

SECTION	PAGE
---------	------

## Introduction

i	Table of Contents	
ii	Corporate Overview	i - ii

## O-Ring Applications

2 - 4	O-Ring Application Theory	
5 - 6	O-Ring Applications	
7 - 8	O-Ring Gland Design	1 - 8

## Material Selection

10 - 18	Compounds - Characteristics	
19 - 34	Fluid Compatibility Chart	9 - 34

## Gland Design

36 - 43	Static Axial Seal Gland Dimensions	
44 - 52	Static Radial Seal Dimensions	
53 - 56	Dynamic Radial Seal Gland Dimensions	
57 - 60	Rotary O-Ring Seal Gland Dimensions	35 - 60

## O-Ring Size Charts and O-Ring Failure

62 - 68	O-Ring Size Chart for Inch Seals	
69	O-Ring Size Chart for Straight Thread Tube Fittings	
70 - 71	O-Ring Size Chart for Metric Seals	
73 - 76	O-Ring Failure	61 - 78

## WARRANTY

Hercules Hydraulics, Inc. guarantees its products to be free from defects in workmanship and raw materials. Our liability for breach of any and all warranties is limited to refunding our invoice price of the product, or at our option, replacement of the material free of charge, including transportation charges but not the cost of installation. The sale of our products under any other warranty or guarantee, expressed or implied, is not authorized by the company. All technical advice, recommendations and services are rendered by the Seller gratis. They are based on technical data which the seller believes to be reliable, and are intended for use by persons having skill and know-how, at their own discretion and risk. Seller assumes no responsibility for results obtained or damages occurred from their use by Buyer in whole or in part.

# CORPORATE OVERVIEW

---



Hercules Bulldog Sealing Products is one of the fastest growing global distributors of hydraulic and pneumatic seals, seal repair kits and hydraulic components for mobile and industrial hydraulic equipment. The company has been in business since 1962, and operates from strategically placed United States and Canadian warehouses with over 35,000 line items and 100,000 square feet of distribution facilities. Hercules achieved ISO 9002 status in 1996 and ISO 9001 status in 1999.

Headquartered in Clearwater, Florida, USA, the company's centralized, technically trained sales force and a highly computerized operation ship close to 100% of orders received in the same day. Most orders are delivered less than 24 hours after receipt. This attention to customer service is critical in working with worldwide repair and operating companies to minimize down time for high dollar revenue generating equipment. Hercules is also a growing force in providing production line and OEM special aftermarket kits for major cylinder manufacturers.

Hercules Bulldog target markets include hydraulic equipment in dump truck and refuse collection, construction (both on and off road) material handling (lift trucks), farm, logging, and industrial plant applications. Replacement seals, seal kits, hydraulic cylinders, pumps, motors and valves are stocked for well known names such as Caterpillar, Clark, Dempster, Heil, Hitachi, Hyster, J.I. Case, Komatsu, Nissan, Toyota, and many other brands of equipment. Hercules sells the highest quality inch and metric sized seals produced by the world's leading manufacturers. Hercules is also an authorized distributor of hydraulic components manufactured by Dana Corporation (Tyrone, Gresen), Custom Hoists, Commercial Intertech, Perfection, Hyco, White, and numerous other suppliers.

Hercules Bulldog publishes the largest single source catalog of individual seals, replacement parts, and technical information in North America. The central sales force in Clearwater operates 12 hours a day and takes orders over a toll free phone and 24 hour fax network. Products in Canada are sold from our Montreal, Toronto and Vancouver branches.

# O-Ring Applications

<b>O-Ring Application Theory</b> .....	2 - 4
<b>O-Ring Applications</b>	
• Static Sealing .....	5
• Dynamic Sealing .....	6
<b>O-Ring Gland Design</b> .....	7 - 8

## O-Ring Application Theory

Typically, an o-ring is an elastomeric seal molded in the shape of a torus (doughnut). During proper operation, o-rings are squeezed between the housing walls of their application and seal off the leakage pathway. At atmospheric pressure, only this o-ring compression is providing the seal. As system pressure increases, the o-ring adjusts to fill the diametrical clearance on the low pressure side of the gland and provides improved sealing. Figure 1 shows the o-ring's reaction to increasing system pressure. When pressure is released, the resiliency of the elastomer returns the o-ring to its original shape.

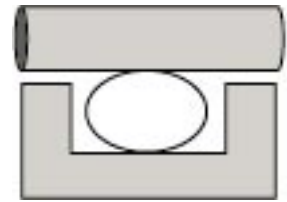

Installed with Zero Pressure

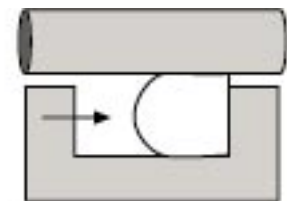

With System Pressure

An o-ring is specified by three of its features: its dimensions, material, and hardness. Material and hardness specify the elastomeric compound and Shore A (durometer) hardness of the compound that is used to manufacture the o-ring. Many available o-ring materials are found later in this catalog and should be selected to meet the requirements of each application. An o-ring's dimensions are described by stating its inside diameter (ID) and its cross-section. The standard ID and cross-sectional sizes that are available are also shown later in this catalog. Since an o-ring must be deformed to function, the relationship between the dimensions of an o-ring and its housing dimensions must meet certain requirements, as explained here.

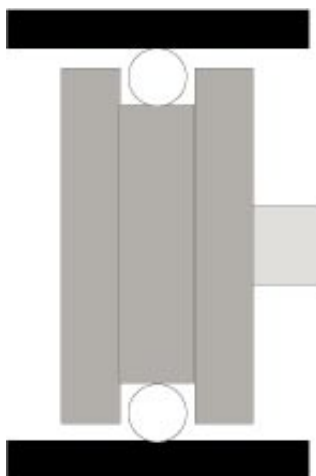

### O-Ring Stretch

As shown in O-Ring Stretch Figure, the o-ring needs to fit snugly in its groove to effectively seal. Accomplishing this requires that the o-ring inside diameter be 1%-5% smaller than the application's rod shaft or piston groove diameter. (2%-3% stretch is ideal.) Overstretching o-rings should be avoided because it causes a reduction in o-ring cross-section. The reduced o-ring cross-section, in turn, causes a reduction in seal squeeze and possible sealing problems. Calculating o-ring stretch is done as follows:

$$\text{Percent O-ring Stretch} = ((\text{Shaft or Groove Diameter} - \text{O-ring ID}) / \text{O-ring ID}) \times 100.$$

## O-Ring Application Theory

### O-Ring Cross-Section

To provide squeeze and proper sealing, the o-ring cross-section needs to be larger than the application gland depth (groove depth + radial clearance). This is typically evaluated by the o-ring cross-sectional compression and should be 10-40% for static applications and 10-30% for dynamic applications. O-ring cross-sectional stretch is calculated by:

$$\text{Percent Compression} = (1 - (\text{Gland Depth} / \text{Seal Cross-section})) \times 100.$$

In new designs, o-ring cross-section is often determined by the amount of space available to contain the seal. However, please note that when choosing o-rings, smaller cross-section o-rings require tighter tolerances and are less capable of handling size variations, scratches, and high pressure.

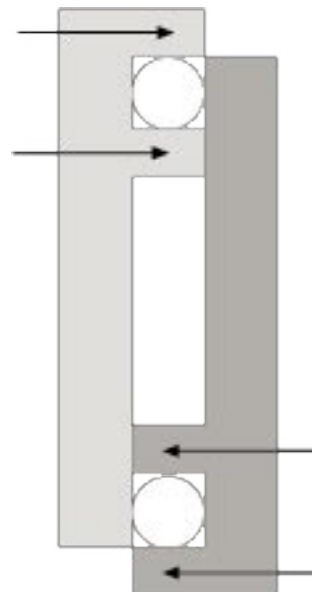

### Gland Fill

Gland fill refers to the percentage of the gland that is occupied by the o-ring. Since an o-ring will not function when it is totally confined in a gland (100% gland fill), o-ring glands should be designed with a maximum of 90% gland fill. The resulting clearance will allow for o-ring expansion during operation without reducing seal function or life. Gland fill is determined as follows:

$$\text{Percent Gland Fill} = (\text{Seal Cross-sectional Area} / (\text{Gland Depth} \times \text{Groove Width})) \times 100.$$

### Anti-Extrusion Rings

# O-Ring Application Theory

Anti-extrusion or back-up rings can be used to prevent seal extrusion in high pressure or high clearance applications. These rings are installed on the low pressure side or both sides of the o-ring and block the diametrical clearance as well as support the o-ring. Typically, back-up rings are recommended for applications involving system pressures above 1500 psi. However, Figure 3 evaluates the fluid pressure, material hardness, and diametrical clearance for a better guide to the use of back-up rings. In Figure 3, when the intersection between the application's pressure line and diametrical clearance line lies to the right of the o-ring's material hardness curve, a back-up ring should be used.

## Summary

The above guidelines highlight some of the design factors that affect o-ring performance. They should be followed when designing o-ring sealing systems to ensure effective sealing. To simplify system design, groove dimensions that meet all of the above requirements are shown for standard size o-rings in Tables B,C, F, and G. And as always, because of the complexity of these forces involved in these applications, all designs should be thoroughly tested before being finalized.

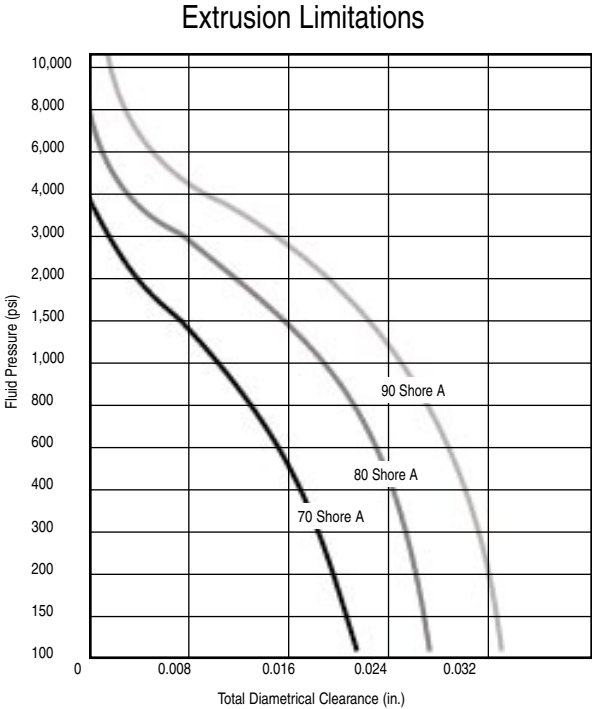

# O-Ring Applications

O-ring applications are categorized by the type of relative motion occurring between the mating surfaces. Static applications involve sealing between two mating parts that do not move. Dynamic sealing describes applications where the mating parts are moving in relation to one another. The following applications depict static and dynamic sealing.

## Static Sealing

**Axial Seals:** The squeeze is on the top and bottom of the cross section and is typically found in a flange type application.

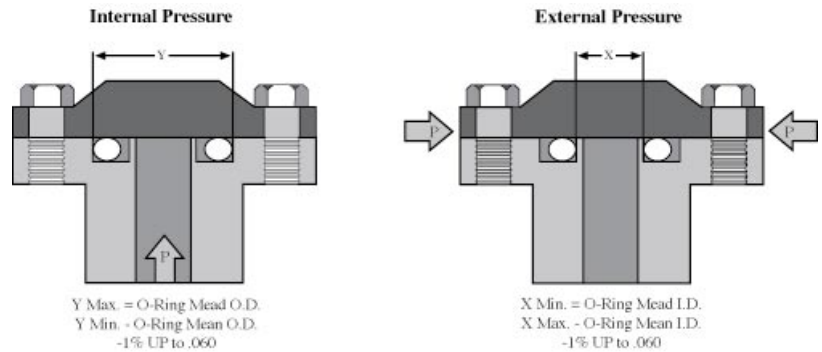

**Radial Seals:** The squeeze is on the I.D. and O.D. of the O-ring as found in most end cap applications.

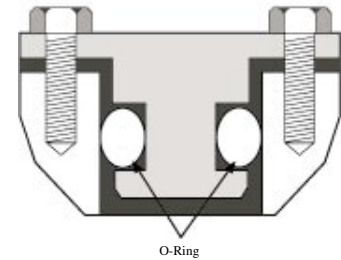

**Crush Seals:** The squeeze is at an angle to the O-rings axis due to its confinement in a triangular gland.



**Dovetail Gland Seals:** The squeeze is on the top and bottom of the O-ring's cross section while the special gland configuration is used to hold the O-ring in place during operation.

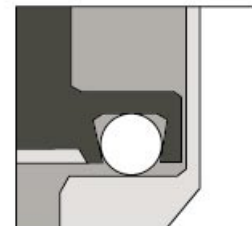

# O-Ring Applications

## Dynamic Sealing

**Reciprocating:**

Motion occurs in an axial direction as in a cylinder.

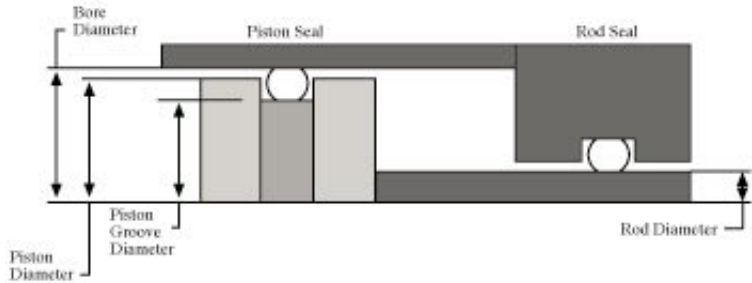

**Rotary:**

Motion occurs as a shaft rotates in relation to the o-ring as in a pump or motor.

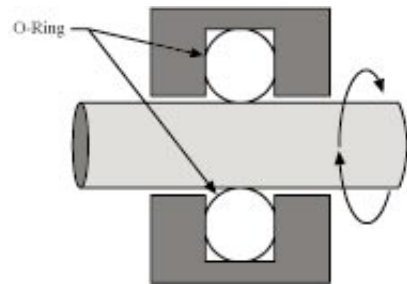

**Oscillating:**

Motion occurs when a shaft rotates and reciprocates as in a valve stem.

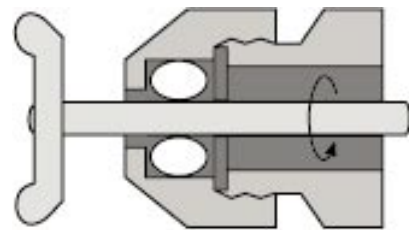



## O-Ring Gland Design

**Table A**

Note: Table A contains general sealing guidelines and more specific information is available in tables G and H.

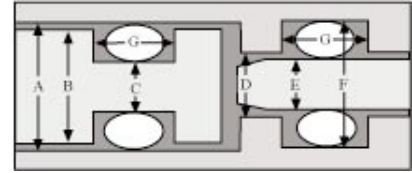

### O-Ring Gland Design for Dynamic Seals

O-Ring Cross Section	Gland Depth	Squeeze		Diametrical Clearance Max.	Groove Width. +/- .005			Groove Radius	Eccentricity Max.
		Inches	%		No Backup Rings	One Backup Ring	Two Backup Rings		
.020	.015/.017	.003/.005	15-25	.003	.035	-	-	-	.0015
.030	.023/.025	.005/.007	16-23	.003	.046	-	-	-	.0015
.040	.031/.033	.007/.009	17-25	.004	.063	-	-	.005-.008	.002
.050	.039/.041	.009/.011	18-25	.004	.073	-	-	.005-.008	.002
.060	.047/.049	.011/.013	18-22	.004	.084	-	-	.005-.008	.002
.070	.055/.057	.010/.018	15-25	.004	.095	.140	.207	.005-.015	.002
.103	.087/.090	.010/.018	10-17	.005	.142	.173	.240	.005-.015	.002
.139	.121/.123	.012/.022	9-16	.006	.189	.210	.277	.010-.025	.003
.210	.185/.188	.017/.030	8.5-14	.006	.283	.283	.413	.020-.035	.004
.275	.237/.240	.029/.044	10.5-16	.007	.377	.377	.540	.020-.035	.005

**Table B**

Note: Table B contains general sealing guidelines and more specific information is available in tables E and F.

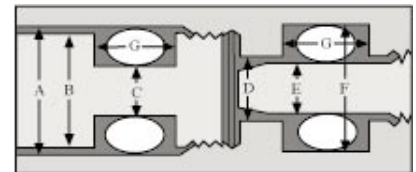

### O-Ring Gland Design For Static Seals (Axial and Radial)

O-Ring Cross Section	Gland Depth		Squeeze				Dia-metrical Clearance Max.	Groove Width. +/- .005			Groove Radius	Eccentricity Max.
	Radial	Axial	Radial		Axial			No Backup Rings	One Backup Ring	Two Backup Rings		
			Inches	%	Inches	%						
.020	.013-.015	.013-.015	.005-.007	25-35	.005-.007	25-35	.002	.040	-	-	-	.0015
.030	.020-.023	.020-.022	.007-.010	23-33	.008-.010	27-33	.003	.052	-	-	-	.0015
.040	.026-.031	.026-.029	.009-.014	23-35	.011-.013	28-33	.003	.101	-	-	.005-.008	.002
.050	.033-.039	.032-.036	.011-.017	22-34	.014-.018	28-35	.004	.101	-	-	.005-.008	.002
.060	.042-.047	.039-.043	.013-.018	22-30	.017-.021	28-35	.004	.105	-	-	.005-.008	.002
.070	.050-.052	.045-.050	.015-.023	22-23	.013-.023	19-32	.004	.095	.140	.207	.005-.015	.002
.103	.081-.083	.074-.080	.017-.025	17-24	.020-.032	20-30	.005	.142	.173	.240	.005-.015	.002
.139	.111-.113	.101-.107	.022-.032	16-23	.028-.042	20-30	.006	.189	.210	.277	.010-.025	.003
.210	.170-.173	.152-.162	.032-.045	15-21	.043-.063	21-30	.006	.283	.3313	.413	.020-.035	.004
.275	.226-.226	.201-.211	.040-.055	15-20	.058-.080	21-29	.007	.377	.410	.540	.020-.035	.005

# O-Ring Gland Design

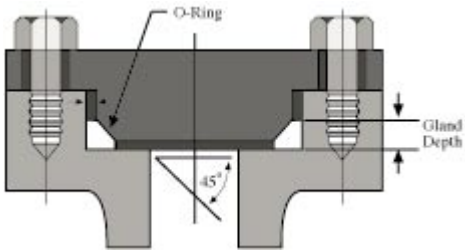

**Table C**

**O-Ring Gland Design for Static Crush Seal (Triangular Grooves)**

AS 568A Number	Nominal Cross	"O" Ring Cross Section				Gland Depth			
		Actual				-.000		-.000	
		In.	+/-	mm	+/-	In.	+	mm	+
004-050	1/16	.070	.003	1.78	.08	.095	.003	2.41	.08
102-178	3/32	.103	.003	2.62	.08	.137	.005	3.48	.13
201-284	1/8	.139	.004	3.53	.10	.186	.007	4.72	.18
309-395	3/16	.210	.005	5.33	.13	.279	.010	7.08	.25
425-475	1/4	.275	.006	6.99	.15	.371	.015	9.42	.38

**Table D**

**O-Ring Gland Design for Dovetail Glands**

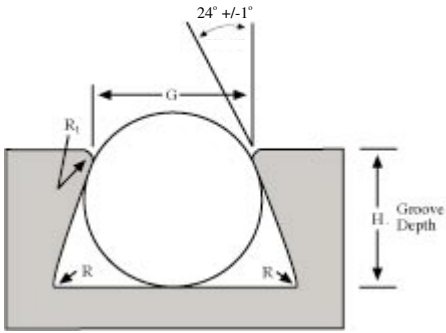

AS 568A Number	W "O" Ring Cross Section				G Groove Width				H Groove Depth		R1 Radius		R Radius	
					Sharp Edge		Round Edge		In.	mm				
	In.	+/-	mm	+/-	In.	mm	In.	mm	+0.00	+0.00	In.	mm	In.	mm
004-050	.070	.003	1.78	.08	.057	1.45	.063	1.60	.052	1.32	.005	.13	1/64	.40
102-178	.103	.003	2.62	.08	.085	2.16	.090	2.29	.083	2.11	.010	.25	1/64	.40
201-284	.139	.004	3.53	.10	.115	2.92	.120	3.05	.115	2.92	.010	.25	1/32	.79
309-395	.210	.005	5.33	.13	.160	.406	.170	4.32	.180	4.57	.015	.38	1/32	.79
425.475	.275	.006	6.99	.15	.220	5.59	.235	5.97	.234	5.94	.015	.38	1/16	1.59

# Material Selection

## Materials/Compounds

- Compounds - Characteristics..... 10 - 18
- Fluid Compatibility Chart..... 19 - 34

## Compounds - Characteristics

Early O-rings were made of natural rubber, which limited their use to a narrow choice of fluids. Since the 1940's many compounds have been developed that resist higher temperatures, higher pressures, and have improved physical properties that resist chemical reaction and exotic fluids. The following is an overview of the O-ring compounds available at Hercules. Based on demand, all sizes and materials shown in this catalog may or may not be stocked by Hercules. Please call for pricing and availability.

### MATERIAL DESCRIPTIONS

#### Acrylonitrile Butadiene (NBR)

NBR, Buna-N, and Nitrile all represent the same elastomer based on a butadiene and acrylonitrile copolymer. Nitrile is inherently resistant to hydraulic fluids, lubricating oils, transmission fluids, and other non-polar petroleum based products due to the polar structure of the elastomer. This inherent resistance has led nitrile to become the most widely used elastomer in the seal industry for temperatures between -40° and 250°F. Nitriles are also resistant to air and water and are superior to most elastomers with regard to compression set or cold flow, tear, and abrasion resistance.

However, they do not possess good resistance to ozone, sunlight, or weather. Through compounding, hydrogenation (see HNBR), carboxylic acid addition (see XNBR), or PVC blending, the nitrile polymer can meet a more specified range of physical or chemical requirements. For instance, increasing the acrylonitrile content yields better resistance to petroleum-based fluids, hydrocarbon fuels, and the degrading effects of heat. However, decreasing acrylonitrile content provides improved low temperature performance.

Nitrile is recommended for:

- General purpose sealing
- Petroleum oils and fluids
- Water, water-oil emulsions, and water-glycol fluids,
- Silicone greases and oils
- Di-ester base lubricants (MIL-L-7808)
- Ethylene glycol base fluids (Hydrolubes)

Nitrile is NOT recommended for:

- Polar solvents (acetone, MEK, chlorinated hydrocarbons, nitro hydrocarbons)
- Brake fluids
- Strong acids
- Ozone and sunlight exposure

## Compounds - Characteristics

### Hydrogenated Nitrile (HNBR)

HNBRs are obtained by hydrogenating the nitrile copolymer and often fill the gap between NBR and FKM elastomers in applications requiring high temperature resistance, high tensile strength, and resistance to petroleum oils. HNBRs have been developed to meet temperatures of -30° to 330°F while maintaining a resistance to petroleum oils and an improved resistance to sour gas and ozone (~5 times greater than standard nitrile).

Hydrogenated Nitrile is recommend for:

- Petroleum oils and fluids
- ATFs
- Sour gas
- Amine/oil mixtures
- Oxidized fuels
- Steam (to 347°F)

Hydrogenated Nitrile is NOT recommended for:

- Polar solvents (acetone, MEK)
- Chlorinated and nitro hydrocarbons

### Carboxylated Nitrile (XNBR)

By adding the carboxyl group to the nitrile copolymer, the elastomer's abrasion resistance is significantly improved (3-5 times greater than standard nitrile) while oil and solvent resistance is maintained. XNBR compounds provide high tensile strength and good physical properties at high temperatures. Typical operating temperatures for XNBR are -40° to 250°F.

Carboxylated Nitrile is recommended for:

- Petroleum oils and fluids
- Water, water-oil emulsions, and water-glycol fluids

Carboxylated Nitrile is NOT recommended for:

- Polar solvents (acetone, MEK)
- Chlorinated and nitro hydrocarbons

## Compounds - Characteristics

### Fluorocarbon (FKM) - Viton®

Fluorocarbon elastomers commonly known as Viton® or Fluorel® were first introduced in the 1950's and have become important seal materials due to their broad chemical compatibility and temperature range. Fluorocarbon elastomers are highly fluorinated, carbon backboned polymers. The fluorine/elastomer backbone is responsible for the relative inertness of FKMs and in general, increasing the fluorine content will improve the chemical resistance while diminishing the low temperature compatibility. FKMs are often used in applications requiring harsh chemical and ozone resistance with thermal stability between -20° and 400°F. Fluorocarbons have been known to seal at 600°F for short periods of time and at -65°F in static applications. Fluorocarbons also offer low compression set, excellent aging characteristics, and low gas permeability (for hard vacuum service).

Fluorocarbon is recommended for:

- Petroleum oils and fluids
- Di-ester base lubricants (MIL-L-7808,6085)
- Silicate ester base lubricants (MLO 8200,8515, OS-45)
- Silicone fluids and greases
- Halogenated hydrocarbons (carbon tetrachloride, trichloroethylene)
- Selected phosphate ester fluids (not Skydrol)
- Acids

Fluorocarbon is NOT recommended for:

- Polar solvents (acetone, MEK)
- Chlorinated and nitro hydrocarbons
- Amines
- Low molecular weight esters and ethers
- Hot hydrofluoric or chlorosulfonic acids
- Skydrol fluids

Note: Viton® is a registered trademark of DuPont Dow Elastomers  
Fluorel® is a registered trademark of 3M Corporation

## Compounds - Characteristics

### Ethylene Propylene (EP)

EP, a copolymer of ethylene and propylene(EPR) combined with the comonomer adiene(EPDM), provides excellent resistance to heat, water, steam, ozone, and sunlight while providing very good low temperature flex properties. EPs withstand the affects of brake fluids; alkali, mild acidic, and oxygenated solvent environments; and outdoor weathering. Typically, the temperature range for EP is -60°F to 250°F.

Ethylene Propylene is recommended for:

- Phosphate ester base fluids (such as Skydrol)
- Water, water-glycol fluids, and steam (to 400°F)
- Silicone oils and greases
- Dilute acids and alkalies
- Polar solvents (acetone, MEK)
- Alcohols
- Automotive brake fluids

Ethylene Propylene is NOT recommended for:

- Petroleum oils and greases
- Diester based lubricants (MIL-L-7808)
- Aromatic fuels
- Hydrocarbon solvents

### Styrene Butadiene (SBR)

Originally developed to replace natural rubber in tires, styrene butadiene (known as Buna-S) is a low cost, general purpose elastomer. SBR exhibits good flex properties, is resistant to many polar type chemicals including ketones and alcohols, and is widely accepted for use in automotive brake fluids. Typically, the temperature range for SBR is -50°F to 212°F.

Styrene Butadiene is recommend for:

- Automotive brake fluids

Styrene Butadiene is NOT recommend for:

- Petroleum oils and fluids
- Hydrocarbon solvents
- Strong Acids
- Ozone

## Compounds - Characteristics

### Isobutylene Isoprene Rubber (IIR)

The isobutylene isoprene copolymer, commonly called butyl, is compatible with water, steam, alkalis, oxygenated solvents, and phosphate ester fluids over a temperature range of -65° to 250°F. Butyl also has excellent resistance to gas permeation (vacuum applications), ozone, and outdoor weathering. In most applications, butyl has been replaced by Ethylene Propylene.

Butyl is recommended for:

- Phosphate ester base fluids
- Polar solvents (acetone, MEK)
- Silicone fluids and greases

Butyl is NOT recommended for:

- Petroleum oils and fluids
- Diester based lubricants (MIL-L-7808)

### Polychloroprene (CR)

Chloroprene (chlorobutadiene) homopolymers, commercially called neoprene, are classified as general purpose elastomers. Chloroprene is characterized by its limited resistance to both petroleum oils and oxygen. CRs exhibit excellent aging characteristics in ozone and water along with abrasion and flex cracking resistance. CRs resist alkalis and acids and are suitable for use in petroleum, animal, and vegetable oils. Furthermore, a broad temperature range, -45° to 250°F, excellent adhesion qualities to metals, and moderate cost make neoprene desirable in many applications.

Polychloroprene is recommended for:

- Refrigerants (freons, ammonia)
- High aniline point petroleum oils
- Mild acid resistance
- Silicate ester lubricants

Polychloroprene is NOT recommended for:

- Strong acids
- Polar solvents (acetone, MEK)
- Chlorinated, aromatic, and nitro hydrocarbons



## Compounds - Characteristics

### Silicone (VMQ)

Silicone elastomers are made from silicone, oxygen, hydrogen, and carbon and are particularly suited to applications involving temperature extremes. Silicone's elastomeric property retention, temperature stability, and low temperature flexibility is superior to other elastomers and various blends of silicone have performed satisfactorily at 600°F for short periods of time. However, continuous service is typically limited to -94° to 400°F in dry air. Silicones provide outstanding resistance to compression set, sunlight, ozone, oxygen, moisture, and fungus. They are very clean and are often used in food and medical applications because they are non-toxic and do not impart an odor or taste. Silicones typically have poor tensile strength, tear resistance, and abrasion resistance and, therefore, are not normally recommended for dynamic sealing applications. Also, silicones are highly permeable to gases.

Silicone is recommended for:

- High-aniline point oils
- Dry heat
- Chlorinated di-phenyls

Silicone is NOT recommended for:

- Polar solvents (acetone, MEK)
- Acids

### Perfluoroelastomer (FFKM) - Kalrez® & Chemraz®

Perfluoroelastomers--most notably, Greene, Tweed & Co's Chemraz® and DuPont Dow's Kalrez®--combine the toughness of an elastomeric material with the chemical inertness of PTFE. Because of the PTFE monomer, perfluoroelastomers offer resistance to most chemicals and corrosive additives that swell or degrade other elastomers. Furthermore, these materials do not creep or cold flow like PTFE parts and are available for -35° to 600°F (dry heat) applications. In high temperature situations, gland dimensions may need to be increased to accommodate perfluoroelastomer's 50% greater coefficient of thermal expansion. Perfluoroelastomers are primarily found in chemical and petroleum industries as well as high temperature or chemically aggressive applications where no other material is acceptable.

Perfluoroelastomers are recommended for:

- Acids and Alkalines
- Ketones
- Esters
- Aldehydes
- Alcohols and Fuels
- Steam and hot water (Chemraz only)

Perfluoroelastomers are NOT recommended for:

- Fluorinated solvents
- Halogenated freons
- Uranium hexafluoride
- Molten or gaseous alkali metals

Note: Kalrez® is a registered trademark of DuPont Dow Elastomers  
Chemraz® is a registered trademark of Greene, Tweed & Co.

## Compounds - Characteristics

### Fluorosilicone (FVMQ)

Fluorosilicones combine the high and low temperature properties of silicone with the fuel and oil resistance of fluorinated elastomers. FVMQs provide an operational temperature range of -75° to 400°F, but care should be taken to avoid fluid degradation, which causes the production of acids that will attack fluorosilicone elastomers.

FVMQs feature good compression set and resilience properties and a suitable resistance to ozone and weathering. They also feature limited physical strength, poor abrasion resistance, and high friction characteristics which limit fluorosilicone's dynamic sealability. Primarily, FVMQs are used as static seals in fuel systems and dry-heat applications that may involve exposure to petroleum oils.

Fluorosilicon is recommended for:

- Petroleum oils and fuels
- Diester based lubricants (MIL-L-7808)
- Silicone fluids and greases

Fluorosilicon is NOT recommended for:

- Brake fluids
- Hydrazine
- Polar solvents (acetone, MEK)

### Polyacrylate (ACM)

Polyacrylate elastomers are polymerization products of acrylic acid esters and are designed to withstand high heat (0° to 350°F) while retaining petroleum fuel and oil resistance. In addition, ACMs are resistant to oxidation, ozone, aliphatic solvents, sunlight, weathering, gas permeation, and flex cracking. Polyacrylate elastomers are primarily found in automotive automatic transmission and power steering applications using Type A fluid.

Polyacrylate is recommended for:

- Petroleum oils
- Automatic transmission fluids

Polyacrylate is NOT recommended for:

- Alcohol
- Glycols
- Alkalis
- Brake fluids
- Chlorinated and aromatic hydrocarbons

## Compounds - Characteristics

### Polyisoprene, Natural (NR) and Synthetic (IR)

Polyisoprenes, both natural (from trees) and synthetic, are noted for outstanding resilience, tear and abrasion resistance, excellent elasticity, and flex fatigue resistance. Polyisoprenes also have excellent tensile strength and are operable in low temperature (-65°F to 220°F) applications. Synthetic polyisoprene provides more consistent dynamic properties and better weather resistance. Also, the lack of "tree" organics yields a relatively odorless elastomer. On the other hand, natural polyisoprene provides slightly better tensile strength, tear resistance, compression set, and flex fatigue resistance.

Since polyisoprenes are not recommended for high heat, ozone, sunlight, petroleum, or hydrocarbon environments, they are typically found in food & beverage applications. Furthermore, they are a popular material for non-hydraulic sealing applications.

Polyisoprene is recommended for:

- Organic acids and alcohols

Polyisoprene is NOT recommended for:

- Petroleum oils and fluids

### PTFE (FEP) - Teflon® (Register Trademark of DuPont Dow Elastomers)

PTFE is a durable, chemically inert polymer with a working temperature range of -300° to 450°F. It features outstanding weather, ozone, and chemical resistance along with good tensile strength, elongation, impact resistance, and low friction. PTFE should be limited to static and slow intermittent dynamic applications because it has a poor elastic memory and tear resistance. Extra care should be used during handling and seal installation to avoid any nicks or scratches which will cause leakage. PTFE also has a tendency to cold flow which may require the addition of special fillers for certain seal or gasket type applications.

PTFE is recommended for:

- Petroleum oils and fuels
- Polar solvents (acetone, MEK)
- Xylene

PTFE is NOT recommended for:

- Dynamic sealing applications

Note: Teflon® is a registered trademark of DuPont Dow Elastomers

## Compounds - Characteristics

### Polyurethane (AU, EU)

Polyurethane offers outstanding abrasion resistance, elongation, compression sets, and tensile strength over a temperature range of -60° to 225°F. Based on its strong physical properties, polyurethane is recommended for sealing high hydraulic pressures and for situations where highly stressed parts are subject to wear.

Polyurethane is recommended for:

- Petroleum oils and fuels
- Mineral oils
- Weak acids and bases
- Aliphatic solvents
- Alcohols
- Ether

Polyurethane is NOT recommended for:

- Concentrated acids and bases
- Polar solvents (acetone, MEK)
- Strong aromatic compounds (>80% aromatic constituents)
- Brake fluids
- Water or steam

# Fluid Compatibility Chart

**COMPATIBILITY RATING:**  
 1 = Satisfactory  
 2 = Fair (Usually OK for Static Seal)  
 3 = Doubtful (Sometimes OK for Static Seal)  
 4 = Unsatisfactory  
 X = Insufficient Data

FLUID NAME	Nitrile	Ethylene Propylene	Fluorocarbon	Neoprene	SBR	Polyacrylate	Polyurethane	Butyl	Butadiene	Isoprene	Natural Rubber	Hypalon	Fluorosilicone	Silicone
1-Butene 2-Ethyl	1	4	1	4	4	1	4	4	4	4	4	4	3	4
1-Chloro 1-Nitro Ethane	4	4	4	4	4	4	4	4	4	4	4	4	4	4
AN-O-3 Grade M	1	4	1	2	4	1	1	4	4	4	4	2	1	2
AN-O-6	1	4	1	2	4	1	1	4	4	4	4	2	1	4
AN-VV-O-366b Hydr. Fluid	1	4	1	2	4	2	2	4	4	4	4	2	1	4
ASTM Oil, No.1	1	4	1	1	4	1	1	4	4	4	4	2	1	1
ASTM Oil, No.2	1	4	1	2	4	1	2	4	4	4	4	4	1	4
ASTM Oil, No.3	1	4	1	4	4	1	2	4	4	4	4	4	1	3
ASTM Oil, No.4	2	4	1	4	4	2	4	4	4	4	4	4	2	4
ASTM Reference Fuel A	1	4	1	2	4	2	1	4	4	4	4	2	1	4
ASTM Reference Fuel B	1	4	1	4	4	4	2	4	4	4	4	4	1	4
ASTM Reference Fuel C	2	4	1	4	4	4	4	4	4	4	4	4	2	4
ATL-857	2	4	1	4	4	2	4	4	4	4	4	4	2	4
Acetaldehyde	3	2	4	3	3	4	4	2	2	2	2	3	4	2
Acetamide	1	1	3	1	4	4	4	2	4	4	4	2	1	2
Acetic Acid, 5%	2	1	1	1	2	4	4	1	2	2	2	1	2	1
Acetic Acid, Glacial	2	2	4	4	2	4	4	2	2	2	2	3	4	2
Acetic Acid, Hot, High Pressure	4	3	4	4	4	4	4	4	4	4	4	3	4	3
Acetic Anhydride	4	2	4	2	2	4	4	2	2	2	2	2	4	2
Acetone	4	1	4	4	4	4	4	1	4	4	4	3	4	4
Acetophenone	4	1	4	4	4	4	4	2	4	4	4	4	4	4
Acetyl Acetone	4	1	4	4	4	4	4	1	4	4	4	4	4	4
Acetyl Chloride	4	4	1	4	4	4	4	4	4	4	4	4	1	3
Acetylene	1	1	1	2	2	4	4	1	2	2	2	2	X	2
Acetylene Tetrabromide	4	1	1	2	4	X	4	1	X	X	X	X	X	X
Acrylonitrile	4	4	3	4	3	4	4	4	X	3	3	3	4	4
Aero Lubriplate	1	4	1	1	2	1	1	4	4	4	4	1	1	2
Aero Shell 17 Grease	1	4	1	2	4	1	1	4	4	4	4	1	1	2
Aero Shell 750	2	4	1	4	4	2	4	4	4	4	4	4	2	4
Aero Shell 7A Grease	2	4	1	2	4	1	1	4	4	4	4	1	1	2
Aero Shell IAC	1	4	1	2	4	1	1	4	4	4	4	1	1	2
Aerosafe 2300	4	1	4	4	4	4	4	2	4	4	4	4	3	3
Aerosafe 2300W	4	1	4	4	4	4	4	2	4	4	4	4	3	3
Aerozene 50 (50% Hydrazine 50% UDMH)	3	1	4	4	4	X	4	1	4	4	4	4	4	4
Air Below 200° F	2	1	1	1	2	1	2	1	2	2	2	1	1	1
Air, 200 - 300° F	3	2	1	2	4	2	3	2	4	4	4	2	1	1
Air, 300 - 400° F	4	4	1	4	4	4	4	4	4	4	4	4	2	1
Air, 400 - 500° F	4	4	3	4	4	4	4	4	4	4	4	4	4	2
Alkazene	4	4	2	4	4	4	4	4	4	4	4	4	2	4
Aluminum Acetate	2	1	4	2	2	4	4	1	4	1	1	4	4	4
Aluminum Bromide	1	1	1	1	1	1	3	1	1	1	1	1	1	1
Aluminum Chloride	1	1	1	1	1	1	3	1	1	1	1	1	1	2
Aluminum Fluoride	1	1	1	1	1	X	3	1	1	1	2	1	1	2
Aluminum Nitrate	1	1	1	1	1	X	3	1	1	1	1	1	X	2
Aluminum Salts	1	1	1	1	1	1	3	1	1	1	1	1	1	1
Aluminum Sulphate	1	1	1	1	2	4	4	1	1	1	1	1	1	1
Alums-NH3 -Cr -K	1	1	4	1	1	4	X	1	1	1	1	1	4	1
Ambrex 33 (Mobil)	1	4	1	2	4	1	2	4	4	4	4	3	3	4
Ambrex 830 (Mobil)	1	3	1	2	4	1	1	3	4	4	4	2	1	2
Amines-Mixed	4	2	4	2	2	4	4	2	2	2	2	4	4	2
Ammonia and Lithium Metal in Solution	2	2	4	X	4	4	4	2	4	4	4	4	4	4
Ammonia, Gas, Cold	1	1	4	1	1	4	X	1	1	1	1	1	4	1
Ammonia, Gas, Hot	4	2	4	2	4	4	X	2	4	4	4	2	4	X
Ammonia, Liquid (Anhydrous)	2	1	4	1	4	4	4	1	4	4	4	2	4	2
Ammonium Carbonate	4	1	1	1	1	4	4	1	X	X	1	1	X	X
Ammonium Chloride, 2N	1	1	1	1	1	X	1	1	X	X	1	1	X	X
Ammonium Hydroxide, 3 Molar	1	1	3	1	2	4	4	1	2	2	2	1	1	1
Ammonium Hydroxide, Concentrated	4	1	4	1	3	4	4	1	3	3	3	1	1	1
Ammonium Nitrate, 2N	1	1	X	1	1	2	X	1	X	X	3	1	X	X
Ammonium Nitrite	1	1	X	1	1	X	X	1	1	1	1	1	X	2
Ammonium Persulfate 10%	4	1	X	1	4	4	4	1	X	1	1	X	X	X
Ammonium Persulfate Solution	4	1	X	X	4	4	4	1	X	1	1	X	X	X

# Fluid Compatibility Chart

**COMPATIBILITY RATING:**  
 1 = Satisfactory  
 2 = Fair (Usually OK for Static Seal)  
 3 = Doubtful (Sometimes OK for Static Seal)  
 4 = Unsatisfactory  
 X = Insufficient Data

MATERIAL	Nitrile	Ethylene Propylene	Fluorocarbon	Neoprene	SBR	Polyacrylate	Polyurethane	Butyl	Butadiene	Isoprene	Natural Rubber	Hypalon	Fluorosilicone	Silicone
Ammonium Phosphate	1	1	4	1	1	X	X	1	X	1	1	1	X	1
Ammonium Phosphate, Dibasic	1	1	X	1	1	X	X	1	X	1	1	1	X	1
Ammonium Phosphate, Mono-Basic	1	1	X	1	1	X	X	1	X	1	1	1	X	1
Ammonium Phosphate, Tribasic	1	1	X	1	1	X	X	1	X	1	1	1	X	1
Ammonium Salts	1	1	3	1	1	3	X	1	X	1	1	1	3	1
Ammonium Sulfate	1	1	4	1	2	4	X	1	1	1	1	1	X	X
Ammonium Sulfide	1	1	4	1	2	4	X	1	1	1	1	1	X	X
Amyl Acetate	4	3	4	4	4	4	4	3	4	4	4	4	4	4
Amyl Alcohol	2	1	2	2	2	4	4	1	2	2	2	2	1	4
Amyl Borate	1	4	1	1	4	X	X	4	4	4	4	1	X	X
Amyl Chloride	X	4	1	4	4	4	X	4	4	4	4	4	2	4
Amyl Chloronaphthalene	4	4	1	4	4	4	X	4	4	4	4	4	2	4
Amyl Naphthalene	4	4	1	4	4	2	4	4	4	4	4	4	1	4
An-O-366	1	4	1	2	4	1	1	4	4	4	4	2	1	4
Anderol, L- 826 (di-ester)	2	4	1	4	4	2	4	4	4	4	4	4	2	4
Anderol, L- 829 (di-ester)	2	4	1	4	4	2	4	4	4	4	4	4	2	4
Anderol, L-774 (di-ester)	2	4	1	4	4	2	4	4	4	4	4	4	2	4
Ang-25 (Di-ester Base) (TG749)	2	4	1	4	4	2	4	4	4	4	4	4	2	2
Ang-25 (Glycerol Ester)	2	1	1	2	2	4	4	2	2	2	2	2	2	2
Anhydrous Ammonia	2	1	4	1	4	4	4	1	4	4	4	4	4	2
Anhydrous Hydrazine	4	2	4	2	1	4	4	2	4	4	4	2	4	X
Anhydrous Hydrogen Fluoride	4	1	4	X	4	4	X	1	4	4	4	X	4	X
Aniline	4	2	3	4	4	4	4	2	4	4	4	4	3	4
Aniline Dyes	4	2	2	2	2	4	4	2	2	2	2	2	2	3
Aniline Hydrochloride	2	2	2	4	3	4	4	2	4	2	2	4	2	3
Aniline Oil	4	2	3	4	4	4	4	2	4	4	4	4	3	4
Animal Oil (Lard Oil)	1	2	1	2	4	1	2	2	4	4	4	2	1	2
Ansul Ether 161 or 181	3	3	4	4	4	4	2	3	4	4	4	4	3	4
Argon	1	1	1	1	1	1	1	1	1	1	1	1	1	1
Aroclor, 1248	3	2	1	4	4	4	4	2	4	4	4	4	2	2
Aroclor, 1254	4	2	1	4	4	4	4	4	4	4	4	4	2	3
Aroclor, 1260	1	X	1	1	1	4	4	1	1	1	1	1	1	1
Aromatic Fuel -50%	2	4	1	4	4	4	4	4	4	4	4	4	2	4
Arsenic Acid	1	1	1	1	1	3	3	1	1	1	2	1	1	1
Askarel	2	4	1	4	4	4	4	4	4	4	4	4	2	4
Asphalt	2	4	1	2	4	2	2	4	4	4	4	2	2	4
Atlantic Dominion F	1	4	1	2	4	1	2	4	4	4	4	4	1	4
Atlantic Utro Gear-EP Lube.	1	4	1	2	4	1	1	4	4	4	4	4	1	4
Aure 903R (Mobil)	1	4	1	2	4	1	1	4	4	4	2	4	4	4
Automatic Transmission Fluid	1	4	1	2	4	1	2	4	4	4	4	3	X	4
Automotive Brake Fluid	3	1	4	2	1	4	4	2	X	X	X	2	4	3
Bardol B	4	4	1	4	4	4	4	4	4	4	4	4	2	4
Barium Chloride	1	1	1	1	1	1	1	1	1	1	1	1	1	1
Barium Hydroxide	1	1	1	1	1	4	4	1	1	1	1	1	1	1
Barium Salts	1	1	1	1	1	1	1	1	1	1	1	1	1	1
Barium Sulfide	1	1	1	1	2	4	1	1	2	1	1	1	1	1
Bayol 35	1	4	1	2	4	1	2	4	4	4	4	4	1	4
Bayol D	1	4	1	2	4	1	4	4	4	4	4	4	1	4
Beer	1	1	1	1	1	4	2	1	1	1	1	1	1	1
Beet Sugar Liquors	1	1	1	2	1	4	4	1	1	1	1	1	1	1
Benzaldehyde	4	1	4	4	4	4	4	1	4	4	4	1	4	2
Benzene	4	4	1	4	4	4	4	4	4	4	4	4	3	4
Benzenesulfonic Acid 10%	4	4	1	2	4	4	4	4	4	4	4	1	2	4
Benzochloride	4	1	1	4	4	4	X	2	4	4	4	4	1	X
Benzoic Acid	4	4	1	4	4	4	4	4	4	4	4	4	2	4
Benzophenone	X	2	1	X	4	4	4	2	4	4	X	X	1	X
Benzyl Alcohol	4	2	1	2	4	4	4	2	4	4	4	2	2	2
Benzyl Benzoate	4	4	1	4	4	4	4	2	4	4	4	4	1	4
Benzyl Chloride	4	4	1	4	4	4	4	4	4	4	4	4	1	4
Black Point 77	1	1	1	3	3	3	3	1	3	3	3	3	3	3
Blast Furnace Gas	4	4	1	4	4	4	4	4	4	4	4	4	2	1
Bleach Liquor	3	1	1	2	3	4	4	1	2	2	3	1	2	2

# Fluid Compatibility Chart

**COMPATIBILITY RATING:**  
 1 = Satisfactory  
 2 = Fair (Usually OK for Static Seal)  
 3 = Doubtful (Sometimes OK for Static Seal)  
 4 = Unsatisfactory  
 X = Insufficient Data

FLUID NAME	MATERIAL													
	Nitrile	Ethylene Propylene	Fluorocarbon	Neoprene	SBR	Polyacrylate	Polyurethane	Butyl	Butadiene	Isoprene	Natural Rubber	Hypalon	Fluorosilicone	Silicone
Borax	2	1	1	4	2	2	1	1	2	2	2	4	2	2
Bordeaux Mixture	2	1	1	2	2	4	4	1	2	2	2	1	2	2
Boric Acid	1	1	1	1	1	4	1	1	1	1	1	1	1	1
Boron Fluids (HEF)	2	4	1	4	4	4	4	4	4	4	4	4	2	4
Brake Fluid DOT3 (Glycol Type)	3	1	4	2	1	X	4	2	X	X	X	2	4	3
Bray GG-130	2	4	1	4	4	2	4	4	4	4	4	4	2	4
Brayco 719-R (VV-H-910)	3	1	4	2	X	4	4	2	2	2	2	2	2	2
Brayco 885 (MIL-L-6085A)	2	4	1	4	4	2	1	4	4	4	4	4	2	4
Brayco 910	2	1	4	2	2	3	3	1	1	1	1	1	4	4
Bret 710	2	1	4	2	2	3	3	1	1	1	1	1	4	4
Brom - 113	3	4	X	4	4	X	X	4	X	X	X	4	X	4
Brom - 114	2	4	2	2	4	X	X	4	4	4	4	2	X	4
Bromine	4	4	1	4	4	4	4	4	4	4	4	4	2	4
Bromine Pentafluoride	4	4	4	4	4	4	4	4	4	4	4	4	4	4
Bromine Trifluoride	4	4	4	4	4	4	4	4	4	4	4	4	4	4
Bromine Water	4	2	1	4	4	4	4	4	4	4	4	1	2	4
Bromobenzene	4	4	1	4	4	4	4	4	4	4	4	4	1	4
Bromochloro Trifluoroethane	4	4	1	4	4	4	4	4	4	4	4	4	2	4
Bunker Oil	1	4	1	4	4	1	2	4	4	4	4	4	1	2
Butadiene (Monomer)	4	4	1	4	4	4	4	4	4	4	4	4	1	4
Butane	1	4	1	1	3	1	1	4	4	4	4	2	3	4
Butane, 2, 2-Dimethyl	1	4	1	2	3	1	4	4	4	4	4	2	3	4
Butane, 2, 3-Dimethyl	1	4	1	2	3	1	4	4	4	4	4	2	3	4
Butanol (Butyl Alcohol)	1	2	1	1	1	4	4	2	1	1	1	1	1	2
Butter-Animal Fat	1	1	1	2	4	1	1	2	4	4	4	2	1	2
Butyl Acetyl Ricinoleate	2	1	1	2	4	X	4	1	4	4	4	2	2	X
Butyl Acrylate	4	4	4	4	4	4	X	4	4	4	4	4	4	X
Butyl Alcohol	1	2	1	1	1	4	4	2	1	1	1	1	1	2
Butyl Amine or N-Butyl Amine	3	3	4	4	4	4	4	4	4	4	4	4	4	4
Butyl Carbitol	4	1	3	3	4	4	X	1	4	4	4	2	4	4
Butyl Cellosolve	3	2	4	3	4	4	4	2	4	4	4	4	4	X
Butyl Cellosolve Adipate	4	2	2	4	4	4	4	2	4	4	4	4	2	2
Butyl Oleate	4	2	1	4	4	X	X	2	4	X	4	4	2	X
Butyl Stearate	2	4	1	4	4	X	X	4	4	4	4	4	2	X
Butylene	2	4	1	3	4	4	4	4	4	4	4	4	2	4
Butyraldehyde	4	2	4	4	4	4	4	2	4	4	4	4	4	4
Butyric Acid	4	2	2	4	4	4	X	2	4	X	X	4	X	X
Calcine Liquors	1	1	1	X	X	4	4	1	X	X	X	X	1	X
Calcium Acetate	2	1	4	2	4	4	4	1	4	1	1	2	4	4
Calcium Bisulfite	2	1	2	2	2	3	3	1	4	4	4	1	3	3
Calcium Carbonate	1	1	1	1	1	3	3	1	1	1	1	1	1	1
Calcium Chloride	1	1	1	1	1	1	1	1	1	1	1	1	1	1
Calcium Cyanide	1	1	X	1	1	X	X	1	1	1	1	1	X	1
Calcium Hydroxide	1	1	1	1	1	4	2	1	1	1	1	1	1	1
Calcium Hypochlorite	2	1	1	2	2	4	4	1	2	2	2	1	2	2
Calcium Nitrate	1	1	1	1	1	1	1	1	1	1	1	1	1	2
Calcium Phosphate	1	1	1	2	1	1	1	1	1	1	1	1	X	1
Calcium Salts	1	1	1	1	1	1	1	1	1	1	1	1	1	2
Calcium Silicate	1	1	1	1	1	X	X	1	1	1	1	1	X	X
Calcium Sulfide	1	1	1	1	2	4	1	1	2	2	2	1	1	1
Calcium Sulfite	1	1	1	1	2	4	1	1	2	2	2	1	1	1
Calcium Thiosulfate	2	1	1	1	2	4	1	1	2	2	2	1	1	1
Caliche Liquors	1	1	1	1	1	1	1	1	1	1	1	1	1	2
Cane Sugar Liquors	1	1	1	1	1	4	4	1	1	1	1	1	1	1
Caproic Aldehyde	X	2	4	X	X	4	4	2	2	2	2	X	4	2
Carbamate	3	2	1	2	4	4	4	2	4	4	4	2	1	X
Carbitol	2	2	2	2	2	4	4	2	2	2	2	2	2	2
Carbolic Acid Phenol	4	2	1	4	4	4	3	2	4	4	4	4	1	4
Carbon Bisulfide	4	4	1	4	4	3	X	4	4	4	4	4	1	4
Carbon Dioxide	1	1	1	1	1	1	1	1	1	1	1	1	1	1
Carbon Dioxide (Explosive Decompression Use)	1	1	1	1	1	1	1	1	1	1	1	1	1	1
Carbon Disulfide	4	4	1	4	4	3	X	4	4	4	4	4	1	4

# Fluid Compatibility Chart

**COMPATIBILITY RATING:**  
 1 = Satisfactory  
 2 = Fair (Usually OK for Static Seal)  
 3 = Doubtful (Sometimes OK for Static Seal)  
 4 = Unsatisfactory  
 X = Insufficient Data

FLUID NAME	Nitrile	Ethylene Propylene	Fluorocarbon	Neoprene	SBR	Polyacrylate	Polyurethane	Butyl	Butadiene	Isoprene	Natural Rubber	Hypalon	Fluorosilicone	Silicone
Carbon Monoxide	1	1	1	2	2	X	1	1	2	2	2	2	2	1
Carbon Tetrachloride	2	4	1	4	4	4	4	4	4	4	4	4	2	4
Carbonic Acid	2	1	1	1	2	1	1	1	2	1	1	1	1	1
Castor Oil	1	2	1	1	1	1	1	2	1	1	1	1	1	1
Cellosolve	4	2	4	4	4	4	4	2	4	4	4	4	4	4
Cellosolve Butyl	4	2	4	4	4	4	4	2	4	4	4	4	4	4
Cellosolve, Acetate	4	2	4	4	4	4	4	2	4	4	4	4	4	4
Cellugard	1	1	1	1	1	3	4	1	1	1	1	1	1	1
Cellutherm 2505A	2	4	1	4	4	2	4	4	4	4	4	4	2	4
Cetane (Hexadecane)	1	4	1	2	4	1	4	4	4	4	4	2	3	4
China Wood Oil (Tung Oil)	1	4	1	2	4	X	3	3	4	4	4	3	2	4
Chlordane	2	4	1	3	4	X	X	4	4	4	4	3	2	4
Chlorextol	2	4	1	2	4	2	4	4	4	4	4	4	2	4
Chlorinated Solvents, Dry	4	4	1	4	4	4	4	4	4	4	4	4	1	4
Chlorinated Solvents, Wet	4	4	1	4	4	4	4	4	4	4	4	4	1	4
Chlorine Dioxide	4	3	1	4	4	4	4	3	4	4	4	3	2	X
Chlorine Dioxide, 8% Cl as NaClO2 in solution	4	4	1	4	4	4	4	4	4	4	4	4	2	X
Chlorine Trifluoride	4	4	4	4	4	4	4	4	4	4	4	4	4	4
Chlorine, Dry	4	X	2	2	4	4	X	X	4	4	4	2	X	4
Chlorine, Wet	4	X	2	4	4	4	X	X	4	4	4	2	X	4
Chloroacetic Acid	4	2	4	4	4	4	4	2	4	4	4	1	4	X
Chloroacetone	4	1	4	4	4	4	4	2	4	4	4	4	4	4
Chlorobenzene	4	4	1	4	4	4	4	4	4	4	4	4	2	4
Chlorobenzene (Mono)	4	4	1	4	4	4	4	4	4	4	4	4	2	4
Chlorobromo Methane	4	2	1	4	4	4	4	2	4	4	4	4	2	4
Chlorobutadiene	4	4	1	4	4	4	4	4	4	4	4	4	2	4
Chlorododecane	4	4	1	4	4	4	4	4	4	4	4	4	1	4
Chloroform	4	4	1	4	4	4	4	4	4	4	4	4	4	4
Chlorosulphonic Acid	4	4	4	4	4	4	4	4	4	4	4	4	4	4
Chlorotoluene	4	4	1	4	4	4	4	4	4	4	4	4	2	4
Chlorox	2	2	1	2	4	4	4	2	4	4	4	2	1	X
Chrome Alum	1	1	1	1	1	4	X	1	1	1	1	1	X	1
Chrome Plating Solutions	4	2	1	4	4	4	4	2	4	4	4	4	2	2
Circo Light Process Oil	1	4	1	2	4	1	1	4	4	4	4	2	1	4
Citric Acid	1	1	1	1	1	X	1	1	1	1	1	1	1	1
City Service #65 #120 #250	1	4	1	2	4	1	2	4	4	4	4	4	1	4
City Service Koolmoter-AP Gear Oil 140-EP lube	1	4	1	2	4	1	1	4	4	4	4	2	1	4
City Service Pacemaker #2	1	4	1	2	4	1	2	4	4	4	4	4	1	4
Cobalt Chloride	1	1	1	1	1	1	1	1	1	1	1	1	1	2
Cobalt Chloride, 2N	1	1	1	1	1	4	4	1	1	1	1	1	1	1
Cocoonut Oil	1	3	1	3	4	1	3	3	4	4	4	3	1	1
Cod Liver Oil	1	1	1	2	4	1	1	1	4	4	4	2	1	2
Coffee	1	1	1	1	1	4	4	1	1	1	1	1	1	1
Coke Oven Gas	4	4	1	4	4	4	4	4	4	4	4	4	2	2
Coliche Liquors	2	2	X	1	2	X	X	2	1	1	1	X	X	X
Convelex 10	4	X	X	4	4	X	2	4	4	4	4	4	X	4
Coolanol 20 25R 35R 40& 45A (Monsanto)	1	3	1	2	4	4	1	4	4	4	4	2	1	4
Copper Acetate	2	1	4	2	4	4	4	1	4	1	1	2	4	4
Copper Chloride	1	1	1	2	1	1	1	1	1	1	1	2	1	1
Copper Cyanide	1	1	1	1	1	1	1	1	1	1	1	1	1	1
Copper Salts	1	1	1	1	1	1	1	1	1	1	1	1	1	1
Copper Sulfate	1	1	1	1	2	4	1	2	2	2	2	1	1	1
Copper Sulfate 10%	1	1	1	1	2	4	2	2	2	2	2	1	1	1
Copper Sulfate 50%	1	1	1	1	2	4	3	2	2	2	1	1	1	1
Corn Oil	1	3	1	3	4	1	1	3	4	4	4	2	1	1
Cottonseed Oil	1	3	1	3	4	1	1	3	4	4	4	2	2	1
Creosote, Coal Tar	1	4	1	2	4	1	3	4	4	4	4	4	1	4
Creosote, Wood	1	4	1	2	4	1	3	4	4	4	4	4	1	4
Cresols	4	4	2	4	4	4	X	4	4	4	4	4	X	4
Cresylic Acid	4	4	1	4	4	4	4	4	4	4	4	4	X	4
Crude Oil	2	4	1	4	4	1	X	4	4	4	4	4	2	4
Cumene	4	4	1	4	4	4	4	4	4	4	4	4	2	4



# Fluid Compatibility Chart

**COMPATIBILITY RATING:**

- 1 = Satisfactory
- 2 = Fair (Usually OK for Static Seal)
- 3 = Doubtful (Sometimes OK for Static Seal)
- 4 = Unsatisfactory
- X = Insufficient Data

FLUID NAME	MATERIAL													
	Nitrile	Ethylene Propylene	Fluorocarbon	Neoprene	SBR	Polyacrylate	Polyurethane	Butyl	Butadiene	Isoprene	Natural Rubber	Hypalon	Fluorosilicone	Silicone
Cutting Oil	1	4	1	2	4	1	1	4	4	4	4	2	1	4
Cyclohexane	1	4	1	3	4	2	1	4	4	4	4	4	1	4
Cyclohexanol	1	4	1	2	4	X	X	4	4	4	4	2	1	4
Cyclohexanone	4	2	4	4	4	4	4	2	4	4	4	4	4	4
DTE 20 Series, Mobil	2	4	1	1	X	2	1	4	X	X	2	2	2	4
DTE named series, Mobil, light-heavy	1	4	1	2	4	X	1	4	4	X	3	1	1	3
Decalin	4	4	1	4	4	X	X	4	4	4	4	4	1	4
Decane	1	4	1	3	4	1	2	4	4	4	4	3	1	2
Delco Brake Fluid	3	1	4	2	1	X	X	2	X	X	X	2	4	3
Denatured Alcohol	1	1	1	1	1	4	4	1	1	1	1	1	1	1
Detergent, Water Solution	1	1	1	2	2	4	4	1	2	2	2	2	1	1
Developing Fluids (Photo)	1	2	1	1	2	X	X	2	2	1	1	1	1	1
Dexron	1	4	1	2	4	1	2	4	4	4	4	4	2	4
Di-ester Lubricant MIL-L-7808	2	4	1	4	4	2	4	4	4	4	4	4	2	4
Di-ester Synthetic Lubricants	2	4	1	4	4	2	4	4	4	4	4	4	2	4
Diacetone	4	1	4	4	4	4	4	1	4	4	4	4	4	4
Diacetone Alcohol	4	1	4	2	4	4	4	1	4	4	4	2	4	4
Diazinon	3	4	2	3	4	X	X	4	4	4	4	3	2	4
Dibenzyl Ether	4	2	4	4	4	X	2	2	4	4	4	4	X	X
Dibenzyl Sebacate	4	2	2	4	4	4	2	2	4	4	4	4	3	3
Dibromoethyl Benzene	4	4	1	4	4	4	4	4	4	4	4	4	2	4
Dibutyl Ether	4	3	3	4	4	3	2	3	4	4	4	4	3	4
Dibutyl Phthalate	4	2	3	4	4	4	3	3	4	4	4	4	3	2
Dibutyl Sebacate	4	2	2	4	4	4	4	2	4	4	4	4	2	2
Dibutylamine	4	4	4	3	4	4	4	4	4	4	4	4	4	3
Dichloro-Butane	2	4	1	4	4	4	4	4	4	4	4	4	2	4
Dichloro-Isopropyl Ether	4	3	3	4	4	3	2	4	4	4	4	4	3	4
Dicyclohexylamine	3	4	4	4	4	4	4	4	4	4	4	4	4	X
Diesel Oil	1	4	1	3	4	1	3	4	4	4	4	3	1	4
Diethyl Ether	4	4	4	3	4	3	1	4	4	4	4	4	3	4
Diethyl Sebacate	2	2	2	4	4	4	4	2	4	4	4	4	2	2
Diethylamine	2	2	4	2	2	4	3	2	2	2	2	3	4	2
Diethylene Glycol	1	1	1	1	1	2	4	1	1	1	1	1	1	2
Difluorodibromomethane	4	2	X	4	4	4	4	2	4	4	4	4	X	4
Diisobutyl Ketone	X	1	X	X	X	X	X	1	X	X	X	X	X	X
Diisobutylene	2	4	1	4	4	4	4	4	4	4	4	4	3	4
Diisooctyl Sebacate	3	3	2	4	4	4	4	4	4	4	4	4	3	3
Diisopropyl Ketone	4	1	4	4	4	4	4	1	4	4	4	4	4	4
Dimethyl Formamide (DMF)	2	1	4	3	4	4	4	2	X	X	4	4	4	2
Dimethyl Phthalate	4	2	2	4	4	4	X	2	4	4	4	4	2	X
Dinitro Toluene	4	4	4	4	4	4	4	4	4	4	4	4	4	4
Diocetyl Phthalate	4	2	2	4	4	4	4	2	4	4	4	4	2	3
Diocetyl Sebacate	4	2	2	4	4	4	2	2	4	4	4	4	3	3
Dioxane	4	2	4	4	4	4	4	2	4	4	4	4	4	4
Dioxolane	4	2	4	4	4	4	4	3	4	4	4	4	4	4
Dipentene	2	4	1	4	4	4	4	4	4	4	4	4	3	4
Diphenyl	4	4	1	4	4	4	4	4	4	4	4	4	2	4
Diphenyl Oxides	4	4	1	4	4	4	4	4	4	4	4	4	2	3
Dow Chemical 50-4	X	1	4	2	1	X	X	2	X	X	X	2	4	X
Dow Chemical ET378	4	X	X	4	4	3	2	4	4	4	4	4	X	4
Dow Chemical ET588	3	1	4	2	1	X	X	2	X	X	X	2	4	X
Dow Corning -11	2	1	1	1	1	1	1	1	1	1	1	1	1	2
Dow Corning -1265 Fluorosilicone Fluid	2	1	1	1	1	1	1	1	1	1	1	1	3	1
Dow Corning -200	2	1	1	1	1	1	1	1	1	1	1	1	2	3
Dow Corning -3	2	1	1	1	1	1	1	1	1	1	1	1	1	2
Dow Corning -33	2	1	1	1	1	1	1	1	1	1	1	1	2	3
Dow Corning -4	2	1	1	1	1	1	1	1	1	1	1	1	1	2
Dow Corning -44	2	1	1	1	1	1	1	1	1	1	1	1	2	3
Dow Corning -5	2	1	1	1	1	1	1	1	1	1	1	1	2	3
Dow Corning -510	2	1	1	1	1	1	1	1	1	1	1	1	2	3
Dow Corning -55	2	1	1	1	1	1	1	1	1	1	1	1	2	3
Dow Corning -550	2	1	1	1	1	1	1	1	1	1	1	1	2	3

# Fluid Compatibility Chart

**COMPATIBILITY RATING:**  
 1 = Satisfactory  
 2 = Fair (Usually OK for Static Seal)  
 3 = Doubtful (Sometimes OK for Static Seal)  
 4 = Unsatisfactory  
 X = Insufficient Data

FLUID NAME	Nitrile	Ethylene Propylene	Fluorocarbon	Neoprene	SBR	Polyacrylate	Polyurethane	Butyl	Butadiene	Isoprene	Natural Rubber	Hypalon	Fluorosilicone	Silicone
Dow Corning -704	2	1	1	1	1	1	1	1	1	1	1	1	2	3
Dow Corning -705	2	1	1	1	1	1	1	1	1	1	1	1	2	3
Dow Corning -710	2	1	1	1	1	1	1	1	1	1	1	1	2	3
Dow Guard	1	1	1	1	1	3	3	1	1	1	1	1	1	1
Dowtherm, 209	3	1	4	2	X	X	X	2	X	X	X	X	3	3
Dowtherm, A	4	4	1	4	4	4	4	4	4	4	4	4	2	4
Dowtherm, E	4	4	1	4	4	4	4	4	4	4	4	4	2	4
Drinking Water	1	1	1	2	1	4	4	1	1	1	1	1	1	1
Dry Cleaning Fluids	3	4	1	4	4	4	4	4	4	4	4	4	2	4
Elco 28-EP lubricant	1	4	1	3	4	1	1	4	4	4	4	4	1	2
Epichlorohydrin	4	2	4	4	4	4	4	2	4	4	4	4	4	4
Epoxy Resins	X	1	4	1	X	X	X	1	X	X	X	X	X	X
Esam-6 Fluid	X	1	4	2	1	X	X	2	X	X	X	2	4	X
Esso Fuel 208	1	4	1	2	4	1	4	4	4	4	4	3	1	4
Esso Golden Gasoline	2	4	1	4	4	4	4	4	4	4	4	4	1	4
Esso Motor Oil	1	4	1	3	4	1	4	4	4	4	4	4	1	4
Esso Transmission fluid (Type A)	1	4	1	2	4	1	3	4	4	4	4	4	1	4
Esso WS2812 (MIL-L-7808A)	1	4	1	4	4	2	4	4	4	4	4	4	1	4
Esso XP90-EP lubricant	1	4	1	2	4	1	1	4	4	4	4	2	1	4
Esstic 42, 43	1	4	1	2	4	1	2	4	4	4	4	4	1	4
Ethane	1	4	1	2	4	1	3	4	4	4	4	2	3	4
Ethanol	3	1	3	1	1	4	4	1	1	1	1	1	1	2
Ethanol Amine	2	2	4	2	2	4	3	2	2	2	2	3	4	2
Ethers	4	3	3	4	4	3	2	4	4	4	4	4	3	4
Ethyl Acetate-Organic ester	4	2	4	4	4	4	4	2	4	4	4	4	4	2
Ethyl Acetoacetate	4	2	4	4	3	4	4	2	3	3	3	4	4	2
Ethyl Acrylate	4	2	4	4	4	4	4	2	4	4	4	4	4	2
Ethyl Alcohol	3	1	3	1	1	4	4	1	1	1	1	1	1	2
Ethyl Benzene	4	4	1	4	4	4	4	4	4	4	4	4	1	4
Ethyl Benzoate	4	4	1	4	4	4	4	4	4	4	4	4	1	4
Ethyl Bromide	2	4	1	4	X	X	X	4	4	4	4	4	1	X
Ethyl Cellosolve	4	2	4	4	4	4	4	2	4	4	4	4	4	4
Ethyl Cellulose	2	2	4	2	2	4	2	2	2	2	2	2	4	2
Ethyl Chloride	1	3	1	4	4	3	2	4	2	1	4	4	1	4
Ethyl Chlorocarbonate	4	2	1	4	4	4	4	4	4	4	4	4	2	4
Ethyl Chloroformate	4	2	4	4	4	4	4	3	4	4	4	4	4	4
Ethyl Ether	3	3	4	4	4	4	2	3	4	4	4	4	3	4
Ethyl Formate	4	2	1	2	4	X	X	2	4	4	4	2	1	X
Ethyl Hexanol	1	1	1	1	1	4	4	1	1	1	1	1	1	2
Ethyl Mercaptan	4	X	2	3	4	X	X	4	4	4	4	3	X	3
Ethyl Oxalate	4	1	2	4	4	4	X	4	4	1	4	4	2	4
Ethyl Pentachlorobenzene	4	4	1	4	4	4	4	4	4	4	4	4	2	4
Ethyl Silicate	1	1	1	1	2	X	X	1	2	2	2	2	1	X
Ethylacrylic Acid	4	2	X	2	4	4	4	2	4	4	4	4	4	4
Ethylcyclopentane	1	4	1	3	4	2	1	4	4	4	4	4	1	4
Ethylene Chloride	4	4	2	4	4	4	4	4	4	4	4	4	2	4
Ethylene Chlorohydrin	4	2	1	2	2	4	4	2	2	2	2	2	2	3
Ethylene Diamine	1	1	4	1	2	4	4	1	2	1	1	2	4	1
Ethylene Dibromide	4	3	1	4	4	4	4	3	4	4	4	4	3	4
Ethylene Dichloride	4	3	1	4	4	4	4	3	4	4	4	4	3	4
Ethylene Glycol	1	1	1	1	1	4	2	1	1	1	1	1	1	1
Ethylene Oxide	4	3	4	4	4	4	4	3	4	4	4	4	4	4
Ethylene Oxide, (12%) and Freon 12 (80%)	3	2	4	4	4	4	4	2	4	4	4	4	4	4
Ethylene Trichloride	4	3	1	4	4	4	4	3	4	4	4	4	3	4
Ethylmorpholene Stannous Octotatate (50/50 mixture)	4	2	4	X	4	X	X	2	X	X	X	X	X	X
F-60 Fluid (Dow Corning)	1	1	1	1	1	1	1	1	1	1	1	1	1	4
F-61 Fluid (Dow Corning)	1	1	1	1	1	1	1	1	1	1	1	1	1	4
FC-43 Heptacosofluorotri-butylamine	1	1	1	1	4	X	X	1	X	X	X	1	1	1
FC75 & FC77 (Fluorocarbon)	1	1	2	1	4	X	X	1	X	X	X	1	2	1
Fatty Acids	2	3	1	2	4	X	X	3	4	4	4	2	X	3
Ferric Chloride	1	1	1	2	1	1	1	1	1	1	1	2	1	2
Ferric Nitrate	1	1	1	1	1	1	1	1	1	1	1	1	1	2

# Fluid Compatibility Chart

**COMPATIBILITY RATING:**

1 = Satisfactory  
 2 = Fair (Usually OK for Static Seal)  
 3 = Doubtful (Sometimes OK for Static Seal)  
 4 = Unsatisfactory  
 X = Insufficient Data

FLUID NAME	Nitrile	Ethylene Propylene	Fluorocarbon	Neoprene	SBR	Polyacrylate	Polyurethane	Butyl	Butadiene	Isoprene	Natural Rubber	Hypalon	Fluorosilicone	Silicone
Fisher Reagent	X	2	X	X	X	X	X	X	X	X	X	X	X	X
Fluorolube	1	1	2	1	4	X	X	1	X	X	X	1	2	1
Formaldehyde	3	2	4	3	3	4	4	2	2	2	2	2	4	2
Freon, 11	4	4	2	4	4	4	X	4	X	X	4	1	2	4
Freon, 112	2	4	1	2	4	X	X	4	X	X	4	2	X	4
Freon, 113	1	4	2	1	2	X	1	4	X	X	4	1	X	4
Freon, 114	1	1	1	1	1	X	X	1	X	X	1	X	X	4
Freon, 114B2	2	4	2	2	4	X	X	4	X	X	4	1	X	4
Freon, 115, 116	1	1	2	1	1	X	X	1	X	X	1	X	X	X
Freon, 12	2	3	3	1	1	X	1	3	4	4	2	1	3	4
Freon, 12 and ASTM Oil #2 (50/50 Mixture)	2	4	1	3	4	X	X	4	4	4	4	2	2	4
Freon, 12 and Suniso 4G (50/50 Mixture)	2	4	1	3	4	X	X	4	4	4	4	2	2	4
Freon, 13	1	1	1	1	1	X	X	1	X	1	1	1	4	4
Freon, 13B1	1	1	1	1	1	X	X	1	X	X	1	1	2	4
Freon, 14	1	1	1	1	1	X	1	1	X	X	1	1	X	4
Freon, 21	4	4	4	3	4	X	X	4	4	4	4	4	X	4
Freon, 22	4	3	4	1	1	2	4	3	X	X	1	1	4	4
Freon, 22 and ASTM Oil #2 (50/50 Mixture)	4	4	2	2	4	2	X	4	X	X	4	X	2	4
Freon, 31	4	1	4	1	2	X	X	1	X	X	2	2	X	X
Freon, 32	1	1	4	1	1	X	X	1	X	X	1	1	X	X
Freon, 502	2	1	2	1	1	X	X	1	X	X	1	X	X	X
Freon, BF	2	4	1	2	4	X	X	4	X	X	4	2	X	4
Freon, C318	1	1	2	1	1	X	X	1	X	X	1	1	X	X
Freon, K-142b	1	1	4	1	1	X	X	1	X	X	2	1	X	X
Freon, K-152a	1	1	4	1	1	X	X	1	X	X	1	4	X	X
Freon, MF	2	4	2	4	4	X	3	4	X	X	4	1	X	4
Freon, PCA	1	4	2	1	2	X	1	4	X	X	4	1	X	4
Freon, TF	1	4	2	1	2	X	1	4	X	X	4	1	X	4
Fuel Oil, #6	2	4	1	4	4	1	2	4	4	4	4	4	1	1
Fuel Oil, 1, and 2	1	4	1	2	4	1	2	4	4	4	4	3	1	4
Fuel Oil, Acidic	1	4	1	2	4	1	2	4	4	4	4	4	1	1
Fumaric Acid	1	2	1	2	2	4	X	4	2	1	3	2	1	2
Fuming Sulphuric Acid (20/25% Oleum)	4	4	1	4	4	4	4	4	4	4	4	4	X	4
Furan (Furfuran)	4	3	X	4	4	4	X	4	4	4	4	4	X	X
Furfural	4	2	4	4	4	4	3	2	4	4	4	3	X	4
Furfuraldehyde	4	2	4	4	4	4	X	2	4	4	4	4	X	4
Furfuryl Alcohol	4	2	X	4	4	4	4	2	4	4	4	4	4	4
Furyl Carbinol	4	2	X	4	4	4	4	2	4	4	4	4	4	4
Fyrquel 150 220 300 550	4	1	1	4	4	4	4	1	4	4	4	4	2	1
Gallic Acid	2	2	1	2	2	4	4	2	X	1	1	2	1	X
Gasoline	1	4	1	4	4	4	2	4	4	4	4	4	1	4
Gelatin	1	1	1	1	1	4	4	1	1	1	1	1	1	1
Girling Brake Fluid	3	1	4	2	1	X	X	2	X	X	X	2	4	X
Glacial Acetic Acid	2	2	4	4	2	4	4	2	2	2	2	4	4	2
Glauber's Salt	4	2	1	2	4	4	X	2	4	2	2	2	1	X
Glucose	1	1	1	1	1	X	4	1	1	1	1	1	1	1
Glycerine - Glycerol	1	1	1	1	1	4	4	1	1	1	1	1	1	1
Glycols	1	1	1	1	1	4	4	1	1	1	1	1	1	1
Grease Petroleum Base	1	4	1	3	4	1	1	4	4	4	4	4	1	4
Green Sulphate Liquor	2	1	1	2	2	4	4	1	2	2	2	2	2	X
Gulf Endurance Oils	1	4	1	2	4	1	1	4	4	4	4	4	1	4
Gulf FR Fluids (Emulsion)	1	4	1	2	4	1	1	4	4	4	4	4	1	4
Gulf FR G-Fluids	1	1	1	1	1	4	2	1	1	1	1	1	1	1
Gulf FR P-Fluids	4	2	2	4	4	4	4	2	4	4	4	4	2	1
Gulf Harmony Oils	1	4	1	2	4	1	1	4	4	4	4	4	1	4
Gulf High Temperature Grease	1	4	1	2	4	1	1	4	4	4	4	4	1	4
Gulf Legion Oils	1	4	1	2	4	1	1	4	4	4	4	4	1	4
Gulf Paramount Oils	1	4	1	2	4	1	2	4	4	4	4	4	1	4
Gulf Security Oils	1	4	1	2	4	1	2	4	4	4	4	4	1	4
Gulfcrown Grease	1	4	1	2	4	1	1	4	4	4	4	4	1	4
HEF-2 (High Energy Fuel)	2	4	1	4	4	4	4	4	4	4	4	4	2	4
Halothane	4	4	1	4	4	4	4	4	4	4	4	4	2	4

# Fluid Compatibility Chart

**COMPATIBILITY RATING:**  
 1 = Satisfactory  
 2 = Fair (Usually OK for Static Seal)  
 3 = Doubtful (Sometimes OK for Static Seal)  
 4 = Unsatisfactory  
 X = Insufficient Data

FLUID NAME	Nitrile	Ethylene Propylene	Fluorocarbon	Neoprene	SBR	Polyacrylate	Polyurethane	Butyl	Butadiene	Isoprene	Natural Rubber	Hypalon	Fluorosilicone	Silicone
Halowax Oil	4	4	1	4	4	X	X	4	4	4	4	1	4	
Hannifin Lube A	1	4	1	1	2	1	1	4	4	4	4	1	1	2
Heavy Water	1	1	X	2	1	4	4	1	1	1	1	1	1	1
Helium	1	1	1	1	1	1	1	1	1	1	1	1	1	1
Hexyl Alcohol	1	3	1	2	1	4	4	3	1	1	1	2	2	2
HiLo MS #1	4	1	4	4	4	4	4	2	4	4	4	4	3	3
High Viscosity Lubricant, H2	1	1	1	2	1	4	4	1	2	X	X	X	2	1
High Viscosity Lubricant, U4	1	1	1	2	1	4	4	1	2	X	X	X	2	1
Houghto-Safe 1010 phosphate ester	4	1	1	4	4	4	X	1	4	4	4	4	2	3
Houghto-Safe 1055 phosphate ester	4	1	1	4	4	4	X	1	4	4	4	4	2	3
Houghto-Safe 1120 phosphate ester	4	2	1	4	4	4	4	1	4	4	4	4	2	3
Houghto-Safe 271 (Water & Glycol Base)	1	1	2	2	1	4	4	2	X	X	X	X	2	2
Houghto-Safe 416 & 500 Series	1	1	X	X	X	X	X	X	X	X	X	X	X	X
Houghto-Safe 5040 (Water/Oil emulsion)	1	4	1	2	4	4	4	4	4	4	4	4	2	3
Houghto-Safe 620 Water/Glycol	1	1	2	2	1	4	4	2	X	X	X	X	2	2
Hydraulic Oil, Petroleum Base, Industrial	1	4	1	2	4	1	1	4	4	4	4	2	1	2
Hydrazine	2	1	4	2	2	X	4	1	X	X	1	2	4	2
Hydro-Drive MIH-10 (Petroleum Base)	1	4	1	2	4	1	2	4	4	4	4	4	1	2
Hydro-Drive MIH-50 (Petroleum Base)	1	4	1	2	4	1	2	4	4	4	4	4	1	2
Hydrobromic Acid	4	1	1	4	4	4	4	1	4	1	1	1	3	4
Hydrobromic Acid 40%	4	1	1	2	4	4	4	1	4	1	1	1	3	4
Hydrocarbons, Saturated	1	4	1	2	4	1	2	4	4	4	4	3	1	4
Hydrochloric Acid, 3 Molar to 158°F	2	1	1	2	3	3	4	1	X	X	3	1	3	4
Hydrochloric Acid, Concentrated Room Temp.	2	2	1	X	X	X	X	X	X	X	X	X	X	X
Hydrochloric Acid, Concentrated to 158°F	4	4	4	4	4	4	4	4	X	X	4	X	4	4
Hydrocyanic Acid	2	1	1	2	2	4	X	1	2	1	1	1	2	3
Hydrofluosilicic Acid	2	1	1	2	2	X	X	1	X	1	1	1	4	4
Hydrogen Gas, Cold	1	1	1	1	2	2	1	1	1	1	2	1	3	3
Hydrogen Gas, Hot	1	1	1	1	2	2	1	1	1	1	2	1	3	3
Hydrogen Peroxide	2	1	1	1	2	4	X	1	2	2	2	2	1	1
Hydrogen Peroxide 90%	4	3	1	4	4	4	X	3	4	4	4	3	2	2
Hydrogen Sulfide Dry Cold	1	1	4	1	1	4	X	1	1	1	1	1	3	3
Hydrogen Sulfide Dry Hot	4	1	4	2	4	4	X	1	4	4	4	3	3	3
Hydrogen Sulfide Wet Cold	4	1	4	1	4	4	X	1	4	4	4	2	3	3
Hydrogen Sulfide Wet Hot	4	1	4	2	4	4	X	1	4	4	4	3	3	3
Hydrolube-Water/Ethylene Glycol	1	1	1	2	1	4	4	2	X	X	X	X	2	2
Hydroquinone	3	2	2	4	4	4	X	4	4	2	2	4	2	X
Hydne	2	1	4	2	2	4	X	2	2	2	2	X	4	4
Hyjet IV and IVA	4	1	4	4	4	4	4	2	4	4	4	4	4	4
Hypochlorous Acid	4	2	1	4	4	4	X	2	4	2	2	1	X	X
Industron FF44	1	4	1	2	4	1	2	4	4	4	4	4	1	4
Industron FF48	1	4	1	2	4	1	2	4	4	4	4	4	1	4
Industron FF53	1	4	1	2	4	1	2	4	4	4	4	4	1	4
Industron FF80	1	4	1	2	4	1	2	4	4	4	4	4	1	4
Iodine	2	2	1	4	2	X	X	2	X	4	X	2	1	X
Iodine Pentafluoride	4	4	4	4	4	4	4	4	4	4	4	4	4	4
Iso Octane	1	4	1	2	4	1	2	4	4	4	4	1	1	4
Iso-Butyl N-Butyrate	4	1	1	4	4	4	X	1	4	4	4	4	1	X
Isobutyl Alcohol	2	1	1	1	2	4	4	1	2	1	1	1	2	1
Isododecane	1	4	1	2	4	4	X	4	4	4	4	2	1	4
Isophorone (Ketone)	4	2	4	4	4	4	4	2	4	4	4	4	4	4
Isopropanol	2	1	1	2	2	4	4	1	2	1	1	1	2	1
Isopropyl Acetate	4	2	4	4	4	4	4	2	4	4	4	4	2	4
Isopropyl Alcohol	2	1	1	2	2	4	4	1	2	1	1	1	2	1
Isopropyl Chloride	4	4	1	4	4	4	4	4	4	4	4	4	2	4
Isopropyl Ether	2	4	4	3	4	3	2	4	4	4	4	3	3	4
JP-10	3	4	1	4	4	4	3	4	X	X	4	X	1	4
JP-4 (MIL-T-5624)	1	4	1	4	4	2	2	4	4	4	4	4	2	4
JP-5 (MIL-T-5624)	1	4	1	4	4	2	2	4	4	4	4	4	2	4
JP-6 (MIL-J-25656)	1	4	1	4	4	2	2	4	4	4	4	4	2	4
JP-8 (MIL-T-83133)	1	4	1	3	4	1	1	4	X	X	4	X	2	4
JP-9 (MIL-F-81912)	3	4	1	4	4	4	3	4	X	X	4	X	2	4

# Fluid Compatibility Chart

**COMPATIBILITY RATING:**  
 1 = Satisfactory  
 2 = Fair (Usually OK for Static Seal)  
 3 = Doubtful (Sometimes OK for Static Seal)  
 4 = Unsatisfactory  
 X = Insufficient Data

FLUID NAME	Nitrile	Ethylene Propylene	Fluorocarbon	Neoprene	SBR	Polyacrylate	Polyurethane	Butyl	Butadiene	Isoprene	Natural Rubber	Hypalon	Fluorosilicone	Silicone
JP-9 -11	4	4	1	4	4	4	4	4	X	X	4	X	2	4
Kel F Liquids	1	1	2	X	1	X	X	1	X	X	X	1	2	1
Kerosene (Similar to RP-1 and JP-1)	1	4	1	2	4	1	1	4	4	4	4	4	1	4
Keystone #87HX-Grease	1	4	1	4	4	1	1	4	4	4	4	4	1	4
Lacquer Solvents	4	4	4	4	4	4	4	4	4	4	4	4	4	4
Lacquers	4	4	4	4	4	4	4	4	4	4	4	4	4	4
Lactams-Amino Acids	4	2	4	2	4	X	X	2	4	4	4	2	4	X
Lactic Acid Cold	1	1	1	1	1	4	X	1	1	1	1	1	1	1
Lactic Acid Hot	4	4	1	4	4	4	X	4	4	4	4	3	2	2
Lactones (Cyclic Esters)	4	2	4	4	4	4	4	2	4	4	4	4	4	2
Lard Animal Fat	1	2	1	2	4	1	1	2	4	4	4	4	1	2
Lead Acetate	2	1	4	2	4	4	4	1	4	1	1	4	4	4
Lead Nitrate	1	1	X	1	1	X	X	1	1	1	1	1	1	2
Lead Sulphamate	2	1	1	1	2	4	X	1	2	2	2	1	1	2
Lehigh X1169	1	4	1	2	4	1	1	4	4	4	4	2	1	4
Lehigh X1170	1	4	1	2	4	1	1	4	4	4	4	2	1	4
Ligroin (Petroleum Ether or Benzine)	1	4	1	2	4	1	2	4	4	4	4	3	1	4
Lindol, Hydraulic Fluid (Phosphate ester type)	4	1	2	4	4	4	4	1	4	4	4	4	3	3
Linoleic Acid	2	4	2	2	4	X	X	4	4	4	4	2	X	2
Linseed Oil	1	3	1	3	4	1	2	3	4	4	4	2	1	1
Liquid Oxygen (LOX)	4	4	4	4	4	4	4	4	4	4	4	4	4	4
Liquid Petroleum Gas (LPG)	1	4	1	2	4	3	1	4	4	4	4	4	3	3
Liquimoly	1	4	1	2	4	1	2	4	4	4	4	4	1	4
Lubricating Oils, Di-ester	2	4	1	3	4	2	X	4	4	4	4	X	2	4
Lubricating Oils, SAE 10, 20, 30, 40, 50	1	4	1	2	4	1	2	4	4	4	4	4	1	4
Lubricating Oils, petroleum base	1	4	1	2	4	1	2	4	4	4	4	4	1	4
Lye Solutions	2	1	2	2	2	4	4	1	2	2	1	1	2	2
MCS 312	4	4	1	4	4	4	X	4	4	4	4	X	1	1
MCS 352	4	1	4	4	4	4	4	2	4	4	4	4	3	3
MCS 463	4	1	4	4	4	4	4	2	4	4	4	4	3	3
MIL-A-6091	2	1	1	1	1	4	4	1	1	1	1	1	1	1
MIL-C-4339	1	4	1	4	4	1	1	4	4	4	4	4	1	3
MIL-C-7024	1	4	1	2	4	2	1	4	4	4	4	4	1	4
MIL-C-8188	2	4	2	4	4	3	4	4	4	4	4	4	2	4
MIL-E-9500	1	1	1	1	1	4	4	1	1	1	1	1	1	1
MIL-F-16884	1	4	1	3	4	1	3	4	4	4	4	3	1	4
MIL-F-17111	1	4	1	2	4	1	3	4	4	4	4	2	2	4
MIL-F-25558 (RJ-1)	1	4	1	2	4	1	1	4	4	4	4	2	1	4
MIL-F-25656	1	4	1	4	4	2	2	4	4	4	4	4	2	4
MIL-F-5566	2	1	1	2	2	4	2	1	2	1	1	1	1	1
MIL-F-81912 (JP-9)	3	4	1	4	4	4	3	4	X	X	4	X	2	4
MIL-F-82522 (RJ-4)	2	4	1	4	4	1	1	4	1	1	1	X	1	4
MIL-G-10924	1	4	1	2	4	2	1	4	4	4	4	2	1	4
MIL-G-15793	1	4	1	2	4	1	1	4	4	4	4	2	2	4
MIL-G-21568	1	1	1	1	1	1	1	1	1	1	1	1	1	4
MIL-G-25013	1	1	1	2	1	1	3	1	4	4	2	2	1	4
MIL-G-25537	1	4	1	2	4	2	1	4	4	4	4	2	1	4
MIL-G-25760	2	4	1	2	4	2	2	4	4	4	4	2	2	4
MIL-G-3278	2	4	1	4	4	1	2	4	4	4	4	4	2	4
MIL-G-3545	1	4	1	2	4	1	1	4	4	4	4	2	1	4
MIL-G-4343	2	3	1	2	1	1	1	3	1	1	1	1	1	3
MIL-G-5572	1	4	1	4	4	2	2	4	4	4	4	4	1	4
MIL-G-7118	2	4	1	2	4	3	3	4	4	4	4	2	1	4
MIL-G-7187	1	4	1	4	4	1	1	4	4	4	4	4	1	4
MIL-G-7421	2	4	1	2	4	4	2	4	4	4	4	2	2	4
MIL-G-7711	1	4	1	4	4	2	1	4	4	4	4	4	1	2
MIL-H-13910	1	1	1	1	1	2	4	1	1	1	1	1	2	4
MIL-H-19457	4	2	1	4	4	4	4	1	4	4	4	4	4	3
MIL-H-22251	2	1	X	2	2	X	X	1	X	X	X	2	X	4
MIL-H-27601	1	4	1	2	4	1	3	4	4	4	4	3	2	4
MIL-H-46170 -15°F to +400°F	1	4	1	2	4	2	2	4	4	4	4	2	1	4
MIL-H-46170 -20°F to +275°F	1	4	1	2	4	2	2	4	4	4	4	2	1	4

# Fluid Compatibility Chart

**COMPATIBILITY RATING:**  
 1 = Satisfactory  
 2 = Fair (Usually OK for Static Seal)  
 3 = Doubtful (Sometimes OK for Static Seal)  
 4 = Unsatisfactory  
 X = Insufficient Data

FLUID NAME	MATERIAL													
	Nitrile	Ethylene Propylene	Fluorocarbon	Neoprene	SBR	Polyacrylate	Polyurethane	Butyl	Butadiene	Isoprene	Natural Rubber	Hypalon	Fluorosilicone	Silicone
MIL-H-46170 -55°F to +275°F	1	4	1	2	4	2	2	4	4	4	4	2	1	4
MIL-H-46170 -65°F to +275°F	1	4	1	2	4	2	2	4	4	4	4	2	1	4
MIL-H-5606 -65°F to +235°F	1	4	1	2	4	2	2	4	4	4	4	2	1	4
MIL-H-5606 -65°F to +275°F	1	4	1	2	4	2	2	4	4	4	4	2	1	4
MIL-H-6083	1	4	1	1	4	1	1	4	4	4	2	2	1	4
MIL-H-7083	1	1	2	2	2	4	4	1	3	3	2	2	1	1
MIL-H-8446 (MLO-8515)	2	4	1	1	4	3	4	4	4	4	4	X	1	4
MIL-J-5161	2	4	1	4	4	1	2	4	4	4	4	4	1	4
MIL-L-15016	1	4	1	2	4	1	1	4	4	4	4	2	2	4
MIL-L-15017	1	4	1	2	4	1	1	4	4	4	4	2	2	4
MIL-L-17331	1	4	1	X	4	X	X	4	4	4	4	X	X	4
MIL-L-2104	1	4	1	2	4	1	1	4	4	4	4	3	1	4
MIL-L-21260	1	4	1	2	4	1	1	4	4	4	4	2	1	4
MIL-L-23699	2	4	1	3	4	3	3	4	4	4	4	3	2	4
MIL-L-25681	2	1	1	2	2	2	3	1	2	2	2	2	2	4
MIL-L-3150	1	4	1	2	4	2	2	4	4	4	4	2	1	4
MIL-L-6081	1	4	1	2	4	1	1	4	4	4	4	2	1	4
MIL-L-6082	1	4	1	2	4	1	1	4	4	4	4	2	1	3
MIL-L-6085	2	4	1	4	4	2	3	4	4	4	4	4	2	4
MIL-L-6387	2	4	1	4	4	2	1	4	4	4	4	4	2	4
MIL-L-7808	2	4	1	4	4	2	4	4	4	4	4	4	2	4
MIL-L-7870	1	4	1	2	4	1	2	4	4	4	4	4	1	4
MIL-L-9000	1	4	1	2	4	1	3	4	4	4	4	2	2	4
MIL-L-9236	2	4	1	4	4	2	2	4	4	4	4	4	2	4
MIL-O-3503	1	4	1	2	4	2	1	4	4	4	4	2	1	4
MIL-P-27402	2	1	X	2	2	X	X	1	X	X	X	2	X	4
MIL-R-25576 (RP-1)	1	4	1	2	4	1	1	4	4	4	4	2	1	4
MIL-S-3136, Type I Fuel	1	4	1	2	4	1	1	4	4	4	4	2	1	4
MIL-S-3136, Type II Fuel	2	4	1	4	4	3	2	4	4	4	4	4	2	4
MIL-S-3136, Type III Fuel	2	4	1	4	4	3	2	4	4	4	4	4	2	4
MIL-S-3136, Type IV Oil High Swell	1	4	1	4	4	1	1	4	4	4	4	4	1	2
MIL-S-3136, Type IV Oil Low Swell	1	4	1	1	4	1	1	4	4	4	4	1	1	3
MIL-S-3136, Type V Oil Medium Swell	1	4	1	2	4	1	1	4	4	4	4	2	1	2
MIL-S-81087	1	1	1	1	1	1	1	1	1	1	1	1	2	3
MIL-T-5624, JP-4, JP-5	1	4	1	4	4	2	2	4	4	4	4	4	2	4
MIL-T-83133	1	4	1	3	4	1	1	4	X	X	4	X	2	4
MLO-7277 Hydr.	3	4	1	4	4	3	3	4	4	4	4	4	3	4
MLO-7557	3	4	1	4	4	3	3	4	4	4	4	4	3	4
MLO-8200 Hydr.	2	4	1	1	4	X	1	4	4	4	4	4	2	4
MLO-8515	2	4	1	1	4	3	1	4	4	4	4	3	1	4
Magnesium Chloride	1	1	1	1	1	X	1	1	1	1	1	1	1	1
Magnesium Hydroxide	2	1	1	2	2	4	4	1	2	2	2	1	X	X
Magnesium Salts	1	1	1	1	1	1	1	1	1	1	1	1	1	1
Magnesium Sulphite and Sulphate	1	1	1	1	2	4	X	1	2	2	2	1	1	1
Malathion	2	4	1	X	4	X	X	4	4	4	4	X	2	4
Maleic Acid	4	4	1	4	4	4	X	4	4	4	4	4	X	X
Maleic Anhydride	4	2	4	4	4	4	X	2	4	4	4	4	X	X
Malic Acid	1	2	1	2	2	4	X	4	2	1	3	2	1	2
Mercuric Chloride	1	1	1	1	1	X	X	1	1	1	1	1	X	X
Mercury	1	1	1	1	1	X	X	1	1	1	1	1	X	X
Mercury Vapors	1	1	1	1	1	X	X	1	1	1	1	1	X	X
Mesityl Oxide (Ketone)	4	2	4	4	4	4	4	2	4	4	4	4	4	4
Methane	1	4	1	2	4	1	3	4	4	4	4	2	3	4
Methanol	4	1	4	1	1	4	4	1	1	1	1	1	1	1
Methyl Acetate	4	2	4	2	4	4	4	2	4	4	4	4	4	4
Methyl Acetoacetate	4	2	4	4	X	4	4	2	X	X	X	4	4	2
Methyl Acrylate	4	2	4	2	4	4	4	2	4	4	4	4	4	4
Methyl Alcohol	4	1	4	1	1	4	4	1	1	1	1	1	1	1
Methyl Benzoate	4	4	1	4	4	4	4	4	4	4	4	4	1	4
Methyl Bromide	2	4	1	4	4	3	X	4	4	4	4	4	1	X
Methyl Butyl Ketone	4	1	4	4	4	4	4	1	4	4	4	4	4	4
Methyl Carbonate	4	4	1	4	4	4	4	4	4	4	4	4	2	4

# Fluid Compatibility Chart

**COMPATIBILITY RATING:**

- 1 = Satisfactory
- 2 = Fair (Usually OK for Static Seal)
- 3 = Doubtful (Sometimes OK for Static Seal)
- 4 = Unsatisfactory
- X = Insufficient Data

FLUID NAME	MATERIAL													
	Nitrile	Ethylene Propylene	Fluorocarbon	Neoprene	SBR	Polyacrylate	Polyurethane	Butyl	Butadiene	Isoprene	Natural Rubber	Hypalon	Fluorosilicone	Silicone
Methyl Cellosolve	3	2	4	3	4	4	4	2	4	4	4	2	4	4
Methyl Cellulose	2	2	4	2	2	4	2	2	2	2	2	2	4	2
Methyl Chloride	4	3	1	4	4	4	4	3	4	4	4	4	2	4
Methyl Chloroformate	4	4	1	4	4	4	4	4	4	4	4	4	2	4
Methyl Ether	1	4	1	3	4	4	X	4	1	1	4	4	1	1
Methyl Ethyl Ketone (MEK)	4	1	4	4	4	4	4	1	4	4	4	4	4	4
Methyl Ethyl Ketone Peroxide	4	4	4	4	4	4	4	4	4	4	4	4	4	2
Methyl Formate	4	2	X	2	4	X	X	2	4	4	4	2	X	X
Methyl Isobutyl Ketone (MIBK)	4	3	4	4	4	4	4	3	4	4	4	4	4	4
Methyl Isopropyl Ketone	4	2	4	4	4	4	4	2	4	4	4	4	4	4
Methyl Mercaptan	X	1	X	X	X	X	X	1	X	X	X	X	X	X
Methyl Methacrylate	4	4	4	4	4	4	X	4	4	4	4	4	4	4
Methyl Oleate	4	2	1	4	4	X	X	2	4	X	4	4	2	X
Methyl Salicylate	4	2	X	4	3	X	X	2	X	X	3	4	X	X
Methylacrylic Acid	4	2	3	2	4	4	4	2	4	4	4	4	4	4
Methylcyclopentane	4	4	1	4	4	4	4	4	4	4	4	4	2	4
Methylene Chloride	4	4	2	4	4	4	4	4	4	4	4	4	2	4
Milk	1	1	1	1	1	4	4	1	1	1	1	1	1	1
Mineral Oils	1	3	1	2	4	1	1	3	4	4	4	2	1	2
Mobil SHC 500 Series	3	4	1	2	X	1	2	4	X	X	X	2	2	2
Mobil SHC 600 Series	3	4	1	2	4	1	1	4	X	X	X	2	2	3
Mobilgear 600 Series	3	3	1	1	4	1	2	3	3	4	4	2	1	1
Mobilgear SHC ISO Series	3	3	1	2	4	1	2	3	3	4	4	2	1	1
Mobilgrease HP	2	4	1	2	4	1	1	4	X	4	4	3	1	2
Mobilgrease HTS	2	4	1	2	4	1	1	4	X	4	4	3	1	2
Mobilgrease SM	2	4	1	2	4	1	1	4	X	4	4	3	1	2
Mobilith AW Series	2	4	1	2	4	1	1	4	X	4	4	3	1	2
Mobilith SHC Series	2	4	1	3	4	1	1	4	X	4	4	3	1	2
Mobilmistlube Series	3	3	1	1	4	1	2	3	3	4	4	2	1	1
Mono Bromobenzene	4	4	1	4	4	4	4	4	4	4	4	4	2	4
Mono Ethanolamine	4	2	4	4	2	4	4	2	2	2	2	4	4	2
Monochlorobenzene	4	4	1	4	4	4	4	4	4	4	4	4	2	4
Mononitrotoluene & Dinitrotoluene (40/60 Mixture)	4	4	3	4	4	4	4	4	4	4	4	4	3	4
Monomethyl Hydrazine	2	1	X	2	2	X	X	1	X	X	X	2	X	4
Monomethylaniline	4	2	2	4	4	4	4	2	4	4	4	4	X	X
Monovinyl Acetylene	1	1	1	2	2	X	X	1	2	2	2	2	X	2
Mopar Brake Fluid	3	1	4	2	1	X	X	2	X	X	X	2	4	3
N-Butyl Acetate	4	2	4	4	4	4	4	2	4	4	4	4	4	4
N-Butyl Benzoate	4	1	1	4	2	4	X	1	4	4	4	4	1	X
N-Butyl Butyrate	4	1	1	4	4	4	X	1	4	4	4	4	1	X
N-Butyl Ether	3	3	4	4	4	4	3	3	4	4	4	4	3	4
N-Heptane	1	4	1	2	4	1	2	4	4	4	4	2	3	4
N-Hexaldehyde	4	1	4	1	4	X	2	2	4	4	4	3	4	2
N-Hexane	1	4	1	2	4	1	2	4	4	4	4	2	3	4
N-Hexane-1	2	4	1	2	4	1	2	4	4	4	4	2	4	4
N-Methyl-2-Pyrrolidone	X	2	X	X	X	X	X	X	X	X	X	X	X	X
N-Octane	1	4	1	4	4	4	4	4	4	4	4	4	2	4
N-Pentane	1	4	1	1	3	1	4	4	4	4	4	2	3	4
N-Propyl Acetone	4	1	4	4	4	4	4	1	4	4	4	4	4	4
Naphthalene	4	4	1	4	4	X	2	4	4	4	4	4	1	4
Naphthenic Acid	2	4	1	4	4	X	X	4	4	4	4	4	1	4
Naptha	2	4	1	4	4	2	2	4	4	4	4	4	2	4
Natural Gas	1	4	1	1	2	2	2	4	2	2	2	1	3	4
Neatsfoot Oil	1	2	1	4	4	1	1	2	4	4	4	4	1	2
Neon	1	1	1	1	1	1	1	1	1	1	1	1	1	1
Neville Acid	4	2	1	4	4	4	X	2	4	4	4	4	2	4
Nickel Acetate	2	1	4	2	4	4	4	1	4	1	1	4	4	4
Nickel Chloride	1	1	1	2	1	3	3	1	1	1	1	1	1	1
Nickel Salts	1	1	1	2	1	3	3	1	1	1	1	1	1	1
Nickel Sulfate	1	1	1	1	2	4	3	1	2	2	2	1	1	1
Niter Cake	1	1	1	1	1	4	1	1	1	1	1	1	1	1
Nitric Acid 3 Molar to 158°F	4	2	3	4	3	4	4	2	X	X	X	2	4	4

# Fluid Compatibility Chart

**COMPATIBILITY RATING:**  
 1 = Satisfactory  
 2 = Fair (Usually OK for Static Seal)  
 3 = Doubtful (Sometimes OK for Static Seal)  
 4 = Unsatisfactory  
 X = Insufficient Data

FLUID NAME	Nitrile	Ethylene Propylene	Fluorocarbon	Neoprene	SBR	Polyacrylate	Polyurethane	Butyl	Butadiene	Isoprene	Natural Rubber	Hypalon	Fluorosilicone	Silicone
Nitric Acid Concentrated Room Temp.	X	4	2	X	X	X	X	X	X	X	X	X	X	X
Nitric Acid Concentrated to 158°F	4	4	4	4	4	4	4	4	X	X	4	X	4	4
Nitrobenzene	4	1	2	4	4	4	4	1	4	4	4	4	4	4
Nitroethane	4	2	4	2	2	4	4	2	2	2	2	2	4	4
Nitrogen	1	1	1	1	1	1	1	1	1	1	1	1	1	1
Nitrogen Tetroxide (N2O4)	4	4	4	4	4	4	4	2	4	4	4	4	4	4
Nitromethane	4	2	4	3	3	4	4	2	2	2	2	2	4	4
Nitropropane	4	2	4	4	4	4	4	2	4	4	4	4	4	4
Nitrous Oxide	1	1	1	X	X	X	X	X	X	X	X	X	X	1
Noryl GE Phenolic	1	1	X	X	X	X	X	X	X	X	X	X	X	X
Nyvac FR200 Mobil	1	1	1	2	4	X	X	4	4	X	4	3	X	X
O-Chloronaphthalene	4	4	1	4	4	4	4	4	4	4	4	4	2	4
O-Chlorophenol	4	4	1	4	4	4	4	4	4	4	4	4	2	4
O-Dichlorobenzene	4	4	1	4	4	4	4	4	4	4	4	4	2	4
OS 45 Type III (OS45)	2	4	1	1	4	X	4	4	4	4	4	2	2	4
OS 45 Type IV (OS45-1)	2	4	1	1	4	X	4	4	4	4	4	2	2	4
OS 70	2	4	1	1	4	X	4	4	4	4	4	2	2	4
Octachloro Toluene	4	4	1	4	4	4	4	4	4	4	4	4	2	4
Octadecane	1	4	1	2	4	2	1	4	4	4	4	2	1	4
Octyl Alcohol	2	3	1	2	2	4	4	2	2	2	2	2	2	2
Oleic Acid	3	4	2	4	4	4	2	4	4	4	4	4	X	4
Oleum (Fuming Sulfuric Acid)	4	4	1	4	4	4	4	4	4	4	4	4	X	4
Oleum Spirits	2	4	1	3	4	X	3	4	4	4	4	2	2	4
Olive Oil	1	2	1	2	4	1	1	2	4	4	4	2	1	3
Oronite 8200	2	4	1	1	4	X	1	4	4	4	4	4	1	4
Oronite 8515	2	4	1	1	4	X	1	4	4	4	4	4	1	4
Ortho-Dichlorobenzene	4	4	1	4	4	4	4	4	4	4	4	4	2	4
Orthochloro Ethyl Benzene	4	4	1	4	4	4	4	4	4	4	4	4	2	4
Oxalic Acid	2	1	1	2	2	X	X	1	2	2	2	2	1	2
Oxygen, 200-400°F (Evaluate for specific applications)	4	4	2	4	4	4	4	4	4	4	4	4	4	1
Oxygen, Cold (Evaluate for specific applications)	2	1	1	1	2	2	1	1	2	2	2	1	1	1
Ozone	4	1	1	2	4	2	1	2	4	4	4	1	1	1
P-Cymene	4	4	1	4	4	4	4	4	4	4	4	4	2	4
P-Dichlorobenzene	4	4	1	4	4	4	4	4	4	4	4	4	2	4
P-Tertiary Butyl Catechol	4	2	1	2	2	4	4	2	2	4	4	2	1	X
PRL-High Temp. Hydr. Oil	2	4	1	2	4	1	2	4	4	4	4	4	1	2
Paint Thinner, Duco	4	4	2	4	4	4	4	4	4	4	4	4	2	4
Palmitic Acid	1	2	1	2	2	X	1	2	2	2	2	3	1	4
Par-al-Ketone	4	4	4	4	4	4	4	4	4	4	4	4	4	4
Para-dichlorobenzene	4	4	1	4	4	4	4	4	4	4	4	4	2	4
Parker O Lube	1	4	1	1	2	1	1	4	4	4	4	1	1	2
Peanut Oil	1	3	1	3	4	1	2	3	4	4	4	2	1	1
Pentane, 2 Methyl	1	4	1	2	4	1	4	4	4	4	4	2	3	4
Pentane, 2-4 dimethyl	1	4	1	2	4	1	4	4	4	4	4	2	3	4
Pentane, 3-Methyl	1	4	1	2	4	1	4	4	4	4	4	2	3	4
Perchloric Acid - 2N	4	2	1	2	4	4	4	2	4	4	4	2	1	4
Perchloroethylene	2	4	1	4	4	4	4	4	4	4	4	4	2	4
Petrolatum	1	4	1	2	4	1	1	4	4	4	4	2	1	4
Petroleum Oil, Above 250°F	4	4	2	4	4	4	4	4	4	4	4	4	4	4
Petroleum Oil, Below 250°F	1	4	1	2	4	2	2	4	4	4	4	2	2	2
Petroleum Oil, Crude	1	4	1	2	4	1	1	4	4	4	4	2	1	4
Phenol	4	4	1	4	4	4	4	4	4	4	4	4	2	4
Phenol, 70%/30% H2O	4	4	1	4	4	4	4	4	4	4	4	4	2	4
Phenol, 85%/15% H2O	4	4	1	4	4	4	4	4	4	4	4	4	2	4
Phenyl Ethyl Ether	4	4	4	4	4	4	4	4	4	4	4	4	4	4
Phenylbenzene	4	4	1	4	4	4	4	4	4	4	4	4	2	4
Phenylhydrazine	4	2	1	4	2	4	X	4	2	1	1	4	X	X
Phorone	4	3	4	4	4	4	4	3	4	4	4	4	4	4
Phosphoric Acid 3 Molar to 158°F	1	1	1	2	2	3	4	1	X	X	X	1	2	2
Phosphoric Acid Concentrated Room Temp	2	1	1	2	1	2	4	1	X	X	X	1	3	3
Phosphoric Acid Concentrated to 158°F	4	1	1	3	2	3	4	1	X	X	X	1	3	4
Phosphorous Trichloride	4	1	1	4	4	X	X	1	X	X	4	4	1	X



# Fluid Compatibility Chart

**COMPATIBILITY RATING:**  
 1 = Satisfactory  
 2 = Fair (Usually OK for Static Seal)  
 3 = Doubtful (Sometimes OK for Static Seal)  
 4 = Unsatisfactory  
 X = Insufficient Data

<b>MATERIAL</b>	Nitrile	Ethylene Propylene	Fluorocarbon	Neoprene	SBR	Polyacrylate	Polyurethane	Butyl	Butadiene	Isoprene	Natural Rubber	Hypalon	Fluorosilicone	Silicone
Pickling Solution	4	3	2	4	4	4	4	3	4	4	4	2	4	4
Picric Acid H <sub>2</sub> O Solution	1	1	1	1	2	X	X	1	2	2	1	1	2	X
Picric Acid Molten	2	2	1	2	2	X	X	2	2	2	2	2	2	4
Pine Oil	1	4	1	4	4	X	X	4	4	4	4	4	1	4
Pinene	2	4	1	3	4	4	2	4	4	4	4	4	1	4
Piperidine	4	4	4	4	4	4	4	4	4	4	4	4	4	4
Plating Solutions Chrome	4	2	1	4	4	4	4	2	4	4	4	4	2	2
Plating Solutions Others	1	1	1	4	4	X	X	1	X	X	4	1	X	4
Pneumatic Service	1	1	1	1	4	4	1	1	4	4	4	1	4	4
Polyvinyl Acetate Emulsion	X	1	X	2	4	X	X	1	X	X	2	2	X	X
Potassium Acetate	2	1	4	2	4	4	4	1	4	1	1	1	4	4
Potassium Chloride	1	1	1	1	1	1	1	1	1	1	1	1	1	1
Potassium Cupro Cyanide	1	1	1	1	1	1	1	1	1	1	1	1	1	1
Potassium Cyanide	1	1	1	1	1	1	1	1	1	1	1	1	1	1
Potassium Dichromate	1	1	1	1	1	1	2	1	1	1	1	1	1	1
Potassium Hydroxide 50%	2	1	4	2	2	4	4	1	2	2	2	1	3	3
Potassium Nitrate	1	1	1	1	1	1	1	1	1	1	1	1	1	1
Potassium Salts	1	1	1	1	1	1	1	1	1	1	1	1	1	1
Potassium Sulfite	1	1	1	1	2	4	1	1	1	2	2	2	1	1
Potassium Sulphate	1	1	1	1	2	4	1	1	1	2	2	2	1	1
Prestone Antifreeze	1	1	1	1	1	4	4	1	1	1	1	1	1	1
Producer Gas	1	4	1	2	4	2	1	4	4	4	4	2	2	2
Propane	1	4	1	2	4	1	3	4	4	4	4	2	2	4
Propyl Acetate	4	2	4	4	4	4	4	2	4	4	4	4	4	4
Propyl Alcohol	1	1	1	1	1	4	4	1	1	1	1	1	1	1
Propyl Nitrate	4	2	4	4	4	4	X	2	4	4	4	4	4	4
Propylene	3	4	1	4	4	4	4	4	4	4	4	4	3	4
Propylene Oxide	4	2	4	4	4	4	4	2	4	4	4	4	4	4
Pydraul, 10E	4	1	4	4	4	4	4	1	4	4	4	4	4	1
Pydraul, 115E	4	1	1	4	4	4	4	1	4	4	4	4	3	4
Pydraul, 230C, 312C, 540C, A200	4	4	1	4	4	4	4	4	4	4	4	4	4	4
Pydraul, 29ELT 30E, 50E, 65E	4	1	1	4	4	4	4	1	4	4	4	4	1	1
Pyranol Transformer Oil	1	4	1	2	4	1	2	4	4	4	4	2	1	4
Pyridine Oil	4	2	4	4	4	4	X	2	4	4	4	4	4	4
Pyrogard 53, Mobil Phosphate Ester	4	1	1	4	4	4	4	1	4	4	4	4	4	4
Pyrogard D, Mobil Water-in-Oil Emulsion	1	4	4	2	4	X	1	4	4	4	4	1	2	3
Pyroligneous Acid	4	2	4	2	4	4	4	2	4	4	4	2	4	X
Pyrolube	4	2	1	4	4	4	4	2	4	4	4	4	2	2
Pyrrrole	4	4	4	4	2	4	X	4	2	2	2	2	4	2
RJ-1 (MIL-F-25558)	1	4	1	2	4	1	1	4	4	4	4	2	1	4
RJ-4 (MIL-F-82522)	2	4	1	4	4	2	2	4	X	X	4	X	1	4
RP-1 (MIL-R-25576)	1	4	1	2	4	1	1	4	4	4	4	2	1	4
Radiation (GAMMA, 1.0 E+07 RADS)	3	2	4	X	X	X	4	4	X	X	4	X	4	2
Rapeseed Oil	2	1	1	2	4	2	2	1	4	4	4	2	1	4
Red Line 100 Oil	1	4	1	2	4	1	1	4	4	4	4	2	1	4
Red Oil (MIL-H-5606)	1	4	1	2	4	1	1	4	4	4	4	2	1	4
SF 1154 GE Silicone Fluid	2	1	1	1	1	1	2	1	X	1	1	1	1	4
SF1147 GE Silicone Fluid	2	3	1	X	X	X	X	3	X	X	X	X	X	4
SF96 GE Silicone Fluid	2	1	1	1	1	1	2	1	1	1	1	1	1	4
SR-10 Fuel	1	4	1	4	4	2	2	4	4	4	4	4	1	4
SR-6 Fuel	2	4	1	4	4	2	2	4	4	4	4	4	1	4
Sal Ammoniac	1	1	1	1	1	1	1	1	1	1	1	1	1	2
Salicylic Acid	2	1	1	X	2	X	X	1	2	1	1	X	1	X
Santo Safe 300	4	3	1	4	4	4	X	3	4	4	4	X	1	1
Sea (Salt) Water	1	1	1	2	1	4	2	1	1	1	1	1	1	1
Sewage	1	1	1	2	1	4	4	1	1	1	1	1	1	1
Shell 3XF Mine Fluid (Fire resist hydr.)	1	4	1	2	4	4	4	4	4	4	4	2	1	X
Shell Alvania Grease #2	1	4	1	2	4	1	1	4	4	4	4	4	1	2
Shell Carnea 19 and 29	1	4	1	4	4	1	2	4	4	4	4	4	1	X
Shell Diala	1	4	1	2	4	1	2	4	4	4	4	4	1	4
Shell Irus 905	1	4	1	2	4	1	1	4	4	4	4	4	1	4
Shell Lo Hydrax 27 and 29	1	4	1	2	4	1	2	4	4	4	4	4	1	4

# Fluid Compatibility Chart

**COMPATIBILITY RATING:**  
 1 = Satisfactory  
 2 = Fair (Usually OK for Static Seal)  
 3 = Doubtful (Sometimes OK for Static Seal)  
 4 = Unsatisfactory  
 X = Insufficient Data

FLUID NAME	Nitrile	Ethylene Propylene	Fluorocarbon	Neoprene	SBR	Polyacrylate	Polyurethane	Butyl	Butadiene	Isoprene	Natural Rubber	Hypalon	Fluorosilicone	Silicone
Shell Macome 72	1	4	1	2	4	1	2	4	4	4	4	4	1	4
Shell Tellus #32 Pet. Base	1	4	1	2	4	1	1	4	4	4	4	4	1	4
Shell Tellus #68	1	4	1	2	4	1	1	4	4	4	4	4	1	4
Shell UMF (5% Aromatic)	1	4	1	2	4	1	1	4	4	4	4	4	1	4
Silicate Esters	2	4	1	1	4	X	1	4	4	4	4	X	1	4
Silicone Greases	1	1	1	1	1	1	1	1	1	1	1	1	2	3
Silicone Oils	1	1	1	1	1	1	1	1	1	1	1	1	3	3
Silver Nitrate	2	1	1	1	1	1	1	1	1	1	1	1	1	1
Sinclair Opaline CX-EP Lube	1	4	1	2	4	1	1	4	4	4	4	2	1	4
Skelly, Solvent B, C, E	1	4	1	4	4	X	X	4	4	4	4	4	1	X
Skydrol 500 B4	4	1	4	4	4	4	4	2	4	4	4	4	3	3
Skydrol LD-4	4	1	4	4	4	4	4	2	4	4	4	4	3	3
Soap Solutions	1	1	1	2	2	4	4	1	1	1	2	1	1	1
Socony Mobile Type A	1	4	1	2	4	1	2	4	4	4	4	4	2	4
Socony Vacuum AMV AC781 (grease)	1	4	1	2	4	1	2	4	4	4	4	4	2	4
Socony Vacuum PD959B	1	4	1	2	4	1	1	4	4	4	4	2	1	4
Soda Ash	1	1	1	1	1	X	X	1	1	1	1	1	1	1
Sodium Acetate	2	1	4	2	4	3	3	1	4	1	1	1	4	4
Sodium Bicarbonate (Baking Soda)	1	1	1	1	1	X	X	1	1	1	1	1	1	1
Sodium Bisulfate or Bisulfite	1	1	1	1	2	4	X	1	2	2	1	1	1	1
Sodium Borate	1	1	1	1	1	X	X	1	1	1	1	1	1	1
Sodium Carbonate (Soda Ash)	1	1	1	1	1	X	X	1	1	1	1	1	1	1
Sodium Chloride	1	1	1	1	1	X	1	1	1	1	1	1	X	1
Sodium Cyanide	1	1	X	1	1	X	X	1	1	1	1	1	X	1
Sodium Hydroxide, 3 Molar	2	1	2	2	2	4	2	1	1	1	1	1	2	1
Sodium Hypochlorite	2	1	1	2	2	4	4	1	2	2	2	1	2	2
Sodium Metaphosphate	1	1	1	2	1	X	X	1	1	1	1	2	1	X
Sodium Nitrate	2	1	X	2	2	X	X	1	1	1	2	1	X	4
Sodium Perborate	2	1	1	2	2	X	X	1	2	2	2	2	1	2
Sodium Peroxide	2	1	1	2	2	4	4	1	2	2	2	2	1	4
Sodium Phosphate (Dibasic)	1	1	1	2	1	1	1	1	1	1	1	1	X	4
Sodium Phosphate (Mono)	1	1	1	2	1	1	1	1	1	1	1	1	X	4
Sodium Phosphate (Tribasic)	1	1	1	2	1	1	1	1	1	1	1	1	X	1
Sodium Salts	1	1	1	2	1	1	1	1	1	1	1	1	1	1
Sodium Silicate	1	1	1	1	1	X	X	1	1	1	1	1	X	X
Sodium Sulphate	1	1	1	1	2	4	1	1	2	2	2	1	1	1
Sodium Sulphide and Sulfite	1	1	1	1	2	4	1	1	2	2	2	1	1	1
Sodium Thiosulfate	2	1	1	1	2	4	1	1	2	2	2	1	1	1
Sour Crude Oil	3	4	1	4	4	4	4	4	4	4	4	X	4	4
Sour Natural Gas	3	4	1	4	4	4	4	4	4	4	4	X	4	4
Sovasol No. 1, 2, and 3	1	4	1	2	4	2	2	4	4	4	4	2	1	4
Sovasol No. 73 and 74	2	4	1	2	4	2	2	4	4	4	4	2	1	4
Soybean Oil	1	3	1	3	4	1	X	3	4	4	4	3	1	1
Spry	1	2	1	2	4	1	1	2	4	4	4	4	1	1
Standard Oil Mobilube GX90-EP Lube	1	4	1	2	4	1	1	4	4	4	4	2	1	4
Stannic Chloride	1	1	1	4	1	X	X	1	1	1	1	4	1	2
Stannic Chloride, 50%	1	1	1	4	1	X	X	1	1	1	1	4	1	2
Stannous Chloride (15%)	1	1	1	1	1	X	X	1	1	1	1	1	1	2
Stauffer 7700	2	4	1	4	4	2	X	4	4	4	4	4	2	4
Steam Below 400°F	4	1	4	4	4	4	4	2	4	4	4	4	4	3
Steam, 400°-500°F	4	3	4	4	4	4	4	4	4	4	4	4	4	4
Steam, Above 500°F														
Stearic Acid	2	2	X	2	2	X	X	2	2	2	2	2	X	2
Stoddard Solvent	1	4	1	2	4	1	1	4	4	4	4	4	1	4
Styrene (Monomer)	4	4	2	4	4	4	X	4	4	4	4	4	3	4
Sucrose Solutions	1	1	1	2	1	4	4	1	1	1	1	2	1	1
Sulfur	4	1	1	1	4	4	X	1	4	4	4	X	1	X
Sulfur Chloride	4	4	1	4	4	4	X	4	4	4	4	4	1	3
Sulfur Dioxide, Dry	4	1	4	4	2	4	X	2	2	2	2	4	2	2
Sulfur Dioxide, Liquidified under pressure	4	1	4	4	4	4	X	2	4	4	4	4	2	2
Sulfur Dioxide, Wet	4	1	4	2	4	4	X	1	4	4	4	3	2	2
Sulfur Liquors	2	2	1	2	2	4	X	2	2	2	2	2	2	4

# Fluid Compatibility Chart

**COMPATIBILITY RATING:**  
 1 = Satisfactory  
 2 = Fair (Usually OK for Static Seal)  
 3 = Doubtful (Sometimes OK for Static Seal)  
 4 = Unsatisfactory  
 X = Insufficient Data

FLUID NAME	MATERIAL													
	Nitrile	Ethylene Propylene	Fluorocarbon	Neoprene	SBR	Polyacrylate	Polyurethane	Butyl	Butadiene	Isoprene	Natural Rubber	Hypalon	Fluorosilicone	Silicone
Sulfur Molten	4	3	1	3	4	4	4	3	4	4	4	4	3	3
Sulfur Trioxide Dry	4	2	1	4	3	4	X	2	2	2	2	4	2	2
Sulfuric Acid, 3 Molar to 158°F	2	1	1	2	3	2	4	1	X	X	X	1	1	1
Sulfuric Acid, Concentrated Room Temp	X	3	1	X	X	X	3	X	X	X	X	X	X	X
Sulfuric Acid, Concentrated to 158°F	4	4	1	4	4	4	4	4	X	X	X	X	4	4
Sulfurous Acid	2	2	1	2	2	4	3	2	2	2	2	1	X	4
Sunoco #3661	1	4	1	2	4	1	1	4	4	4	4	2	1	4
Sunoco All purpose grease	1	4	1	2	4	1	1	4	4	4	4	2	1	4
Sunoco SAE 10	1	4	1	2	4	1	1	4	4	4	4	2	1	4
Sunsafe (Fire resist. hydr. fluid)	1	4	1	2	4	4	4	4	4	4	4	2	1	X
Super Shell Gas	1	4	1	2	4	2	2	4	4	4	4	4	2	4
Swan Finch EP Lube	1	4	1	4	4	1	1	4	4	4	4	4	1	4
Swan Finch Hypoid-90	1	4	1	2	4	1	1	4	4	4	4	4	1	4
Tannic Acid (10%)	1	1	1	2	4	X	1	1	1	1	1	1	1	2
Tar, bituminous	2	4	1	3	4	4	X	4	4	2	3	4	1	2
Tartaric Acid	1	2	1	2	4	X	1	2	2	1	3	1	1	1
Terpineol	2	3	1	4	4	X	2	3	4	4	4	4	1	X
Tertiary Butyl Alcohol	2	2	1	2	2	4	4	2	2	2	2	2	2	2
Tertiary Butyl Mercaptan	4	4	1	4	4	4	4	4	4	4	4	4	X	4
Tetrabromoethane	4	4	1	4	4	4	X	4	4	4	4	4	2	4
Tetrabutyl Titanate	2	1	1	2	2	X	X	2	2	2	2	4	4	4
Tetrachloroethylene	4	4	1	4	4	4	4	4	4	4	4	4	2	4
Tetrachoroethane	4	4	1	4	4	4	4	4	4	4	4	4	2	X
Tetraethyl Lead	2	4	1	2	4	X	X	4	4	4	4	4	2	X
Tetraethyl Lead Blend	2	4	1	4	4	X	X	4	4	4	4	4	2	X
Tetrahydrofuran	4	2	4	4	4	4	3	2	4	4	4	4	4	4
Tetralin	4	4	1	4	4	X	X	4	4	4	4	4	1	4
Texaco 3450 Gear Oil	1	4	1	4	4	1	1	4	4	4	4	4	1	4
Texaco Capella A and AA	1	4	1	2	4	1	2	4	4	4	4	4	1	4
Texaco Meropa 220 (No Lead)	1	4	1	2	4	1	2	4	4	4	4	4	1	4
Texaco Regal B	1	4	1	4	4	1	1	4	4	4	4	4	1	4
Texaco Uni-Temp Grease	1	4	1	2	4	1	1	4	4	4	4	4	1	2
Texamatic A 1581 Fluid	1	4	1	2	4	1	2	4	4	4	4	4	2	4
Texamatic A 3401 Fluid	1	4	1	2	4	1	2	4	4	4	4	4	2	4
Texamatic A 3525 Fluid	1	4	1	2	4	1	2	4	4	4	4	4	2	4
Texamatic A 3528 Fluid	1	4	1	2	4	1	2	4	4	4	4	4	2	4
Texamatic A Transmission Oil	1	4	1	2	4	1	2	4	4	4	4	4	2	4
Texas 1500 Oil	1	4	1	2	4	1	1	4	4	4	4	4	1	2
Therminol 44	4	4	1	4	X	4	X	4	X	X	X	X	X	4
Therminol 55	2	4	1	4	X	2	X	4	X	X	X	X	X	4
Therminol VP-1, 60, 65	4	4	1	4	X	4	X	4	X	X	X	X	X	2
Thiokol TP-90B	4	1	1	2	4	X	X	1	X	X	X	2	2	X
Thiokol TP-95	4	1	1	2	4	X	X	1	X	X	X	2	2	X
Tidewater Multigear, 140 EP Lube	1	4	1	2	4	1	1	4	4	4	4	2	1	4
Tidewater Oil-Beedol	1	4	1	2	4	1	1	4	4	4	4	4	1	2
Titanium Tetrachloride	2	4	1	4	4	4	4	4	4	4	4	4	2	4
Toluene	4	4	1	4	4	4	4	4	4	4	4	4	2	4
Toluene Diisocyanate	4	2	4	4	4	4	X	2	4	4	4	4	4	4
Transformer Oil	1	4	1	2	4	2	1	4	4	4	4	4	1	2
Transmission Fluid Type A	1	4	1	2	4	1	1	4	4	4	4	2	1	2
Triacetin	2	1	4	2	3	4	4	1	2	2	2	2	4	X
Triaryl Phosphate	4	1	1	4	4	4	4	1	4	4	4	4	2	3
Tributoxyethyl Phosphate	4	1	1	4	2	4	4	1	2	4	2	4	2	X
Tributyl Mercaptan	4	4	1	4	4	4	X	4	4	4	4	4	3	4
Tributyl Phosphate	4	1	4	4	4	4	4	2	4	2	2	4	4	4
Trichloroacetic Acid	2	2	3	4	2	4	4	2	2	2	2	4	4	X
Trichloroethane	4	4	1	4	4	4	4	4	4	4	4	4	2	4
Trichloroethylene	3	4	1	4	4	4	4	4	4	4	4	4	2	4
Tricresyl Phosphate	4	1	2	3	2	4	4	1	4	4	4	4	2	3
Triethanol Amine	3	2	4	2	2	4	4	2	2	2	2	2	4	X
Trifluoroethane	4	4	1	4	4	4	4	4	4	4	4	4	2	4
Trinitrololuene	4	4	2	2	4	4	X	4	4	4	4	2	2	X

# Fluid Compatibility Chart

**COMPATIBILITY RATING:**  
 1 = Satisfactory  
 2 = Fair (Usually OK for Static Seal)  
 3 = Doubtful (Sometimes OK for Static Seal)  
 4 = Unsatisfactory  
 X = Insufficient Data

FLUID NAME	Nitrile	Ethylene Propylene	Fluorocarbon	Neoprene	SBR	Polyacrylate	Polyurethane	Butyl	Butadiene	Isoprene	Natural Rubber	Hypalon	Fluorosilicone	Silicone
Trioctyl Phosphate	4	1	2	4	4	4	4	1	4	4	4	4	2	3
Tripoly Phosphate	4	1	2	3	4	4	4	1	4	4	4	4	1	3
Tung Oil (China Wood Oil)	1	4	1	2	4	X	3	3	4	4	4	3	2	4
Turbine Oil	1	4	1	4	4	1	1	4	4	4	4	4	1	4
Turbine Oil #15 (MIL-L-7808A)	2	4	1	4	4	2	4	4	4	4	4	4	2	4
Turbo Oil #35	1	4	1	2	4	1	1	4	4	4	4	4	1	4
Turpentine	1	4	1	4	4	2	4	4	4	4	4	4	2	4
Type I Fuel (MIL-S-3136)(ASTM Ref. Fuel A)	1	4	1	2	4	1	1	4	4	4	4	2	1	4
Type II Fuel MIL-S-3136	2	4	1	4	4	3	2	4	4	4	4	4	2	4
Type III Fuel MIL-S-3136 (ASTM Ref. Fuel B)	2	4	1	4	4	3	2	4	4	4	4	4	2	4
Ucon Hydrolube J-4	1	1	1	2	1	4	4	1	2	X	X	X	2	1
Ucon Lubricant 50-HB-100	1	1	1	1	1	X	X	1	1	1	1	1	1	1
Ucon Lubricant 50-HB-260	1	1	1	1	1	X	X	1	1	1	1	1	1	1
Ucon Lubricant 50-HB-5100	1	1	1	1	1	X	X	1	1	1	1	1	1	1
Ucon Lubricant 50-HB-660	1	1	1	1	1	X	X	1	1	1	1	1	1	1
Ucon Lubricant 50-HB55	1	1	1	1	1	X	X	1	1	1	1	1	1	1
Ucon Lubricant LB-1145	1	1	1	1	1	X	X	1	1	1	1	1	1	1
Ucon Lubricant LB-135	1	1	1	1	1	X	X	1	1	1	1	1	1	1
Ucon Lubricant LB-285	1	1	1	1	1	X	X	1	1	1	1	1	1	1
Ucon Lubricant LB-300X	1	1	1	1	1	X	X	1	1	1	1	1	1	1
Ucon Lubricant LB-625	1	1	1	1	1	X	X	1	1	1	1	1	1	1
Ucon Lubricant LB-65	1	1	1	1	2	X	X	1	2	2	2	2	1	1
Ucon Oil Heat Transfer Fluid 500(Polyalkalene Glycol)	1	1	1	1	1	X	X	1	1	1	1	1	1	1
Ucon Oil LB-385	1	1	1	1	1	X	X	1	1	1	1	1	1	1
Ucon Oil LB-400X	1	1	1	1	1	X	X	1	1	1	1	1	1	1
Univis 40 (Hydr. Fluid)	1	4	1	2	4	1	1	4	4	4	4	2	1	4
Univolt #35 (Mineral Oil)	1	4	1	2	4	1	1	4	4	4	4	4	1	4
Unsymmetrical Dimethyl Hydrazine (UDMH)	2	1	4	2	2	X	X	1	1	1	1	1	4	4
Uranium Hexachloride	X	X	1	X	X	X	X	X	X	X	X	X	X	X
VV-H-910	3	1	1	2	1	2	4	2	2	2	2	2	2	2
Varnish	2	4	1	4	4	4	3	4	4	4	4	4	2	4
Vegetable Oil	1	3	1	3	4	1	X	3	4	4	4	X	1	1
Versilube F-50	1	1	1	1	1	1	1	1	1	1	1	1	1	3
Vinegar	2	2	3	2	2	4	4	2	2	2	2	X	3	3
Vinyl Chloride	X	4	X	X	X	X	X	X	X	X	X	X	X	X
Wagner 21B Brake Fluid	3	1	4	2	1	X	X	2	X	X	2	2	4	3
Water	1	1	2	2	1	4	4	1	1	1	1	1	1	1
Wemco C	1	4	1	2	4	1	1	4	4	4	4	4	1	4
Whiskey and Wines	1	1	1	1	1	4	4	1	1	1	1	1	1	1
White Oil	1	4	1	2	4	1	1	4	4	4	4	4	1	4
White Pine Oil	2	4	1	4	4	X	X	4	4	4	4	4	1	4
Wolmar Salt	1	1	1	2	1	2	1	1	1	1	1	1	1	1
Wood Alcohol	1	1	4	1	1	4	4	1	1	1	1	1	1	1
Wood Oil	1	4	1	2	4	1	3	3	4	4	4	3	2	4
Xenon	1	1	1	1	1	1	1	1	1	1	1	1	1	1
Xylene	4	4	1	4	4	4	4	4	4	4	4	4	1	4
Xylidenes-Mixed-Aromatic Amines	3	4	4	4	4	4	4	4	4	4	4	4	4	4
Xylol	4	4	1	4	4	4	4	4	4	4	4	4	1	4
Zeolites	1	1	1	1	1	X	X	1	1	1	1	1	1	X
Zinc Acetate	2	1	4	2	4	4	4	1	4	1	1	4	4	4
Zinc Chloride	1	1	1	1	1	4	X	1	1	1	1	1	1	X
Zinc Salts	1	1	1	1	1	4	1	1	1	1	1	1	1	1
Zinc Sulfate	1	1	1	1	2	4	X	1	2	2	2	1	1	1

# Gland Design

<b>Static Axial Seal Gland Dimensions</b> .....	36 - 43
<b>Static Radial Seal Dimensions</b> .....	44 - 52
<b>Dynamic Radial Seal Gland Dimensions</b> .....	53 - 56
<b>Rotary O-Ring Seal Gland Dimensions</b> .....	57 - 60

# Static Axial Seal Gland Dimensions

**Table E**

This table contains gland dimensions for the application of standard size O-rings into Static Axial seal glands as shown in the diagram.

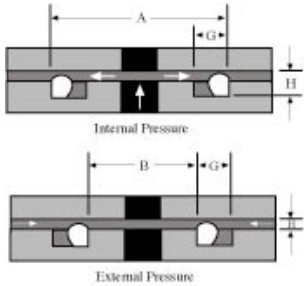

AS 568A Number	Internal Pressure Diameter A Inch	External Pressure Diameter B Inch	Groove Width G	Gland Depth H
<b>Tolerance</b>	<b>+.005/- .000</b>	<b>+.000/- .005</b>	<b>+.010/- .000</b>	<b>+.006/- .000</b>
-004	*	0.075	0.125	0.049
-005	*	0.106	0.125	0.049
-006	*	0.119	0.125	0.049
-007	*	0.150	0.125	0.049
-008	*	0.181	0.125	0.049
-009	*	0.213	0.125	0.049
-010	*	0.244	0.125	0.049
-011	0.436	0.306	0.125	0.049
-012	0.499	0.369	0.125	0.049
-013	0.561	0.431	0.125	0.049
-014	0.624	0.494	0.125	0.049
-015	0.686	0.556	0.125	0.049
-016	0.749	0.619	0.125	0.049
-017	0.811	0.681	0.125	0.049
-018	0.874	0.744	0.125	0.049
-019	0.936	0.806	0.125	0.049
-020	0.999	0.869	0.125	0.049
-021	1.061	0.931	0.125	0.049
-022	1.124	0.994	0.125	0.049
-023	1.186	1.056	0.125	0.049
-024	1.249	1.119	0.125	0.049
-025	1.311	1.181	0.125	0.049
-026	1.374	1.244	0.125	0.049
-027	1.436	1.306	0.125	0.049
-028	1.499	1.368	0.125	0.049
-029	1.624	1.494	0.125	0.049
-030	1.749	1.619	0.125	0.049
-031	1.874	1.744	0.125	0.049
-032	1.999	1.869	0.125	0.049
-033	2.124	1.994	0.125	0.049
-034	2.249	2.119	0.125	0.049
-035	2.374	2.244	0.125	0.049
-036	2.499	2.369	0.125	0.049
-037	2.624	2.494	0.125	0.049
-038	2.749	2.619	0.125	0.049
-039	2.874	2.744	0.125	0.049
-040	2.999	2.869	0.125	0.049
-041	3.124	2.994	0.125	0.049
-042	3.374	3.244	0.125	0.049
-043	3.624	3.494	0.125	0.049

## Static Axial Seal Gland Dimensions

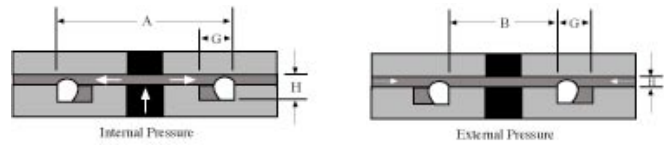
**Table E**

AS 568A Number	Internal Pressure Diameter A Inch	External Pressure Diameter B Inch	Groove Width G	Gland Depth H
<b>Tolerance</b>	<b>+0.005/-0.000</b>	<b>+0.000/-0.005</b>	<b>+0.010/-0.000</b>	<b>+0.006/-0.000</b>
-044	3.874	3.744	0.125	0.049
-045	4.124	3.994	0.125	0.049
-046	4.374	4.244	0.125	0.049
-047	4.624	4.494	0.125	0.049
-048	4.874	4.744	0.125	0.049
-049	5.124	4.994	0.125	0.049
-050	5.374	5.244	0.125	0.049
-102	*	0.054	0.170	0.075
-103	*	0.086	0.170	0.075
-104	*	0.117	0.170	0.075
-105	*	0.148	0.170	0.075
-106	*	0.179	0.170	0.075
-107	*	0.211	0.170	0.075
-108	*	0.242	0.170	0.075
-109	*	0.304	0.170	0.075
-110	0.563	0.367	0.170	0.075
-111	0.625	0.429	0.170	0.075
-112	0.688	0.492	0.170	0.075
-113	0.750	0.554	0.170	0.075
-114	0.813	0.617	0.170	0.075
-115	0.875	0.679	0.170	0.075
-116	0.938	0.742	0.170	0.075
-117	1.000	0.804	0.170	0.075
-118	1.063	0.867	0.170	0.075
-119	1.125	0.929	0.170	0.075
-120	1.188	0.992	0.170	0.075
-121	1.250	1.054	0.170	0.075
-122	1.313	1.117	0.170	0.075
-123	1.375	1.179	0.170	0.075
-124	1.438	1.242	0.170	0.075
-125	1.500	1.304	0.170	0.075
-126	1.563	1.367	0.170	0.075
-127	1.625	1.429	0.170	0.075
-128	1.688	1.492	0.170	0.075
-129	1.750	1.554	0.170	0.075
-130	1.183	1.617	0.170	0.075
-131	1.875	1.679	0.170	0.075
-132	1.938	1.742	0.170	0.075
-133	2.000	1.804	0.170	0.075
-134	2.063	1.867	0.170	0.075
-135	2.126	1.930	0.170	0.075
-136	2.188	1.992	0.170	0.075
-137	2.251	2.055	0.170	0.075
-138	2.313	2.117	0.170	0.075
-139	2.376	2.180	0.170	0.075

# Static Axial Seal Gland Dimensions

**Table E**

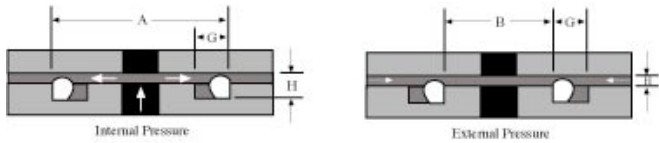

AS 568A Number	Internal Pressure Diameter A Inch	External Pressure Diameter B Inch	Groove Width G	Gland Depth H
<b>Tolerance</b>	<b>+0.005/-0.000</b>	<b>+0.000/-0.005</b>	<b>+0.010/-0.000</b>	<b>+0.006/-0.000</b>
-140	2.438	2.242	0.170	0.075
-141	2.501	2.305	0.170	0.075
-142	2.563	2.367	0.170	0.075
-143	2.626	2.430	0.170	0.075
-144	2.688	2.492	0.170	0.075
-145	2.751	2.555	0.170	0.075
-146	2.813	2.617	0.170	0.075
-147	2.876	2.680	0.170	0.075
-148	2.938	2.742	0.170	0.075
-149	3.001	2.805	0.170	0.075
-150	3.063	2.867	0.170	0.075
-151	3.188	2.992	0.170	0.075
-152	3.438	3.242	0.170	0.075
-153	3.688	3.492	0.170	0.075
-154	3.938	3.742	0.170	0.075
-155	4.188	3.992	0.170	0.075
-156	4.438	4.242	0.170	0.075
-157	4.688	4.492	0.170	0.075
-158	4.938	4.742	0.170	0.075
-159	5.188	4.992	0.170	0.075
-160	5.438	5.242	0.170	0.075
-161	5.688	5.492	0.170	0.075
-162	5.938	5.742	0.170	0.075
-163	6.188	5.992	0.170	0.075
-164	6.438	6.242	0.170	0.075
-165	6.688	6.492	0.170	0.075
-166	6.938	6.742	0.170	0.075
-167	7.188	6.992	0.170	0.075
-168	7.438	7.242	0.170	0.075
-169	7.688	7.492	0.170	0.075
-170	7.938	7.742	0.170	0.075
-171	8.188	7.992	0.170	0.075
-172	8.438	8.242	0.170	0.075
-173	8.688	8.492	0.170	0.075
-174	8.938	8.742	0.170	0.075
-175	9.188	8.992	0.170	0.075
-176	9.438	9.242	0.170	0.075
-177	9.688	9.492	0.170	0.075
-178	9.939	9.742	0.170	0.075
-201	*	0.176	0.210	0.107
-202	*	0.239	0.210	0.107
-203	*	0.301	0.210	0.107
-204	*	0.364	0.210	0.107
-205	0.694	0.426	0.210	0.107
-206	0.757	0.489	0.210	0.107

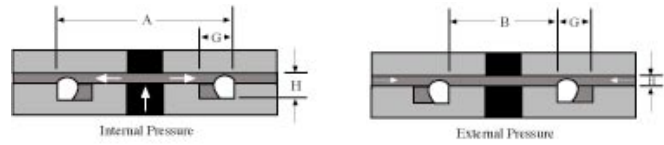

## Static Axial Seal Gland Dimensions

**Table E**

AS 568A Number	Internal Pressure Diameter A Inch	External Pressure Diameter B Inch	Groove Width G	Gland Depth H
<b>Tolerance</b>	<b>+0.005/-0.000</b>	<b>+0.000/-0.005</b>	<b>+0.010/-0.000</b>	<b>+0.006/-0.000</b>
-207	0.819	0.551	0.210	0.107
-208	0.882	0.614	0.210	0.107
-209	0.944	0.676	0.210	0.107
-210	1.007	0.739	0.210	0.107
-211	1.069	0.801	0.210	0.107
-212	1.132	0.864	0.210	0.107
-213	1.194	0.926	0.210	0.107
-214	1.257	0.989	0.210	0.107
-215	1.319	1.051	0.210	0.107
-216	1.382	1.114	0.210	0.107
-217	1.444	1.176	0.210	0.107
-218	1.507	1.239	0.210	0.107
-219	1.569	1.301	0.210	0.107
-220	1.632	1.364	0.210	0.107
-221	1.694	1.426	0.210	0.107
-222	1.757	1.489	0.210	0.107
-223	1.882	1.614	0.210	0.107
-224	2.007	1.739	0.210	0.107
-225	2.132	1.864	0.210	0.107
-226	2.257	1.989	0.210	0.107
-227	2.382	2.114	0.210	0.107
-228	2.507	2.239	0.210	0.107
-229	2.632	2.364	0.210	0.107
-230	2.757	2.489	0.210	0.107
-231	2.882	2.614	0.210	0.107
-232	3.007	2.739	0.210	0.107
-233	3.132	2.864	0.210	0.107
-234	3.257	2.989	0.210	0.107
-235	3.382	3.114	0.210	0.107
-236	3.507	3.239	0.210	0.107
-237	3.632	3.364	0.210	0.107
-238	3.757	3.489	0.210	0.107
-239	3.882	3.614	0.210	0.107
-240	4.007	3.739	0.210	0.107
-241	4.132	3.864	0.210	0.107
-242	4.257	3.989	0.210	0.107
-243	4.382	4.114	0.210	0.107
-244	4.507	4.239	0.210	0.107
-245	4.632	4.364	0.210	0.107
-246	4.757	4.489	0.210	0.107
-247	4.882	4.614	0.210	0.107
-248	5.007	4.739	0.210	0.107
-249	5.132	4.864	0.210	0.107
-250	5.257	4.989	0.210	0.107
-251	5.382	5.114	0.210	0.107

# Static Axial Seal Gland Dimensions

**Table E**

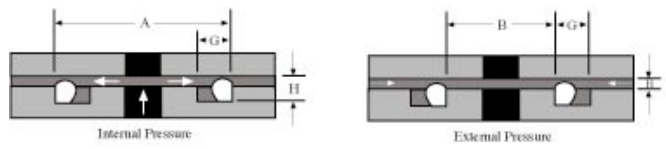

AS 568A Number	Internal Pressure Diameter A Inch	External Pressure Diameter B Inch	Groove Width G	Gland Depth H
<b>Tolerance</b>	<b>+0.005/-0.000</b>	<b>+0.000/-0.005</b>	<b>+0.010/-0.000</b>	<b>+0.006/-0.000</b>
-252	5.507	5.239	0.210	0.107
-253	5.632	5.359	0.210	0.107
-254	5.757	5.489	0.210	0.107
-255	5.882	5.614	0.210	0.107
-256	6.007	5.739	0.210	0.107
-257	6.132	5.864	0.210	0.107
-258	6.257	5.989	0.210	0.107
-259	6.507	6.239	0.210	0.107
-260	6.757	6.489	0.210	0.107
-261	7.007	6.739	0.210	0.107
-262	7.257	6.989	0.210	0.107
-263	7.507	7.239	0.210	0.107
-264	7.757	7.489	0.210	0.107
-265	8.007	7.739	0.210	0.107
-266	8.257	7.989	0.210	0.107
-267	8.507	8.239	0.210	0.107
-268	8.757	8.489	0.210	0.107
-269	9.007	8.739	0.210	0.107
-270	9.257	8.989	0.210	0.107
-271	9.507	9.239	0.210	0.107
-272	9.757	9.489	0.210	0.107
-273	10.007	9.739	0.210	0.107
-274	10.257	9.989	0.210	0.107
-275	10.757	10.489	0.210	0.107
-276	11.257	10.989	0.210	0.107
-277	11.757	11.489	0.210	0.107
-278	12.257	11.989	0.210	0.107
-279	13.257	12.989	0.210	0.107
-280	14.257	13.989	0.210	0.107
-281	15.257	14.989	0.210	0.107
-282	16.228	15.960	0.210	0.107
-283	17.228	16.960	0.210	0.107
-284	18.228	17.960	0.210	0.107
-309	*	0.417	0.300	0.169
-310	0.890	0.480	0.300	0.169
-311	0.952	0.542	0.300	0.169
-312	1.015	0.605	0.300	0.169
-313	1.077	0.667	0.300	0.169
-314	1.140	0.730	0.300	0.169
-315	1.202	0.792	0.300	0.169
-316	1.265	0.855	0.300	0.169
-317	1.327	0.917	0.300	0.169
-318	1.390	0.980	0.300	0.169
-319	1.452	1.042	0.300	0.169
-320	1.515	1.105	0.300	0.169

## Static Axial Seal Gland Dimensions

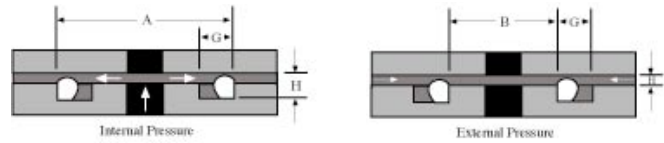
**Table E**

AS 568A Number	Internal Pressure Diameter A Inch	External Pressure Diameter B Inch	Groove Width G	Gland Depth H
<b>Tolerance</b>	<b>+0.005/-0.000</b>	<b>+0.000/-0.005</b>	<b>+0.010/-0.000</b>	<b>+0.006/-0.000</b>
-321	1.577	1.167	0.300	0.169
-322	1.640	1.230	0.300	0.169
-323	1.702	1.292	0.300	0.169
-324	1.765	1.355	0.300	0.169
-325	1.890	1.480	0.300	0.169
-326	2.015	1.605	0.300	0.169
-327	2.140	1.730	0.300	0.169
-328	2.265	1.855	0.300	0.169
-329	2.390	1.980	0.300	0.169
-330	2.515	2.105	0.300	0.169
-331	2.640	2.230	0.300	0.169
-332	2.765	2.355	0.300	0.169
-333	2.890	2.480	0.300	0.169
-334	3.015	2.605	0.300	0.169
-335	3.140	2.730	0.300	0.169
-336	3.265	2.855	0.300	0.169
-337	3.390	2.980	0.300	0.169
-338	3.515	3.105	0.300	0.169
-339	3.640	3.230	0.300	0.169
-340	3.765	3.355	0.300	0.169
-341	3.890	3.480	0.300	0.169
-342	4.015	3.605	0.300	0.169
-343	4.140	3.730	0.300	0.169
-344	4.265	3.855	0.300	0.169
-345	4.390	3.980	0.300	0.169
-346	4.515	4.105	0.300	0.169
-347	4.640	4.230	0.300	0.169
-348	4.765	4.355	0.300	0.169
-349	4.890	4.480	0.300	0.169
-350	5.015	4.605	0.300	0.169
-351	5.140	4.730	0.300	0.169
-352	5.265	4.855	0.300	0.169
-353	5.390	4.980	0.300	0.169
-354	5.515	5.105	0.300	0.169
-355	5.640	5.230	0.300	0.169
-356	5.765	5.355	0.300	0.169
-357	5.890	5.480	0.300	0.169
-358	6.015	5.605	0.300	0.169
-359	6.140	5.730	0.300	0.169
-360	6.265	5.855	0.300	0.169
-361	6.390	5.980	0.300	0.169
-362	6.640	6.230	0.300	0.169
-363	6.890	6.480	0.300	0.169
-364	7.140	6.730	0.300	0.169
-365	7.390	6.980	0.300	0.169

# Static Axial Seal Gland Dimensions

**Table E**

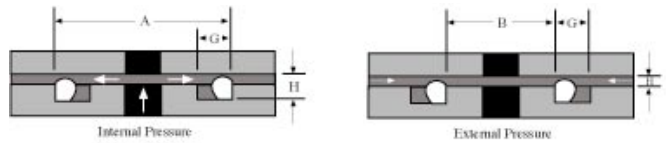

AS 568A Number	Internal Pressure Diameter A Inch	External Pressure Diameter B Inch	Groove Width G	Gland Depth H
<b>Tolerance</b>	<b>+0.005/-0.000</b>	<b>+0.000/-0.005</b>	<b>+0.010/-0.000</b>	<b>+0.006/-0.000</b>
-366	7.640	7.230	0.300	0.169
-367	7.890	7.480	0.300	0.169
-368	8.140	7.730	0.300	0.169
-369	8.390	7.980	0.300	0.169
-370	8.640	8.230	0.300	0.169
-371	8.890	8.480	0.300	0.169
-372	9.140	8.730	0.300	0.169
-373	9.390	8.980	0.300	0.169
-374	9.640	9.230	0.300	0.169
-375	9.890	9.480	0.300	0.169
-376	10.140	9.730	0.300	0.169
-377	10.390	9.980	0.300	0.169
-378	10.980	10.480	0.300	0.169
-379	11.390	10.980	0.300	0.169
-380	11.890	11.480	0.300	0.169
-381	12.390	11.980	0.300	0.169
-382	13.390	12.980	0.300	0.169
-383	14.390	13.980	0.300	0.169
-384	15.390	14.980	0.300	0.169
-385	16.370	15.960	0.300	0.169
-386	17.370	16.960	0.300	0.169
-387	18.370	17.960	0.300	0.169
-388	19.370	18.960	0.300	0.169
-389	20.370	19.960	0.300	0.169
-390	21.370	20.960	0.300	0.169
-391	22.370	21.960	0.300	0.169
-392	23.355	22.945	0.300	0.169
-393	24.355	23.945	0.300	0.169
-394	25.355	24.945	0.300	0.169
-395	26.355	25.945	0.300	0.169
-425	5.020	4.480	0.355	0.231
-426	5.145	4.605	0.355	0.231
-427	5.270	4.730	0.355	0.231
-428	5.395	4.855	0.355	0.231
-429	5.520	4.980	0.355	0.231
-430	5.645	5.105	0.355	0.231
-431	5.770	5.230	0.355	0.231
-432	5.895	5.355	0.355	0.231
-433	6.020	5.480	0.355	0.231
-434	6.145	5.605	0.355	0.231
-435	6.270	5.730	0.355	0.231
-436	6.395	5.855	0.355	0.231
-437	6.520	5.980	0.355	0.231
-438	6.770	6.230	0.355	0.231
-439	7.020	6.480	0.355	0.231

## Static Axial Seal Gland Dimensions

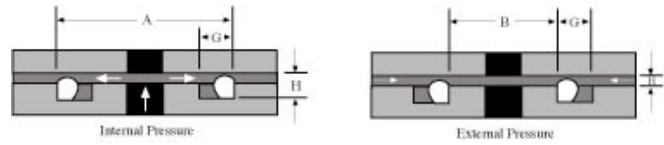
**Table E**

AS 568A Number	Internal Pressure Diameter A Inch	External Pressure Diameter B Inch	Groove Width G	Gland Depth H
<b>Tolerance</b>	<b>+0.005/-0.000</b>	<b>+0.000/-0.005</b>	<b>+0.010/-0.000</b>	<b>+0.006/-0.000</b>
-440	7.270	6.730	0.355	0.231
-441	7.520	6.980	0.355	0.231
-442	7.770	7.230	0.355	0.231
-443	8.020	7.480	0.355	0.231
-444	8.270	7.730	0.355	0.231
-445	8.520	7.980	0.355	0.231
-446	9.020	8.480	0.355	0.231
-447	9.520	8.980	0.355	0.231
-448	10.202	9.480	0.355	0.231
-449	10.520	9.980	0.355	0.231
-450	11.020	10.480	0.355	0.231
-451	11.520	10.980	0.355	0.231
-452	12.020	11.480	0.355	0.231
-453	12.520	11.980	0.355	0.231
-454	13.020	12.480	0.355	0.231
-455	13.520	12.980	0.355	0.231
-456	14.020	13.480	0.355	0.231
-457	14.520	13.980	0.355	0.231
-458	15.020	14.480	0.355	0.231
-459	15.520	14.980	0.355	0.231
-460	16.020	15.480	0.355	0.231
-461	16.500	15.960	0.355	0.231
-462	17.000	16.460	0.355	0.231
-463	17.500	16.960	0.355	0.231
-464	18.000	17.460	0.355	0.231
-465	18.500	17.960	0.355	0.231
-466	19.000	18.460	0.355	0.231
-467	19.500	18.960	0.355	0.231
-468	20.000	19.460	0.355	0.231
-469	20.500	19.960	0.355	0.231
-470	21.500	20.960	0.355	0.231
-471	22.500	21.960	0.355	0.231
-472	23.485	22.945	0.355	0.231
-473	24.485	23.945	0.355	0.231
-474	25.485	24.945	0.355	0.231
-475	26.485	25.945	0.355	0.231

\*\* O-Ring seal sizes not listed are not recommended for axial seals because the seal ID after installation becomes too small for practical use.

## Static Radial Seal Dimensions

**Table F**

This table contains gland dimensions for the application of standard size O-rings into Static Radial seal glands as shown in the diagram.

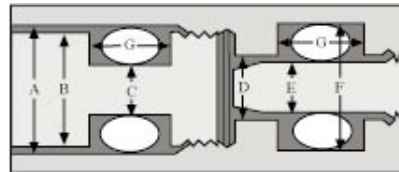

AS 568A Number	A Bore Diameter	B Piston Diameter	C Piston Groove Diameter	D Bore Diameter	E Rod Diameter	F Gland Diameter	G Gland Width
<b>Tolerance</b>	<b>+0.002/-0.000</b>	<b>+0.000/-0.001</b>	<b>+0.000/-0.001</b>	<b>+0.002/-0.000</b>	<b>+0.000/-0.001</b>	<b>+0.001/-0.000</b>	<b>+0.010/-0.000</b>
-001	0.082	0.081	0.035	0.036	0.035	0.083	0.101
-002	0.115	0.114	0.048	0.049	0.048	0.116	0.101
-003	0.148	0.147	0.062	0.063	0.062	0.149	0.101
-004	0.181	0.180	0.077	0.078	0.077	0.182	0.105
-005	0.215	0.214	0.109	0.110	0.109	0.216	0.105
-006	0.229	0.228	0.122	0.123	0.122	0.230	0.105
-007	0.262	0.261	0.154	0.155	0.154	0.263	0.105
-008	0.295	0.294	0.186	0.187	0.186	0.296	0.105
-009	0.326	0.325	0.218	0.219	0.218	0.327	0.105
-010	0.359	0.358	0.250	0.251	0.250	0.360	0.105
-011	0.421	0.420	0.313	0.314	0.313	0.422	0.105
-012	0.486	0.485	0.377	0.378	0.377	0.487	0.105
-013	0.550	0.549	0.441	0.442	0.442	0.551	0.105
-014	0.614	0.613	0.505	0.506	0.505	0.615	0.105
<b>Tolerance</b>	<b>+0.002/-0.000</b>	<b>+0.000/-0.002</b>	<b>+0.000/-0.003</b>	<b>+0.002/-0.000</b>	<b>+0.000/-0.002</b>	<b>+0.003/-0.000</b>	<b>+0.010/-0.000</b>
-015	0.680	0.679	0.572	0.572	0.571	0.679	0.105
-016	0.746	0.745	0.638	0.638	0.637	0.745	0.105
-017	0.810	0.809	0.702	0.702	0.701	0.809	0.105
-018	0.874	0.873	0.766	0.766	0.765	0.873	0.105
-019	0.937	0.936	0.829	0.829	0.828	0.936	0.105
-020	1.000	0.999	0.893	0.893	0.892	0.999	0.105
-021	1.064	1.063	0.957	0.957	0.956	1.063	0.105
-022	1.129	1.128	1.022	1.022	1.021	1.128	0.105
-023	1.192	1.191	1.085	1.085	1.084	1.191	0.105
-024	1.257	1.256	1.149	1.149	1.148	1.256	0.105
-025	1.321	1.320	1.214	1.214	1.213	1.320	0.105
-026	1.386	1.385	1.278	1.278	1.277	1.385	0.105
-027	1.449	1.448	1.341	1.341	1.340	1.448	0.105
-028	1.515	1.514	1.408	1.408	1.407	1.514	0.105
-029	1.643	1.642	1.535	1.535	1.534	1.642	0.105
-030	1.711	1.770	1.663	1.663	1.662	1.770	0.105
-031	1.900	1.899	1.792	1.791	1.792	1.899	0.105
-032	2.028	2.027	1.920	1.920	1.919	2.027	0.105
-033	2.158	2.157	2.050	**	**	**	0.105
-034	2.286	2.285	2.178	**	**	**	0.105
-035	2.413	2.412	2.305	**	**	**	0.105
-036	2.541	2.540	2.433	**	**	**	0.105
-037	2.668	2.667	2.560	**	**	**	0.105
-038	2.798	2.797	2.690	**	**	**	0.105
-039	2.925	2.924	2.817	**	**	**	0.105

## Static Radial Seal Dimensions

Table F

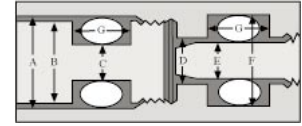

AS 568A Number	A Bore Diameter	B Piston Diameter	C Piston Groove Diameter	D Bore Diameter	E Rod Diameter	F Gland Diameter	G Gland Width
<b>Tolerance</b>	<b>+0.02/-0.00</b>	<b>+0.00/-0.02</b>	<b>+0.00/-0.03</b>	<b>+0.02/-0.00</b>	<b>+0.00/-0.02</b>	<b>+0.03/-0.00</b>	<b>+0.010/-0.00</b>
-040	3.053	3.052	2.945	**	**	**	0.105
-041	3.184	3.183	3.076	**	**	**	0.105
-042	3.439	3.438	3.331	**	**	**	0.105
-043	3.694	3.693	3.586	**	**	**	0.105
-044	3.952	3.951	3.844	**	**	**	0.105
-045	4.207	4.206	4.099	**	**	**	0.105
-046	4.465	4.464	4.357	**	**	**	0.105
-047	4.720	4.719	4.612	**	**	**	0.105
-048	4.975	4.974	4.867	**	**	**	0.105
-049	5.238	5.237	5.130	**	**	**	0.105
-050	5.493	5.492	5.385	**	**	**	0.105
<b>Tolerance</b>	<b>+0.003/-0.000</b>	<b>+0.000/-0.002</b>	<b>+0.000/-0.004</b>	<b>+0.003/-0.000</b>	<b>+0.000/-0.002</b>	<b>+0.003/-0.000</b>	<b>+0.010/-0.000</b>
-102	0.213	0.212	0.059	0.058	0.057	0.212	0.182
-103	0.251	0.250	0.092	0.091	0.090	0.250	0.165
-104	0.285	0.284	0.123	0.122	0.121	0.284	0.158
-105	3.180	0.317	0.155	0.154	0.153	0.317	0.158
-106	0.350	0.349	0.187	0.186	0.185	0.349	0.153
-107	0.382	0.381	0.219	0.218	0.217	0.381	0.153
-108	0.415	0.414	0.251	0.250	0.249	0.414	0.153
-109	0.478	0.477	0.314	0.313	0.312	0.477	0.146
-110	0.541	0.540	0.378	0.377	0.376	0.540	0.146
-111	0.606	0.605	0.442	0.441	0.440	0.605	0.146
-112	0.669	0.668	0.506	0.505	0.504	0.668	0.146
-113	0.734	0.733	0.571	0.570	0.569	0.733	0.146
-114	0.800	0.799	0.637	0.636	0.635	0.799	0.146
-115	0.864	0.863	0.701	0.700	0.699	0.863	0.146
-116	0.929	0.928	0.765	0.764	0.763	0.928	0.146
-117	0.993	0.992	0.829	0.828	0.827	0.992	0.146
-118	1.056	1.055	0.893	0.892	0.891	1.055	0.146
-119	1.120	1.119	0.957	0.958	0.955	1.119	0.146
-120	1.184	1.183	1.021	1.020	1.019	1.183	0.146
-121	1.247	1.246	1.084	1.083	1.082	1.246	0.146
-122	1.311	1.310	1.148	1.147	1.146	1.310	0.146
-123	1.377	1.376	1.214	1.213	1.212	1.376	0.146
-124	1.441	1.440	1.278	1.277	1.276	1.440	0.146
-125	1.504	1.503	1.341	1.340	1.339	1.503	0.146
-126	1.568	1.567	1.405	1.404	1.403	1.567	0.146
-127	1.633	1.632	1.469	1.468	1.467	1.632	0.146
-128	1.696	1.695	1.533	1.532	1.531	1.695	0.146
-129	1.762	1.761	1.599	1.598	1.597	1.761	0.146
-130	1.827	1.826	1.664	1.663	1.662	1.826	0.146
-131	1.890	1.889	1.727	1.726	1.725	1.889	0.146
-132	1.954	1.953	1.791	1.790	1.789	1.953	0.146

# Static Radial Seal Dimensions

**Table F**

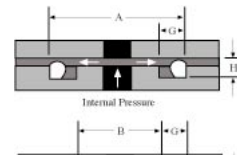

AS 568A Number	A Bore Diameter	B Piston Diameter	C Piston Groove Diameter	D Bore Diameter	E Rod Diameter	F Gland Diameter	G Gland Width
<b>Tolerance</b>	<b>+0.003/-0.000</b>	<b>+0.000/-0.002</b>	<b>+0.000/-0.004</b>	<b>+0.003/-0.000</b>	<b>+0.000/-0.002</b>	<b>+0.003/-0.000</b>	<b>+0.010/-0.000</b>
-133	2.018	2.017	1.854	1.853	1.852	2.017	0.146
-134	2.083	2.082	1.919	1.918	1.917	2.082	0.146
-135	2.148	2.147	1.985	1.984	1.983	2.147	0.146
-136	2.211	2.210	2.048	2.047	2.046	2.210	0.146
-137	2.276	2.275	2.112	2.111	2.110	2.275	0.146
-138	2.340	2.339	2.176	2.175	2.174	2.339	0.146
-139	2.403	2.402	2.240	2.239	2.238	2.402	0.146
-140	2.466	2.465	2.303	2.302	2.301	2.465	0.146
-141	2.533	2.532	2.370	2.369	2.368	2.532	0.146
-142	2.597	2.596	2.434	2.433	2.432	2.596	0.146
-143	2.662	2.661	2.498	2.497	2.496	2.661	0.146
-144	2.724	2.723	2.561	2.560	2.559	2.723	0.146
-145	2.788	2.787	2.625	2.624	2.623	2.787	0.146
-146	2.852	2.851	2.689	2.688	2.687	2.851	0.146
-147	2.919	2.918	2.755	2.754	2.753	2.918	0.146
-148	2.981	2.980	2.818	2.817	2.816	2.980	0.146
-149	3.045	3.044	2.882	2.881	2.880	3.044	0.146
-150	3.109	3.108	2.946	2.945	2.944	3.108	0.146
-151	3.238	3.237	3.075	3.074	3.073	3.237	0.146
-152	3.493	3.492	3.330	**	**	**	0.146
-153	3.748	3.747	3.585	**	**	**	0.146
-154	4.007	4.006	3.844	**	**	**	0.146
-155	4.262	4.261	4.099	**	**	**	0.146
-156	4.519	4.518	4.356	**	**	**	0.146
-157	4.774	4.773	4.611	**	**	**	0.146
-158	5.029	5.028	4.866	**	**	**	0.146
-159	5.289	5.288	5.126	**	**	**	0.146
-160	5.544	5.543	5.381	**	**	**	0.146
-161	5.799	5.798	5.636	**	**	**	0.146
-162	6.054	6.053	5.891	**	**	**	0.146
-163	6.309	6.308	6.146	**	**	**	0.146
-164	6.570	6.569	6.407	**	**	**	0.146
-165	6.825	6.824	6.662	**	**	**	0.146
-166	7.080	7.079	6.917	**	**	**	0.146
-167	7.335	7.334	7.172	**	**	**	0.146
-168	7.596	7.594	7.432	**	**	**	0.146
-169	7.850	7.849	7.687	**	**	**	0.146
-170	8.105	8.104	7.942	**	**	**	0.146
-171	8.360	8.359	8.197	**	**	**	0.146
-172	8.620	8.619	8.457	**	**	**	0.146
-173	8.875	8.874	8.712	**	**	**	0.146
<b>Tolerance</b>	<b>+0.003/-0.000</b>	<b>+0.000/-0.002</b>	<b>+0.000/-0.004</b>	<b>+0.003/-0.000</b>	<b>+0.000/-0.003</b>	<b>+0.006/-0.000</b>	<b>+0.010/-0.000</b>
-174	9.130	9.129	8.967	**	**	**	0.146



## Static Radial Seal Dimensions

**Table F**

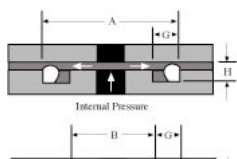

AS 568A Number	A Bore Diameter	B Piston Diameter	C Piston Groove Diameter	D Bore Diameter	E Rod Diameter	F Gland Diameter	G Gland Width
<b>Tolerance</b>	<b>+0.003/-0.000</b>	<b>+0.000/-0.002</b>	<b>+0.000/-0.004</b>	<b>+0.003/-0.000</b>	<b>+0.000/-0.003</b>	<b>+0.006/-0.000</b>	<b>+0.010/-0.000</b>
-175	9.385	9.384	9.222	**	**	**	0.146
-176	9.645	9.644	9.482	**	**	**	0.146
-177	9.900	9.899	9.737	**	**	**	0.146
-178	10.155	10.154	9.992	**	**	**	0.146
<b>Tolerance</b>	<b>+0.003/-0.000</b>	<b>+0.000/-0.003</b>	<b>+0.000/-0.006</b>	<b>+0.003/-0.000</b>	<b>+0.000/-0.003</b>	<b>+0.006/-0.000</b>	<b>+0.010/-0.000</b>
-201	0.408	0.406	0.186	0.185	0.183	0.405	0.205
-202	0.472	0.470	0.250	0.249	0.247	0.469	0.205
-203	0.534	0.532	0.313	0.312	0.310	0.531	0.205
-204	0.599	0.597	0.377	0.376	0.374	0.596	0.195
-205	0.663	0.661	0.441	0.440	0.438	0.660	0.195
-206	0.726	0.724	0.505	0.504	0.502	0.723	0.195
-207	0.792	0.790	0.570	0.569	0.567	0.789	0.195
-208	0.858	0.856	0.636	0.635	0.633	0.855	0.195
-209	0.921	0.919	0.700	0.699	0.697	0.918	0.195
-210	0.986	0.984	0.765	0.764	0.762	0.983	0.195
-211	1.050	1.048	0.828	0.827	0.825	1.047	0.195
-212	1.114	1.112	0.892	0.891	0.889	1.111	0.195
-213	1.177	1.175	0.956	0.955	0.953	1.174	0.195
-214	1.242	1.240	1.020	1.019	1.017	1.239	0.195
-215	1.305	1.303	1.083	1.082	1.080	1.302	0.195
-216	1.370	1.368	1.149	1.148	1.146	1.367	0.195
-217	1.435	1.433	1.213	1.212	1.210	1.432	0.195
-218	1.499	1.497	1.277	1.276	1.274	1.496	0.195
-219	1.562	1.560	1.340	1.339	1.337	1.559	0.195
-220	1.626	1.624	1.404	1.403	1.401	1.623	0.195
-221	1.690	1.688	1.468	1.467	1.465	1.687	0.195
-222	1.757	1.755	1.535	1.534	1.532	1.754	0.195
-223	1.884	1.882	1.662	1.661	1.659	1.881	0.195
-224	2.012	2.010	1.790	1.789	1.787	2.009	0.195
-225	2.143	2.141	1.921	1.920	1.918	2.140	0.195
-226	2.270	2.268	2.048	2.047	2.045	2.267	0.195
-227	2.398	2.396	2.176	2.175	2.173	2.395	0.195
-228	2.527	2.525	2.305	2.304	2.302	2.524	0.195
-229	2.655	2.653	2.433	2.432	2.430	2.652	0.195
-230	2.781	2.779	2.560	2.559	2.557	2.778	0.195
-231	2.909	2.907	2.688	2.687	2.685	2.906	0.195
-232	3.041	3.039	2.819	2.818	2.816	3.038	0.195
-233	3.169	3.167	2.947	2.946	2.944	3.166	0.195
-234	3.296	3.293	3.074	3.073	3.071	3.292	0.195
-235	3.423	3.421	3.202	3.201	3.199	3.420	0.195
-236	3.551	3.549	3.329	3.328	3.326	3.548	0.195
-237	3.679	3.677	3.457	3.456	3.454	3.678	0.195
-238	3.806	3.804	3.584	3.583	3.581	3.803	0.195
-239	3.937	3.935	3.716	3.715	3.713	3.934	0.195

# Static Radial Seal Dimensions

**Table F**

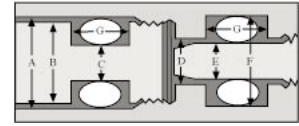

AS 568A Number	A Bore Diameter	B Piston Diameter	C Piston Groove Diameter	D Bore Diameter	E Rod Diameter	F Gland Diameter	G Gland Width
<b>Tolerance</b>	<b>+0.003/-0.000</b>	<b>+0.000/-0.003</b>	<b>+0.000/-0.006</b>	<b>+0.003/-0.000</b>	<b>+0.000/-0.003</b>	<b>+0.006/-0.000</b>	<b>+0.010/-0.000</b>
-240	4.065	4.063	3.843	3.842	3.840	4.062	0.195
-241	4.193	4.191	3.971	3.970	3.968	4.190	0.195
-242	4.320	4.318	4.098	4.097	4.095	4.317	0.195
-243	4.448	4.446	4.226	4.225	4.223	4.445	0.195
-244	4.577	4.575	4.355	4.354	4.352	4.574	0.195
-245	4.705	4.703	4.483	**	**	**	0.195
-246	4.832	4.830	4.610	**	**	**	0.195
-247	4.960	4.958	4.738	**	**	**	0.195
-248	5.087	5.085	4.865	**	**	**	0.195
-249	5.220	5.218	4.998	**	**	**	0.195
-250	5.347	5.345	5.125	**	**	**	0.195
-251	5.475	5.473	5.253	**	**	**	0.195
-252	5.602	5.600	5.380	**	**	**	0.195
-253	5.730	5.728	5.508	**	**	**	0.195
-254	5.857	5.855	5.635	**	**	**	0.195
-255	5.985	5.983	5.783	**	**	**	0.195
-256	6.112	6.110	5.890	**	**	**	0.195
-257	6.240	6.238	6.018	**	**	**	0.195
-258	6.367	6.365	6.145	**	**	**	0.195
-259	6.627	6.625	6.405	**	**	**	0.195
-260	6.882	6.880	6.660	**	**	**	0.195
-261	7.137	7.135	6.915	**	**	**	0.195
-262	7.392	7.390	7.170	**	**	**	0.195
-263	7.653	7.651	7.431	**	**	**	0.195
-264	7.908	7.906	7.686	**	**	**	0.195
-265	8.163	8.161	7.941	**	**	**	0.195
-266	8.418	8.416	8.196	**	**	**	0.195
-267	8.678	8.676	8.456	**	**	**	0.195
-268	8.933	8.931	8.711	**	**	**	0.195
-269	9.188	9.186	8.966	**	**	**	0.195
-270	9.442	9.440	9.221	**	**	**	0.195
-271	9.703	9.701	9.481	**	**	**	0.195
-272	9.958	9.956	9.736	**	**	**	0.195
-273	10.213	10.211	9.991	**	**	**	0.195
-274	10.467	10.465	10.246	**	**	**	0.195
-275	10.977	10.975	10.756	**	**	**	0.195
-276	11.498	11.496	11.276	**	**	**	0.195
-277	12.008	12.006	11.786	**	**	**	0.195
-278	12.517	12.515	12.296	**	**	**	0.195
-279	13.537	13.535	13.316	**	**	**	0.195
-280	14.558	14.556	14.336	**	**	**	0.195
-281	15.578	15.576	15.356	**	**	**	0.195
-282	16.578	16.576	16.357	**	**	**	0.195
-283	17.603	17.601	17.382	**	**	**	0.195
-284	18.628	18.626	18.407	**	**	**	0.195

## Static Radial Seal Dimensions

**Table F**

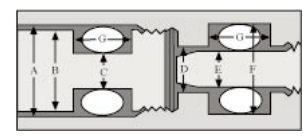

AS 568A Number	A Bore Diameter	B Piston Diameter	C Piston Groove Diameter	D Bore Diameter	E Rod Diameter	F Gland Diameter	G Gland Width
<b>Tolerance</b>	<b>+0.003/-0.000</b>	<b>+0.000/-0.003</b>	<b>+0.000/-0.006</b>	<b>+0.003/-0.000</b>	<b>+0.000/-0.003</b>	<b>+0.006/-0.000</b>	<b>+0.010/-0.000</b>
-309	0.778	0.775	0.433	0.431	0.428	0.773	0.280
-310	0.843	0.840	0.498	0.496	0.493	0.838	0.280
-311	0.908	0.905	0.563	0.561	0.558	0.903	0.280
-312	0.973	0.970	0.629	0.627	0.624	0.968	0.280
-313	1.037	1.034	0.692	0.690	0.687	1.032	0.280
-314	1.103	1.100	0.758	0.756	0.753	1.098	0.280
-315	1.165	1.162	0.821	0.819	0.816	1.160	0.280
-316	1.230	1.227	0.885	0.883	0.880	1.225	0.280
-317	1.292	1.289	0.948	0.946	0.943	1.287	0.280
-318	1.358	1.355	1.013	1.011	1.008	1.353	0.280
-319	1.421	1.418	1.076	1.074	1.071	1.416	0.280
-320	1.487	1.484	1.142	1.140	1.137	1.482	0.280
-321	1.550	1.547	1.205	1.203	1.200	1.545	0.280
-322	1.615	1.612	1.270	1.268	1.265	1.610	0.280
-323	1.678	1.675	1.333	1.331	1.328	1.673	0.280
-324	1.741	1.738	1.397	1.395	1.392	1.736	0.280
-325	1.873	1.870	1.528	1.526	1.523	1.868	0.280
-326	2.000	1.997	1.655	1.653	1.650	1.995	0.280
-327	2.127	2.124	1.783	1.781	1.778	2.122	0.280
-328	2.255	2.252	1.910	1.908	1.905	2.250	0.280
-329	2.386	2.383	2.041	2.039	2.036	2.381	0.280
-330	2.513	2.510	2.168	2.166	2.163	2.508	0.280
-331	2.641	2.638	2.296	2.294	2.291	2.636	0.280
-332	2.768	2.765	2.423	2.421	2.418	2.763	0.280
-333	2.898	2.895	2.553	2.551	2.548	2.893	0.280
-334	3.025	3.022	2.680	2.678	2.675	3.020	0.280
-335	3.153	3.150	2.808	2.806	2.803	3.148	0.280
-336	3.279	3.276	2.935	2.933	2.930	3.274	0.280
-337	3.412	3.409	3.067	3.065	3.062	3.407	0.280
-338	3.539	3.536	3.194	3.192	3.189	3.534	0.280
-339	3.667	3.664	3.322	3.320	3.317	3.662	0.280
-340	3.794	3.791	3.449	3.447	3.444	3.789	0.280
-341	3.921	3.918	3.577	3.575	3.572	3.916	0.280
-342	4.054	4.051	3.709	3.707	3.704	4.049	0.280
-343	4.181	4.178	3.836	3.834	3.831	4.176	0.280
-344	4.309	4.306	3.964	3.962	3.959	4.304	0.280
-345	4.436	4.433	4.091	4.089	4.086	4.431	0.280
-346	4.563	4.560	4.219	4.217	4.214	4.558	0.280
-347	4.693	4.690	4.348	4.346	4.343	4.688	0.280
-348	4.820	4.817	4.476	4.474	4.471	4.815	0.280
-349	4.948	4.945	4.603	4.601	4.598	4.943	0.280
-350	5.076	5.073	4.731	4.729	4.726	5.071	0.280
-351	5.203	5.200	4.858	4.856	4.853	5.198	0.280
-352	5.331	5.328	4.986	4.984	4.981	5.326	0.280
-353	5.465	5.462	5.120	5.118	5.115	5.460	0.280

# Static Radial Seal Dimensions

**Table F**

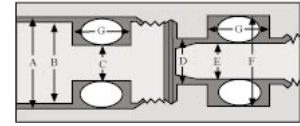

AS 568A Number	A Bore Diameter	B Piston Diameter	C Piston Groove Diameter	D Bore Diameter	E Rod Diameter	F Gland Diameter	G Gland Width
<b>Tolerance</b>	<b>+0.003/-0.000</b>	<b>+0.000/-0.003</b>	<b>+0.000/-0.006</b>	<b>+0.003/-0.000</b>	<b>+0.000/-0.003</b>	<b>+0.006/-0.000</b>	<b>+0.010/-0.000</b>
-354	5.593	5.590	5.248	5.246	5.243	5.588	0.280
-355	5.720	5.717	5.375	5.373	5.370	5.715	0.280
-356	5.847	5.844	5.503	5.501	5.498	5.842	0.280
-357	5.975	5.972	5.630	5.628	5.625	5.970	0.280
-358	6.103	6.100	5.758	5.756	5.753	6.098	0.280
-359	6.230	6.227	5.885	5.883	5.880	6.225	0.280
-360	6.358	6.355	6.013	6.011	6.008	6.353	0.280
-361	6.485	6.482	6.140	6.138	6.135	6.480	0.280
-362	6.743	6.740	6.398	6.396	6.393	6.738	0.280
-363	6.998	6.995	6.653	6.651	6.648	6.993	0.280
-364	7.253	7.250	6.908	6.906	6.903	7.248	0.280
-365	7.508	7.505	7.163	7.161	7.158	7.503	0.280
-366	7.768	7.765	7.423	7.421	7.418	7.763	0.280
-367	8.023	8.020	7.678	7.676	7.673	8.018	0.280
-368	8.278	8.275	7.933	7.931	7.928	8.273	0.280
-369	8.533	8.530	8.188	8.186	8.183	8.528	0.280
-370	8.794	8.791	8.449	8.447	8.444	8.789	0.280
-371	9.049	9.046	8.704	**	**	**	0.280
-372	9.304	9.301	8.959	**	**	**	0.280
-373	9.559	9.556	9.214	**	**	**	0.280
-374	9.819	9.816	9.474	**	**	**	0.280
-375	10.074	10.071	9.729	**	**	**	0.280
-376	10.329	10.326	9.984	**	**	**	0.280
-377	10.584	10.581	10.239	**	**	**	0.280
-378	11.099	11.096	10.754	**	**	**	0.280
-379	11.609	11.606	11.264	**	**	**	0.280
-380	12.124	12.121	11.779	**	**	**	0.280
-381	12.634	12.631	12.289	**	**	**	0.280
<b>Tolerance</b>	<b>+0.003/-0.000</b>	<b>+0.000/-0.003</b>	<b>+0.000/-0.008</b>	<b>+0.004/-0.000</b>	<b>+0.000/-0.003</b>	<b>+0.010/-0.000</b>	<b>+0.010/-0.000</b>
-382	13.654	13.651	13.309	**	**	**	0.280
-383	14.679	14.676	14.334	**	**	**	0.280
-384	15.699	15.696	15.354	**	**	**	0.280
-385	16.703	16.700	16.359	**	**	**	0.280
-386	17.728	17.725	17.384	**	**	**	0.280
-387	18.753	18.750	18.409	**	**	**	0.280
-388	19.778	19.775	19.434	**	**	**	0.280
-389	20.803	20.800	20.459	**	**	**	0.280
-390	21.824	21.821	21.479	**	**	**	0.280
-391	22.849	22.846	22.504	**	**	**	0.280
-392	23.859	23.856	23.514	**	**	**	0.280
-393	24.884	24.881	24.539	**	**	**	0.280
-394	25.909	25.906	25.564	**	**	**	0.280
-395	26.934	26.931	26.589	**	**	**	0.280
-425	5.065	5.061	4.608	4.606	4.601	5.059	0.350

## Static Radial Seal Dimensions

**Table F**

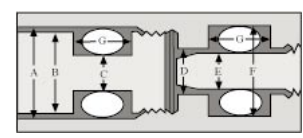

AS 568A Number	A Bore Diameter	B Piston Diameter	C Piston Groove Diameter	D Bore Diameter	E Rod Diameter	F Gland Diameter	G Gland Width
<b>Tolerance</b>	<b>+0.003/-0.000</b>	<b>+0.000/-0.003</b>	<b>+0.000/-0.008</b>	<b>+0.004/-0.000</b>	<b>+0.000/-0.003</b>	<b>+0.010/-0.000</b>	<b>+0.010/-0.000</b>
-426	5.193	5.189	4.736	4.734	4.729	5.187	0.350
-427	5.321	5.317	4.863	4.861	4.856	5.315	0.350
-428	5.449	5.445	4.991	4.989	4.984	5.443	0.350
-429	5.579	5.575	5.122	5.120	5.115	5.573	0.350
-430	5.707	5.703	5.250	5.248	5.243	5.701	0.350
-431	5.835	5.831	5.377	5.375	5.370	5.829	0.350
-432	5.963	5.959	5.505	5.503	5.498	5.957	0.350
-433	6.090	6.086	5.632	5.630	5.625	6.084	0.350
-434	6.218	6.214	5.760	5.758	5.753	6.212	0.350
-435	6.344	6.340	5.887	5.885	5.880	6.338	0.350
-436	6.472	6.468	6.015	6.013	6.008	6.466	0.350
-437	6.599	6.595	6.142	6.140	6.135	6.593	0.350
-438	6.857	6.853	6.400	6.398	6.393	6.851	0.350
-439	7.112	7.108	6.655	6.653	6.648	7.106	0.350
-440	7.367	7.363	6.910	6.908	6.903	7.361	0.350
-441	7.623	7.619	7.165	7.163	7.158	7.617	0.350
-442	7.882	7.878	7.425	7.423	7.418	7.876	0.350
-443	8.137	8.133	7.680	7.678	7.673	8.131	0.350
-444	8.392	8.388	7.935	7.933	7.928	8.386	0.350
-445	8.648	8.644	8.190	8.188	8.183	8.642	0.350
-446	9.168	9.164	8.711	8.709	8.704	9.162	0.350
-447	9.678	9.674	9.221	9.219	9.214	9.672	0.350
-448	10.188	10.184	9.731	**	**	**	0.350
-449	10.699	10.695	10.241	**	**	**	0.350
-450	11.213	11.209	10.756	**	**	**	0.350
-451	11.724	11.720	11.266	**	**	**	0.350
-452	12.233	12.229	11.776	**	**	**	0.350
-453	12.743	12.739	12.286	**	**	**	0.350
-454	13.253	13.249	12.796	**	**	**	0.350
-455	13.763	13.759	13.306	**	**	**	0.350
-456	14.283	14.279	13.826	**	**	**	0.350
-457	14.793	14.789	14.336	**	**	**	0.350
-458	15.303	15.299	14.846	**	**	**	0.350
-459	15.813	15.809	15.356	**	**	**	0.350
-460	16.323	16.319	15.866	**	**	**	0.350
-461	16.818	16.814	16.361	**	**	**	0.350
-462	17.328	17.324	16.871	**	**	**	0.350
-463	17.843	17.839	17.386	**	**	**	0.350
-464	18.358	18.354	17.901	**	**	**	0.350
-465	18.868	18.864	18.411	**	**	**	0.350
-466	19.378	19.374	18.921	**	**	**	0.350
-467	19.893	19.889	19.436	**	**	**	0.350
-468	20.403	20.399	19.946	**	**	**	0.350
-469	20.918	20.914	20.461	**	**	**	0.350
-470	21.938	21.934	21.481	**	**	**	0.350

## Static Radial Seal Dimensions

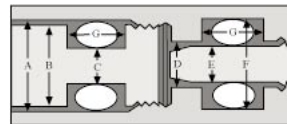
**Table F**

AS 568A Number	A Bore Diameter	B Piston Diameter	C Piston Groove Diameter	D Bore Diameter	E Rod Diameter	F Gland Diameter	G Gland Width
<b>Tolerance</b>	<b>+0.003/-0.000</b>	<b>+0.000/-0.003</b>	<b>+0.000/-0.008</b>	<b>+0.004/-0.000</b>	<b>+0.000/-0.003</b>	<b>+0.010/-0.000</b>	<b>+0.010/-0.000</b>
-471	22.963	22.959	22.506	**	**	**	0.350
-472	23.973	23.969	23.516	**	**	**	0.350
-473	24.998	24.994	24.541	**	**	**	0.350
-474	26.023	26.019	25.566	**	**	**	0.350
-475	27.048	27.044	26.591	**	**	**	0.350

\*\* Standard glands are not provided for the larger diameter bore-mounted applications because Diameter F becomes larger than the outside diameter of the O-Ring seal, making the installation of the seal impractical.

## Dynamic Radial Seal Gland Dimensions

**Table G**

This table contains gland dimensions for the application of standard size O-ring into Dynamic Radial seal glands as shown in the diagram.

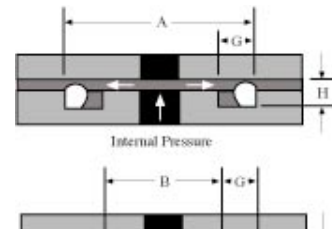

AS 568A Number	A Cylinder Bore Dia.	B Piston Diameter	C Piston Groove Diameter	D Rod Bore Diameter	E Rod Diameter	F Gland Diameter	G Gland Width
<b>Tolerance</b>	<b>+0.001/-0.000</b>	<b>+0.001/-0.000</b>	<b>+0.001/-0.000</b>	<b>+0.001/-0.000</b>	<b>+0.001/-0.000</b>	<b>+0.001/-0.000</b>	<b>+0.001/-0.000</b>
-006	0.230	0.228	0.120	0.123	0.120	0.230	0.100
-007	0.262	0.260	0.151	0.154	0.151	0.262	0.100
-008	0.294	0.292	0.182	0.185	0.182	0.294	0.100
-009	0.326	0.324	0.214	0.217	0.214	0.326	0.100
-010	0.358	0.356	0.245	0.248	0.245	0.358	0.100
-011	0.421	0.419	0.307	0.310	0.307	0.421	0.100
-012	0.484	0.482	0.370	0.373	0.370	0.484	0.100
-013	0.546	0.544	0.432	0.435	0.432	0.546	0.100
-014	0.609	0.607	0.495	0.498	0.495	0.609	0.100
<b>Tolerance</b>	<b>+0.002/-0.000</b>	<b>+0.001/-0.000</b>	<b>+0.002/-0.000</b>	<b>+0.002/-0.000</b>	<b>+0.002/-0.000</b>	<b>+0.002/-0.000</b>	<b>+0.010/-0.000</b>
-015	0.672	0.670	0.559	0.562	0.559	0.672	0.100
-016	0.736	0.734	0.624	0.627	0.624	0.736	0.100
-017	0.798	0.796	0.686	0.689	0.686	0.798	0.100
-018	0.862	0.860	0.749	0.752	0.749	0.862	0.100
-019	0.925	0.923	0.812	0.815	0.812	0.925	0.100
-020	0.988	0.986	0.875	0.878	0.875	0.988	0.100
<b>Tolerance</b>	<b>+0.002/-0.000</b>	<b>+0.002/-0.000</b>	<b>+0.002/-0.000</b>	<b>+0.002/-0.000</b>	<b>+0.002/-0.000</b>	<b>+0.002/-0.000</b>	<b>+0.010/-0.000</b>
-106	0.351	0.348	0.180	0.184	0.180	0.351	0.135
-107	0.384	0.381	0.212	0.216	0.212	0.384	0.135
-108	0.415	0.412	0.243	0.247	0.243	0.415	0.135
-109	0.479	0.476	0.305	0.309	0.305	0.479	0.135
-110	0.542	0.539	0.368	0.372	0.368	0.542	0.135
-111	0.605	0.602	0.430	0.434	0.430	0.605	0.135
<b>Tolerance</b>	<b>+0.002/-0.000</b>	<b>+0.001/-0.000</b>	<b>+0.002/-0.000</b>	<b>+0.002/-0.000</b>	<b>+0.002/-0.000</b>	<b>+0.002/-0.000</b>	<b>+0.010/-0.000</b>
-112	0.668	0.665	0.493	0.497	0.493	0.668	0.135
-113	0.732	0.729	0.557	0.561	0.557	0.732	0.135
-114	0.796	0.793	0.622	0.626	0.622	0.796	0.135
-115	0.859	0.856	0.684	0.688	0.684	0.859	0.135
-116	0.922	0.919	0.747	0.751	0.747	0.922	0.135
-117	0.986	0.983	0.811	0.815	0.811	0.986	0.135
-118	1.049	1.046	0.874	0.878	0.874	1.049	0.135
-119	1.110	1.107	0.936	0.940	0.936	1.110	0.135
-120	1.174	1.171	0.999	1.003	0.999	1.174	0.135
-121	1.236	1.233	1.061	1.065	1.061	1.236	0.135
-122	1.299	1.296	1.124	1.128	1.124	1.299	0.135
-123	1.363	1.360	1.188	1.192	1.188	1.363	0.135
-124	1.426	1.423	1.251	1.255	1.251	1.426	0.135

# Dynamic Radial Seal Gland Dimensions

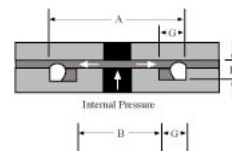
**Table G**

AS 568A Number	A Cylinder Bore Dia.	B Piston Diameter	C Piston Groove Diameter	D Rod Bore Diameter	E Rod Diameter	F Gland Diameter	G Gland Width
<b>Tolerance</b>	<b>+0.002/-0.000</b>	<b>+0.001/-0.000</b>	<b>+0.002/-0.000</b>	<b>+0.002/-0.000</b>	<b>+0.002/-0.000</b>	<b>+0.002/-0.000</b>	<b>+0.010/-0.000</b>
-125	1.489	1.486	1.314	1.318	1.314	1.489	0.135
<b>Tolerance</b>	<b>+0.002/-0.000</b>	<b>+0.002/-0.000</b>	<b>+0.002/-0.000</b>	<b>+0.002/-0.000</b>	<b>+0.002/-0.000</b>	<b>+0.002/-0.000</b>	<b>+0.010/-0.000</b>
-202	0.478	0.474	0.240	0.244	0.240	0.478	0.175
-203	0.541	0.537	0.302	0.306	0.302	0.541	0.175
-204	0.605	0.601	0.365	0.369	0.365	0.605	0.175
-205	0.668	0.664	0.427	0.431	0.427	0.668	0.175
-206	0.732	0.728	0.490	0.494	0.490	0.732	0.175
-207	0.795	0.791	0.554	0.558	0.554	0.795	0.175
-208	0.859	0.855	0.619	0.623	0.619	0.859	0.175
-209	0.922	0.918	0.681	0.685	0.681	0.922	0.175
-210	0.986	0.982	0.745	0.749	0.745	0.986	0.175
-211	1.049	1.045	0.808	0.812	0.808	1.049	0.175
-212	1.112	1.108	0.871	0.875	0.871	1.112	0.175
-213	1.175	1.171	0.933	0.937	0.933	1.175	0.175
-214	1.238	1.234	0.996	1.000	0.996	1.238	0.175
-215	1.299	1.295	1.058	1.062	1.058	1.299	0.175
-216	1.365	1.361	1.123	1.127	1.123	1.365	0.175
-217	1.427	1.423	1.185	1.189	1.185	1.427	0.175
-218	1.489	1.485	1.248	1.252	1.248	1.489	0.175
-219	1.552	1.548	1.311	1.315	1.311	1.552	0.175
-220	1.616	1.612	1.374	1.378	1.374	1.616	0.175
-221	1.678	1.674	1.436	1.440	1.436	1.678	0.175
-222	1.744	1.740	1.502	1.506	1.502	1.744	0.175
-223	1.868	1.864	1.627	1.631	1.627	1.868	0.175
-224	1.994	1.990	1.752	1.756	1.752	1.994	0.175
-225	2.122	2.118	1.881	1.885	1.881	2.122	0.175
-309	0.789	0.784	0.418	0.423	0.418	0.789	0.250
-310	0.853	0.848	0.481	0.486	0.481	0.853	0.250
-311	0.916	0.911	0.545	0.550	0.545	0.916	0.250
-312	0.981	0.976	0.610	0.615	0.610	0.981	0.250
-313	1.044	1.039	0.672	0.677	0.672	1.044	0.250
-314	1.108	1.103	0.736	0.741	0.736	1.108	0.250
-315	1.170	1.165	0.799	0.804	0.799	1.170	0.250
-316	1.234	1.229	0.862	0.867	0.862	1.234	0.250
-317	1.295	1.290	0.924	0.929	0.924	1.295	0.250
-318	1.359	1.354	0.987	0.992	0.987	1.359	0.250
-319	1.420	1.415	1.049	1.054	1.049	1.420	0.250
-320	1.485	1.480	1.114	1.119	1.114	1.485	0.250
-321	1.548	1.543	1.176	1.181	1.176	1.548	0.250
-322	1.610	1.605	1.239	1.244	1.239	1.610	0.250
-323	1.673	1.668	1.302	1.307	1.302	1.673	0.250
-324	1.737	1.732	1.365	1.370	1.365	1.737	0.250
-325	1.865	1.860	1.493	1.498	1.493	1.865	0.250



## Dynamic Radial Seal Gland Dimensions

**Table G**

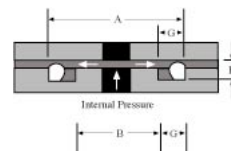

AS 568A Number	A Cylinder Bore Dia.	B Piston Diameter	C Piston Groove Diameter	D Rod Bore Diameter	E Rod Diameter	F Gland Diameter	G Gland Width
<b>Tolerance</b>	<b>+0.02/-0.00</b>	<b>+0.02/-0.00</b>	<b>+0.02/-0.00</b>	<b>+0.02/-0.00</b>	<b>+0.02/-0.00</b>	<b>+0.02/-0.00</b>	<b>+0.10/-0.00</b>
-326	1.990	1.985	1.618	1.623	1.618	1.990	0.250
-327	2.114	2.109	1.743	1.748	1.743	2.114	0.250
-328	2.240	2.235	1.869	1.874	1.869	2.240	0.250
-329	2.369	2.364	1.997	2.002	1.997	2.369	0.250
-330	2.493	2.488	2.122	2.127	2.122	2.493	0.250
-331	2.618	2.613	2.247	2.252	2.247	2.618	0.250
-332	2.745	2.740	2.373	2.378	2.373	2.745	0.250
-333	2.871	2.866	2.500	2.505	2.500	2.871	0.250
-334	2.997	2.992	2.625	2.630	2.625	2.997	0.250
-335	3.121	3.116	2.750	2.755	2.750	3.121	0.250
-336	3.247	3.242	2.876	2.881	2.876	3.247	0.250
-337	3.376	3.371	3.005	3.010	3.005	3.376	0.250
-338	3.502	3.497	3.130	3.135	3.130	3.502	0.250
-339	3.626	3.621	3.255	3.260	3.255	3.626	0.250
-340	3.752	3.747	3.381	3.386	3.381	3.752	0.250
-341	3.877	3.872	3.506	3.511	3.506	3.877	0.250
-342	4.007	4.002	3.635	3.640	3.635	4.007	0.250
-343	4.133	4.128	3.761	3.766	3.761	4.133	0.250
-344	4.257	4.252	3.886	3.891	3.886	4.257	0.250
-345	4.382	4.377	4.011	4.016	4.011	4.382	0.250
-346	4.507	4.502	4.136	4.141	4.136	4.507	0.250
-347	4.635	4.630	4.264	4.269	4.264	4.635	0.250
-348	4.760	4.755	4.389	4.394	4.389	4.760	0.250
-349	4.885	4.880	4.514	4.519	4.514	4.885	0.250
<b>Tolerance</b>	<b>+0.003/-0.000</b>	<b>+0.003/-0.000</b>	<b>+0.003/-0.000</b>	<b>+0.003/-0.000</b>	<b>+0.003/-0.000</b>	<b>+0.004/-0.000</b>	<b>+0.10/-0.000</b>
-425	5.009	5.002	4.517	4.523	4.517	5.008	0.320
-426	5.134	5.127	4.642	4.648	4.642	5.133	0.320
-427	5.260	5.253	4.768	4.774	4.768	5.259	0.320
-428	5.385	5.378	4.893	4.899	4.893	5.384	0.320
-429	5.514	5.507	5.022	5.028	5.022	5.513	0.320
-430	5.639	5.632	5.147	5.153	5.147	5.638	0.320
-431	5.765	5.758	5.273	5.279	5.273	5.764	0.320
-432	5.890	5.883	5.398	5.404	5.398	5.889	0.320
-433	6.015	6.008	5.523	5.529	5.523	6.014	0.320
-434	6.140	6.133	5.648	5.654	5.644	6.139	0.320
-435	6.266	6.259	5.774	5.780	5.774	6.265	0.320
-436	6.391	6.384	5.899	5.905	5.899	6.390	0.320
-437	6.516	6.509	6.024	6.030	6.024	6.515	0.320
-438	6.770	6.763	6.278	6.284	6.278	6.769	0.320
-439	7.020	7.013	6.528	6.534	6.528	7.019	0.320
-440	7.271	7.264	6.779	6.785	6.779	7.270	0.320
-441	7.521	7.514	7.029	7.035	7.029	7.520	0.320
-442	7.777	7.770	7.285	7.291	7.285	7.776	0.320
-443	8.027	8.020	7.535	7.541	7.535	8.026	0.320

# Dynamic Radial Seal Gland Dimensions

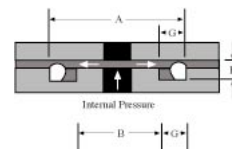
**Table G**

AS 568A Number	A Cylinder Bore Dia.	B Piston Diameter	C Piston Groove Diameter	D Rod Bore Diameter	E Rod Diameter	F Gland Diameter	G Gland Width
<b>Tolerance</b>	<b>+0.003/-0.000</b>	<b>+0.003/-0.000</b>	<b>+0.003/-0.000</b>	<b>+0.003/-0.000</b>	<b>+0.003/-0.000</b>	<b>+0.004/-0.000</b>	<b>+0.010/-0.000</b>
-444	8.278	8.271	7.786	7.792	7.786	8.277	0.320
-445	8.528	8.521	8.036	8.042	8.036	8.527	0.320
-446	9.039	9.032	8.547	8.553	8.547	9.038	0.320
-447	9.540	9.533	9.048	9.054	9.048	9.539	0.320
-448	10.041	10.034	9.549	9.555	9.549	10.040	0.320
-449	10.542	10.535	10.050	10.056	10.050	10.541	0.320
-450	11.048	11.041	10.556	10.562	10.556	11.047	0.320
-451	11.549	11.542	11.057	11.063	11.057	11.548	0.320
-452	12.050	12.043	11.558	11.564	11.558	12.049	0.320
-453	12.551	12.554	12.059	12.065	12.059	12.550	0.320
-454	13.052	13.045	12.560	12.566	12.560	13.051	0.320
-455	13.553	13.546	13.061	13.067	13.061	13.552	0.320
-456	14.064	14.057	13.572	13.578	13.572	14.063	0.320
-457	14.565	14.558	14.073	14.079	14.073	14.564	0.320
-458	15.066	15.059	14.574	14.580	14.574	15.065	0.320
-459	15.567	15.560	15.075	15.081	15.075	15.566	0.320
-460	16.068	16.061	15.576	15.582	15.576	16.067	0.320

## Rotary O-Ring Seal Gland Dimensions

**Table H**

This table contains gland dimensions for the application of standard size O-ring into Rotary seal glands as shown in the diagram.

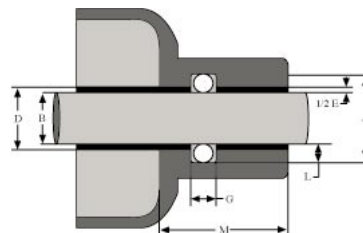
**NOTE:**

- 1) For best results, max pressure 900 psi
- 2) 16 RMS rod finish max
- 3) Due to centrifugal force, do not locate groove in shaft
- 4) Locate seal as close as possible to lubricating fluid
- 5) Feet per minute = (RPM x shaft diameter (inches) x 3.14/12
- 6) To allow for heat transfer, bearing length should be 10 times the cross section of the O-ring used

AS 568A	L Gland Depth	E Diametrical Clearance	M Bearing Length Min.
-004 to -045	.065 to .067	.012 to .016	0.700
-102 to -163	.097 to .099	.012 to .016	1.030
-210 to -258	.133 to .135	.016 to .020	1.390

AS568A Number	B Shaft Diameter	A Groove Diameter	D Bore Diameter	G Groove Width
<b>Tolerance</b>	<b>+.000/-0.001</b>	<b>+.003/-0.000</b>	<b>+.003/-0.000</b>	<b>+.004/-0.000</b>
-004	0.072	0.202	0.084	0.075
-005	0.103	0.233	0.115	0.075
-006	0.116	0.246	0.128	0.075
-007	0.147	0.277	0.159	0.075
-008	0.178	0.308	0.190	0.075
-009	0.210	0.340	0.222	0.075
-010	0.241	0.371	0.253	0.075
-011	0.303	0.433	0.315	0.075
-012	0.366	0.496	0.378	0.075
-013	0.428	0.558	0.440	0.075
-014	0.491	0.621	0.503	0.075
-015	0.553	0.683	0.565	0.075
-016	0.616	0.746	0.628	0.075
-017	0.678	0.808	0.693	0.075
-018	0.741	0.871	0.753	0.075
-019	0.803	0.933	0.815	0.075
-020	0.866	0.996	0.878	0.075
-021	0.928	1.058	0.940	0.075
-022	0.991	1.121	1.003	0.075
-023	1.053	1.183	1.065	0.075
-024	1.116	1.246	1.128	0.075
-025	1.178	1.308	1.190	0.075
-026	1.241	1.371	1.253	0.075
-027	1.303	1.433	1.315	0.075
-028	1.366	1.496	1.378	0.075
-029	1.491	1.621	1.503	0.075
-030	1.616	1.746	1.628	0.075
-031	1.741	1.871	1.753	0.075

# Rotary O-Ring Seal Gland Dimensions

Table H

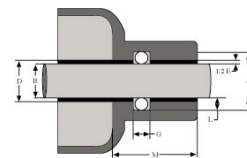

AS568A Number	B Shaft Diameter	A Groove Diameter	D Bore Diameter	G Groove Width
<b>Tolerance</b>	<b>+0.00/-0.001</b>	<b>+0.003/-0.000</b>	<b>+0.003/-0.000</b>	<b>+0.004/-0.000</b>
-032	1.866	1.996	1.878	0.075
-033	1.991	2.121	2.003	0.075
-034	2.116	2.246	2.128	0.075
-035	2.241	2.371	2.253	0.075
-036	2.366	2.496	2.378	0.075
-037	2.491	2.621	2.503	0.075
-038	2.616	2.746	2.628	0.075
-039	2.741	2.871	2.753	0.075
-040	2.866	2.996	2.878	0.075
-041	2.991	3.121	3.003	0.075
-042	3.241	3.371	3.253	0.075
-043	3.491	3.621	3.503	0.075
-044	3.741	3.871	3.753	0.075
-045	3.991	4.121	4.003	0.075
-102	0.051	0.245	0.063	0.108
-103	0.083	0.277	0.095	0.108
-104	0.114	0.308	0.126	0.108
-105	0.145	0.339	0.157	0.108
-106	0.176	0.370	0.188	0.108
-107	0.208	0.402	0.220	0.108
-108	0.239	0.433	0.251	0.108
-109	0.301	0.495	0.313	0.108
-110	0.364	0.558	0.376	0.108
-111	0.426	0.620	0.438	0.108
-112	0.489	0.683	0.501	0.108
-113	0.551	0.745	0.563	0.108
-114	0.614	0.808	0.626	0.108
-115	0.676	0.870	0.688	0.108
-116	0.739	0.933	0.751	0.108
-117	0.801	0.995	0.813	0.108
-118	0.864	1.058	0.876	0.108
-119	0.926	1.120	0.938	0.108
-120	0.989	1.183	1.001	0.108
-121	1.051	1.245	1.063	0.108
-122	1.114	1.308	1.126	0.108
-123	1.176	1.370	1.188	0.108
-124	1.239	1.433	1.251	0.108
-125	1.301	1.495	1.313	0.108
-126	1.364	1.558	1.376	0.108
-127	1.426	1.620	1.438	0.108
-128	1.489	1.683	1.501	0.108
-129	1.551	1.745	1.563	0.108
-130	1.614	1.808	1.626	0.108
-131	1.676	1.870	1.688	0.108
-132	1.739	1.933	1.751	0.108

# Rotary O-Ring Seal Gland Dimensions

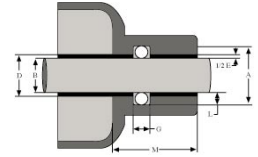
**Table H**

AS568A Number	B Shaft Diameter	A Groove Diameter	D Bore Diameter	G Groove Width
<b>Tolerance</b>	<b>+0.00/-0.001</b>	<b>+0.003/-0.000</b>	<b>+0.003/-0.000</b>	<b>+0.004/-0.000</b>
-133	1.801	1.995	1.813	0.108
-134	1.864	2.058	1.876	0.108
-135	1.927	2.121	1.939	0.108
-136	1.989	2.183	2.001	0.108
-137	2.052	2.246	2.064	0.108
-138	2.114	2.308	2.126	0.108
-139	2.177	2.371	2.189	0.108
-140	2.239	2.433	2.251	0.108
-141	2.302	2.496	2.314	0.108
-142	2.364	2.558	2.376	0.108
-143	2.427	2.621	2.439	0.108
-144	2.489	2.683	2.501	0.108
-145	2.552	2.746	2.564	0.108
-146	2.614	2.808	2.626	0.108
-147	2.677	2.871	2.689	0.108
-148	2.739	2.933	2.751	0.108
-149	2.802	2.996	2.814	0.108
-150	2.864	3.058	2.876	0.108
-151	2.989	3.183	3.001	0.108
-152	3.239	3.433	3.251	0.108
-153	3.489	3.683	3.501	0.108
-154	3.739	3.933	3.751	0.108
-155	3.989	4.183	4.001	0.108
-156	4.239	4.443	4.251	0.108
-157	4.489	4.683	4.501	0.108
-158	4.739	4.933	4.751	0.108
-159	4.989	5.183	5.001	0.108
-160	5.239	5.433	5.251	0.108
-161	5.489	5.683	5.501	0.108
-162	5.739	5.933	5.751	0.108
-163	5.989	6.183	6.001	0.108
-201	0.173	0.439	0.189	0.144
-202	0.236	0.502	0.252	0.144
-203	0.298	0.564	0.314	0.144
-204	0.361	0.627	0.377	0.144
-205	0.423	0.689	0.439	0.144
-206	0.486	0.752	0.502	0.144
-207	0.548	0.814	0.564	0.144
-208	0.611	0.877	0.627	0.144
-209	0.673	0.939	0.689	0.144
-210	0.736	1.002	0.752	0.144
-211	0.798	1.064	0.814	0.144
-212	0.861	1.127	0.877	0.144
-213	0.923	1.189	0.939	0.144
-214	0.986	1.252	1.002	0.144

# Rotary O-Ring Seal Gland Dimensions

Table H

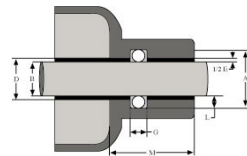

AS568A Number	B Shaft Diameter	A Groove Diameter	D Bore Diameter	G Groove Width
<b>Tolerance</b>	<b>+0.00/-0.01</b>	<b>+0.003/-0.000</b>	<b>+0.003/-0.000</b>	<b>+0.004/-0.000</b>
-215	1.048	1.314	1.064	0.144
-216	1.111	1.377	1.127	0.144
-217	1.173	1.439	1.189	0.144
-218	1.236	1.502	1.252	0.144
-219	1.298	1.564	1.314	0.144
-220	1.361	1.627	1.377	0.144
-221	1.423	1.689	1.439	0.144
-222	1.486	1.752	1.502	0.144
-223	1.611	1.877	1.627	0.144
-224	1.736	2.002	1.752	0.144
-225	1.861	2.127	1.877	0.144
-226	1.986	2.252	2.002	0.144
-227	2.111	2.377	2.127	0.144
-228	2.236	2.502	2.252	0.144
-229	2.361	2.627	2.377	0.144
-230	2.486	2.752	2.502	0.144
-231	2.611	2.877	2.627	0.144
-232	2.736	3.002	2.752	0.144
-233	2.861	3.127	2.877	0.144
-234	2.986	3.252	3.002	0.144
-235	3.111	3.377	3.127	0.144
-236	3.236	3.502	3.252	0.144
-237	3.361	3.627	3.377	0.144
-238	3.486	3.752	3.502	0.144
-239	3.611	3.877	3.627	0.144
-240	3.736	4.002	3.752	0.144
-241	3.861	4.127	3.877	0.144
-242	3.986	4.252	4.002	0.144
-243	4.111	4.377	4.127	0.144
-244	4.236	4.502	4.252	0.144
-245	4.361	4.627	4.377	0.144
-246	4.486	4.752	4.502	0.144
-247	4.611	4.877	4.627	0.144
-248	4.736	5.002	4.752	0.144
-249	4.861	5.127	4.877	0.144
-250	4.986	5.252	5.002	0.144
-251	5.111	5.377	5.127	0.144
-252	5.236	5.502	5.252	0.144
-253	5.361	5.627	5.377	0.144
-254	5.486	5.752	5.502	0.144
-255	5.611	5.877	5.627	0.144
-256	5.736	6.002	5.752	0.144
-257	5.861	6.127	5.877	0.144
-258	5.986	6.252	6.002	0.144

# O-Ring Size Chart

- O-Ring Size Chart for Inch Seals..... 62 - 68
- O-Ring Size Chart for Straight Thread  
Tube Fittings ..... 69
- O-Ring Size Chart for Metric Seals..... 70 - 71

## O-Ring Size Chart for Inch Seals

Hercules Size No.	Nominal Size				Inch Standard					Metric Standard					
					Inside Diameter		Cross Section		Basic Volume cu in.	Inside Diameter		Cross Section		Basic Volume cu. cm	
	ID	OD	CS	in.	+/-	in.	+/-	mm		+/-	mm	+/-			
001	1/32	X	3/32	X	1/32	0.029	0.004	0.040	0.003	0.0003	0.74	0.10	1.02	0.08	0.005
001-1/2	1/16	X	1/8	X	1/32	0.070	0.004	0.040	0.003	0.0004	1.78	0.10	1.02	0.08	0.007
002	3/64	X	9/64	X	1/32	0.042	0.004	0.050	0.003	0.0006	1.07	0.10	1.27	0.08	0.010
003	1/16	X	3/16	X	1/16	0.056	0.004	0.060	0.003	0.0010	1.42	0.10	1.52	0.08	0.016
004	5/64	X	13/84	X	1/16	0.070	0.005	0.070	0.003	0.0017	1.78	0.13	1.78	0.08	0.028
005	3/32	X	7/32	X	1/16	0.101	0.005	0.070	0.003	0.0021	2.57	0.13	1.78	0.08	0.034
006	1/8	X	1/4	X	1/16	0.114	0.005	0.070	0.003	0.0022	2.90	0.13	1.78	0.08	0.036
007	5/32	X	9/32	X	1/16	0.145	0.005	0.070	0.003	0.0026	3.68	0.13	1.78	0.08	0.043
008	3/16	X	5/16	X	1/16	0.176	0.005	0.070	0.003	0.0030	4.47	0.13	1.78	0.08	0.049
009	7/32	X	11/32	X	1/16	0.208	0.005	0.070	0.003	0.0034	5.28	0.13	1.78	0.08	0.058
010	1/4	X	3/8	X	1/16	0.239	0.005	0.070	0.003	0.0037	6.07	0.13	1.78	0.08	0.061
011	5/16	X	7/16	X	1/16	0.301	0.005	0.070	0.003	0.0045	7.65	0.13	1.78	0.08	0.074
012	3/8	X	1/2	X	1/16	0.364	0.005	0.070	0.003	0.0052	9.25	0.13	1.78	0.08	0.085
013	7/16	X	9/16	X	1/16	0.426	0.005	0.070	0.003	0.0060	10.82	0.13	1.78	0.08	0.098
014	1/2	X	5/8	X	1/16	0.489	0.005	0.070	0.003	0.0068	12.42	0.13	1.78	0.08	0.111
015	9/16	X	11/16	X	1/16	0.551	0.007	0.070	0.003	0.0075	14.00	0.18	1.78	0.08	0.123
016	5/8	X	3/4	X	1/16	0.614	0.009	0.070	0.003	0.0083	15.60	0.23	1.78	0.08	0.136
017	11/16	X	13/16	X	1/16	0.676	0.009	0.070	0.003	0.0090	17.17	0.23	1.78	0.08	0.148
018	3/4	X	7/8	X	1/16	0.739	0.009	0.070	0.003	0.0098	18.77	0.23	1.78	0.08	0.161
019	13/16	X	15/16	X	1/16	0.801	0.009	0.070	0.003	0.0105	20.35	0.23	1.78	0.08	0.172
020	7/8	X	1	X	1/16	0.864	0.009	0.070	0.003	0.0113	21.95	0.23	1.78	0.08	0.185
021	15/16	X	1-1/16	X	1/16	0.926	0.009	0.070	0.003	0.0120	23.52	0.23	1.78	0.08	0.197
022	1	X	1-1/8	X	1/16	0.989	0.010	0.070	0.003	0.0128	25.12	0.25	1.78	0.08	0.210
023	1-1/16	X	1-3/16	X	1/16	1.051	0.010	0.070	0.003	0.0136	26.70	0.25	1.78	0.08	0.223
024	1-1/8	X	1-1/4	X	1/16	1.114	0.010	0.070	0.003	0.0143	28.30	0.25	1.78	0.08	0.234
025	1-3/16	X	1-5/16	X	1/16	1.176	0.011	0.070	0.003	0.0151	29.87	0.28	1.78	0.08	0.247
026	1-1/4	X	1-3/8	X	1/16	1.239	0.011	0.070	0.003	0.0158	31.47	0.28	1.78	0.08	0.259
027	1-5/16	X	1-7/8	X	1/16	1.239	0.011	0.070	0.003	0.0166	33.05	0.28	1.78	0.08	0.272
028	1-3/8	X	1-1/2	X	1/16	1.364	0.013	0.070	0.003	0.0173	34.65	0.33	1.78	0.08	0.284
029	1-1/2	X	1-5/8	X	1/16	1.489	0.013	0.070	0.003	0.0188	37.82	0.33	1.78	0.08	0.308
030	1-5/8	X	1 3/4	X	1/16	1.614	0.013	0.070	0.003	0.0204	41.00	0.33	1.78	0.08	0.334
031	1-3/4	X	1-7/8	X	1/16	1.739	0.015	0.070	0.003	0.0219	44.17	0.38	1.78	0.08	0.359
032	1-7/8	X	2	X	1/16	1.864	0.015	0.070	0.003	0.0234	47.35	0.38	1.78	0.08	0.384
033	2	X	2-1/8	X	1/16	1.989	0.018	0.070	0.003	0.0249	50.52	0.46	1.78	0.08	0.408
034	2-1/8	X	2-1/4	X	1/16	2.114	0.018	0.070	0.003	0.0264	53.70	0.46	1.78	0.08	0.433
035	2-1/4	X	2-3/8	X	1/16	2.239	0.018	0.070	0.003	0.0279	56.87	0.46	1.78	0.08	0.457
036	2-3/8	X	2-1/2	X	1/16	2.364	0.018	0.070	0.003	0.0294	60.05	0.46	1.78	0.08	0.482
037	2-1/2	X	2/5/8	X	1/16	2.489	0.018	0.070	0.003	0.0309	63.22	0.46	1.78	0.08	0.506
038	2-5/8	X	2-3/4	X	1/16	2.614	0.020	0.070	0.003	0.0324	66.40	0.51	1.78	0.08	0.531
039	2-3/4	X	2-7/8	X	1/16	2.739	0.020	0.070	0.003	0.0340	69.57	0.51	1.78	0.08	0.557
040	2-7/8	X	3	X	1/16	2.864	0.020	0.070	0.003	0.0355	72.75	0.51	1.78	0.08	0.582
041	3	X	3-1/8	X	1/16	2.989	0.024	0.070	0.003	0.0370	75.92	0.61	1.78	0.08	0.606
042	3-1/4	X	3-3/8	X	1/16	3.239	0.024	0.070	0.003	0.0400	82.27	0.61	1.78	0.08	0.656
043	3-1/2	X	3-5/8	X	1/16	3.489	0.024	0.070	0.003	0.0430	88.62	0.61	1.78	0.08	0.705
044	3-3/4	X	3-7/8	X	1/16	3.739	0.027	0.070	0.003	0.0460	94.97	0.69	1.78	0.08	0.754
045	4	X	4-1/8	X	1/16	3.989	0.027	0.070	0.003	0.0491	101.32	0.69	1.78	0.08	0.805
046	4-1/4	X	4-3/8	X	1/16	4.239	0.030	0.070	0.003	0.0521	107.67	0.76	1.78	0.08	0.854
047	4-1/2	X	4-5/8	X	1/16	4.489	0.030	0.070	0.003	0.0551	114.02	0.76	1.78	0.08	0.903
048	4-3/4	X	4-7/8	X	1/16	4.739	0.030	0.070	0.003	0.0582	120.37	0.76	1.78	0.08	0.954
049	5	X	5-1/8	X	1/16	4.989	0.037	0.070	0.003	0.0612	126.72	0.94	1.78	0.08	1.003
050	5-1/4	X	5-3/8	X	1/16	5.239	0.037	0.070	0.003	0.0642	133.07	0.94	1.78	0.08	1.054



## O-Ring Size Chart for Inch Seals

Hercules Size No.	Nominal Size				Inch Standard					Metric Standard				
					Inside Diameter		Cross Section		Basic Volume cu in.	Inside Diameter		Cross Section		Basic Volume cu. cm
	ID	OD	CS	in.	+/-	in.	+/-	mm		+/-	mm	+/-		
102	1/16	X 1/4	X 3/32	0.049	0.005	0.103	0.003	0.0400	1.24	0.10	2.62	0.08	0.065	
103	3/32	X 9/32	X 3/32	0.081	0.005	0.103	0.003	0.0048	2.06	0.13	2.62	0.08	0.079	
104	1/8	X 5/16	X 3/32	0.112	0.005	0.103	0.003	0.0058	2.84	0.13	2.62	0.08	0.092	
105	5/32	X 11/32	X 3/32	0.143	0.005	0.103	0.003	0.0064	3.63	0.13	2.62	0.08	0.106	
106	3/16	X 3/8	X 3/32	0.174	0.005	0.103	0.003	0.0072	4.42	0.13	2.62	0.08	0.119	
107	7/32	X 13/32	X 3/32	0.206	0.005	0.103	0.003	0.0081	5.23	0.13	2.62	0.08	0.133	
108	1/4	X 7/16	X 3/32	0.237	0.005	0.103	0.003	0.0089	6.02	0.13	2.62	0.08	0.146	
109	5/16	X 1/2	X 3/32	0.299	0.005	0.103	0.003	0.0105	7.59	0.13	2.62	0.08	0.173	
110	3/8	X 9/16	X 3/32	0.362	0.005	0.103	0.003	0.0122	9.19	0.13	2.62	0.08	0.200	
111	7/16	X 5/8	X 3/32	0.424	0.005	0.103	0.003	0.0138	10.77	0.13	2.62	0.08	0.226	
112	1/2	X 11/16	X 3/32	0.487	0.005	0.103	0.003	0.0154	12.37	0.13	2.62	0.08	0.252	
113	9/16	X 3/4	X 3/32	0.549	0.007	0.103	0.003	0.0171	13.94	0.13	2.62	0.08	0.280	
114	5/8	X 13/16	X 3/32	0.612	0.009	0.103	0.003	0.0187	15.54	0.23	2.62	0.08	0.306	
115	11/16	X 7/8	X 3/32	0.674	0.009	0.103	0.003	0.0203	17.12	0.23	2.62	0.08	0.333	
116	3/4	X 15/16	X 3/32	0.737	0.009	0.103	0.003	0.0220	18.72	0.23	2.62	0.08	0.361	
117	13/16	X 1	X 3/32	0.799	0.010	0.103	0.003	0.0236	20.29	0.25	2.62	0.08	0.387	
118	7/8	X 1-1/16	X 3/32	0.862	0.010	0.103	0.003	0.0253	21.89	0.25	2.62	0.08	0.415	
119	15/16	X 1-1/8	X 3/32	0.924	0.010	0.103	0.003	0.0269	23.47	0.25	2.62	0.08	0.441	
120	1	X 1-3/16	X 3/32	0.987	0.010	0.103	0.003	0.0285	25.07	0.25	2.62	0.08	0.467	
121	1-1/8	X 1-1/4	X 3/32	1.049	0.010	0.103	0.003	0.0302	26.64	0.25	2.62	0.08	0.495	
122	1-1/8	X 1-5/16	X 3/32	1.112	0.010	0.103	0.003	0.0318	28.24	0.25	2.62	0.08	0.521	
123	1-3/8	X 1-3/8	X 3/32	1.174	0.012	0.103	0.003	0.0334	29.82	0.30	2.62	0.08	0.547	
124	1-1/4	X 1-7/16	X 3/32	1.237	0.012	0.103	0.003	0.0351	31.42	0.30	2.62	0.08	0.575	
125	1-5/16	X 1/2	X 3/32	1.299	0.012	0.103	0.003	0.0367	32.99	0.30	2.62	0.08	0.602	
126	1-3/8	X 1-9/16	X 3/32	1.362	0.012	0.103	0.003	0.0383	34.59	0.30	2.62	0.08	0.628	
127	1-7/16	X 1-5/8	X 3/32	1.424	0.012	0.103	0.003	0.0400	36.17	0.30	2.62	0.08	0.656	
128	1-1/2	X 1-11/16	X 3/32	1.487	0.012	0.103	0.003	0.0416	37.77	0.30	2.62	0.08	0.682	
129	1-9/16	X 1-3/4	X 3/32	1.549	0.015	0.103	0.003	0.0432	39.34	0.38	2.62	0.08	0.708	
130	1-5/8	X 1-13/16	X 3/32	1.612	0.015	0.103	0.003	0.0449	40.94	0.38	2.62	0.08	0.736	
131	1-11/16	X 1-7/8	X 3/32	1.674	0.015	0.103	0.003	0.0465	42.52	0.38	2.62	0.08	0.762	
132	1-3/4	X 1-15/16	X 3/32	1.737	0.015	0.103	0.003	0.0482	44.12	0.38	2.62	0.08	0.790	
133	1-13/16	X 2	X 3/32	1.799	0.015	0.103	0.003	0.0498	45.69	0.38	2.62	0.08	0.816	
134	1-7/8	X 2-1/16	X 3/32	1.862	0.015	0.103	0.003	0.0514	47.29	0.38	2.62	0.08	0.842	
135	1-15/16	X 2-1/8	X 3/32	1.925	0.017	0.103	0.003	0.0531	48.90	0.43	2.62	0.08	0.870	
136	2	X 2-3/16	X 3/32	1.987	0.017	0.103	0.003	0.0547	50.47	0.43	2.62	0.08	0.897	
137	2-1/16	X 2-1/4	X 3/32	2.050	0.017	0.103	0.003	0.0564	52.07	0.43	2.62	0.08	0.924	
138	2-1/8	X 2-5/16	X 3/32	2.112	0.017	0.103	0.003	0.0580	53.64	0.43	2.62	0.08	0.951	
139	2-3/16	X 2-3/8	X 3/32	2.175	0.017	0.103	0.003	0.0596	55.25	0.43	2.62	0.08	0.977	
140	2-1/4	X 2-7/16	X 3/32	2.237	0.017	0.103	0.003	0.0612	56.82	0.43	2.62	0.08	1.003	
141	2-5/16	X 2-1/2	X 3/32	2.300	0.020	0.103	0.003	0.0629	58.42	0.51	2.62	0.08	1.031	
142	2-3/8	X 2-9/16	X 3/32	2.362	0.020	0.103	0.003	0.0645	59.99	0.51	2.62	0.08	1.057	
143	2-7/16	X 2-5/8	X 3/32	2.425	0.020	0.103	0.003	0.0662	61.60	0.51	2.62	0.08	1.085	
144	2-1/2	X 2-11/16	X 3/32	2.487	0.020	0.103	0.003	0.0678	63.17	0.51	2.62	0.08	1.111	
145	2-9/16	X 2-3/4	X 3/32	2.550	0.020	0.103	0.003	0.0694	64.77	0.51	2.62	0.08	1.137	
146	2-5/8	X 2-13/16	X 3/32	2.612	0.020	0.103	0.003	0.0711	66.34	0.51	2.62	0.08	1.165	
147	2-11/16	X 2-7/8	X 3/32	2.675	0.022	0.103	0.003	0.0727	67.95	0.56	2.62	0.08	1.192	
148	2-3/4	X 2-15/16	X 3/32	2.737	0.022	0.103	0.003	0.0743	69.52	0.56	2.62	0.08	1.218	
149	2-13/16	X 3	X 3/32	2.800	0.022	0.103	0.003	0.0760	71.12	0.56	2.62	0.08	1.246	
150	2-7/8	X 3-1/16	X 3/32	2.862	0.022	0.103	0.003	0.0776	72.69	0.56	2.62	0.08	1.272	
151	3	X 3-3/16	X 3/32	2.987	0.024	0.103	0.003	0.0809	75.87	0.61	2.62	0.08	1.326	

## O-Ring Size Chart for Inch Seals

Hercules Size No.	Nominal Size			Inch Standard					Metric Standard						
				Inside Diameter		Cross Section		Basic Volume cu in.	Inside Diameter		Cross Section		Basic Volume cu. cm		
				ID	OD	CS	in.		+/-	in.	+/-	mm		+/-	mm
152	3-1/4	X	3-7/16	X	3/32	3.237	0.024	0.103	0.003	0.0874	82.22	0.61	2.62	0.08	1.432
153	3-1/2	X	3-11/16	X	3/32	3.487	0.024	0.103	0.003	0.0940	88.57	0.61	2.62	0.08	1.541
154	3-3/4	X	3-15/16	X	3/32	3.737	0.028	0.103	0.003	0.1005	94.62	0.71	2.62	0.08	1.647
155	4	X	4-3/16	X	3/32	3.987	0.028	0.103	0.003	0.1071	101.27	0.71	2.62	0.08	1.755
156	4-1/4	X	4-7/16	X	3/23	4.237	0.030	0.103	0.003	0.1136	107.62	0.76	2.62	0.08	1.862
157	4-1/2	X	4-11/16	X	3/32	4.487	0.030	0.103	0.003	0.1202	113.97	0.76	2.62	0.08	1.970
158	4-3/4	X	4-15/16	X	3/32	4.737	0.030	0.103	0.003	0.1267	120.32	0.76	2.62	0.08	2.077
159	5	X	5-3/16	X	3/32	4.987	0.035	0.103	0.003	0.1332	126.67	0.89	2.62	0.08	2.183
160	5-1/4	X	5-7/16	X	3/32	5.237	0.035	0.103	0.003	0.1398	133.02	0.89	2.62	0.08	2.291
161	5-1/2	X	5-11/16	X	3/32	5.487	0.035	0.103	0.003	0.1463	139.37	0.89	2.62	0.08	2.398
162	5-3/4	X	5-15/16	X	3/32	5.737	0.035	0.103	0.003	0.1529	145.72	0.89	2.62	0.08	2.506
163	6	X	6-3/16	X	3/32	5.987	0.035	0.103	0.003	0.1594	152.07	0.89	2.62	0.08	2.613
164	6-1/4	X	6-7/16	X	3/32	6.237	0.040	0.103	0.003	0.1658	158.42	1.02	2.62	0.08	2.717
165	6-1/2	X	6-11/16	X	3/32	6.487	0.040	0.103	0.003	0.1724	164.77	1.02	2.62	0.08	2.826
166	6-3/4	X	6-15/16	X	3/32	6.737	0.040	0.103	0.003	0.1789	171.12	1.02	2.62	0.08	2.932
167	7	X	7-3/16	X	3/32	6.987	0.040	0.103	0.003	0.1854	177.47	1.02	2.62	0.08	3.039
168	7-1/4	X	7-7/16	X	3/32	7.237	0.045	0.103	0.003	0.1920	183.82	1.14	2.62	0.08	3.147
169	7-1/2	X	7-11/16	X	3/32	7.487	0.045	0.103	0.003	0.1985	190.17	1.14	2.62	0.08	3.253
170	7-3/4	X	7-15/16	X	3/32	7.737	0.045	0.103	0.003	0.2051	196.52	1.14	2.62	0.08	3.362
171	8	X	8-13/16	X	3/32	7.987	0.045	0.103	0.003	0.2116	202.87	1.14	2.62	0.08	3.468
172	8-1/4	X	8-7/16	X	3/32	8.237	0.050	0.103	0.003	0.2181	209.22	1.27	2.62	0.08	3.575
173	8-1/2	X	8-11/16	X	3/32	8.487	0.050	0.103	0.003	0.2247	215.57	1.27	2.62	0.08	3.683
174	8-3/4	X	8-15/16	X	3/32	8.737	0.050	0.103	0.003	0.2312	221.92	1.27	2.62	0.08	3.789
175	9	X	9-3/16	X	3/32	8.987	0.050	0.103	0.003	0.2377	228.27	1.27	2.62	0.08	3.896
176	9-1/4	X	9-7/16	X	3/32	9.237	0.055	0.103	0.003	0.2443	234.62	1.4	2.62	0.08	4.004
177	9-1/2	X	9-11/16	X	3/32	9.487	0.055	0.103	0.003	0.2508	240.97	1.4	2.62	0.08	4.111
178	9-3/4	X	9-15/16	X	3/32	9.737	0.055	0.103	0.003	0.2574	247.32	1.4	2.62	0.08	4.219
201	3/16	X	7/16	X	1/8	0.171	0.007	0.139	0.004	0.0148	4.34	0.18	3.53	0.10	0.242
202	1/4	X	1/2	X	1/8	0.234	0.007	0.139	0.004	0.0178	5.94	0.18	3.53	0.10	0.291
203	5/16	X	9/16	X	1/8	0.296	0.007	0.139	0.004	0.0207	7.52	0.18	3.53	0.10	0.340
204	3/8	X	5/8	X	1/8	0.359	0.007	0.139	0.004	0.0237	9.12	0.18	3.53	0.10	0.389
205	7/16	X	11/16	X	1/8	0.421	0.007	0.139	0.004	0.0267	10.69	0.18	3.53	0.10	0.437
206	1/2	X	3/4	X	1/8	0.484	0.007	0.139	0.004	0.0297	12.29	0.18	3.53	0.10	0.486
207	9/16	X	1-13/16	X	1/8	0.546	0.007	0.139	0.004	0.0327	13.87	0.18	3.53	0.10	0.535
208	5/8	X	7/8	X	1/8	0.609	0.009	0.139	0.004	0.0357	15.47	0.23	3.53	0.10	0.584
209	11/16	X	15/16	X	1/8	0.671	0.009	0.139	0.004	0.0386	17.04	0.23	3.53	0.10	0.632
210	3/4	X	1	X	1/8	0.734	0.010	0.139	0.004	0.0418	18.66	0.25	3.53	0.10	0.682
211	13/16	X	1-1/16	X	1/8	0.796	0.010	0.139	0.004	0.0446	20.22	0.25	3.53	0.10	0.731
212	7/8	X	1-1/8	X	1/8	0.859	0.010	0.139	0.004	0.0476	21.82	0.25	3.53	0.10	0.780
213	15/16	X	1-3/16	X	1/8	0.921	0.010	0.139	0.004	0.0505	23.40	0.25	3.53	0.10	0.828
214	1	X	1-1/4	X	1/8	0.984	0.010	0.139	0.004	0.0535	25.00	0.25	3.53	0.10	0.877
215	1-1/16	X	1-5/16	X	1/8	1.046	0.010	0.139	0.004	0.0565	26.58	0.25	3.53	0.10	0.926
216	1-1/8	X	1-3/8	X	1/8	1.109	0.012	0.139	0.004	0.0595	28.17	0.3	3.53	0.10	0.975
217	1-3/16	X	1-7/16	X	1/8	1.171	0.012	0.139	0.004	0.0624	29.75	0.3	3.53	0.10	1.023
218	1-1/4	X	1-1/2	X	1/8	1.234	0.012	0.139	0.004	0.0656	31.35	0.3	3.53	0.10	1.075
219	1-5/16	X	1-9/16	X	1/8	1.296	0.012	0.139	0.004	0.0684	32.92	0.3	3.53	0.10	1.121
220	1-3/8	X	1-5/8	X	1/8	1.359	0.012	0.139	0.004	0.0714	34.52	0.3	3.53	0.10	1.170
221	1-7/16	X	1-11/16	X	1/8	1.421	0.012	0.139	0.004	0.0744	36.09	0.3	3.53	0.10	1.219
222	1-1/2	X	1-3/4	X	1/8	1.484	0.015	0.139	0.004	0.0774	37.70	0.38	3.53	0.10	1.264
223	1-5/8	X	1-7/8	X	1/8	1.609	0.015	0.139	0.004	0.0833	40.87	0.38	3.53	0.10	1.365

## O-Ring Size Chart for Inch Seals

Hercules Size No.	Nominal Size				Inch Standard					Metric Standard					
					Inside Diameter		Cross Section		Basic Volume cu in.	Inside Diameter		Cross Section		Basic Volume cu. cm	
	ID	OD	CS	in.	+/-	in.	+/-	mm		+/-	mm	+/-			
224	1-3/4	X	2	X	1/8	1.734	0.015	0.139	0.004	0.0893	44.04	0.38	3.53	0.10	1.464
225	1-7/8	X	2-1/8	X	1/8	1.859	0.018	0.139	0.004	0.0952	47.22	0.46	3.53	0.10	1.560
226	2	X	2-1/4	X	1/8	1.984	0.018	0.139	0.004	0.1012	50.39	0.46	3.53	0.10	1.659
227	2-1/8	X	2-3/8	X	1/8	2.109	0.018	0.139	0.004	0.1072	53.57	0.46	3.53	0.10	1.759
228	2-1/4	X	2-1/2	X	1/8	2.234	0.020	0.139	0.004	0.1131	56.74	0.51	3.53	0.10	1.854
229	2-3/8	X	2-5/8	X	1/8	2.359	0.020	0.139	0.004	0.1191	59.92	0.51	3.53	0.10	1.952
230	2-1/2	X	2-3/4	X	1/8	2.484	0.020	0.139	0.004	0.1250	63.09	0.51	3.53	0.10	2.049
231	2-5/8	X	2-7/8	X	1/8	2.609	0.020	0.139	0.004	0.1310	66.27	0.51	3.53	0.10	2.147
232	2-3/4	X	3	X	1/8	2.734	0.024	0.139	0.004	0.1370	69.44	0.61	3.53	0.10	2.245
233	2-7/8	X	3-1/8	X	1/8	2.859	0.024	0.139	0.004	0.1429	72.62	0.61	3.53	0.10	2.342
234	3	X	3-1/4	X	1/8	2.984	0.024	0.139	0.004	0.1489	75.79	0.61	3.53	0.10	2.440
235	3-1/8	X	3-3/8	X	1/8	3.109	0.024	0.139	0.004	0.1548	78.97	0.61	3.53	0.10	2.537
236	3-1/4	X	3-1/2	X	1/8	3.234	0.024	0.139	0.004	0.1608	82.14	0.61	3.53	0.10	2.636
237	3-3/8	X	3-5/8	X	1/8	3.359	0.024	0.139	0.004	0.1668	85.32	0.61	3.53	0.10	2.734
238	3-1/2	X	3-3/4	X	1/8	3.484	0.024	0.139	0.004	0.1727	88.49	0.61	3.53	0.10	2.831
239	3-5/8	X	3-7/8	X	1/8	3.609	0.028	0.139	0.004	0.1787	91.67	0.71	3.53	0.10	2.929
240	3-3/4	X	4	X	1/8	3.734	0.028	0.139	0.004	0.1846	94.84	0.71	3.53	0.10	3.026
241	3-7/8	X	4-1/8	X	1/8	3.859	0.028	0.139	0.004	0.1906	96.02	0.71	3.53	0.10	3.124
242	4	X	4-1/4	X	1/8	3.984	0.028	0.139	0.004	0.1966	101.19	0.71	3.53	0.10	3.222
243	4-1/8	X	4-3/8	X	1/8	4.109	0.028	0.139	0.004	0.2025	104.37	0.71	3.53	0.10	3.319
244	4-1/4	X	4-1/2	X	1/8	4.234	0.030	0.139	0.004	0.2085	107.54	0.76	3.53	0.10	3.417
245	4-3/8	X	4-5/8	X	1/8	4.359	0.030	0.139	0.004	0.2144	110.72	0.76	3.53	0.10	3.514
246	4-1/2	X	4-3/4	X	1/8	4.484	0.030	0.139	0.004	0.2204	113.89	0.76	3.53	0.10	3.612
247	4-5/8	X	4-7/8	X	1/8	4.609	0.030	0.139	0.004	0.2264	117.07	0.76	3.53	0.10	3.711
248	4-3/4	X	5	X	1/8	4.734	0.030	0.139	0.004	0.2323	120.24	0.76	3.53	0.10	3.807
249	4-7/8	X	5-1/8	X	1/8	4.859	0.035	0.139	0.004	0.2383	123.42	0.89	3.53	0.10	3.906
250	5	X	5-1/4	X	1/8	4.984	0.035	0.139	0.004	0.2442	126.59	0.89	3.53	0.10	4.002
251	5-1/8	X	5-3/8	X	1/8	5.109	0.035	0.139	0.004	0.2502	129.77	0.89	3.53	0.10	4.101
252	5-1/4	X	5-1/2	X	1/8	5.234	0.035	0.139	0.004	0.2561	132.94	0.89	3.53	0.10	4.197
253	5-3/8	X	5-5/8	X	1/8	5.359	0.035	0.139	0.004	0.2621	136.12	0.89	3.53	0.10	4.296
254	5-1/2	X	5-3/4	X	1/8	5.484	0.035	0.139	0.004	0.2681	139.29	0.89	3.53	0.10	4.394
255	5-5/8	X	5-7/8	X	1/8	5.609	0.035	0.139	0.004	0.2740	142.47	0.89	3.53	0.10	4.491
256	5-3/4	X	6	X	1/8	5.734	0.035	0.139	0.004	0.2800	145.64	0.89	3.53	0.10	4.589
257	5-7/8	X	6-1/8	X	1/8	5.859	0.035	0.139	0.004	0.2859	148.82	0.89	3.53	0.10	4.686
258	6	X	6-1/4	X	1/8	5.984	0.035	0.139	0.004	0.2919	151.99	0.89	3.53	0.10	4.784
259	6-1/4	X	6-1/2	X	1/8	6.234	0.040	0.139	0.004	0.3039	158.34	1.02	3.53	0.10	4.979
260	6-1/2	X	6-3/4	X	1/8	6.484	0.040	0.139	0.004	0.3157	164.69	1.02	3.53	0.10	5.174
261	6-3/4	X	7	X	1/8	6.734	0.040	0.139	0.004	0.3276	171.04	1.02	3.53	0.10	5.389
262	7	X	7-1/4	X	1/8	6.984	0.040	0.139	0.004	0.3396	177.39	1.02	3.53	0.10	5.566
263	7-1/4	X	7-1/2	X	1/8	7.234	0.045	0.139	0.004	0.3515	183.74	1.14	3.53	0.10	5.761
264	7-1/2	X	7-3/4	X	1/8	7.484	0.045	0.139	0.004	0.3634	190.09	1.14	3.53	0.10	5.956
265	7-3/4	X	8	X	1/8	7.734	0.045	0.139	0.004	0.3754	196.44	1.14	3.53	0.10	6.151
266	8	X	8-1/4	X	1/8	7.984	0.045	0.139	0.004	0.3872	202.79	1.14	3.53	0.10	6.345
267	8-1/4	X	8-1/2	X	1/8	8.234	0.050	0.139	0.004	0.3992	209.14	1.27	3.53	0.10	6.543
268	8-1/2	X	8-3/4	X	1/8	8.484	0.050	0.139	0.004	0.4111	215.49	1.27	3.53	0.10	6.738
269	8-3/4	X	9	X	1/8	8.734	0.050	0.139	0.004	0.4230	221.84	1.27	3.53	0.10	6.933
270	9	X	9-1/4	X	1/8	8.984	0.050	0.139	0.004	0.4349	228.19	1.27	3.53	0.10	7.128
271	9-1/4	X	9-1/2	X	1/8	9.234	0.055	0.139	0.004	0.4468	234.54	1.4	3.53	0.10	7.323
272	9-1/2	X	9-3/4	X	1/8	9.484	0.055	0.139	0.004	0.4588	240.89	1.4	3.53	0.10	7.520
273	9-3/4	X	10	X	1/8	9.734	0.055	0.139	0.004	0.4707	247.24	1.4	3.53	0.10	7.715

## O-Ring Size Chart for Inch Seals

Hercules Size No.	Nominal Size			Inch Standard					Metric Standard						
				Inside Diameter		Cross Section		Basic Volume cu in.	Inside Diameter		Cross Section		Basic Volume cu. cm		
				in.	+/-	in.	+/-		mm	+/-	mm	+/-			
ID	OD	CS													
274	10	x	10-1/4	x	1/8	9.984	.055	.139	.004	.4826	253.59	1.40	3.53	0.10	7.910
275	10-1/2	X	10-3/4	X	1/8	10.484	.055	.139	.004	.5064	266.29	1.40	3.53	0.10	8.300
276	11	X	11-1/4	X	1/8	10.994	.065	.139	.004	.5303	278.99	1.65	3.53	0.10	8.692
277	11-1/2	X	11-3/4	X	1/8	11.484	.065	.139	.004	.5541	291.69	1.65	3.53	0.10	9.082
278	12	X	12-1/4	X	1/8	11.984	.065	.139	.004	.5779	304.39	1.65	3.53	0.10	9.472
279	13	X	13-1/4	X	1/8	12.984	.065	.139	.004	.6256	329.79	1.65	3.53	0.10	10.254
280	14	X	14-1/4	X	1/8	13.984	.065	.139	.004	.6773	355.19	1.65	3.53	0.10	11.101
281	15	X	15-1/4	X	1/8	14.984	.065	.139	.004	.7210	380.59	1.65	3.53	0.10	11.817
282	16	X	16-1/4	X	1/8	15.955	.075	.139	.004	.7678	405.26	1.90	3.53	0.10	12.581
283	17	X	17-1/4	X	1/8	16.955	.080	.139	.004	.8155	430.66	2.16	3.53	0.10	13.366
284	18	X	18-1/4	X	1/8	17.955	.085	.139	.004	.8627	458.06	2.42	3.53	0.10	14.140
309	7/16	X	13/16	X	3/16	.412	.005	.210	.005	.0677	10.46	0.13	5.33	0.13	1.107
310	1/2	X	7/8	X	3/16	.475	.005	.210	.005	.0745	12.07	0.13	5.33	0.13	1.219
311	9/16	X	15/16	X	3/16	.537	.007	.210	.005	.0813	13.64	0.18	5.33	0.13	1.330
312	5/8	X	1	X	3/16	.600	.009	.210	.005	.0881	15.24	0.23	5.33	0.13	1.442
313	11/16	X	1-1/16	X	3/16	.682	.009	.210	.005	.0949	16.81	0.23	5.33	0.13	1.552
314	3/4	X	1-1/8	X	3/16	.725	.010	.210	.005	.1017	18.42	0.25	5.33	0.13	1.665
315	13/16	X	1-3/16	X	3/16	.787	.010	.210	.005	.1085	19.99	0.25	5.33	0.13	1.775
316	7/8	X	1-1/4	X	3/16	.850	.010	.210	.005	.1153	21.59	0.25	5.33	0.13	1.887
317	15/16	X	1-5/16	X	3/16	.912	.010	.210	.005	.1221	23.16	0.25	5.33	0.13	1.997
318	1	X	1-3/8	X	3/16	.975	.010	.210	.005	.1289	24.77	0.25	5.33	0.13	2.109
319	1-1/16	X	1-7/16	X	3/16	1.037	.010	.210	.005	.1357	26.34	0.25	5.33	0.13	2.220
320	1-1/8	X	1-1/2	X	3/16	1.100	.012	.210	.005	.1425	27.94	0.30	5.33	0.13	2.332
321	1-3/16	X	1-9/16	X	3/16	1.162	.012	.210	.005	.1493	29.51	0.30	5.33	0.13	2.442
322	1-1/4	X	1-5/8	X	3/16	1.225	.012	.210	.005	.1561	31.12	0.30	5.33	0.13	2.555
323	1-5/16	X	1-11/16	X	3/16	1.287	.012	.210	.005	.1629	32.69	0.30	5.33	0.13	2.655
324	1-3/8	X	1-3/4	X	3/16	1.350	.012	.210	.005	.1697	34.29	0.30	5.33	0.13	2.777
325	1-1/2	X	1-7/8	X	3/16	1.475	.015	.210	.005	.1833	37.47	0.38	5.33	0.13	3.004
326	1-5/8	X	2	X	3/16	1.600	.015	.210	.005	.1970	40.64	0.38	5.33	0.13	3.229
327	1-3/4	X	2-1/8	X	3/16	1.725	.015	.210	.005	.2106	43.82	0.38	5.33	0.13	3.452
328	1-7/8	X	2-1/4	X	3/16	1.850	.015	.210	.005	.2242	46.99	0.38	5.33	0.13	3.675
329	2	X	2-3/8	X	3/16	1.975	.018	.210	.005	.2378	50.17	0.46	5.33	0.13	3.898
330	2-1/8	X	2-1/2	X	3/16	2.100	.018	.210	.005	.2514	53.34	0.46	5.33	0.13	4.120
331	2-1/4	X	2-5/8	X	3/16	2.225	.018	.210	.005	.2650	56.52	0.46	5.33	0.13	4.343
332	2-3/8	X	2-3/4	X	3/16	2.350	.018	.210	.005	.2786	59.69	0.46	5.33	0.13	4.566
333	2-1/2	X	2-7/8	X	3/16	2.475	.020	.210	.005	.2922	62.87	0.51	5.33	0.13	4.789
334	2-5/8	X	3	X	3/16	2.600	.020	.210	.005	.3058	66.04	0.51	5.33	0.13	5.012
335	2-3/4	X	3-1/8	X	3/16	2.725	.020	.210	.005	.3194	69.22	.051	5.33	0.13	5.235
336	2-7/8	X	3-1/4	X	3/16	2.850	.020	.210	.005	.3330	72.39	0.51	5.33	0.13	5.458
337	3	X	3-3/8	X	3/16	2.975	.024	.210	.005	.3466	75.57	0.61	5.33	0.13	5.681
338	3-1/8	X	3-1/2	X	3/16	3.100	.024	.210	.005	.3602	78.74	.061	5.33	0.13	5.904
339	3-1/4	X	3-5/8	X	3/16	3.225	.024	.210	.005	.3738	81.92	0.61	5.33	0.13	6.127
340	3-3/8	X	3-3/4	X	3/16	3.350	.024	.210	.005	.3874	85.09	0.61	5.33	0.13	6.349
341	3-1/2	X	3-7/8	X	3/16	3.475	.024	.210	.005	.4010	88.27	0.61	5.33	0.13	6.572
342	3-5/8	X	4	X	3/16	3.600	.028	.210	.005	.4146	91.44	0.71	5.33	0.13	6.795
343	3-3/4	X	4-1/8	X	3/16	3.725	.028	.210	.005	.4282	94.62	0.71	5.33	0.13	7.018
344	3-7/8	X	4-1/4	X	3/16	3.850	.028	.210	.005	.4418	97.79	0.71	5.33	0.13	7.241
345	4	X	4-3/8	X	3/16	3.975	.028	.210	.005	.4554	100.97	0.71	5.33	0.13	7.464

## O-Ring Size Chart for Inch Seals

Hercules Size No.	Nominal Size			Inch Standard					Metric Standard						
				Inside Diameter		Cross Section		Basic Volume cu in.	Inside Diameter		Cross Section		Basic Volume cu. cm		
				ID	OD	CS	in.		+/-	in.	+/-	mm		+/-	mm
347	4-1/4	X	4-5/8	X	3/16	4.225	.030	.210	.005	.4826	107.32	0.76	5.33	0.13	7.910
348	4-3/8	X	4-3/4	X	3/16	4.350	.030	.210	.005	.4962	110.49	0.76	5.33	0.13	8.133
349	4-1/2	X	4-7/8	X	3/16	4.475	.030	.210	.005	.5098	113.67	0.76	5.33	0.13	8.358
350	4-5/8	X	5	X	3/16	4.600	.030	.210	.005	.5243	116.84	0.76	5.33	0.13	8.593
351	4-3/4	X	5-1/8	X	3/16	4.725	.030	.210	.005	.5379	120.02	0.76	5.33	0.13	8.816
352	4-7/8	X	5-1/4	X	3/16	4.850	.030	.210	.005	.5515	123.19	0.76	5.33	0.13	9.039
353	5	X	5-3/8	X	3/16	4.975	.037	.210	.005	.5652	126.37	0.94	5.33	0.13	9.264
354	5-1/8	X	5-1/2	X	3/16	5.100	.037	.210	.005	.5788	129.54	0.94	5.33	0.13	9.487
355	5-1/4	X	5-5/8	X	3/16	5.225	.037	.210	.005	.5824	132.72	0.94	5.33	0.13	9.709
356	5-3/8	X	5-3/4	X	3/16	5.350	.037	.210	.005	.6060	135.89	0.94	5.33	0.13	9.932
357	5-1/2	X	5-7/8	X	3/16	5.475	.037	.210	.005	.6197	139.07	0.94	5.33	0.13	10.157
358	5-5/8	X	6	X	3/16	5.600	.037	.210	.005	.6333	142.24	0.94	5.33	0.13	10.380
359	5-3/4	X	6-1/8	X	3/16	5.725	.037	.210	.005	.6469	145.42	0.94	5.33	0.13	10.603
360	5-7/8	X	6-1/4	X	3/16	5.850	.037	.210	.005	.6605	148.49	0.94	5.33	0.13	10.826
361	6	X	6-3/8	X	3/16	5.975	.037	.210	.005	.6742	151.77	.094	5.33	0.13	11.050
362	6-1/4	X	6-5/8	X	3/16	6.225	.040	.210	.005	.7014	158.12	1.02	5.33	0.13	11.496
363	6-1/2	X	6-7/8	X	3/16	6.475	.040	.210	.005	.7287	164.47	1.02	5.33	0.13	11.943
364	6-3/4	X	7-1/8	X	3/16	6.725	.040	.210	.005	.7559	170.82	1.02	5.33	0.13	12.389
365	7	X	7-3/8	X	3/16	6.975	.040	.210	.005	.7832	177.17	1.02	5.33	0.13	12.837
366	7-1/4	X	7-5/8	X	3/16	7.225	.045	.210	.005	.8104	183.52	1.14	5.33	0.13	13.282
367	7-1/2	X	7-7/8	X	3/16	7.475	.045	.210	.005	.8379	189.87	1.14	5.33	0.13	13.733
368	7-3/4	X	8-1/8	X	3/16	7.725	.045	.210	.005	.8649	196.22	1.14	5.33	0.13	14.176
369	8	X	8-3/8	X	3/16	7.975	.045	.210	.005	.8922	202.57	1.14	5.33	0.13	14.823
370	8-1/4	X	8-5/8	X	3/16	8.225	.050	.210	.005	.9194	208.92	1.30	5.33	0.13	15.069
371	8-1/2	X	8-7/8	X	3/16	8.475	.050	.210	.005	.9467	215.27	1.30	5.33	0.13	15.516
372	8-3/4	X	9-1/8	X	3/16	8.725	.050	.210	.005	.9739	221.62	1.30	5.33	0.13	15.902
373	9	X	9-3/8	X	3/16	8.975	.050	.210	.005	1.0011	227.97	1.30	5.33	0.13	16.408
374	9-1/4	X	9-5/8	X	3/16	9.225	.055	.210	.005	1.0284	234.92	1.40	5.33	0.13	16.855
375	9-1/2	X	9-7/8	X	3/16	9.475	.055	.210	.005	1.0557	240.67	1.40	5.33	0.13	17.303
376	9-3/4	X	10-1/8	X	3/16	9.725	.055	.210	.005	1.0829	247.02	1.40	5.33	0.13	17.749
377	10	X	10-3/8	X	3/16	9.975	.055	.210	.005	1.1102	253.37	1.40	5.33	0.13	18.196
378	10-1/2	X	10-7/8	X	3/16	10.475	.060	.210	.005	1.1647	266.07	1.52	5.33	0.13	19.089
379	11	X	11-3/8	X	3/16	10.975	.060	.210	.005	1.2192	278.77	1.52	5.33	0.13	19.963
380	11-1/2	X	11-7/8	X	3/16	11.475	.065	.210	.005	1.2737	291.47	1.65	5.33	0.13	20.876
381	12	X	12-3/8	X	3/16	11.975	.065	.210	.005	1.3282	304.17	1.65	5.33	0.13	21.769
382	13	X	13-3/8	X	3/16	12.975	.065	.210	.005	1.4372	329.57	1.65	5.33	0.13	23.556
363	14	X	14-3/8	X	3/16	13.975	.070	.210	.005	1.5462	354.97	1.78	5.33	0.13	25.342
384	15	X	15-3/8	X	3/16	14.975	.070	.210	.005	1.6552	380.37	1.78	5.33	0.13	27.129
385	16	X	16-3/8	X	3/16	15.955	.075	.210	.005	1.7620	405.26	1.90	5.33	0.13	28.879
386	17	X	17-3/8	X	3/16	16.955	.080	.210	.005	1.8710	430.66	2.03	5.33	0.13	30.666
387	18	X	18-3/8	X	3/16	17.955	.085	.210	.005	1.9800	456.06	2.16	5.33	0.13	32.452
388	19	X	19-3/8	X	3/16	18.955	.090	.210	.005	2.0890	481.38	2.29	5.33	0.13	34.239
389	20	X	20-3/8	X	3/16	19.955	.095	.210	.005	2.1980	506.78	2.41	5.33	0.13	36.025
390	21	X	21-3/8	X	3/16	20.955	.095	.210	.005	2.3070	532.18	2.41	5.33	0.13	37.812
391	22	X	22-3/8	X	3/16	21.955	.100	.210	.005	2.4160	557.58	2.55	5.33	0.13	39.598
392	23	X	23-3/8	X	3/16	22.940	.105	.210	.005	2.5234	582.68	2.75	5.33	0.13	41.359
393	24	X	24-3/8	X	3/16	23.940	.110	.210	.005	2.6324	608.08	2.80	5.33	0.13	43.145
394	25	X	25-3/8	X	3/16	24.940	.115	.210	.005	2.7414	633.48	2.90	5.33	0.13	44.932
395	26	X	26-3/8	X	3/16	25.940	.120	.210	.005	2.8504	658.88	3.05	5.33	0.13	46.718

## O-Ring Size Chart for Inch Seals

Hercules Size No.	Nominal Size			Inch Standard					Metric Standard				
				Inside Diameter		Cross Section		Basic Volume cu in.	Inside Diameter		Cross Section		Basic Volume cu. cm
				in.	+/-	in.	+/-		mm	+/-	mm	+/-	
ID	OD	CS											
425	4-1/2 X	5 X	1/4	4.475	.033	.275	.006	.8863	113.67	0.84	6.99	0.15	14.526
426	4-5/8 X	5-1/8 X	1/4	4.600	.033	.275	.006	.9097	116.84	0.84	6.99	0.15	14.910
427	4-3/4 X	5-1/4 X	1/4	4.725	.033	.275	.006	.9330	120.02	0.84	6.99	0.15	15.292
428	4-7/8 X	5-3/8 X	1/4	4.850	.033	.275	.006	.9563	123.19	0.84	6.99	0.15	15.674
429	5 X	5-1/2 X	1/4	4.975	.037	.275	.006	.9796	126.37	0.94	6.99	0.15	16.056
430	5-1/8 X	5-5/8 X	1/4	5.100	.037	.275	.006	1.0030	129.54	0.94	6.99	0.15	16.439
431	5-1/4 X	5-3/4 X	1/4	5.225	.037	.275	.006	1.0263	132.72	0.94	6.99	0.15	16.821
432	5-3/8 X	5-7/8 X	1/4	5.350	.037	.275	.006	1.0496	135.89	0.94	6.99	0.15	17.203
433	5-1/2 X	6 X	1/4	5.475	.037	.275	.006	1.0729	139.07	0.84	6.99	0.15	17.585
434	5-5/8 X	6-1/8 X	1/4	5.600	.037	.275	.006	1.0962	142.24	0.94	6.99	0.15	17.967
435	5-3/4 X	6-1/4 X	1/4	5.725	.037	.275	.006	1.1196	145.42	0.94	6.99	0.15	18.350
436	5-7/8 X	6-3/8 X	1/4	5.850	.037	.275	.006	1.1429	148.59	0.94	6.99	0.15	18.732
437	6 X	6-1/2 X	1/4	5.975	.037	.275	.006	1.1662	151.77	0.94	6.99	0.15	19.114
438	6-1/4 X	6-3/4 X	1/4	6.225	.040	.275	.006	1.2129	158.12	1.02	6.99	0.15	19.879
439	6-1/2 X	7 X	1/4	6.475	.040	.275	.006	1.2595	164.47	1.02	6.99	0.15	20.643
440	6-3/4 X	7-1/4 X	1/4	6.725	.040	.275	.006	1.3062	170.82	1.02	6.99	0.15	21.409
441	7 X	7-1/2 X	1/4	6.975	.040	.275	.006	1.3528	177.17	1.02	6.99	0.15	22.172
442	7-1/4 X	7-3/4 X	1/4	7.225	.045	.275	.006	1.3995	183.52	1.14	6.99	0.15	22.938
443	7-1/2 X	8 X	1/4	7.475	.045	.275	.006	1.4461	189.87	1.14	6.99	0.15	23.702
444	7-3/4 X	8-1/4 X	1/4	7.725	.045	.275	.006	1.4928	196.22	1.14	6.99	0.15	24.467
445	8 X	8-1/2 X	1/4	7.975	.045	.275	.006	1.5394	202.57	1.14	6.99	0.15	25.231
446	8-1/2 X	9 X	1/4	8.475	.055	.275	.006	1.6327	215.27	1.40	6.99	0.15	26.760
447	9 X	9-1/2 X	1/4	8.975	.055	.275	.006	1.7260	227.97	1.40	6.99	0.15	28.289
448	9-1/2 X	10 X	1/4	9.475	.055	.275	.006	1.8193	240.67	1.40	6.99	0.15	29.818
449	10 X	10-1/2 X	1/4	9.975	.055	.275	.006	1.9126	253.37	1.40	6.99	0.15	31.348
450	10-1/2 X	11 X	1/4	10.475	.060	.275	.006	2.0059	266.07	1.52	6.99	0.15	32.877
451	11 X	11-1/2 X	1/4	10.975	.060	.275	.006	2.0992	278.77	1.52	6.99	0.15	34.406
452	11-1/2 X	12 X	1/4	11.475	.060	.275	.006	2.1925	291.47	1.52	6.99	0.15	35.935
453	12 X	12-1/2 X	1/4	11.975	.060	.275	.006	2.2858	304.17	1.52	6.99	0.15	37.464
454	12-1/2 X	13 X	1/4	12.475	.060	.275	.006	2.3791	316.87	1.52	6.99	0.15	38.993
455	13 X	13-1/2 X	1/4	12.975	.060	.275	.006	2.4724	329.57	1.52	6.99	0.15	40.523
456	13-1/2 X	14 X	1/4	13.475	.070	.275	.006	2.5657	342.27	1.78	6.99	0.15	42.052
457	14 X	14-1/2 X	1/4	13.975	.070	.275	.006	2.6590	354.97	1.78	6.99	0.15	43.581
458	14-1/2 X	15 X	1/4	14.475	.070	.275	.006	2.7523	367.67	1.78	6.99	0.15	45.110
459	15 X	15-1/2 X	1/4	14.975	.070	.275	.006	2.8456	380.37	1.78	6.99	0.15	46.639
460	15-1/2 X	16 X	1/4	15.475	.070	.275	.006	2.9389	393.07	1.78	6.99	0.15	48.169
461	16 X	16-1/2 X	1/4	15.955	.075	.275	.006	3.0350	405.28	1.90	6.99	0.15	49.744
462	16-1/2 X	17 X	1/4	16.455	.075	.275	.006	3.1285	417.96	1.90	6.99	0.15	51.276
463	17 X	17-1/2 X	1/4	16.955	.080	.275	.006	3.2220	430.66	2.05	6.99	0.15	52.809
464	17-1/2 X	18 X	1/4	17.455	.085	.275	.006	3.3155	443.36	2.15	6.99	0.15	54.341
485	18 X	18-1/2 X	1/4	17.955	.085	.275	.006	3.4090	456.06	2.15	6.99	0.15	55.874
486	18-1/2 X	19 X	1/4	18.455	.085	.275	.006	3.5025	468.76	2.15	6.99	0.15	57.406
487	19 X	19-1/2 X	1/4	18.955	.090	.275	.006	3.5960	481.46	2.29	6.99	0.15	58.938
468	19-1/2 X	20 X	1/4	19.455	.090	.275	.006	3.6895	494.16	2.29	6.99	0.15	60.471
469	20 X	20-1/2 X	1/4	19.955	.095	.275	.006	3.7830	506.86	2.41	6.99	0.15	62.003
470	21 X	21-1/2 X	1/4	20.955	.095	.275	.006	3.9700	532.26	2.41	6.99	0.15	65.068
471	22 X	22-1/2 X	1/4	21.955	.100	.275	.006	4.1570	557.66	2.55	6.99	0.15	68.133
472	23 X	23-1/2 X	1/4	22.940	.105	.275	.006	4.3412	582.68	2.65	6.99	0.15	71.152
473	24 X	24-1/2 X	1/4	23.940	.110	.275	.006	4.5282	608.08	2.80	6.99	0.15	74.217
474	25 X	25-1/2 X	1/4	24.940	.115	.275	.006	4.7152	633.48	2.90	6.99	0.15	77.282
475	26 X	26-1/2 X	1/4	25.940	.120	.275	.006	4.9022	658.88	3.05	6.99	.015	80.347

## O-Ring Size Chart for Straight Thread Tube Fittings

Hercules Size No.	Tube Size		Inside Diameter		Inside Diameter		Cross-Section Standard			
							Inch		Metric	
							Dash No.	OD in.	Class in.	II +/-
901	1	3/32	.185	.006	4.70	.15	.056	.003	1.42	.08
902	2	1/8	.239	.007	6.07	.18	.064	.003	1.63	.08
903	3	3/16	.301	.007	7.65	.18	.064	.003	1.63	.08
904	4	1/4	.351	.007	8.92	.18	.072	.003	1.83	.08
905	5	5/16	.414	.007	10.52	.18	.072	.003	1.83	.08
906	6	3/8	.468	.007	11.89	.18	.078	.003	1.98	.08
907	7	7/16	.530	.007	13.46	.18	.082	.003	2.08	.08
908	8	1/2	.644	.009	16.36	.23	.087	.003	2.20	.08
909	9	9/16	.706	.009	17.93	.23	.097	.003	2.46	.08
910	10	5/8	.755	.009	19.18	.23	.097	.003	2.46	.08
911	11	11/16	.863	.009	21.92	.23	.116	.004	2.95	.10
912	12	3/4	.924	.009	23.47	.23	.116	.004	2.95	.10
913	13	13/16	.966	.010	25.04	.25	.116	.004	2.95	.10
914	14	7/8	1.048	.010	26.62	.25	.116	.004	2.95	.10
916	16	1	1.171	.010	29.74	.25	.116	.004	2.95	.10
918	18	1-1/8	1.355	.012	34.42	.30	.116	.004	2.95	.10
920	20	1-1/4	1.475	.014	37.47	.36	.118	.004	3.00	.10
924	24	1-1/2	1.720	.014	43.69	.36	.118	.004	3.00	.10
928	28	1-3/4	2.090	.018	53.09	.46	.118	.004	3.00	.10
932	32		2.337	.018	59.36	.46	.118	.004	3.00	.10

## O-Ring Size Chart for Metric Seals

JIS B 2401		WIDTH		I.D.		JIS B 2401		WIDTH		I.D.		JIS B 2401		WIDTH		I.D.	
P - 3				2.8	±0.14	P - 71				70.6	±0.62	G - 25				24.4	±0.25
P - 4				3.8	±0.14	P - 75				74.6	±0.65	G - 30				29.4	±0.29
P - 5				4.8	±0.15	P - 80				79.6	±0.69	G - 35				34.4	±0.33
P - 6				5.8	±0.15	P - 85				84.6	±0.73	G - 40				39.4	±0.37
P - 7	1.9	±0.08		6.8	±0.16	P - 90				89.6	±0.77	G - 45				44.4	±0.41
P - 8				7.8	±0.16	P - 95				94.6	±0.81	G - 50				49.4	±0.45
P - 9				8.8	±0.17	P - 100				99.6	±0.84	G - 55				54.4	±0.49
P - 10				9.8	±0.17	P - 102				101.6	±0.85	G - 60				59.4	±0.53
						P - 105				104.6	±0.87	G - 65				64.4	±0.57
P - 10A				9.8	±0.17	P - 110	5.7	±0.13		109.6	±0.91	G - 70				69.4	±0.61
P - 11				10.8	±0.18	P - 112				111.6	±0.92	G - 75				74.4	±0.65
P - 11.2				11.0	±0.18	P - 115				114.6	±0.94	G - 80				79.4	±0.69
P - 12				11.8	±0.19	P - 120				119.6	±0.98	G - 85	3.1	±0.1		84.4	±0.73
P - 12.5				12.3	±0.19	P - 125				124.6	±1.01	G - 90				89.4	±0.77
P - 14	2.4	±0.09		13.8	±0.19	P - 130				129.6	±1.05	G - 95				94.4	±0.81
P - 15				14.8	±0.20	P - 132				131.6	±1.06	G - 100				99.4	±0.85
P - 16				15.8	±0.20	P - 135				134.6	±1.09	G - 105				104.4	±0.87
P - 18				17.8	±0.21	P - 140				139.6	±1.12	G - 110				109.4	±0.91
P - 20				19.8	±0.22	P - 145				144.6	±1.16	G - 115				114.4	±0.94
P - 21				20.8	±0.23	P - 150				149.6	±1.19	G - 120				119.4	±0.98
P - 22				21.8	±0.24							G - 125				124.4	±1.01
						P - 150A				149.5	±1.19	G - 130				129.4	±1.05
P - 22A				21.7	±0.24	P - 155				154.5	±1.23	G - 135				134.4	±1.08
P - 22.4				22.1	±0.24	P - 160				159.5	±1.26	G - 140				139.4	±1.12
P - 24				23.7	±0.24	P - 165				164.5	±1.30	G - 145				144.4	±1.16
P - 25				24.7	±0.25	P - 170				169.5	±1.33						
P - 25.5				25.2	±0.25	P - 175				174.5	±1.37	G - 150				149.3	±1.19
P - 26				25.7	±0.26	P - 180				179.5	±1.40	G - 155				154.3	±1.23
P - 28				27.7	±0.28	P - 185				184.5	±1.44	G - 160				159.3	±1.26
P - 29				28.7	±0.29	P - 190				189.5	±1.48	G - 165				164.3	±1.30
P - 29.5				29.2	±0.29	P - 195				194.5	±1.51	G - 170				169.3	±1.33
P - 30				29.7	±0.29	P - 200				199.5	±1.55	G - 175				174.3	±1.37
P - 31				30.7	±0.30	P - 205				204.5	±1.58	G - 180				179.3	±1.40
P - 31.5				31.2	±0.31	P - 209				208.5	±1.61	G - 185				184.3	±1.44
P - 32	3.5	±0.10		31.7	±0.31	P - 210				209.5	±1.62	G - 190	5.7	±0.13		189.3	±1.47
P - 34				33.7	±0.33	P - 215				214.5	±1.65	G - 195				194.3	±1.51
P - 35				34.7	±0.34	P - 220				219.5	±1.68	G - 200				199.3	±1.55
P - 35.5				35.2	±0.34	P - 225				224.5	±1.71	G - 205				204.3	±1.58
P - 36				35.7	±0.34	P - 230				229.5	±1.75	G - 210				209.3	±1.61
P - 38				37.7	±0.37	P - 235				234.5	±1.78	G - 215				214.3	±1.64
P - 39				38.7	±0.37	P - 240	8.4	±0.15		239.5	±1.81	G - 220				219.3	±1.68
P - 40				39.7	±0.37	P - 245				244.5	±1.84	G - 225				224.3	±1.71
P - 41				40.7	±0.38	P - 250				249.5	±1.88	G - 230				229.3	±1.73
P - 42				41.7	±0.39	P - 255				254.5	±1.91	G - 235				234.3	±1.77
P - 44				43.7	±0.41	P - 260				259.5	±1.94	G - 240				239.3	±1.81
P - 45				44.7	±0.41	P - 265				264.5	±1.97	G - 245				244.3	±1.84
P - 46				45.7	±0.42	P - 270				269.5	±2.01	G - 250				249.3	±1.88
P - 48				47.7	±0.44	P - 275				274.5	±2.04	G - 255				254.3	±1.91
P - 49				48.7	±0.45	P - 280				279.5	±2.07	G - 260				259.3	±1.94
P - 50				49.7	±0.45	P - 285				284.5	±2.10	G - 265				264.3	±1.97
						P - 290				289.5	±2.14	G - 270				269.3	±2.01
P - 48A				47.6	±0.45	P - 295				294.5	±2.17	G - 275				274.3	±2.04
P - 50A				49.6	±0.45	P - 300				299.5	±2.20	G - 280				279.3	±2.07
P - 52				51.6	±0.47	P - 315				314.5	±2.30	G - 285				284.3	±2.10
P - 53				52.6	±0.48	P - 320				319.5	±2.33	G - 290				289.3	±2.14
P - 55				54.6	±0.49	P - 335				334.5	±2.42	G - 295				294.3	±2.17
P - 56				55.6	±0.50	P - 340				339.5	±2.45	G - 300				299.3	±2.20
P - 58	5.7	±1.13		57.6	±0.52	P - 355				354.5	±2.54	G - 305				304.3	±2.24
P - 62				59.6	±0.53	P - 360				359.5	±2.57	G - 310				309.3	±2.27
P - 63				61.6	±0.55	P - 375				374.5	±2.67	G - 315				314.3	±2.30
P - 65				62.6	±0.56	P - 385				384.5	±2.73	G - 320				319.3	±2.33
P - 67				64.6	±0.57	P - 400				399.5	±2.82	G - 325				324.3	±2.36
P - 70				66.6	±0.59							G - 330				329.3	±2.39
				69.6	±0.61												

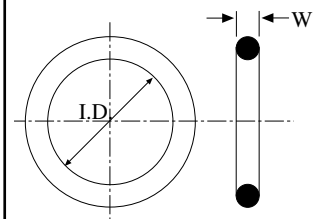

The JIS number indicates the Japanese Industrial Size. This o-ring size can be cross-referenced by finding the width and inside diameter on the chart provided.



## O-Ring Size Chart for Metric Seals

JIS B 2401	WIDTH	I.D.		SM - O RINGS	WIDTH	I.D.		KS-O RINGS	WIDTH	I.D.	
V - 15	4 ±0.10	14.5	±0.20	SM - 3	1.5±0.1	2.5	±0.15	KS - 1	1.70  ±0.08	2.75	±0.13
V - 24		23.5	±0.24	SM - 4		3.5	±0.15	KS - 2		3.75	±0.13
V - 34		33.5	±0.33	SM - 5		4.5	±0.15	KS - 3		4.75	±0.13
V - 40		39.5	±0.37	SM - 6		5.5	±0.15	KS - 4		5.75	±0.13
V - 55		54.5	±0.49	SM - 7		6.5	±0.15	KS - 5		6.75	±0.13
V - 70		69.0	±0.61	SM - 8		7.5	±0.15	KS - 6		7.75	±0.13
V - 85		84.0	±0.72	SM - 9		8.5	±0.15	KS - 7		8.75	±0.13
V - 100		99.0	±0.83	SM - 10		9.5	±0.15	KS - 8		9.75	±0.13
V - 120		119.0	±0.97	SM - 11.2		10.7	±0.15	2.25	9.70	±0.13	
V - 150		148.5	±1.18	SM - 12		11.5	±0.15		KS - 9	11.70	±0.13
V - 175	173.0	±1.36	SM - 12.5	12.0	±0.15	KS - 10	13.70		±0.13		
V - 225	6 ±0.15	222.5	±1.70	SM - 14	13.5	±0.15	KS - 11		15.70	±0.13	
V - 275		272.0	±2.02	SM - 15	14.5	±0.15	KS - 12		17.70	±0.13	
V - 325		321.5	±2.34	SM - 16	15.5	±0.15	KS - 13		19.70	±0.13	
V - 380		376.0	±2.68	SM - 18	17.5	±0.15	3.30 ±0.10	19.60	±0.15		
V - 430		425.5	±2.99	SM - 20	19.5	±0.15		KS - 15	21.60	±0.15	
V - 480	10 ±0.30	475.0	±3.30	SM - 22	2.0±0.1	21.9	±0.15	KS - 16	23.60	±0.15	
V - 530		524.5	±3.60	SM - 24		23.5	±0.15	KS - 17	24.60	±0.15	
V - 585		579.0	±3.92	SM - 25		24.5	±0.15	KS - 18	25.60	±0.15	
V - 640		633.5	±4.24	SM - 26		25.5	±0.15	KS - 19	27.60	±0.15	
V - 690		683.0	±4.54	SM - 28		27.5	±0.15	KS - 20	29.60	±0.15	
V - 740		732.5	±4.83	SM - 29		28.5	±0.15	KS - 21	31.60	±0.15	
V - 790		782.0	±5.12	SM - 30		29.5	±0.15	KS - 22	33.60	±0.15	
V - 845		836.5	±5.44	SM - 31.5		31.0	±0.15	KS - 23	35.60	±0.15	
V - 950		940.5	±6.06	SM - 32		31.5	±0.15	KS - 24	37.60	±0.15	
V - 1055		1044.0	±6.67	SM - 34		33.5	±0.15	KS - 25	39.60	±0.15	
			SM - 35	34.5	±0.15	KS - 26					
			SM - 35.5	35.0	±0.15						
			SM - 36	35.5	±0.15						
			SM - 38	37.5	±0.15						
			SM - 39	38.5	±0.15						
			SM - 40	39.5	±0.15						
			SM - 42	41.5	±0.25						
			SM - 44	43.5	±0.25						
			SM - 45	44.5	±0.25						
			SM - 46	45.5	±0.25						
			SM - 48	47.5	±0.25						
			SM - 50	49.5	±0.25						
			SM - 53	52.5	±0.25						
			SM - 55	54.5	±0.25						
			SM - 56	55.5	±0.25						
			SM - 60	59.5	±0.25						
			SM - 63	62.5	±0.25						
			SM - 65	64.5	±0.25						
			SM - 67	66.5	±0.25						
			SM - 70	69.5	±0.25						
			SM - 71	70.5	±0.4						
			SM - 75	74.5	±0.4						
			SM - 80	79.5	±0.4						
			SM - 85	84.5	±0.4						
			SM - 90	89.5	±0.4						
			SM - 95	94.5	±0.4						
			SM - 100	99.5	±0.4						
			SM - 105	104.5	±0.4						
			SM - 110	109.5	±0.4						
			SM - 112	111.5	±0.4						
			SM - 115	114.5	±0.4						
			SM - 120	119.5	±0.4						
			SM - 125	124.5	±0.4						
			SM - 130	129.5	±0.6						
			SM - 132	131.5	±0.6						
			SM - 135	134.5	±0.6						
			SM - 140	139.5	±0.6						
			SM - 145	144.5	±0.6						
			SM - 150	149.5	±0.6						

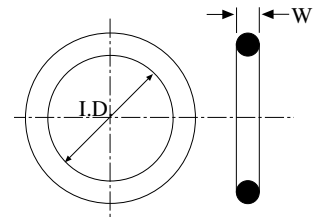

Unit: mm  
25.4 mm = 1 inch

Notes

# O-Ring Failure

## Common Seal Failures

• Abrasion .....	74
• Swelling .....	74
• Compression Set.....	74
• Explosive Decompression .....	75
• Spiraling .....	75
• Extrusion .....	75
• Installation Damage .....	76

## Common Seal Failures

### Abrasion

Usually found in dynamic applications, abrasion results in a scraping or rubbing away of the o-ring's sealing surface. The resulting damage reduces the o-ring's "squeeze" and its ability to properly function.

**Cause:**

Improper dynamic surface finish

Improper o-ring lubrication

System fluid contamination

**Solution:**

Evenly apply 8-16 Ra surface finish to dynamic sealing surfaces

Improve o-ring lubrication

Clean system fluid

Use more abrasion resistant seal material

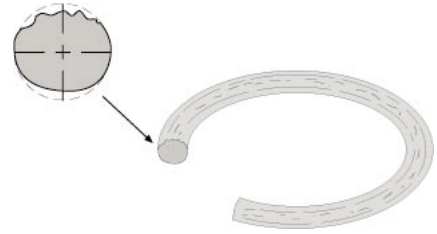

### Swelling

Usually due to an incompatibility between o-ring material and system fluid, the o-ring will absorb excessive amounts of fluid. The resulting o-ring swell will result in reduced material physical properties and improper o-ring squeeze.

**Cause:**

O-ring material incompatible with system fluid

**Solution:**

Use a more compatible o-ring material

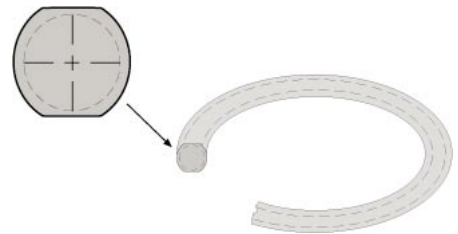

### Compression Set

Compression set is the failure of an elastomer to rebound to its original shape after being squeezed for a period of time.

**Cause:**

Use of a poor compression set resistant material

Improper gland design resulting in too much squeeze

Excessive temperatures

O-ring swell due to incompatible fluids

**Solution:**

Use compression set resistant material

Reduce system temperatures

Use more compatible seal material

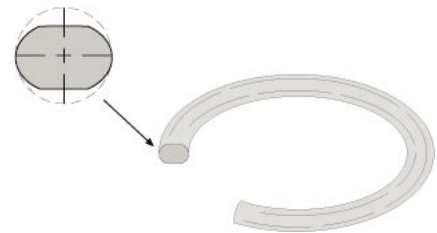

## Common Seal Failures

## Explosive Decompression

Typically in high pressure applications, gas may become trapped within the o-ring material. When the system pressure is reduced, the trapped gas expands and causes splits and/or blisters on the o-ring surface.

**Cause:**

Rapid reduction of system pressure

**Solution:**

Increase pressure release time  
Use a material with improved gas permeation properties

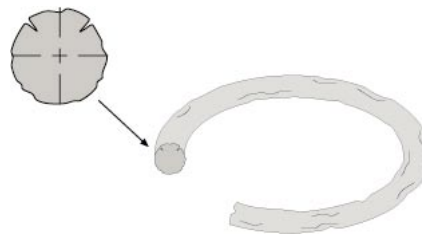

## Spiraling

Typically found in long stroke applications, spiral failure results when the seal ceases to slide along the sealing surface and begins to roll. After removal, the seal is twisted and the surface shows deep spiral cuts.

**Cause:**

Wide clearances and/or side loads

Inadequate seal lubrication  
Uneven surface finishes  
Stroke speed is too slow

Improper o-ring installation  
O-ring material is too soft

**Solution:**

Evenly apply 8-16 Ra surface finish to dynamic sealing surfaces  
Improve o-ring lubrication  
Use a harder o-ring material  
Switch to rectangular cross-section seals

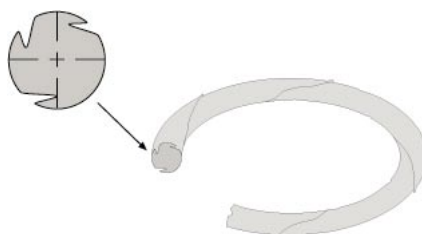

## Extrusion

In high pressure applications, the o-ring is forced into the gap between the mating surfaces of the housing. The resulting damage gives a "chewed" or "nibbled" appearance on the low pressure side of the o-ring. In extreme situations, more than 50% of the o-ring may be removed from the low pressure side.

**Cause:**

Excessive clearances  
Excessive pressures  
O-ring material too soft  
O-ring material incompatible with system fluid  
Improper gland design or machining  
Improper o-ring cross-section

**Solution:**

Reduce clearances  
Use anti-extrusion rings  
Use harder or more compatible seal material  
Break sharp edges

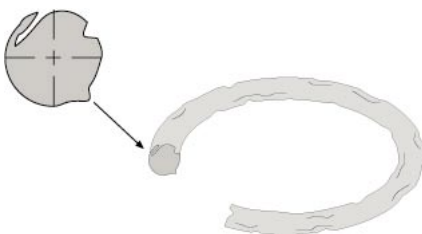

## Common Seal Failures

### Installation Damage

When adequate care is not taken during installation, the o-ring can become damaged, cut, or worn before it is entered into service. This installation damage reduces the o-ring's ability to properly function.

**Cause:**

Installation over threads or sharp corners  
Insufficient assembly chamfering  
Twisting or pinching during installation  
Improper o-ring lubrication  
Improper o-ring size

**Solution:**

Break sharp edges  
Lubricate o-ring prior to installation  
Cover threads during installation  
Provide 15-20° lead-in chamfer  
Use properly sized o-ring

Notes

Notes