



HERO3

WHITE EDITION

USER MANUAL

GoPro®
Be a HERO. ■■■■

Join the GoPro party at [facebook.com/gopro](https://www.facebook.com/gopro) to see what other GoPro owners are capturing and sharing. Share *your* footage and be a part of the GoPro movement!

TABLE OF CONTENTS

Accessories	4
Mounts + Accessories	5
HERO3 Features	6
Camera LCD Status Screen	8
Camera User Interface Flow Chart	9
Software Updates	10
Basics	10
Camera Modes	13
Camera Settings	20
Delete	26
Set Up	28
Wireless Controls	36
Storage/SD Cards	38
System Requirements	39
Transferring Files	40
Playback	41
Battery Life	43
Important Warning Messages	45
Camera Assembly	46
Customer Support	52

PREMIUM ACCESSORIES



LCD Touch BacPac™



Battery BacPac™



Wi-Fi Remote™

The Frame Mount
(HERO3 accessory)

HERO3 ACCESSORIES



Wrist Housing



Replacement Housing



Rechargeable Li-Ion Battery



Lens Replacement Kit



Caps + Doors



32GB/16GB microSD™

More HERO3 accessories available at gopro.com

MOUNTS + ACCESSORIES

Helmet Front
MountChest Mount
HarnessHandlebar/Seatpost/
Pole Mount

Surfboard Mounts



Floaty Backdoor



Head Strap



Suction Cup Mount

Vented Helmet
Strap

Roll Bar Mount



Tripod Mount



Anti-Fog Inserts

Grab Bag of
MountsCurved + Flat
Adhesive Mounts

Side Mount



Camera Tethers

Wi-Fi Remote
Mounting Kit

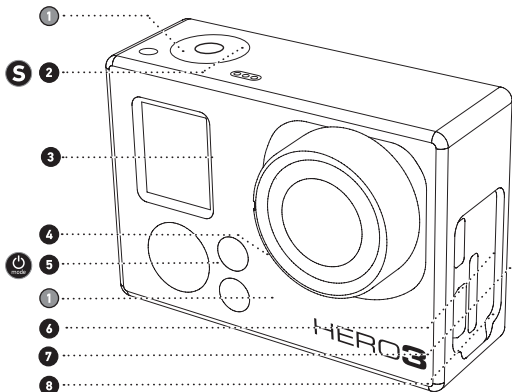

1. Status Indicator Lights (Red)
2. SHUTTER/SELECT Button **S**
3. LCD Status Screen
4. Wi-Fi Indicator Light (Blue)
5. POWER/MODE Button **⏻**
6. Micro HDMI Port
(Cable not included)
7. microSD™ Card Slot
(SD card not included)
8. mini-USB Port
(Supports Composite A/C
cable/3.5mm stereo mic adapter,
not included)

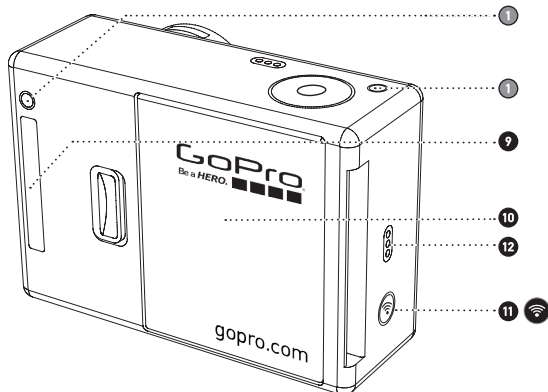

9. HERO Port
10. Battery Door
11. Wi-Fi ON/OFF Button **📶**
12. Audio Alert

CAMERA LCD STATUS SCREEN

The LCD screen displays the following information about HERO3 modes and settings:

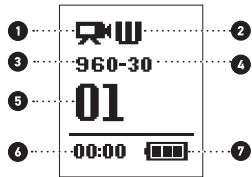

1. Camera Modes/FOV (Field of View)
2. Capture Setting Modes (not shown)
3. Resolution/FPS (Frames Per Second)
4. Time Interval Settings: (not shown)
5. Counter
6. Time/Storage/Files
7. Battery Life

Note: The icons displayed above will vary depending on what mode your camera is in.

CAMERA USER INTERFACE FLOW CHART

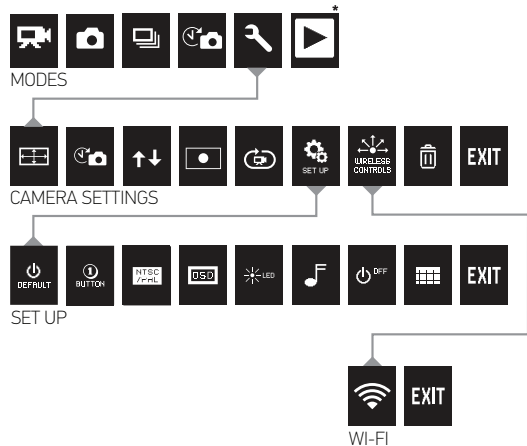

***Note:** White Balance only appears in your camera display if **Protune** mode is turned **ON**. Playback only appears if **Playback** is activated.



GoPro releases product updates through software updates. Check to see if any updates are available for your camera or other GoPro products. Visit: gopro.com/update.

USING YOUR HERO3: BASICS

GETTING STARTED

Before using your HERO3 for the first time:

- 1. Insert a microSD™, microSDHC™ or microSDXC™ card into the card slot with label facing forward, narrowest part of the card first.**
Speed Class 4 or higher cards are recommended. When using 0.5 second **Time Lapse**, a Speed Class Rating 10 is required.
- 2. Place battery into the camera.**
- 3. Charge battery.** The included lithium-ion battery comes partially charged. To charge, connect the included USB cable to camera and connect the other end of the cable to a power source such as a computer, GoPro Wall Charger or GoPro Auto Charger. No damage will occur to the camera or battery if used prior to a full charge.

PRO TIP:

Status Indicator Lights when camera is OFF and charging, show:

- **Status Indicator Lights** are **ON** when charging.
- **Status Indicator Lights** are **OFF** when charging is complete.

▶ See **BATTERY LIFE** for more information.

▶ See **PROTUNE** for more information.

CAMERA DEFAULT SETTINGS

The HERO3 White Edition camera powers up with the following default settings:

	Video Resolution	1080p30fps
	Photo Resolution	5 Megapixels (MP)
	Photo Burst	3 photos in 1 second
	Time Lapse	0.5 seconds
	Wi-Fi	OFF

PRO TIP:

Want to change your **VIDEO** and **PHOTO** settings?

▶ See **SETTINGS MENU** to make changes.

POWERING ON AND OFF

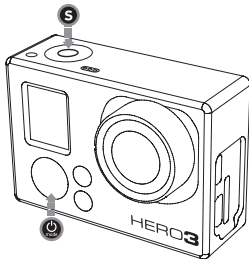

To power ON:

Press and release . The red **Status Indicator Lights** flash three times and the **Sound Indicator** emits three beeps.

To power OFF:

Press  for two seconds, then release. The red **Status Indicator Lights** flash several times and the **Sound Indicator** emits seven beeps.





PRO TIP:

Want to turn your HERO3 into a “one-button” camera that automatically starts recording **Photos** or **Videos** once it turns **ON**? Set the camera to **ONE BUTTON** mode.

▶ See **ONE BUTTON** mode for more information.

OVERVIEW

The HERO3 features several camera modes. To cycle through the modes, press . The modes will appear in the following order:



	VIDEO	Record Video
	PHOTO	Capture single Photo
	PHOTO BURST	Capture Burst photos
	TIME LAPSE	Capture Time Lapse photos
	PLAYBACK	Appears only if the camera is plugged into a TV/HDTV. PLAYBACK allows you to play Photos and Videos on a TV/HDTV (via optional Micro HDMI cable or A/V composite cable).

PRO TIP:

Use **PHOTO BURST** to capture fast moving subjects.

▶ See **PLAYBACK** for more information.

VIDEO

To record **Video**, verify the camera is in **Video** mode. If the **Video** icon  on your camera's LCD screen is not showing, press  repeatedly until it appears.

To start recording:

Press and release . The camera will emit one beep and the red **Status Indicator Lights** will flash while recording.

To stop recording:

Press and release . The red **Status Indicator Lights** flash three times and the camera emits three beeps to indicate recording has stopped.

The HERO3 automatically stops recording when the memory card is full or the battery is out of power. Your video will be saved before the camera powers off.

▶ See **VIDEO** mode for instructions on how to change resolution settings.

PHOTO

To capture a **Photo**, verify the camera is in **Photo** mode. If the **Photo** icon  on your camera's LCD is not showing, press  repeatedly until it appears.



To take a photo:

Press and release . The camera beeps two times and the red **Status Indicator Lights** flash.

▶ See **PHOTO** modes for instructions on how to change resolution settings and other **Photo** features.

PHOTO BURST

In **Photo Burst** mode, your camera takes multiple photos in short time intervals—**3 photos/1 second**.

To capture a **Photo Burst** series, verify the camera is in **Photo Burst** mode. If the **Photo Burst** icon  on your camera's LCD screen is not showing, press  repeatedly until it appears.

To take a Photo Burst series:



Press and release . The red **Status Indicator Lights** flash and the camera beeps multiple times.

PRO TIP:	Sometimes 30 photos/1 second is too fast. Try a slower Burst setting to better match the action.
-----------------	--

▶ See **PHOTO BURST** for instructions on how to change the interval settings.

TIME LAPSE

Time Lapse mode captures a series of photos at **0.5, 1, 2, 5, 10, 30** or **60** second intervals. When using the **0.5** seconds setting, an SD card with a Speed Class 10 Rating is required.

To capture a **Time Lapse** series, verify the camera is in **Time Lapse** mode. If the Time Lapse icon  is not showing on your camera's LCD screen, press  repeatedly until it appears.

To take Time Lapse:

Press and release . The camera initiates countdown and the red **Status Indicator Lights** flash each time a **Photo** is taken.

To stop Time Lapse:

Press and release . The red **Status Indicator Lights** flash three times and the camera emits three beeps to indicate that **Time Lapse** has stopped.

▶ See **TIME LAPSE** for instructions on how to change the interval settings.

SETTINGS

The **Settings** menu allows you to adjust a variety of camera settings including:

 **Video Resolution**

 **Photo Resolution**

 **Time Lapse**

 **Photo Burst**

• and more

▶ See **SETTINGS MENU** to make changes, learn how to navigate menu options and read more details on each setting.

PLAYBACK





You can playback your GoPro **Photos** and **Videos** on a TV/HDTV or with the LCD Touch BacPac™ (optional accessory). **Playback** appears as a camera mode when camera is powered **ON** and plugged into a TV/HDTV.

▶ See **PLAYBACK** for more information on viewing your **Videos** and **Photos**.



SETTINGS

To enter the Settings menu:

1. Verify the camera is in the **Settings** menu. If the **Setting** icon  on your camera's LCD screen is not showing, press  repeatedly until it appears.
2. Press **S** to enter  menu.
3. Use  to cycle through the various **Settings** options.
4. Press **S** to select desired option.
5. To exit, hold down **S** for two seconds or cycle through to **EXIT** and press **S**.

PRO TIP:

If at any time you wish to exit from the **SETTINGS MENU**, press and hold **S** for two seconds.



VIDEO RESOLUTION/FPS/FOV MODES

The HERO3 White Edition offers the following Video Capture modes:

Video Resolution	NTSC fps	PAL fps	Field of View (FOV)	Screen Resolution	Best Use
1080p	30fps	25fps	Ultra Wide	1920x1080 16:9	Use this mode when camera is mounted on a vehicle, tripod or other stable object.
960p	30fps	25fps	Ultra Wide	1280x960 4:3	High-quality 4:3 video. Good when shooting in low light conditions. Use for body-mounted shots.
720p	60fps	50fps	Ultra Wide	1280x720 16:9	Best resolution frame rate for handheld shots and when slow motion is desired.
720p	30fps	25fps	Ultra Wide	1280x720 16:9	Best resolution for handheld shots and low light conditions. Choose this mode when camera is mounted on vehicle, tripod or other stable object.
WVGA	60fps	50fps	Ultra Wide	848x480	Good when standard definition is acceptable.

CAMERA SETTINGS



TIME LAPSE

Several time interval options are available for **Time Lapse** mode, including **0.5, 1, 2, 5, 10, 30** and **60** seconds.



UPSIDE DOWN

Mounting your HERO3 **Upside Down** but wish the files to appear upright when viewing or editing? This setting eliminates the NEED to flip your video or photos after recording.



Camera right side up (Default)



Camera upside down



SPOT METER

Turn on **Spot Meter** when filming from within a dark space pointing the camera into a brighter setting, such as filming the outdoors from within a car. When **Spot Meter** is set to **ON**,  appears in the LCD window.

OFF (Default)

ON

CAMERA SETTINGS



LOOPING VIDEO

Looping Video mode allows you to record a continuously looping video that overwrites itself until you press the **S** button to stop it. **Looping Video** is not available if **Protune** mode is turned **ON**.

Looping Video options include:

OFF	(Default)
Max video	Camera records until memory card is full, then overwrites with a new video.
5 min video	Camera records for 5 minutes, then begins a new video, progressively overwriting the previous 5 minute video.
20 min video	Camera records for 20 minutes, then begins a new video, progressively overwriting the previous 20 minute video.
60 min video	Camera records for 60 minutes, then begins a new video, progressively overwriting the previous 60 minute video.
120 min video	Camera records for 120 minutes, then begins a new video, progressively overwriting the previous 120 minute video.

PRO TIP:

Multiple chapter files are written to your memory card. This allows for small segments of content to be overwritten during loop recording. When viewing on a computer screen you will see separate files for each time segment. Use video editing software if you wish to combine files into a longer video.

Note: **Looping Video** is not enabled when in **Protune** mode.



SET UP MENU

The **Set Up** menu allows you to adjust the following camera settings:

 **Default mode at Power Up**

DEFAULT

 **One Button Mode**

BUTTON

 **NTSC/PAL**

 **On Screen Display**

 **Status Indicator Lights**

 **Sound Indicator**

 **Month/Day/Year/Time**

▶ See **SET UP MENU** section for a complete list of set up options.



WIRELESS CONTROLS

The HERO3 camera's built-in Wi-Fi allows you to connect to the Wi-Fi Remote or smartphone/tablet via the GoPro App. When **Wi-Fi** is **ON**, your **Wi-Fi Status Indicator Light** will blink blue.

To turn Wi-Fi ON/OFF:

Press  to turn **Wi-Fi ON/OFF**. The most recently used **Wi-Fi** mode will be active when Wi-Fi is **ON**.

▶ See **WIRELESS CONTROLS** section for a complete list of wireless functions



DELETE











Delete the last file or all files and format the memory card. During delete **LAST** or **ALL**, the **Status Indicator Lights** blink until operation is complete.

CANCEL (Default)

LAST

ALL

To delete LAST or ALL:

1. Verify the camera is in **Settings** mode. If the **Settings**  icon on your camera's LCD screen is not showing, press  repeatedly until it appears.
2. Press  to enter **Settings** menu.
3. Use  to cycle through **Settings** to locate .
4. Press  to enter **Delete**.
5. Use  to cycle through options.
6. Select highlighted option by pressing .
7. To exit, hold down  for two seconds or cycle through to **EXIT** and press .

PRO TIP:

Use caution — by selecting **ALL**, the memory card will be formatted, deleting every file on your SD card.

EXIT EXIT

From the **EXIT** screen, press  to exit the **Settings** menu.













PRO TIP:

If at anytime you wish to exit from the **CAMERA SETTINGS MENU**, press and hold  for two seconds.



SET UP

To enter the Set Up menu:

1. Verify the camera is in **Settings** mode. If the **Settings**  icon on your camera's LCD screen is not showing, press  repeatedly until it appears.
2. Press  to enter .
3. Use  to cycle through **Settings** to locate  .
4. Press  to enter **Set Up**.
5. Use  to locate the desired option to change.
6. Press  to select the desired option.
7. To exit, hold down  for two seconds or cycle through to **EXIT** and press .



DEFAULT MODE AT POWER UP

You can set the camera's **Default** mode at power up to any of the following modes:



(factory default)

















① ONE BUTTON

With **One Button** mode selected, the camera automatically begins recording when powering the camera **ON**. **One Button** mode can be configured to start in **Video** or **Time Lapse**.

OFF (Default)

ON







To turn One Button mode ON:

1. Verify the camera is in **Settings** mode. If the **Settings**  icon on your camera's LCD screen is not showing, press  repeatedly until it appears.
2. Press  to enter  menu.
3. Use  to cycle through **Settings** to locate  **SET UP**.
4. Press  to enter **Set Up**.
5. Use  to cycle through to locate  **ONE BUTTON**.
6. Press  to enter **One Button** menu.
7. Use  to cycle through options.
8. Press  to select a highlighted option.
9. To exit, hold down  for two seconds or cycle through to **EXIT** and press .

Next time you power your camera **ON**, it will begin recording in its **Default Power Up Mode**. To stop recording, push and hold  for two seconds.

ONE BUTTON MODE (continued)

To exit **One Button** mode:

1. Power camera **ON**.
2. Press and hold  until  **ONE BUTTON** shows in the LCD window.
3. Press  to enter.
4. Use  to highlight **OFF**.
5. Press  to select.
6. To exit, hold down  for two seconds or cycle through to **EXIT** and press .

PRO TIP:

To stop the capture process (**VIDEO** or **TIME LAPSE**) when in **ONE BUTTON**, press and hold  for two seconds. You will return to the **ONE BUTTON** menu where you can turn **ONE BUTTON** mode **OFF**.

Note: **One Button** mode is disabled when connected to *Wi-Fi Remote* or *GoPro App*.

NTSC / PAL

The **NTSC** and **PAL** settings govern **Video** recording frame rate and playback when viewing **Video** on a TV/HDTV. Select **NTSC** when viewing a TV/HDTV in North America. Select **PAL** if viewing on a PAL TV/HDTV (most televisions outside of North America) or if viewing on a PAL TV/HDTV in any region.

NTSC (Default)	PAL
1080p/30fps	1080p/25fps
960p/30fps	960p/25fps
720p/60fps	720p/50fps
720p/30fps	720p/25fps
WVGA/60fps	WVGA/50fps

OSD ONSCREEN DISPLAY

To display or hide the recording icons and file information on video or the viewing screen during playback, turn **Onscreen Display (OSD) OFF** or **ON**.

OFF
ON (Default)

 LED STATUS INDICATOR LIGHTS

Keep all four **Status Indicator Lights** active, only two active (front and back) or turn **OFF** all lights.

4 (Default)
2
OFF

 SOUND INDICATOR

You can adjust volume or turn **OFF** the **Sound Indicator**.

100% (Default)
70%
OFF

 MANUAL POWER OFF

The HERO3 can be configured to automatically power **OFF** after a specific period of inactivity (when no **Videos** or **Photos** are being taken and no buttons have been pressed).

















MANUAL (Default)
60sec
120sec
300sec



MONTH / DAY / YEAR / TIME

Set the HERO3 clock to ensure **Video** and **Photo** files are saved with the correct date and time.

To change Month/Day/Year/Time:

1. Verify the camera is in **Settings** mode. If the **Settings**  icon on your camera's LCD screen is not showing, press  repeatedly until it appears.
2. Press  to enter  menu.
3. Use  to cycle through **Settings** to locate  SET UP.
4. Press  to enter **Set Up**.
5. Use  to locate .
6. Press  to enter **Month/Day/Year/Time** sub-menu; **Month (MM)** will be highlighted.
7. Press  to access the list of months (**1** to **12**).
8. Use  to cycle through list until desired selection is highlighted.
9. Press  to select.
10. To advance to the next option, press .
11. Repeat steps 7, 8 and 9 to make selections for day (**DD**), year (**YY**), hour (**HH**) and minutes (**MM**).
12. To exit, hold down  for two seconds or cycle through to **EXIT** and press .

Note: If the battery is removed from the camera for an extended period of time **MONTH/DAY/YEAR/TIME** will need to be set again.

EXIT EXIT

From the **EXIT** screen, press  to exit the **Set Up** menu.

PRO TIP:

If at anytime you wish to exit from the **SET UP MENU**, press and hold  for two seconds.



WIRELESS CONTROLS













The built-in Wi-Fi allows your HERO3 camera to connect to the Wi-Fi Remote and smartphone/tablet via the GoPro App.

To turn Wi-Fi ON/OFF via the Wi-Fi button:

Press  to turn **Wi-Fi ON/OFF**. When turning **Wi-Fi ON** the Wi-Fi mode will be set to the most recently used mode.





USING HERO3 WITH THE WI-FI REMOTE NOT PAIRING

Pair your HERO3 with the Wi-Fi Remote to control your camera remotely. The Wi-Fi Remote can control up to 50 cameras at a time at distances of up to 600'/180m in optimal conditions.

1. Power **ON** the HERO3 and turn **Wi-Fi ON**.
2. Press  to cycle through to the **Settings** menu.
3. Press  to enter .
3. Use  to cycle through to locate .
4. Press  to enter **Wireless Controls**.
5. You will see .
6. Press  again to enter the sub-menu.
7. Use  to select **Wi-Fi RC**.
8. Press  to select it.
9. Use  to select **CURRENT** or **NEW**.
10. Press  to select desired option.

WIRELESS CONTROLS (CONTINUED)

On your Wi-Fi Remote:

1. Turn **ON** the GoPro Wi-Fi Remote.
2. While holding , press and release .
3. Once you see , you can release .
4. A check will appear once the Wi-Fi Remote and camera have successfully paired.

The Wi-Fi Remote's LCD screen will now mirror the HERO3 LCD screen.

USING THE HERO3 WITH THE GOPRO APP

The GoPro App lets you control your camera remotely using a smartphone or tablet. Features include full camera control of all settings, live video preview to your smartphone or tablet for easy shot framing and more.

The GoPro App is available for free at the Apple App Store and is coming soon to Google Play.

PRO TIP:

Before you hit the shutter, see what your HERO3 camera sees by viewing it on your smartphone or tablet's screen.

▶ See gopro.com for more information.

STORAGE/MICROSD CARDS

The HERO3 camera is compatible with **2GB, 4GB, 8GB, 16GB, 32GB** and **64GB** capacity **microSD**, **microSDHC** and **microSDXC** memory cards. While all speed class ratings are compatible, GoPro requires using an SD card with Speed Class Rating 10 or higher speed when recording in **Protune** mode, or when using the 0.5 **Time Lapse** setting. GoPro recommends using brand name memory cards for maximum reliability in high-vibration activities.

To insert SD card:



1. Slide memory card into card slot with label facing front of camera.
2. The card will click into place when fully inserted.

To remove SD card:



1. Place fingernail against edge of memory card and lightly press further into camera.
2. Card will spring out far enough to be removed.

PRO TIP:

Use care when handling memory cards. Avoid liquids, dust and debris. As a precaution, turn off the camera before inserting or removing the card. Check manufacturer guidelines regarding use in acceptable temperature ranges.

SYSTEM REQUIREMENTS

The HERO3 camera is compatible with Microsoft® XP (Service Pack 2) or later and Mac OS X 10.4.11 or later.

WINDOWS	MAC
Windows XP (Service Pack 2 or later) or Vista	Mac OS® X 10.4.11 or later
3.2GHz Pentium 4 or faster	2.0GHz Intel Core Duo or faster
DirectX 9.0c or later	
Minimum 1GB of system RAM	Minimum 1GB of system RAM
Video card with minimum 256MB of RAM	Video card with minimum 128MB of RAM

PRO TIP:

Want to see your footage and stills on the big screen? Plug your HERO3 directly into a TV/HDTV with GoPro's Micro HDMI cable or USB cable (optional accessories).

TO TRANSFER VIDEO AND PHOTO FILES TO A COMPUTER

ON A PC:

1. Connect the camera to the computer using included USB cable.
2. Press  to turn **ON** the camera.
3. Double click "My Computer" and locate "Removable Disk".
4. If "Removable Disk" is not showing, close "My Computer" folder and reopen it. The "Removable Disk" icon should appear.
5. Double click "Removable Disk" icon.
6. Double click "DCIM" folder icon.
7. Double click "100GOPRO" icon to view all **Photo** and **Video** files.
8. Copy/move files to the computer or external hard drive.

On a Mac:

1. Connect the camera to Mac using included USB cable.
2. Press  to turn **ON** the camera.
3. The Mac recognizes the camera as an external hard drive. Double click icon for external drive to access files.
4. Copy/move files to computer or external hard drive.











IMPORTANT TIP FOR MAC USERS: *When deleting files from the memory card, empty the trash before removing the memory card or unplugging the camera.*

TO VIEW VIDEOS AND PHOTOS

Videos and **Photos** can be viewed on a TV/HDTV or the LCD Touch BacPac™ (optional accessory).

PLAYBACK ON TV/HDTV

To browse Videos and Photos:

1. Plug the camera into a TV/HDTV with a **Micro HDMI** or a **miniUSB to a Composite Cable** (optional accessories).
2. Turn camera **ON**.
3. On your camera press  to cycle to . Press .
4. HERO3 displays thumbnail previews of all **Videos** and **Photos** on the SD card. **Photo** sets taken in **Continuous Photo**, **Photo Burst** and **Time Lapse** display the first **Photo** in a series.
5. While in thumbnail preview use  to cycle through thumbnails. Press  to view.
6. Use  and  to navigate backward and forward to see more media files on your memory card.
7. Highlight desired file to view and press .
8. Depending on whether you are viewing **Videos** and **Photos**, different control options will appear. Use the  and  buttons to navigate.

Note: *Photo Burst and Time Lapse files will display the first Photo in the series. To view all Photos in a series, use  to select **VIEW** and press .*

PLAYBACK ON LCD TOUCH BACPAC

Playback using the LCD Touch BacPac follows a similar process/procedure as described with a few slight variations.

▶ See the LCD Touch BacPac User Manual for more information.

CHARGING BATTERY

The battery icon displayed in the camera's LCD will blink when the battery drops below 10%. If recording is occurring when battery reaches 0%, the camera will save the file and power **OFF**.

To charge the battery:

1. Connect the camera to a computer or USB power supply (such as the GoPro Wall Charger or GoPro Auto Charger).
2. The Red **Status Indicator Light** remains **ON** while the battery is charging.
3. The Red **Status Indicator Light** will turn **OFF** when the battery is fully charged.

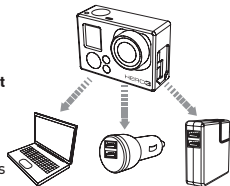

The battery will charge to 80% in one hour and 100% in two hours when using GoPro's 1000mAh USB-compatible Wall or Auto Charger. Other chargers may charge at only half this rate.

No damage will occur to the camera or the battery if used together prior to full charge. Spare batteries and additional charging accessories are available at gopro.com.

BATTERY LIFE

USING THE CAMERA WHILE CHARGING

You can charge the camera's battery while recording **Video** or taking **Photos**. Simply plug the camera into a GoPro-specific auto, wall or phone charger to charge the HERO3 camera while recording **Video** or **Photos**. It is best to use GoPro's 1AMP (1000mAh) Wall or Auto Charger for maximum charging performance while the camera is in use. Performance of non-GoPro chargers cannot be guaranteed.

REMOVING THE BATTERY FROM THE CAMERA

The HERO3 battery is designed to have a tight fit to maximize reliability in high-vibration activities.

To remove the battery:

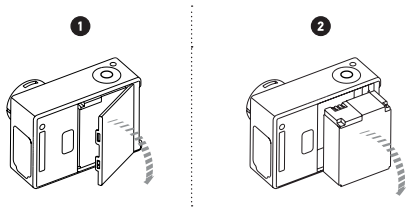

1. Remove the battery door by placing your thumb in the indentation in the battery door (on the back of the camera) and sliding it to the left.
2. Allow the door to pop out. Grasp the battery pull-tab and remove from the camera.

IMPORTANT WARNING MESSAGES

MICROSD CARD MESSAGES

NO SD	No card present. The camera requires a microSD, microSDHC or microSDXC card to record Video or take Photos .
SD FULL	Card is full. Delete files or swap card.
SD ERROR	Camera unable to access card.

FILE REPAIR ICON ON THE LCD



If you see the **File Repair** icon on the LCD screen, your **Video** file was corrupted during recording. Press any button and the camera will repair the file.

TEMPERATURE WARNING ICON ON THE LCD



The **Temperature Warning** icon will appear on the LCD when the camera has become too hot and needs to cool down. Simply let it sit and cool before attempting to use it again. Your camera will not allow itself to overheat—do not worry, no damage has occurred.

ASSEMBLING THE CAMERA

The HERO3 camera housing is waterproof to 197'/60m and is constructed of polycarbonate and stainless steel for ultimate durability. The HERO3 has a new improved latch closure that offers one hand open-and-close functionality and locking.

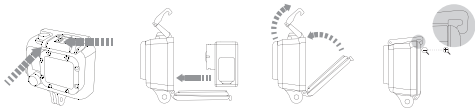

To place the HERO3 camera into the housing:

1. Place camera in housing.
2. Position the backdoor into place.
3. Lift the latch arm into upright position allowing the hinged arm to hang downward.
4. Hook grooved portion of hinged arm to grooved top of the backdoor.
5. Use one finger to push down the latch arm to snap into place.

To remove the HERO3 camera from the housing:

1. Grip the housing with left hand.
2. Using right hand, place thumb to left side of arrow and index finger just below latch arm.
3. Pinch fingers together, sliding arrow to the right.
4. Use fingertips to pull upward, allowing latch arm to swing to fully upright position.
5. Lift hinged arm over the housing and remove the HERO3.

To close properly, be sure grooved sections of the latch arm and the backdoor are hooked.

The HERO3 housing comes with two types of backdoors—Skeleton and Waterproof.

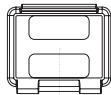

Skeleton Backdoor

The Skeleton Backdoor (non-waterproof) provides better sound quality by allowing more sound to reach the camera's microphone. It also reduces wind noise at speeds up to 100mph when mounted on helmets, motorcycles, bikes and other fast-moving vehicles. Use this backdoor only when sand, excessive dirt/dust and water damage is not a risk. This backdoor is also recommended for use inside vehicles.

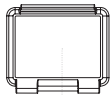

Waterproof Backdoor

The Waterproof Backdoor makes the housing waterproof to 197'/60m. Use this door when you need to protect the camera from water and other environmental hazards.

PRO TIP:

Apply RAIN-X or a similar anti-beading solution to the housing lens to prevent waterspots from forming when using your camera in rain or water. When RAIN-X is not available, periodically licking your lens is a good backup solution. Dunk your camera after licking. Trust us, this works.

SWAPPING HOUSING DOORS

Your HERO3 camera housing comes with two types of backdoors—Waterproof and Skeleton (non-waterproof).

To change backdoor:

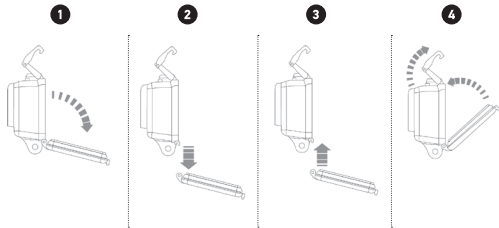

1. Open the backdoor of the housing so that it is hanging downwards.
2. Pull downwards on the backdoor until it snaps free from the hinge.
3. Line up replacement backdoor into the hinge opening.
4. Push upwards on the backdoor until it clicks into place.

PREVENTING WATER DAMAGE TO YOUR CAMERA

The rubber seal that lines the camera housing forms a waterproof barrier that protects your HERO3 in wet and underwater conditions. Keep the camera housing's rubber seal clean; a single hair or grain of sand can cause a leak.

After every use in salt water you will need to rinse the outside of the housing with non-salt water and dry. Not doing this can eventually cause corrosion of the hinge pin and salt buildup in the seal, which can cause failure.

To clean the seal, rinse in fresh water and shake dry (drying with a cloth may cause lint to compromise the seal). Re-install the seal into the grooves in the backdoor of the housing.

WARNING: Failure to follow these steps each time you use your HERO3 can result in leaks that may damage or destroy your camera. Your warranty does not cover water damage resulting from user error.

ATTACHING YOUR CAMERA TO MOUNTS

To attach your HERO3 camera to a mount, you will need an attachment buckle, thumb screw or other hardware depending on the mount you are using. For more information on mounts, visit gopro.com/support.

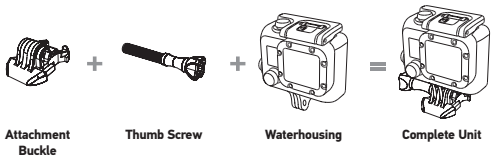

USING CURVED OR FLAT ADHESIVE MOUNTS

The curved and flat adhesive mounts make it easy to attach the camera to curved and flat surfaces of helmets, vehicles and gear. With the attachment buckle the assembled camera housing can be clicked **ON/OFF** the secured adhesive mounts.

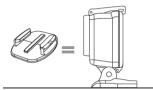

Flat Adhesive Mount

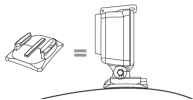

Curved Adhesive Mount

ATTACHING ADHESIVE MOUNTS

PRO TIPS:

Apply to clean surface only. Wax, oil, dirt or other debris will reduce adhesion, which can result in a weak bond and risk of losing camera should connection fail.

Attach mount in room temperature conditions. Mount's adhesive will not bond properly if applied in cold or damp environments to cold or damp surfaces, or if the surface is not room temperature.

Adhesive mounts should only be mounted to smooth surfaces; porous or textured surfaces will not enable a proper bond. When applying mount, firmly press into place and ensure full contact over entire surface.

For best results, attach the mount a minimum of 24 hours prior to use.

▶ See gopro.com/support for more information on mounts.

Locking Plug



Using the HERO3 in high impact sports such as surfing or skiing where significant impact may occur? Use the special locking plug which securely locks the attachment buckle fingers into place--helping prevent accidental housing release from the mount. The circular ring fits over the thumbscrew and acts as a leash to prevent dropping or losing the locking plug.

GoPro is dedicated to providing the best possible service. To reach the GoPro Customer Support Team, visit **gopro.com/support**.

Learn about more GoPro products at: **gopro.com**