

Heuristic Optimization for Microload Shedding in Generation Constrained Power Systems

JULIUS QUARSHIE AZASOO^{1,2}, (Member, IEEE),
TRIANTAFYLLOS KANAKIS¹, (Member, IEEE), **ALI AL-SHERBAZ**¹, (Member, IEEE),
AND MICHAEL OPOKU AGYEMAN¹, (Senior Member, IEEE)

¹Department of Computing, University of Northampton, Northampton NN1 5PH, U.K.

²School of Technology (SOT), Ghana Institute of Management and Public Administration (GIMPA), Accra, Ghana

Corresponding author: Julius Quarshie Azasoo (julius.azasoo@northampton.ac.uk)

ABSTRACT While the causes of power system outages are often complex and multi-faceted, an apparent deficit in generation compared to a known demand for electricity could be more alarming. A sudden hike in demand at any given time may ultimately result in the total failure of an electricity network. In this paper, algorithms to efficiently allocate the available generation is investigated. Dynamic programming based algorithms are developed to achieve this constraint by uniquely controlling home appliances to reduce the overall demands for electricity by the consumers on the grid in context. To achieve this, heuristic optimization method (HOM) based on the consumers' comfort and the benefits to the electricity utility is proposed. This is then validated by simulating microload management in generation constrained power systems. Three techniques; General Shedding (GS), Priority Based Shedding (PBS) and Excess Reuse Shedding (ERS) techniques were studied for effecting efficient microload shedding. The research is aimed at reducing the burden imposed on the consumers in a generation constrained power system by the traditional load shedding approach. Additionally, the reduction of the excess curtailment is a prime objective in this paper as it helps the utility companies to reduce wastage and ultimately reduce losses resulting from over shedding. Reducing the peak-to-average ratios (PAR) on the entire network in context as a critical factor in the determination of the efficiency of an electricity network is also investigated. In the long run, the PAR affects the price charged to the final consumer. Simulation results show the associated benefits that include effectiveness, deployability, and scalability of the proposed HOM to reduce these burdens.

INDEX TERMS Demand-side management (DSM), microload management, smart grid, smart metering, optimization, peak-to-average ratio (PAR).

I. INTRODUCTION

There are various reasons why both governments and the electricity utility companies are forced to implement different types of demand-side management (DSM) [1]; three key factors have been identified to influence this. These are the reduction in peaking cost with its associated impact on the environment [2], avoidance of additional expenditure on expansion and providing consumers with options to reduce their electricity consumption and ultimately saving them money [3]. Even more critical is the effects of global warming and the associated climate change threats it poses [4], [5]. The rate of change in the climate is becoming more alarming now than ever [6]. In generation constrained power

systems, where the normal electricity generation cannot even meet the off-peak demand of the consumers, create a different dimension to the pollution caused by peaking as the consumers mostly rely on fossil fuel-powered generator set to get electricity in time of sectional load shedding [7]. For instance, it is estimated that on the average every base transceiver station (bts) in most developing countries is equipped with a diesel-powered generator set [8]. Another way this menace is being handled is the use of renewable energy sources, but they are also intermittent in nature which is a challenge for effective integration [9], [10]. The portion of energy derived from renewable sources in the United Kingdom, for example, have risen significantly from 2009 to 2015 by 6.7% to 24.6% respectively [11]. Meanwhile, the best integration methods of renewable sources of electricity are still under investigation [12], [13].

The associate editor coordinating the review of this manuscript and approving it for publication was Huiping Li.

Sectional power cuts which are known as load shedding used to avoid total blackout or overload on the generation constrained powers systems further create inconveniences for both the consumers and their providers [14]. However, this has become a necessary evil as the failure to forcefully reduce the demand can result in the total collapse of the entire network. The works by Khalid *et al.* [15], Samarakoon *et al.* [16], and Trovato *et al.* [17] illuminate these facts by demonstrating that it would be catastrophic if measures are not put in place to avoid an overload on the electricity grid. Smart grid has the potential to ameliorate the situation with the provision of bidirectional communication amongst smart meter and the energy providers as well as the consumers [18].

Among the potentials of the smart grid is the demand-side Management (DSM). DSM refers to the measures put in place by the providers to influence the consumption behaviour of the end-users [1], [19]. Conventionally, conservation of energy, the substitution of fuel, energy efficiency and demand response are the main DSM schemes observed in literature [20], [21]. DSM in a residential or commercial setting is aimed at the reduction in the need for expensive peaking costs and/or the reduction of overload of the network. This is done through the provision of Time of Use (TOU), Real-Time Pricing (RTP), Critical Peak Pricing (CPP) and other incentives-based billing methods. In most cases, the consumer is promised the minimization of their bills, while they shift or defer the use of their appliances to a cheaper price period representing a win-win for both the electric utility companies and the customers [15], [22].

Prevailing attempts in smart grid research have mostly concentrated on the security and privacy of the smart metering systems and the associated data [23], optimization techniques modeled to minimize bill payments by the consumer [24], [25], PAR, peaking [26], maintaining consumer preferences [27], [28] and exploring the causes of these constraints [29], [30]. For example, retrofitting existing meters into smart meters to do real-time monitoring and evaluation of the grid was considered in [30]. What is, therefore, noticeable in almost all the studies reviewed is that they assume that the cost of peaking is the critical constraint on the overall network as well as the preservation of consumers' comfort of use [31], [32].

Peaking activities on the ozone layer (Carbon Emission) has also been considered by other studies as in [33], [34]. Additionally, generation side approach that could ultimately reduce PAR in the long run, was investigated in [35] where an efficient computational formulation of stochastic scheduling model that combines the optimization of the energy production, optimal scheduling and both under/over frequency responses based load shedding using mixed-integer linear programming was also examined. The focus of their work was to optimized energy production with wind energy generation as a reserve to optimize both operating reserve and the frequency response.

Based on the current research activities in smart grid along with those mentioned above, there is clearly insufficient incorporation of generation constraint situations where the electric utility provider cannot meet the off-peak demand of electricity by the users. Therefore, it is critically important to consider these situations [36]–[39]. Also, the instances where consumers are not provided with such pricing schemes as TOU, CPP, RTP, etc which permits them to alter their electricity usage patterns for some benefits have not been reflected as well in the current research space.

This paper is an extended version of [40] and [14]. The work reported in [40] focuses on the optimization of microload shedding in generation constrained power systems where a distributed DSM system is modeled to combine both traditional electricity grid and smart grid. The assumption has been that the grid is made up of residential loads being served by a single source of generation. Six (6) priority levels of controllable loads were considered and evaluated in the work in [40] where the results showed a significant curtailment of power in addition to expected values. This excess curtailment is therefore seen as additional constrained on both the electric utility providers and their customers.

On the other hand, the second work in [14] further investigated 2% and 5% microload shedding under the 6 priority levels in addition to those in [40]. Additionally, the controllable loads were increased from six (6) to thirty-five (35) priority levels to increase the control to observe the shedding accuracy it presents. The main objective of the proposed system is to reduce the effect of the traditional methods of load shedding in the generation constrained power systems on their consumers. The reduction of PAR was also examined.

However, this paper, in addition to the works reported in [40] and [14], we investigate a heuristic optimization method (HOM) based on the consumers' comfort and its benefits to the electric utility. Three techniques, namely; General Shedding (GS), Priority Based Shedding (PBS) and Excess Reuse Shedding (ERS) were studied for effecting efficient microload shedding. The PBS for six (6) grouped (GPL) microloads was investigated in [40] and extended in [14] to cover the discussions on thirty-five (35) Ungrouped microload (UPL) shedding and the corresponding priority optimization and PAR optimization. This extension focuses on GS of GPL and UPL shedding. Further, the ERS is performed on the GS as Excess Reuse General Shedding (ERGS). Also, the PBS is further conducted using the ERS as Excess Reuse Priority Based Shedding (ERPBS). The results of the GS, PBS, ERGS and ERPBS were then used to further examine the effects on the PAR and the priority optimization.

The essential contributions of this paper are as follows:

- HOM: We focus on enhancing the efficiency of the microload shedding algorithm and evaluate the result based on minimizing the gap between the intended amount of electricity shed and the actual values, and optimizing the priority of the user. We further examine the impact of each approach on the PAR of the

grid in context. To achieve this, we develop GS and PBS algorithms. Furthermore, the concept of ERS was investigated on the GS and PBS as ERGS and ERPBS respectively. The effectiveness of the proposed method is validated by analyzing the performance metrics of the algorithms, which show high significant reduction in the additional shedding associated with various intended sheddings, enhanced user comfort (i.e. maintaining the preferences of the user) through the priority optimization and minimum system PAR.

- To ensure the reduction in the excesses in the microload shedding by GS and PBS we introduce ERS which shows a significant reduction in the associated excesses.
- We show that total blackout can be avoided through the granular reduction of consumers' total energy consumption thereby minimizing the associated inconveniences.
- A novel formulation that considers the demand as an independent variable from the generation (i.e. Normally, generation is forced to follow the demand but when the generation is obviously not enough to meet the demand, there is a need to come up with innovative ways to solve this problem. One way of doing this is to define demand and generation as non-dependent variables. Therefore, instead of treating the generation as a follower of the demand we adjust the demand in relation to the generation) with potential for new perspectives of generation models.

The rest of the paper is organized as follows; Section II shows the System Model while in Section III we discuss the problem formulation. Section VI shows the algorithms making up the HOM and the optimizations discussed along with the set of the simulation parameters. Section IV. Results and discussions are then presented in Section V. We conclude the paper in Section VI.

II. THE SYSTEM MODEL

The System Model is made up of a typical power system structure of generation constrained power system like that of Nigeria and Ghana comprising four (4) key systems namely: Generation, Transmission, Distribution and the end-user. These are categorized into 5 Layers, and the Layer 1 and Layer 2 are considered in this paper. The structure of the grid is shown in Figure 2 where the smart meters is represented as SM (i.e. household equipped with controllable microloads L) as depicted in the Microload Management Smart Metering Architecture in Figure 1 above where Wide Area Network (WAN), Neighborhood Area Network (NAN) and Metering Information System Server (MISS) are clearly shown. We assumed a traditional electricity grid where electricity is generated at a single source and distributed among all consumers. The users consume electricity as at when they require it.

The Load (microloads) is the last level of control and accounts for almost all the total electric energy consumed by the entire Main Power System (MPS) representing the Demand (D) on the overall Power System (PS). It is assumed

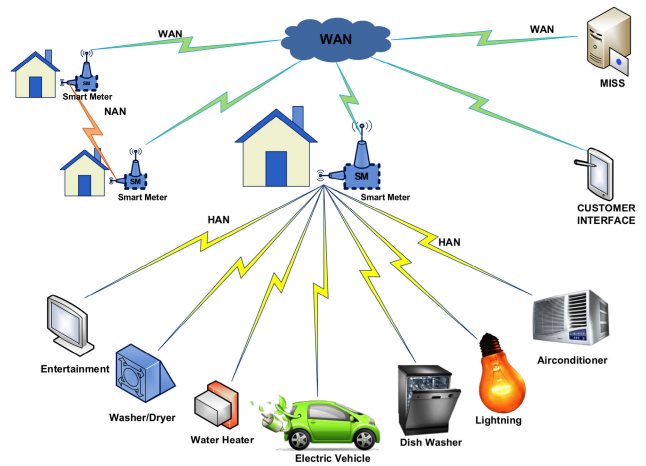

FIGURE 1. Proposed microload management architecture.

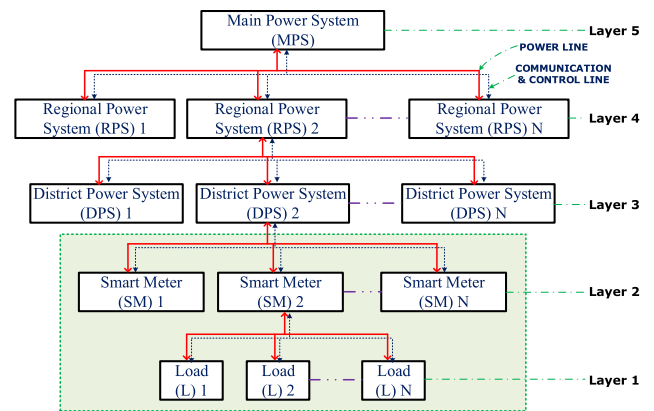

FIGURE 2. Single source power system structure.

that there are no internally self generated electricity at Layer 2. The parameters of each Load are; Rated Current (RC), Voltage (V), Load Power (LP), Status (S = ON or OFF), Priority (Pr), Schedule Status (SS), Load ID (Lid), Control Type (CT) and could be configured to add more parameters. All these parameter are attached to a particular Load.

The Smart Meter (SM) is the main connection to the Loads ($L = L_1, L_2, L_3, \dots, L_n$) directly connected to it. The parameters considered for the purpose of the paper are; Total Consumption (TC = sum of all LPs), Voltage (MV), Current (MC), Number of Controllable Loads (NCL), Meter ID (Mid). The list of home appliances considered for this simulation are shown in Table 1 (in Section II) along with their categorisation for six (6) Priority levels and thirty-five (35) Priority levels and their current ratings.

III. PROBLEM FORMULATION

The cradle of the above research gaps was initially investigated by Azasoo and Boateng in [30] where the causes of such constraints were investigated. Retrofit strategy for designing the smart meters to reduce the cost of acquisition

TABLE 1. Current ratings for GPL 1 to 6.

Item	Apps	I/A	GPL	UPL
1	100W light bulb (Incandescent)	0.43	6	35
2	60W light bulb (Incandescent)	0.26	6	34
3	LED Light Bulb	0.04	6	33
4	25" colour TV	0.65	5	32
5	Clock radio	0.01	5	31
6	Desktop Computer	1.96	5	30
7	Home Internet Router	0.07	5	29
8	Scanner	0.08	5	28
9	TV (19" colour)	0.43	5	27
10	Laptop Computer	0.43	5	26
11	Smart Phone Charger	0.03	5	25
12	Inkjet Printer	0.13	5	24
13	Coffee Maker	6.09	4	23
14	Toaster	7.83	4	22
15	Electric Kettle	13.04	4	21
16	Food Blender	1.74	4	20
17	Microwave	7.39	4	19
18	Oven	9.35	4	18
19	Ceiling Fan	0.33	3	17
20	Electric Blanket	0.87	3	16
21	Electric Heater Fan	13.04	3	15
22	Electric Mower	6.52	3	14
23	Electric Shaver	0.09	3	13
24	Table Fan	0.11	3	12
25	Water Filter and Cooler	0.43	3	11
26	Clothes Dryer	17.39	2	10
27	Hair Blow dryer	10.87	2	9
28	Iron	4.35	2	8
29	Dishwasher	6.52	2	7
30	Power Shower	45.65	2	6
31	Vacuum Cleaner	3.04	2	5
32	Washing Machine	2.17	2	4
33	Lawnmower	6.09	1	3
34	Fridge / Freezer	1.74	1	2
35	Home Air Conditioner	21.74	1	1

and deployment was then proposed. Therefore, in this paper, a distributed DSM system that is modeled to assess the possibilities of reducing the discomforts associated with traditional load shedding by proposing various algorithms and optimization techniques through HOM.

The assumption is that the grid is made up of residential loads being served by a single source of generation. Six (6) controllable loads per household were considered and evaluated and then extended to thirty-five (35) microloads. For the Six (6) controllable loads, it is assumed that a group of similar or closely related electric devices are lumped together as a single controllable group to reduce the overall number of controllers fitted in a house. Four (4) algorithms were proposed and evaluated under the HOM, namely; GS, PBS, ERGS, and ERPBS. The objectives of the proposed HOM is to reduce the impact of the traditional methods of load shedding mechanisms in generation constrained power systems on their users whilst reducing the PAR within the part of the grid in context.

Moreover, optimization of the priority of the microloads is proposed to maximize adherence to consumers' priorities. Consequently, simulation results from the investigation reveals that the proposed HOM is effective in reducing the overall discomfort associated with the traditional load

shedding along with a resultant reduction in PAR and a significant reduction in the excess microload shedding.

The optimization of the available power is intended to reduce the peak to average ratio of the overall grid thereby increasing efficiency of the network and at the same time the proposed priority optimization will help increase customer satisfaction by making sure that their salient loads are not curtailed by the proposed mechanism thereby enhancing customer satisfaction. We denote the rated current of appliance with *Priority* = *p* belonging to *SM* = *m* ∈ *M*, where *M* is the total number of Smart Meters (SM) in a particular District Power System (DPS) as shown in Layer 3 in Figure 1 as:

$$I_p^m$$

The Voltage = *V* of a particular *SM* = *m* ∈ *M* with Priorities = *P* such that *p* ∈ *P* belonging to a particular *DPS* is also denoted as:

$$V_p^m$$

Also, the known consumption of *microload* = *l* ∈ *L* with *priority* = *p* ∈ (*SM* = *m*) is given as:

$$l_p^m$$

Hence, without loss of generality, we compute *l_p^m* as shown in Equation 1.

$$l_p^m = I_p^m V_p^m \tag{1}$$

The Total Load of an *SM* = *m* ∈ *M* at any time *τ*, is then given as:

$$L_m^\tau$$

We compute the *L_m^τ* as follows:

$$L_m^\tau = \sum_{p=1}^n L_p^m \text{ Where } p \mapsto \{n \in P \mid p \leq n\} \tag{2}$$

Therefore, the Total demand *TC* = *D* of all *SMs* (*M* ∋ *m*) in a particular *DPS* is calculated as;

$$D = \sum_{m \in M} L_m^\tau \text{ Where } k \mapsto \{k \in K \mid \tau = 1\} \tag{3}$$

We denote *Ĥ* as the expected demand from a particular *DPS*. Therefore, ideally, *D* = *Ĥ* but that has not always been the case resulting in heavy financial loss to the electricity utility companies along with the additional inconvenience it causes the final consumer. The Total Expected Load of an *SM* = *m* ∈ *M* at any time *τ*, is then given as:

$$d_m^\tau$$

We compute the *Ĥ* as follows:

$$\hat{D} = \sum_{p=1}^n d_m^\tau \tag{4}$$

Our *Objective 1* is to distribute the Expected Demand \hat{D} such that;

$$\text{Objective 1: } \hat{D} \approx \sum_{m \in M}^k \sum_{p=1}^n L_p^m \quad (5)$$

The *Objective 2* is to Maximise the Priority of the consumer so as to meet essential electricity needs. Let denote the Group of load that are not affected by the microload shedding as \hat{P} and those affected as \check{P} so that;

$$P = \hat{P} + \check{P} \quad (6)$$

$$\text{Objective 2} = \text{maximize}(\hat{P}) \quad (7)$$

We denote Pr or P_i as the Priority, being inversely proportional to the Total Priority of the consumer P_T . Where the constant of proportionality is \hat{P} Therefore,

$$Pr \propto \frac{1}{P_T} \quad (8)$$

Hence,

$$Pr = \frac{\hat{P}}{P_T} \quad (9)$$

The *Objective 3* is to Reduce the PAR of the entire Grid in context thereby enhancing network efficiency.

$$\text{Objective 3} = \text{minimise}(PAR) \quad (10)$$

The Equation for PAR at time τ (PAR_τ) is given as:

$$PAR_\tau = \frac{\text{Max Peak of } D \text{ at time } \tau}{\text{Average Max Peaks of } D} \quad (11)$$

Therefore, we compute the PAR at time τ (PAR_τ) as:

$$PAR_\tau = \frac{\text{Max Peak of } (\sum_{m \in M}^k \sum_{p=1}^n L_p^m)_\tau}{\text{Average Max Peaks of } (\sum_{m \in M}^k \sum_{p=1}^n L_p^m)} \quad (12)$$

IV. THE MICROLOAD SHEDDING ALGORITHMS

A key objective of this paper is to optimise the load shedding process in generation constrained power systems. We have identified three key constraints to optimise in order to achieve this objective such that it benefits both the electric utility company, their consumers and more importantly, the environment.

- We reduced the impact of the load shedding by microload managing the demand such that the available generation denoted as D is not exceeded by the demand \hat{D} from the consumers.
- We optimized the microload shedding such that the user set Priorities are adhered to as much as possible by maximizing the Pr in the PBS
- Attempts in [7], [14], [40] show a significant shedding along with the intended amount of load resulting in what is popular known as over-generation. Hence, in this paper we have significantly bridged this gap existing between the available generation D and the actual demand \hat{D} through the proposed HOM approach

- By making available some amount of electricity to the consumers, we immensely reduced the PAR of the entire DPS under consideration from an undefined state (i.e because there is no consumption during the time of traditional load shedding) to a (PAR_τ) as shown in Equation 11.

Algorithm 1 GS & PBS Server Side

```

1 Initialization;
2 Get Total GS Demand D;
3 Input Grid Section (GS);
4 Get N i.e. total number of SM in GS;
5 Input Total Expected Demand  $\hat{D}$ ;
6 Compute Percentage Expected Demand  $d_m\%$  per SM;
7 for Grid = 1 to Gridmax do
8   while m <= N do
9      $d_m\% = \frac{\hat{D}}{D} * 100$ ;
10    if m = N then
11      Return False;
12    else
13      end if
14      Perform the SM Side Optimization algorithm in
        Algorithm 2;
15    end while
16    Display Current Total Demand D;
17    Update the GS;
18 end for

```

1) THE GS AND PBS ALGORITHMS

The concept of the GS has to do with the idea that there are no priorities set for the microloads such that each microload is handle based solely on their ratings to reduce the overall demand. On the other hand, the PBS considers the priority of the microloads in the cutting OFF the loads, this is assumed to have been set by the end user. We confront the constraints from two angles; Server Side and the SM side as shown in Algorithm 1 which represents the algorithm on the server for both GS and PBS, the Algorithm 2 for the SM side of the GS and a flowchart of the SM side of the PBS in Figure 3. L_p^m represents the load of the home appliance where m is the SM number and P is the microload number and at the same time, L_p^m is represented as L_p kW in the flowchart shown in Figure 3.

Inferring from privacy issues expressed in previous works with respect to the consumer, we restrict microload consumption information sharing to the utility by sending only the required amount of load to be shed to the user SMs as a percentage $d_m\%$. The optimization Algorithm 2 is performed with the aim of efficiently allocating the available generation at the SM levels. Hence, we compute the Expected Demand per SM at the Server side as percentage demoted as $d_m\%$ so that it can be sent across the network privately. Each SM is therefore required to compute its d_m from the $d_m\%$.

Algorithm 2 GS Smart Meter (SM) Side Algorithm

```

1 initialization;
2 Set  $L_m$  to 0.00 kW;
3 Get  $d_m^t$ ;
4 Compute Expected Demand per SM ( $d_m$ );
5  $d_m = d_m\% * d_m^t$ ;
6 for  $p = 1$  to  $p_{max}$  do
7    $L_m = L_m + L_p$ ;
8   if  $L_m < d_m$  then
9     Turn OFF  $L_p$ ;
10  end if
11  if  $L_m \geq d_m$  then
12     $L_m = L_m - L_p$ ;
13    Update Server with  $L_m$ ;
14  end if
15 end for
    
```

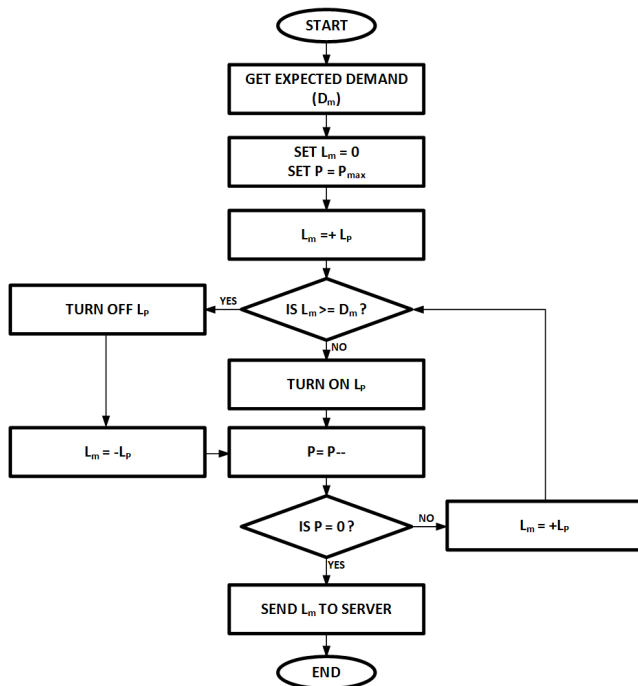

FIGURE 3. PBS smart meter (SM) side algorithm.

Simulation results from these techniques are discussed in Section IV.

2) THE ERS ALGORITHMS (ERGS AND ERPBS)

After observing the excess sheddings along with the intended values termed as overshedding as seen in our work in [40] and [14], ERS is developed to reuse the excess from an initial SM to the next successive SM. For general shedding, ERGS is used and ERPBS is used in the case of the priority based shedding. Algorithms 3 and Algorithm 4 depict the sequence of these approaches respectively.

Algorithm 3 ERGS Algorithm

```

1 Initialization;
2 Get Total GS Demand D;
3 Input Grid Sections (GS);
4 Get N i.e. total number of SM in GS;
5 Set ER = 0.00 kW;
6 Input Total Expected Demand  $\hat{D}$ ;
7 Compute Percentage Expected Demand  $d_m\%$  per SM;
8  $d_m\% = \frac{\hat{D}}{D} * 100$ ;
9 for Grid = 1 to Grid_max do
10  Set  $L_m = 0.00$  kW;
11  for  $m = 1$  to N do
12    Compute Expected Demand per SM ( $d_m$ );
13     $d_m = d_m\% * d_m^t$ ;
14     $D_m = d_m + ER$ ;
15    if  $ER < 0$  then
16       $D_m = d_m$ ;
17    end if
18    for  $p = 1$  to  $p_{max}$  do
19       $L_m = L_m + L_p$ ;
20      if  $L_m < D_m$  then
21        Turn OFF  $L_p$ ;
22      end if
23      if  $L_m > D_m$  then
24         $L_m = L_m - L_p$ ;
25         $ER = D_m - L_m$ ;
26        Update Server with  $L_m$  &  $ER$ ;
27      end if
28    end for
29    Display Current Total Demand D;
30    Update the GS;
31  end for
32 end for
    
```

V. SIMULATION SETUP

The simulation is setup such that a single source of generation is assumed to be serving the entire grid in context. The grid is made up of twenty six (26) homes which are equipped with a maximum of uniquely identifiable thirty-five (35) microloads. Firstly, we grouped the loads into six (6) priority groups. It is assumed that the users assign the priorities to their appliances or the groupings. We refer to this grouped loads as Grouped Priority Loads (GPL). GS, PBS, ERGS and ERPBS are performed on the microloads. Secondly, we identified each microload with unique priorities as also assumed to be assigned by the consumers themselves. Collectively, we refer to this load category as Ungrouped Priority Loads (UPL). We then repeat the simulation for this set of microloads. The possible combinations of microloads per a household is shown in Table 1. The total consumption per microload with priority p on SM m is represented by Equation 1 as I_p^m .

Algorithm 4 ERPBS Algorithm

```

1 Initialization;
2 Get Total GS Demand D;
3 Input Grid Sections (GS);
4 Get N i.e. total number of SM in GS;
5 Set ER = 0.00 kW;
6 Input Total Expected Demand  $\hat{D}$ ;
7 Compute Percentage Expected Demand  $d_m\%$  per SM;
8  $d_m\% = \frac{\hat{D}}{D} * 100$ ;
9 for Grid = 1 to Gridmax do
10   Set  $L_m = 0.00$  kW;
11   Set  $P_T = 0$ ;
12   for  $m = 1$  to N do
13     Compute Expected Demand per SM ( $d_m$ );
14      $d_m = d_m\% * d_m^r$ ;
15      $D_m = d_m + ER$ ;
16     if  $ER < 0$  then
17       |  $D_m = d_m$ ;
18     end if
19     Sort Priority P per microload i in SM m as ( $P_i$ )
    in Ascending order;
20     for  $i = 0$  to I - 1 do
21       HoldSub = i;
22       for  $k = i + 1$  to I - 1 do
23         if  $P[k] < P[HoldSub]$  then
24           | HoldSub = k;
25         end if
26       end for
27       HoldTemp =  $P[i]$ ;
28        $P[i] = P[HoldSub]$ ;
29        $P[HoldSub] = HoldTemp$ ;
30     end for
31     for  $p = 1$  to  $p_{max}$  do
32        $L_m = L_m + L_p$ ;
33        $P_T = P_T + P[i]$ ;
34       if  $L_m < D_m$  then
35         | Turn OFF  $L_p$ ;
36       end if
37       if  $L_m > D_m$  then
38         |  $L_m = L_m - L_p$ ;
39         |  $P_T = P_T - P[i]$ ;
40         |  $ER = D_m - L_m$ ;
41         | Update Server with  $L_m, P_T$  and  $ER$ ;
42       end if
43     end for
44     Display Current Total Demand D;
45     Update the GS;
46   end for
47 end for

```

VI. RESULTS AND DISCUSSIONS

We present simulation results and evaluate the performance of the HOM in this section. The works [40] and [14] presented the results for GPL and UPL using the PBS for

a 20%, 15%, 10%, 5%, and 2% microload shedding. The subsections below show the results of the GPL microload shedding and that of the UPL microload shedding and how the two approaches compare. Furthermore, we show how the PBS approach affect the Peak Average Ratio (PAR) and the Priority Optimizations.

A. GROUPED PRIORITY LOADS (GPL)

This section discusses the results obtained from grouping the microloads into 6 priorities groups. The higher priorities are assigned high priority numbers (i.e. the higher the priority the more user prefers the devices in that category to remain ON during microload shedding periods). 10%, 15%, and 20% microload shedding requests were conducted in that order. However, we only discuss the results of 10% and 20% microload shedding. The GS microload shedding assumes that the priorities of all the microloads are the same (i.e. in this case $P = 1$ for all microloads) and the PBS assumes uniquely varied priorities per microload as shown in Table 1. Expected Demand is given as (D_m) where General Shedding (GS), Priority based shedding (PBS), Excess Reuse General Shedding (ERGS), and Excess Reuse Priority Based Shedding (ERPBS) were performed.

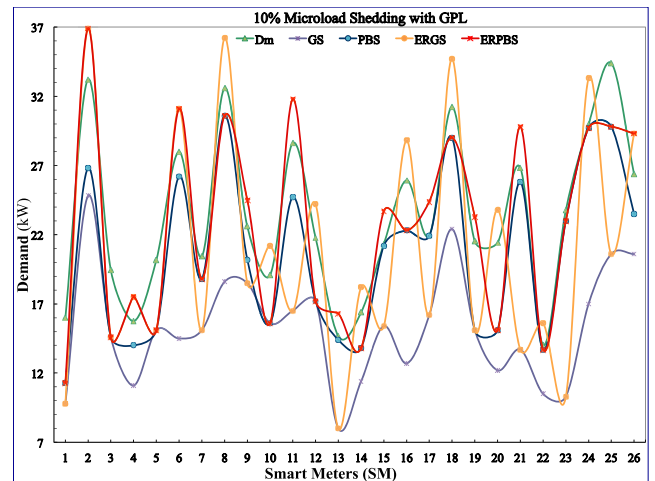
**FIGURE 4.** 10% GPL microload shedding.

The total demand from the 26 SMs was observed to be 674.90kW at the beginning of all simulations. Figure 4 and Figure 5 show the results of GPL microload sheddings for 10% and 20% requests for microload shedding respectively. As shown in Figure 4, a 10% microload management was performed on the same consumption profile of 26 SMs consuming a total of 674.90kW with expected demand of 607.41kW. However, the effectual total demand recorded for this was 397.50kW, 533.40kW, 539.70kW, and 588.20kW for GS, PBS, ERGS, and ERPBS techniques respectively. The lowest excess shedding is observed on ERPBS with total excess of 19.21kW and the largest excess shedding is seen to be 209.91kW on GS.

The distribution of all the SMs for the various techniques with 10% microload shedding with GPL is shown in Figure 4.

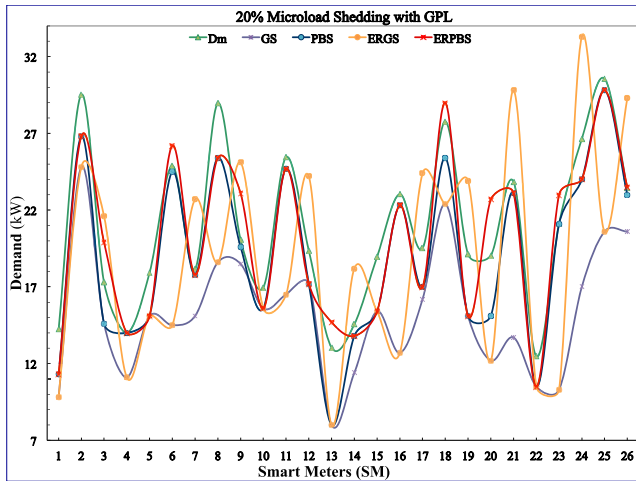

FIGURE 5. 20% GPL microload shedding.

GS is observed to have the overall highest excess shedding as seen on SM6, SM8, SM11, SM16, SM21, SM23, SM24, and SM25. On the other-hand, the lowest excess shedding is observed on ERPBS with the highest in it being seen at SM20 but generally all SMs in the ERPBS experienced very minimal excess shedding. Some SMs experienced more demand than the expected demand as in SM2 and many others. This could be as a result of the reuse of the excess from the previous SMs resulting in higher capacity for the current one.

The Figure 5 shows the result of performing various HOM techniques on the grouped microloads with a 20% request for shedding. The aim is to reduce the gap between the Dm and the microload shedding. It is observed that GS performed the worse compared to PBS. The best PBS results were observed on SM4, SM5, SM9, SM21, SM23, and SM36. Even-though the ERGS appears to be quiet closer to the Dm as compared to the GS and PBS, the ERPBS is observed to be the closest again and even sometimes better; as seen SM3, SM7, SM13, SM18, SM21, and SM23. The over performance of the ERPBS is due to the excess reuse of the curtailed consumption from previous SMs which enables the SM in focus to have more available power to be shed amongst its microloads. This excess could make the available capacity greater than the expected demand (Dm) thereby resulting in higher availability for a particular SM and eventually resulting in the observations from the ERPBS on SM3, SM7, SM13, SM18, SM21, and SM23.

B. UNGROUPED PRIORITY LOADS (UPL)

This subsection focuses on discussions of the results from treating individual microloads with their own priorities to increase the granularity of the microloads with the priorities assumed to have been assigned by the users (see Table 1.) Actual microload shedding of 277.40kW, 141.50kW, 135.20kW, and 86.70kW were recorded when the system was subjected to a 10% microload shedding on GS, PBS, ERGS, and ERPBS respectively. Actual percentage

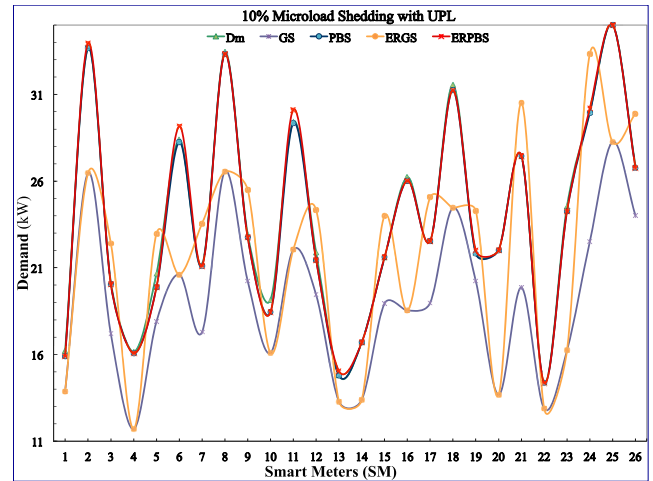

FIGURE 6. 10% ungrouped microload shedding.

microload shedding of 31%, 12%, 20%, and 11% was observed as against the required 10% microload shedding where the highest over-shedding is observed on the GS. ERPBS recorded less than 1% excess as shown in Figure 6. It is observed that increasing granularity lowers the excess shedding since there are more microloads to handle specific shedding requests. From the Figure 6, the most efficient sheddings are observed when employing the ERPBS and PBS. The highest over-shedding is seen on the GS and ERGS. The lower values of recorded for the excess sheddings could be attributed to the increased granularity of the microloads.

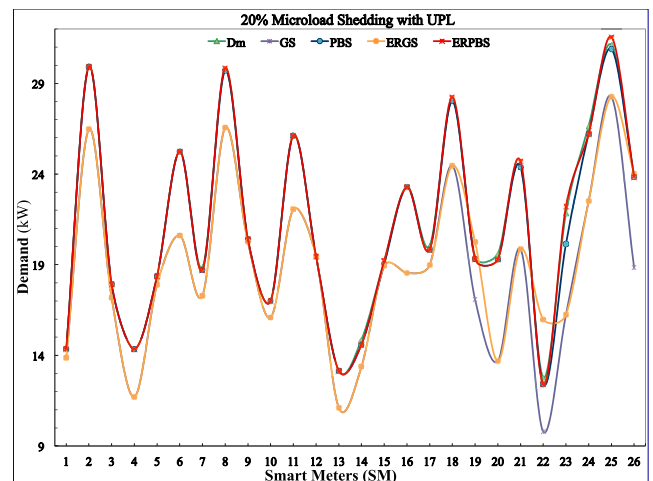

FIGURE 7. 20% ungrouped microload shedding.

The system was then subjected to a 20% microload shedding with the results shown in Figure 7 where excess of 69.09kW, 4.25kW, 54.56kW, and 0.63kW for GS, PBS, ERGS, and ERPBS respectively using the UPL consumption profiles of the 26 homes. The PBS and ERPBS continued to outperform the GS and the ERGS using the UPL profiles. GS similar patterns from SM1 until SM18 where ERGS begins to slightly outperform the GS on SM19,

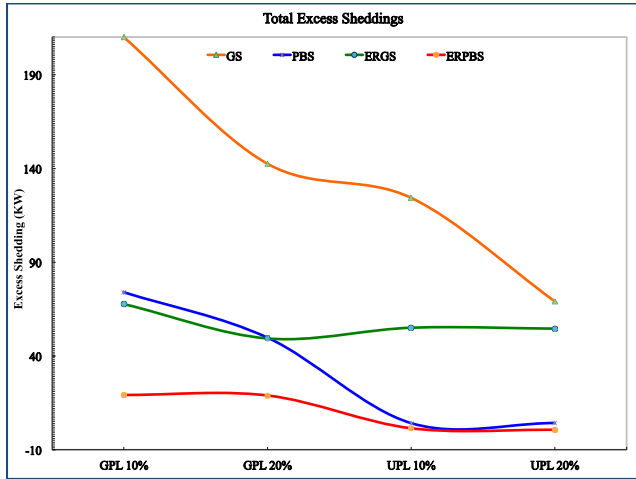

FIGURE 8. Overall grouped and ungrouped excess microload sheddings.

SM22 and SM26. A combination of two factors could have accounted for this; the excess reuse and the increased granularity as discussed in the GPL and the 10% UPL approaches.

The comparison between the Grouped and Ungrouped microload shedding resulting in 6 and 35 priority levels of microloads (i.e. GPL and UPL) is shown in the Figure 8. It can be seen that there is a significant reductions in all the excess load shedding in the Grouped loads shedding compared to the Ungrouped microload shedding performed. Whilst the attempt to microload manage six (6) grouped loads based on their group priorities resulted in a better availability for the user based on their own set priorities, it is clear that the excess load shed along with the desired values could result in huge financial loss to the electricity utility companies.

Increasing the controllable loads by increasing the granularity of the controllable microloads from six (6) to thirty-five (35), resulted in a better value of the overall demand on the network during the constrained generation periods. The gap between the actual demand and the expected demand has been significantly reduced as shown in the Figure 8. Overall the sum of all the excess microload shedding in the GPL and the UPL respectively was 631.22kW and 313.43kW representing an improvement of 317.79kW over the grouped microload management just by increasing the granularity of the loads.

C. THE PEAK-TO-AVERAGE RATIO (PAR) AND PRIORITY OPTIMISATIONS

The PAR is computed by assuming that from Equation 11, the *Max Peak of D at time τ* is assumed to be the maximum demand after effecting a microload shedding. Also, the *Average Max Peaks of D* is assumed the average of the total demand before and after microload shedding. We focused only on the results of employing the PBS technique on 2%, 5%, 10%, 15%, and 20% using GPL and UPL consumption profiles of the 26 SMs for both PAR and the Priority optimisations. The results obtained are shown in Figure 9.

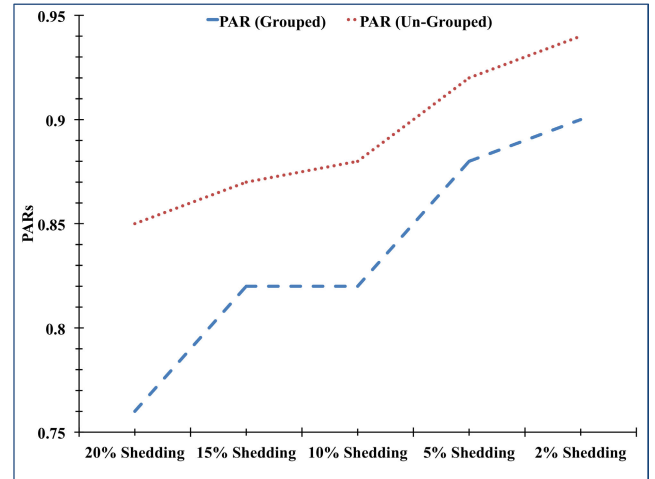

FIGURE 9. Grouped and ungrouped microload shedding PARs.

It can be observed that the PAR under the traditional load shedding of completely blocking or turning OFF Homes (SMs) would have been mathematically impossible as it would have been undefined as a result of division by zero (0). However, the researchers were expecting a further improvement in PAR as the granularity of microloads increases from 6 for GPL to 35 for UPL microloads but the results obtained showed otherwise as depicted in Figure 9. Also, the best PARs are being recorded when higher percentage microloads are being shed which, shows that the lesser the amount of load shed the more significant it affects the PAR of the grid in context.

Base on Equation 8, where Pr is the Priority and is inversely proportional to the Total Priority of the consumer P . With the constant of proportionality is \hat{P} , we assumed that when all the microloads are ON in a particular household it will result in a Unity Pr ($Pr = 1$). Therefore Unity Pr is the ideal situation of demand for the network in context. However, in times of traditional load shedding the Pr is traditionally 0. The paper aims to make the Pr close to Unity Pr as much as possible. The Pr distribution of the entire network under GPL and UPL microload shedding conditions are shown in Table 2.

TABLE 2. Priorities distributions for GPL and UPL.

Item	20%	15%	10%	5%	2%
\hat{P} GPL	500	507	510	515	518
\hat{P} UPL	46	39	36	31	28
Pr GPL	0.9158	0.9286	0.9341	0.9432	0.9487
\hat{P} UPL	16179	16227	16271	16306	16330
\hat{P} UPL	201	153	109	74	50
Pr UPL	0.9877	0.9907	0.9933	0.9955	0.9969

The results show that the Pr approaches Unity as the percentage microload load shedding reduces from 20% to 2%. The Pr seen in the GPL microload shedding appears to be

lower than those recorded under the UPL microload shedding results. It is clear that the higher the number of controllable microloads the better the consumers' priority are preserved.

VII. CONCLUSION

In this paper, we examine the most effective ways of reducing the impact of traditional load shedding of electricity in generation constrained power systems on the consumers within the context of the smart grid. Algorithms to efficiently allocate the available generation are investigated. Dynamic programming based algorithms are developed to achieve this constraint by uniquely controlling home appliances to reduce the overall electricity demands. This was achieved through, heuristic optimization method (HOM) based on the consumers' comfort and the resultant benefits to the electricity utility company. The validation of the proposed HOM is achieved by implementing microload management with three techniques; General Shedding (GS), Priority Based Shedding (PBS) and Excess Reuse Shedding (ERS) for effecting efficient microload shedding. A significant reduction in the excess curtailment was achieved as it helps the utility companies to reduce wastage and ultimately reduce losses resulting from over shedding. There was a reduction of the over-shedding from 69.09kW to 0.63kW after employing various HOM techniques using the UPL consumption profiles. Additionally, the actual percentage shedding was also improved from 31% to 11% when subjected to a 10% shedding using the GPL load profiles.

However, peak-to-average ratios (PAR) on the entire network in context was expected to have a further improvement as the granularity of microloads increases from 6 for GPL to 35 for UPL microloads but the results obtained showed otherwise. Also, in times of traditional load shedding the Pr is traditionally 0. The paper aims to make the Pr close to Unity Pr as much as possible. The Pr distribution of the entire network under GPL and UPL microload shedding conditions showed that increasing the granularity of the microloads increases the preservation of the customers' set priorities.

The efficient allocation of available scarce electricity resources to a household that would have been otherwise entirely switched OFF, the paper increases the availability of the electricity, which is a crucial parameter in the determination of the network efficiency. As a result, the PAR was moved from an undefined state to an average of 0.84 and 0.89 for GPL and UPL microloads profiles respectively. By efficiently allocating the available electricity do consumers would reduce the dependence on massive fossil fuel-based generators sets which could have positive implications for global warming. The simulation was based on ratings of selected domestic appliances.

A future direction would be the development of load profile dynamically based on various consumption patterns such as those from the Tropical and Temperate regions of the world such as West Africa and the United Kingdom consumption patterns. The proposed HOM presented in this paper

even-though focused on electricity, could also be adapted for other scarce resources such as water and gas.

REFERENCES

- [1] B. P. Esther and K. S. Kumar, "A survey on residential Demand Side Management architecture, approaches, optimization models and methods," *Renew. Sustain. Energy Rev.*, vol. 59, pp. 342–351, Jun. 2016.
- [2] A. Heydari, F. Keynia, D. A. Garcia, and L. De Santoli, "Mid-term load power forecasting considering environment emission using a hybrid intelligent approach," in *Proc. 5th Int. Symp. Environ.-Friendly Energies Appl. (EFEA)*, Sep. 2018, pp. 1–5.
- [3] H. Yang, L. Wang, and Y. Ma, "Optimal time of use electricity pricing model and its application to electrical distribution system," *IEEE Access*, vol. 7, pp. 123558–123568, 2019.
- [4] X. Yu, L. Jin, Q. Wang, and D. Zhou, "Optimal path for controlling pollution emissions in the Chinese electric power industry considering technological heterogeneity," *Environ. Sci. Pollut. Res.*, vol. 26, no. 11, pp. 11087–11099, Apr. 2019.
- [5] W. Chen, K. Zhou, and S. Yang, "Evaluation of China's electric energy efficiency under environmental constraints: A DEA cross efficiency model based on game relationship," *J. Cleaner Prod.*, vol. 164, pp. 38–44, Oct. 2017.
- [6] C. B. Field, *Climate Change 2014—Impacts, Adaptation and Vulnerability: Regional Aspects*. Cambridge, U.K.: Cambridge Univ. Press, 2014.
- [7] J. Q. Azasoo, E. Kuada, K. O. Boateng, and M. O. Agyeman, "An algorithm for micro-load shedding in generation constrained electricity distribution network," in *Proc. IEEE PES PowerAfrica*, Jun. 2017, pp. 396–401.
- [8] J. S. Ojo, P. A. Owolawi, and A. M. Atoyé, "Designing a green power delivery system for base transceiver stations in Southwestern Nigeria," *SAIEE Afr. Res. J.*, vol. 110, no. 1, pp. 19–25, Mar. 2019.
- [9] *Power Cut: National Grid Promises to Learn Lessons From Blackout*. BBC, London, U.K., Aug. 2019.
- [10] Y. Dong, T. Zhao, and Z. Ding, "Demand-side management using a distributed initialisation-free optimisation in a smart grid," *IET Renew. Power Gener.*, vol. 13, no. 9, pp. 1533–1543, Jul. 2019.
- [11] K. Harris, A. Annut, and I. MacLeay, "Digest of United Kingdom energy statistics, 2015," Dept. Bus. Energy Ind. Strategy, London, U.K., Tech. Rep., 2016. [Online]. Available: https://assets.publishing.service.gov.uk/government/uploads/system/uploads/attachment_data/file/454482/DUKES_2015_internet_content.pdf
- [12] S. Sannigrahi, S. Roy Ghatak, and P. Acharjee, "Multi-objective optimisation-based active distribution system planning with reconfiguration, intermittent RES, and DSTATCOM," *IET Renew. Power Gener.*, vol. 13, no. 13, pp. 2418–2429, Oct. 2019.
- [13] N. Javaid, I. Ullah, M. Akbar, Z. Iqbal, F. A. Khan, N. Alrajeh, and M. S. Alabed, "An intelligent load management system with renewable energy integration for smart homes," *IEEE Access*, vol. 5, pp. 13587–13600, 2017.
- [14] J. Azasoo, T. Kanakis, A. Al-Sherbaz, and M. O. Agyeman, "Optimal demand side management in generation constrained power systems," in *Proc. IEEE Smart World Congr.*, Apr. 2019.
- [15] A. Khalid, N. Javaid, M. Guizani, M. Alhoussein, K. Aurangzeb, and M. Ilahi, "Towards dynamic coordination among home appliances using multi-objective energy optimization for demand side management in smart buildings," *IEEE Access*, vol. 6, pp. 19509–19529, 2018.
- [16] K. Samarakoon, J. Ekanayake, and N. Jenkins, "Investigation of domestic load control to provide primary frequency response using smart meters," *IEEE Trans. Smart Grid*, vol. 3, no. 1, pp. 282–292, Mar. 2012.
- [17] V. Trovato, I. M. Sanz, B. Chaudhuri, and G. Strbac, "Advanced control of thermostatic loads for rapid frequency response in great britain," *IEEE Trans. Power Syst.*, vol. 32, no. 3, pp. 2106–2117, May 2017.
- [18] X. Fang, S. Misra, G. Xue, and D. Yang, "Smart grid—The new and improved power grid: A survey," *IEEE Commun. Surveys Tutr.*, vol. 14, no. 4, pp. 944–980, 4th Quart., 2012.
- [19] E. C. J. R. C. I. for Energy, Transport, V. Giordano, A. Meletiou, C. F. Covrig, A. Mengolini, M. Ardelean, G. Fulli, M. S. Jiménez, and C. Filiou, *Smart Grid Projects Europe: Lessons Learned Current Developments: 2012 Update*. Brussels, Belgium: Publications Office of the European Union, 2013.
- [20] M. H. Yaghmaee, M. Moghaddassian, and A. Leon-Garcia, "Autonomous two-tier cloud-based demand side management approach with microgrid," *IEEE Trans. Ind. Informat.*, vol. 13, no. 3, pp. 1109–1120, Jun. 2017.

- [21] V. Venizelou, N. Philippou, M. Hadjipanayi, G. Makrides, V. Efthymiou, and G. E. Georghiou, "Development of a novel time-of-use tariff algorithm for residential prosumer price-based demand side management," *Energy*, vol. 142, pp. 633–646, Jan. 2018.
- [22] D. Li, W.-Y. Chiu, H. Sun, and H. V. Poor, "Multiobjective optimization for demand side management program in smart grid," *IEEE Trans. Ind. Informat.*, vol. 14, no. 4, pp. 1482–1490, Apr. 2018.
- [23] S. Tweneboah-Koduah, A. K. Tsetse, J. Azasoo, and B. Endicott-Popovsky, "Evaluation of cybersecurity threats on smart metering system," in *Information Technology-New Generations*. Cham, Switzerland: Springer, 2018, pp. 199–207. [Online]. Available: <https://www.springer.com/gb>
- [24] S. Aslam, Z. Iqbal, N. Javaid, Z. Khan, K. Aurangzeb, and S. Haider, "Towards efficient energy management of smart buildings exploiting heuristic optimization with real time and critical peak pricing schemes," *Energies*, vol. 10, no. 12, p. 2065, Dec. 2017.
- [25] M. Naz, Z. Iqbal, N. Javaid, Z. Khan, W. Abdul, A. Almogren, and A. Alamri, "Efficient power scheduling in smart homes using hybrid grey wolf differential evolution optimization technique with real time and critical peak pricing schemes," *Energies*, vol. 11, no. 2, p. 384, Feb. 2018.
- [26] Y. Wang, W. Yang, and T. Liu, "Appliances considered demand response optimisation for smart grid," *IET Gener., Transmiss. Distrib.*, vol. 11, no. 4, pp. 856–864, Mar. 2017.
- [27] P. Braun, L. Grune, C. M. Kellett, S. R. Weller, and K. Worthmann, "A distributed optimization algorithm for the predictive control of smart grids," *IEEE Trans. Autom. Control.*, vol. 61, no. 12, pp. 3898–3911, Dec. 2016.
- [28] M. Rasheed, N. Javaid, M. Awais, Z. Khan, U. Qasim, N. Alrajeh, Z. Iqbal, and Q. Javaid, "Real time information based energy management using customer preferences and dynamic pricing in smart homes," *Energies*, vol. 9, no. 7, p. 542, Jul. 2016.
- [29] T. Sanni, A. Adoghe, P. Amaize, and C. Ajaegbu, "Smart metering system: A solution for adoption in developing countries," in *Proc. IEEE PES/IAS PowerAfrica*, Jun. 2018, pp. 623–627.
- [30] J. Q. Azasoo and K. O. Boateng, "A retrofit design science methodology for smart metering design in developing countries," in *Proc. 15th Int. Conf. Comput. Sci. Appl.*, Jun. 2015, pp. 1–7.
- [31] C. Akasiadis and G. Chalkiadakis, "Mechanism design for demand-side management," *IEEE Intell. Syst.*, vol. 32, no. 1, pp. 24–31, Jan. 2017.
- [32] N. Shaheen, N. Javaid, N. Nisa, A. M. Zeb, Z. A. Khan, and U. Qasim, "Appliance scheduling for energy management with user preferences," in *Proc. 10th Int. Conf. Innov. Mobile Internet Services Ubiquitous Comput. (IMIS)*, Jul. 2016, pp. 328–334.
- [33] B. Lokeshgupta and S. Sivasubramani, "Multi-objective dynamic economic and emission dispatch with demand side management," *Int. J. Electr. Power Energy Syst.*, vol. 97, pp. 334–343, Apr. 2018.
- [34] H. Liang, Y. Liu, F. Li, and Y. Shen, "A multiobjective hybrid bat algorithm for combined economic/emission dispatch," *Int. J. Electr. Power Energy Syst.*, vol. 101, pp. 103–115, Oct. 2018.
- [35] F. Teng and G. Strbac, "Full stochastic scheduling for low-carbon electricity systems," *IEEE Trans. Autom. Sci. Eng.*, vol. 14, no. 2, pp. 461–470, Apr. 2017.
- [36] A. Adewuyi and Z. Emmanuel, "Electricity outages and firm performance across the six Geo-political zones in Nigeria: The role of corruption," MPRA, Munich Univ., Munich, Germany, Tech. Rep., 2018. [Online]. Available: <https://mpra.ub.uni-muenchen.de/92089/>
- [37] W. in Africa. (2016). *Ghana Promises End to Black Outs*. [Online]. Available: <http://www.wantedinafrica.com/news/ghana-promises-end-to-black-outs/>
- [38] A. N. Online. (2017). *Sa Heatwave Forces Blackouts to Cope With Electricity Demand, Angering Government*. [Online]. Available: <http://www.abc.net.au/news/2017-02-08/sa-heatwave-forces-rolling-blackouts-angering-government/8252512>
- [39] News24. (2014). *Tripped Coal Stations Add to Load Shedding Burden*. [Online]. Available: <http://www.fin24.com/Economy/Tripped-coal-stations-add-to-load-shedding-burden-20141205>
- [40] J. Q. Azasoo, T. Kanakis, A. Al-Sherbaz, and M. O. Agyeman, "Improving electricity network efficiency and customer satisfaction in generation constrained power system," in *Proc. 6th Int. Conf. Control, Decis. Inf. Technol. (CoDIT)*, Apr. 2019, pp. 2010–2015.



JULIUS QUARSHIE AZASOO (Member, IEEE) received the B.Sc. degree (Hons.) in electrical and electronics engineering and the Master of Philosophy degree in computer engineering from the Kwame Nkrumah University of Science and Technology (KNUST), Ghana, in 2008 and 2012, respectively. He was a BSS and a Transmission Engineer with Huawei Technologies and a Data Network Engineer with Vodafone. Before his Ph.D. Candidature at the University of Northampton, he was a Faculty Member at the School of Technology, Ghana Institute of Management and Public Administration (GIMPA), where he lectured in Electronics circuits, Embedded Systems, Numerical Methods, Computer Networking, and so on. His research interests are smart grid, wireless sensor networks, artificial intelligence, the Iot, the Internet of Everything, and so on.



TRIANAFYLOS KANAKIS (Member, IEEE) received the B.Eng. degree in communication systems engineering from the University of Portsmouth, the M.Sc. degree in mobile and personal communications from the King's College London, and the Ph.D. degree from the University of Greenwich. Since 2014, he has been a Senior Lecturer of computing with the University of Northampton, where he leads the Computer Networks Engineering Programme. He has contributed to more than 60 articles. His research interests are in the field of wireless and mobile communications, the Internet of Things and the Internet of Everything, wireless channel models, and so on.



ALI AL-SHERBAZ (Member, IEEE) received the M.Sc. degree in electronic and communication engineering, Baghdad, Iraq, and the Ph.D. degree in mobile/wireless communications and network security from the University of Buckingham-U.K. He is also the Faculty Research Leader and an Associate Professor with the Faculty of Arts, Science and Technology, University of Northampton, U.K., and a skilled Senior Research Engineer with the University of Buckingham. He has twenty five years theoretical and practical experience in researching and teaching at various universities both in the Middle East and U.K., with good experience in both academic and industrial projects. He published more than 60 articles, including patents, books, book chapters, journal and conference papers, and act as a Keynote Speaker in several international conferences.



MICHAEL OPOKU AGYEMAN (Senior Member, IEEE) received the B.Sc. degree (Hons.) in electrical and electronics engineering from KNUST, Ghana, the M.Sc. degree in embedded and distributed systems from London South Bank University, U.K., and the Ph.D. degree in embedded and distributed systems from Glasgow Caledonian University, U.K. He is currently a Senior Lecturer of computer systems engineering with the Department of Computing, University of Northampton, U.K. His research interests include VLSI SoC, computer architecture, reconfigurable computing, and so on. He is also a Chartered Engineer (CEng) of the IET and a Fellow of Higher Education Academy, U.K.

• • •