



BRINGING TOMORROW'S INNOVATION TODAY.



PRODUCT CATALOG

Founded on May 2004, Halden Galway International Corporation was set-up by a group of entrepreneurs who wanted to make a mark in the car care industry. They achieved this by creating and innovating professional-grade products available at a reasonable price. Upholding key attributes such as Quality, Cost Efficiency and Environmentally Friendly, the company began developed and distributed its own line of consumer products under the named Microtex®.

The company's initial line-up included Microtex® Ultimate Cleaning Cloths and Microtex® Car Care Solutions. Then, the portfolio was further expanded in 2010 with the introduction of PRO Choice® - a line designed specifically for professionals to provide dependable, high-volume, and competitively-priced items that are guaranteed to improve business performance.

In 2012, the company introduced a new label called Glàz®, which is the latest revolution in glass and plastic care, restoration and maintenance.

Aside from consumers and professionals, Halden Galway International Corporation also supplies customized products. It is now a well-established original equipment manufacturer (OEM) as well as original design manufacturer (ODM).

Halden Galway International Corporation distributes the Microtex®, PRO Choice® and Glàz® brands throughout the Philippines and international markets through its network of distribution partners. Its headquarters is based in the Philippines with a main manufacturing facility located in Kajang, Malaysia. The Malaysian manufacturing facility has over 30 years of experience in manufacturing home care and industrial formulation as well as over 20 years of experience formulating car care products.

The Evolution of Microtex Logo

OLD



Microtex®

NEW



MTX
MICROTEX®

The first Microtex® logo was created with the microfiber products in mind, hence the focus on MICRO-tex to highlight it's Ultimate Cleaning Cloth brand of car care product. A new logo was created in 2017 when the company expanded its brands. The new MTX-Microtex® logo sports a modern and dynamic look with three color bars to symbolize the company's product lines: microfiber cloths, car & glass care and detailing products, and industrial grade products.



OUR BRANDS:



MTX
MICROTEX®

PROCHOICE™

glàz®

| | |
|----|---|
| 2 | Ultimate Cleaning Cloths |
| 5 | Cleaning & Detailing Tools |
| 7 | Car Care Solutions |
| 11 | Nano Series |
| 12 | Supra Series |
| 14 | PerfectBUFF™ Buffing Pads & Accessories |
| 16 | Comparison & Product Guide |
| 18 | Detailing & Refinishing Chart |
| 20 | Car Care & Maintenance Chart |
| 21 | Glàz® |
| 24 | PROChoice® |
| 26 | MTX® Bike Pro Series |
| 28 | Accessories |





ULTIMATE CLEANING CLOTHS



MTX Ultimate Cleaning Cloths are made from ultra fine threads called microfibers. It has a special blend of 80% polyester and 20% nylon that gives it unparalleled absorbing, cleaning, dusting, buffing, and polishing qualities. Microfibers are subjected to a special process where each strand is split into 16 sections with 16 interval spaces. The resulting triangular sections are polyester wedged into nylon core (Illustration A-1). Microscopic pockets in the wedge-shaped cross section trap dirt and dust particles from any surface like magnet.



Illustration A-1

A microfiber strand is less than 1.0 denier in diameter, making it 100 times finer than human hair, 40 times finer than wool, 30 times finer than cotton, and 10 times finer than silk.

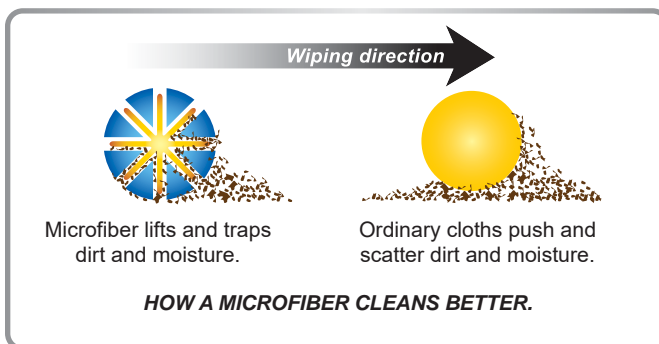

FOLDING TECHNIQUE:

Utilizing these folding techniques, you can use the towel more efficiently and minimize rinsing and wringing.

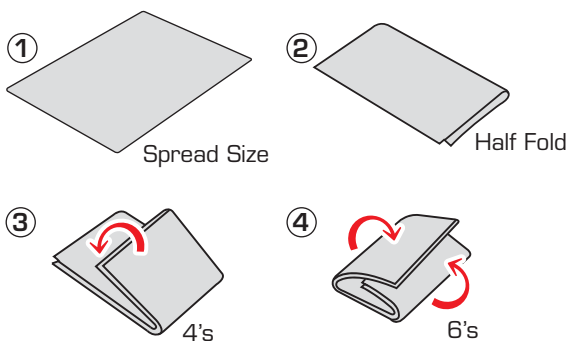

MTX® Microfiber Cloths in reusable and recyclable canister.

MICROFIBER COLOR GUIDE

| SHAMPOOING | | DRYING | | BUFFING/POLISHING | | | GLASS/INTERIOR | WAX APPLICATION | |
|------------|---------|-----------|--------------|-------------------|--------------------|--------------------------------|----------------|-----------------|---------|
| WASHMITT | CHAMOIS | ELITE | TERRY | PLUSH | ULTRA PLUSH | SUPREME | ULTRA | SUEDE | WAX PAD |
| WASHPAD | | ELITE JR. | medium fiber | high fiber | high density fiber | 2 sided, ultra-soft hi-density | | | |



CHAMOIS *THE NEXT GENERATION CHAMOIS*

- Absorbs 7 times of its weight
- Glides smoothly on panels
- Does not harden when dry

SPECIFICATION: Drying Cloth

SIZE: 16in. x 16in. / 40cm. x 40cm.



MA-001

MA-001C

MA-12P001
(Pack of 12)

SUEDE *SUPREME DELICATE SURFACE CLEANER*

- Velvety soft and smooth
- Excellent for polishing lenses, jewelries, and CDs/DVDs
- Renews surface without chemicals

SPECIFICATION: Glass/Interior/Wax Application

SIZE: 16in. x 16in. / 40cm. x 40cm.



MA-002

MA-002C

MA-12P002
(Pack of 12)

ULTRA *ALL AROUND HARD SURFACE CLEANER*

- Unique micro-structure weave
- Excellent for cleaning glass and lenses
- Attracts dust, dirt, grease and grime like magnet

SPECIFICATION: Glass/Interior Cloth

SIZE: 16in. x 16in. / 40cm. x 40cm.



MA-003

MA-003C

MA-12P003
(Pack of 12)

PLUSH *FLUFFY HIGH PILE FIBER*

- Extraordinary softness
- Removes polishes, waxes, and fingerprints easily
- Holds up to 7 times of its weight in liquid

SPECIFICATION: Buffing/Polishing Cloth

SIZE: 16in. x 16in. / 40cm. x 40cm.



MA-004

MA-004C

MA-12P004
(Pack of 12)

ULTRA PLUSH *SUPER HIGH DENSITY FIBER*

- Extremely soft and high pile
- Over 200,000 fibers per square inch
- Removes polishes, waxes, and fingerprints easily

SPECIFICATION: Buffing/Polishing Cloth

SIZE: 16in. x 16in. / 40cm. x 40cm.



MA-005

MA-005C

MA-12P005
(Pack of 12)

TERRY *FLUFFY MEDIUM PILE FIBER*

- Attracts dust and dirt like magnet
- Use for cleaning and polishing surfaces
- Absorbs 7 times of its weight

SPECIFICATION: Buffing/Polishing Cloth

SIZE: 16in. x 16in. / 40cm. x 40cm.



MA-006

MA-006C

MA-12P006
(Pack of 12)

ELITE *THE ULTIMATE DRYING TOWEL*

- Can dry an entire full size vehicle in no time
- Over 5 square feet of drying surface
- Dries completely and effortlessly

SPECIFICATION: Drying Cloth

SIZE: 24in. x 36. / 60cm. x 90cm.



MX-001

MX-6P001
(Pack of 6)

ELITE JR. *SUPERIOR DRYING MADE EASY*

- Made for easy wringing and drying
- Lightweight and super absorbent
- Micro-pockets to absorb water fast

SPECIFICATION: Drying Cloth

SIZE: 18in. x 24in. / 45cm. x 60cm.



MX-001S

MX-6P006
(Pack of 6)

SUPREME *MADE FOR LUXURY, DESIGNED FOR SUPERCARS*

- Extremely durable, double-sided design
- Scratch-free luxurious thick pile
- Perfect for all applications

SPECIFICATION: Buffing/Polishing Cloth

SIZE: 16in. x 16in. / 40cm. x 40cm.



MX-002

MX-6P002
(Pack of 6)

PROKIT *THE COMPLETE PROFESSIONAL MICROFIBER KIT*

- Highest quality microfiber towels
- Each kit contains a drying, polishing, & glass/interior cloth
- Renews surface without chemicals

SPECIFICATION: Drying + Polishing + Glass/Interior

SIZE: 3 x 16in. x 16in. / 40cm. x 40cm.



MA-PKT001
[PCS]

MA-PKT002
[UCU]

MA-PKT003
[TCU]



WASHMITT *MICRO-FINGER TECHNOLOGY*

- Designed not to scratch even dark finishes
- Extra long fibers encapsulate dirt and grime
- Holds gallons of soap water during use
- Highly durable and reusable

SIZE: 8in. x 10in. / 20cm. x 25.5cm.



MA-WM100

WASH PAD *MICRO-FLUFF TECHNOLOGY*

- Gently cleans without scratching
- Safely removes bug and tar
- Color-coded sides and easy-grip design

DIMENSION: 9in. x 4.5in. x 2.25in.
23cm. x 11.5cm. x 5.7cm.



DOUBLE-SIDED



MA-WP100

CLAY BAR *SMOOTHS • CLEANS • REVIVES*

- Removes overspray and contaminants
- Scratch-free decontamination
- Smooth as glass finish

SIZE: 100g, 200g



MA-CB100



MA-CB200

WAX APPLICATOR *FINEST WAX PAD*

- Velvety soft and smooth
- Does not absorb wax
- Does not trap dirt or dust like a sponge
- Washable and reusable

DIMENSION: 5in x 2.75in x 1.25in
13cm. x 7cm. x 3cm.



MA-007

FLEXIBLADE *SURE DRY IN ONE PASS*

- Scratch-free flexible handle
- Contours to curved surfaces
- Dries surface 1/3 of the time
- Made from medical grade silicone

SIZE: 2.5in. x 12.5in / 6.35cm. x 31.75cm.



MA-WB100

DETAILING BRUSH

- Cleans hard-to-reach areas easily
- 100% boar's hair for extra gentle cleaning
- Chemically resistant bristles

1 Set includes:
25mm Ø
30mm Ø
40mm Ø



MA-DB100

ULTIMATE DUSTER

THE DIRTIER IT GETS, THE BETTER IT WORKS

- Excellent dust removal capability
- Keeps your ride looking new
- Use hundreds of times
- Won't scratch dark finishes

SIZE: Big (for automobiles)
Small (for interior and motorcycles)



MA-D500L

MA-D500S

DUSTER REPLACEMENT HEAD

- For replacement of worn-out and unusable duster heads

SIZE: Small (fits MA-D500S)
Big (fits MA-D500L)



MA-D500SR

MA-D500LR

EDGELESS APPLICATOR PADS

- Smooth application of waxes, polish, and protectants
- Washable and reusable

MATERIAL: Hi-Grade U.S. Foam

SIZE: 4in. Ø

COLOR:

UFO DESIGN SERIES



EDGELESS FORM FACTOR



OTHER BRANDS



MA-AP10-6
(Pack of 6)

ELEC. & LENS CLEANING CLOTH

- Unique micro-structure weave
- Designed for polishing lenses, LCD/LED screens, DVDs
- Quickly and safely removes fingerprints and dust
- Cleans without chemicals or solvents

SIZE: MC – 10in. x 10in. / 25cm. x 25cm.
ME-Series – 5in. x 5in. / 13cm. x 13cm.



MC-100

ME-001

ME-002



CAR SHAMPOO *POWER FOAM TECHNOLOGY*

- Won't strip wax formula
- Easily remove dirt, grime, and road films
- Maintains paint gloss longer
- Safe for clear coats



MA-S100 2 x 25mL MA-S500 500mL MA-S101 1000mL MA-S2000 2000mL

WASH & WAX *HI-FOAM WASH PROTECTION*

- Deep clean for a brilliant shine
- Cleans, shines, and protects paint
- Wax booster formula
- Safe for clear coats



MA-SW100 2 x 25mL MA-SW500 500mL MA-SW101 1000mL MA-SW2000 2000mL

TIRE BLACK *MOISTURIZING TIRE LOTION*

- Non-greasy shine formula
- Conditions tire against aging
- Deep black finish



MA-T30 30mL MA-T125 125mL MA-T250 250mL MA-T500 500mL MA-T3800 3800mL

SUNSHIELD *ANTI-BAC PROTECTANT*

- Non-greasy shine
- Renews and revitalizes surface
- Non-sticky residue



MA-P30 30mL MA-P125 125mL MA-P300 300mL MA-P500 500mL MA-P3800 3800mL



QUICKLEEN *MULTI-PURPOSE CLEANER*

- Tough on stains, gentle on hands
- Cleans upholstery, leather, and vinyl
- Non-alkaline, pH neutral



DILUTION: 1:3



MA-Q125 125mL Ready-To-Use
 MA-Q500 500mL Ready-To-Use
 MA-Q3800C 3800mL Concentrate

L'VI RESTORER *BACK-TO-ORIGINAL*

- Leather and vinyl treatment
- Deep clean action
- Restores and conditions



MA-LV125 125mL Ready-To-Use
 MA-LV500 500mL Ready-To-Use
 MA-LV3800 3800mL Concentrate

O'DEE *ORANGE DEGREASER*

- Dissolves grease, oil, and dirt
- Formulated with natural orange solvents
- Safe for most surfaces



DILUTION: 1:3 - Heavy 1:8 - Light



MA-OD500 500mL Ready-To-Use
 MA-OD1000C 1000mL Ready-To-Use
 MA-OD3800C 3800mL Concentrate

O'SEE *ORANGE MULTI-CLEANER*

- Interior organic cleaner
- Removes dirt, grease, and grime
- Non-toxic and biodegradable



DILUTION: 1:3 - Heavy 1:8 - Light



MA-OS500 500mL Ready-To-Use
 MA-OS1000C 1000mL Ready-To-Use
 MA-OS3800C 3800mL Concentrate

AFTER WASH *FAST WAX & DRY*

- Wax your car under 5 minutes
- Easy no streak formula
- Just spray and dry to shine

QUICKPRO™



MA-AW500
500mL

MA-AW3800
3800mL

QUICK SHINE *CARNAUBA SPRAY WAX*

- Detailed shine in half the time
- Super slick finish
- Keeps your car looking new

QUICKPRO™



MA-QS500
500mL

MA-QS3800
3800mL

DRY WASH *WATERLESS WASH*

- Wash your car anytime anywhere
- Anti-static formula
- Safely clean your car in minutes

QUICKPRO™

DILUTION: 1:3



MA-DW500
500mL
Ready-To-Use

MA-DW1000C
1000mL

MA-DW3800C
3800mL
Concentrate

C'TRU *GLASS CLEANER*

- No streaks formula
- Reduces glare and haze
- Safe for glass coatings

QUICKPRO™

DILUTION: 1:3



MA-CT500
500mL
Ready-To-Use

MA-CT3800C
3800mL
Concentrate

C'TRIX *CITRUS IRON DECONTAMINANT* (WHEELS & BODY PAINT)

- Dissolves iron deposits
- Deep cleanse wheels
- Safe for body and paint



MA-CX1000C
1000mL
Concentrate

MA-CX500
500mL
Ready-To-Use

WIPER WASH *AMAZING CLEAR VISION*

- Excellent cleaning action
- Cleans grease, oil, bugs, and grime
- Streak-free brilliant shine



MA-WW2000
2000mL

BAC-TO-ZERO

SANITIZING ODOUR ELIMINATOR

- Revolutionary mist system
- Complete interior coverage
- Kills bacteria fast!



MA-BZ60
60mL (1 Shot)



MA-BZ500
500mL



MA-BZ1000
1000mL



MA-BZ900W
Mist Machine (900 watts)

FULL CONTROL



antiseptic

Tested by a trusted international laboratory.

DEOSOL AFC REFRESHES & DISINFECTS

- ODOUR-FREE technology
- Anti-bacterial odour eliminator
- Eliminates pet, fabric, and smoke odours



SCENT: ■ Fresh Air ■ Peach Blossom



MD-FA125 125mL MD-FA500 500mL MD-PB125 125mL MD-PB500 500mL MD-FA3800 / MD-PB3800 3800mL

DEOSOL EXTREME KILLS ODOUR FAST

- Active enzyme formula
- Removes odour caused by dampness
- Prevents odour from coming back



SCENT: ■ Floral Fresh ■ Citrus Splash



MD-FF125X 125mL MD-FF500X 500mL MD-CS125X 125mL MD-CS500X 500mL MD-FF3800X / MD-CS3800X 3800mL



- 1 NANOFIL
- 2 NANOSIL
- 3 NANOGLOS
- 4 NANOSLIQ



NANOFIL *SELF-LEVELING FILLER*

- Instant detailed finish
- Deep showroom shine
- Fills surfaces without reducing paint

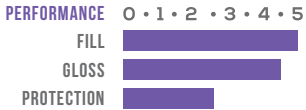

MA-NF50 50mL MA-NF500 500mL MA-NF3800 3800mL

NANOSIL *CRYSTAL SEAL POLISH*

- High definition finish
- Fills and seals swirls
- Paint protection sealer



MA-NL50 50mL MA-NL500 500mL MA-NL3800 3800mL

NANOGLOS *CARNAUBA WAX*

- Ultimate hi-gloss finish
- Conceals fine swirl marks
- Long-lasting finish protection



MA-NG50 50mL MA-NG125 125mL MA-NG500 500mL MA-NG3800 3800mL

NANOSLIQ *QUICK DETAILER*

- Waterless carwash
- Deep gloss finish
- Instant shine in just seconds



MA-NS30 30mL MA-NS125 125mL MA-NS500 500mL MA-NS3800 3800mL



SUPRABRIL *HI-PERFORMANCE PASTE COMPOUND*

- Removes 1200 grit sanding marks
- Brilliant cut and shine
- Perfect for all paints

STEP 1.0
NON-SILICONE

PERFORMANCE LEVEL

0 • 1 • 2 • 3 • 4 • 5

CUT

GLOSS

PROTECTION



MA-SB75
75g

MA-SB500
500g

MA-SB1000
1Kg

SUPRAMAX *ULTRA FAST-CUT COMPOUND*

- Maximum cutting and coverage
- Removes 1200 grit sanding marks
- Designed for modern paint system

STEP 1.0
NON-SILICONE

PERFORMANCE LEVEL

0 • 1 • 2 • 3 • 4 • 5

CUT

GLOSS

PROTECTION



MA-SM30
30mL

MA-SM500
500g

MA-SM1000
1Kg

MA-SM3800
3800mL

SUPRACUT *HI-GLOSS RUBBING COMPOUND*

- Fast cut high gloss finish
- Cuts like a compound, finishes like a polish
- Removes scratches and sanding marks

STEP 1.0
NON-SILICONE

PERFORMANCE LEVEL

0 • 1 • 2 • 3 • 4 • 5

CUT

GLOSS

PROTECTION



MA-SC30
30mL

MA-SC500
500g

MA-SC1000
1Kg

MA-SC3800
3800mL

SUPRAONE *HYBRID POLISH & COMPOUND*

- Removes 1500 grit sanding marks
- Ultimate cut and perfect finish
- One step high gloss system

STEP 1.0
NON-SILICONE

PERFORMANCE LEVEL

0 • 1 • 2 • 3 • 4 • 5

CUT

GLOSS

PROTECTION



MA-SO30
30mL

MA-SO500
500g

MA-SO1000
1Kg

MA-SO3800
3800mL

SUPRASHINE *HI-GLOSS POLISHING COMPOUND*

- Hologram-free mirror finish
- Removes swirls and light oxidation
- Restores and revives paint color

STEP 2.0
NON-SILICONE

PERFORMANCE LEVEL

0 • 1 • 2 • 3 • 4 • 5

CUT

GLOSS

PROTECTION



MA-SS30
30mL

MA-SS500
500g

MA-SS1000
1Kg

MA-SS3800
3800mL

SUPRAGLAZE *SHOW CAR GLAZE*

- New car paint protection
- Intense wet-look shine
- Deep show car shine

STEP 3.0
NON-SILICONE

PERFORMANCE LEVEL

0 • 1 • 2 • 3 • 4 • 5

CUT

GLOSS

PROTECTION



MA-SZ50
50mL

MA-SZ500
500g

MA-SZ1000
1Kg

MA-SZ3800
3800mL

PROCESS CHART



SUPRAGLOS *CLEANER WAX & POLISH*

- One step cleaning and protection
- Restores brilliance and color of paint
- Deep cleanse formula

STEP 3.0
SILICONE

PERFORMANCE LEVEL

0 • 1 • 2 • 3 • 4 • 5

CUT

GLOSS

PROTECTION



MA-SG50
50mL

MA-SG500
500g

MA-SG1000
1Kg

MA-SG3800
3800mL

PAINT DEFECTS

HOLOGRAMS

FINE SWIRLS & LIGHT SCRATCHES

MODERATE SWIRLS & SCRATCHES

DEEP SWIRLS & HEAVY SCRATCHES

DEEP SCRATCHES

ORANGE PEEL

SANDING MARKS

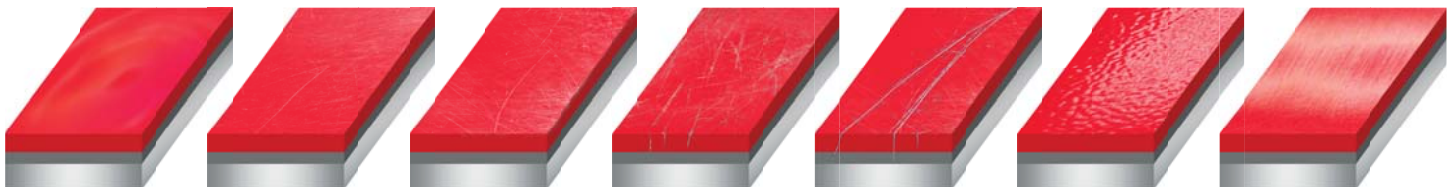



FLAT FACE
Most popular version, it works as the highest efficiency for cutting and polishing paint surfaces.

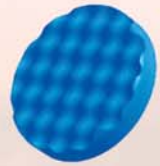

WAFFLE FACE
The wave design reduces heat and speed up the air flow to cool the pad against overheating the surfaces.

WOOLPAD

- 100% Australian lamb's wool
- Cuts 1500 sanding marks & oxidation
- Flexible edge for hard-to-reach areas
- Double sided pad for double durability

SIZE: 8in. / 20.3cm. Ø



MA-DWP8

SPOT-BUFF WOOLPAD

- Perfect for small panels
- Great for spot repairs
- Removes sanding marks

SIZE: 3in. / 7.6cm. Ø



MA-WP301

HI-CUT WOOLPAD

- Removes sanding marks
- Perfect for headlight restoration
- Removes deep watermarks

SIZE: 3in. / 7.6cm. Ø



MA-WP302

PREMIUM PADS

- Higher pores per inch (PPI) than any other pads
- Recessed velcro to avoid scratching and prolong use
- Open cell technology for cooler process

Pad Thickness: 33mm



HI-GRADE
Black Velcro Backing

CUTTING PAD

8in.

6in.



MA-CP8PM

MA-CP6PM

POLISHING PAD

8in.

6in.



MA-PP8PM

MA-PP6PM

FINISHING PAD

8in.

6in.



MA-FP8PM

MA-FP6PM

PRO CUTTING PAD

- Cutting and polishing all-in-one pad
- Removes oxidation and scratches
- Recessed velcro to avoid scratching and prolong use
- Open cell technology for cooler process

Pad Thickness: 30mm.

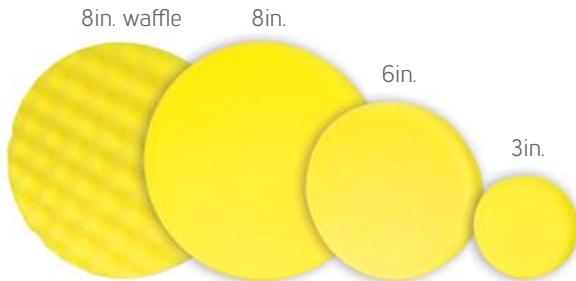

MA-CP8W MA-CP8 MA-CP6 MA-CP3

PRO POLISHING PAD

- Solution to 2500 fine sanding marks
- Quickly and easily remove swirl marks
- Recessed velcro to avoid scratching and prolong use
- Open cell technology for cooler process

Pad Thickness: 30mm.

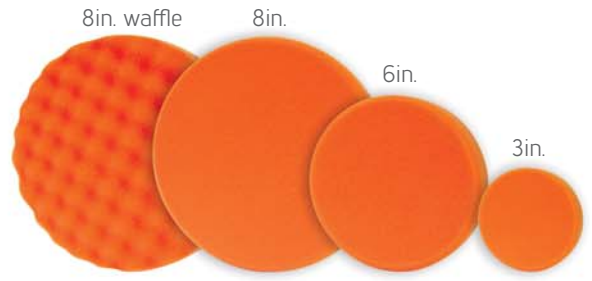

MA-PP8W MA-PP8 MA-PP6 MA-PP3

PRO FINISHING PAD

- No cut on paint surface
- Buff waxes into a high gloss finish
- Recessed velcro to avoid scratching and prolong use
- Open cell technology for cooler process

Pad Thickness: 30mm.



MA-FP8W MA-FP8 MA-FP6 MA-FP3

BACKING PLATES

- FLEXEDGE™ backing
- Micro-velcro to prolong foam pad use
- Recessed lip design for quick change
- Smaller plates are ideal for curve and contour surfaces

AVAILABLE in M14 and M16
SIZE: 6.8in, 5in, 3in. Ø



RECESSED LIP DESIGN



MA-M16-6 MA-M14-6 MA-M16-5 MA-M14-5 MA-M16-3 MA-M14-3

ADAPTORS

- For rotary buffing machine
- 6mm adaptors are for hand drills
- Covers m14, m16, and 5/8 backing plates
- Made from quality brass and aluminum



MA-AD1 m14-m16 MA-AD2 m14-5/8 MA-AD3 m16-5/8 MA-AD4 6mm-m14 MA-AD5 6mm-m16 MA-AD6 m14-m16 MA-AD7 m14-5/8 MA-AD8 m16-5/8

PAD SPUR

- Keeps woolpad in tip-top condition
- Removes cake-on polish on-the-fly so you can continue polishing



MA-PS100

CAR SHAMPOO



+ 2.5 L water =



POWER FOAM TECHNOLOGY

TIRE BLACK



OTHER BRAND

MTX



SUNSHIELD



NANOGLÓS



3 in 1 PROTECTION
WITH CARNAUBA WAX



1 Conceal swirl marks. Hi-gloss finish.

2 Removes dirt & stains.

3 Cleans and prevents headlight against yellowing. (Not applicable on peeling and inside discoloration.)

NANOSLIQ



WATERLESS WASH

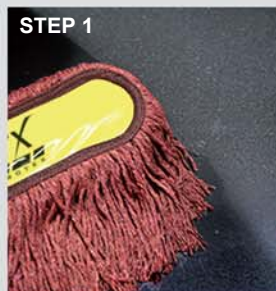

WAX AND DRY



Use Microtex Duster, then spray & wipe. (Not applicable for heavily soiled cars.)

Spray then wipe as you dry!

QUICKLEEN



Cleans Upholstery, Leather, Vinyl & Carpet.



L'VI RESTORER



**CLEANS,
RESTORES,
CONDITIONS.**



Cleans and restores leather seats. Works on shoes and bags too.



DEOSOL



FRESH AIR PEACH BLOSSOM



AIR • FABRIC • CARPET

ANTI-BACTERIAL



Refreshes & disinfects upholstery, carpet, clothing, shoes, living room, bathroom, kitchen, and pet litter to keep feeling fresh at all times.



FLORAL FRESH CITRUS SPLASH



EXTREME

**ACTIVE ENZYME
FORMULA**



Kills odour on carpet, car mat, compartments, toilet, urinal, garbage can, pet cage, and locker room that are affected by dampness or flood.

ULTIMATE FILLING SYSTEM

HOW IT'S DONE:



HIGH DEFINITION PAINT PROTECTION

- STEP 1
NANOFIL
- STEP 2
NANOSIL
- STEP 3
NANOGLOS
- STEP 4
NANOSLIQ



FILL SEAL GLOSS MAINTAIN

DETAILING & REFINISHING CHART



| PRODUCT SERIES | SupraBRIL | SupraMAX | SupraCUT | SupraONE | SupraSHINE |
|------------------------------------|-------------------------------|----------|----------|----------|------------|
| | COMPOUNDS | | | POLISH | |
| BASIC DETAILING | | | | | |
| Machine Wax | | | | | |
| 1 Step + Wax | | | | ● | |
| 3 Step Detailing | | | | ● | ● |
| Double Wax | | | | | |
| New Paint Protection | | | | | |
| Quick Detailing | | | | | |
| PREMIUM DETAILING | | | | | |
| Premium 1 Step + Wax | | | | ● | |
| Premium 3 Step Detailing | | | | ● | ● |
| Premium Double Wax | | | | | |
| Coating | | | | | ● |
| SHOW CAR DETAILING | | | | | |
| Old Car Show Prep | | ● | | | ● |
| New Paint Show Prep | | | | | ● |
| HIGH DEFINITION RESTORATION | | | | | |
| Sealant Application | | | | | |
| Minor Correction + Sealant | | | | | |
| Moderate Correction + Sealant | | | | | ● |
| Heavy Correction + Sealant | | | | ● | |
| NEW PAINT REFINISHING | | | | | |
| Sanding Mark #1200 | ● / ● / ● | | | | |
| Sanding Mark #1500 | ● / ● / ● / ● | | | | |
| Sanding Mark #2000 | ● ● ● / ● ● ● / ● ● ● / ● ● ● | | | | |
| Orange Peel | ● ● ● / ● ● ● / ● ● ● | | | | |
| Deep Scratches | ● ● ● / ● ● ● / ● ● ● | | | | |
| Deep Swirls | | | | ● | ● ● ● |
| Moderate Swirls and Scratches | | | | ● | ● ● ● |
| Fine Swirls and Scratches | | | | | ● ● ● |
| Holograms | | | | | |
| Pre Delivery Inspection | | | | | |
| COMPLETE PAINT FINISHING | | | | | |
| | ● ● ● / ● ● ● / ● ● ● / ● ● ● | | | | ● ● ● |
| CLEAR COAT GUIDE | | | | | |
| Medium Solid (MS) | ✓ | | | ✓ | |
| High Solid (HS) | ✓ | ✓ | | ✓ | |
| Ultra High Solid (UHS) | ✓ | ✓ | ✓ | | |
| Ceramic Clear | ✓ | ✓ | | | |
| Self Healing | | | ✓ | ✓ | |

DETAILING & REFINISHING CHART

| SupraGLAZE | SupraGLOS | NanoFIL | NanoSIL | NanoGLOS | SOON TO BE RELEASED | | NanoSLIQ |
|---------------------|-----------|-----------------------|---------|------------|---------------------|---|-------------|
| GLAZE & FINE POLISH | | HI-DEFINITION SEALANT | | PROTECTION | | | MAINTENANCE |
| | ● | | ● / ● | | | | |
| ● | ● | | ● / ● | | | | 👤 |
| | | | ● / ● | | | | |
| | ● | | ● / ● | | 👤 | | |
| | | | ● / ● | | 👤 | | |
| ● | | | | | | 👤 | |
| ● | | | | | | 👤 | |
| | | ● | ● | | | | |
| | | ● | ● | | | | |
| | | ● | ● | | | | |

| | | | | | | | |
|---|---|---|--|--|--|--|--|
| | | | | | | | |
| | | | | | | | |
| ● | | | | | | | |
| ● | | | | | | | |
| ● | ● | ● | | | | | |
| ● | | | | | | | |

WOOL AND FOAM PAD GUIDE

| CUT LEVEL | 1200/1500 GRIT SANDING MARKS | 2000 GRIT SANDING MARKS | | MEDIUM CUT | MEDIUM/LOW CUT | FINISHING | |
|-----------------|------------------------------|-------------------------|---|------------|----------------|-----------|------|
| PRO Series | ● | ● | | ● | | | ● |
| PREMIUM Series | | | ● | | ● | ● | |
| Level of Finish | COARSE | | | | | | FINE |

Legend:

| | | | | | | | | | |
|---------|-------------|---------------|---------------|-----------------|-------------------|-------------------|-----------|--------------|---|
| ● | ● | ● | ● | ● | ● | ● | ● | ● | 👤 |
| Woolpad | PRO Cutting | PRO Polishing | PRO Finishing | Premium Cutting | Premium Polishing | Premium Finishing | Either Or | Hand Applied | |

CAR CARE MAINTENANCE CHART



| BASIC MAINTENANCE | CAR SHAMPOO/ WASH & WAX | TIRE BLACK | SUNSHIELD | NANOSLIQ | NANOGLOS/ PASTE | C'TRU & DEOSOL |
|----------------------|-------------------------------------|-------------------------------------|-------------------------------------|-------------------------------------|-------------------------------------|-------------------------------------|
| Basic Wash | <input checked="" type="checkbox"/> | <input checked="" type="checkbox"/> | <input checked="" type="checkbox"/> | | | |
| Premium Wash | <input checked="" type="checkbox"/> | <input checked="" type="checkbox"/> | <input checked="" type="checkbox"/> | <input checked="" type="checkbox"/> | | <input checked="" type="checkbox"/> |
| Basic Wash And Wax | <input checked="" type="checkbox"/> | <input checked="" type="checkbox"/> | <input checked="" type="checkbox"/> | | <input checked="" type="checkbox"/> | |
| Premium Wash And Wax | <input checked="" type="checkbox"/> | <input checked="" type="checkbox"/> | <input checked="" type="checkbox"/> | <input checked="" type="checkbox"/> | <input checked="" type="checkbox"/> | <input checked="" type="checkbox"/> |



| EXPRESS MAINTENANCE | DRY WASH | CAR SHAMPOO/ WASH & WAX | TIRE BLACK | SUNSHIELD | QUICK SHINE | AFTER WASH |
|----------------------|-------------------------------------|-------------------------------------|-------------------------------------|-------------------------------------|-------------------------------------|-------------------------------------|
| Express Dry Wash | <input checked="" type="checkbox"/> | | <input checked="" type="checkbox"/> | <input checked="" type="checkbox"/> | | |
| Express Wax & Dry | | <input checked="" type="checkbox"/> | <input checked="" type="checkbox"/> | <input checked="" type="checkbox"/> | | <input checked="" type="checkbox"/> |
| Express Wash & Shine | | <input checked="" type="checkbox"/> | <input checked="" type="checkbox"/> | <input checked="" type="checkbox"/> | <input checked="" type="checkbox"/> | |



| INTERIOR DETAILING | O'SEE | QUICKLEEN | L'VI RESTORER | SUN SHIELD | DEOSOL-AFC |
|--------------------------------------|-------------------------------------|-------------------------------------|-------------------------------------|-------------------------------------|-------------------------------------|
| Basic Interior Maintenance | | | | <input checked="" type="checkbox"/> | <input checked="" type="checkbox"/> |
| Basic Interior & Leather Maintenance | | | <input checked="" type="checkbox"/> | <input checked="" type="checkbox"/> | <input checked="" type="checkbox"/> |
| Basic Interior Detailing | <input checked="" type="checkbox"/> | <input checked="" type="checkbox"/> | <input checked="" type="checkbox"/> | <input checked="" type="checkbox"/> | <input checked="" type="checkbox"/> |
| Basic Carpet & Fabric Cleaning | <input checked="" type="checkbox"/> | <input checked="" type="checkbox"/> | | | <input checked="" type="checkbox"/> |



| ENGINE DETAILING | CAR SHAMPOO | O'SEE | O'DEE | SUNSHIELD |
|------------------|-------------------------------------|-------------------------------------|-------------------------------------|-------------------------------------|
| Engine Wash | <input checked="" type="checkbox"/> | | | <input checked="" type="checkbox"/> |
| Engine Detailing | <input checked="" type="checkbox"/> | <input checked="" type="checkbox"/> | <input checked="" type="checkbox"/> | <input checked="" type="checkbox"/> |



| ODOR ELIMINATING SANITIZING TREATMENT | BAC-TO-ZERO | DEOSOL-AFC | DEOSOL-EXTREME |
|--|-------------------------------------|-------------------------------------|-------------------------------------|
| Basic Treatment | | <input checked="" type="checkbox"/> | |
| Moisture & Mold Treatment | | | <input checked="" type="checkbox"/> |
| Aircon & Interior Full Treatment | <input checked="" type="checkbox"/> | | |

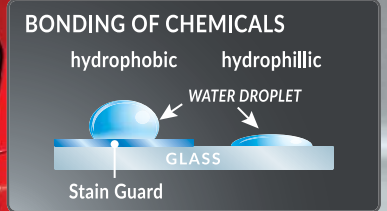
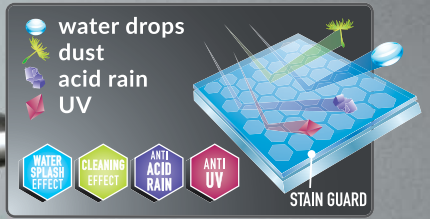

STAINZ' OUT *GLASS COMPOUND*

- Easily removes stain and oil film
- Improves glass clarity
- Smoothens wiper performance

APPLICATION:

glass, mirrors, windshield, headlights



CAR & HOME USE



GZ-SO70
70mL



GZ-SO500
500mL

STAIN GUARD *WATER REPELLANT COATING*

- Protects glass from stain
- Exhibits hydrophobic effect
- Improves rain visibility and safety

APPLICATION:

glass, mirrors, windshield, headlights



CAR & HOME USE



GZ-SG70
70mL



GZ-SG500
500mL

NO SQUIX *RUBBER SOFTENER*

- Stops squeaking of wipers and windows
- Ensures smooth gliding and sliding
- Lubricates rubber and hinges

APPLICATION:

windshield wipers, hinges, weather stripping seals



GZ-SX70
70mL



GZ-SX500
500mL

WIPER BEAD *WATER REPELLANT WASHER*

- Crystal clear vision
- Beading enhancement formula
- Repels water and dirt

APPLICATION:

windshield



GZ-WB125C
125mL
Concentrated



GZ-WB2000
2000mL
Ready-To-Use

BLINX HEADLIGHT RESTORER

- Deeply clean lenses
- Removes stain and minor imperfections
- Eliminates haze and discoloration

APPLICATION:
headlights



GZ-BX70
70mL



GZ-BX500
500mL

CRYSTAL GUARD UV PROTECTION

- Crystal clear finish
- Protects headlight against yellowing
- Extends glass beading protection

APPLICATION:
glass, mirrors, windshield, headlights



GZ-CG125
125mL



GZ-CG500
500mL

CRYSTAL FX HYDROPHOBIC SPRAY COATING

- Water repellent booster
- Protects from stains and discoloration
- Crystal shine finish

APPLICATION:
body paint



GZ-FX125
125mL



GZ-FX250
250mL

WATERMARK REMOVER

- Removes watermarks effortlessly
- Cuts through mineral deposits
- Restores gleam and clarity

APPLICATION:
glass, windshield



CAR & HOME USE



GZ-WR125
125mL



GZ-WR250
250mL



GZ-WR500
500mL

WHY USE glaz® ?

- Nano technology
- Hydrophobic effect
- Prevents watermarks
- Improves visibility
- Invisible wiper
- Easy to clean
- Non-stick surface
- Up to 6 months protection

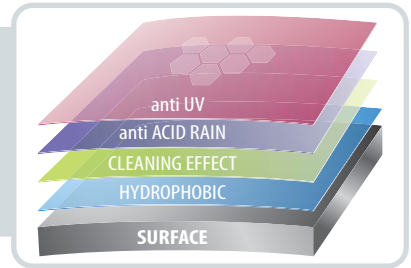

GLASS TREATMENT

STEP 1

BEFORE AFTER

STEP 2

BEFORE AFTER

STEP 3

CAUTION: Wipe No Squix® properly until the rubber blades are clean to avoid smudges on the glass.

STEP 4

MAINTENANCE:

Do not use strong detergent on your wiper tank. Use only water or GLAZ® WIPER BEAD to enhance and maintain water beading effect.

HEADLIGHT TREATMENT



NOTE: Peeling headlights requires wet sanding use 1500 and 2000 grit sand paper. For inside discoloration, seek professional assistance.

STEP 1

STEP 2

STEP 3



LIGHT STAIN
HAND USE



MODERATE TO HEAVY STAIN
MACHINE USE



CAR SHAMPOO

- pH neutral, safe for all finishes
- Ideal for high volume valet application
- Perfect for foam pre-soaking or two bucket wash method.

DILUTION: 25mL : 2.5L water
Pressure tank - 500mL:50L water



PC-S1L
1 Liter

PC-S4L
4 Liters

PC-S20L
20 Liters

ALL PURPOSE DRESSING

- Excellent rubber and plastic protection from UVA and UVB
- Can adjust from matte to high gloss finish
- For both interior/exterior plastic and rubber trims

APPLICATION: Engine / Tire / Interior
DILUTION: Super Hi-Gloss - as is
Hi-Gloss - 1:1
Semi-gloss - 1:2



PC-APD1L
1 Liter

PC-APD4L
4 Liters

ALL PURPOSE CLEANER

- Alkaline-base cleaner
- Very high dilution ratio makes it economical
- Cleans dirt and grime from interior and engine compartment.

APPLICATION: Engine / Interior
DILUTION: Engine - 1:4
Interior - 1:10



PC-APC1L
1 Liter

PC-APC4L
4 Liters

2 IN 1 HEAVY DUTY DEGREASER

- Fast acting alkaline-base cleaner for aluminum
- Cuts through oxidation, tough stains, and grease
- Should be handled only by professionals

DILUTION: Aluminum - 1:5
Engine - 1:10



PC-AB1L
1 Liter

PC-AB4L
4 Liters

GLASS CLEANER

- Low-base ammonia cleaner
- Dilutable according to the level of cleaning needed
- Doesn't streak or smear

DILUTION: 1:1 / 1:2



PC-GC1L
1 Liter

PC-GC4L
4 Liters

WATERMARK REMOVER

- Heavy duty acid-base cleaner designed to remove contaminants immediately
- Formulated to tackle the worse of lime and hard water spots



PC-SR1L
1 Liter

PC-SR4L
4 Liters

TIRE SHINE

- Shines and protects tires
- Deep black finish
- Dries to a high gloss



PC-TS1L
1 Liter

PC-TS4L
4 Liters

| MICROFIBER COLOR CODING APPLICATIONS | COMMERCIAL | AUTOMOTIVE |
|---|--|--|
| BLUE General Surface | Furniture, mirrors, office. | Windshield, side mirrors, dashboard. |
| GREEN General Areas | Food and bar service areas including kitchens. | Car interior (leather seats, carpets, ceiling, etc.) |
| YELLOW Medium Risk Areas | Washroom, showers, countertops, tiles, etc. | Car exterior (body, doors, hood, bumpers, etc.) |
| RED High Risk Areas | Restrooms, toilets, urinals, washroom floors. | Tires, engine, grille, undercarriage. |

ALL PURPOSE CLOTHS

- Cleans, shine, polishes
- Scratch-free and lint-free
- Color coded to prevent cross contamination

SIZE: 12in. x 12in. / 30cm. x 30cm.



PC-MF3S
Pack of 3

PC-MF12S
Pack of 12

MULTI-TASKER CLOTH

- Cleans, shine, polishes
- Scratch-free and lint-free
- Color coded to prevent cross contamination

SIZE: 10.5in x 24in / 26.5cm. x 60cm.



PC-MF3R
Pack of 3

PC-MF12R
Pack of 12

ULTRA SOFT CLOTHS

- High pile and high absorbent
- Cleans, shine, polishes
- Scratch-free and lint-free

SIZE: 16in. x 16in. / 40cm. x 40cm.



PC-MF3Y
Pack of 3

PC-MF12Y
Pack of 12



SHAMPOO *TOUGH ON DIRT, GENTLE ON HANDS*

- Safe and gentle formula
- Removes dirt and grime easily
- Preserves brilliance and color



MB-S125
125mL

MB-S250
250mL

TIRE CREAM *ULTIMATE BLACK & SHINE*

- Anti-skid formula
- Non-greasy feel
- New look finish



MB-T125
125mL

MB-T250
250mL

QUICK SHINE *INSTANT WASH & SHINE*

- Cleans and protects in minutes
- Ultra slick and shine
- Cleans without scratching



MB-QS125
125mL

MB-QS250
250mL

PROTECTANT *HI-GLOSS PROTECTION*

- Rain or shine protection
- Revives plastic and rubber
- Prevents oxidation and cracking
- Anti-Bac properties



MB-P125
125mL

MB-P250
250mL

HI-GLOSS WAX *ULTIMATE SHINE & PROTECTION*

- Show shine polish
- Ultra slick finish
- Seals pores and scratches



MB-W125
125mL

MB-W250
250mL

REFRESHER *COOL & REFRESHING*

- Kills and disinfects germs
- Eliminates bad odor
- Keeps your helmet and jacket feeling fresh

APPLICATION:
helmet
jacket



MB-HR125
125mL

MB-HR250
250mL

VH POLISH *SUPERIOR VISIBILITY & PROTECTION*

- Crystal clear protection
- Improves driving visibility
- Removes yellowing and stains

APPLICATION:
headlight
helmet visor



MB-VH125
125mL

VH GUARD *UV PROTECTION COATING*

- Crystal clear finish
- Prevents yellowing and fading
- Improves clarity for safe driving

APPLICATION:
headlight
helmet visor



MB-VG125
125mL

DETAIL CLOTH

- Scratch-free and lint-free
- Ideal for cleaning and polishing
- Removes dust and dirt like magnet
- Absorbs 7 times of its weight

SIZE: 12in. x12in / 30cm. x 30cm.



MB-100



MTX® Microtex® Bike Pro cleans, shines, and protects. Guarantees your ride to stand out at all times.

DETAILING APRON

- One size fits all design
- Four pockets to hold your polish, waxes, and other detailing supplies
- Water-proof so you can use it while washing your car



MA-DT001

DETAILING BELT

- Lightweight, adjustable utility belt
- Holds your polish, pads, waxes, and other detailing supplies while you detail your vehicle



MA-DT002

SPRAYER BOTTLE

- With volume measurement guide
- Dilution guide up to 10:1
- Great for liquid concentrate
- Spritz spray or foaming spray head



MA-BS480
Regular Spray Head

MA-BFS480
Foaming Spray Head

DISPENSER BOTTLE

- Push-pull dispensing head
- Great for liquid waxes



MA-BD350

OUR GLOBAL PARTNERS



... and other major stores and car dealers nationwide.



www.hgmicrotex.com

Distributor:

MANILA OFFICE:

Halden Galway International Corporation

483 Barcelona St., San Nicolas, City of Manila, Philippines 1010

Tel. Nos. +632 244-5538 to 39 • Telefax +632 245-4818

e-mail: info@hgmicrotex.com

SHANGHAI OFFICE:

Shanghai Halden Galway Car Care Co.,Ltd

No.1937 Baoqian Rd. , Huating Town,

Jiading District, Shanghai , China

MALAYSIA OFFICE | PLANT:

Halden Galway Industries Sdn. Bhd.

No. 6 Jalan, Mega 3B, Taman Industri Mega

Bandar Teknologi, 43500 Semenyih,

Selangor, Malaysia