

HI-MACS®. Perfect for the kitchen.
Perfect for the bathroom.

BECAUSE
QUALITY
WINS

What's the perfect material for bathrooms?

Bathrooms should be a haven of tranquility, as well as being functional. The ideal material in this room should not only be hygienic and water resistant, but also have a soft, warm touch. And, above all, it needs to be so flexible in terms of design that every last design vision can be transformed into reality: from minimalist and linear to delicate and opulent. HI-MACS® can be all those things – and can create all those things as well.



Nowhere does quality count more than in the kitchen.

Fine culinary artistry is celebrated in the kitchen. The demands are often exacting when it comes to handling high-quality foods and top kitchen equipment. The requirements in terms of functionality, durability, robustness, as well as aesthetics and comfort, simply couldn't be more demanding: right here in the heart of the house.



HI-MACS® inspires in the kitchen.

HI-MACS® is hardwearing and resistant

- HI-MACS® is 100% water-resistant
- HI-MACS® is resistant to almost all commercial household chemicals, and everyday stains such as fruit acid or red wine
- HI-MACS® is scratch-resistant and can be repaired in the event of small scratches – without the need to call in a tradesman
- HI-MACS® is heat-resistant thanks to new Thermalcure-technology

HI-MACS® is very easy to clean

- HI-MACS® can be cleaned using a moist cloth and commercial detergent, removing almost all dirt without leaving any residue
- HI-MACS® is hygienic and can be assembled without the need for visible joints, preventing germs, bacteria and pathogens accumulating in the first place
- HI-MACS® offers a wide range of sinks and individual bowls, which can also be seamlessly integrated with the worktop

HI-MACS® looks fantastic

- HI-MACS® has a natural matt satin finish, which can be given a high-gloss polished finish on request
- HI-MACS® offers a broad selection of attractive shades – elegant solid colours in classic shades and new trend colours, added every year – as well as many natural stone designs
- HI-MACS® can be machined just like hardwood or three-dimensionally moulded, and also offers the option of creating spectacular lighting effects using rear-milled cut-outs



Everything leads to the use of HI-MACS® in the bathroom.

HI-MACS® is easy to use and permanent

- HI-MACS® is 100% water-resistant
- HI-MACS® is resistant to almost all commercially available household chemicals
- HI-MACS® is scratch-resistant and can be repaired in the event of small scratches – without the need to call in a tradesman

HI-MACS® is very easy to clean

- HI-MACS® can be cleaned using a moist cloth and commercial detergent, removing almost all dirt without leaving any residue
- HI-MACS® is hygienic and can be machined without the need for visible joints, preventing the build-up of germs, bacteria and pathogens
- HI-MACS® offers a wide range of round, angled or oval wash-basins, which can also be ultra-hygienically and seamlessly integrated or installed as fashionable top-mounted bowls

HI-MACS® looks amazing

- HI-MACS® has a matt satin finish with an extremely pleasant feel: as if designed specifically for bathrooms – which can be given a high-gloss polished finish, on request
- HI-MACS® offers a generous selection of attractive shades: countless elegant shades of white and more solid colours in classic shades and new trend colours, added every year
- HI-MACS® can be three-dimensionally moulded, offering the option of creating spectacular lighting effects using rear-milled cut-outs



In the kitchen the words 'quality' and 'detail' define their meaning.



Apart from a number of uni-colours – including several shades of white – the extensive colour range also includes many attractive stone textures, following to the current trend for natural colours and materials in kitchen design.

Design: PLAN W GbmH – Photo: Heinrich Hermes



Extensive surfaces without visible joints make working in the kitchen a veritable pleasure. This kitchen also includes HI-MACS® furniture fronts: the handle recesses are simply cut out.



Photographed by Alvangarde



Flush-mounted sinks and bowls, milled draining grooves, three-dimensionally moulded elements: the range of options for creating design features with HI-MACS® is almost limitless.

HI-MACS® transforms every bathroom into your very own personal oasis of comfort.



The top-mounted basins in the HI-MACS® collection combine maximum bowl size with elegant, sleek lines.

Design: Roth kreativ GmbH | Photo: Studio Hetzer



All the functional elements in this minimalist elegant bathroom were individually designed with HI-MACS®: the washstand with its dramatic double sink, furniture fronts with bevelled handles, and the room-partition that supports the washstand whilst at the same time forming the shower cladding.



This comfortable shower is completely manufactured from HI-MACS®, creating a hygienic, easy-care zone with a maximum "feel-good" factor.



Straight, curved, rectangular, baroque ...
any shape you can imagine.

Due to the highly flexible manufacturing options of HI-MACS® your dealer can offer a wide range of attractive and functional edge-treatments and hygienic splashbacks for your kitchen. Here you can see a small selection of the various possibilities.

Edge profile examples

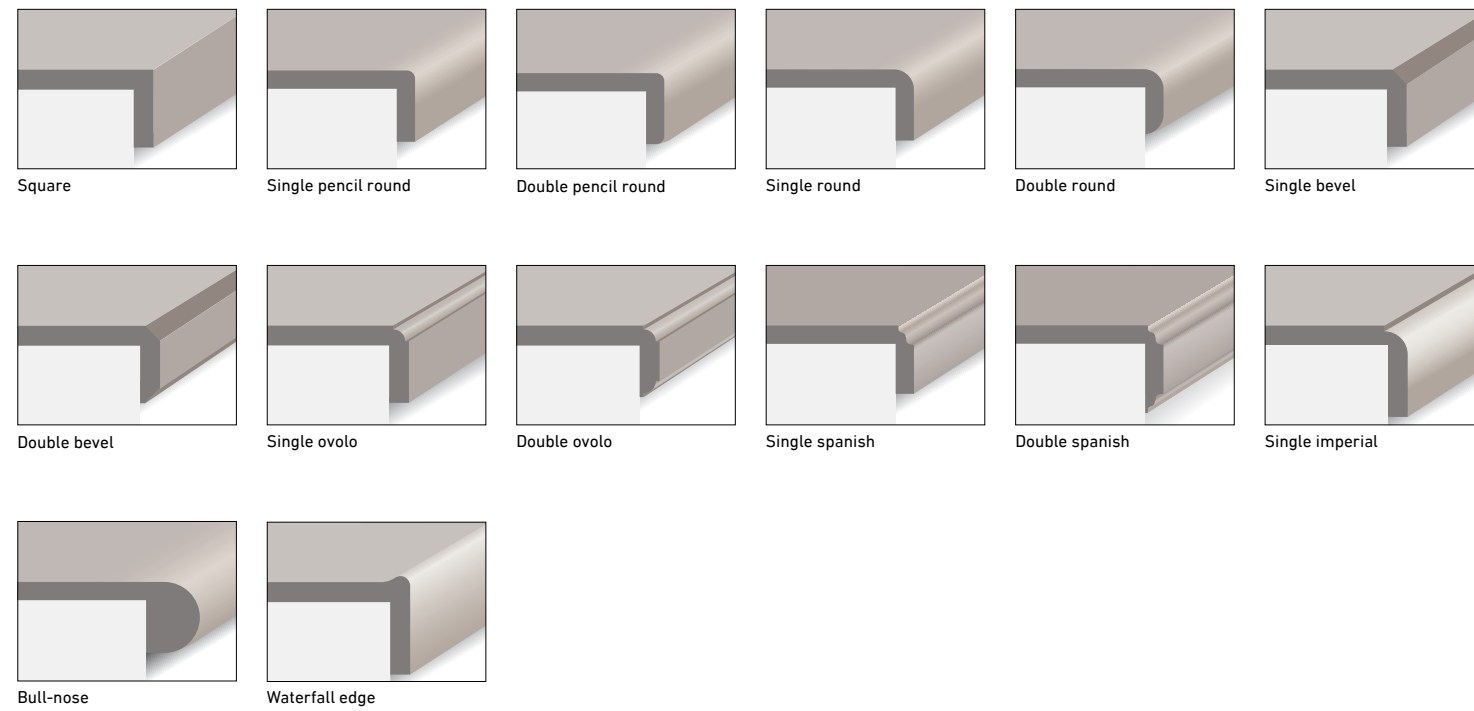

Splashbacks

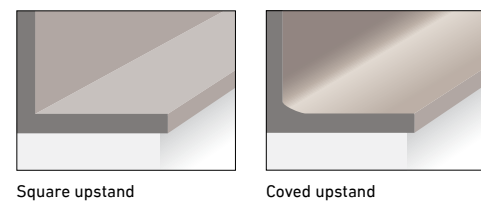

Drainer groove examples

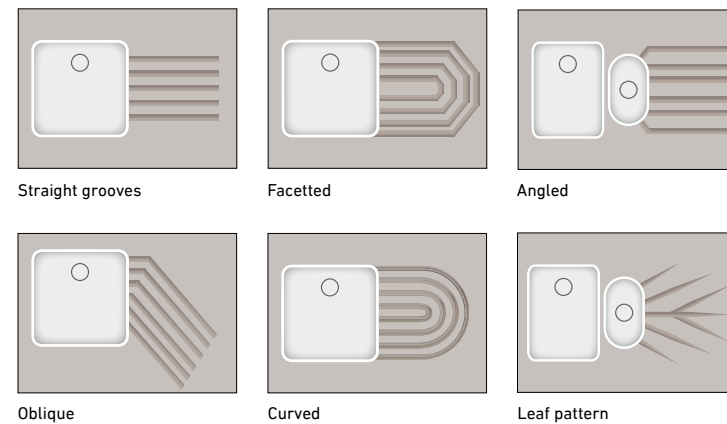

Sinks. Spacious and elegant.

Perfectly coordinated and ideal for mixing and matching with your kitchen worktop, the spacious sinks provide high-level functionality, guarantee a modern appearance, and are easy to look after.

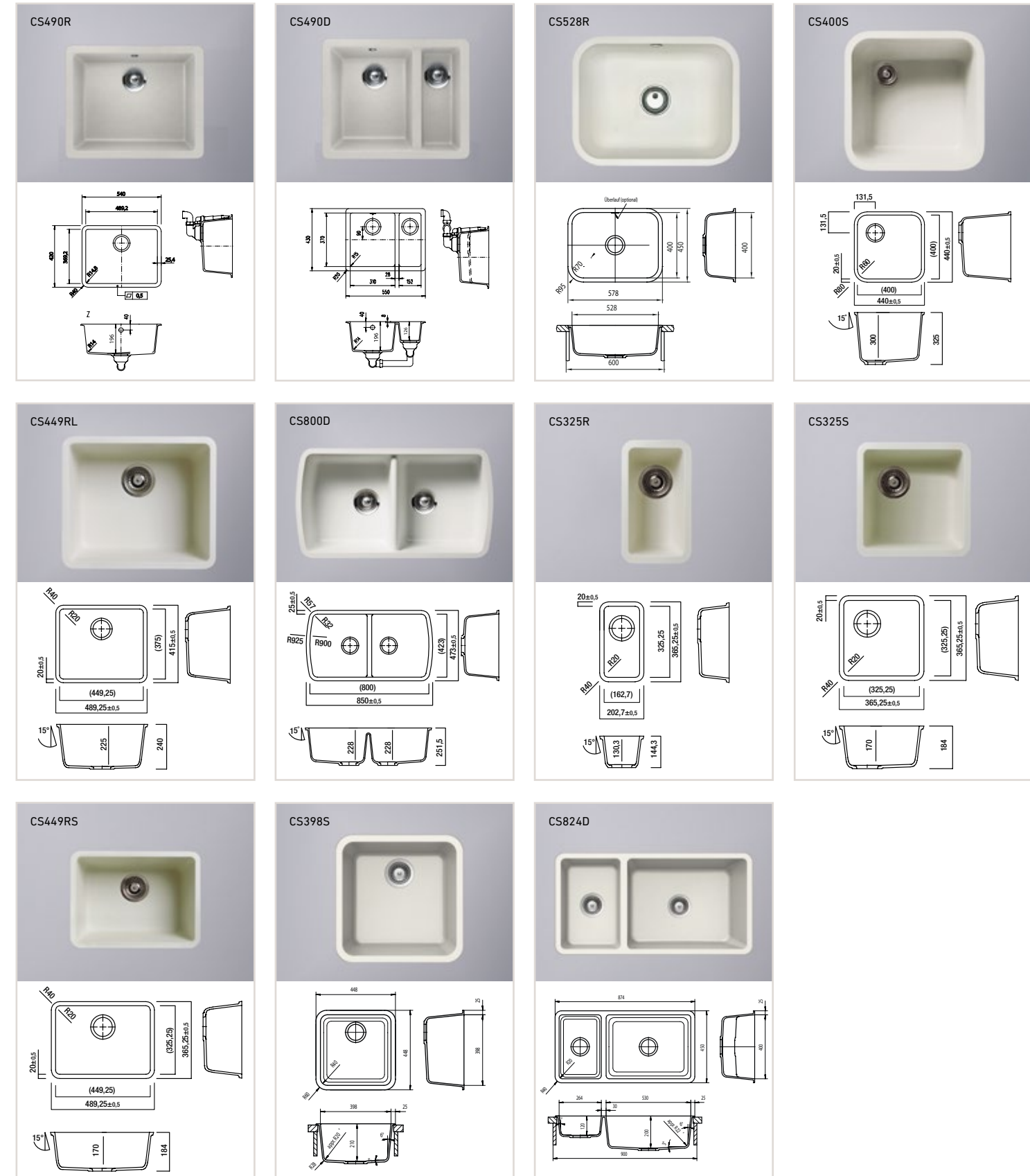

Stainless Steel Based Sinks utilising HI-MACS®

HI-MACS® has found the perfect synergy for hard-wearing sinks – stainless steel. The HI-MACS® sided sinks are smooth, aesthetically pleasing, non porous and available in a multitude of colours to complement any worktop. They are married to stainless steel, giving a highly robust and durable base that can withstand the rigours of a typical working kitchen.

All Combina sinks are available in the colours from the residential colour range (except Bologna).

Warranty: Peace of mind comes with the fact that these sinks come with a 10 Year Limited Warranty.

The sinks when under mounted, will seamlessly integrate into your HI-MACS® worktop. Because the join between the worktop and sink is visually seamless you do not get water ingress and there is no hiding place for bacteria. With a wide range of colours, shapes and sizes available you can be sure to find your perfect solution.

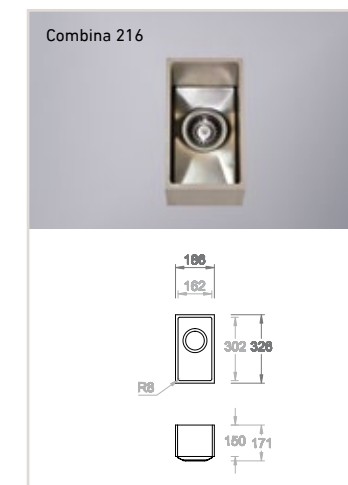
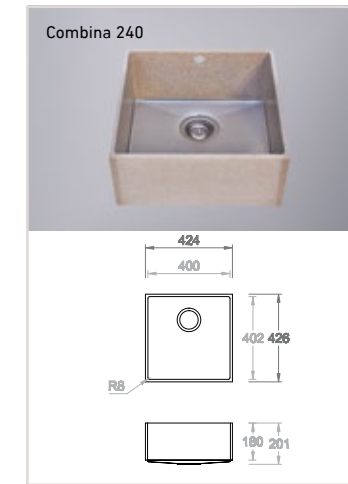
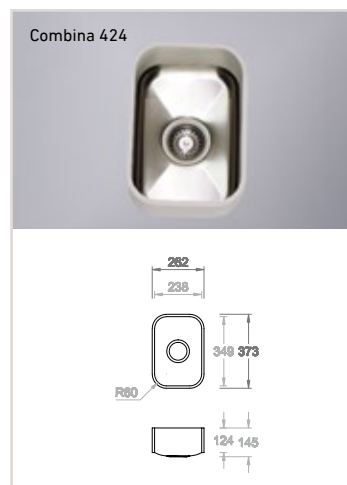

Bowls. Hygienic and beautiful.

Creative designers have every option at their disposal to create beautiful and highly functional bathrooms and kitchens with the extensive range of HI-MACS® bowls and sinks. All sinks can be incorporated or supported flush within the sheet material. Special customised products are also available outside the standard range.

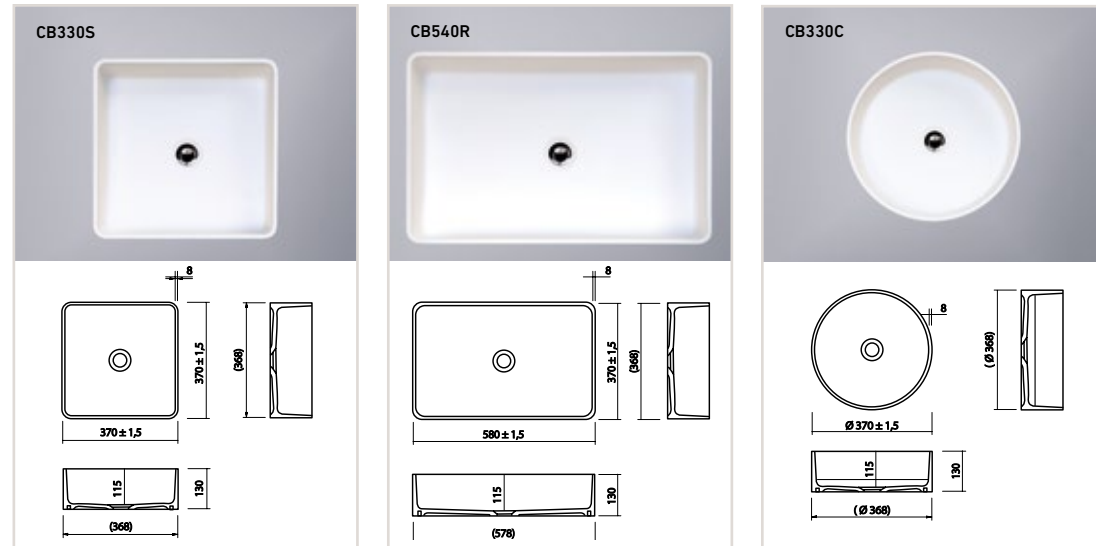

HI-MACS® Bowls for bathrooms (top mount installation)

These three shapes are HI-MACS® answer to the trend for linear designs. All three bowls were exclusively designed as top-mounted bowls. The narrow radius of the two rectangular models creates exceptionally spacious bowls.

HI-MACS® Bowls for bathrooms

Pleasantly warm to the touch – simple to look after: HI-MACS® washbasins are produced in a casting process and can be fitted flush or supported in washstands made of HI-MACS®.

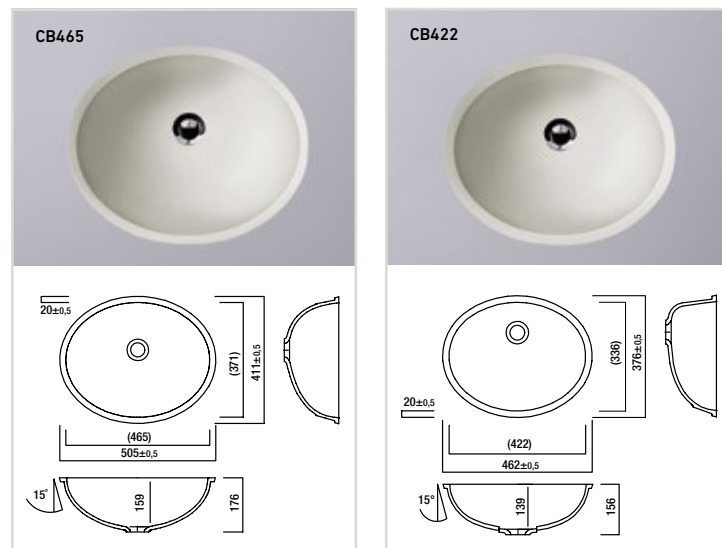

HI-MACS® Baby Bath

The neo-natal ward of a hospital is the one place where maximum hygiene, ergonomics and warmth is the order of the day. The ergonomic shape of the bowl is specifically designed for babies.

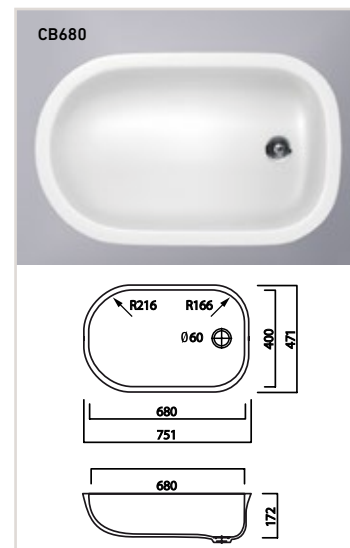

Thermoformed Bowls

Available in all colours (except Marmo, Volcanics and disclaimer colours) these come with a 10 year manufacturer's warranty. Fabricated bowls are made to order – Allow a 4 week lead time from date of order.

A basin waste needs to be acquired separately from a plumbers merchant.

It is important to understand that colour matching cannot be guaranteed between the bowls and sheet. Sheets must be rebated. Please follow the guidelines which come with your fabricated bowl.

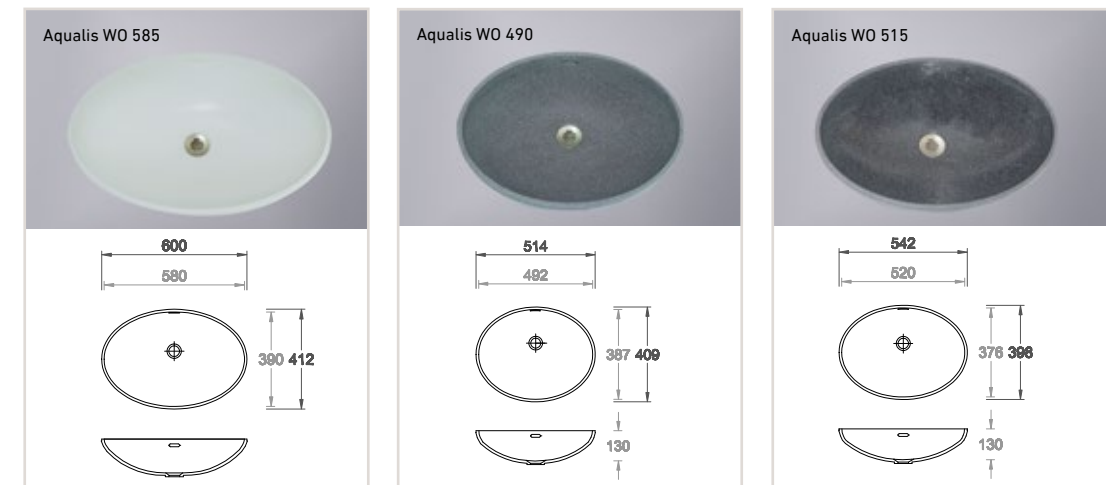
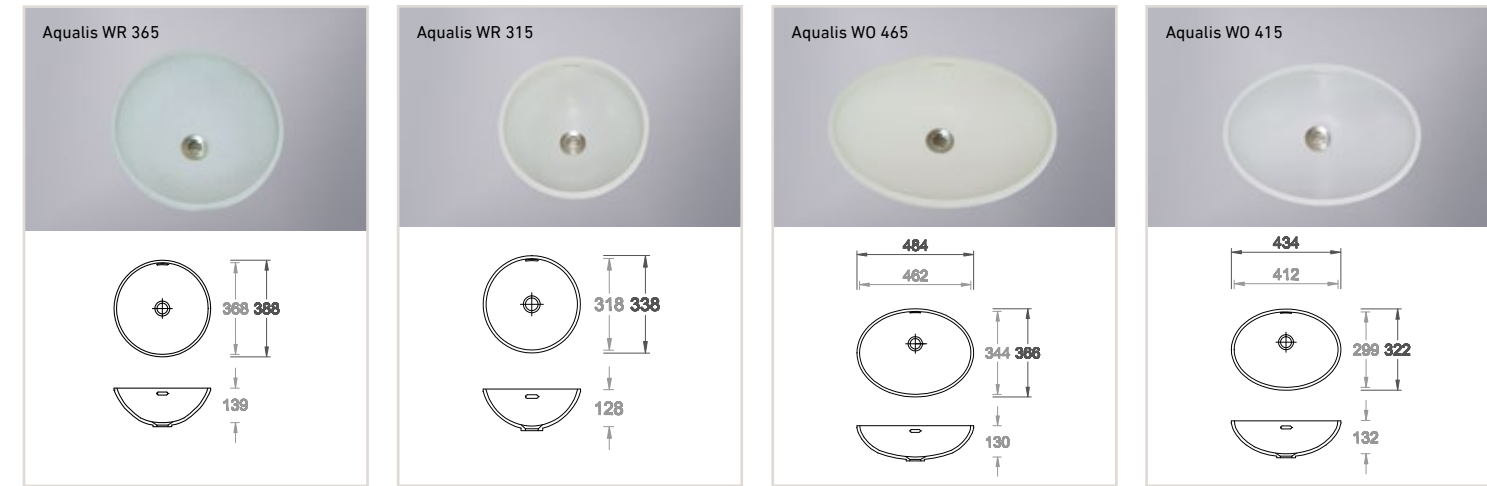

When pouring boiling liquids including boiling water taps into HI-MACS® sinks and bowls, cold water should be poured in at the same time.

HI-MACS® sinks and HI-MACS® washstands are available in Alpine White S028 and Nougat Cream S201.
HI-MACS® Baby Bath is available only in Alpine White S028.
Warranty: 15 years on all precast HI-MACS® bowls, sinks and baby bath.



Minimum order quantities apply:
S001, S002, S005, S006,
S009, S029, S033

The colours for kitchen and bathroom.

Colours are key in design: elegant Cream, hot Allspice Quartz or delicious Mocha Granite ...

We have whatever you want – it's your choice.

Solids

From elegant to extravagant, classic to ultra-contemporary.



Granite, Sparkle, Quartz, Sand & Pearl

A huge selection of textures and colours. Natural, elegant and perfect in combination.

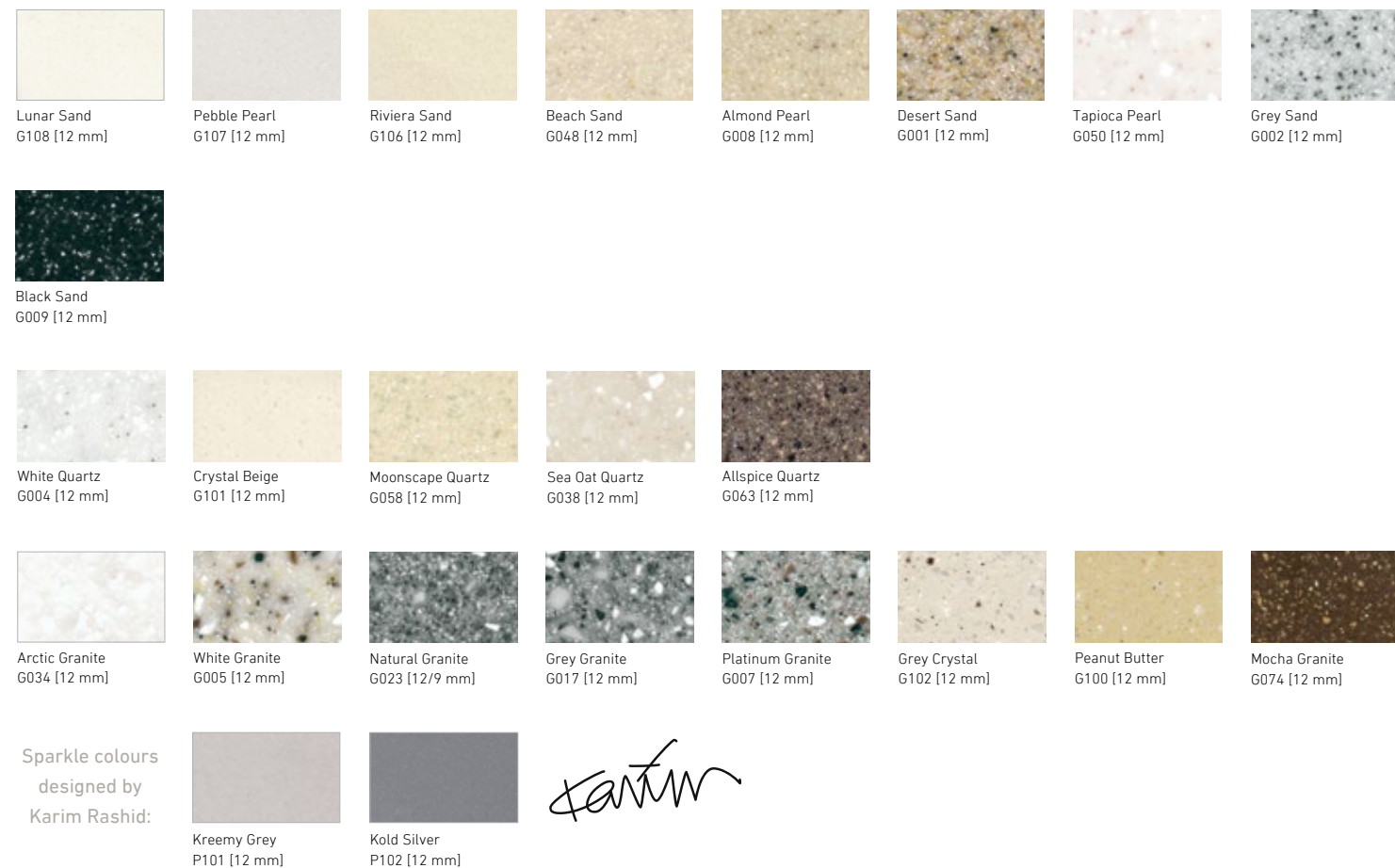

Lucia

Natural colour trends characterised by linear-edged, midsize particles: two of those designed by Dutch Star Designer, Marcel Wanders.

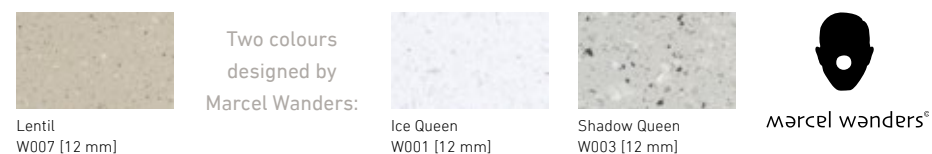

Care and Maintenance

HI-MACS® Natural Acrylic Stone™ is hard-wearing, durable and extremely resistant to stains and is therefore very easy to look after. Below are a few simple tips and hints for caring for HI-MACS® to help maintain its exceptional quality for many years to come.

General day-to-day stains

HI-MACS® is a completely homogenous material. As it does not have any pores, you can simply and easily clean it with a damp cloth or sponge and a mild detergent. You can also use a domestic scouring agent on all matt finishes. It is useful to wipe your surface occasionally with a scouring agent or wet sponge to retain the even finish of your product.

Tougher stains

Tougher stains, caused by food colouring, tea or fruit juice can easily be removed using a bleaching agent (do not leave in contact with the work surface for more than five minutes). Clean the surface with a domestic all-purpose cleaner and rinse with clean water. You can also use a scouring agent on matt finishes. Nail varnish can easily be removed with nail varnish remover (acetone-free) or a scouring agent.

Acidic cleaning agents

A number of cleaning agents contain acids, such as methyl chloride or acetone. You should avoid using these on a HI-MACS® surface. Should one of these products accidentally come into contact with the material, as a precautionary measure you should rinse the surface with soapy water to prevent any discolouring taking place.

Hot objects and boiling water

Hot saucepans or pots straight out of the oven or from the hob should not be laid directly on the HI-MACS® surface. Place a mat or board underneath to prevent any damage to your product. If you pour boiling liquids into HI-MACS® sinks or basins, you should also pour in cold water at the same time. This also applies to the use of boiling water taps.

Burn marks

Small burn marks or marks caused by nicotine can simply be removed using a scouring agent or an abrasive sponge. Should this give the high-gloss finish a matt appearance, rubbing the surface with a scouring pad will quickly return it to its high-gloss state.

Sharp objects

HI-MACS® copes effortlessly with the wear and tear of everyday life, however pointed or sharp-edged objects can leave cuts or scratches on the HI-MACS® surface. You can repair smaller cuts and scratches without too much trouble but we recommend the services of a professional for especially deep cuts.

Aster (Galaxy)

With transparent grains and mother of pearl shimmer.

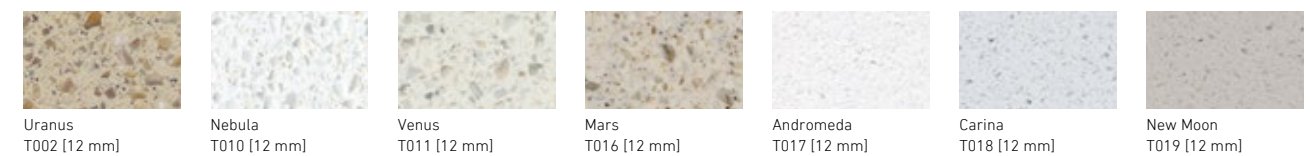

Marmo

Marmo has a random, veined texture, similar to marble.

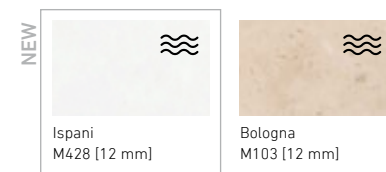

Volcanics

Looks like a precious natural stone but with all of the advantages of "Natural Acrylic Stone™".



The basic HI-MACS® material is identical for every colour, although darker hues have a higher percentage of natural pigments. There may be some slight variation in colour between the illustrated and actual colours due to printing techniques. The recommended finish for kitchen worktops is semi-matt.

≅ Marmo is a randomly veined product, specific fabrication guidelines need to be followed. Ask your sales partner for more information, and see more details at himacs.eu.

Resistant for your benefit.

HI-MACS® is extremely hard-wearing and durable and transforms your kitchen or bathroom into a universally functional room.

TEST SUBSTANCE	APPLICATION TIME	EVALUATION OF G02 CHANGES	EVALUATION OF S06 CHANGES
Acetic acid	16h	no change	no change
Citric acid	16h	no change	no change
White wine, red wine	16h	no change	no change
Cola drinks	16h	no change	no change
Instant coffee	16h	no change	no change
Black Tea	16h	no change	no change
Blackcurrant juice	16h	no change	no change
Cream	16h	no change	no change
Water	16h	no change	no change
Butter	16h	no change	no change
Olive Oil	16h	no change	no change
Mustard	16h	no change	no change
Salt	16h	no change	no change
Onions	16h	no change	no change
Common household disinfectant	16h	no change	no change
Cleaning agent	16h	no change	no change
Cleaning solution	16h	no change	no change

Please feel free to contact us
for further information.

HI-MACS®. Because Quality Wins.

European Headquarters:
LG Hausys Europe GmbH
Lyoner Str. 15
60528 Frankfurt
Germany
info@himacs.eu

To see more kitchen and bathroom styles or to find the contact
for your region, please visit our website.

himacs.eu



HI-MACS® Natural Acrylic Stone™ and HI-MACS Structura® are registered trademarks of LG Hausys Europe GmbH. All other trademarks and product names are trademarks or registered trademarks of their respective rights owners. The information contained in this brochure is intended to be for information only and can be amended at any time without prior notification. ©2017. LG Hausys Europe GmbH. All rights reserved.