

High Performance Bench Fume Hood

with Self-closing Vertical Rising Sash



Available Models:
Dynamic Barrier By-Pass

Available Options:

- Automatic Sash Operator
- Air Flow Alarms
- Service Fittings and Piping
- Electrical Fixtures and Wiring
- UL listed when pre-wired per UL 61010A-1
- 1805 UL classified with Kemglass or Stainless Steel liner
- Vapor Proof and Explosion Proof Lighting
- Stainless Steel Sill
- Tempered Sash Glass
- Tissue Screen
- Fire Extinguisher
- Distillation Rack
- Stainless Steel Duct Collar

Features:

- Patented, self-closing sash to 18" for less exhaust volume and maximum protection.
- Patented Dynamic Barrier by-pass provides safe flow of clean air between experiment and user
- Stainless steel cable reinforced, notched nylon belt and sprocketed sash counterweight system for level, smooth, quiet sash operation.
- Unique interstitial, vertical slot baffles for exceptional turbulence free airflow and minimal upper vortex roll. Removable for easy cleaning and hood maintenance.
- 35 $\frac{1}{2}$ " high frameless safety glass sash for optimal unobstructed sight into hood.
- 28" high sash opening with automatic hold-open latch for easy loading and set-up.
- T-5 fluorescent light for increased energy savings.
- Triangular shaped access panels with staggered service outlet for easy set-up and maintenance.
- Notched sash handle for neat and easy cord and hose management.
- Designed and tested using ASHRAE 110-1995, BS 7258, and DIN 12 924 standards.

Supreme Air LV Fume Hood

LV05

Specifications:

Supreme Air LV Bench Hoods are furnished with a choice of liner and baffles, and each fume hood is complete with a lower deflector vane, counterbalanced, self-closing (to 18"), frameless sash of 1/4" combination safety glass and

interior plumbing access panels. Hood exteriors are fabricated of cold rolled steel, phosphate coated with a baked chemical resistant, synthetic resin finish. The exhaust duct collar is polyethylene, 11^{15/16}" O.D. (8 foot hoods are furnished with two duct

collars.) Supreme Air LV Bench Hoods are not designed for use with auxiliary air chambers.

Additional Parts Required to Make Up a Complete Fume Hood Assembly

Work Top	see page 49
Base Cabinets	see page 63
Service Fittings	see page 57
Cupsink	see page 53
Fan/Blower	see page 82

Liner Options:

- T** = Phenolic Resin
- G** = Kemglass
Fiberglass reinforced polyester
- S** = Type 304 Stainless Steel

The blank left in the fume hood catalog numbers is for designating the desired lining.

Example: LV05T543448-00 would designate a 4' hood with a Phenolic Resin lining.

DIMENSIONS	HEIGHT	LENGTH					DEPTH
Overall Dimension	89 ^{3/4} " *	48"	60"	72"	84"	96"	36 ^{3/4} "
Work Top	37" *	39"	51"	63"	75"	87"	24"
Clearance (sash up)	103" *

* Subtract 1" in height if wood base cabinets are used.

Airflow Requirements

Overall Hood Width	Sq. Ft. Opening at 28" Sash Opening *	Sq. Ft. Opening at 18" Sash Opening *	HIGH SETTING 100 FPM at 18" 66 FPM at 28"		MEDIUM SETTING 84 FPM at 18" 55 FPM at 28"		LOW SETTING 55 FPM at 18" 28" Not Recommended	
			CFM	SP	CFM	SP	CFM	SP
4'-0" / 48"	7.85	5.15	515	0.20	430	0.15	285	0.10
5'-0" / 60"	10.27	6.73	675	0.20	565	0.15	370	0.12
6'-0" / 72"	12.69	8.31	830	0.25	700	0.20	460	0.15
7'-0" / 84"	15.10	9.90	990	0.33	830	0.25	545	0.18
8'-0" / 96"	17.52	11.49	1150	0.20	965	0.15	630	0.10

* Includes free area contributions from sash clearance spaces and bypass opening.

Static pressures shown are for the pressure drop through the hoods only. The total pressure drop through the hood and the duct system must be calculated to select the proper exhaust fan.

Accessories Include: Two 120 volt AC 20 amp GFI receptacles, single-tube, T-5 fluorescent light fixture with bulb and 20 amp light switch. **No wiring for the electrical fixtures is included unless H-Option is added to part number. Hoods with H-Option are UL listed.**

Optional Accessories: Each front post and interior end liner is punched for up to five (5) remote control service fittings. The right hand post is punched for a second electrical fixture at the top which may be used for a fan switch or other electrical device. **Service fittings, fan, fan switch, work top, cupsink, and base units must be ordered separately.**

High Performance Low Velocity Bench Fume Hoods — Self-closing Vertical Rising Sash

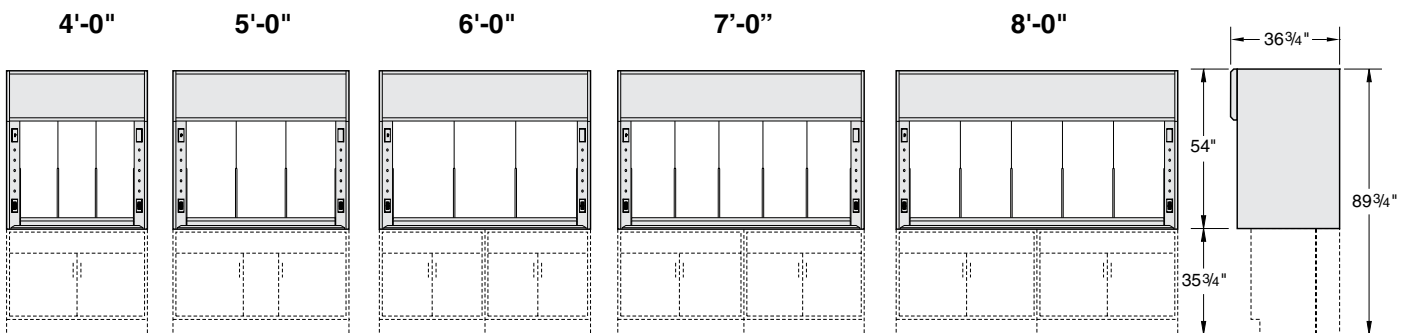

LV05_543448-00

LV05_543460-00

LV05_543472-00

LV05_543484-00

LV05_543496-00

End View

Note: See page 44 for chart of available options.

General Purpose Bench Fume Hood

with Vertical Rising Sash

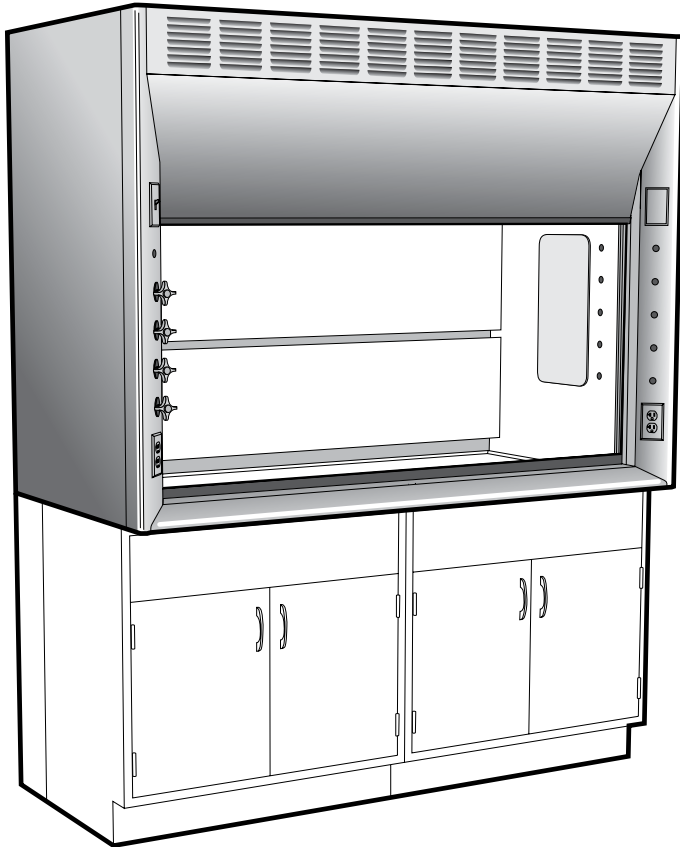

Available Options:

- Adjustable Baffles
- Air Flow and Static Pressure Alarms
- Service Fittings and Piping
- Electrical Fixtures and Wiring
- UL listed when pre-wired per UL 61010A-1
- 1805 UL classified with Kemglass or Stainless Steel liner
- Vapor Proof and Explosion Proof Lighting
- Stainless Steel Deflector Vane
- Alternate Sash Handles
- Sash Frames
- Tempered Sash Glass
- Tissue Screen
- Fire Extinguisher
- Distillation Rack
- Sash Stop
- Stainless Steel Duct Collar

Available Models:

- Open By-Pass
- Restricted By-Pass
- Auxiliary Air

Features:

- Radiused corner posts and airfoils for smooth air movement assures high level of comfort, safety and efficiency.
- 4" thick endwalls provide more interior work space and clean-lined uncluttered design.
- Interior baffles designed to minimize turbulence and optimize containment.
- Frameless sash with full-length formed steel handle for neat, clean appearance and streamline air features.
- Low profile PVC sash tracks and exclusive sash leveling and alignment features assure easy-smooth sash operation
- Large friction-fit interior access panels provide easy access to piping and service fittings.
- Heavy gauge cold rolled steel exterior panels with independent rigid structural frame.
- Designed and tested using ASHRAE 110-1995, BS 7258, and DIN 12 924 standards.

Supreme Air Fume Hood

H05

Specifications:

Supreme Air General Purpose Bench Fume Hoods are furnished with a choice of liner and baffles with upper, center, and lower exhaust slots. Each fume hood is complete with a lower deflector vane, counterbalanced, frameless sash of 1/4" combination

safety glass and interior plumbing access panels. Hood exteriors are fabricated of cold rolled steel, phosphate coated with a baked chemical resistant, synthetic resin finish. The exhaust duct collar is polyethylene, 11¹⁵/₁₆" O.D. (8 foot

hoods are furnished with two duct collars.) Supreme Air Bench Hoods are available with either an Open By-Pass or a Restricted By-Pass for VAV use. An auxiliary air chamber is available for use on the Open By-Pass hood.

Additional Parts Required to Make Up a Complete Fume Hood Assembly

Work Top	see page 49
Base Cabinets	see page 63
Service Fittings	see page 54
Cupsink	see page 53
Fan/Blower	see page 82

DIMENSIONS	HEIGHT	LENGTH				DEPTH
Overall Dimension	89 3/4" **	48"	60"	72"	96"	36"
Sash Opening	28" *	40"	52"	64"	88"	...
Work Top	37" **	40"	52"	64"	88"	25 1/2"
Clearance (sash up)	97" **

* Sash opening height above airfoil. Add 1" in height to calculate sash opening area.
** Subtract 1" in height if wood base cabinets are used.

Liner Options:

- T** = Phenolic Resin
- G** = Kemglass
Fiberglass reinforced polyester
- S** = Type 304 Stainless Steel

The blank left in the fume hood catalog numbers is for designating the desired lining.

Example: H05T5448-00 would designate a 4' hood with a Phenolic Resin lining.

Overall Hood Length	Sash Opening Sq. Ft.	Total CFM and Static Pressure					
		80 FPM	S.P.	100 FPM	S.P.	120 FPM	S.P.
4'-0" / 48"	8.1	650	0.15"	810	0.25"	980	0.35"
5'-0" / 60"	10.5	840	0.20"	1050	0.30"	1260	0.45"
6'-0" / 72"	12.9	1040	0.25"	1290	0.40"	1550	0.60"
8'-0" / 96"	17.7	1420	0.15"	1770	0.25"	2130	0.35"

Static pressures shown are for the pressure drop through the hoods only. The total pressure drop through the hood and the duct system must be calculated to select the proper exhaust fan.

Note: CFM requirements shown above are for **Open By-Pass** hoods. The CFM requirements for a **Restricted By-Pass** hood with the sash fully open is the same as above. The by-pass opening with the sash closed is 20% of that with the sash fully open.

Accessories Include: Two 120 volt AC 20 amp GFI receptacles, single-tube, T-5 fluorescent light fixture with bulb and 20 amp light switch. **No wiring for the electrical fixtures is included unless H-Option is selected.**

Optional Accessories: Each front post and interior end liner is punched for up to five (5) remote control service fittings. The right hand post is punched for a second electrical fixture at the top which may be used for a fan switch or other electrical device. **Service fittings, fan, fan switch, work top, cupsink, and base units must be ordered separately.**

General Purpose Bench Fume Hoods — Vertical Rising Sash

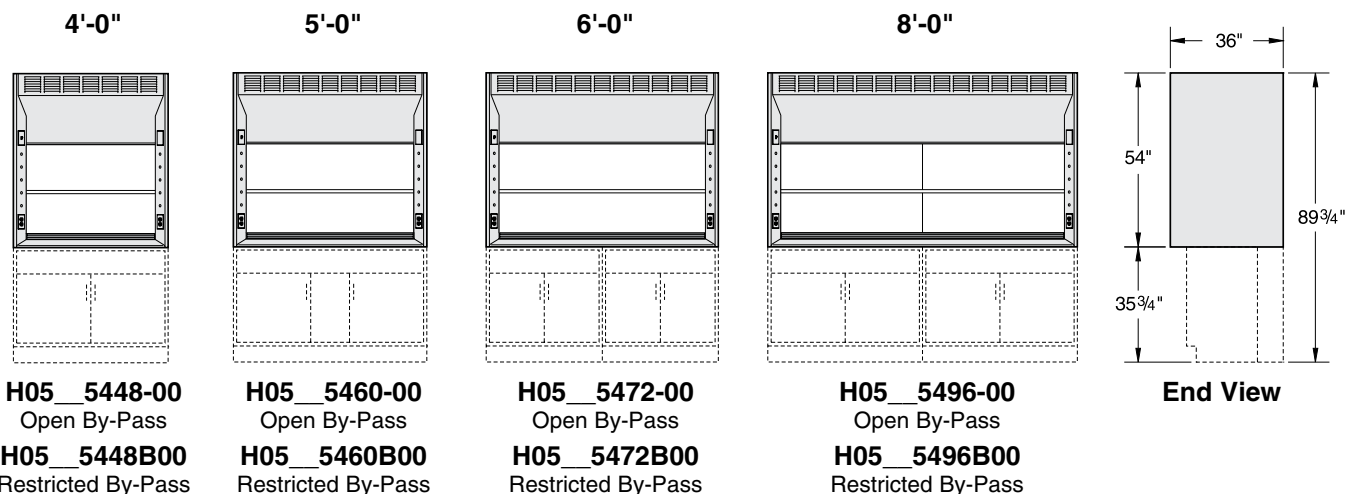

Auxiliary Air

All Open By-Pass hoods can be Auxiliary Air hoods by adding an Auxiliary Air Chamber. See page 43 for catalog numbers.

Note: See page 44 for chart of available options.

Note: Open By-Pass Fume Hood shown. Restricted By-Pass Fume Hoods do not have louvered top front panel.

Ultra Low Constant Volume Fume Hood

with Telescoping Combination Vertical Rising/Horizontal Sash

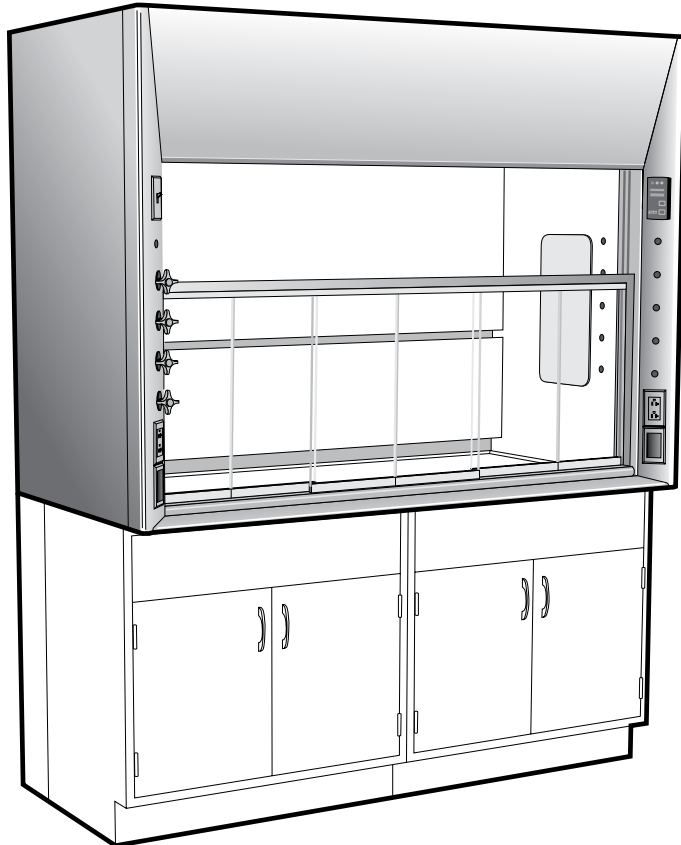

Available Models:
Dynamic Barrier By-Pass

Available Option:

Service Fittings and Piping
Electrical Fixtures and Wiring
UL listed when pre-wired per UL 61010A-1
1805 UL classified with Kemglass
or Stainless Steel liner
Lighting
Stainless Steel Deflector Vane
Tempered Sash Glass
Tissue Screen
Fire Extinguisher
Distillation Rack
Stainless Steel Duct Collar

Features:

- Requires over 70 percent less exhaust air volume than a traditional by-pass fume hood.
- Double telescoping vertical sash design allows full view into hood interior and 37" opening height for apparatus setup.
- Radiused corner posts and airfoils for smooth air movement assures high level of comfort, safety and efficiency.
- 4" thick endwalls provide more interior work space and clean-lined uncluttered design.
- Low profile sash frame for easy access through horizontal panels.
- Service ports provide convenient, safe passage for equipment connections.
- Exclusive Air Alert 600 Monitor provides a visual one-hour timeline of fume hood performance.
- Exclusive static pressure averaging mechanism provides accurate face velocity readings regardless of sash opening.
- Quiet fume hood operation, under 40 dBA with properly sized fans and ductwork.
- Designed and tested using ASHRAE 110-1995, BS 7258, and DIN 12 924 standards.

Dynamic Barrier Fume Hood

H50

Specifications:

Dynamic Barrier Supreme Air Bench Fume Hoods are furnished with a choice of liner and baffles with center and lower exhaust slots. Each fume hood is complete with a lower deflector vane, lower sash frame fitted with six 1/4" combination safety glass

panels, interlocking upper frameless 1/4" combination safety glass sash, and an Air Alert 600 Monitor with static pressure averaging. Hood exteriors are fabricated of cold rolled steel, phosphate coated with a baked chemical resistant, synthetic

resin finish. The exhaust duct collar is polyethylene, 7¹⁵/₁₆" O.D. (8 foot hoods are furnished with two duct collars.)

Dynamic Barrier Supreme Air Bench Hoods are not designed for use with auxiliary air chambers.

Additional Parts Required to Make Up a Complete Fume Hood Assembly

- Work Top** see page 49
- Base Cabinets** see page 63
- Service Fittings** see page 54
- Cupsink** see page 53
- Fan/Blower** see page 82

Liner Options:

- T** = Phenolic Resin
- G** = Kemglass
Fiberglass reinforced polyester
- S** = Type 304 Stainless Steel

The blank left in the fume hood catalog numbers is for designating the desired lining.

Example: H50T5448-00 would designate a 4' hood with a Phenolic Resin lining.

DIMENSIONS	HEIGHT	LENGTH				DEPTH
Overall Dimension	89 3/4" *	48"	60"	72"	96"	36"
Sash Opening	37"	40"	52"	64"	88"	...
Work Top	37" *	40"	52"	64"	88"	25 1/2"
Clearance (sash up)	98 3/4" *

* Subtract 1" in height if wood base cabinets are used.

Overall Hood Length	Maximum Face Opening of Horizontal Sashes				Face Opening with Vertical Sash at 10" Sash Stop				Total CFM and Static Pressure	
	W	H	Ft ² *	Velocity	W	H	Ft ² *	Velocity	CFM	S.P.
4'-0" / 48"	14 1/2"	22"	2.25	100 fpm	40"	10"	2.78	81 fpm	225	0.11"
5'-0" / 60"	18"	22"	2.80	100 fpm	52"	10"	3.61	80 fpm	280	0.15"
6'-0" / 72"	22"	22"	3.50	100 fpm	64"	10"	4.44	80 fpm	350	0.21"
8'-0" / 96"	30"	22"	4.85	100 fpm	88"	10"	6.11	80 fpm	485	0.11"

* Includes free area contributions from sash clearance spaces and by-pass opening.

Static pressures shown are for the pressure drop through the hoods only. The total pressure drop through the hood and the duct system must be calculated to select the proper exhaust fan.

Accessories Include: Two 120 volt AC 20 amp GFI receptacles, single-tube, T-5 fluorescent light fixture with bulb and 20 amp light switch, Air Alert 600 Air Flow Monitor and two cord ports. **No wiring for the electrical fixtures is included unless H-Option is added to part number.**

Optional Accessories: Each front post and interior end liner is punched for up to five (5) remote control service fittings. **Service fittings, fan, fan switch, work top, cupsink, and base units must be ordered separately.**

Dynamic Barrier Bench Fume Hoods — Telescoping Combination Vertical Rising/Horizontal Sash

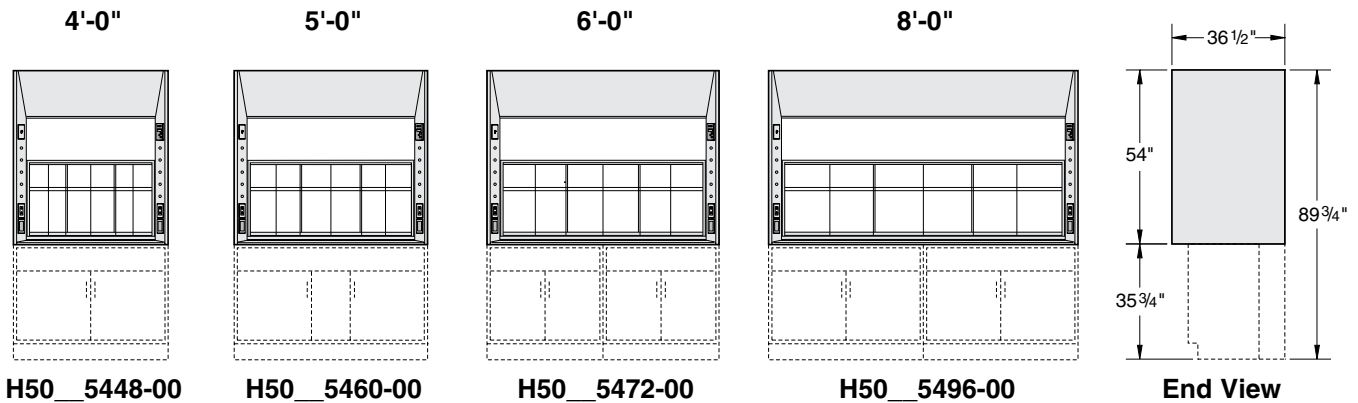

Note: See page 44 for chart of available options.

Combination Sash Bench Fume Hood

with Combination Vertical Rising/Horizontal Sash

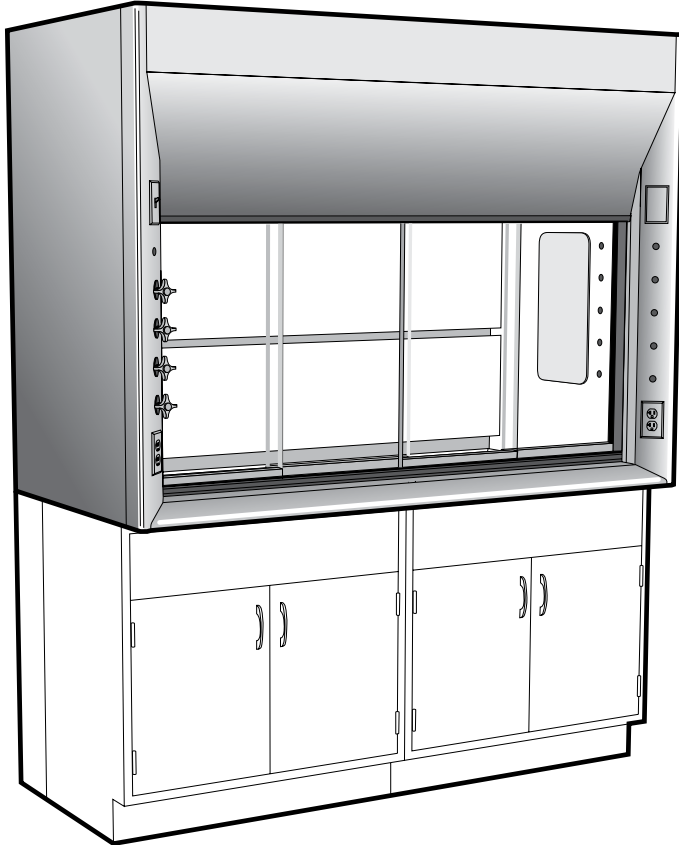

Available Options:

- Adjustable Baffles
- Air Flow and Static Pressure Alarms
- Service Fittings and Piping
- Electrical Fixtures and Wiring
- UL listed when pre-wired per UL 61010A-1
- 1805 UL classified with Kemglass or Stainless Steel liner
- Vapor Proof and Explosion Proof Lighting
- Stainless Steel Deflector Vane
- Stainless Steel Sash Frame
- Tempered Sash Glass
- Tissue Screen
- Fire Extinguisher
- Distillation Rack
- Sash Stop
- Stainless Steel Duct Collar

Available Models:
Restricted By-Pass
Open By-Pass
(by special request only)

Features:

- Radiused corner posts and airfoils for smooth air movement assures high level of comfort, safety and efficiency.
- 4" thick endwalls provide more interior work space and clean-lined uncluttered design.
- Interior baffles designed to minimize turbulence and optimize containment.
- Narrow framed sash with four horizontal glass panels on two tracks for neat clean appearance and improved exhaust efficiency.
- Low profile PVC sash tracks and exclusive sash leveling and alignment features assure easy-smooth sash operation
- Large friction-fit interior access panels provide easy access to piping and service fittings.
- Heavy gauge cold rolled steel exterior panels with independent rigid structural frame.
- Designed and tested using ASHRAE 110-1995, BS 7258, and DIN 12 924 standards.

Supreme Air Fume Hood

H07

Specifications:

Supreme Air Combination Sash Bench Fume Hoods are furnished with a choice of liner and baffles with upper, center, and lower exhaust slots. Each fume hood is complete with a lower deflector vane, counterbalanced, narrow framed sash with 1/4" combination safety glass horizontal panels and interior plumbing access panels. Hood exteriors are fabricated

of cold rolled steel, phosphate coated with a baked chemical resistant, synthetic resin finish. The exhaust duct collar is polyethylene, 1 15/16" O.D. (8 foot hoods are furnished with two duct collars.)

Combination Sash Bench Hoods are furnished with a Restricted By-Pass to match the restricted sash opening. They are designed for use with both constant volume and VAV applications. An Open By-Pass is available on request for applications where the hood is operated with the sash fully open. Combination Sash Bench Hoods are not designed for use with Auxiliary Air Chambers.

Additional Parts Required to Make Up a Complete Fume Hood Assembly

Work Top	see page 49
Base Cabinets	see page 63
Service Fittings	see page 54
Cupsink	see page 53
Fan/Blower	see page 82

Liner Options:

- T** = Phenolic Resin
- G** = Kemglass
Fiberglass reinforced polyester
- S** = Type 304 Stainless Steel

The blank left in the fume hood catalog numbers is for designating the desired lining.

Example: H07T5448-00 would designate a 4' hood with a Phenolic Resin lining.

DIMENSIONS	HEIGHT	LENGTH				DEPTH
Overall Dimension	89 3/4" **	48"	60"	72"	96"	36"
Sash Opening	28" *	40"	52"	64"	88"	...
Work Top	37" **	40"	52"	64"	88"	25 1/2"
Clearance (sash up)	97" **

* Sash opening height above airfoil. Add 1" in height to calculate sash opening area.
** Subtract 1" in height if wood base cabinets are used.

Overall Hood Length	Sash Opening Sq. Ft. *	Total CFM and Static Pressure					
		80 FPM	S.P.	100 FPM	S.P.	120 FPM	S.P.
4'-0" / 48"	4.8	380	0.05"	480	0.10"	580	0.15"
5'-0" / 60"	6.3	500	0.10"	630	0.15"	760	0.20"
6'-0" / 72"	7.8	620	0.10"	780	0.15"	940	0.25"
8'-0" / 96"	10.9	870	0.10"	1090	0.10"	1310	0.15"

* Maximum sash opening with vertical sash down and horizontal panels fully open. Includes By-Pass opening and 1" below deflector vane.

Static pressures shown are for the pressure drop through the hoods only. The total pressure drop through the hood and the duct system must be calculated to select the proper exhaust fan.

Accessories Include: Two 120 volt AC 20 amp GFI receptacles, single-tube, T-5 fluorescent light fixture with bulb and 20 amp light switch. **No wiring for the electrical fixtures is included unless H-Option is selected.**

Optional Accessories: Each front post and interior end liner is punched for up to five (5) remote control service fittings. The right hand post is punched for a second electrical fixture at the top which may be used for a fan switch or other electrical device. **Service fittings, fan, fan switch, work top, cupsink, and base units must be ordered separately.**

Combination Sash Bench Fume Hoods — Combination Vertical Rising/Horizontal Sash

4'-0"

5'-0"

6'-0"

8'-0"

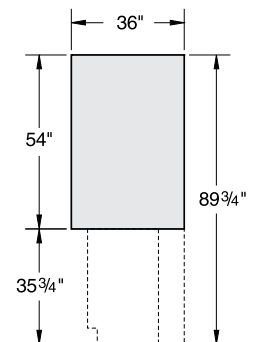
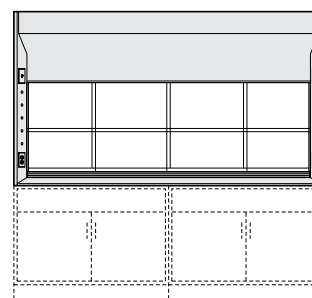
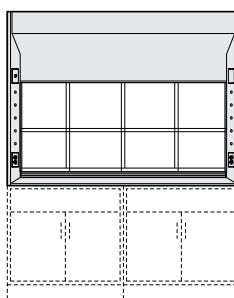
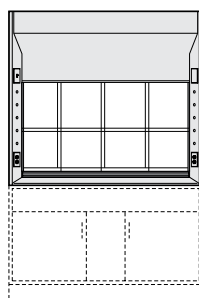
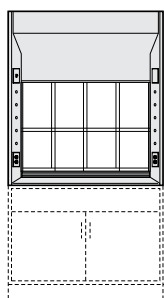

H07_5448B00
View

Restricted By-Pass

H07_5460B00

Restricted By-Pass

H07_5472B00

Restricted By-Pass

H07_5496B00

Restricted By-Pass

End

Open By-Pass by special request

Note: See page 44 for chart of available options.

Note: Restricted By-Pass Fume Hood shown. Open By-Pass Fume Hoods have louvered top front panel.

ADA Bench Fume Hood

with Vertical Rising Sash

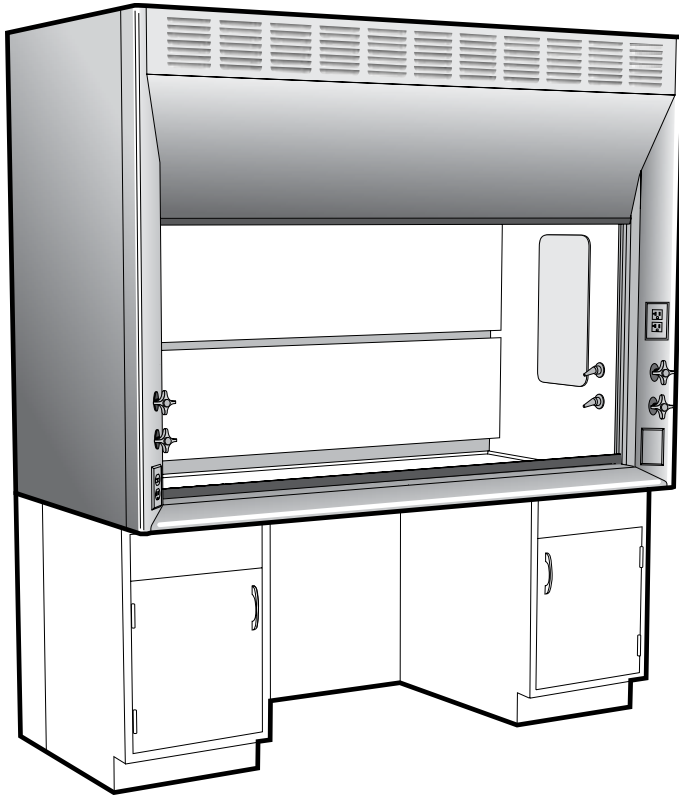

Available Options:

- Adjustable Baffles
- Air Flow and Static Pressure Alarms
- Service Fittings and Piping
- Electrical Fixtures and Wiring
- UL listed when pre-wired per UL 61010A-1
- 1805 UL classified with Kemglass or Stainless Steel liner
- Vapor Proof and Explosion Proof Lighting
- Stainless Steel Deflector Vane
- Alternate Sash Handles
- Sash Frames
- Tempered Sash Glass
- Tissue Screen
- Fire Extinguisher
- Distillation Rack
- Stainless Steel Duct Collar

Available Models:

- Open By-Pass
- Restricted By-Pass
- Auxiliary Air

Features:

- Designed to meet guidelines of the Americans with Disabilities Act (ADA)
- Complete with Gravity Sash Stop.
- Fixtures and service fittings moved down to within reach of wheelchair bound operator.
- Radiused corner posts and airfoils for smooth air movement assures high level of comfort, safety and efficiency.
- 4" thick endwalls provide more interior work space and clean-lined uncluttered design.
- Interior baffles designed to minimize turbulence and optimize containment.
- Frameless sash with full-length formed steel handle for neat, clean appearance and streamline air features.
- Low profile PVC sash tracks and exclusive sash leveling and alignment features assure easy-smooth sash operation
- Large friction-fit interior access panels provide easy access to piping and service fittings.
- Heavy gauge cold rolled steel exterior panels with independent rigid structural frame.
- Designed and tested using ASHRAE 110-1995, BS 7258, and DIN 12 924 standards.

Supreme Air Fume Hood

H08

Specifications:

Supreme Air Vertical Rising Sash ADA Bench Fume Hoods are furnished with a choice of liner and baffles with upper, center, and lower exhaust slots. Each fume hood is complete with a lower deflector vane, counterbalanced, frameless sash with 1/4" combination safety glass, and interior plumbing access panels. Hood exteriors are fabricated of cold

rolled steel, phosphate coated with a baked chemical resistant, synthetic resin finish. The exhaust duct collar is polyethylene, 1 15/16" O.D. Each hood is furnished with a sash stop mounted at 14" above the lower deflector to keep the sash from rising above the operators reach.

Supreme Air ADA Bench Hoods with Vertical Rising Sash are available with either an Open By-Pass or a Restricted By-Pass for VAV use. An auxiliary air chamber is available for use on the Open By-Pass hood.

Additional Parts Required to Make Up a Complete Fume Hood Assembly

- Work Top** see page 49
- Base Cabinets*** see page 63
- Service Fittings** see page 54
- Cupsink** see page 53
- Fan/Blower** see page 82

* ADA guidelines require a space 30" wide by 30" high by 25" deep for a wheelchair to roll beneath a fume hood.

Liner Options:

- T** = Phenolic Resin
- G** = Kemglass
Fiberglass reinforced polyester
- S** = Type 304 Stainless Steel

The blank left in the fume hood catalog numbers is for designating the desired lining.

Example: H08T5448-00 would designate a 4' hood with a Phenolic Resin lining.

DIMENSIONS	HEIGHT	LENGTH			DEPTH
Overall Dimension	84"	48"	60"	72"	36"
Sash Opening	14"	40"	52"	64"	...
Work Top	31 1/4"	40"	52"	64"	25 1/2"
Clearance (sash up)	91"

Overall Hood Length	Sash Opening Sq. Ft.	Total CFM and Static Pressure					
		80 FPM	S.P.	100 FPM	S.P.	120 FPM	S.P.
4'-0" / 48"	4.7	380	0.05"	470	0.10"	570	0.15"
5'-0" / 60"	6.1	490	0.10"	610	0.10"	740	0.15"
6'-0" / 72"	7.6	600	0.10"	760	0.15"	910	0.20"

Static pressures shown are for the pressure drop through the hoods only. The total pressure drop through the hood and the duct system must be calculated to select the proper exhaust fan.

Note: CFM requirements shown above are for **Open By-Pass** hoods with sash stop at 14". CFM requirements for sash fully open is same as H05. The CFM requirements for a **Restricted By-Pass** hood with the sash fully open is the same as above.

Accessories Include: 120 volt AC 20 amp GFI duplex receptacle, combination 20 amp light switch—120 volt receptacle, and single-tube, T-5 fluorescent light fixture with bulb. **No wiring for the electrical fixtures is included unless H-Option is selected.**

Optional Accessories: Each front post and interior end liner is punched for up to two (2) remote control service fittings. The right hand post is punched for a second electrical fixture at the bottom which may be used for a fan switch or other electrical device. **Service fittings, fan, fan switch, work top, cupsink, and base units must be ordered separately.**

ADA Bench Fume Hoods — Vertical Rising Sash

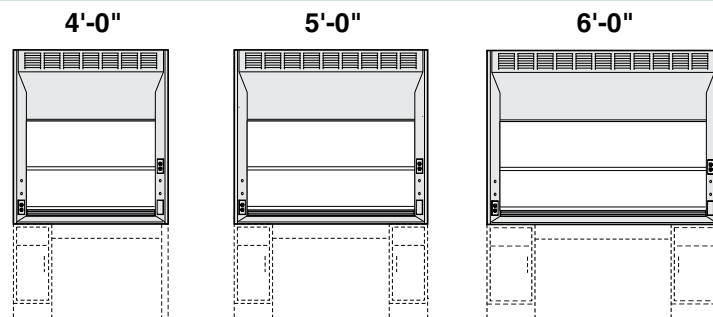

H08_5448-00
Open By-Pass

H08_5460-00
Open By-Pass

H08_5472-00
Open By-Pass

H08_5448B00
Restricted By-Pass

H08_5460B00
Restricted By-Pass

H08_5472B00
Restricted By-Pass

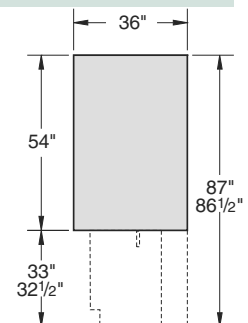

End View

Auxiliary Air

All Open By-Pass hoods can be Auxiliary Air hoods by adding an Auxiliary Air Chamber. See page 43 for catalog numbers.

Note: See page 44 for chart of available options.

Note: Open By-Pass Fume Hood shown. Restricted By-Pass Fume Hoods do not have louvered top front panel.

ADA Bench Fume Hood

with Combination Vertical Rising/Horizontal Sash

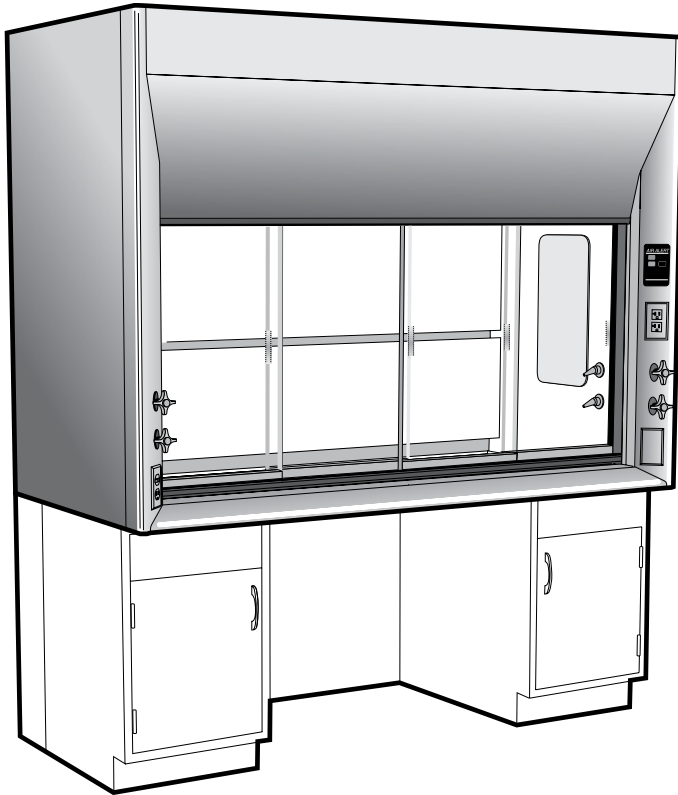

Available Models:
Restricted By-Pass
Open By-Pass
(by special request only)

Features:

- Designed to meet guidelines of the Americans with Disabilities Act (ADA)
- Complete with Air Alert 300 Alarm and Gravity Sash Stop.
- Fixtures and service fittings moved down to within reach of wheelchair bound operator.
- Radiused corner posts and airfoils for smooth air movement assures high level of comfort, safety and efficiency.
- 4" thick endwalls provide more interior work space and clean-lined uncluttered design.
- Interior baffles designed to minimize turbulence and optimize containment.
- Narrow framed sash with four horizontal glass panels on two tracks for neat clean appearance and improved exhaust efficiency.
- Low profile PVC sash tracks and exclusive sash leveling and alignment features assure easy-smooth sash operation
- Large friction-fit interior access panels provide easy access to piping and service fittings.
- Heavy gauge cold rolled steel exterior panels with independent rigid structural frame.
- Designed and tested using ASHRAE 110-1995, BS 7258, and DIN 12 924 standards.

Available Option:

Adjustable Baffles
Service Fittings and Piping
Electrical Fixtures and Wiring
UL listed when pre-wired per UL 61010A-1
1805 UL classified with Kemglass
or Stainless Steel liner
Vapor Proof and Explosion Proof Lighting
Stainless Steel Deflector Vane
Stainless Steel Sash Frame
Tempered Sash Glass
Tissue Screen
Fire Extinguisher
Stainless Steel Duct Collar

Supreme Air Fume Hood

H09

Specifications:

Supreme Air Combination Sash ADA Bench Fume Hoods are furnished with a choice of liner and baffles with upper, center, and lower exhaust slots. Each fume hood is complete with a lower deflector vane, counterbalanced, narrow framed sash with 1/4" combination safety glass horizontal panels and interior plumbing access panels.

Hood exteriors are fabricated of cold rolled steel, phosphate coated with a baked chemical resistant, synthetic resin finish. The exhaust duct collar is polyethylene, 11^{5/16}" O.D. Each hood is furnished with an Air Alert 300 Alarm and a sash stop mounted at 14" above the lower deflector.

ADA Combination Sash Hoods are furnished with a Restricted By-Pass to match the restricted sash opening. They are designed for use with both constant volume and VAV applications. An Open By-Pass is available on request for applications where the hood is operated with the sash fully open. Combination Sash Bench Hoods are not designed for use with Auxiliary Air Chambers.

Additional Parts Required to Make Up a Complete Fume Hood Assembly

- Work Top** see page 49
- Base Cabinets*** see page 63
- Service Fittings** see page 54
- Cupsink** see page 53
- Fan/Blower** see page 82

* ADA guidelines require a space 30" wide by 30" high by 25" deep for a wheelchair to roll beneath a fume hood.

Liner Options:

- T** = Phenolic Resin
- G** = Kemglass
Fiberglass reinforced polyester
- S** = Type 304 Stainless Steel

The blank left in the fume hood catalog numbers is for designating the desired lining.

Example: H09T5448-00 would designate a 4' hood with a Phenolic Resin lining.

DIMENSIONS	HEIGHT	LENGTH			DEPTH
Overall Dimension	84"	48"	60"	72"	36"
Sash Opening	29"	40"	52"	64"	...
Work Top	31 ^{1/4} "	40"	52"	64"	25 ^{1/2} "
Clearance (sash up)	91"

Overall Hood Length	Sash Opening Sq. Ft. *	Total CFM and Static Pressure					
		80 FPM	S.P.	100 FPM	S.P.	120 FPM	S.P.
4'-0" / 48"	4.8	380	0.05"	480	0.10"	580	0.15"
5'-0" / 60"	6.3	500	0.10"	630	0.15"	760	0.20"
6'-0" / 72"	7.8	620	0.10"	780	0.15"	940	0.25"

* Maximum sash opening with vertical sash down and horizontal panels fully open. Includes By-Pass opening and 1" below deflector vane.
Static pressures shown are for the pressure drop through the hoods only. The total pressure drop through the hood and the duct system must be calculated to select the proper exhaust fan.

Accessories Include: 120 volt AC 20 amp GFI duplex receptacle, combination 20 amp light switch—120 volt receptacle, single-tube, T-5 fluorescent light fixture with bulb, and an Air Alert 300 Airflow Alarm. **No wiring for the electrical fixtures is included unless H-Option is selected.**

Optional Accessories: Each front post and interior end liner is punched for up to two (2) remote control service fittings. The right hand post is punched for a second electrical fixture at the bottom which may be used for a fan switch or other electrical device. **Service fittings, fan, fan switch, work top, cupsink, and base units must be ordered separately.**

ADA Bench Fume Hoods — Combination Vertical Rising/Horizontal Sash

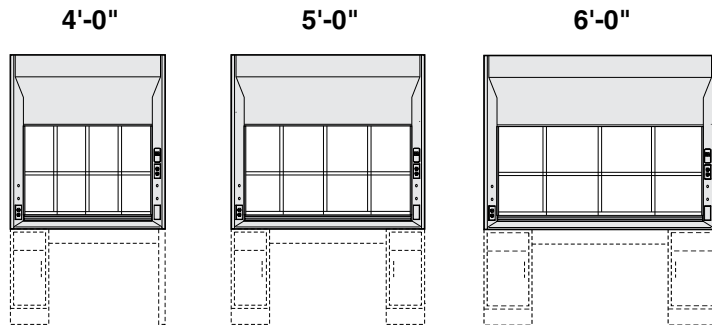

H09_5448B00
Restricted By-Pass

H09_5460B00
Restricted By-Pass

H09_5472B00
Restricted By-Pass

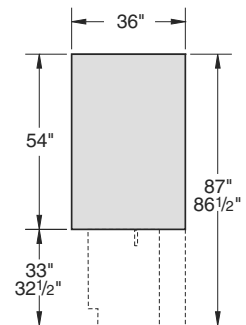

End View

Open By-Pass available by special request.

Note: See page 44 for chart of available options.

Note: Restricted By-Pass Fume Hood shown. Open By-Pass Fume Hoods have louvered top front panel.

Split Sash Bench Fume Hood

Split Vertical Rising Sash with Disappearing Center Post

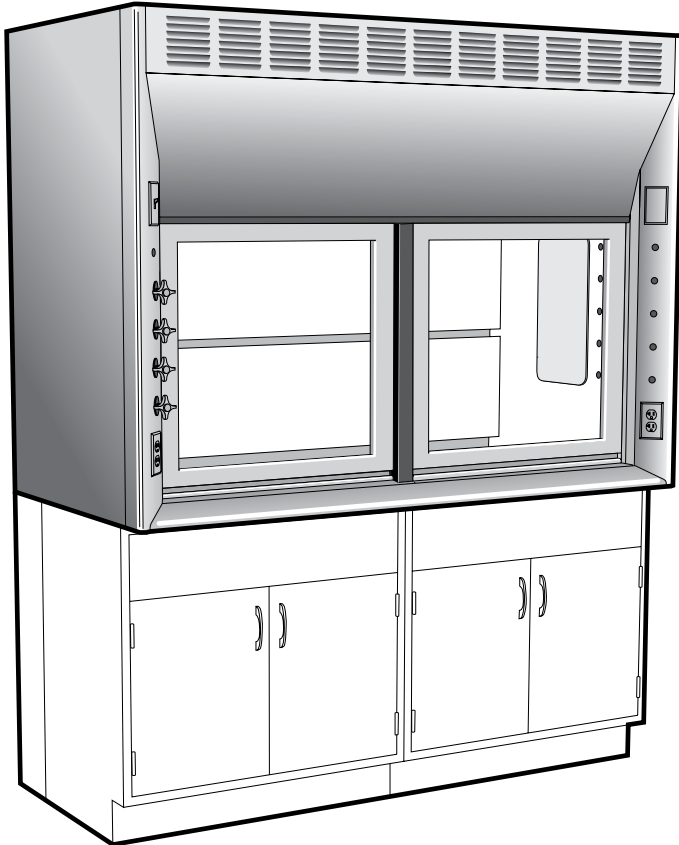

Available Models:
Open By-Pass
Restricted By-Pass
Auxiliary Air

Available Option:

Adjustable Baffles
Air Flow and Static Pressure Alarms
Service Fittings and Piping
Electrical Fixtures and Wiring
UL listed when pre-wired per UL 61010A-1
1805 UL classified with Kemglass
or Stainless Steel liner
Vapor Proof and Explosion Proof Lighting
Stainless Steel Deflector Vane
Stainless Steel Sash Frame
Tempered Sash Glass
Tissue Screen
Fire Extinguisher
Distillation Rack
Sash Stop
Stainless Steel Duct Collar

Features:

- Two piece vertical rising sash with a disappearing center post allows safer operating conditions.
- Radiused corner posts and airfoils for smooth air movement assures high level of comfort, safety and efficiency.
- 4" thick endwalls provide more interior work space and clean-lined uncluttered design.
- Interior baffles designed to minimize turbulence and optimize containment.
- Narrow framed sash with full-length formed steel handles for neat, clean appearance and streamline air features.
- Low profile PVC sash tracks and exclusive sash leveling and alignment features assure easy-smooth sash operation
- Large friction-fit interior access panels provide easy access to piping and service fittings.
- Heavy gauge cold rolled steel exterior panels with independent rigid structural frame.
- Designed and tested using ASHRAE 110-1995, BS 7258, and DIN 12 924 standards.

Supreme Air Fume Hood

H10

Specifications:

Supreme Air Split Sash Bench Fume Hoods are furnished with a choice of liner and baffles with upper, center, and lower exhaust slots. Each fume hood is complete with a lower deflector vane, counterbalanced, two-piece, steel framed sash with 1/4" combination

safety glass and interior plumbing access panels. Hood exteriors are fabricated of cold rolled steel, phosphate coated with a baked chemical resistant, synthetic resin finish. All are furnished with two polyethylene, 11¹⁵/₁₆" O.D. exhaust

duct collars. Supreme Air Bench Hoods are available with either an Open By-Pass or a Restricted By-Pass for VAV use. An auxiliary air chamber is available for use on the Open By-Pass hood.

Additional Parts Required to Make Up a Complete Fume Hood Assembly

Work Top	see page 49
Base Cabinets	see page 63
Service Fittings	see page 54
Cupsink	see page 53
Fan/Blower	see page 82

DIMENSIONS	HEIGHT	LENGTH			DEPTH
Overall Dimension	89 3/4" **	96"	120"	144"	36"
Sash Opening	28" *	88"	112"	136"	...
Work Top	37" **	88"	112"	136"	25 1/2"
Clearance (sash up)	107" **

* Sash opening height above airfoil. Add 1" in height to calculate sash opening area.
** Subtract 1" in height if wood base cabinets are used.

Liner Options:

- T** = Phenolic Resin
- G** = Kemglass
Fiberglass reinforced polyester
- S** = Type 304 Stainless Steel

The blank left in the fume hood catalog numbers is for designating the desired lining.

Example: H10T5472-00 would designate a 6' hood with a Phenolic Resin lining.

Overall Hood Length	Sash Opening Sq. Ft.	Total CFM and Static Pressure					
		80 FPM	S.P.	100 FPM	S.P.	120 FPM	S.P.
8'-0" / 96"	17.7	1420	0.15"	1770	0.25"	2130	0.35"
10'-0" / 120"	22.6	1810	0.25"	2260	0.35"	2720	0.50"
12'-0" / 144"	27.4	2200	0.30"	2740	0.45"	3290	0.65"

Static pressures shown are for the pressure drop through the hoods only. The total pressure drop through the hood and the duct system must be calculated to select the proper exhaust fan.

Note: CFM requirements shown above are for **Open By-Pass** hoods. The CFM requirements for a **Restricted By-Pass** hood with the sash fully open is the same as above. The by-pass opening with the sash closed is 20% of that with the sash fully open.

Accessories Include: Two 120 volt AC 20 amp GFI receptacles, single-tube, T-5 fluorescent light fixture with bulb and 20 amp light switch. **No wiring for the electrical fixtures is included unless H-Option is selected.**

Optional Accessories: Each front post and interior end liner is punched for up to five (5) remote control service fittings. The right hand post is punched for a second electrical fixture at the top which may be used for a fan switch or other electrical device. **Service fittings, fan, fan switch, work top, cupsink, and base units must be ordered separately.**

Split Sash Bench Fume Hoods — Vertical Rising Sash with Disappearing Center Post

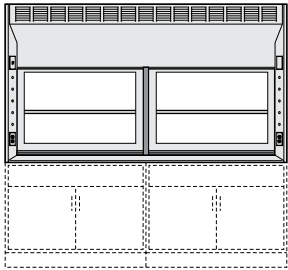
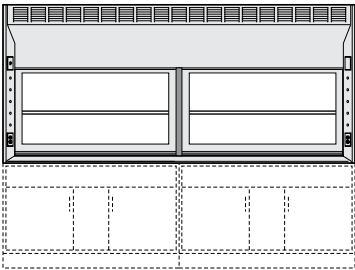
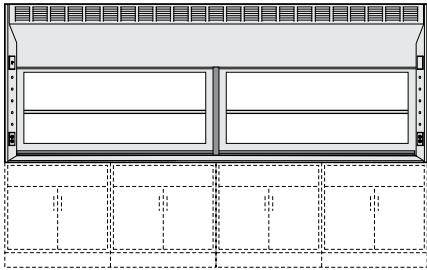
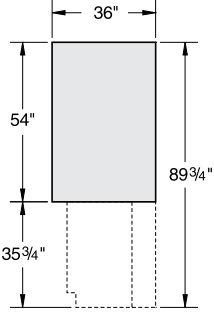
8'-0"	10'-0"	12'-0"	
			
H10_5496-00 Open By-Pass	H10_5420-00 Open By-Pass	H10_5444-00 Open By-Pass	End View
H10_5496B00 Restricted By-Pass	H10_5420B00 Restricted By-Pass	H10_5444B00 Restricted By-Pass	

Auxiliary Air

All Open By-Pass hoods can be Auxiliary Air hoods by adding an Auxiliary Air Chamber. See page 43 for catalog numbers.

Note: See page 44 for chart of available options.

Note: Open By-Pass Fume Hood shown. Restricted By-Pass Fume Hoods do not have louvered top front panel.

Isotope Bench Fume Hood

with Vertical Rising Sash

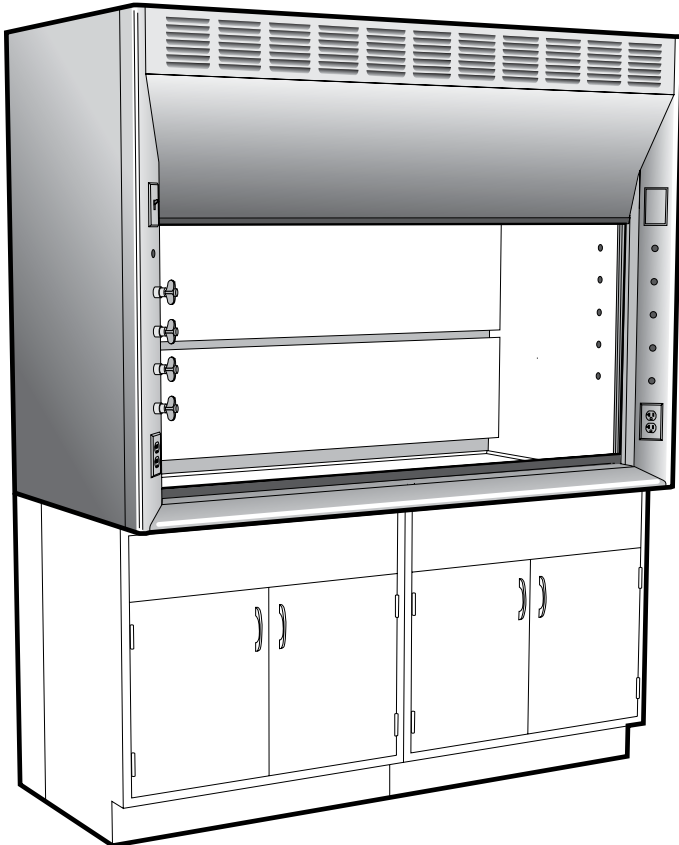

Available Option:

Adjustable Baffles
Air Flow and Static Pressure Alarms
Service Fittings and Piping
Electrical Fixtures and Wiring
UL listed when pre-wired per UL 61010A-1
Vapor Proof and Explosion Proof Lighting
Stainless Steel Deflector Vane
Alternate Sash Handles
Sash Frame
Tempered Sash Glass
Tissue Screen
Sash Stop

Available Models:
Open By-Pass
Restricted By-Pass
Auxiliary Air

Features:

- Coved cornered, seamless welded stainless steel construction for easy cleaning and decontamination.
- Complete with integral work top and hemispherical cupsink.
- Radiused corner posts and airfoils for smooth air movement assures high level of comfort, safety and efficiency.
- 4" thick endwalls provide more interior work space and clean-lined uncluttered design.
- Interior baffles designed to minimize turbulence and optimize containment.
- Frameless sash with full-length formed steel handle for neat, clean appearance and streamline air features.
- Low profile PVC sash tracks and exclusive sash leveling and alignment features assure easy-smooth sash operation
- Heavy gauge cold rolled steel exterior panels with independent rigid structural frame.
- Designed and tested using ASHRAE 110-1995, BS 7258, and DIN 12 924 standards.

Supreme Air Fume Hood

H2O

Specifications:

Supreme Air Isotope Bench Fume Hoods are furnished with a type 304 stainless steel liner and baffles with upper, center, and lower exhaust slots. Each fume hood is complete with a lower deflector vane, counterbalanced, frameless sash of

1/4" combination safety glass, dished work top, and 5" diameter cupsink. Hood exteriors are fabricated of cold rolled steel, phosphate coated with a baked chemical resistant, synthetic resin finish. The exhaust duct collar is stainless steel, 11¹⁵/₁₆" O.D. (8 foot

hoods are furnished with two duct collars.) Supreme Air Isotope Hoods are available with either an Open By-Pass or a Restricted By-Pass for VAV use. An auxiliary air chamber is available for use on the Open By-Pass hood.

Additional Parts Required to Make Up a Complete Fume Hood Assembly

Base Cabinets see page 63
Service Fittings see page 56
Fan/Blower see page 82

DIMENSIONS	HEIGHT	LENGTH				DEPTH
Overall Dimension	89 3/4" **	48"	60"	72"	96"	36"
Sash Opening	28" *	40"	52"	64"	88"	...
Work Top	37" **	40"	52"	64"	88"	25 1/2"
Clearance (sash up)	97" **

* Sash opening height above airfoil. Add 1" in height to calculate sash opening area.
 ** Subtract 1" in height if wood base cabinets are used.

Overall Hood Length	Sash Opening Sq. Ft.	Total CFM and Static Pressure					
		80 FPM	S.P.	100 FPM	S.P.	120 FPM	S.P.
4'-0" / 48"	8.1	not recommended		810	0.25"	980	0.35"
5'-0" / 60"	10.5	not recommended		1050	0.30"	1260	0.45"
6'-0" / 72"	12.9	not recommended		1290	0.40"	1550	0.60"
8'-0" / 96"	17.7	not recommended		1770	0.25"	2130	0.35"

Static pressures shown are for the pressure drop through the hoods only. The total pressure drop through the hood and the duct system must be calculated to select the proper exhaust fan.

Note: CFM requirements shown above are for **Open By-Pass** hoods. The CFM requirements for a **Restricted By-Pass** hood with the sash fully open is the same as above. The by-pass opening with the sash closed is 20% of that with the sash fully open.

Accessories Include: Two 120 volt AC 20 amp GFI receptacles, single-tube, T-5 fluorescent light fixture with bulb and 20 amp light switch. **No wiring for the electrical fixtures is included unless H-Option is selected.**

Optional Accessories: Each front post and interior end liner is punched for up to five (5) front loading remote control service fittings. The right hand post is punched for a second electrical fixture at the top which may be used for a fan switch or other electrical device. **Service fittings, fan, fan switch, and base units must be ordered separately.**

Isotope Bench Fume Hoods — Vertical Rising Sash

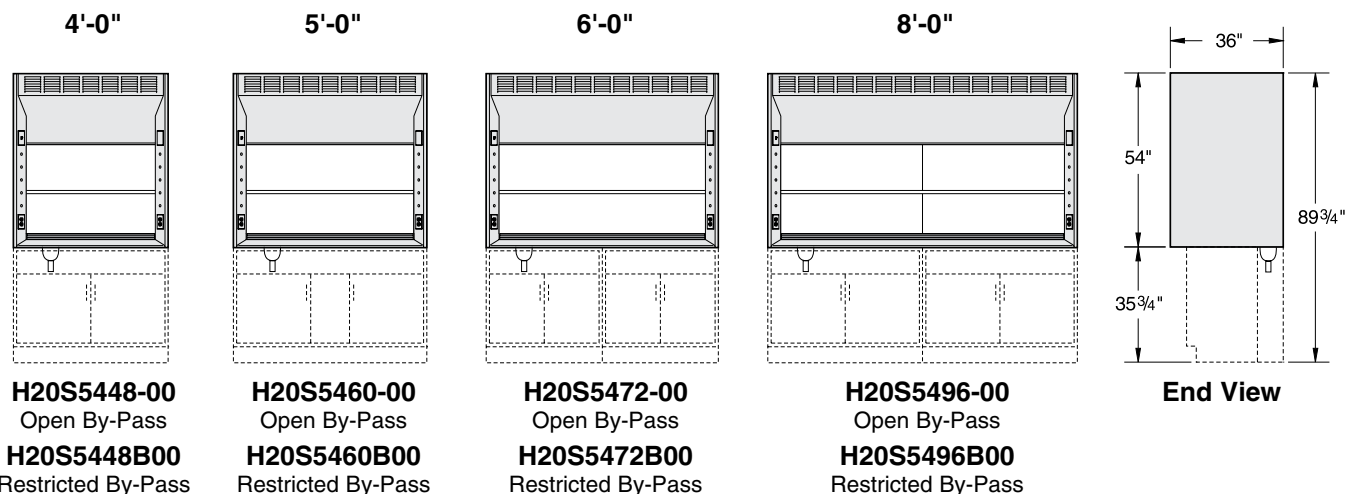

Auxiliary Air

All Open By-Pass hoods can be Auxiliary Air hoods by adding an Auxiliary Air Chamber. See page 43 for catalog numbers.

Note: See page 44 for chart of available options.

Note: Open By-Pass Fume Hood shown. Restricted By-Pass Fume Hoods do not have louvered top front panel.

Perchloric Acid Bench Fume Hood

with Vertical Rising Sash

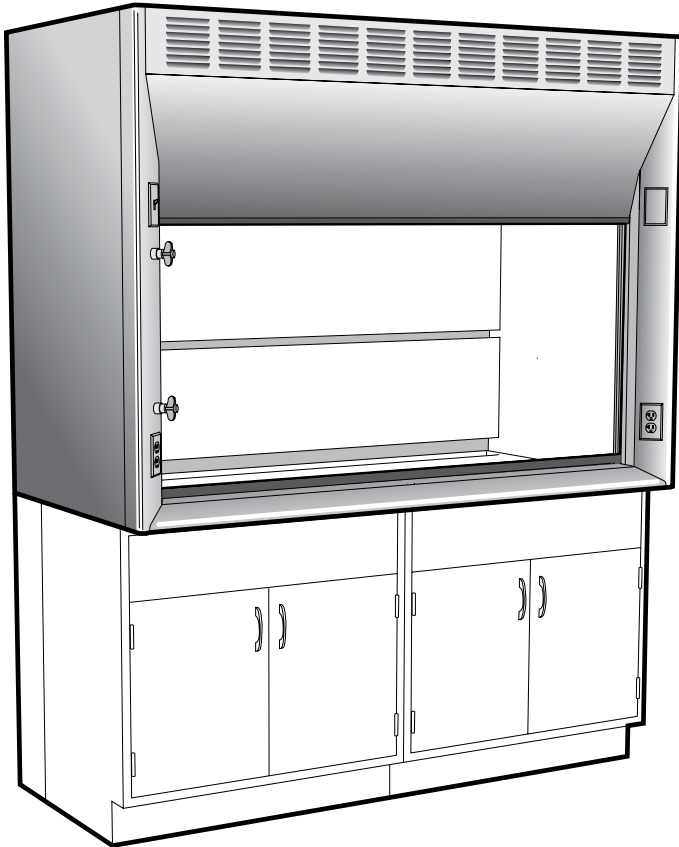

Available Models:
Open By-Pass
Auxiliary Air

Features:

- Coved cornered, seamless welded type 316 stainless steel construction for easy cleaning and decontamination.
- Complete with integral work top drain trough, cold water service fitting, and cold water hood washdown.
- Radiused corner posts and airfoils for smooth air movement assures high level of comfort, safety and efficiency.
- 4" thick endwalls provide more interior work space and clean-lined uncluttered design.
- Interior baffles designed to minimize turbulence and optimize containment.
- Frameless sash with full-length formed steel handle for neat, clean appearance and streamline air features.
- Low profile PVC sash tracks and exclusive sash leveling and alignment features assure easy-smooth sash operation
- Heavy gauge cold rolled steel exterior panels with independent rigid structural frame.
- Designed and tested using ASHRAE 110-1995, BS 7258, and DIN 12 924 standards.

Available Option:

Adjustable Baffles
Air Flow and Static Pressure Alarms
Service Fittings and Piping
Electrical Fixtures and Wiring
UL listed when pre-wired per UL 61010A-1
Explosion Proof Lighting
Stainless Steel Deflector Vane
Sash Frame
Tempered Sash Glass
Sash Stop

Supreme Air Fume Hood

H25

Specifications:

Supreme Air Perchloric Acid Bench Fume Hoods are furnished with a stainless steel liner and baffles with upper, center, and lower exhaust slots. Each fume hood is complete with a lower deflector vane, counter balanced, frameless sash of 1/4"

combination safety glass, and a louvered top front panel. A full length perforated spray pipe is located behind the top baffle, and is provided to simplify periodic washdown procedures. Hood exteriors are fabricated of cold rolled steel,

phosphate coated with a baked chemical resistant, synthetic resin finish. The exhaust duct collar is st. steel, 11¹⁵/₁₆" O.D. Perchloric Acid Hoods are available only with an Open By-Pass. An auxiliary air chamber is available.

Additional Parts Required to Make Up a Complete Fume Hood Assembly

Base Cabinets * see page 63
Fan/Blower see page 82

* Only steel base cabinets are recommended for use under perchloric acid fume hoods.

DIMENSIONS	HEIGHT	LENGTH		DEPTH
Overall Dimension	89 3/4"	48"	60" 72"	36"
Sash Opening	28" *	40"	52" 64"	...
Work Top	37"	40"	52" 64"	25 1/2"
Clearance (sash up)	97"

* Sash opening height above airfoil. Add 1" in height to calculate sash opening area. Wood base cabinets are not recommended for use under perchloric acid fume hoods.

Overall Hood Length	Sash Opening Sq. Ft.	Total CFM and Static Pressure					
		80 FPM	S.P.	100 FPM	S.P.	120 FPM	S.P.
4'-0" / 48"	8.1	not recommended		not recommended		980	0.35"
5'-0" / 60"	10.5	not recommended		not recommended		1260	0.45"
6'-0" / 72"	12.9	not recommended		not recommended		1550	0.60"

Static pressures shown are for the pressure drop through the hoods only. The total pressure drop through the hood and the duct system must be calculated to select the proper exhaust fan.

Note: Due to the use of hot plates in perchloric acid hoods, Kewaunee recommends using a minimum of 120 FPM face velocity.

Accessories Include: Two front loaded remote controlled service fittings (one cold water, one cold water washdown), Two 120 volt AC 20 amp GFI receptacles, vapor-proof light fixture(s) (bulbs not included) with 20 amp light switch. **No wiring for the electrical fixtures is included unless H-Option is selected.**

Optional Accessories: The right hand post is punched for a second electrical fixture at the top which may be used for a fan switch or other electrical device. **Fan, fan switch, and base units must be ordered separately.**

Stainless Steel Lining

Interior Perchloric Acid fume hood 14 gauge linings and 16 gauge baffles are type 316 stainless steel. The seamless welded 14 gauge, type 316 stainless steel work top is dished 1/2" to retain spillage, and has an integrally welded trough sink at the rear.

Note: acid storage or vacuum pump storage cabinets can not be vented through perchloric acid fume hood work tops.

Perchloric Acid Bench Fume Hoods — Vertical Rising Sash

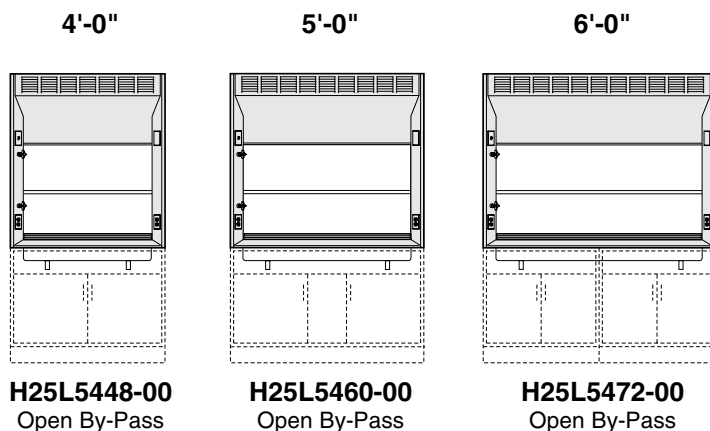

H25L5448-00
Open By-Pass

H25L5460-00
Open By-Pass

H25L5472-00
Open By-Pass

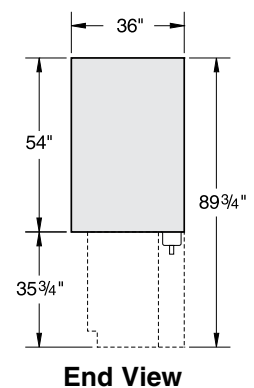

End View

Auxiliary Air

All Open By-Pass hoods can be Auxiliary Air hoods by adding an Auxiliary Air Chamber. See page 43 for catalog numbers.

Note: See page 44 for chart of available options.

Horizontal Sash – Bench Fume Hood

with Four Panel Horizontal Sash

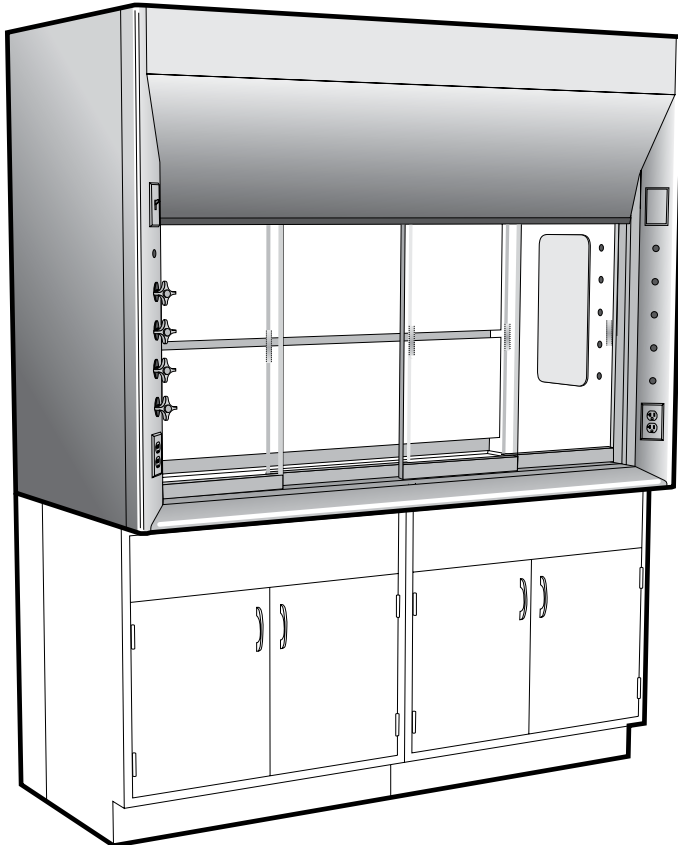

Available Models: Restricted By-Pass

Available Option:

Adjustable Baffles
Air Flow and Static Pressure Alarms
Service Fittings and Piping
Electrical Fixtures and Wiring
UL listed when pre-wired per UL 61010A-1
1805 UL classified with Kemglass
or Stainless Steel liner
Vapor Proof and Explosion Proof Lighting
Stainless Steel Deflector Vane
Sash Frame
Tempered Sash Glass
Tissue Screen
Fire Extinguisher
Distillation Rack
Sash Stop
Stainless Steel Duct Collar

Features:

- Radiused corner posts and airfoils for smooth air movement assures high level of comfort, safety and efficiency.
- 4" thick endwalls provide more interior work space and clean-lined uncluttered design.
- Interior baffles designed to minimize turbulence and optimize containment.
- Frameless, four-panel, two-track, horizontal sash with 1/4" laminated safety glass for neat, clean appearance and streamline air features.
- Large friction-fit interior access panels provide easy access to piping and service fittings.
- Heavy gauge cold rolled steel exterior panels with independent rigid structural frame.
- Designed and tested using ASHRAE 110-1995, BS 7258, and DIN 12 924 standards.

Supreme Air Fume Hood

H70

Specifications:

Supreme Air Horizontal Sash Bench Fume Hoods are furnished with a choice of liner and baffles with upper, center, and lower exhaust slots. Each fume hood is complete with a lower deflector vane, four-panel, frameless

sash of 1/4" combination safety glass and interior plumbing access panels. Hood exteriors are fabricated of cold rolled steel, phosphate coated with a baked chemical resistant, synthetic resin finish. The exhaust duct collar

is polyethylene, 11¹⁵/₁₆" O.D. (8 foot hoods are furnished with two duct collars.) Supreme Air Bench Hoods are available only as a Restricted By-Pass hood. They may be used either with or without a VAV system.

Additional Parts Required to Make Up a Complete Fume Hood Assembly

Work Top	see page 49
Base Cabinets	see page 63
Service Fittings	see page 54
Cupsink	see page 53
Fan/Blower	see page 82

DIMENSIONS	HEIGHT	LENGTH				DEPTH
Overall Dimension	89 3/4" **	48"	60"	72"	96"	36"
Sash Opening	29" *	18 1/2"	24 1/2"	30 1/2"	42 1/2"	...
Work Top	37" **	40"	52"	64"	88"	25 1/2"
Clearance (sash up)	89 3/4" **

* Sash opening height above airfoil. Add 1" in height to calculate sash opening area.
** Subtract 1" in height if wood base cabinets are used.

Liner Options:

- T** = Phenolic Resin
- G** = Kemglass
Fiberglass reinforced polyester
- S** = Type 304 Stainless Steel

The blank left in the fume hood catalog numbers is for designating the desired lining.

Example: H70T5448-00 would designate a 4' hood with a Phenolic Resin lining.

Overall Hood Length	Sash Opening Sq. Ft. *	Total CFM and Static Pressure					
		80 FPM	S.P.	100 FPM	S.P.	120 FPM	S.P.
4'-0" / 48"	5.2	410	0.10"	520	0.10"	620	0.15"
5'-0" / 60"	6.8	550	0.10"	680	0.15"	820	0.20"
6'-0" / 72"	8.5	680	0.15"	850	0.20"	1020	0.25"
8'-0" / 96"	11.8	940	0.10"	1180	0.15"	1410	0.15"

* At maximum sash opening. Includes By-Pass opening and 1" below deflector vane.

Static pressures shown are for the pressure drop through the hoods only. The total pressure drop through the hood and the duct system must be calculated to select the proper exhaust fan.

Accessories Include: Two 120 volt AC 20 amp GFI receptacles, single-tube, T-5 fluorescent light fixture with bulb and 20 amp light switch. **No wiring for the electrical fixtures is included unless H-Option is selected.**

Optional Accessories: Each front post and interior end liner is punched for up to five (5) remote control service fittings. The right hand post is punched for a second electrical fixture at the top which may be used for a fan switch or other electrical device. **Service fittings, fan, fan switch, work top, cupsink, and base units must be ordered separately.**

Horizontal Sash Bench Fume Hoods — Four Panel Horizontal Sash

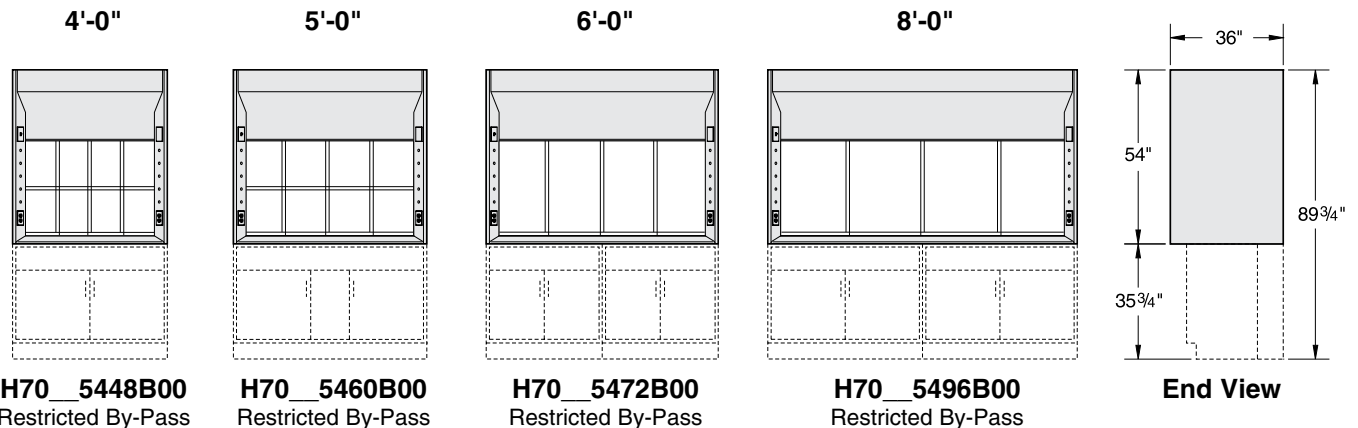

Note: See page 44 for chart of available options.

HOPEC Style Bench Fume Hood

with Combination Vertical Rising/Horizontal Sash

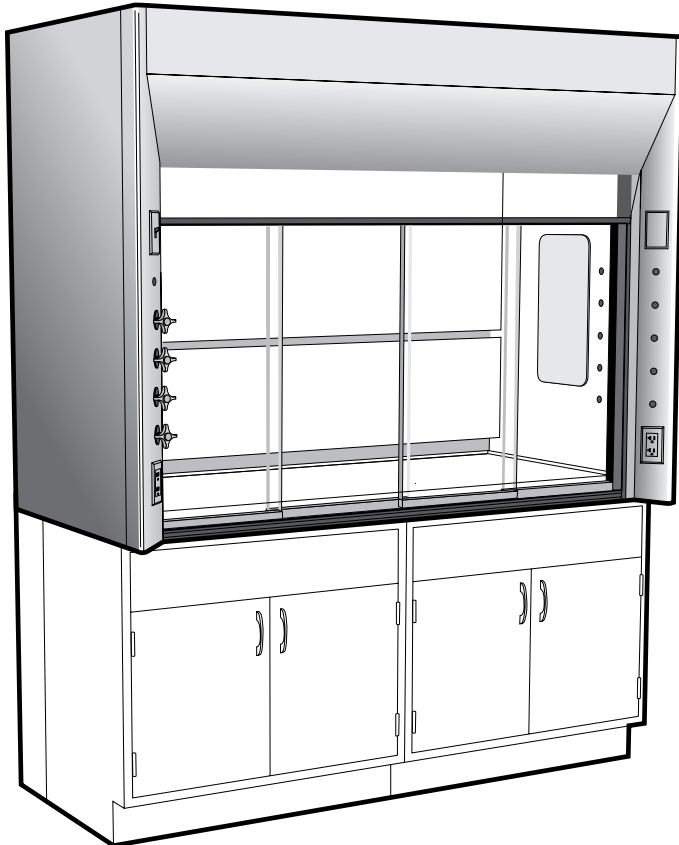

Available Models: Restricted By-Pass

Available Options:

- Adjustable Baffles
- Air Flow and Static Pressure Alarms
- Service Fittings and Piping
- Electrical Fixtures and Wiring
- UL listed when pre-wired per UL 61010A-1
- 1805 UL classified with Kemglass or Stainless Steel liner
- Vapor Proof and Explosion Proof Lighting
- Stainless Steel Sash Frame
- Tempered Sash Glass
- Tissue Screen
- Fire Extinguisher
- Distillation Rack
- Sash Stops
- Stainless Steel Duct Collar

Features:

- Flush bottom airfoil with integral spill trough—painted stainless steel.
- Transparent Vision Panel standard, for increased hood interior visibility.
- Radiused corner posts and airfoils for smooth air movement assures high level of comfort, safety and efficiency.
- 4" thick endwalls provide more interior work space and clean-lined uncluttered design.
- Interior baffles designed to minimize turbulence and optimize containment.
- Narrow framed sash with four horizontal glass panels on two tracks for neat clean appearance and improved exhaust efficiency.
- Low profile PVC sash tracks and exclusive sash leveling and alignment features assure easy-smooth sash operation
- Large friction-fit interior access panels provide easy access to piping and service fittings.
- Heavy gauge cold rolled steel exterior panels with independent rigid structural frame.
- Designed and tested using ASHRAE 110-1995, BS 7258, and DIN 12 924 standards.

Supreme Air Fume Hood

HOP

Specifications:

HOPEC Style Supreme Air Bench Fume Hoods are furnished with a choice of liner and baffles with upper, center, and lower exhaust slots. Each fume hood is complete with a flush lower airfoil with integral spill trough, counterbalanced, narrow framed sash with 1/4" combination safety glass horizontal panels, vision panel

and interior plumbing access panels. Hood exteriors are fabricated of cold rolled steel, phosphate coated with a baked chemical resistant, synthetic resin finish. The exhaust duct collar is polyethylene, 11¹⁵/₁₆" O.D. (8 foot hoods are furnished with two duct collars.)

HOPEC Bench Hoods are available only with a Restricted By-Pass to match the restricted sash opening. They are designed for use with both constant volume and VAV applications. HOPEC Bench Hoods are not designed for use with Auxiliary Air Chambers.

Additional Parts Required to Make Up a Complete Fume Hood Assembly

Work Top	see page 49
Base Cabinets	see page 63
Service Fittings	see page 54
Cupsink	see page 53
Fan/Blower	see page 82

Liner Options:

- T** = Phenolic Resin
- G** = Kemglass
Fiberglass reinforced polyester
- S** = Type 304 Stainless Steel

The blank left in the fume hood catalog numbers is for designating the desired lining.

Example: HOP5448-00 would designate a 4' hood with a Phenolic Resin lining.

DIMENSIONS	HEIGHT	LENGTH				DEPTH
Overall Dimension	88 3/4"	48"	60"	72"	96"	36"
Sash Opening	29"	40"	52"	64"	88"	...
Work Top	36"	40"	52"	64"	88"	25 1/2"
Clearance (sash up)	97"

Overall Hood Length	Sash Opening Sq. Ft. *	Total CFM and Static Pressure					
		80 FPM	S.P.	100 FPM	S.P.	120 FPM	S.P.
4'-0" / 48"	4.0	320	0.05"	400	0.05"	490	0.10"
5'-0" / 60"	5.4	430	0.05"	540	0.10"	650	0.15"
6'-0" / 72"	6.8	540	0.10"	680	0.15"	820	0.20"
8'-0" / 96"	9.5	760	0.05"	950	0.10"	1150	0.10"

* Maximum sash opening with vertical sash down and horizontal panels fully open. Includes By-Pass opening and 1" below deflector vane.

Static pressures shown are for the pressure drop through the hoods only. The total pressure drop through the hood and the duct system must be calculated to select the proper exhaust fan.

Accessories Include: Two 120 volt AC 20 amp GFI receptacles, single-tube, T-5 fluorescent light fixture with bulb and 20 amp light switch. **No wiring for the electrical fixtures is included unless H-Option is selected.**

Optional Accessories: Each front post and interior end liner is punched for up to five (5) remote control service fittings. The right hand post is punched for a second electrical fixture at the top which may be used for a fan switch or other electrical device. **Service fittings, fan, fan switch, work top, cupsink, and base units must be ordered separately.**

HOPEC Bench Fume Hoods — Combination Vertical Rising/Horizontal Sash

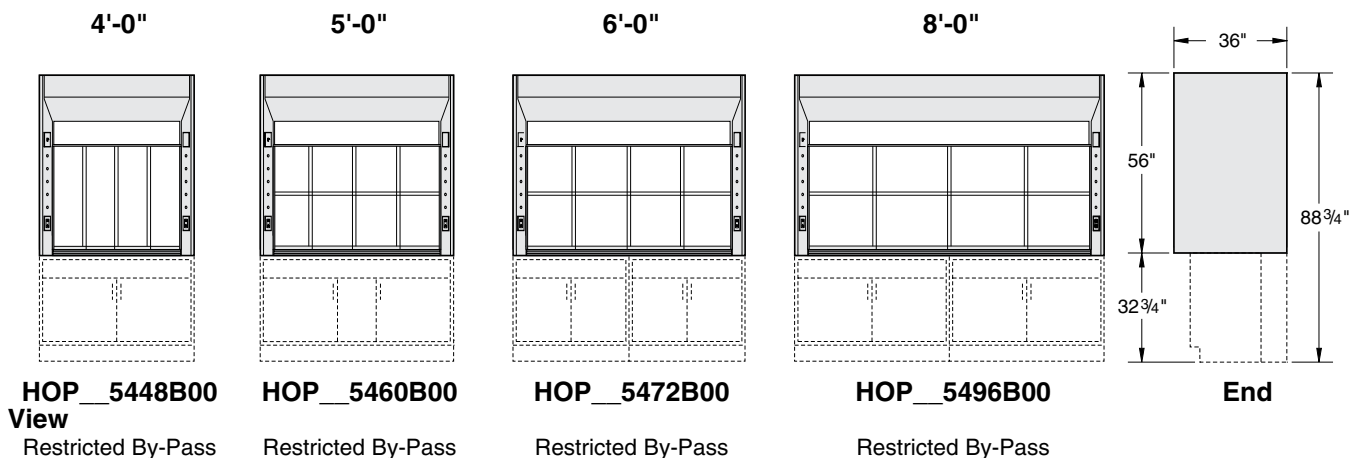

Note: See page 44 for chart of available options.