

HIGH PERFORMANCE
Super Night Vision Camera
OPERATION MANUAL



Thank you for choosing our high quality camera. Before attempting to connect operate this unit, please read and follow these instructions.

HIGH PERFORMANCE
Super Night Vision Camera
OPERATION MANUAL



Thank you for choosing our high quality camera. Before attempting to connect operate this unit, please read and follow these instructions.

CAUTION

These servicing instructions are for use by qualified service personnel only. To reduce the risk of electric shock do not perform any servicing other than that contained in the operating instructions unless you are qualified to do so.

In USA and Canada, Use Class 2 Power Supply Only

CONTENTS

1. CAUTIONS
2. IMPORTANT SAFETY INSTRUCTIONS
3. FEATURES
4. COMPONENTS
5. NAME AND FUNCTION
6. INSTALLATION
7. DIMENSIONS
8. SPECIFICATION
9. OSD MANUAL
10. COMMUNICATION PROTOCOL

1. CAUTIONS

This device complies with Part 15 of the FCC Rules. Operation is subject to the following two conditions;

1. This device may not cause harmful interference.
2. This device must accept any interference received, including interference that may cause undesired operation.

Note

This equipment has been tested and found to comply with the limits for a Class A digital device, pursuant to part 15 of the FCC Rules. These limits are designed to provide reasonable protection against harmful interference when the equipment is operated in a commercial environment. This equipment generates, uses, and can radiate radio frequency energy and, if not installed and used in accordance with the instruction manual, may cause harmful interference to radio communications. Operation of this equipment in a residential area is likely to cause harmful interference in which case the user will be required to correct the interference at his own expense."

WARNING

This is a class A product. In a domestic environment this product may cause radio interference in which case the user may be required to take adequate measures.

Caution

Any changes or modifications in construction of this device which are not expressly approved by the party responsible for compliance could void the user's authority to operate the equipment.

CAUTION

1. A regulated DC12V 1A power supply is recommended for use with this camera for the best picture and the most stable operation.
An unregulated power supply can cause damage to the camera.
When unregulated power supply is applied, product warranty will be out of subject.
2. It is recommended that the camera is used with a monitor that has a CCTV quality 75 video impedance level.
If your monitor is switched to high impedance then please adjust accordingly.
3. Do not attempt to disassemble the camera to gain access to the internal componets. Refer servicing to your dealer.
4. Never face the camera towards the sun or any bright or reflective light, which may cause smear on the picture and possible damage to the CCD.
5. **Do not remove the serial sticker for the warranty service.**

1. CAUTIONS



Correct Disposal of This Product (Waste Electrical & Electronic Equipment)

(Applicable in the European Union and other European countries with separate collection systems)

This marking shown on the product or its literature, indicate that it should not be disposed with other household wastes at the end of its working life. To prevent possible harm to the environment or human health from uncontrolled waste disposal, please separate this from other types of wastes and recycle it responsibly to promote the sustainable reuse of material resources.

This product should not be mixed with other commercial wastes purchased this product, or their local government office, for details of where and how they can take item for environmentally safe recycling.

Business users should contact their supplier and check the terms and conditions of the purchase contract.

Household users should contact either the retailer where they for disposal.

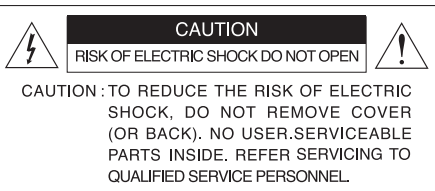

This symbol is intended to alert the user to the presence of uninsulated “dangerous voltage” within the product’s enclosure that may be of sufficient magnitude to constitute a risk of electric shock to persons.



This symbol is intended to alert the user to the presence of important operating and maintenance(servicing) instructions in the literature accompanying the appliance

2. IMPORTANT SAFETY INSTRUCTION





- 1) Read these instructions.
- 2) Keep these instructions.
- 3) Heed all warnings.
- 4) Follow all instructions.
- 5) Do not use this apparatus near water.
- 6) Clean only with dry cloth.
- 7) Do not block any ventilation openings. Install in accordance with the manufacturer's instructions.
- 8) Do not install near any heat sources such as radiators, heat registers, stoves, or other apparatus (including amplifiers) that produce heat.
- 9) Do not defeat the safety purpose of the polarized or grounding-type plug. A polarized plug has two blades with one wider than the other. A grounding type plug has two blades and a third grounding prong. The wide blade or the third prong are provided for your safety. If the provided plug does not fit into your outlet, consult an electrician for replacement of the obsolete outlet.
- 10) Protect the power cord from being walked on or pinched particularly at plugs, convenience receptacles, and the point where they exit from the apparatus.
- 11) Only use attachments/accessories specified by the manufacturer.
- 12) Use only with the cart, stand, tripod, bracket, or table specified by the manufacturer, or sold with the apparatus. When a cart is used, use caution when moving the cart/apparatus combination to avoid injury from tip-over.
- 13) Unplug this apparatus during lightning storms or when unused for long periods of time.
- 14) Refer all servicing to qualified service personnel. Servicing is required when the apparatus has been damaged in any way, such as power-supply cord or plug is damaged, liquid has been spilled or objects have fallen into the apparatus, the apparatus has been exposed to rain or moisture, does not operate normally, or has been dropped.

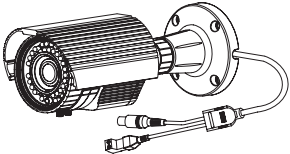

3. FEATURES

- 1/3" 960H SONY EXview HAD CCD II
- High Resolution of 700TV Lines
- OSD Function
- Multi Language
(ENGLISH, CHINESE, RUSSIAN, SPANISH, GERMAN, FRENCH, PORTUGUESE, JAPANESE)
- 2DNR
- Privacy Zone / Motion Detect
- Smart IR
- DC12V / AC24V Dual Voltage
- ATR(Adaptive Tone-curve Reproduction / Digital WDR)
The function provides gradation compensation to improve the contrast of subjects both low-luminance areas and high luminance areas exist in the same picture

4. COMPONENTS

SUPER NIGHT VISION CAMERA	
VIDEO OUTPUT TEST CABLE	
L-WRENCH / SCREW - 4ea	
OPERATION MANUAL	

5. NAME AND FUNCTION

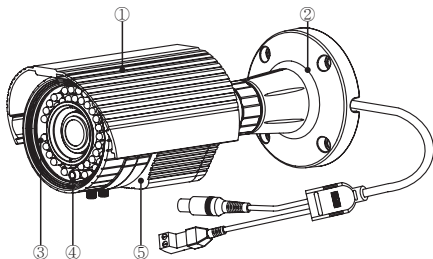

• Service Video connector & OSD Joystick

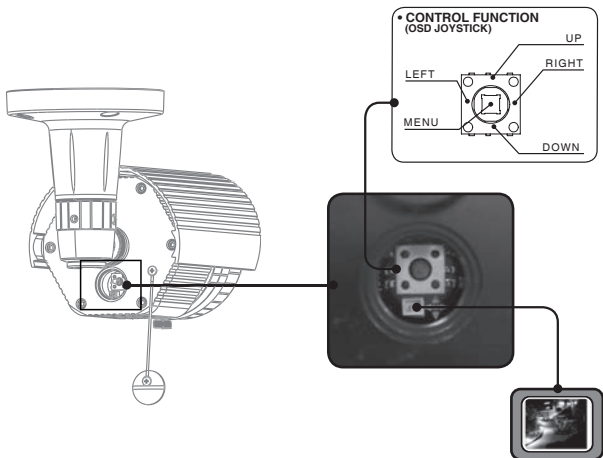

5. NAME AND FUNCTION

- Heater

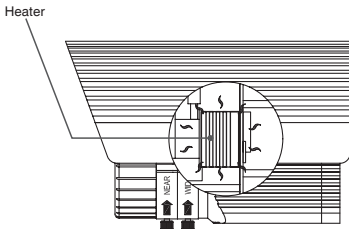

Built in heater protects the camera from low temperature.
(Operating temperature with Heater:-40°C)

- External Zoom & Focus Adjustable

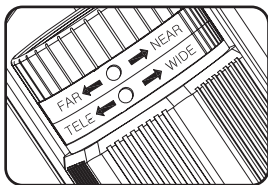
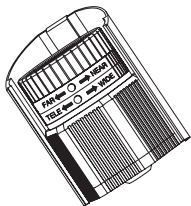

External Zoom & Focus Adjustable

6. INSTALLATION

• MOUNTING POSITION

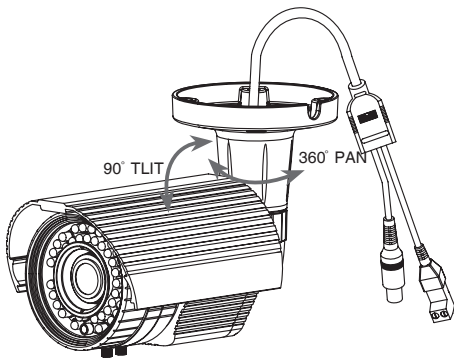
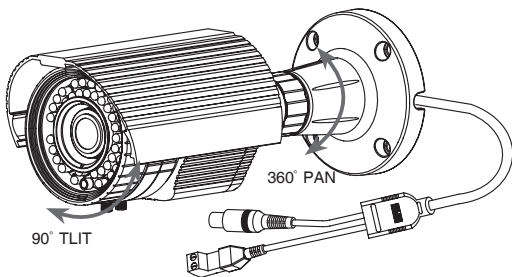

6. INSTALLATION

• MONITOR CONNECTION

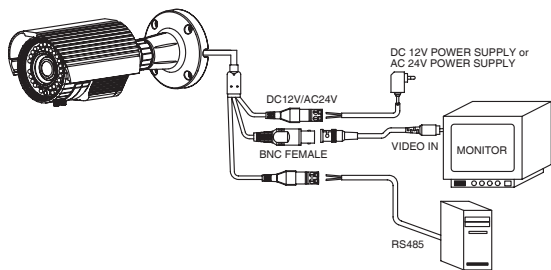
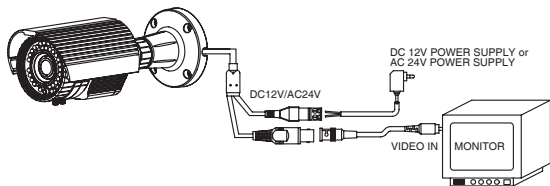

When you install the camera, please glue up the end of cable to keep it stable in order to protect the camera from the humidity problems.

7. DIMENSIONS

Unit : mm

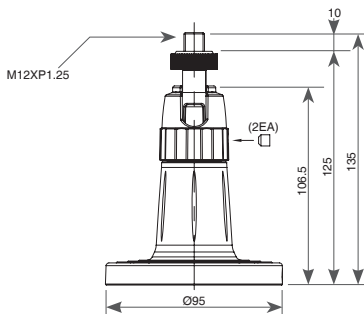
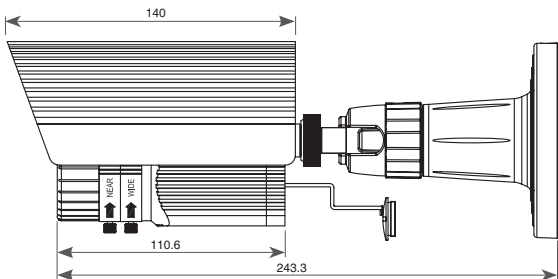
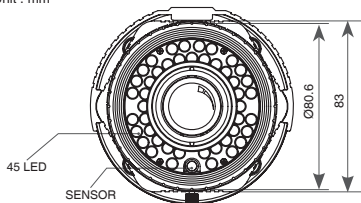

8. SPECIFICATION

Signal Format	NTSC	PAL
Image Device	1/3"~960H SONY EXview HAD CCD II	
Scanning System	2 : 1 Interlace	
Scanning Frequency	15.734KHz(H), 59.94Hz(V)	15.625KHz(H), 50Hz(V)
Total Pixels	1020(H) X 508(V)	1020(H) X 596(V)
Effective Pixels	976(H) X 494(V)	976(H) X 582(V)
Electronic Shutter Speed	1/60 sec	1/50 sec
H.Resolution	750TV Lines	
S/N Ratio	More than 50dB(AGC OFF)	
Min.Illumination	LED On : 0 Lux	
Sync System	Internal	
Gamma	$\gamma = 0.45$	
Video Output Level	1.0 Vp-p Composite(75 Ω)	
OSD	Built in (Joystick)	
BLC	OFF / BLC / HLC	
2DNR	OFF/ON(Level adjustable)	
ATR	OFF/ON(Level adjustable)	
SMART IR	On / Off	
White Balance	ATW / PUSH / MANUAL / PUSH-LOCK	
Privacy Masking	4 Zones	
Motion Detection	4 Zones	
Day & Night(ICR)	AUTO / Color / BW	
Language	ENGLISH, CHINESE, RUSSIAN, SPANISH, GERMAN, FRENCH, PORTUGUESE, JAPANESE	
IP Rating	IP67 (Water proof)	
IR LED	850nm, 45ea	
IR LED Distance	Up to 50M	
Operating Temperature	14°F~122°F(-10°C~+50°C) / Heater On: -40°F~122°F(-40°C~+50°C)	
Storage Temperature	-4°F~140°F(-20°C~+60°C)	
Humidity	Less than 80%	
Power Consumption	DC12V ($\pm 10\%$) Max.850mA, 1.1A(Heater On) AC24V ($\pm 10\%$) Max.10W, 21W(Heater On)	
Lens	Varifocal Lens	
Dimension	98.6(W) x 83(H) x 110.6(D)	
Weight	Approx. 900g	
Option	RS-485, Heater	

Specifications and designs are subject to change for improving the functionality of this product without notice.

9. OSD MANUAL

GENERAL STRUCTURE

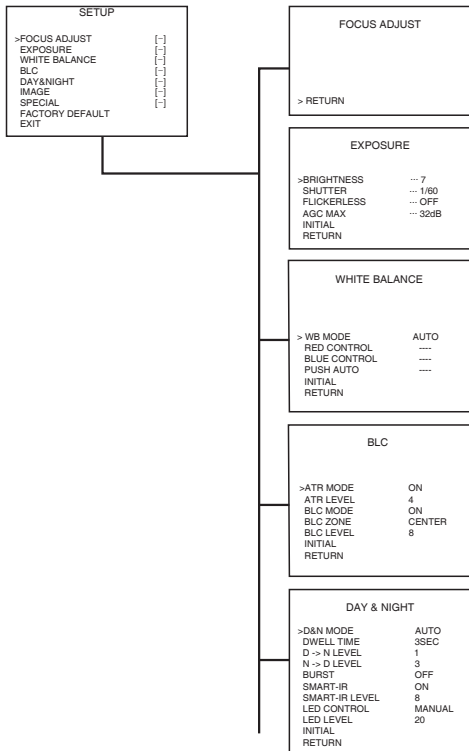

9. OSD MANUAL

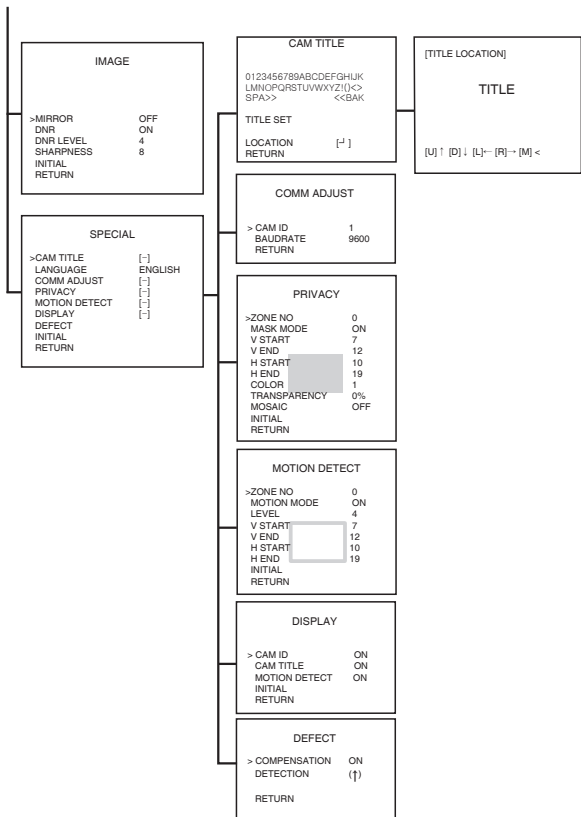

9. OSD MANUAL

MAIN MENU	Sub Menu	Sub MENU
SETUP		
FOCUS ADJUST	RETURN	
EXPOSURE	BRIGHTNESS	0-15
	SHUTTER	1/60(50), 1/120(100), 1/250, 1/500, 1/1k, 1/2k, 1/4k, 1/6k, 1/10k, 1/50k, 1/100k
	FLICKERLESS	OFF, ON
	AGC MAX	6dB, 9dB, 12dB, 15dB, 18dB, 21dB, 24dB, 27dB, 30dB, 33dB, 36dB, 39dB, 42dB
	INITIAL	
	RETURN	
WHITE BALANCE	WB MODE	ATW, PUSH, PUSH LOCK, MANUAL
	RED CONTROL	0 - 255
	BLUE CONTROL	0 - 255
	PUSH AUTO	-
	INITIAL	
	RETURN	
BLC	ATR MODE	OFF, ON
	ATR LEVEL	0 - 4
	BLC MODE	OFF, ON, HLC
	BLC ZONE	TOP, BOTTOM, CENTER, LEFT, BIGHT
	BLC LEVEL	0 - 15
	INITIAL	
	RETURN	
DAY&NIGHT	D&N MODE	COLOR, B/W, AUTO
	DWELL TIME	0 - 10
	D -> N LEVEL	0 - 19
	N -> D LEVEL	1 - 20
	BURST	OFF, ON
	SAMRT-IR	OFF, ON
	SMART-IR LEVEL	0 - 15
	LED CONTROL	MANUAL, AUTO
	LED LEVEL	0 - 20
	INITIAL	
	RETURN	
IMAGE	MIRROR	OFF, ON
	DNR	OFF, ON
	DNR LEVEL	0 - 15
	SHARPNESS	0 - 15
	INITIAL	
	RETURN	
SPECIAL	CAM TITLE	CAM TITLE
		0 1 2 3 4 5 6 7 8 9 A B C D E F G H I J K
		L M O P Q R S T U V W X Y Z I - () < >
		SPA>> <<BAK
		LOCATION
	RETURN	

9. OSD MANUAL

MAIN MENU	Sub Menu	Sub MENU		
SPECIAL	LANGUAGE	ENGLISH, CHINESE, RUSSIAN, SPANISH, GERMAN, FRENCH, PORTUGUESE, JAPANESE		
	COMM ADJUST	CAM ID	0 - 255	
		BAUDRATE	2400, 4800, 9600, 19200	
		RETURN		
	PRIVACY	ZONE NO	0 - 3	
		MASK MODE	OFF, ON	
		V START	0 - 17	
		V END	1 - 18	
		H START	0 - 29	
		H END	1 - 30	
		COLOR	0 - 7	
		TRANSPARENCY	0%, 25%, 50%	
		MOSAIC	OFF, ON	
		INITIAL		
	RETURN			
	MOTION DETECT	ZONE NO	0 - 3	
		MOTION MODE	OFF, ON	
		LEVEL	0 - 15	
		V START	0 - 6	
		V END	1 - 7	
		H START	0 - 10	
		H END	1 - 11	
		INITIAL		
	RETURN			
	DISPLAY	CAM ID	OFF, ON	
		CAM TITLE	OFF, ON	
		MOTION DETECT	OFF, ON	
		INITIAL		
		RETURN		
	DEFECT	COMPENSATION	OFF, ON	
		DETECTION		
		RETURN		
INITIAL				
RETURN				
FACTORY DEFAULT				
EXT				

9. OSD MANUAL

OSD FUNCTION DESCRIPTION

1. FOCUS ADJUST

: According to the brightness of light to minimize the depth of focus, to be more accurate to focus.

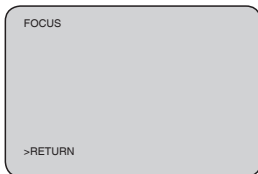

2. EXPOSURE

: Enable user to set up the function of BRIGHTNESS, SHUTTER, FLICKERLESS, AGC. Set up using LEFT, RIGHT KEY at each menu.

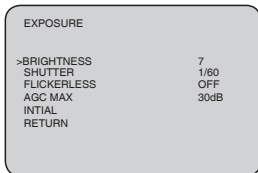

- BRIGHTNESS

: Enable user to control the image brightness (0~15steps).

- SHUTTER

: Enable user to set up the Shutter Speed.

-> 1/60(50), 1/100(120), 1/250, 1/500, 1/1K, 1/2K, 1/4K, 1/6K, 1/10K, 1/50K, 1/100K.

*() is for PAL TYPE.

- FLICKERLESS

: Enable user to set up the FLICKERLESS ON/OFF.

- AGC MAX

: Enable user to make imager bright to amplify the Gain.

-> 6dB~42dB

- INITIAL

: Enable user to initialize the Exposure menu set up.

9. OSD MANUAL

3. WHITE BALANCE

: Enable user to represent the accurate white color by controlling the R,G,B level. Setting up LEFT, RIGHT KEY on each menu.

- WB MODE

- ① ATW : Enable user to trace the White Balance automatically in the range of 2,300K~10,000K.
- ② PUSH : Enable user to search for White Balance automatically. In this mode, color temperature range is broader than ATW.
- ③ PUSH LOCK : Enable user to fix the White Balance according to the color temperature in the certain environment.
- ④ MANUAL : Enable user to sets the White Balance according to the circumstance.

- RED CONTROL

: In the MANUAL setting of WB MODE, enable user to set the RED GAIN.

- BLUE CONTROL

: In the MANUAL setting of WB MODE, enable user to set the BLUE GAIN.

- PUSH AUTO

: In the PUSH LOCK setting of WB MODE, enable user to fix the White Balance in camera setting.

- INITIAL

: Enable user to reset the WHITE BALANCE menu setting..

WHITE BALANCE	
>WB MODE	AUTO
RED CONTROL	---
BLUE CONTROL	---
PUSH AUTO	---
INITIAL	
RETURN	

4. BLC

: Use the condition which Image doesn't figure out with BLC such as place surrounded windows and lobby. Set the BLC using the LEFT, RIGHT KEY on the each menu.

- ATR MODE

: In this mode, the brightness of a single image is compensated using the gamma curve.

- ATR LEVEL

: Enable user to set ATR Level(0~4 level).

- BLC(Back Light Compensation)

- ① OFF : BLC mode off.
- ② ON : BLC mode on.
- ③ HLC : High Light Compensation Mode on.

BLC	
>ATR MODE	ON
ATR LEVEL	4
BLC MODE	ON
BLC ZONE	CENTER
BLC LEVEL	8
INITIAL	
RETURN	

***High Light Compensation (HLC)** is a function that improves the visual recognition of license plates and other such objects by suppressing or masking strong light sources (such as the headlights of automobiles).

9. OSD MANUAL

- BLC ZONE : Enable user to set the BLC area
-> TOP, BOTTOM, CENTER, LEFT, RIGHT.
- BLC LEVEL : Enable user to set BLC in selected area(0~15 level).
- INITIAL : Enable user to initialize the BLC setting.

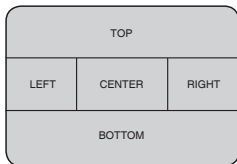

5. DAY&NIGHT

: Conversion of output image COLOR / BW depending on exterior environment
Enable user to set the LEFT, RIGHT KEY in menu.

- D&N MODE

- ① COLOR : Enable user to fit the output image in color.
- ② B/W : Enable user to fit the output image in B/W.
- ③ AUTO :
Enable user to convert to COLOR/BW automatically.

- DWELL TIME : In D&N MODE AUTO, enable user to set to delay time for changing COLOR/BW(0~10sec).

- D->N LEVEL

: Day(Color) to Night(BW) a Sensor level(0~19).

- N->D LEVEL

: Night(BW) to Day(Color) a Sensor level(1~20).

- BURST

: In BW mode, Color burst signal ON / OFF.

- SMART-IR

: By the IR LED light, the screen is saturated, and automatically adjust the brightness, so you can see the screen.

- SMART-IR LEVEL

: Enable user to control the Level (0~15steps).

- LED CONTROL

- ① MANUAL : IR LED brightness is adjusted manually.
- ② AUTO : IR LED brightness is adjusted automatically.

- LED LEVEL

: Enable user to control the IR-LED Level (0~15steps).

- INITIAL

: Enable user to initialize the setting in DAY&NIGHT menu.

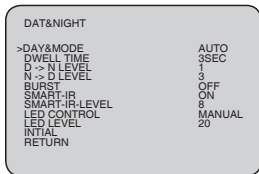

9. OSD MANUAL

6. IMAGE

: MIRROR, DNR, SHARPNESS functions set up by pressing LEFT, RIGHT KEY.

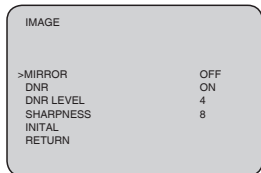

- MIRROR: Enable user to reverse the image.
- DNR : This function reduces noise by undertaking spatial filtering for one image.

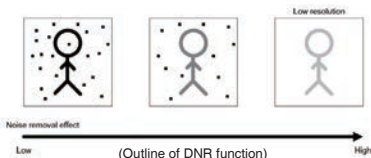

- DNR LEVEL : Enable user to set level(0~15 steps).
- SHARPNESS : Enable user to control the image sharpness (0~15steps).
- INITIAL : Enable user to initialize the setting on IMAGE menu.

7. SPECIAL

: Setting up the CAM TITLE, LANGUAGE, COMM ADJUST, PRIVACY, MOTION DETECT, DISPLAY, DEFECT. Set up using LEFT and RIGHT key in each menu.

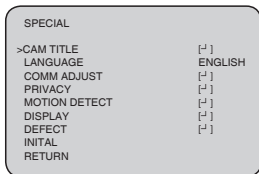

9. OSD MANUAL

- CAM TITLE : Enable user to choose any word in screen(Maximum 10 letter is available)

- ① A letter Choice from the screen using menu key
- ② Enable user to move to next menu using LEFT, RIGHT KEY in LOCATION.
- ③ By using UP, DOWN, LEFT, RIGHT KEY, enable user to choose any letters in LOCATION and then get back to previous step.
- ④ Enable user to finish words choice and position by using LEFT, RIGHT KEY in RETURN

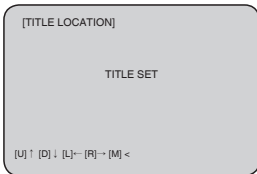

- LANGUAGE : Enable user to set up an OSD language

-> ENGLISH, CHINESE, RUSSIAN, SPANISH, GERMAN, FRENCH, PORTUGUESE, JAPANESE.

- COMM ADJUST :

Enable user to set up CAMERA ID, BAUDRATE.

- ① CAM ID : Enable user to set up Camera ID (0-255).
- ② BAUDRATE : A communication speed to Communicate with external device. (2400, 4800, 9600, 19200).

- PRIVACY : Privacy is the function that covers the some part on screen to prevent private life (Maximum 4 point covered).

- ① ZONE : Enable user to set up a position from 0 to 3 area.
- ② MASK : Enable user to set up screen output of chosen position.
- ③ V START : Mask Vertical start position.
- ④ V END : Mask Vertical end position.
- ⑤ H START : Mask Horizontal start position.
- ⑥ H END : Mask Horizontal end position.
- ⑦ COLOR : Set the mask color.
- ⑧ TRANSPARENCY : Set the transparency of the mask.
- ⑨ MOSAIC : Mosaic is set to mask the effect.
- ⑩ INITIAL : Enable user to initialize setting of PRIVACY MENU

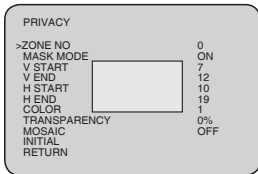
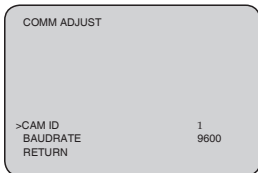

9. OSD MANUAL

- **MOTION DETECT** : Motion detection function.

- ① **MOTION MODE** : Enable user to set up ON/OFF
- ② **LEVEL** : Enable user to setup a motion detect sensitivity (0-3)
- ③ **V START** : Motion area Vertical start position.
- ④ **V END** : Motion area Vertical end position.
- ⑤ **H START** : Motion area Horizontal start position.
- ⑥ **H END** : Motion area Horizontal end position.
- ⑦ **INITIAL** : Enable user to initialize setting of MOTION DETECT

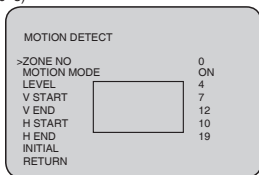

- **DISPLAY** : Enable user to set up a screen marking of CAM ID, CAM TITLE, MOTION DETECT.

- ① **CAM ID** :
Enable user to set up output on Camera ID screen
- ② **CAM TITLE** :
Enable user to set up output in fixed CAM TITLE
- ③ **MOTION DETECT**: Enable user to set up output of MOTION on the screen as MOTION DETECT ON setting.
- ④ **INITIAL** : Enable user to initialize of DISPLAY menu.

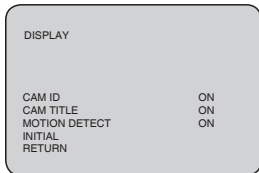

- **DEFECT** : The white pixel detection and compensation function can automatically detect and compensate up to 64 white pixels.

- ① **COMPENSATION** : DEFECT COMPENSATION On/Off..
- ② **DETECTION** : White pixel detection..

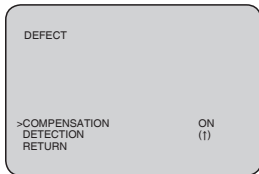

8. FACTORY DEFAULT

: Enable user to reset all of the status as the factory default Setting up using LEFT, RIGHT KEY

9. EXIT

: Enable user to EXIT the OSD menu Setting up using LEFT, RIGHT KEY

10. Communication Protocol

Pelco "D" Protocol Commands

- Most widely used Commands

	BYTE1	BYTE2	BYTE3	BYTE4	BYTE5	BYTE6	BYTE7
TELE	0xFF	CamID	0x00	0x20	0x00	0x00	ChkSum
WIDE	0xFF	CamID	0x00	0x40	0x00	0x00	ChkSum
NEAR	0xFF	CamID	0x01	0x00	0x00	0x00	ChkSum
FAR	0xFF	CamID	0x00	0x80	0x00	0x00	ChkSum
MENU①	0xFF	CamID	0x00	0x23	0x00	0x5F	ChkSum
MENU②	0xFF	CamID	0x00	0x03	0x00	0x62	ChkSum
MENU③	0xFF	CamID	0x00	0x07	0x00	0x5F	ChkSum
MENU④	0xFF	CamID	0x00	0x07	0x00	0x60	ChkSum

- ※ MENU① : Pelco Keyboard Menu On/Off [95(=0x5F) + Pattern]
- ※ MENU② : V/D Keyboard Menu On/Off [Set Preset + 98(=0x62)]
- ※ MENU③④ : Another Menu On/Off [Go To Preset + 95(=0x5F) or 96(=0x60)]

- ※ CamID : 0x00 ~ 0xFF
- ※ ChkSum : The Check Sum is the 8 bit (modulo256) sum of the payload bytes (BYTE2-BYTE6) in the command.

- TELE = UP KEY
- WIDE = DOWN KEY
- NEAR = LEFT KEY
- FAR = RIGHT KEY
- MENU = MENU KEY

CAUTION

These servicing instructions are for use by qualified service personnel only. To reduce the risk of electric shock do not perform any servicing other than that contained in the operating instructions unless you are qualified to do so.

In USA and Canada, Use Class 2 Power Supply Only

CONTENTS

1. CAUTIONS
2. IMPORTANT SAFETY INSTRUCTIONS
3. FEATURES
4. COMPONENTS
5. NAME AND FUNCTION
6. INSTALLATION
7. DIMENSIONS
8. SPECIFICATION
9. OSD MANUAL
10. COMMUNICATION PROTOCOL

1. CAUTIONS

This device complies with Part 15 of the FCC Rules. Operation is subject to the following two conditions;

1. This device may not cause harmful interference.
2. This device must accept any interference received, including interference that may cause undesired operation.

Note

This equipment has been tested and found to comply with the limits for a Class A digital device, pursuant to part 15 of the FCC Rules. These limits are designed to provide reasonable protection against harmful interference when the equipment is operated in a commercial environment. This equipment generates, uses, and can radiate radio frequency energy and, if not installed and used in accordance with the instruction manual, may cause harmful interference to radio communications. Operation of this equipment in a residential area is likely to cause harmful interference in which case the user will be required to correct the interference at his own expense."

WARNING

This is a class A product. In a domestic environment this product may cause radio interference in which case the user may be required to take adequate measures.

Caution

Any changes or modifications in construction of this device which are not expressly approved by the party responsible for compliance could void the user's authority to operate the equipment.

CAUTION

1. A regulated DC12V 1A power supply is recommended for use with this camera for the best picture and the most stable operation.
An unregulated power supply can cause damage to the camera.
When unregulated power supply is applied, product warranty will be out of subject.
2. It is recommended that the camera is used with a monitor that has a CCTV quality 75 video impedance level.
If your monitor is switched to high impedance then please adjust accordingly.
3. Do not attempt to disassemble the camera to gain access to the internal componets. Refer servicing to your dealer.
4. Never face the camera towards the sun or any bright or reflective light, which may cause smear on the picture and possible damage to the CCD.
5. **Do not remove the serial sticker for the warranty service.**

1. CAUTIONS



Correct Disposal of This Product (Waste Electrical & Electronic Equipment)

(Applicable in the European Union and other European countries with separate collection systems)

This marking shown on the product or its literature, indicate that it should not be disposed with other household wastes at the end of its working life. To prevent possible harm to the environment or human health from uncontrolled waste disposal, please separate this from other types of wastes and recycle it responsibly to promote the sustainable reuse of material resources.

This product should not be mixed with other commercial wastes purchased this product, or their local government office, for details of where and how they can take item for environmentally safe recycling.

Business users should contact their supplier and check the terms and conditions of the purchase contract.

Household users should contact either the retailer where they for disposal.

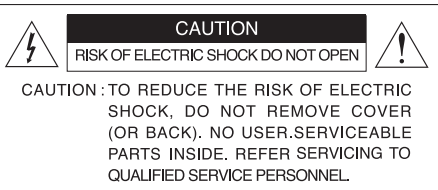

This symbol is intended to alert the user to the presence of uninsulated “dangerous voltage” within the product’s enclosure that may be of sufficient magnitude to constitute a risk of electric shock to persons.



This symbol is intended to alert the user to the presence of important operating and maintenance(servicing) instructions in the literature accompanying the appliance

2. IMPORTANT SAFETY INSTRUCTION





- 1) Read these instructions.
- 2) Keep these instructions.
- 3) Heed all warnings.
- 4) Follow all instructions.
- 5) Do not use this apparatus near water.
- 6) Clean only with dry cloth.
- 7) Do not block any ventilation openings. Install in accordance with the manufacturer's instructions.
- 8) Do not install near any heat sources such as radiators, heat registers, stoves, or other apparatus (including amplifiers) that produce heat.
- 9) Do not defeat the safety purpose of the polarized or grounding-type plug. A polarized plug has two blades with one wider than the other. A grounding type plug has two blades and a third grounding prong. The wide blade or the third prong are provided for your safety. If the provided plug does not fit into your outlet, consult an electrician for replacement of the obsolete outlet.
- 10) Protect the power cord from being walked on or pinched particularly at plugs, convenience receptacles, and the point where they exit from the apparatus.
- 11) Only use attachments/accessories specified by the manufacturer.
- 12) Use only with the cart, stand, tripod, bracket, or table specified by the manufacturer, or sold with the apparatus. When a cart is used, use caution when moving the cart/apparatus combination to avoid injury from tip-over.
- 13) Unplug this apparatus during lightning storms or when unused for long periods of time.
- 14) Refer all servicing to qualified service personnel. Servicing is required when the apparatus has been damaged in any way, such as power-supply cord or plug is damaged, liquid has been spilled or objects have fallen into the apparatus, the apparatus has been exposed to rain or moisture, does not operate normally, or has been dropped.

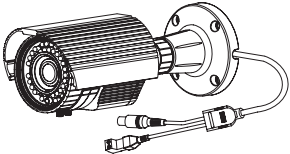

3. FEATURES

- 1/3"960H SONY EXview HAD CCD II
- High Resolution of 700TV Lines
- OSD Function
- Multi Language
(ENGLISH, CHINESE, RUSSIAN, SPANISH, GERMAN, FRENCH, PORTUGUESE, JAPANESE)
- 2DNR
- Privacy Zone / Motion Detect
- Smart IR
- DC12V / AC24V Dual Voltage
- ATR(Adaptive Tone-curve Reproduction / Digital WDR)
The function provides gradation compensation to improve the contrast of subjects both low-luminance areas and high luminance areas exist in the same picture

4. COMPONENTS

SUPER NIGHT VISION CAMERA	
VIDEO OUTPUT TEST CABLE	
L-WRENCH / SCREW - 4ea	
OPERATION MANUAL	

5. NAME AND FUNCTION

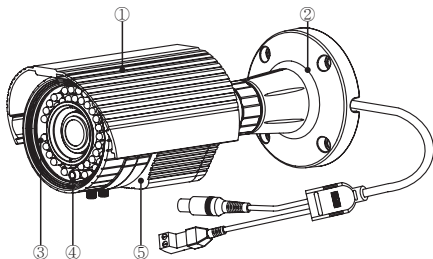

• Service Video connector & OSD Joystick

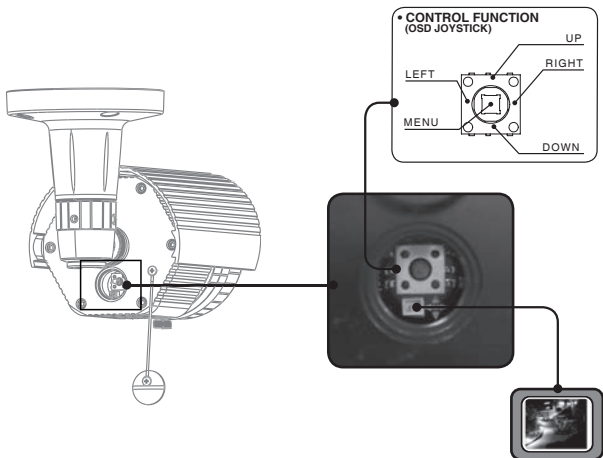

5. NAME AND FUNCTION

- Heater

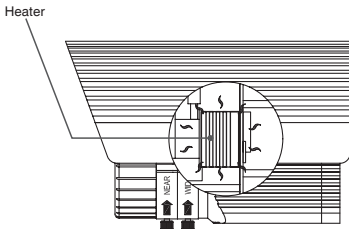

Built in heater protects the camera from low temperature.
(Operating temperature with Heater:-40°C)

- External Zoom & Focus Adjustable

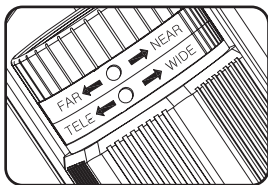
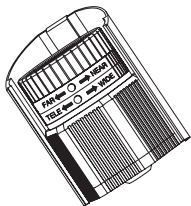

External Zoom & Focus Adjustable

6. INSTALLATION

• MOUNTING POSITION

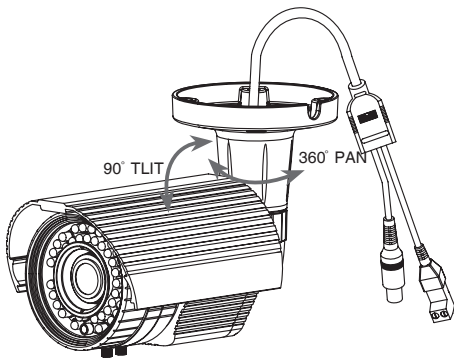
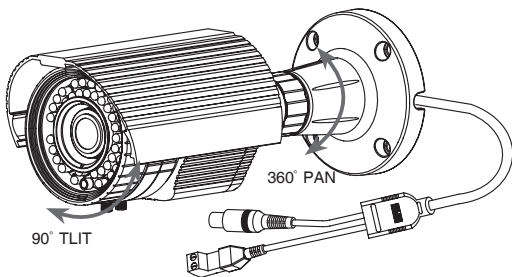

6. INSTALLATION

• MONITOR CONNECTION

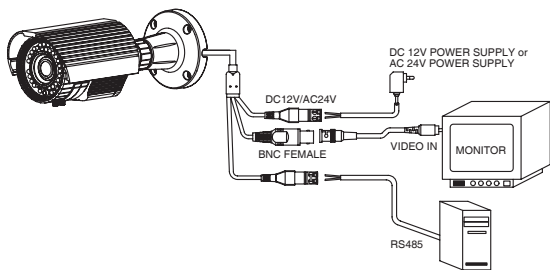
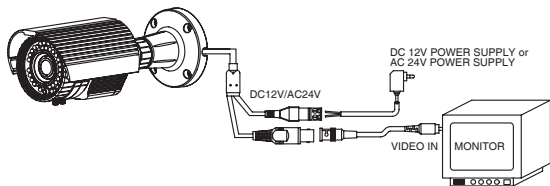

When you install the camera, please glue up the end of cable to keep it stable in order to protect the camera from the humidity problems.

7. DIMENSIONS

Unit : mm

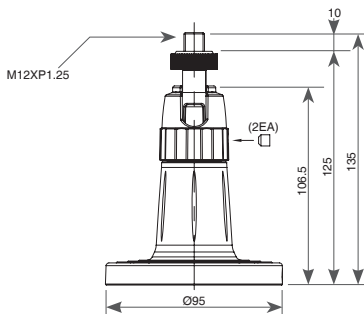
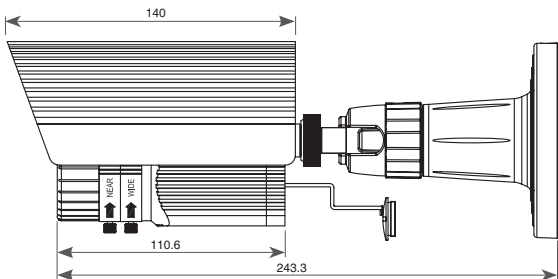
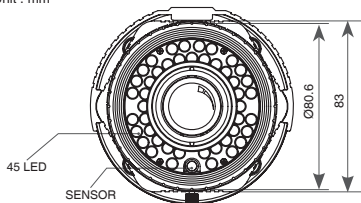

8. SPECIFICATION

Signal Format	NTSC	PAL
Image Device	1/3"~960H SONY EXview HAD CCD II	
Scanning System	2 : 1 Interlace	
Scanning Frequency	15.734KHz(H), 59.94Hz(V)	15.625KHz(H), 50Hz(V)
Total Pixels	1020(H) X 508(V)	1020(H) X 596(V)
Effective Pixels	976(H) X 494(V)	976(H) X 582(V)
Electronic Shutter Speed	1/60 sec	1/50 sec
H.Resolution	750TV Lines	
S/N Ratio	More than 50dB(AGC OFF)	
Min.Illumination	LED On : 0 Lux	
Sync System	Internal	
Gamma	$\gamma = 0.45$	
Video Output Level	1.0 Vp-p Composite(75 Ω)	
OSD	Built in (Joystick)	
BLC	OFF / BLC / HLC	
2DNR	OFF/ON(Level adjustable)	
ATR	OFF/ON(Level adjustable)	
SMART IR	On / Off	
White Balance	ATW / PUSH / MANUAL / PUSH-LOCK	
Privacy Masking	4 Zones	
Motion Detection	4 Zones	
Day & Night(ICR)	AUTO / Color / BW	
Language	ENGLISH, CHINESE, RUSSIAN, SPANISH, GERMAN, FRENCH, PORTUGUESE, JAPANESE	
IP Rating	IP67 (Water proof)	
IR LED	850nm, 45ea	
IR LED Distance	Up to 50M	
Operating Temperature	14°F~122°F(-10°C~+50°C) / Heater On: -40°F~122°F(-40°C~+50°C)	
Storage Temperature	-4°F~140°F(-20°C~+60°C)	
Humidity	Less than 80%	
Power Consumption	DC12V ($\pm 10\%$) Max.850mA, 1.1A(Heater On) AC24V ($\pm 10\%$) Max.10W, 21W(Heater On)	
Lens	Varifocal Lens	
Dimension	98.6(W) x 83(H) x 110.6(D)	
Weight	Approx. 900g	
Option	RS-485, Heater	

Specifications and designs are subject to change for improving the functionality of this product without notice.

9. OSD MANUAL

GENERAL STRUCTURE

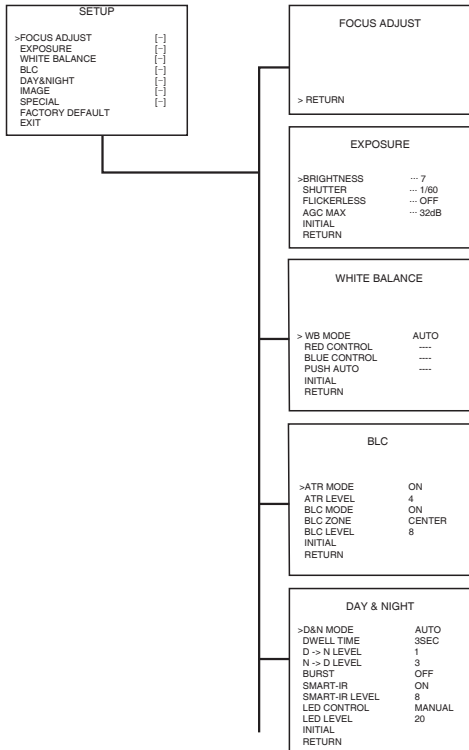

9. OSD MANUAL

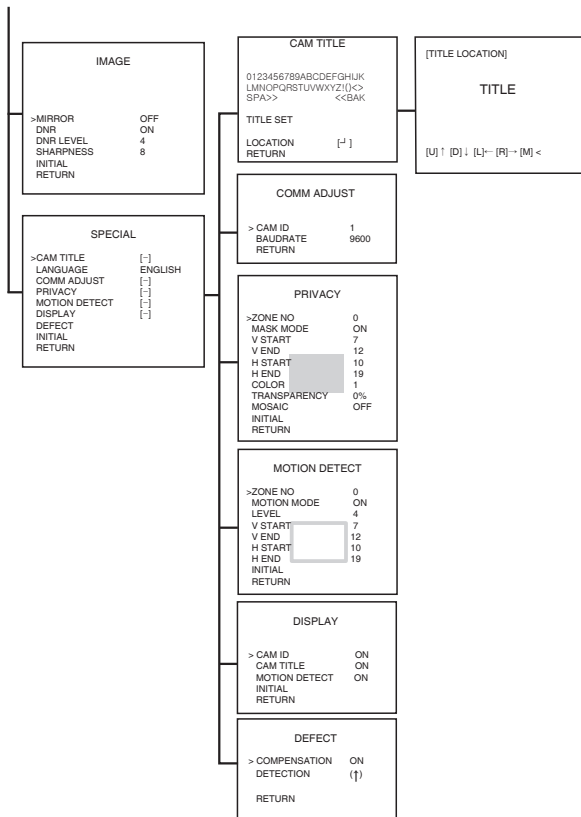

9. OSD MANUAL

MAIN MENU	Sub Menu	Sub MENU
SETUP		
FOCUS ADJUST	RETURN	
EXPOSURE	BRIGHTNESS	0-15
	SHUTTER	1/60(50), 1/120(100),1/250, 1/500, 1/1k, 1/2k, 1/4k, 1/6k, 1/10k, 1/50k, 1/100k
	FLICKERLESS	OFF, ON
	AGC MAX	6dB, 9dB, 12dB, 15dB, 18dB, 21dB, 24dB, 27dB, 30dB, 33dB, 36dB, 39dB, 42dB
	INITIAL	
	RETURN	
WHITE BALANCE	WB MODE	ATW, PUSH, PUSH LOCK, MANUAL
	RED CONTROL	0 - 255
	BLUE CONTROL	0 - 255
	PUSH AUTO	-
	INITIAL	
	RETURN	
BLC	ATR MODE	OFF, ON
	ATR LEVEL	0 - 4
	BLC MODE	OFF, ON, HLC
	BLC ZONE	TOP, BOTTOM, CENTER, LEFT, BIGHT
	BLC LEVEL	0 - 15
	INITIAL	
	RETURN	
DAY&NIGHT	D&N MODE	COLOR, B/W, AUTO
	DWELL TIME	0 - 10
	D -> N LEVEL	0 - 19
	N -> D LEVEL	1 - 20
	BURST	OFF, ON
	SAMRT-IR	OFF, ON
	SMART-IR LEVEL	0 - 15
	LED CONTROL	MANUAL, AUTO
	LED LEVEL	0 - 20
	INITIAL	
	RETURN	
IMAGE	MIRROR	OFF, ON
	DNR	OFF, ON
	DNR LEVEL	0 - 15
	SHARPNESS	0 - 15
	INITIAL	
	RETURN	
SPECIAL	CAM TITLE	CAM TITLE
		0 1 2 3 4 5 6 7 8 9 A B C D E F G H I J K
		L M O P Q R S T U V W X Y Z I - () < >
		SPA>> <<BAK
		LOCATION
	RETURN	

9. OSD MANUAL

MAIN MENU	Sub Menu	Sub MENU	
SPECIAL	LANGUAGE	ENGLISH, CHINESE, RUSSIAN, SPANISH, GERMAN, FRENCH, PORTUGUESE, JAPANESE	
	COMM ADJUST	CAM ID	0 - 255
		BAUDRATE	2400, 4800, 9600, 19200
		RETURN	
	PRIVACY	ZONE NO	0 - 3
		MASK MODE	OFF, ON
		V START	0 - 17
		V END	1 - 18
		H START	0 - 29
		H END	1 - 30
		COLOR	0 - 7
		TRANSPARENCY	0%, 25%, 50%
		MOSAIC	OFF, ON
		INITIAL	
	RETURN		
	MOTION DETECT	ZONE NO	0 - 3
		MOTION MODE	OFF, ON
		LEVEL	0 - 15
		V START	0 - 6
		V END	1 - 7
		H START	0 - 10
		H END	1 - 11
		INITIAL	
	RETURN		
	DISPLAY	CAM ID	OFF, ON
		CAM TITLE	OFF, ON
		MOTION DETECT	OFF, ON
		INITIAL	
		RETURN	
	DEFECT	COMPENSATION	OFF, ON
		DETECTION	
RETURN			
INITIAL			
RETURN			
FACTORY DEFAULT			
EXT			

9. OSD MANUAL

OSD FUNCTION DESCRIPTION

1. FOCUS ADJUST

: According to the brightness of light to minimize the depth of focus, to be more accurate to focus.

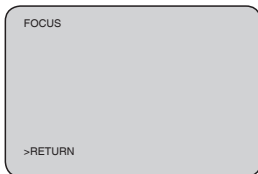

2. EXPOSURE

: Enable user to set up the function of BRIGHTNESS, SHUTTER, FLICKERLESS, AGC. Set up using LEFT, RIGHT KEY at each menu.

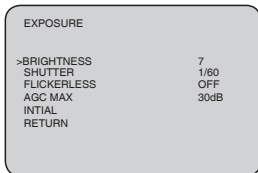

- BRIGHTNESS

: Enable user to control the image brightness (0~15steps).

- SHUTTER

: Enable user to set up the Shutter Speed.

-> 1/60(50), 1/100(120), 1/250, 1/500, 1/1K, 1/2K, 1/4K, 1/6K, 1/10K, 1/50K, 1/100K.

*() is for PAL TYPE.

- FLICKERLESS

: Enable user to set up the FLICKERLESS ON/OFF.

- AGC MAX

: Enable user to make imager bright to amplify the Gain.

-> 6dB~42dB

- INITIAL

: Enable user to initialize the Exposure menu set up.

9. OSD MANUAL

3. WHITE BALANCE

: Enable user to represent the accurate white color by controlling the R,G,B level. Setting up LEFT, RIGHT KEY on each menu.

- WB MODE

- ① ATW : Enable user to trace the White Balance automatically in the range of 2,300K~10,000K.
- ② PUSH : Enable user to search for White Balance automatically. In this mode, color temperature range is broader than ATW.
- ③ PUSH LOCK : Enable user to fix the White Balance according to the color temperature in the certain environment.
- ④ MANUAL : Enable user to sets the White Balance according to the circumstance.

- RED CONTROL

: In the MANUAL setting of WB MODE, enable user to set the RED GAIN.

- BLUE CONTROL

: In the MANUAL setting of WB MODE, enable user to set the BLUE GAIN.

- PUSH AUTO

: In the PUSH LOCK setting of WB MODE, enable user to fix the White Balance in camera setting.

- INITIAL

: Enable user to reset the WHITE BALANCE menu setting..

WHITE BALANCE	
>WB MODE	AUTO
RED CONTROL	---
BLUE CONTROL	---
PUSH AUTO	---
INITIAL	
RETURN	

4. BLC

: Use the condition which Image doesn't figure out with BLC such as place surrounded windows and lobby. Set the BLC using the LEFT, RIGHT KEY on the each menu.

- ATR MODE

: In this mode, the brightness of a single image is compensated using the gamma curve.

- ATR LEVEL

: Enable user to set ATR Level(0~4 level).

- BLC(Back Light Compensation)

- ① OFF : BLC mode off.
- ② ON : BLC mode on.
- ③ HLC : High Light Compensation Mode on.

BLC	
>ATR MODE	ON
ATR LEVEL	4
BLC MODE	ON
BLC ZONE	CENTER
BLC LEVEL	8
INITIAL	
RETURN	

***High Light Compensation (HLC)** is a function that improves the visual recognition of license plates and other such objects by suppressing or masking strong light sources (such as the headlights of automobiles).

9. OSD MANUAL

- BLC ZONE : Enable user to set the BLC area
-> TOP, BOTTOM, CENTER, LEFT, RIGHT.
- BLC LEVEL : Enable user to set BLC in selected area(0~15 level).
- INITIAL : Enable user to initialize the BLC setting.

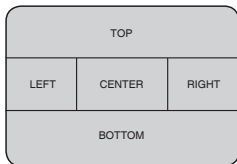

5. DAY&NIGHT

: Conversion of output image COLOR / BW depending on exterior environment
Enable user to set the LEFT, RIGHT KEY in menu.

- D&N MODE

- ① COLOR : Enable user to fit the output image in color.
- ② B/W : Enable user to fit the output image in B/W.
- ③ AUTO :
Enable user to convert to COLOR/BW automatically.

- DWELL TIME : In D&N MODE AUTO, enable user to set to delay time for changing COLOR/BW(0~10sec).

- D->N LEVEL

: Day(Color) to Night(BW) a Sensor level(0~19).

- N->D LEVEL

: Night(BW) to Day(Color) a Sensor level(1~20).

- BURST

: In BW mode, Color burst signal ON / OFF.

- SMART-IR

: By the IR LED light, the screen is saturated, and automatically adjust the brightness, so you can see the screen.

- SMART-IR LEVEL

: Enable user to control the Level (0~15steps).

- LED CONTROL

- ① MANUAL : IR LED brightness is adjusted manually.
- ② AUTO : IR LED brightness is adjusted automatically.

- LED LEVEL

: Enable user to control the IR-LED Level (0~15steps).

- INITIAL

: Enable user to initialize the setting in DAY&NIGHT menu.

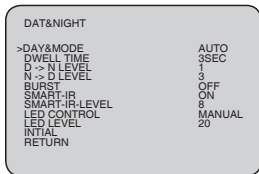

9. OSD MANUAL

6. IMAGE

: MIRROR, DNR, SHARPNESS functions set up by pressing LEFT, RIGHT KEY.

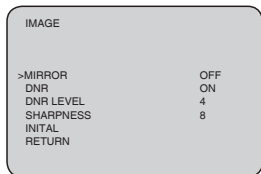

- MIRROR: Enable user to reverse the image.
- DNR : This function reduces noise by undertaking spatial filtering for one image.

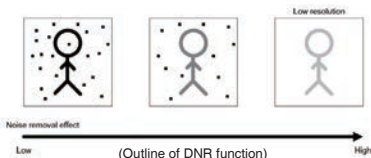

- DNR LEVEL : Enable user to set level(0~15 steps).
- SHARPNESS : Enable user to control the image sharpness (0~15steps).
- INITIAL : Enable user to initialize the setting on IMAGE menu.

7. SPECIAL

: Setting up the CAM TITLE, LANGUAGE, COMM ADJUST, PRIVACY, MOTION DETECT, DISPLAY, DEFECT. Set up using LEFT and RIGHT key in each menu.

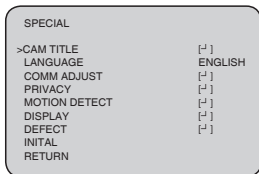

9. OSD MANUAL

- CAM TITLE : Enable user to choose any word in screen(Maximum 10 letter is available)
 - ① A letter Choice from the screen using menu key
 - ② Enable user to move to next menu using LEFT, RIGHT KEY in LOCATION.
 - ③ By using UP, DOWN, LEFT, RIGHT KEY, enable user to choose any letters in LOCATION and then get back to previous step.
 - ④ Enable user to finish words choice and position by using LEFT, RIGHT KEY in RETURN

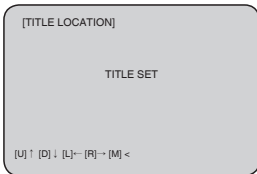

- LANGUAGE : Enable user to set up an OSD language
-> ENGLISH, CHINESE, RUSSIAN, SPANISH, GERMAN, FRENCH, PORTUGUESE, JAPANESE.

- COMM ADJUST :

Enable user to set up CAMERA ID, BAUDRATE.

- ① CAM ID : Enable user to set up Camera ID (0-255).
- ② BAUDRATE : A communication speed to Communicate with external device. (2400, 4800, 9600, 19200).

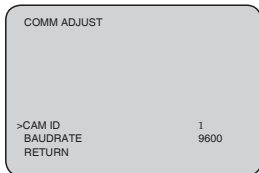

- PRIVACY : Privacy is the function that covers the some part on screen to prevent private life (Maximum 4 point covered).

- ① ZONE : Enable user to set up a position from 0 to 3 area.
- ② MASK : Enable user to set up screen output of chosen position.
- ③ V START : Mask Vertical start position.
- ④ V END : Mask Vertical end position.
- ⑤ H START : Mask Horizontal start position.
- ⑥ H END : Mask Horizontal end position.
- ⑦ COLOR : Set the mask color.
- ⑧ TRANSPARENCY : Set the transparency of the mask.
- ⑨ MOSAIC : Mosaic is set to mask the effect.
- ⑩ INITIAL : Enable user to initialize setting of PRIVACY MENU

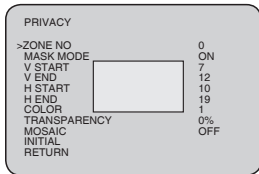

9. OSD MANUAL

- **MOTION DETECT** : Motion detection function.

- ① **MOTION MODE** : Enable user to set up ON/OFF
- ② **LEVEL** : Enable user to setup a motion detect sensitivity (0-3)
- ③ **V START** : Motion area Vertical start position.
- ④ **V END** : Motion area Vertical end position.
- ⑤ **H START** : Motion area Horizontal start position.
- ⑥ **H END** : Motion area Horizontal end position.
- ⑦ **INITIAL** : Enable user to initialize setting of MOTION DETECT

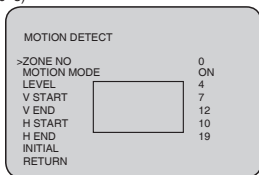

- **DISPLAY** : Enable user to set up a screen marking of CAM ID, CAM TITLE, MOTION DETECT.

- ① **CAM ID** :
Enable user to set up output on Camera ID screen
- ② **CAM TITLE** :
Enable user to set up output in fixed CAM TITLE
- ③ **MOTION DETECT**: Enable user to set up out put of MOTION on the screen as MOTION DETECT ON setting.
- ④ **INITIAL** : Enable user to initialize of DISPLAY menu.

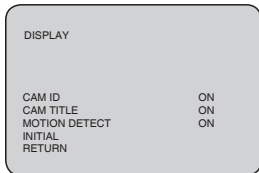

- **DEFECT** : The white pixel detection and compensation function can automatically detect and compensate up to 64 white pixels.

- ① **COMPENSATION** : DEFECT COMPENSATION On/Off..
- ② **DETECTION** : White pixel detection..

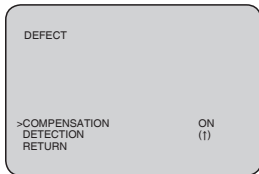

8. FACTORY DEFAULT

: Enable user to reset all of the status as the factory default Setting up using LEFT, RIGHT KEY

9. EXIT

: Enable user to EXIT the OSD menu Setting up using LEFT, RIGHT KEY

10. Communication Protocol

Pelco "D" Protocol Commands

- Most widely used Commands

	BYTE1	BYTE2	BYTE3	BYTE4	BYTE5	BYTE6	BYTE7
TELE	0xFF	CamID	0x00	0x20	0x00	0x00	ChkSum
WIDE	0xFF	CamID	0x00	0x40	0x00	0x00	ChkSum
NEAR	0xFF	CamID	0x01	0x00	0x00	0x00	ChkSum
FAR	0xFF	CamID	0x00	0x80	0x00	0x00	ChkSum
MENU①	0xFF	CamID	0x00	0x23	0x00	0x5F	ChkSum
MENU②	0xFF	CamID	0x00	0x03	0x00	0x62	ChkSum
MENU③	0xFF	CamID	0x00	0x07	0x00	0x5F	ChkSum
MENU④	0xFF	CamID	0x00	0x07	0x00	0x60	ChkSum

- ※ MENU① : Pelco Keyboard Menu On/Off [95(=0x5F) + Pattern]
- ※ MENU② : V/D Keyboard Menu On/Off [Set Preset + 98(=0x62)]
- ※ MENU③④ : Another Menu On/Off [Go To Preset + 95(=0x5F) or 96(=0x60)]

- ※ CamID : 0x00 ~ 0xFF
- ※ ChkSum : The Check Sum is the 8 bit (modulo256) sum of the payload bytes (BYTE2-BYTE6) in the command.

- TELE = UP KEY
- WIDE = DOWN KEY
- NEAR = LEFT KEY
- FAR = RIGHT KEY
- MENU = MENU KEY