

Historic Artifact Handbook

by

Jonathon C. Horn
Alpine Archaeological Consultants, Inc.
PO Box 2075
Montrose, CO 81402

March 2005

The intent of this handbook is to provide site recorders with little or no background in historic artifact identification sufficient information so that they can provide consistent descriptive information about the artifacts and site features they are observing. Good description of observed features and artifacts is essential for functional and chronological determinations to be made, thereby insuring that sites or site components are evaluated for significance using the proper thematic context. Regardless of whether or not an individual has the expertise to interpret the evidence present at a particular site, anyone carrying out site recordation has the obligation and should have the ability to provide good descriptive information.

A large portion of this handbook is composed of illustrations. For the most part, these are self-explanatory and little text will be written to accompany them. Many artifacts will not be described whatsoever. A list of references is also provided. The focus of the handbook will be on commonly found artifacts that are particularly useful in providing dating information. Historic artifacts from the late nineteenth and twentieth centuries are particularly time sensitive, because of the rapid growth and change of technology. Using an assemblage of historic artifacts, it is not uncommon to be able to date a site to a 5 or 10-year time period. Functional interpretations can also be quite accurate using the artifacts alone. When coupled with well-directed historical research, the information that can be learned from a historic site can be very illuminating, not only from a historical perspective, but from anthropological, behavioral, technological, and socioeconomic viewpoints as well.

When classifying historic artifacts, the preferred method is by function. Classifying artifacts by material type makes functional interpretations very difficult and is inherently troublesome because many historic artifacts are composed of a variety of materials. A classificatory system for artifacts in museum collections was devised Robert G. Chenall (1978) and updated by Blackaby and Greeno (1988). This system is used by the National Park Service for their museum collections and works very well, especially when reference is made to Sprague (1981). Reuse of artifacts for purposes other than their original intention is very important data and should be recorded, but is problematic.

Vessel Glass

Vessel glass includes all glass containers such as food and household chemical bottles and jars, beverage bottles, and canning jars. It also includes glass service wares such as drinking glasses and dishes. Glass color is a very good indicator of a vessel's age.

White Milkglass	ca. 1890s-present
Aqua	ca. 1800-1920s
Green	ca. 1860s-present
Amber or Brown	ca. 1860s-present
Cobalt Blue	ca. 1890s-present
Purple	ca. 1885-1920
Yellowish	ca. 1918-1920s

Purple glass is one of the best time markers to be found on archaeological sites. Use of manganese as a clearing agent in glass became very commonplace by 1885, perhaps beginning as early as 1880. Although the vessels started out clear in color, exposure to the sun resulted in a purple tint, varying in intensity depending on the amount of manganese used. The main source of manganese, Germany, was cut off as a result of World War I. Supplies on hand may have lasted into the very early 1920s, though in very limited quantities. Selenium replaced manganese as a clearing agent. It also changed color with exposure to the sun, this time to a yellowish hue, never getting dark enough to be confused with amber or brown glass.

Care must be taken when assigning a disposal date for a particular piece of glassware. Common food or household vessels were most usually disposed of immediately or soon after their contents had been used up. Canning jars and table service, especially fancy glassware, were used over and over again and were not discarded until unusable. Other glassware fragments, such as lamp chimneys or lantern globes, may be mistaken for short-lived vessels but in reality were used until broken.

Makers marks are very commonly found on the bases of food or household bottles and jars and the name or trademark of the product manufacturer is also frequently embossed on containers or lids. These marks and names should always be recorded as accurately as possible, even if fragmentary, because they can be looked up with relative ease, providing dates and other information. Here are four of the most common makers marks:

◊ - Mark of the Illinois Glass Company of Alton, Illinois in use between 1916 and 1929 (Toulouse 1971:264-268).

☐ - Mark of the Owens Bottle Company in use between 1911 and 1929 (Toulouse 1971:393).

⊕ - Mark of the Owens Illinois Glass Co. of Toledo, Ohio used upon the merger of the Owens Bottle Company and the Illinois Glass Company in 1929 and used until 1954 (Toulouse 1971:403-406). Associated with this mark will be numbers to the left, right, and bottom. The number to the left indicates the manufacturing plant. The number to the bottom is the mold number. The number to the right is the date number and can usually be added to 1929 to get the year of manufacture. However, care should be taken with the number 0, 1, and 2. The 0 may indicate manufacture in 1940 and the 1 and 2 may indicate manufacture in 1930 and 1931 or 1941 and 1942. Beginning in 1942, the last two digits of the year were used.

⌊ - Mark of the Hazel-Atlas Glass Co. of Wheeling, West Virginia. This mark was in use from 1920 to 1964 (Toulouse 1971:239). According to the U.S. Patent Office, the trademark was registered in 1924.

Other marks also seem to have date numbers in association, particularly beer bottles beginning in the 1940s. These are not well documented, so assumptions of dates by numbers on bottle bases should be considered relative to other artifacts on a site. Plastic bottles may also have date numbers.

Vessel manufacturing attributes should be recorded as well. The attached dating key and illustrations provide the technical information necessary for providing this information.

Depression glass comes in a variety of colors and shapes. It was usually inexpensive dime-store dishware and was often given away in advertising promotions. Patterns can often be identified and frequently have restricted periods of production. On occasion, decorative glass table service or housewares came in purple. Consideration should be of the type of vessel and its use when purple glass is concerned as curated items or items considered for long use were sometimes manufactured of purple glass that, without close observation, can be confused with fragments of jar or bottles of an earlier age.

Ceramics

Ceramics found on archaeological sites in the West can generally be categorized into one of three basic types: stoneware, earthenware, and porcelain.

Stoneware is a clay ceramic frequently used for utilitarian vessels, such as crockery or sewer pipe. It is fired at a high enough temperature that the clay becomes vitrified somewhat, resulting in impermeability to liquids. It is frequently glazed. The fired clay has a rather porous appearance and is frequently tan to brown.

Earthenware is probably the most common type of ceramic found on historic archaeological sites. It is easily manufactured into a variety of shapes with fairly thin walls and is impermeable to liquids. The fired clay appears very fine in texture, ranges in color from white to yellowish, and sticks to the tongue to varying degrees depending on how vitrified the ceramic is from firing. Earthenwares are commonly glazed with a white or clear slip and are often well decorated. Decoration can range from blue-on-white oriental patterns to polychrome hand-painted, transfer-printed, or decal decoration, to relief-molded patterning with gilding, or any combination of the above. In general, the more refined the decoration, the more expensive the ware. This makes some economic scaling possible. Another generalization that should be considered is that decorated wares frequently indicate a family unit or at least the presence of a woman. Plain white earthenwares, often known as hotel ware, are frequently found at labor camps.

Porcelain is the most refined of the ceramics. It is generally very thin walled and highly vitreous. In cross section, porcelain looks very much like rough glass and will not stick to the tongue. It is almost always very fancy tableware and well decorated in the manner described above for earthenware. The expensiveness of porcelain is indicative of a certain level of affluence and, again, the likelihood of a woman's presence.

As with vessel glass, makers marks are very commonly found on the bases of earthenware and porcelain vessels and on the sides of stoneware vessels. These are either printed on or impressed into the vessel. Makers marks are very time diagnostic and occasionally can be dated to the month and year of manufacture. Because ceramic vessels were intended for long use, the date obtained from ceramics may indicate a slightly earlier date than is the actual case for a site. Ceramic dates should be considered as only one piece of information in the total artifact assemblage from a site when ascribing a date.

Cans

Cans come in a wide variety of shapes, sizes, and styles. Changes in can manufacturing technology in the late nineteenth century and early twentieth century make cans fairly good time indicators. The most commonly encountered cans are those which contained fresh foods. These can be broken down into three basic types: Hole-in-cap, hole-in-top, and sanitary (modern-style) cans.

Hole-and-cap cans are lead-sealed cans having a separate filler cap, soldered in place, with a pin hole vent covered with a spot of lead solder. These cans were manufactured at first entirely by hand and later by machine. The ends of the cans have flat lips that fit around the outside of the can sides. The connection is not interlocked in any way. One end of the can has a filler hole large enough for the contents of the can to enter. The filler hole was covered by a sheet metal disc soldered in place forming a characteristic ring of lead. The filler cap has a pin hole which allowed steam to escape during processing. Once processing was completed, the pin hole was sealed with a spot of lead solder. The side seam of the cans was also covered with a line of solder. In general, cans from the early 1880s and before tend to have heavier amounts of solder on their side seams, less neatly applied, than later cans. Side seams began to be soldered by machine in the 1880s, resulting in more uniform and regular solder seams. Aberrations may be observed on hole-in-cap cans that may be

noteworthy. On occasion, cans may be found that have the sides fitted around the ends. More frequently, cans with two vent holes and two lead spots on the filler caps may be observed.

Hole-in-cap cans were in production by the 1820s. A stamping machine for the manufacture of can ends was patented in 1847. Can ends began being soldered by machine in the mid-1870s and a machine for soldering side seams was introduced in 1883. Rectangular hole-in-cap cans for canned corned beef were introduced in 1875 (Rock 1984:102-103). Inventions for crimping the seams of cans, eliminating the need for solder, leading to the development of "sanitary" cans, began in 1888, but sanitary cans as we know them did not come onto the market until 1904. By 1911, sanitary cans had dominated the can market (Rock 1984:105-106). In general, hole-in-cap cans on a site indicate a date of occupation prior to 1914 and an absence of sanitary cans suggests a pre-1904 date. One exception should be noted. Large hole-in-cap bulk food cans provided by the U.S. government to Civilian Conservation Corps camps, and possibly for military use, have been noted dating to the 1930s.

Hole-in-top cans closely resemble hole-in-cap cans but do not have filler holes. The tops of these cans may be stamped with ridges that mimic filler holes, but lack the solder ring. They do have a pin hole vent sealed with a spot of lead. Hole-in-top cans were introduced in 1900 by Carnation for evaporated milk (Rock 1984:104). These cans were still in use until the early 1990s. Prior to the introduction of hole-in-top cans (by 1885), evaporated milk was canned in hole-in-cap cans.

Sanitary cans are the cans in use today. These were the result of innovations in seam crimping machinery. In 1897, machinery was developed that could crimp the can ends to the sides with a double seam sealed with a rubber compound. By 1904, sanitary cans were in full production, completely dominating the market by 1911.

Other Can Innovations of Note

During the late 1890s and early 1900s, many new innovations were attempted to modernize food cans. These innovations appear as cans with unusual attributes. For instance, some lead-sealed cans have been observed with crimped ends similar to sanitary cans with lead spots over vent holes similar to hole-in-top cans. Some hole-in-cap cans have been observed with lead spots over two vent holes through the filler caps.

Prince Albert tobacco tins appear to have been first manufactured in 1907 or 1908 (Rock 1989:166; Periodical Publishers Association 1934:74). They had a simple friction-type lid with a loose pin hinge. In 1948, the lid was changed to be more airtight. The edge of the can was doubled over and the lid was made with a U-shaped lip into which the can edge fit and ran the full length of the lid. This is the closure still used (Kirkpatrick and Duran 1981:53).

Round quart-sized motor oil cans were introduced in 1933 (Rock 1989:147).

Sardine cans: three-piece body – 1810-1880; one-piece body – 1880-1918; depressed lid – 1884-present; double seamed – 1918-present (Gillio et al. 1980:9)

Distribution of canned beer did not begin until 1935. Cone-top cans with crown cap finishes were used on a limited basis from 1935 to 1959 (Rock 1981:25). See Beer Can Table for additional information.

Soft drinks were not successfully canned until 1953 (Rock 1981:27).

Can Openings

The way in which food cans have been opened is an indication of what may have been inside. There appears to be a correlation of the size of the filler hole on hole-in-cap cans to the type of opening technique used. This is not surprising because both are related to the size of the items inside. The opening technique may indicate whether the food inside was liquid, solid, or composed of small or large pieces. Condensed milk cans tend to have two small punched holes or slits for pouring out the contents. Key-wind openings were first introduced in 1866, though they were not widely used. In 1895, the technology was refined for use on meat tins that incorporated a scored strip (Rock 1984:105; Gillio et al. 1980:9). This is the opening technique used until very recently on sardine and coffee cans. Geared rotary can openers were introduced in 1925 for use on sanitary cans. Church-key openers were introduced in 1935 (Gillio et al. 1980:9).

Marks on Cans

For the most part, food cans were identified with paper labels and others with painted labels that rarely survive in archaeological contexts. Certain can types, such as baking powder cans, coffee cans, and others, have embossing identifying their contents and/or manufacturer. It is frequently possible to look these up and refine the date of the artifact. An unusual example is KC Baking Powder cans that give a number of years that the product cost the same. The year of manufacture can be determined by adding the years to 1890. Later cans, such as hole-in-top and sanitary cans, occasionally have markings or codes which may prove to be informative and should be recorded. For instance, the "SANITARY" mark found on some early sanitary cans is probably the mark of the Sanitary Can Company, which began business in 1904 and was purchased by the American Can Company in 1908 (Rock 1989:65).

Plastic

Molded plastic screw caps began to be manufactured in quantity in 1927. Initially, they were used on high-priced toiletries and cosmetics and were black, dark red, or brown in color. New plastics enabled a wide variety of colors to be manufactured in a few years, as well as a wider variety of applications. With improvements in molding equipment, plastic screw caps could be produced at prices competitive with metal caps (Lief 1965:30).

Nails

Nails are the most frequently encountered hardware fasteners at historic archaeological sites. The basic identification of wire (round) and cut (square) nails and their relative frequencies to each other is an important dating tool.

Cut nails have a long history of manufacture. Both hand-made and machine-made cut nails were manufactured in the nineteenth century. Transition from cut nails to wire nails took place between the 1880s to the early 1900s. Wire nails began to be imported in small numbers to America in the 1850s, and the manufacture of wire nails in America began in 1873; large-scale production did not begin until the 1880s. Wire nails were initially most competitive with cut nails in the smaller, finer sizes. It has been estimated that by 1890, approximately 50% of the nails produced were wire nails. In 1894, 70% of the nails produced were wire nails; in 1900, 82% were wire nails; and in 1913, 95% were wire nails (Clark 1929:Vol. 2:351-355, Vol. 3:126; Buckles 1978). In general, if cut nails are found on a site, a date of 1900 or before can be presumed. The rate at which wire nails replaced cut nails may vary throughout the country depending upon the source of supply. In Colorado, it is common for sites as early as 1890 to have a nail assemblage dominated by wire nails. This seems to be because the Colorado Fuel & Iron Company of Pueblo had the capability of producing wire nails by that time and had the ability to ship them by railroad by way of the Denver & Rio Grande Railway. The

sphere of their marketing area is currently unknown, but probably covers all of Colorado and may have extended into northern New Mexico, western Kansas, and southern Wyoming.

Window Glass

Window glass is flat glass, usually light green in color, frequently with lines, air bubbles or other flaws in older examples. The presence of window glass usually indicates that a fairly substantial structure was present at that location. Often, no other physical evidence remains of a structure besides window glass and nails.

Cartridges

Cartridges can be categorized into three types: Pinfire, rimfire, and centerfire.

Pinfire cartridges are the oldest of the patent ignition type cartridges. The hammer of the gun struck a pin projecting from near the base of the cartridge engaging a primer that set off the enclosed load. These saw fairly wide use and were still advertised after 1900.

Rimfire cartridges were ignited by a blow to the base by the gun's firing pin or hammer. These cartridges were introduced in the 1850s and are still popular today.

Centerfire cartridges have a primer incorporated into their base which ignites the load when struck by the gun's firing pin. These cartridges were developed in the 1860s, but did not become generally available until 1873 with the introduction of the .45-70 Government cartridge. Centerfire cartridges are still in use today.

It is very important to record any markings on the base of cartridges. On occasion, cartridges may be found that have no markings. These should be collected so that they can be measured and identified. In general, cartridges with no markings are older varieties, possibly dating prior to the early 1880s. Centerfire cartridges are reusable. Original primers are brass, replacement primers are usually chrome. Reloaded cartridges may not be very good indicators of site age. Introduction of recent cartridges by hunters to an otherwise older site is not uncommon and should be expected and accounted for when considering the occupational history indicated by surface artifacts.

Some basic chronological information about marks on cartridges:

U.M.C. - Union Metallic Cartridge Co. before it merged with Remington in 1912.

Rem-UMC - Remington-Union Metallic Cartridge Co. after merger in 1912.

R-P - Remington-Peters after Peters Cartridge Co. was absorbed by du Pont and Remington in 1934.

W.R.A. Co. - Winchester Repeating Arms Company prior to 1934 when the mark was changed to simply W.R.A.

Military ammunition is marked with the month and year of manufacture as well as the manufacturer.

Other gun related items to look for are percussion caps and gun flints. Gun flints may be mistaken for prehistoric lithic material but has a characteristic square shape. Bullets and gun parts are also found on occasion.

Other Artifacts

Buttons and Fasteners - Buttons and other clothing fasteners are commonly found on historic archaeological sites. Describe buttons by how they are attached to clothing and the material they are made of. Common shirt buttons should be described as two or four-hole sew-through buttons. What are usually thought to be white milkglass buttons are in reality Prosser ceramic. On occasion, the backs of buttons will have the name of the manufacturer or other information. Metal buttons similar to those on Levi's frequently have product names stamped or embossed on them. These are generally from overalls or other work clothes. Overall and suspender buckles are generally made of wire, sometimes partly covered with sheet metal. Old catalogs of clothing are very helpful in their identification.

Beads - Beads are found at both historic and post-contact aboriginal sites. Beads should be described by how they were made - drawn or spun (wound), by color, and any other manufacturing attributes they might possess such as grinding, etching, engraving, enameling, or painting. Bead styles can be somewhat time sensitive.

Wire Products - Wire products such as barbed wire, baling wire, and wire rope became widespread after the development of the Bessemer steel manufacturing process in 1876. Prior to the Bessemer process, wire could not be made into long strands of consistent strength and quality. The ability to make long lengths of good quality wire enabled a large number of products to be produced. One of the most frequently encountered products is barbed wire. The number of types of barbed wire manufactured is astounding. The varieties are very well documented, however, and patent dates ascertained if good descriptions are made in the field. Baling wire also became quite prevalent. Early baling machines required hand tying off of the ends of wire around a bale of hay. To facilitate this, a variety of bale ties with distinctive pre-made loop ends were marketed. How long these were available is not known, but they were certainly in use through the 1890s. Wire rope (commonly referred to as "cable") consists of numerous strands of wire braided or twisted into a single unit, sometimes around a core of hemp rope. Wire rope replaced natural fiber rope for use with machinery, especially with the expansion of use of steam power in the late 1880s and 1890s. Consequently, when wire rope is found on a site, it can be presumed that some sort of motive power was in use there.

Animal Shoes - Horse, mule, and oxen shoes are easy to identify. When examining them, however, be sure to note any modifications, especially of horseshoes. Such modifications may indicate use for work or pleasure, orthopedic problems the animal may have had, and use in icy, snowy, or muddy conditions - indicating seasonality.

Stove Parts - Very little information is currently available about stove manufacturers. However, stove parts are usually well marked with casting marks, the name of the stove and its manufacturer, and decorations. Frequently these marks can be identified or interpreted. For instance, some marks may indicate the size of the burner plates and oven. Certain parts may indicate whether a stove was intended to burn coal or wood. It may also be possible to tell if a stove was a cook stove or heating stove. Even when pieces of an actual stove are not present, pieces of stove pipe may reveal that one was there and where it was located. Ash and coal cinders are other indicators.

Hardware - Hardware is a very diverse artifact category that must be handled on an item by item basis. Artifacts in this category include all sorts of tools, equipment, and fasteners. Frequently pieces of a larger item are found which cannot be identified from what is left. Sometimes a single item will be very informative. The best that can be done is to describe hardware artifacts as well as possible. If the function of an item is unknown to you, photograph or draw it. It is usually possible to tell if something is hand or machine made. On machine made items, look for casting marks. These will usually be numbers but occasionally are manufacturer's marks, patent dates, or names.

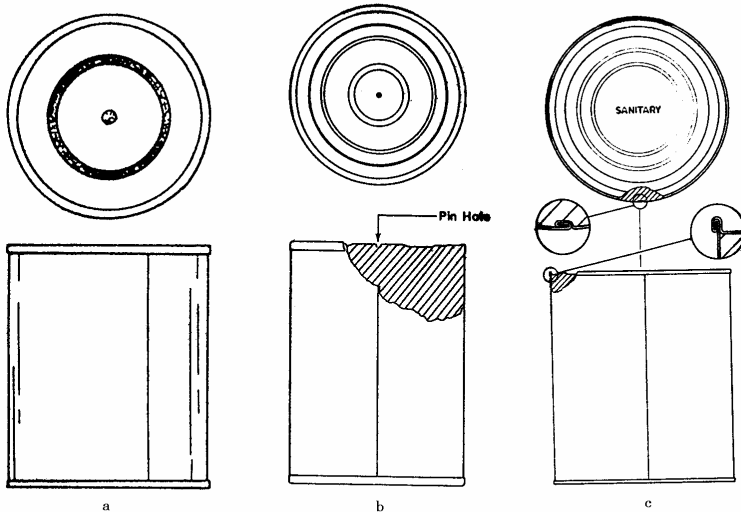
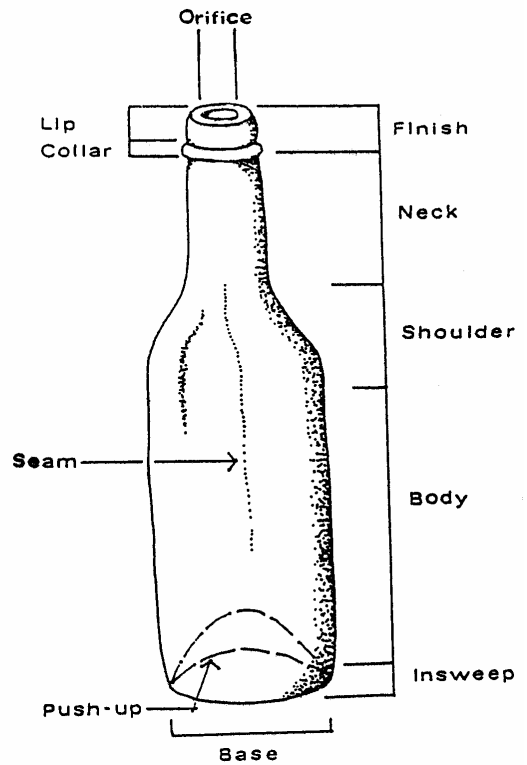
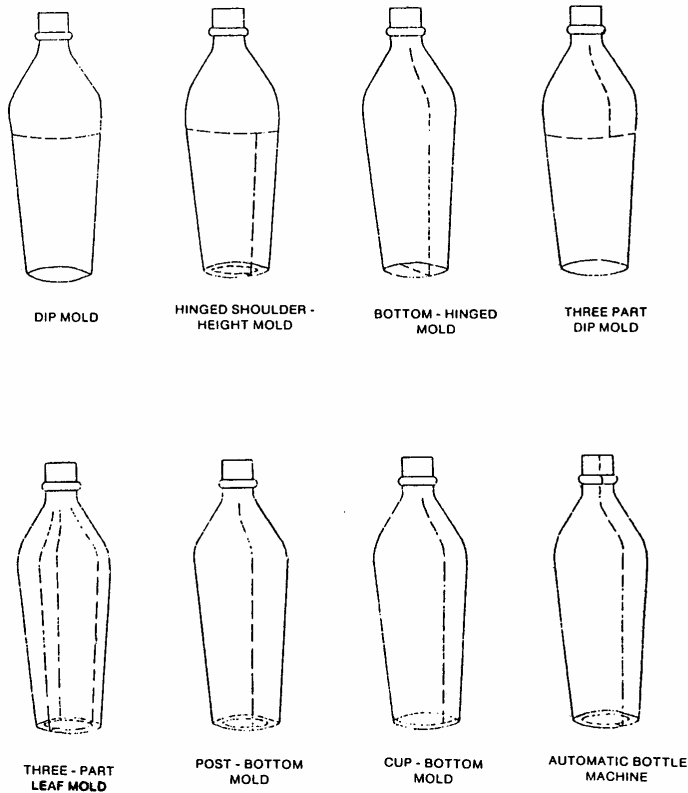

Can Types. a, hole-in-cap; b, hole-in-top; and c, sanitary (modern style).

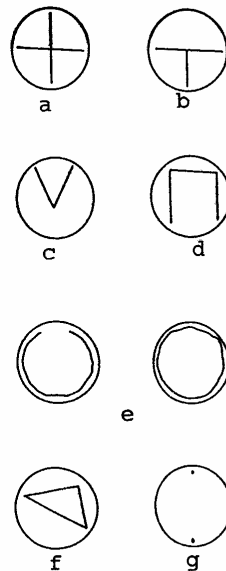

Can Opening Styles. a, X-cut; b, T-cut; c, V-cut; d, square cut; e, cut all around; f, irregular opening; and g, two punched holes.

Bottle seams indicative of mold type, bottle nomenclature, can types, and can opening styles.

DATING KEY FOR POST 18th CENTURY BOTTLES

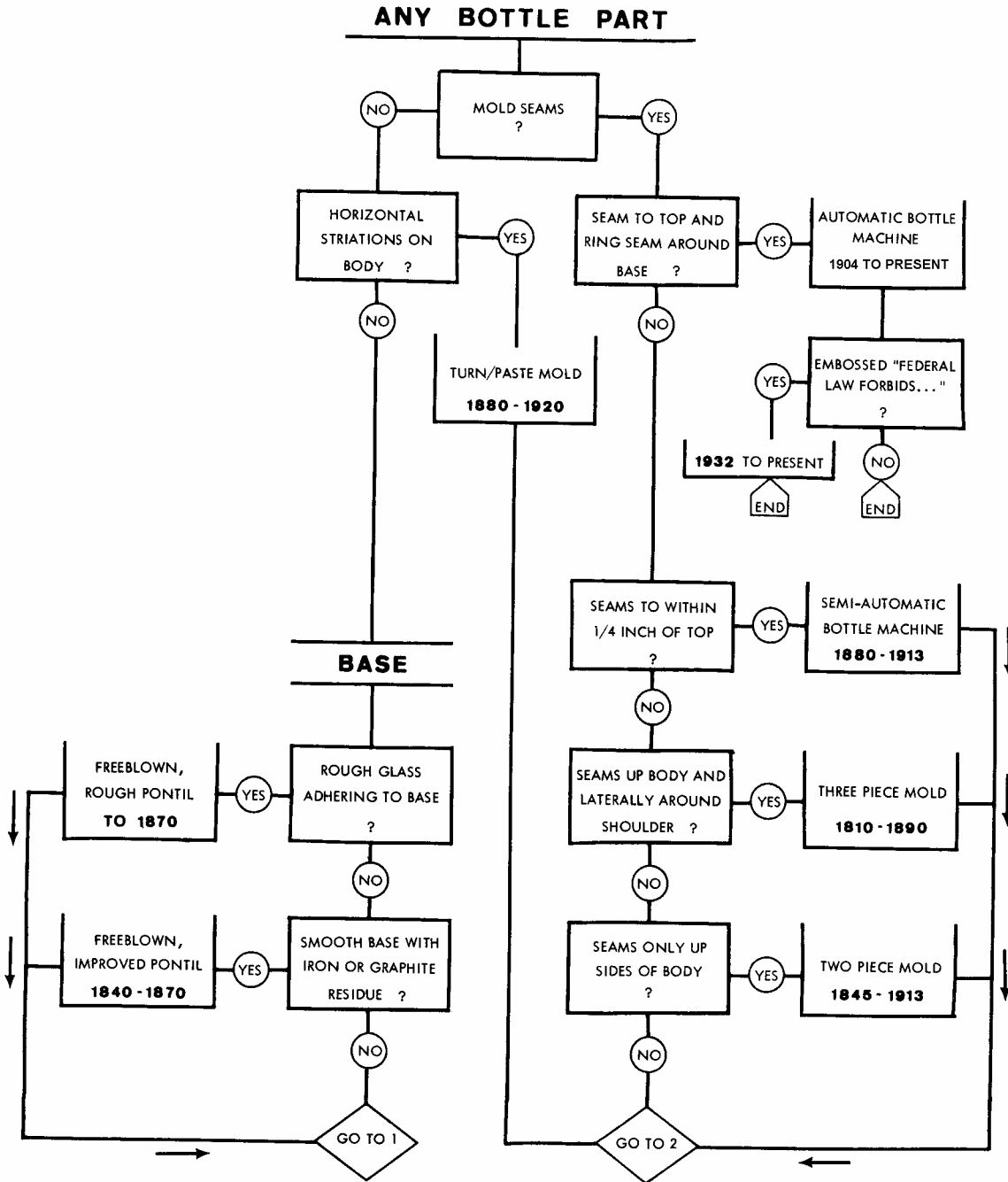

Dating key for bottles from D. Stell Newman, 1970, A Dating Key for Post-Eighteenth Century Bottles. *Historical Archaeology* 4:72-75.

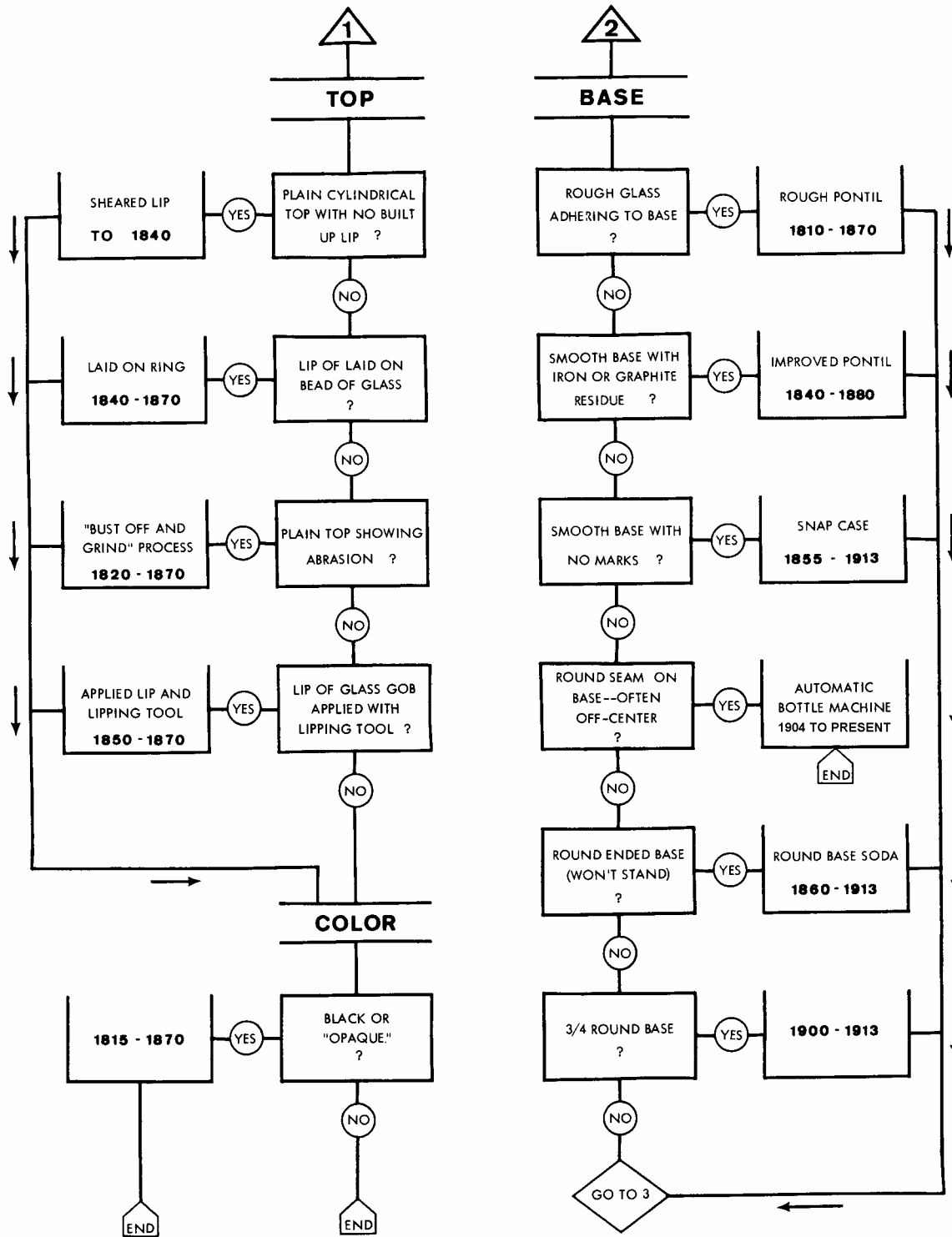

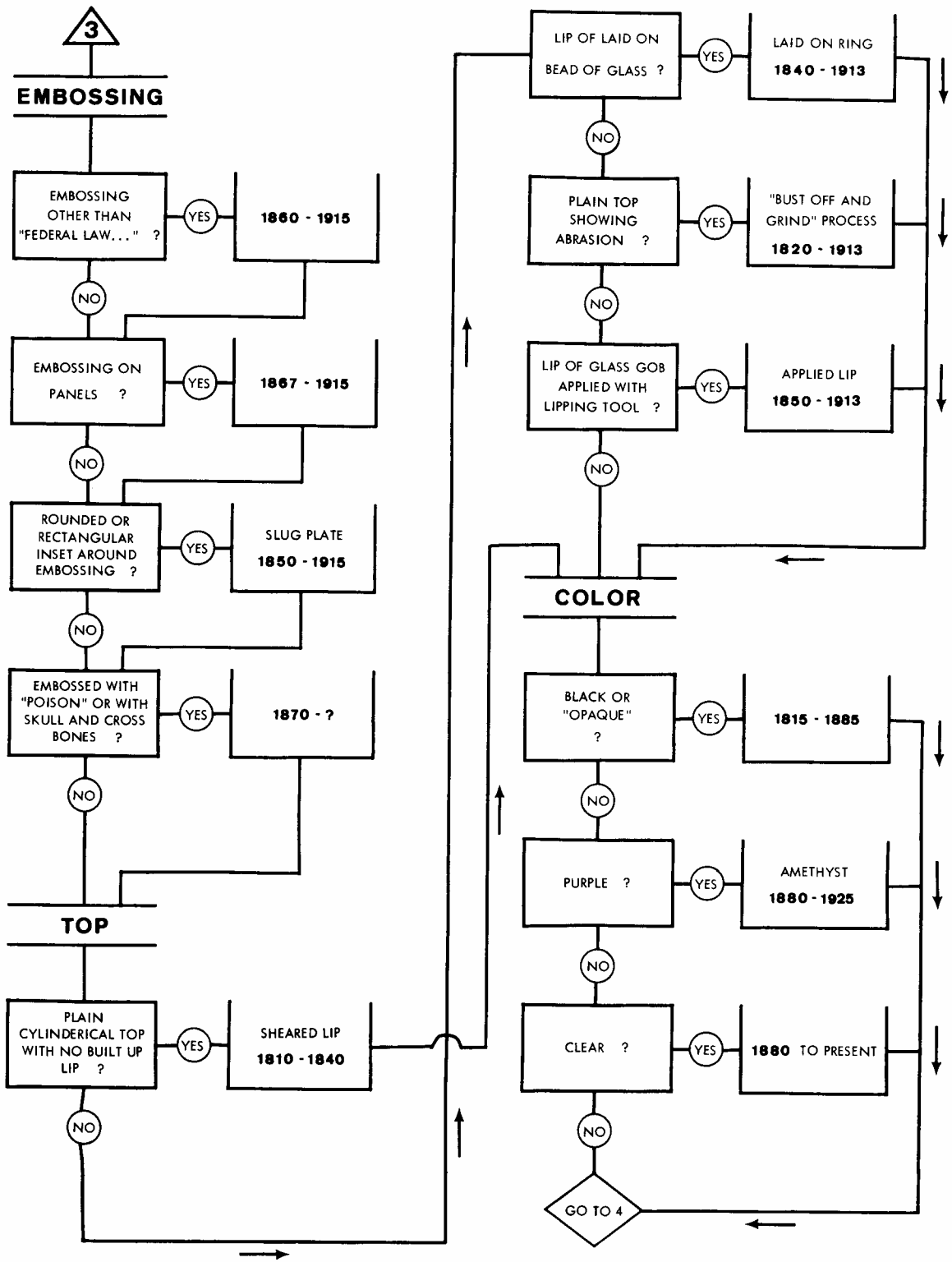

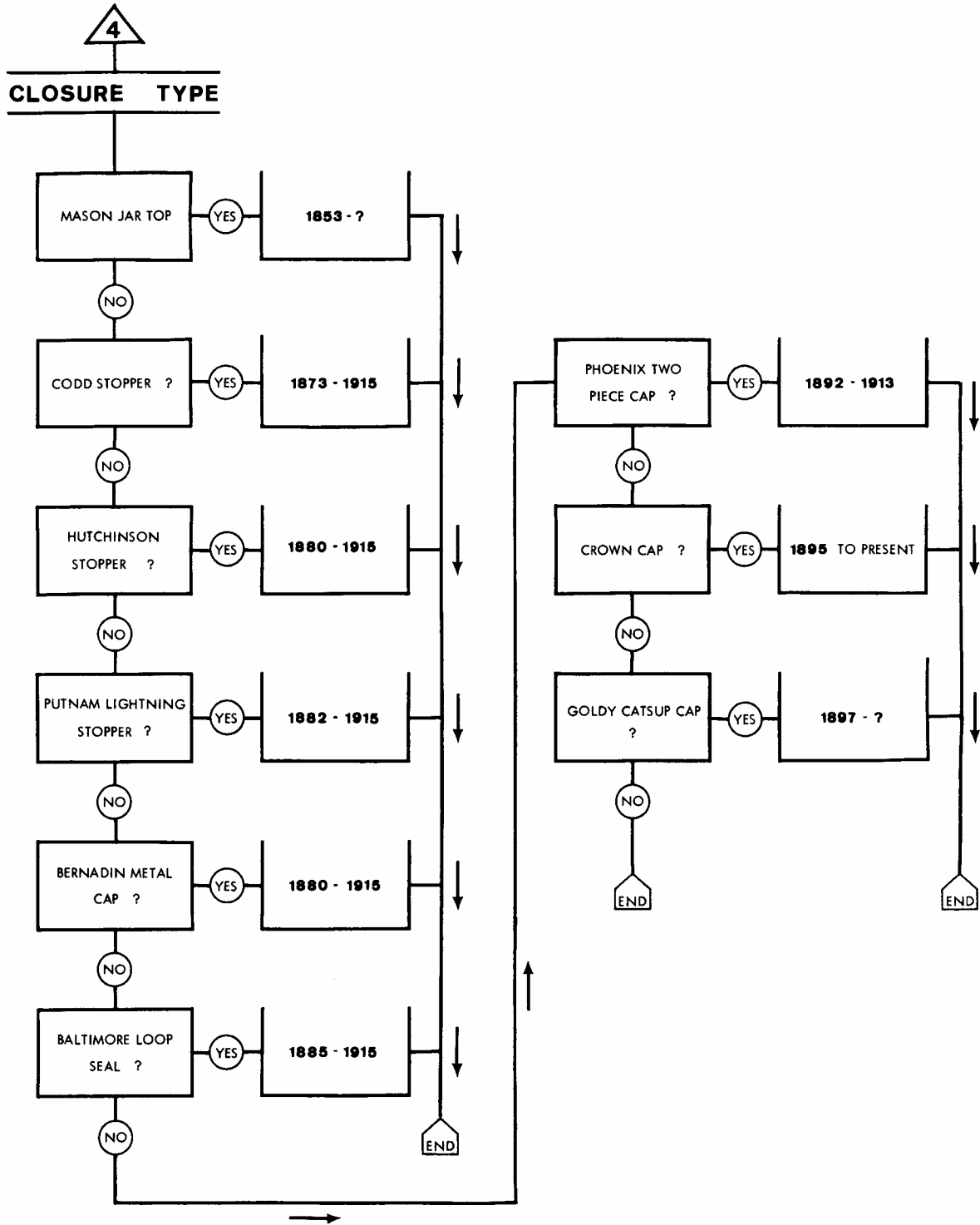

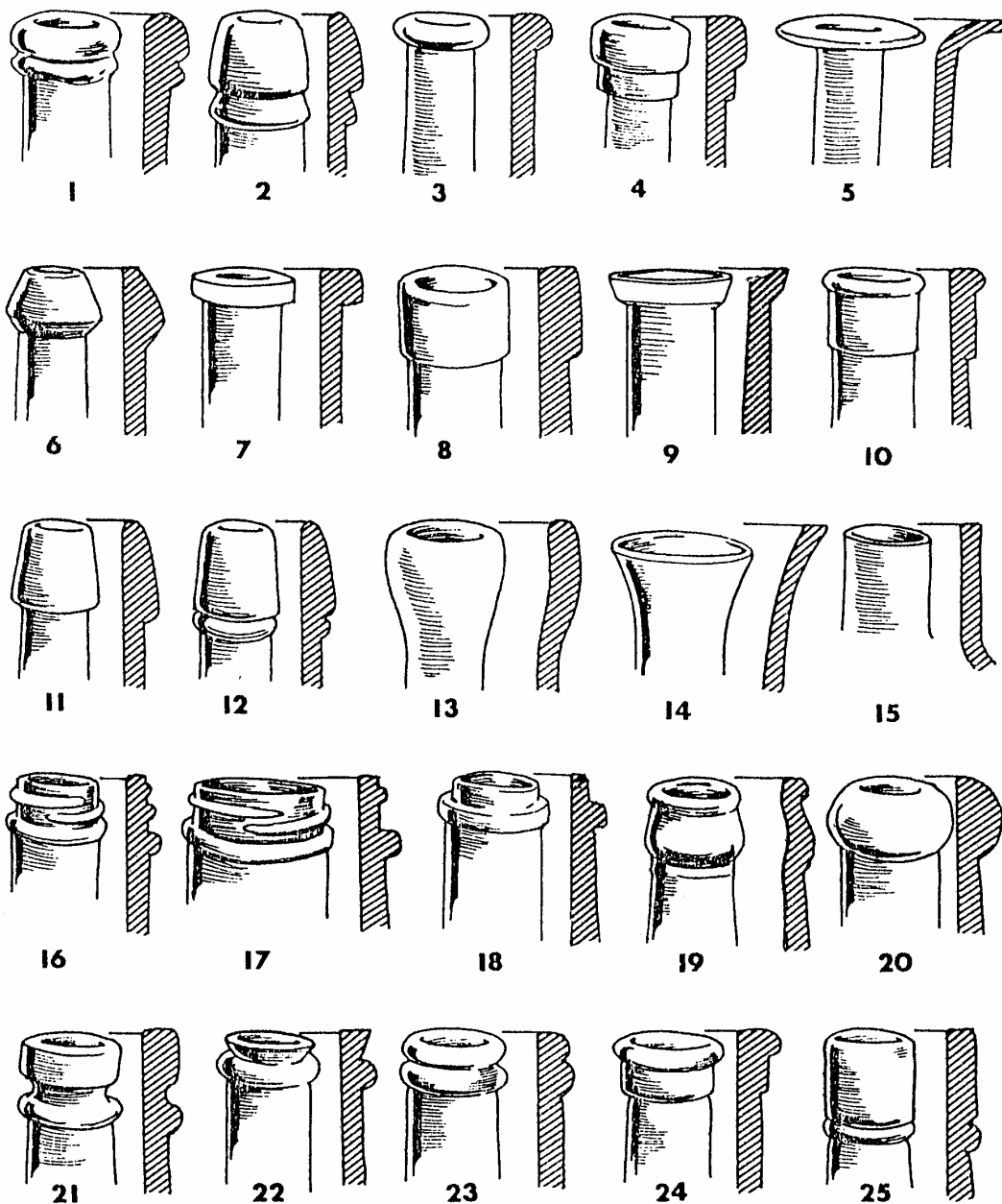

NECK FINISHES: 1 DOUBLE RING; 2 DOUBLE OIL OR MINERAL; 3 BEAD; 4 STOVE PIPE; 5 WIDE PRESCRIPTION; 6 SHEARED RING (OCCASIONALLY GROUND); 7 FLAT OR PATENT; 8 ENGLISH RING, DEEP LIP OR PACKER; 9 PRESCRIPTION; 10 REINFORCED EXTRACT; 11 RING OR OIL; 12 WINE OR BRANDY; 13 GLOBULAR FLARE; 14 FLARE OR TRUMPET; 15 SHEARED OR BLOW OVER (USUALLY GROUND); 16 SMALL MOUTH EXTERNAL THREAD; 17 WIDE MOUTH EXTERNAL THREAD; 18 CHAMPAGNE; 19 CROWN; 20 BLOB; 21 GROOVED RING; 22 FLARED RING; 23 STACKED RING; 24 COLLARED RING; 25 STRAIGHT BRANDY OR WINE (1911, Cumberland Glass Co. Catalog; Dominion Glass Co. Catalog, n.d.; James, 1967 (1902, Whitall Tatum Glass Co. Catalog Reprint); Lohman, 1972 (1904, Whitney Glass Co. Catalog Reprint); Putnam, 1965 (1911, Illinois Glass Co. Catalog Reprint); 1880 Whitall Tatum Glass Co. Catalog).

IMACS USERS GUIDE/April 1984

Bottle neck finishes from: Fike, Richard E.

1987 *The Bottle Book: A Comprehensive Guide to Historic, Embossed Medicine Bottles.*
Peregrine Smith Books, Salt Lake City.

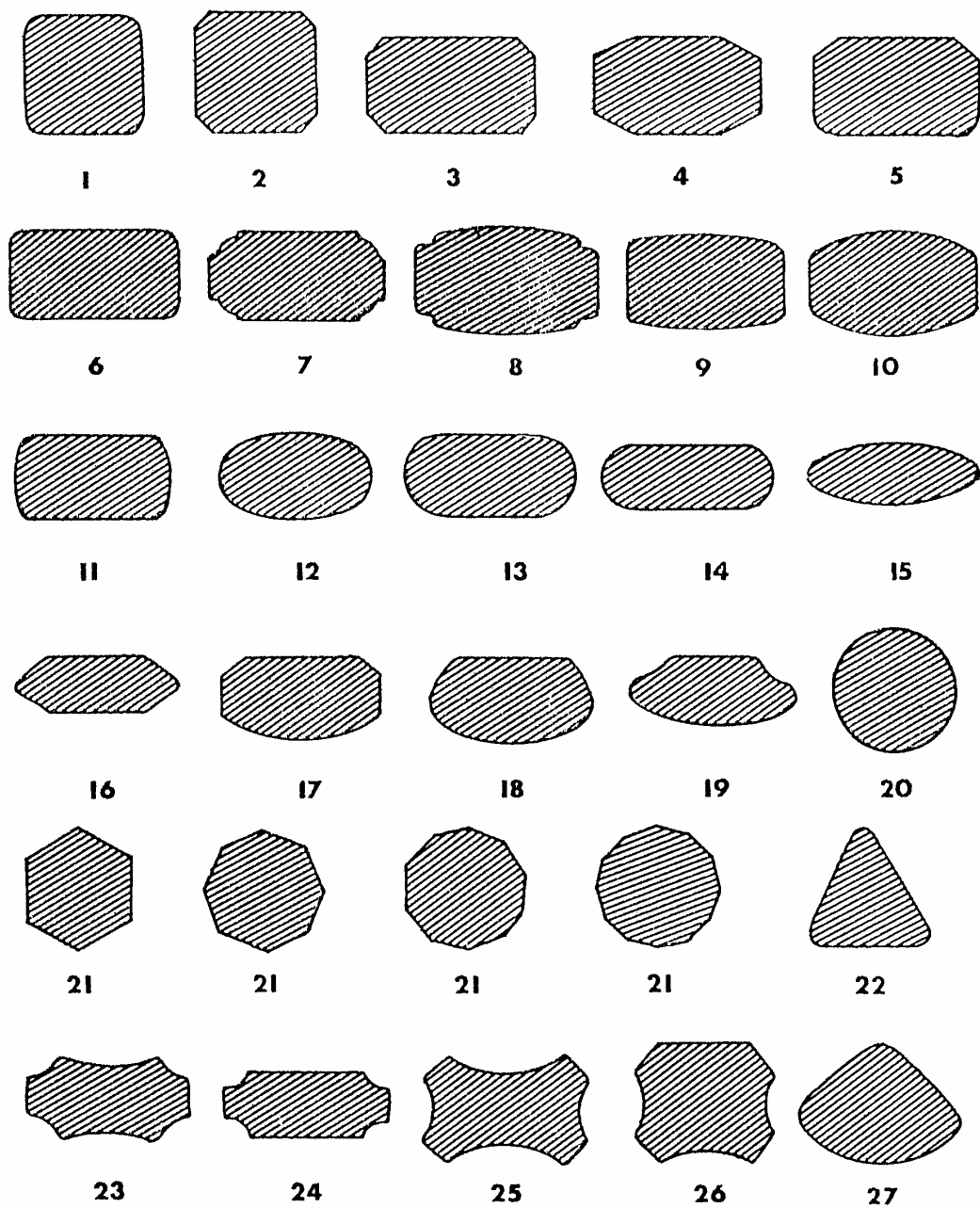

BASE PROFILES: 1 HOPKINS SQUARE; 2 FRENCH SQUARE; 3 BLAKE (VARIANT 1); 4 BLAKE (VARIANT 2); 5 BEVELED IDEAL; 6 EXCELSIOR, WINDSOR OVAL OR ROUND CORNERED BLAKE; 7 OBLONG PRESCRIPTION; 8 UNION OVAL; 9 CROWN OVAL; 10 SALAMANDER OVAL; 11 MONARCH OR ERIE OVAL; 12 PLAIN OVAL; 13 ELIXIR OR HANDY; 14 SLENDER HANDY; 15 OVAL; 16 IRREGULAR POLYGON; 17 HUB OR GOLDEN GATE OVAL; 18 BUFFALO OR PHILADELPHIA OVAL; 19 CLAMSHELL; 20 ROUND; 21 POLYGON; 22 TRIANGLE; 23 FLUTED OBLONG (VARIANT 1); 24 FLUTED OBLONG (VARIANT 2); 25 CONCAVE; 26 FLUTED SQUARE; 27 SPHERICAL TRIANGLE (Berge, 1980; Dominion Glass Co. Catalog, n.d.; James, 1967 (1902, Whitall Tatum Glass Co. Catalog Reprint); Putnam, 1965 (1911, Illinois Glass Co. Catalog Reprint.); 1907, Peter Van Schaack & Sons Drug Catalog).

IMACS USERS GUIDE/April 1984

Bottle base shapes from: Fike, Richard E.

1987 *The Bottle Book: A Comprehensive Guide to Historic, Embossed Medicine Bottles.*
Peregrine Smith Books, Salt Lake City.

CHRONOLOGY OF STYLISTIC DEVELOPMENT OF THE BEER CAN

<u>Date</u>	<u>Feature Introduced</u>
1980s	-UPC computer codes standard feature on all cans. -Multiple neck-in chimes present on cans produced in the early years of the decade. -Single, longer neck-in chimes prevalent during latter years of the decade.
1989	-Government alcohol warning labels introduced.
1984	-Straight-sided steel cans cease production.
1983	-Production of ring-pull cans ceases.
1970s	-Production of II-oz., 15-oz., and gallon cans ceases. -UPC computer codes introduced.
1977	-Coors phases out push-button cans.
1975	-American Can Company begins producing push-button cans.
1974-1979	-Cans issued commemorating the U.S. bicentennial.
1972	-Oregon bans the use of ring-pull cans. Push-button can openings introduced by Coors. -Cans with specialized shapes first marketed.
1967	-Tin-free steel (TFS) cans introduced.
1966	-Welded-seam cans introduced. -"Neck-in chime" cans (lid smaller than can body) introduced.
1965	-First "ring-pull" can marketed.
1964	-Continental Can's "U-tab" design introduced. -Tab-tops with "smile" beads introduced. -Gallon cans introduced.
1963	-In January, Schlitz becomes first national brewer to use tab-top cans. By August, 65 brands are available in this design. -First 12-oz. all-aluminum can issued. -Plastic six-pack holder (yoke) introduced.
1962	-First self-opening can ("snap-top" or "tab-top") introduced by Pittsburgh Brewing Company.
1960	-Cones completely phased out by this time.
1950s	-Crowntainers phased out by mid-decade. -Cones largely phased out by mid-decade. -Odd-size cans marketed include 7-, 8-, 10-, II-, 14-, and 15-oz. sizes. -Aluminum lids used on steel-bodied cans. These are often described on can labels as "soft-tops." -Pastels and metallic colors become common features of can labels.
1959	-Coors markets 7-oz. all-aluminum can.
1958	-Primo markets II-oz. paper-labeled, all-aluminum can.
1954	-Schlitz markets the first 16-oz. punch-top can.
1950	-"Internal Revenue Tax Paid" marking removed from can (and bottle) labels, March 30.
1942-1947	-Domestic canned beer production ceased due to World War II. Over 18 million cans of beer produced for military use. -Military beer cans are silver or olive drab in color. -Military cans are not marked "Internal Revenue Tax Paid" but, rather, "Withdrawn Free of Tax for Exportation."
1940	-J-spout cans phased out of production. -Introduction of crowntainer, which replaces the J spout.
1930s	-Most cans feature heavy paint and lacquer, resulting in good label preservation. -The word "beer" is usually as prominent as the brand name, owing to the novelty of having beer in cans. -Opening instructions, usually with illustrations, are included as part of the label (usually near the seam).
1937	-Contents are often described as "contains 12 fluid ounces-same as a bottle." -Cones produced after this date have concave bottoms and long cones ("high-profile"). -J-spout cans introduced.
1935	-Quart-size cones introduced in July. -First can marketed on January 24 in Richmond, Virginia. Eighteen breweries are canning beer by end of year. -Beginning June 28, all cans produced are marked "Internal Revenue Tax Paid." -Cone-top cans first marketed in September. These have flat bottoms and short cones ("low-profile").

Note. It is often difficult (if not impossible) to document the dates when various features are eliminated or removed from use, due primarily to the fact that old stock is frequently utilized after changes have been made. The presence of multiple suppliers (and in some cases, brewery locations) will also result in the simultaneous usage of different styles of cans (i.e., a single brewing company may produce aluminum and crimped-steel cans in different plants).

From: Maxwell, D. B. S.

1993 Beer Cans: A Guide for the Archaeologist. *Historical Archaeology* 27(1):95-113.

BUTTON TYPES

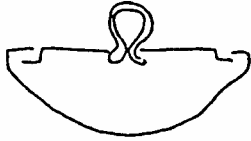

Sanders Shank



Key Shank (glass)
(ca. 1800)



Pinhead Shank
(ca. 1800)



Loop Shank



Loop Shank



Loop Shank



Omega Shank



Alpha Shank



Rosette Shank

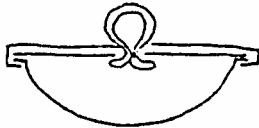

Staff Shank
(1832-1902)



Cone Shank
(1700s-1800s)



Box Shank (4 holes)
(1800s-1900s)



Cut-out Shank (1900s)

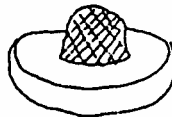

Flexible Shank

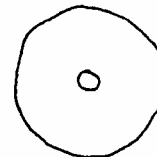

Whistle (ceramic)
(ca. 1875)

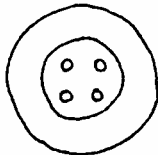

Sew-Through (2-5 holes)



Self Shank (1 piece)
(ca. 1850)

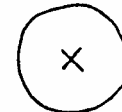

Thread Back
(1820-1900)



Wedge Shank (ca. 1700s)

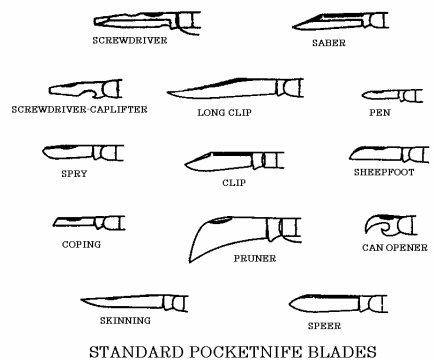
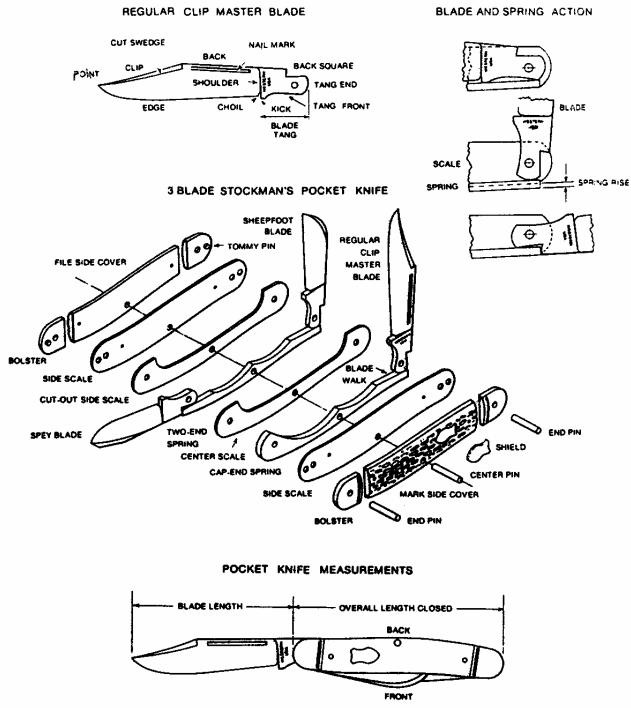

STANDARD POCKETKNIFE BLADES

POCKETKNIFE PATTERNS

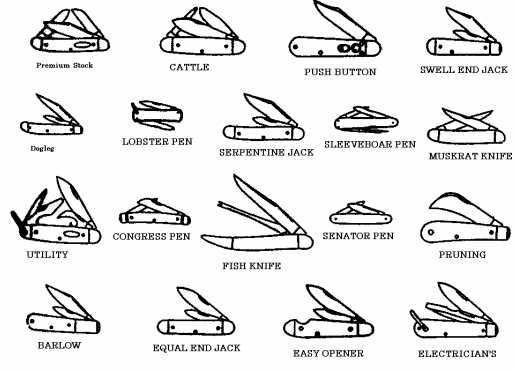

ANIMAL SHOES

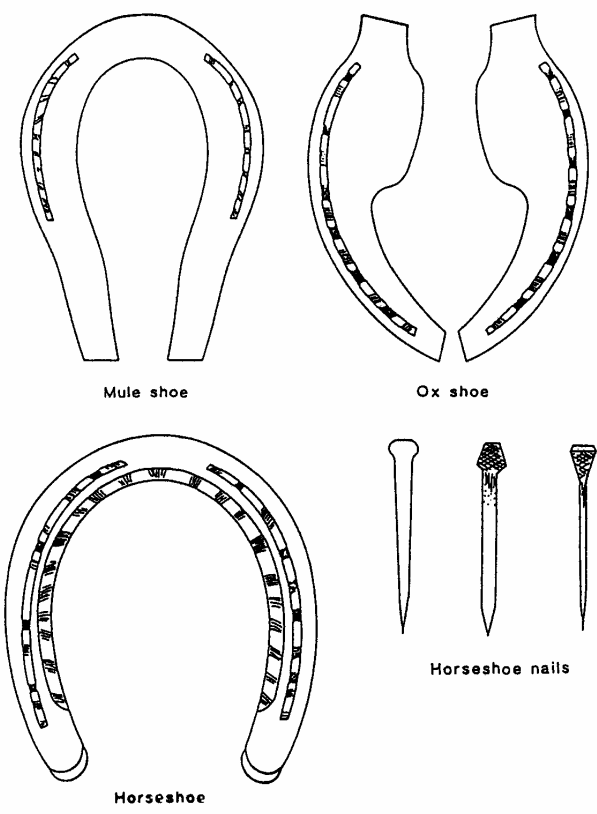

CARTRIDGE TYPES

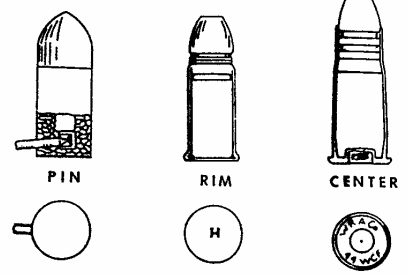

BALE TIES

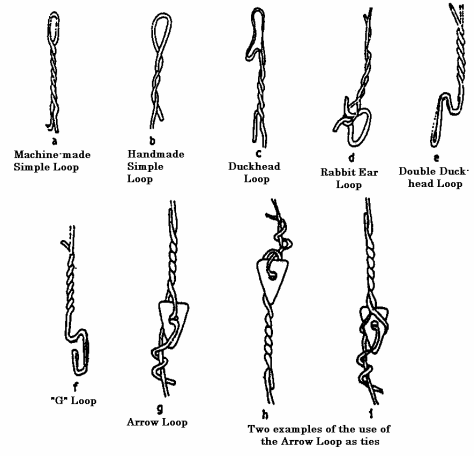

Pocketknives, animal shoes, cartridge types, and bale ties.

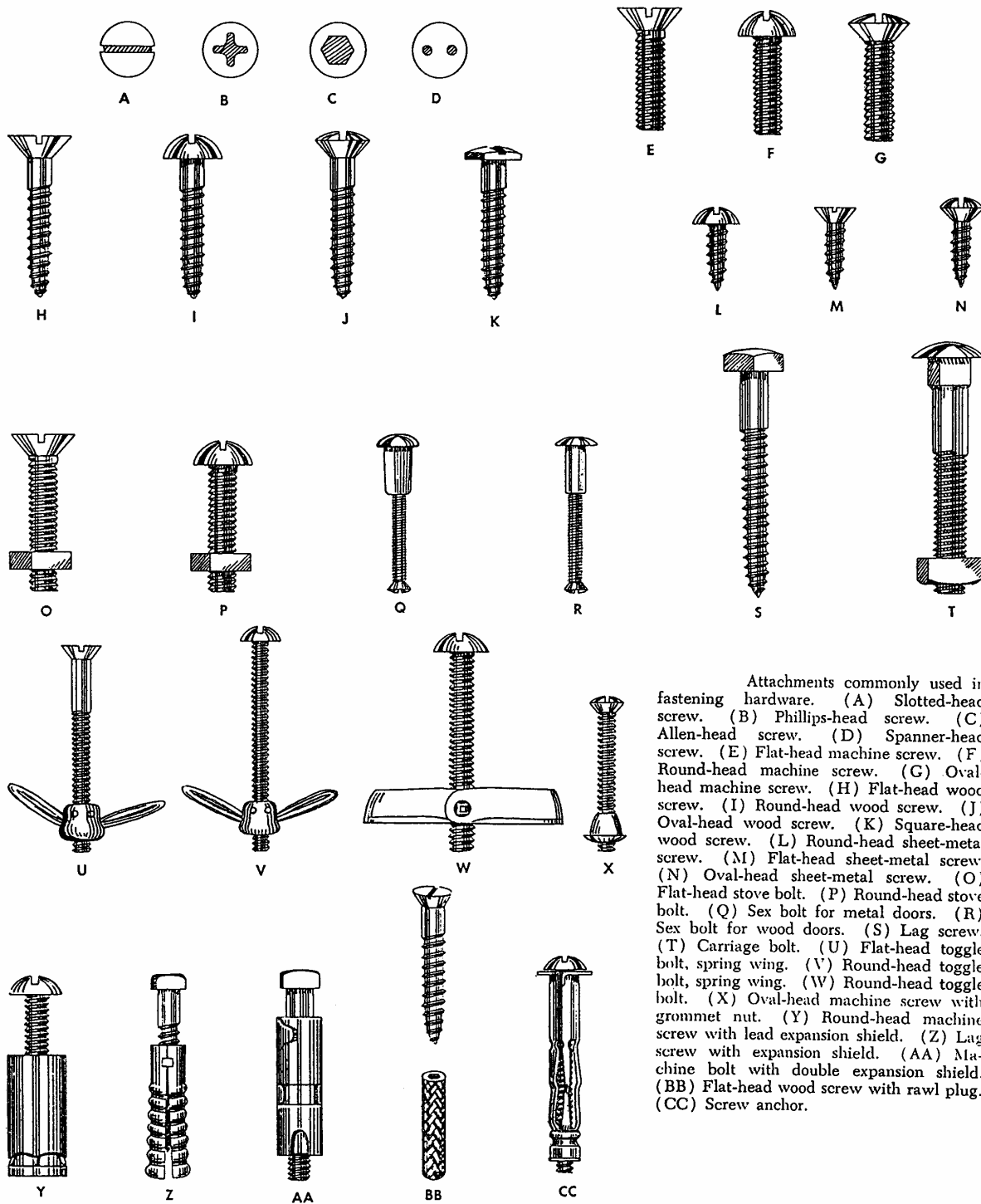

Attachments commonly used in fastening hardware. (A) Slotted-head screw. (B) Phillips-head screw. (C) Allen-head screw. (D) Spanner-head screw. (E) Flat-head machine screw. (F) Round-head machine screw. (G) Oval-head machine screw. (H) Flat-head wood screw. (I) Round-head wood screw. (J) Oval-head wood screw. (K) Square-head wood screw. (L) Round-head sheet-metal screw. (M) Flat-head sheet-metal screw. (N) Oval-head sheet-metal screw. (O) Flat-head stove bolt. (P) Round-head stove bolt. (Q) Sex bolt for metal doors. (R) Sex bolt for wood doors. (S) Lag screw. (T) Carriage bolt. (U) Flat-head toggle bolt, spring wing. (V) Round-head toggle bolt, spring wing. (W) Round-head toggle bolt. (X) Oval-head machine screw with grommet nut. (Y) Round-head machine screw with lead expansion shield. (Z) Lag screw with expansion shield. (AA) Machine bolt with double expansion shield. (BB) Flat-head wood screw with rawl plug. (CC) Screw anchor.

Screw nomenclature from: Brownell, Adon H.

n.d. *Hardware Age Builders' Hardware Handbook*. Chilton Company - Book Division, Publishers, Philadelphia.

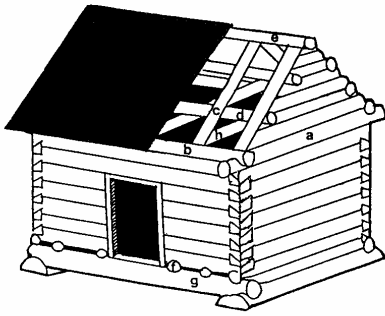

Structural Terminology. a, eave beam; b, plate log; c, rafter; d, purlin; e, ridgepole; f, joist; g, sill log; and h, tie beam.

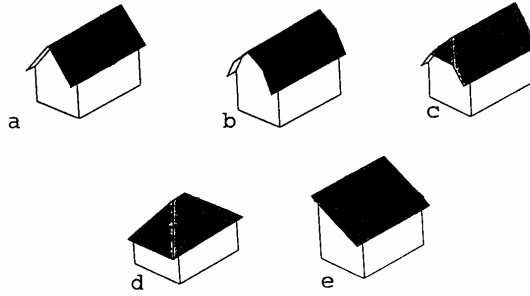

Roof Styles. a, gable roof; b, gambrel roof; c, hip on gable roof; d, hip roof; and e, shed roof.

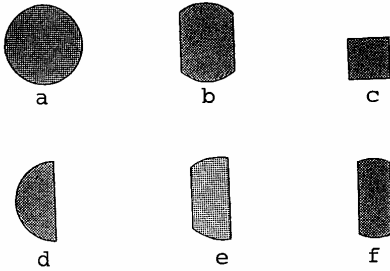

Log Shapes. a, round; b, round hewn; c, square hewn; d, half log; e, hewn half log; and f, planked.

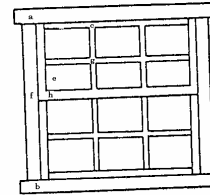

SASH-TYPE WINDOW

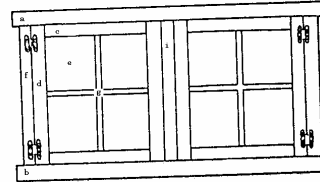

CASEMENT-TYPE WINDOW

Window Terminology. a, head; b, sill; c, rails; d, stiles; e, lights or panes; f, jambs; g, mutins; h, meeting rails; and i, mullion.

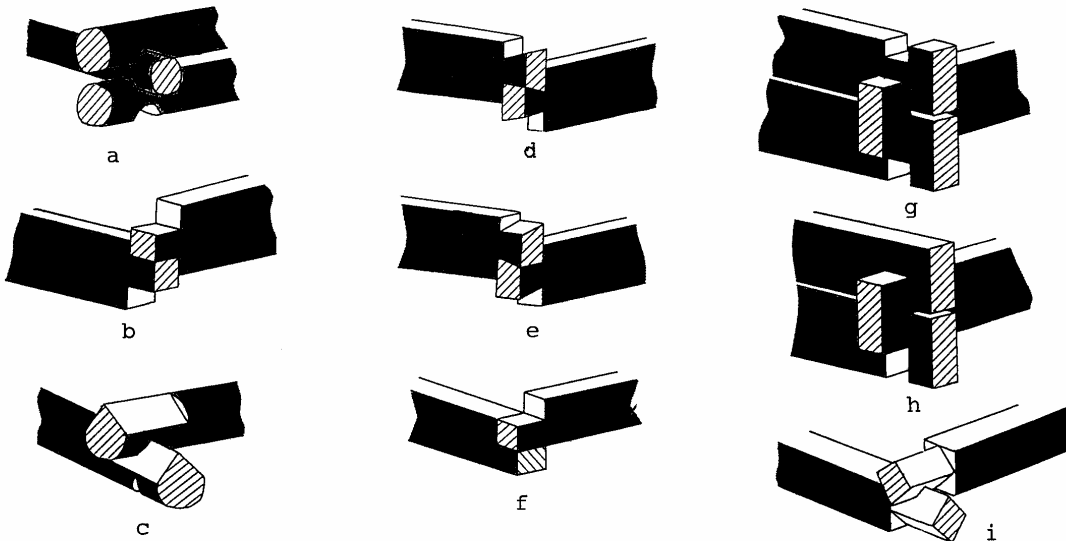

Log Notching Styles. a, saddle; b, square; c, V-notch; d, full dovetail; e, half dovetail; f, half notch; g, double lock; h, single lock; and i, diamond notch.

Cabin and architectural information adapted from: Wilson, Mary
 1984 *Log Cabin Studies, the Rocky Mountain Cabin, Log Cabin Technology and Typology and Log Cabin Bibliography.* U.S. Forest Service, Intermountain Region, Cultural Resource Report No. 9.

TRESTLES

STANDARD PILE BENT

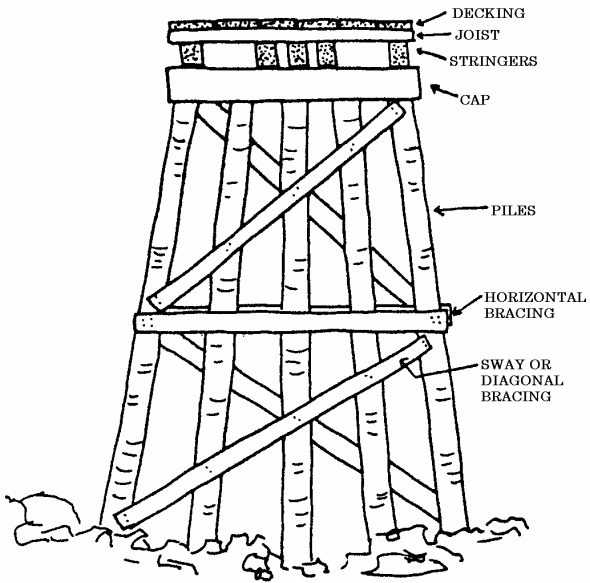

SPAN OF TWO STANDARD BENTS
(SIDE VIEW)

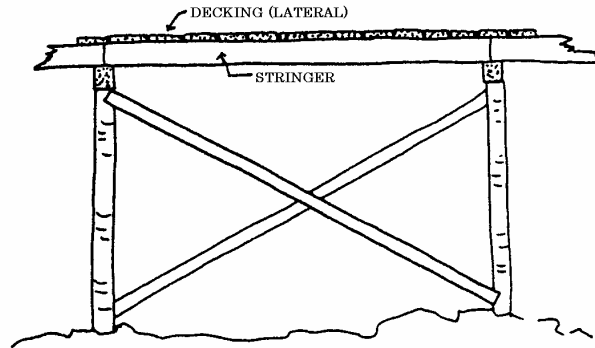
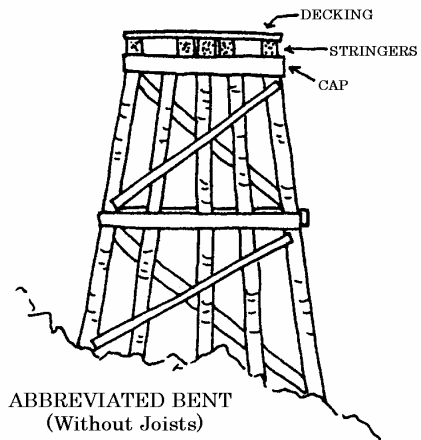
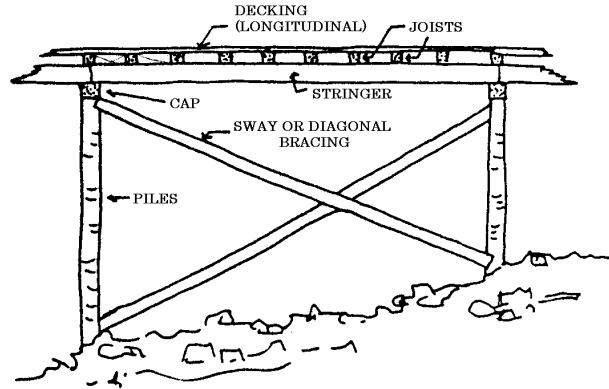

SPAN OF TWO ABBREVIATED BENTS
(Side View)

ARTIFACT IDENTIFICATION BIBLIOGRAPHY

General Classification and Company Histories

Adams, William Hampton

- 2003 Dating Historical Sites: The Importance of Understanding Time Lag in the Acquisition, Curation, Use, and Disposal of Artifacts. *Historical Archaeology* 37(2):38-64.

Blackaby, James R., and Patricia Greeno

- 1988 *The Revised Nomenclature for Museum Cataloging: A Revised and Expanded Version of Robert G. Chenhall's System for Classifying Man-Made Objects*. American Association for State and Local History, Nashville.

Brand Names Foundation, Incorporated

- 1947 *43,000 Years of Public Service: A Roster of Product-identifying Names Used by the American Public for 50 Consecutive Years or More*. Brand Names Foundation, Incorporated, New York.

Chenhall, Robert G.

- 1978 *Nomenclature for Museum Cataloging: A System for Classifying Man-made Objects*. American Association for State and Local History, Nashville.

Clark, Victor S.

- 1929 *History of Manufactures in the United States. Volume II: 1860-1893*. Carnegie Institution of Washington, Washington, D.C. Reprinted 1949 by Peter Smith, New York.

- 1929 *History of Manufactures in the United States. Volume III: 1893-1928*. Carnegie Institution of Washington, Washington, D.C. Reprinted 1949 by Peter Smith, New York.

Cramp, Arthur J.

- 1912 *Nostrums and Quackery*. American Medical Association Press, Chicago.

- 1921 *Nostrums and Quackery, Vol. II*. Press of American Medical Association, Chicago.

- 1936 *Nostrums and Quackery and Pseudo-Medicine, Vol. III*. Press of American Medical Association, Chicago.

Fisher, David, and Reginald Bragonier, Jr.

- 1981 *What's What: A Visual Glossary of the Physical World*. Hammond Incorporated, Maplewood, NJ.

Hambleton, Ronald

- 1987 *The Branding of America: From Levi Strauss to Chrysler, from Westinghouse to Gillette, the Forgotten Founders of America's Best-Known Brand Names*. Yankee Books, Camden, Maine.

Kelley, Etna M.

- 1954 *The Business Founding Date Directory*. Morgan & Morgan Publishers, Scarsdale, New York.

Panati, Charles
1987 *Extraordinary Origins of Everyday Things*. Harper & Row, Publishers, New York.

Periodical Publishers Association
1934 *Nationally Established Trade-Marks*. Periodical Publishers Association, New York.

Riley, John J.
1958 *A History of the American Soft Drink Industry: Bottled Carbonated Beverages, 1807-1957*. American Bottlers of Carbonated Beverages, Washington, D.C. Reprinted 1972 by Arno Press, New York.

Multiple Artifacts

Adams, William H.
1977 *Silcott, Washington: Ethnoarchaeology of a Rural American Community*. Reports of Investigations, No. 54. Laboratory of Anthropology, Washington State University, Pullman.

Adams, William H., Linda P. Gaw, and Frank C. Leonhardy
1975 *Archaeological Excavations at Silcott, Washington: the Data Inventory*. Reports of Investigations, No. 53. Laboratory of Anthropology, Washington State University, Pullman.

Berge, Dale L.
1980 *Simpson Springs Station: Historical Archaeology in Western Utah, 1974-1975*. Bureau of Land Management, Utah, Cultural Resource Series No. 6.

Gillio, David, Francis Levine, and Douglas Scott
1980 Some Common Artifacts Found at Historical Sites. *Cultural Resources Report* No. 31. USDA Forest Service, Southwest Region, Albuquerque, New Mexico.

Herskovitz, Robert M.
1978 *Fort Bowie Material Culture*. Anthropological Papers of the University of Arizona No. 31. Tucson.

Kovel, Ralph M., and Terry H. Kovel
1986 *Kovel's New Dictionary of Marks*. Crown Publishers, New York.

Lichty, Alan S., and Joel D. McNamara
1984 IMACS Users Guide. Intermountain Antiquities Computer System, revised edition.

Montgomery Ward & Company
1895 *Montgomery Ward & Co. Catalogue and Buyers' Guide No. 57, Spring and Summer 1895*. Reprint 1969 by Dover Publications, New York.

1894-5 *Montgomery Ward & Co. 1894-95 Catalogue & Buyers Guide No. 56*. Reprint 1977 by DBI Books, Inc., Northfield, Illinois.

Noël Hume, Ivor
1970 *A Guide to Artifacts of Colonial America*. Alfred A. Knopf, New York.

- Petsche, Jerome E.
 1974 *The Steamboat Bertrand: History, Excavation, and Architecture*. National Park Service Publications in Archeology 11. GPO, Washington.
- Russell, Carl P.
 1967 *Firearms, Traps & Tools of the Mountain Men*. Alfred A. Knopf, New York.
- Sagstetter, Beth, and Bill Sagstetter
 1998 *The Mining Camps Speak: A New Way to Explore the Ghost Towns of the American West*. Benchmark Publishing of Colorado, Denver.
- Sears, Roebuck and Co.
 1894 *Sears, Roebuck and Co. Consumer's Guide for 1894*. Reprint edition.
 1902 *The 1902 Edition of the Sears, Roebuck Catalog, No. 111*. Reprinted 1969 by Bounty Books, New York.
 1908 *Sears, Roebuck and Company 1908 Catalogue, No. 117, The Great Price Maker*. Reprinted by Gun Digest Co., Chicago.
 1909 *Sears, Roebuck and Co., Incorporated Consumers Guide, Fall 1909, No. 118*. Reprinted by Ventura Books, Inc., New York, 1979.
 1915 *Tools, Machinery, Blacksmiths' Supplies*. Sears, Roebuck and Co., Chicago. Reprinted 1985 by the Mid-West Tool Collectors Association and the Artist Blacksmith's Association of North America, n.p.
- Richardson, M. T.
 1998 *Practical Blacksmithing*. 2 Vols. Astragal Press, Mendham, New Jersey.

Agriculture

- Baird, James S.
 1994 *Hoard's Dairyman Dairy Collectibles: A Pictorial Guide to Collecting and Identifying Items Related to Dairying*. W. D. Hoard & Sons Company, Atkinson, Wisconsin.
- Hurt, R. Douglas
 1982 *American Farm Tools from Hand-Power to Steam-Power*. Sunflower University Press, Manhattan, Kansas.
- Montgomery Ward & Company
 1908 *Farm Implements*. Montgomery Ward & Co., Chicago.
- Rathbone, Pembroke Thom
 1999 *The History of Old Time Farm Implement Companies and the Wrenches They Issued Including Buggy, Silo, Cream Separator, Windmill and Gas Engine Companies*. Pembroke Thom Rathbone, Marsing, Idaho.
 1999 *The History of Old Time Farm Implement Companies and the Wrenches They Issued Including Buggy, Silo, Cream Separator, Windmill and Gas Engine Companies Supplement*. Pembroke Thom Rathbone, Marsing, Idaho.

Wendel, C. H.
1997 *Encyclopedia of American Farm Implements & Antiques*. Krause Publications, Iola, Wisconsin.

Arms and Ammunition

Barnes, Frank C.
1993 *Cartridges of the World*. DBI Books, Inc., Northbrook, IL.

Bearse, Ray
1966 *Centerfire American Rifle Cartridges 1892-1963*. A. S. Barnes and Co., Inc., South Brunswick, New Jersey.

Brinckerhoff, Sidney B. and P. A. Chamberlain
1972 *Spanish Military Weapons in Colonial America: 1700-1821*. Stackpole Books, Harrisburg, Pennsylvania.

Datig, Fred A.
1956 *Cartridges for Collectors, Vol. I (Centerfire)*. FADCO Publishing Co., Beverly Hills, California.

1958 *Cartridges for Collectors, Vol. II*. FADCO Publishing Co., Beverly Hills, California.

Kass, George G., editor
1979 *Rimfire Headstamp Guide: Part I*. George G. Kass, Okemos, Michigan.

Logan, Herschel C.
1959 *Cartridges: A Pictorial Digest of Small Arms Ammunition*. Bonanza Books, New York.

Murtz, Harold A., editor
1993 *The Gun Digest Book of Exploded Long Gun Drawings*. DBI Books, Inc., Northbrook, Illinois.

Russell, Carl P.
1957 *Guns on the Early Frontiers: A History of Firearms from Colonial Times through the Years of the Western Fur Trade*. University of Nebraska Press, Lincoln.

Barbed Wire

Clifton, Robert T.
1970 *Barbs, Prongs, Points, Prickers & Stickers: A Complete and Illustrated Catalogue of Antique Barbed Wire*. University of Oklahoma Press, Norman.

Glover, Jack
1969 *The "Bobbed" Wire Bible*. Jack Glover, Sunset, Texas.

Bottles

Baldwin, Joseph K.
1973 *A Collector's Guide to Patent and Proprietary Medicine Bottles of the Nineteenth Century*. Thomas Nelson, Inc., New York.

- Clint, David K.
1976 *Colorado Historical Bottles & ETC., 1859-1915*. Johnson Publishing Company, Boulder, Colorado.
- Clorox Company, The
1999 *The Clorox Bottle Guide: An Aid for Collectors*. The Clorox Company (<http://www.clorox.com/company/bottlguide/>). January 6, 2000.
- Coors, Adolph, Company
1984 *Time in a Bottle*. Adolph Coors Company, Golden, Colorado.
- Devner, Kay
1968 *Patent Medicine Picture*. The Tombstone Epitaph, Tombstone, Arizona.
- Fike, Richard E.
1987 *The Bottle Book: A Comprehensive Guide to Historic, Embossed Medicine Bottles*. Peregrine Smith Books, Salt Lake City.
- Fountain, John C., and Donald E. Colcleaser
1968 *Dictionary of Soda and Mineral Water Bottles*. Ole Empty Bottle House Publishing Co., Amador City, California.

1969 *Dictionary of Spirits and Whiskey Bottles*. Ole Empty Bottle House Publishing Company, Amador City, California.
- Howe, John
1967 *A Whiskeyana Guide: Antique Whiskey Bottles*. John Howe, San Jose, California.
- James, D.
1967 *Whitall, Tatum and Company, Drug, Perfume and Chemical Bottles, 1902*. Reprint of historic catalog, n.p.
- Jones, Olive
1971 Glass Bottle Push-Ups and Pontil Marks. *Historical Archaeology* 5:62-73.
- Kovel, Ralph M., and Terry H. Kovel
1971 *The Official Bottle Price List*. Crown Publishers, Inc., New York.
- Lief, Alfred
1965 *A Close-Up of Closures: History and Progress*. Glass Manufacturers Institute, New York.
- Lorrain, Dessamae
1968 An Archaeologist's Guide to Nineteenth Century American Glass. *Historical Archaeology* 2:35-44.
- Miller, George L., and Catherine Sullivan
1984 Machine-Made Glass Containers and the End of Production for Mouth-Blown Bottles. *Historical Archaeology* 18(2):83-96.
- Peterson, Arthur G.
1968 *400 Trademarks on Glass*. Washington College Press, Takoma Park, Maryland.

- Rock, Jim
1981 *Glass Bottles: Basic Identification.* USDA, Klamath National Forest, Yreka, California.
- Schulz, Peter D., Betty J. Rivers, Mark M. Hales, Charles A. Litzinger, and Elizabeth A. McKee
1980 *The Bottles of Old Sacramento: A Study of Nineteenth Century Glass and Ceramic Retail Containers, Part I.* California Archeological Reports No. 20. State of California, Department of Parks and Recreation, Sacramento.
- Seamans, Berna Mackey, and Mertie Mackey Robb
1969 *Colorado Bottle History: When and Where?* R & S Publication, Denver.
- Switzer, Ronald R.
1974 *The Bertrand Bottles: A Study of 19th-Century Glass and Ceramic Containers.* National Park Service Publications in Archeology No. 12. GPO, Washington.
- Toulouse, Julian Harrison
1971 *Bottle Makers and Their Marks.* Thomas Nelson Inc., New York.
- 1977 *Fruit Jars: A Collector's Manual with Prices.* Thomas Nelson Inc., Publishers, Nashville, Tennessee.
- Watson, Richard
1965 *Bitters Bottles.* Thomas Nelson and Sons, New York.
- White, James Seeley
1974 *The Hedden's Store Handbook of Proprietary Medicines.* Durham & Downey, Portland, Oregon.
- Wilson, Bill, and Betty Wilson
1968 *Spirits Bottles of the Old West.* Henington Publishing Company, Wolfe City, TX.
- Wilson, Rex L.
1981 *Bottles on the Western Frontier.* The University of Arizona Press, Tucson.
- Zumwalt, Betty
1980 *Ketchup, Pickles, Sauces: 19th Century Food in Glass.* Mark West Publishers, Fulton, California.

Buttons

- Adams, Jane Ford, and Lillian Smith Albert
1965 *A Descriptive Catalog of Pictorial Buttons Worn on Work Clothing 1900-1935.* Sullivan Lithographics, Wichita, Kansas.
- Brown, Dorothy Foster
1968 *The New Enlarged and Revised Button Parade.* Mid-America Book Company, Leon, Iowa.
- Century House
1959 *Military Uniforms and Their Buttons.* Century House, Watkins Glen, New York.

Houart, Victor

1977 *Buttons: A Collector's Guide*. Charles Scribner's Sons, New York.

Johnson, David F.

1948 *Uniform Buttons: American Armed Forces 1784-1948, Vol. I: Descriptions & Value*. Century House, Watkins Glen, New York.

1959 *Uniform Buttons: American Armed Forces 1784-1948, Vol. II*. Century House, Watkins Glen, New York.

Quartermaster General, U.S. Army

1889 *U.S. Army Uniforms and Equipment, 1889 Specifications for Clothing, Camp and Garrison Equipage, and Clothing and Equipage Materials*. Reprinted 1986, University of Nebraska Press, Lincoln.

Sprague, Roderick

2002 China or Prosser Button Identification and Dating. *Historical Archaeology* 36(2):111-127.

Cans

Beer Can Collectors of America

1975 *The Beer Can Collectors of America Guide to United States Beer Cans*. Greatlakes Living Press, Matteson, Illinois.

Maxwell, D. B. S.

1993 Beer Cans: A Guide for the Archaeologist. *Historical Archaeology* 27(1):95-113.

May, Earl Chapin

1937 *The Canning Clan: A Pageant of Pioneering Americans*. The Macmillan Company, New York.

Rock, Jim

1981 *Tin Cans, Notes and Comments*. USDA, Klamath National Forest, Yreka, California.

1984 Cans in the Countryside. *Historical Archaeology* 18(2):97-111.

Ceramics

Barber, Edwin Atlee

1904 *Marks of American Potters*. Patterson & White Company, Philadelphia.

Butler Brothers

1930 *China & Glassware 1930*. 1968 reprint of Butler Brothers Catalog #2749. Antique Research Publications, Chattanooga, Tennessee.

Chaffers, William

1946 *Marks & Monograms on European and Oriental Pottery and Porcelain*. Borden Publishing Company, London.

Cushion, J. P.

1961 *Pocket Book of German Ceramic Marks and Those of Other Central European Countries*. Faber and Faber, London.

- Gates, William C., Jr., and Dana E. Ormerod
 1984 *The East Liverpool Pottery District: Identification of Manufacturers and Marks. Historical Archaeology* 16(1-2).
- Godden, Geoffrey A.
 1991 *Encyclopaedia of British Pottery and Porcelain Marks*. Barrie & Jenkins, London.
- Kovel, Ralph M., and Terry H. Kovel
 1953 *Dictionary of Marks, Pottery and Porcelain*. Crown Publishers, Inc., New York.
- Kowalsky, Arnold A., and Dorothy E. Kowalsky
 1999 *Encyclopedia of Marks on American, English, and European Earthenware, Ironstone, and Stoneware (1780-1980): Makers, Marks, and Patterns in Blue and White, Historic Blue, Flow Blue, Mulberry, Romantic Transferware, Tea Leaf, and White Ironstone*. Schiffer Publishing Ltd., Atglen, Pennsylvania.
- Lehner, Lois
 1978 *Ohio Pottery and Glass Marks and Manufacturers*. Wallace Homestead Book Co., Des Moines, Iowa.
- 1980 *Complete Book of American Kitchen and Dinner Ware*. Wallace-Homestead Book Company, Des Moines, Iowa.
- 1988 *Lehner's Encyclopedia of U.S. Marks on Pottery, Porcelain & Clay*. Collector Books, Paducah, Kentucky.
- McKee, Floyd W.
 1966 *The Second Oldest Profession: A Century of American Dinnerware Manufacture*. Privately published, n.p.
- Ramsey, John
 1939 *American Potters and Pottery*. Colonial Press Inc., Clinton, Massachusetts.
- Thorn, C. Jordan
 1947 *Handbook of Old Pottery and Porcelain Marks*. Tudor Publishing Company, New York.
- Weatherbee, Jean
 1980 *A Look at White Ironstone*. Wallace Homestead Book Company, Des Moines, Iowa.

Glassware

- Florence, Gene
 1986 *Elegant Glassware of the Depression Era*. Collector Books, Paducah, Kentucky.
- 1987 *Kitchen Glassware of the Depression Years*. Collector Books, Paducah, Kentucky.
- 1989 *Pocket Guide to Depression Glass, Revised Sixth Edition*. Collector Books, Paducah, Kentucky.
- 1998 *Florence's Glassware Pattern Identification Guide*. Collector Books, Paducah, Kentucky.

2000 *Florence's Glassware Pattern Identification Guide, Volume II.* Collector Books, Paducah, Kentucky.

Lee, Ruth Webb

1936 *Ruth Webb Lee's Handbook of Early American Pressed Glass Patterns.* Ruth Webb Lee, Publisher, Framingham Centre, Massachusetts.

Mauzy, Barbara and Jim Mauzy

2001 *Mauzy's Comprehensive Handbook of Depression Glass Prices, 3rd Edition.* Schiffer Publishing Ltd., Atglen, Pennsylvania.

McKearin, George S., and Helen McKearin

1941 *American Glass.* Crown Publishers, New York.

Revi, Albert Christian

1964 *American Pressed Glass and Figure Bottles.* Thomas Nelson Inc., New York.

Hardware

Adams, William Hampton

2002 Machine Cut Nails and Wire Nails: American Production and Use for Dating 19th-Century and Early-20th-Century Sites. *Historical Archaeology* 36(4):66-88.

Barnes, Frank T.

1988 *Hooks, Rings & Other Things: An Illustrated Index of New England Iron, 1660-1860.* The Christopher Publishing House, Hanover, Massachusetts.

D'Allemagne, Henry Rene

1968 *Decorative Antique Ironwork: A Pictorial Treasury.* Dover Publications, Inc., New ork.

Eastwood, Maudie

1976 *The Antique Doorknob.* Times Litho, Forest Grove, Oregon.

Forney, Matthias N.

1974 *The Railroad Car Builder's Pictorial Dictionary.* Dover Publications, Inc., New York.

Russell and Erwin Manufacturing Company

1865 *Illustrated Catalogue of American Hardware of the Russell and Erwin Manufacturing Company.* Reprinted 1980 by the Association for Preservation Technology, Lisle, Illinois.

Wells, Tom

1998 Nail Chronology: The Use of Technologically Derived Features. *Historical Archaeology* 32(2):78-99.

Horse Equipment and Harness

Ahlborn, Richard

1980 *Man Made Mobil Early Saddles of Western North America.* Smithsonian Institution Press, Washington.

Fitzgerald, William N.
1875 *The Harness Makers' Illustrated Manual*. Wm. N. Fitz-Gerald, NY. Reprinted 1974 by North River Press, Inc., Croton-on-Hudson, New York.

Fox, Charles Philip
1987 *Horses in Harness: A Pictorial Recollection of the Horse-Drawn Decades*. Reiman Associates, Greendale, Wisconsin.

Keegan, Terry
1973 *The Heavy Horse: Its Harness and Harness Decoration*. A.S. Barnes and Company, New York.

Lungwitz, A. and John W. Adams
1966 *A Textbook of Horseshoeing for Horseshoers and Veterinarians*. Oregon State University Press, Corvallis.

Moseman, C. M., and Brother
1987 *Mosemans' Illustrated Catalog of Horse Furnishing Goods: An Unabridged Republication of the Fifth Edition*. Dover Publications, Inc., New York.

Insulators

Hill, James L., and Edward Pickett
1968 *An Insulator Book for Collectors, Sketches and Prices*. The Mail Printers, Myrtle Creek, Oregon.

Kareofelas, Greg A., Gary G. Cranfill, and John C. Fountain
1969 *A Catalogue and Reference to Insulators and Other Related Materials*. Ole Empty Bottle House Publishing Company, Amador City, California.

Milholland, Marion C.
1971 *Milhollands Complete Glass Insulator Reference Book*. Sequim Press, Sequim, Washington.

Lamps and Lanterns

Bright, Arthur A., Jr.
1949 *The Electric-Lamp Industry: Technological Change and Economic Development from 1800 to 1947*. The Macmillan Company, New York.

Freeman, Larry
1944 *Light on Old Lamps*. Century House, Watkins Glen, New York.

Hobson, Anthony
1991 *Lanterns That Lit Our World: How to Identify, Date, and Restore Old Railroad, Marine, Fire, Carriage, Farm, and Other Lanterns*. Golden Hill Press, Inc., Spencertown, New York.

1996 *Lanterns That Lit Our World, Book Two: Old Railroad, Marine, Fire, Carriage, Farm, & Other Lanterns*. Golden Hill Press, Inc., Spencertown, New York.

Myers, Denys Peter
1978 *Gaslighting in America: A Pictorial Survey, 1815-1910*. Dover Publications, Inc., New York.

Pyne Press
1972 *Lamps and Other Lighting Devices 1850-1906*. Pyne Press, Princeton, New Jersey.

Wallace-Homestead Book Co.
1972 *Lamps & Other Lighting Devices 1850-1906*. Wallace-Homestead Book Co., Des Moines, Iowa.

Woodhead, E. I., C. Sullivan, and G. Gusset
1984 *Lighting Devices in the National Reference Collection, Parks Canada*. Studies in Archaeology, Architecture and History. National Historic Parks and Sites Branch, Parks Canada, Ottawa, Ontario.

Silver

Rainwater, Dorothy T.
1966 *American Silver Manufacturers, Their Marks, Trademarks and History*. Everybodys Press, Hanover, Pennsylvania.

Rainwater, Dorothy T. and Judy Redfield
1998 *Encyclopedia of American Silver Manufacturers, Fourth Edition*. Schiffer Publishing Ltd., Atglen, Pennsylvania.

Wyler, Seymour B.
1937 *The Book of Old Silver, English - American - Foreign, With All Available Hallmarks Including Sheffield Plate Marks, Profusely Illustrated*. Crown Publishers, New York.

Tools

Cope, Kenneth L.
1993 *American Machinist's Tools: An Illustrated Directory of Patents, Over 1000 Diagrams*. Astragal Press, Mendham, New Jersey.

1994 *More Makers of American Machinist's Tools: A Historical Directory of Makers and Their Tools*. Astragal Press, Mendham, New Jersey.

1998 *More Makers of American Machinist's Tools: A Historical Directory of Makers and Their Tools*. Astragal Press, Mendham, New Jersey.

Kijowski, Gene W., editor
1990 *Directory of American Tool Makers, Colonial Times to 1899, Working Draft Edition*. Early American Industries Association, Albany, New York.

Pollak, Emil, and Martyl Pollak
1987 *A Guide to American Wooden Planes and Their Makers*. The Astragal Press, Morristown, New Jersey.

Salaman, R. A.
1975 *Dictionary of Woodworking Tools and Tools of Allied Trades*. Taunton Press, Inc., Newtown, Connecticut.

1986 *Dictionary of Leather-working Tools, c.1700-1950 and the Tools of Allied Trades.* Macmillan Publishing Company, New York.

Sellens, Alvin

1990 *Dictionary of American Hand Tools: A Pictorial Synopsis.* Alvin Sellens, Augusta, Kansas.

Smith, H. R. Bradley

1966 *Blacksmith's and Farrier's Tools at Shelburne Museum: A History of their Development from Forge to Factory. Museum Pamphlet Series, Number 7.* The Shelburne Museum, Inc., Shelburne, Vermont.

Toys

Baumann, Paul

1981 *Collecting Antique Marbles.* Wallace-Homestead Book Co., Des Moines, Iowa.

Best, Charles W.

1973 *Cast Iron Toy Pistols 1870-1940: A Collector's Guide.* Rocky Mountain Arms & Antiques, Englewood, Colorado.

Carskadden, Jeff, and Richard Gartley

1990 A Preliminary Seriation of 19th Century Decorated Porcelain Marbles. *Historical Archaeology* 24(2):55-69.

Grist, Everett

1992 *Antique & Collectible Marbles: Identification & Values, Third Edition.* Collector Books, Paducah, Kentucky.

Pina, Ravi

1995 *Cracker Jack Collectibles with Price Guide.* Schiffer Publishing Ltd., Atglen, Pennsylvania.

Trade Goods

Fike, Richard E., and H. Blaine Phillips II

1984 *A Nineteenth Century Ute Burial From Northeast Utah.* Bureau of Land Management, Utah, Cultural Resource Series, No. 16.

Hanson, James Austin

1975 *Metal Weapons, Tools, and Ornaments of the Teton Dakota Indians.* University of Nebraska Press, Lincoln.

Woodward, Arthur

1976 *Indian Trade Goods.* Binford & Mort, Portland, Oregon.

Wagons

Rittenhouse, Jack D.

1948 *American Horse-Drawn Vehicles.* Floyd Clymer, Los Angeles.

Spivey, Towana, editor
1979 A Historical Guide to Wagon Hardware & Blacksmith Supplies. *Contributions of the Museum of the Great Plains Number 9*. Lawton, Oklahoma.

Miscellaneous

Anderson, Adrienne
1968 The Archaeology of Mass-Produced Footwear. *Historical Archaeology* 2:56-65.

Anderton, Mark
1999 *Encyclopedia of Petrolianan: Identification and Price Guide*. Krause Publications, Iola, Wisconsin.

Brown, Martin R., and John W. Dunn
1966 *A Guide to the Grading of United States Coins (Illustrated)*. Whitman Publishing Company, Racine, Wisconsin.

Bull, Donald A., and John R. Stanley
1999 *Just for Openers: A Guide to Beer, Soda, & Other Openers*. Schiffer Publishing Ltd., Atglen, PA.

Cope, Kenneth L.
2000 *Kitchen Collectibles: An Identification Guide*. Astragal Press, Mendham, New Jersey.

Goins, John E.
1982 *Pocketknives: Markings of Manufacturers and Dealers*. Knife World Publications, Knoxville, Tennessee.

Gurcke, Karl
1987 *Bricks and Brickmaking: A Handbook for Historical Archaeology*. The University of Idaho Press, Moscow.

Hillier, Mary
1968 *Dolls and Doll-Makers*. G. P. Putnam's Sons, New York.

Jacobs, Celia
1970 *American Pewter Marks & Makers: A Handbook for Collectors*. The Stephen Greene Press, Brattleboro, Vermont.

Klenman, Allan
1990 *Axe Makers of North America*. Whistle Punk Books, Victoria, British Columbia, Canada.

Lewis, Jack and B. R. Hughes
1979 *Gun Digest Book of Folding Knives*. Follett Publishing Company, Chicago.

Martin, Andy
1991 *Blasting Cap Tin Catalog, Over 200 Tins Illustrated*. Old Adit Press, Tucson, Arizona.

Mott, J. L., Iron Works
1987 *Mott's Illustrated Catalog of Victorian Plumbing Fixtures for Bathrooms and Kitchens*. Dover Publications, Inc., New York.

Museums at Stony Brook

1986 *The Carriage Collection*. The Museums at Stony Brook, Stony Brook, New York.

Nelson, Lee H.

1968 *Nail Chronology as an Aid to Dating Old Buildings*. American Association for State and Local History Technical Leaflet 48.

Schroeder, Bill

1970 *1000 Razors Priced and Illustrated*. Collectors Books, Paducah, Kentucky.

1977 *Collector's Illustrated Price Guide, Pocket Knives*. Collectors Books, Paducah, Kentucky.

Sprague, Roderick

1985 Glass Beads: A Progress Report. *Historical Archaeology* 19(2):87-105.

Storino, Louis

1995 *Chewing Tobacco Tin Tags 1870-1930*. Schiffer Publishing Ltd., Atglen, Pennsylvania.

Thompson, Helen Lester

1997 *Sewing Tools and Trinkets: Collector's Identification & Value Guide*. Collector Books, Paducah, Kentucky.

Townsend, George E.

1971 *Almost Everything You Wanted to Know About American Watches and Didn't Know Who to Ask*. N.p., n.p.

Weber, Carl

1965 *Weber's Guide to Pipes and Pipe Smoking*. Rutledge Books, Inc., New York.