

30 PRESERVATION BRIEFS

The Preservation and Repair of Historic Clay Tile Roofs

Anne E. Grimmer and Paul K. Williams



U.S. Department of the Interior
National Park Service
Cultural Resources
Heritage Preservation Services

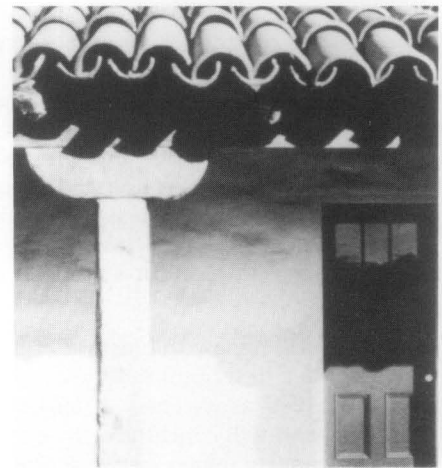

Clay tiles are one of the most distinctive and decorative historic roofing materials because of their great variety of shapes, colors, profiles, patterns, and textures. Traditionally, clay tiles were formed by hand, and later by machine extrusion of natural clay, textured or glazed with color, and fired in high-temperature kilns. The unique visual qualities of a clay tile roof often make it a prominent

feature in defining the overall character of a historic building (Fig. 1). The significance and inherently fragile nature of historic tile roofs dictate that special care and precaution be taken to preserve and repair them.

Clay tile has one of the longest life expectancies among historic roofing materials—generally about 100 years,



Figure 1. Clay tiles used as roof covering and as vertical cladding on the third story and gable ends are important in defining the historic character of the Alfred W. McCune Mansion in Salt Lake City. Designed by the architect S.C. Dallas, and completed in 1901, this brick and brownstone structure is a tiled variation of the Shingle style. Drawing: Clay Fraser, HABS Collection.

and often several hundred. Yet, a regularly scheduled maintenance program is necessary to prolong the life of any roofing system. A complete internal and external inspection of the roof structure and the roof covering is recommended to determine condition, potential causes of failure, or source of leaks, and will help in developing a program for the preservation and repair of the tile roof. Before initiating any repair work on historic clay tile roofs, it is important to identify those qualities important in contributing to the historic significance and character of the building.

This Brief will review the history of clay roofing tiles and will include a description of the many types and shapes of historic tiles, as well as their different methods of attachment. It will conclude with general guidance for the historic property owner or building manager on how to plan and carry out a project involving the repair and selected replacement of historic clay roofing tiles. Repair of historic clay tile roofs is not a job for amateurs; it should be undertaken only by professional roofers experienced in working with clay tile roofs.

Historical Background

The origin of clay roofing tile can be traced independently to two different parts of the world: China, during the Neolithic Age, beginning around 10,000 B.C.; and the Middle East, a short time later. From these regions, the use of clay tile spread throughout Asia and Europe. Not only the ancient Egyptians and Babylonians, but also the Greeks and Romans roofed their buildings with clay tiles, and adaptations of their practice continue in Europe to the present. European settlers brought this roofing tradition to America where it was established in many places by the 17th century.

Archeologists have recovered specimens of clay roofing tiles from the 1585 settlement of Roanoke Island in North Carolina. Clay tile was also used in the early English settlements in Jamestown, Virginia, and nearby St. Mary's in Maryland. Clay roofing tiles were also used in the Spanish settlement of St. Augustine in Florida, and by both the French and Spanish in New Orleans.



Fig. 2. Sunnyside, Washington Irving's house in Tarrytown, New York, dates to about 1656. Although extensively remodeled during the years 1836-1849, the stepped gables and tiled roof still reflect the heritage of its original Dutch builders. Photo: Jack E. Boucher, HABS Collection.

Dutch settlers on the east coast first imported clay tiles from Holland. By 1650, they had established their own full-scale production of clay tiles in the upper Hudson River Valley, shipping tiles south to New Amsterdam (Fig. 2). Several tile manufacturing operations were in business around the time of the American Revolution, offering both colored and glazed tile and unglazed natural terra-cotta tile in the New York City area, and in neighboring New Jersey. A 1774 New York newspaper advertised the availability of locally produced, glazed and unglazed pantiles for sale that were guaranteed to "stand any weather." On the west coast clay tile was first manufactured in wooden molds in 1780 at Mission San Antonio de Padua in California by Indian neophytes under the direction of Spanish missionaries (Fig. 3).

By far the most significant factor in popularizing clay roofing tiles during the Colonial period in America was the concern with fire. Devastating fires in London, 1666, and Boston in 1679, prompted the establishment of building and fire codes in New York and Boston. These fire codes, which remained in effect for almost two centuries, encouraged the use of tile for roofs, especially



Fig. 3. Clay tiles were first produced on the west coast in 1780 at Mission San Antonio de Padua in Monterey County, California. The present church shown here dates from 1810. Photo: Gene Falk.

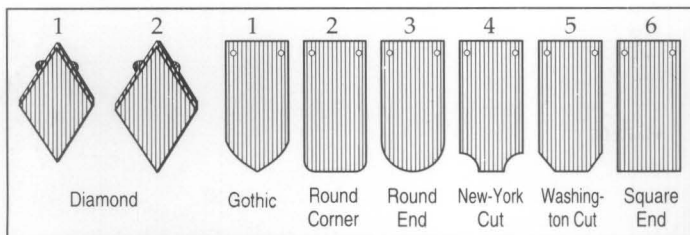

Fig. 4. Many mid- and late-19th century buildings had roofs with uniquely shaped tiles such as fishscale, or another one of the tile shapes that Charles Thomas Davis described as "the six forms of roofing tiles in most common use in this country," and illustrated in his 1884 book *A Practical Treatise on the Manufacture of Bricks, Tiles, Terra-Cotta, Etc.*

in urban areas, because of its fireproof qualities. Clay roofing tile was also preferred because of its durability, ease of maintenance, and lack of thermal conductivity.

Although more efficient production methods had lowered the cost of clay tile, its use began to decline in much of the northeastern United States during the second quarter of the 19th century. In most areas outside city-designated fire districts, wood shingles were used widely; they were more affordable and much lighter, and required less heavy and less expensive roof framing. In addition, new fire-resistant materials were becoming available that could be used for roofing, including slate, and metals such as copper, iron, tinplate, zinc, and galvanized iron. Many of the metal roofing materials could be installed at a fraction of the cost and weight of clay tile. Even the appearance of clay tile was no longer fashionable, and by the 1830s clay roofing tiles had slipped temporarily out of popularity in many parts of the country.

Revival Styles Renew Interest in Clay Roofing Tiles

By the mid-19th century, the introduction of the Italianate Villa style of architecture in the United States prompted a new interest in clay tiles for roofing. This had the effect of revitalizing the clay tile manufacturing industry, and by the 1870s, new factories were in business, including large operations in Akron, Ohio, and Baltimore, Maryland. Clay tiles were promoted by the Centennial Exhibition in Philadelphia in 1876, which featured several prominent buildings with tile roofs, including a pavilion for the state of New Jersey roofed with clay tiles of local manufacture. Tile-making machines were first patented in the 1870s, and although much roofing tile continued to be made by hand, by the 1880s more and more factories were beginning to use machines (Fig. 4). The development of the Romanesque Revival style of architecture in the 1890s further strengthened the role of clay roofing tiles as an American building material (Fig. 5).

Alternative substitutes for clay tiles were also needed to meet this new demand. By about 1855, sheet metal roofs designed to replicate the patterns of clay tile were being produced. Usually painted a natural terra cotta color to emulate real clay tile, these sheet metal roofs became popular because they were cheaper and lighter, and easier to install than clay tile roofs.

Clay roofing tiles fell out of fashion again for a short time at the end of the 19th century, but once more gained acceptance in the 20th century, due primarily to the popularity of the Romantic Revival architectural styles,



Figure 5. (a) Clay tile was a popular roofing material during the Romanesque Revival period, not only for residential structures including these rowhouses in the Dupont Circle Historic District in Washington, D.C., and designed and built by Thomas F. Schneider between 1889-1892, but also for large-scale public buildings such as (b) the Old Federal Courts Building (1894-1901) in St. Paul, Minnesota, designed by Willoughby J. Edbrooke. Photo: (a) Anne Grimmer, and (b) Winsor/Faricy Architects.

including Mission, Spanish, Mediterranean, Georgian and Renaissance Revival in which clay tile roofs featured prominently. With the availability of machines capable of extruding clay in a variety of forms in large quantities, clay tiles became more readily available across the nation. More regional manufacturing plants were established in areas with large natural deposits of clay, including Alfred, New York; New Lexington, Ohio; Lincoln, California; and Atlanta, Georgia; as well as Indiana, Illinois and Kansas.

The popularity of clay tile roofing, and look-alike substitute roofing materials, continues in the 20th century, especially in areas of the South and West—most notably Florida and California—where Mediterranean and Spanish-influenced styles of architecture still predominate (Fig. 6).



Fig. 6. Like many other house of this period in Florida, the roof of the Chester C. Bolton House in Palm Beach features tiles imported from Cuba. These tiles, with their richly varied earth colors, were often laid in thick cement mortar that was intended to give a "rustic" appearance. The residence, which includes the main house (1918-1919) designed by James A. Garfield, and an addition built in 1929 designed by Prentice Sanger, has been described as an English manor house with Spanish details. Photo: Jack E. Boucher, HABS Collection.

Early Tiles

During the 17th and 18th centuries the most common type of clay roofing tiles used in America were flat and rectangular. They measured approximately 10" × 6" × 1/2" (25cm × 15cm × 1.25cm), and had two nail or peg holes at one end through which they were anchored to the roofing laths. Sometimes a strip of mortar was placed between the overlapping rows of tile to prevent the tiles from lifting in high winds. In addition to flat tiles, interlocking S-shaped pantiles were also used in the 18th century. These were formed by molding clay over tapered sections of logs, and were generally quite large. Alternately termed pan, crooked, or Flemish tiles, and measuring approximately 14 1/2" × 9 1/2" (37cm × 24cm), these interlocking tiles were hung on roofing lath by means of a ridge or lug located on the upper part of the underside of each tile. Both plain (flat) tile and pantile (S-shaped or curved) roofs were capped at the ridge with semicircular ridge tiles. Clay roofing tiles on buildings in mid-18th century Moravian settlements in Pennsylvania closely resembled those used in Germany at the time. These tiles were about 14"-15" long × 6"-7" wide (36cm-38cm × 15cm-18cm) with a curved butt, and with vertical grooves to help drainage. They were also designed with a lug or nib on the back so that the tiles could hang on lath without nails or pegs.

The accurate dating of early roofing tiles is difficult and often impossible. Fragments of tile found at archeological sites may indicate the existence of clay tile roofs, but the

same type of tile was also sometimes used for other purposes such as paving, and in bake ovens. To further complicate dating, since clay tile frequently outlasted many of the earliest, less permanent structures, it was often reused on later buildings.

Clay Tile Substitutes

In addition to sheet metal "tile" roofs introduced in the middle of the 19th century, concrete roofing tile was developed as another substitute for clay tile in the latter part of the 19th century (Fig. 7). It became quite popular by the beginning of the 20th century. Concrete tile is composed of a dense mixture of portland cement blended with aggregates, including sand, and pigment, and extruded from high-pressure machines. Although it tends to lack the color permanence and the subtle color variations inherent in natural clay tile, concrete tile continues to be a popular roofing material today because it reproduces the general look of clay tile, if not always the exact profile or proportions of historic clay tile, at a somewhat lower cost and weight. Another modern, slightly cheaper and lighter substitute for clay tile more recently developed consists of a mixture of mineral fiber and cement with pigments added to supply color. While these aggregate tiles also replicate the shape and appearance of clay roofing tiles, they have many of the same dissimilarities to clay tiles that are found in concrete tiles. Thus, like concrete tiles, they are seldom appropriate substitutes for clay tiles.

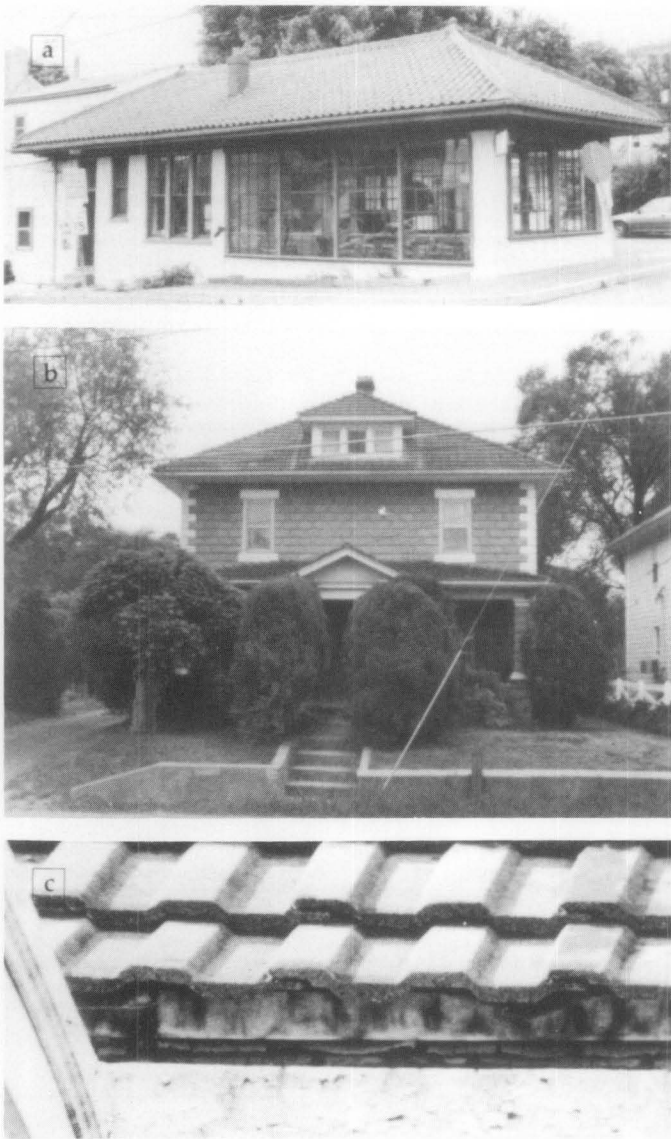

Fig. 7. (a) Metal "tile" roofs of galvanized steel closely resemble the clay tiles they mimic. Often painted to look like terra cotta, their identity can sometimes be revealed by peeling paint or dented "tiles." (b-c) Concrete roofing tiles are generally thicker than clay tiles, and tend to fade and lose their color. Photos: (a-b) Anne Grimmer, (c) National Park Service Files.

Traditional Tile Shapes and Colors

There are two types of clay roofing tiles: interlocking and overlapping. *Interlocking* tiles are designed in pairs so that an extrusion or "lip" on one of the tiles "hooks" over the other tile thereby "locking" or securing the two together; they are also usually nailed to the roof structure.

Overlapping tiles, which can also function in pairs, generally do not have any sort of "lip" and must be nailed in place. There is a wide range of shapes of historic clay roofing tiles, and many, sometimes with slight variations, are still produced today. There are many variations, and the country of origin of some of them may be revealed in their names, but there are essentially only two kinds of shapes: pantiles and flat tiles. Both pantiles and flat tiles may be either interlocking or overlapping (Figs. 8-9).

Pantiles. The shape most commonly associated with historic clay roofing tiles is probably that of convex or rounded tiles, often grouped together generically as "pan tiles" or "pantiles." These include Spanish tiles—sometimes called "S" tiles, or the similarly shaped Mission tiles, also known as Barrel or Barrel Mission tiles, straight or tapered, as well as Roman tiles, and their Greek variation.

Flat Tiles. Flat, shingle tiles are another type of historic clay roofing tiles. Flat tiles can be completely plain and flat, and, like roofing slates, overlap one another, attached with nails to the roof sheathing. Or they may interlock at the top and on one side. Although the "interlock" holds them together, most interlocking shingle tiles also have one or more holes, usually near the top, for nailing to the roof sheathing. Flat tiles are mostly variations of English or Shingle tiles, and include English Shingle, Closed Shingle, Flat, Shingle or Slab Shingle, as well as French tiles which have a slightly higher and more contoured profile.

Any of the standard tile shapes may be known by a different name in another region of the country, or in different parts of the world. For example, what are known as Spanish or "S" tiles in the United States, may be called Single Roman tiles in England. Sometimes Spanish and Mission tiles are equated despite the fact that the former are usually 1-piece interlocking tiles and the latter are single $\frac{1}{2}$ cylinders that overlap. Since missions and the Mission style are associated with the Americas, Mission tiles in the United States are more commonly referred to as Spanish tiles in England and Europe. In a similar vein, Spanish or "S" tiles, or Barrel tiles, might seem to be more typical of some tiles used in France than what are marketed as French tiles by American manufacturers.

Today some tile manufacturers have given their own trademark name to historic tile shapes. Other companies market uniquely shaped "S" tiles that are more in the shape of a true, but rather low profile "s" without the customary flat portion of traditional American "S" tiles.

Field and Specialty Tile. The tiles that cover the majority of the flat surface of the roof are called *field* tile. Some roof shapes, particularly conical towers or turrets, require tiles of graduated sizes, and some shapes or patterns of field tile also require specially shaped finish tiles to complete the roof covering package. Other uniquely-shaped tiles were made to fit odd-shaped spaces and places including dormers and valleys, roof hips, rakes, ridges and corners. There are also finish tiles that fulfill certain needs, such as eave closures or clay plugs called "birdstops." These are intended to keep out snow and rain, and birds from nesting in the voids under the bottom row of curved tiles. Different patterns and designs can also be created by combining, or mixing and matching flat tiles with dimensional tiles.

Tile Colors. A terra cotta red is the color most commonly associated with historic clay roofing tiles. The reddish color comes from clay with a large percentage of iron oxide, and there are many variations of this natural color to be found in tiles ranging from deep reddish browns to softer and paler oranges and pinks. Lighter buff and beige colors, as well as black, also appear on traditional tile-

Traditional Clay Roofing Tile Shapes and Methods of Attachment

Pantiles		
Type	Average Size	Description
 <p style="text-align: right;">Spanish or "S" Interlocking</p>	<p>13 1/4" long × 9 3/4" wide</p> <p>Exposure: 10 1/4"</p>	<p>Spanish or "S" tiles are 1-piece interlocking tiles with both a convex and a flat, or almost flat, horizontal surface. A raised lip that projects from the edge of the flat portion is designed to interlock with the edge of the convex, barrel end of the adjacent tile. Spanish tiles are usually laid directly on the wood sheathing, or on roofing felt, and fastened by two nails through holes at the top of the tiles, or sometimes mortared in place. Spanish tiles give a roof surface a fairly low and undulating profile.</p>
 <p style="text-align: right;">Tapered or Straight Mission, Barrel, or Barrel Mission Overlapping</p>	<p>14"–18" up to 22"–24" long</p> <p>Each half cylinder about 3" high × about 8" in diameter</p> <p>Exposure: 11"–15"</p>	<p>Tapered or Straight Mission, Barrel, Barrel Mission, or Pan and Cover tile roofs are created with both a concave and a convex 1/2 cylinder-shaped tile. The concave (pan) tiles are laid first in vertical rows, and nailed directly to the roof sheathing. The convex (cover) tiles are laid to overlap and cover the vertical spaces, or joints, that separate the vertical rows of the concave tiles. The convex tiles may be fastened to the roof sheathing with very long nails, hooks or hangers, or more commonly laid over, and nailed to vertical wood battens underneath. Mission tile roofs have a higher profile than Spanish or Roman tile roofs.</p>
 <p style="text-align: right;">Roman, Pan and Roll, or Pan and Cover Interlocking and Overlapping</p>	<p>12 3/4" long</p> <p>Width from center of 1 cover tile to center of next including width of 1 flat tile is 12"</p> <p>Exposure: 10"</p>	<p>Roman, or Pan and Roll, roofs consist of a two-part tile system which includes a convex barrel cover tile with a rather low profile placed over a flat tile laid directly on the roof sheathing. Like Mission tiles, the convex tiles may be nailed either to battens laid vertically on the roof or directly onto the roof sheathing. Both the convex cover tile and the flat tile may also have nibs at the top by which they interlock with tiles laid in rows above them. Roman tiles may also be cemented in place. A Roman tile roof appears as a series of fairly wide or broad, flat "valleys" alternating with rather low ridges or hills, much like a Spanish tile roof but with wider "flat" sections.</p>
 <p style="text-align: right;">Greek Interlocking and Overlapping</p>	<p>Same size and dimensions as Roman tiles</p>	<p>Greek tiles are essentially a variation of Roman tiles, but the convex tiles that cover the vertical joints between the rows of "pan" tiles are shaped like a gable end or inverted "V". Greek tiles are attached to the roof in the same manner as Roman tiles.</p>
Flat Tiles		
 <p style="text-align: right;">English Shingle or Closed Shingle Interlocking</p>	<p>English Shingle: 13 1/4" long × 8 3/4" wide</p> <p>Exposure: 10 1/8" long × 7 3/4" wide</p> <p>Closed Shingle: 11" long × 8 3/4" wide</p> <p>Exposure: 8" × 8"</p>	<p>English or Shingle tiles are generally plain and smooth-surfaced, but some are intended to imitate slate or wood shingles and are textured accordingly. The underside of these tiles can be either flat and smooth, or may have a corrugated appearance with 4-5 toothlike projections; all are attached with nails.</p>
 <p style="text-align: right;">English Flat or Slab Shingle Overlapping</p>	<p>12" × 15" long × 6" × 7" wide, or 12" long × 9"–10" wide</p> <p>Exposure varies according to size of the tile, but is generally slightly less than 1/2 length of the tile</p>	
 <p style="text-align: right;">French Interlocking</p>	<p>16 1/4" long × 9" wide</p> <p>Exposure: 9"</p>	<p>French tiles feature two deep vertical grooves on the surface that facilitate drainage, and create interesting light and shadow contrasts. A vertical lug projects from the top of these tiles that interlocks with the bottom of the tile laid over it. French tiles also have two nail holes at the top for nailing, and are often given a dab of cement for added security.</p>

Fig. 8. Traditional Clay Roofing Tile Shapes and Methods of Attachment. Drawing: Karin Murr Link.

Clay Roofing Tile Installation Patterns

Spanish or "S"

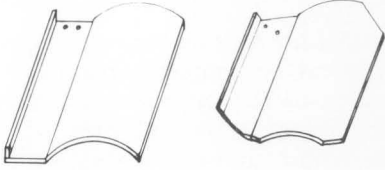
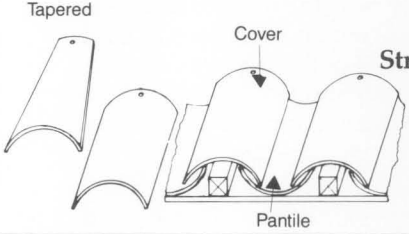
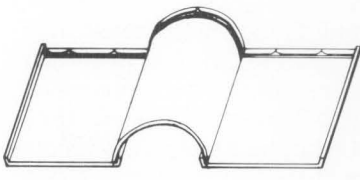
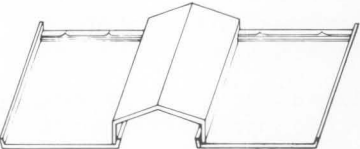
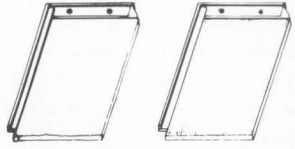
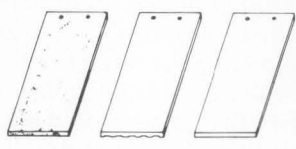
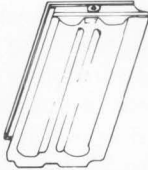
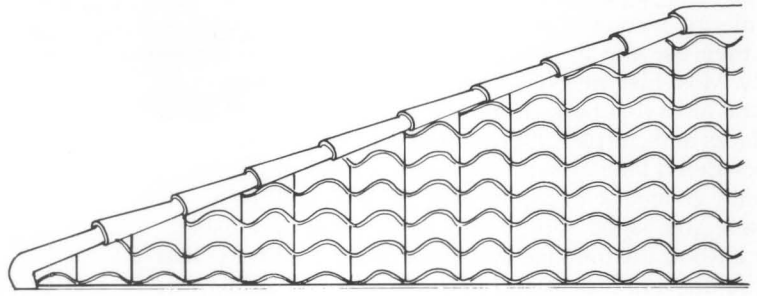
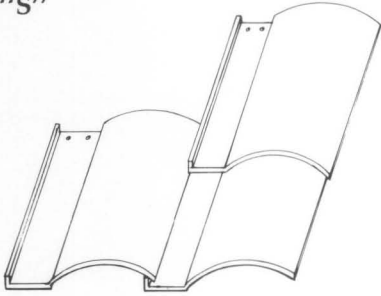

Straight Mission,
Barrel,
Barrel Mission
or
Pan and Cover

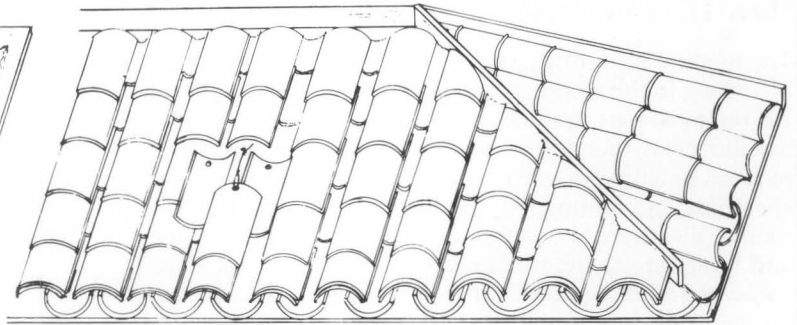
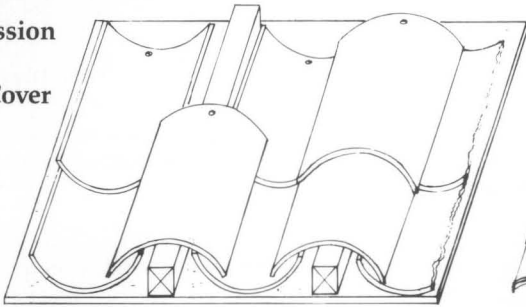

Roman

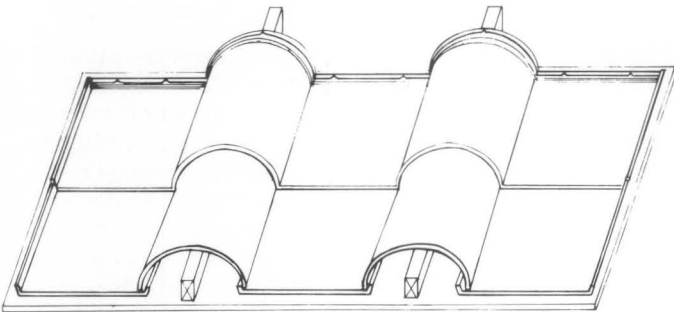

Greek

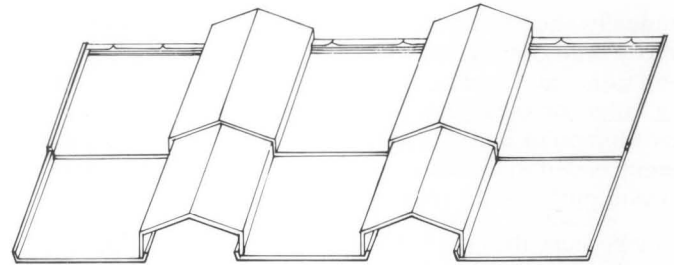

English Shingle or
Closed
Shingle

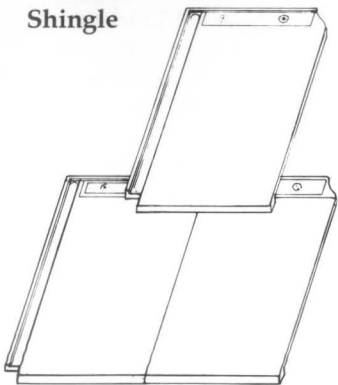

English Flat or Slab Shingle

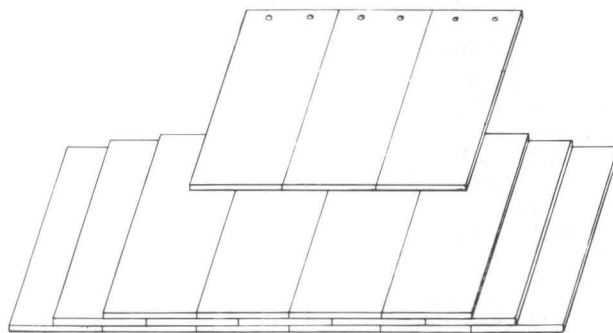

French

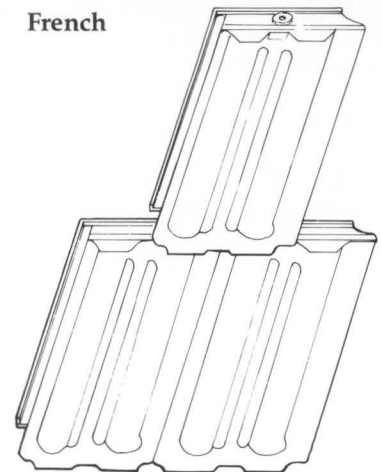

Fig. 9. Clay Roofing Tile Installation Patterns. Drawing: Karin Murr Link.

roofed buildings. Buff-colored tiles were made from nearly pure fire clay, and pouring manganese dissolved in water over the tile before firing resulted in smoke brown or black glazed tiles. Toward the end of the 19th century the popularity of colored glazes for roofing tiles increased, and their use and the range of colors continues to expand today. Most historic glazed roofing tiles are in fairly natural hues that range from reds and browns and buffs, to blacks and purples, blues (often created with smalt, or powdered blue glass), and a wide variety of greens (usually created with copper slag). There could be a considerable range in the colors of tiles that were baked over a wood fire because the temperature within the kiln was so uneven; tiles closest to the fire cooked all the way through and turned a darker red, while tiles farthest from the flames were likely to be smoke-stained, and lighter orange in color.

How Tiles are Attached

The method used to attach clay roofing tiles varies according to the shape, size and style of the particular tile. For the most part, traditional and modern methods of installing clay roofing tiles are very similar, except that modern practice always includes the use of wood sheathing and roofing felt. But most of the earliest clay roofing tiles were laid without benefit of wood sheathing and hung directly on roofing laths and battens that were nailed to the roof rafters; this practice continued up into the mid-19th century in some regions. While this method of attachment allowed for plenty of ventilation, and made it easy to find leaks and make repairs, it also meant that the overall watertightness of the roof depended entirely on the tiles themselves.

Gradually, the practice evolved of nailing roofing tiles directly onto continuous wood sheathing, or hanging them from “nibs” on horizontal lath that was attached to roof rafters or sheathing. Some kinds of tile, especially the later Mission or Barrel tiles were laid over vertical strips or battens nailed to the sheathing, or the tiles were fastened to wood purlins with copper wire.

Partly because they do not always fit together very closely, some tile shapes, including Spanish, Barrel or Mission as well as other types of interlocking tiles, are not themselves completely water-repellent when used on very low-pitched roofs. These have always required some form of sub-roofing, or an additional waterproof underlayer, such as felting, a bituminous or a cementitious coating. In some traditional English applications, a treatment called “torching,” involved using a simple kind of mortar most commonly consisting of straw, mud, and moss. The tapered Mission tiles of the old Spanish missions in California were also laid in a bed of mud mortar mixed with grass or straw which was their only means of attachment to the very low-pitched reed or twig sheathing (*latia*) that supported the tiles (Fig. 10).

More recent and contemporary roofing practices require that the tiles be laid on solid 1" (2.5cm) wood sheathing felted with coated base sheets of at least 30 lbs., or built-up membranes or single-ply roof membranes. This substantially increases the watertightness of the roof by adding a second layer of waterproofing. Horizontal and vertical chalk lines are drawn to serve as a guide in laying



Fig. 10. The underside of this roof on the restored barracks at Santa Cruz Mission reveals the twig sheathing or *latia* to which the clay tiles were traditionally attached with mud mortar. Photo: Gil Sánchez, FAIA.

the tile and to indicate its patterning. Most tiles are designed with one or two holes so they can be attached by copper nails or hangers, and/or with projecting nibs, to interlock or hang on battens or lath attached to the base sheathing.

Before laying the tiles, the copper or lead gutters, flashings and valleys must be installed, preferably using at least #26 gauge (20-24 ounce) corrosion-resistant metal extending a minimum of 12" (30.5cm) under the tile from the edge, or in accordance with the manufacturer's specifications. The long life and expected durability of clay tiles require that, as with the roofing nails, only the best quality metal be selected for the flashing and guttering.

“Field tile” is usually ordered by the number of “squares”—that is, a flat section 10' x 10' (25cm x 25cm)—needed to cover a roof section. The tile company or roofing contractor should calculate the number of tiles needed according to the type of roof, and based on architect's drawings to ensure accuracy. This should include specialty ridge and eave tiles, decorative trim, partial “squares”, approximately 10-20 per cent allowance for breakage, and extra tiles to store for repairing incidental damage later on. Once at the site, the tile is evenly distributed in piles on the roof, within easy reach for the roofers.

The tiles are laid beginning with the first course at the lower edge of the roof at the eaves. The method by which roofing tiles are laid and attached varies, depending on the type and design of the tiles and roof shape, as well as on regional practice and local weather conditions. A raised fascia, a cant strip, a double or triple layer of tiles, or special “birdstop” tiles for under the eaves, may be used to raise the first row of tiles to the requisite height and angle necessary for the best functioning of the roof (Fig. 11). The tile is positioned to overhang the previously installed gutter system by at least 1 1/2" (4cm) to ensure that rainwater discharges into the central portion of the gutter. Once this first course is carefully fitted and examined from the ground level for straightness and color nuances, and adjusted accordingly, successive courses are lapped over the ones below as the roofer works diagonally up the roof toward the ridge. Positioning and laying tiles in a 10' x 10' (25cm x 25cm) square may take on the average of 16½ man hours.

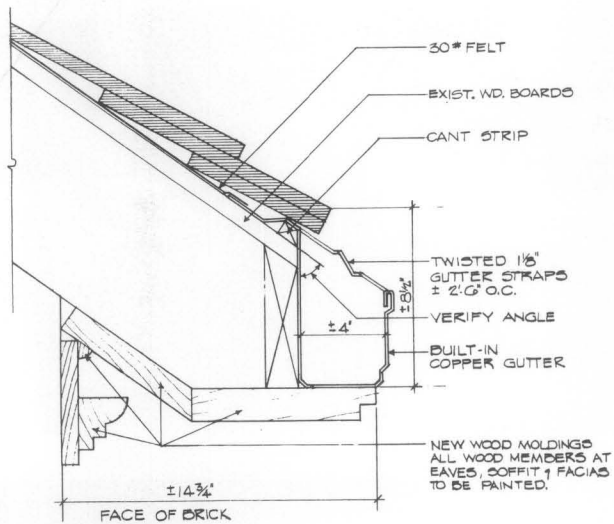

Fig. 11. Both a cant strip and a double layer of tiles are used here to raise the first row of tiles to ensure proper roof drainage. This drawing was prepared for the restoration of the 1911-1912 Jamaica Pond Boathouse, Jamaica Plain, Massachusetts, which is part of the original Boston Park system designed by Frederick Law Olmsted in the late-19th century. Drawing: Richard White, Architect/Planner.

Flat Tiles

Most flat clay tiles have one or two holes located at the top, or on a "nib" or "lug" that projects vertically either from the face or the underside of the tiles, for nailing the tile to the sheathing, battens, or furring strips beneath. As successive rows of tile are installed these holes will be covered by the next course of tiles above. Traditionally, clay tiles on the oldest tile roofs were hung on roofing laths with oak wooden pegs. As these wood pegs rotted, they were commonly replaced with nails. Today, copper nails, 13/4" (4.5cm) slaters' nails, are preferred for attaching the tiles because they are the longest lasting, although other corrosion-resistant nails can also be used. Less durable nails reduce the longevity of a clay tile roof which depends on the fastening agents and the other roofing components, as much as on the tiles themselves. Clay roofing tiles, like roofing slates, are intended to hang on the nails, and nailheads should always be left to protrude slightly above the surface of the tile. Nails should not be driven too deeply into the furring strips because too much pressure on the tile can cause it to break during freeze/thaw cycles, or when someone walks on the roof.

Plain flat tiles, like roofing slates, are attached to the roof sheathing only with nails. They are laid in a pattern overlapping one another in order to provide the degree of impermeability necessary for the roof covering. Because plain flat tiles overlap in most cases almost as much of one half of the tile, this type of tile roof covering results in a considerably heavier roof than does an interlocking tile roof which does not require that the tiles overlap to such an extent. Interlocking flat tiles form a single layer, and an unbroken roof covering. Although most interlocking tiles on all but the steepest roofs can technically be expected to remain in place because they hang on protruding nibs from the roofing laths or battens, in contemporary roofing practices they are often likely to be nailed for added security. In most cases it is usually a good idea to nail at least every other tile (Fig. 12).

Pantiles

With Mission or Barrel tiles, where one half-cylinder overlaps another inverted half-cylinder to form a cover and pan (cap and trough) arrangement, the fastening is more complicated. While the pantiles that rest directly on the sheathing are simply nailed in place, there are two ways of attaching the cover tiles that rest on the pantiles. They can be secured by a copper wire nailed to the sheathing or tied to vertical copper strips running behind the tiles (Fig. 13). Another method requires the installation of vertical battens or nailing strips on the roof to which the cover tiles are nailed, or the use of tile nails or hooks, which are hooked to the pantile below and secured with twisted copper wire.

Sometimes cement mortar, or another underlayer such as grass, moss or straw, or hair-reinforced mortar was added under the tiles. Before the use of felting this was a particularly common practice on some of the plain flat tile or Spanish tile roofs with low rises that were themselves not especially waterproof. Mortar also helped to keep driving rain from getting under the pantiles, and it is still customary in contemporary roofing to add a dab of cement mortar to help secure them (Fig. 14).

Ridge or Hip Tiles

At the roof ridge or hip, clay tile is usually attached to a raised stringer with nails and a small amount of mortar, elastic cement or mastic. The joint is sealed with a flexible flashing such as copper or lead. Ridge tiles are often somewhat larger and more decorative than the field tile utilized on the broad sections of the roof.

Roof Pitch and Weather are Factors in Tile Attachment

The means by which clay tile is attached to the sheathing is also partly determined by the roof pitch. *Generally the fastening requirements increase with an increase of roof pitch.* For low-pitched rises of 4"–6" (10cm–15cm) in a 12" (30.5cm) run the weight of the tiles is usually sufficient to hold them in place on the lath by the ridge or "lug" on the underside of the tile, with only the perimeter tiles requiring metal clips to secure them to the sheathing. But the tiles on even these low-pitched roofs are usually nailed for added security, and additional fastening measures are necessary on roofs with a higher pitch, or in areas subject to high winds or earthquakes. For steeper pitched roofs, such as towers, 7"–11" (18cm–28cm), or 12"–15" (30.5cm–38cm) in a 12" (30.5cm) run the tiles are nailed and a band of perimeter tiles three to four tiles thick is secured with clips. For roof rises over 16" (41cm) in a 12" (30.5cm) run, and in areas prone to earthquakes or hurricanes, every tile may be secured with both a nail and a copper or non-corrosive metal clip, and often also with a dab of roofing mastic or mortar.

The installation of clay roofing tiles in areas with significant amounts of snowfall—over 24" (61cm) per year—also varies somewhat from the normal guidelines. Larger battens may be necessary, as well as additional clipping or tying of the tile to securely attach it to the sheathing. The roof structure itself may also need added bracing, as well as the insertion of small snow clips or snow birds that protrude above the surface of the tile to prevent snow and ice from sliding off the roof and damaging the tile.



Figure 12. When constructed in Frankfort, Kentucky, in 1900, the Colonial Revival-style Berry Hill Mansion, and its 1912 Music Room addition were both roofed with "Imperial" tiles manufactured by Ludowici-Celadon (a). In 1992 the entire roof was replaced because of deterioration and surface spalling of many of the tiles (b). It was not possible to reproduce the original tiles due to budget limitations, thus Ludowici-Celadon's stock "Classic Interlocking" Shingle tiles were selected as replacements which could provide a close, if not exact, match. After tearing off and removing the old tiles, 30 lb. roofing felt was laid over the existing wood sheathing, new lead gutters and valleys were installed, and 90 lb. roll roofing was laid, on which the new tiles were laid. Although most of the field tiles were simply attached by 2 nails to the substrate (c), many of the tiles that had to be cut to fit hips, valleys and dormers were left with only one hole, and had to be wired and then nailed in place (d-e). The exact color and glaze of the original tiles also could not be duplicated because the coloring material is no longer available; however, the new hipped roof terminus for the Music Room roof was custom-made and the replacement field tiles are very similar to the originals (f). The original ridge tiles were designed to "nest" and fit perfectly over the field tiles beneath them whereas the new ridge tiles simply overlap one another, but this is barely perceptible when viewed from the ground. Photos: Edwin C. Krebs, AIA.

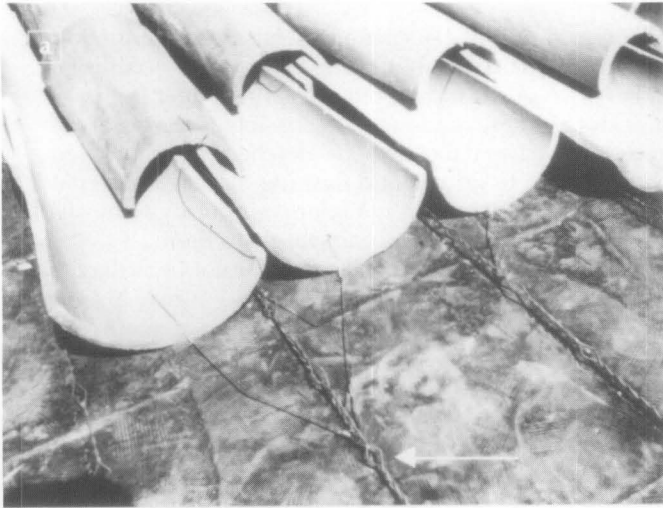

Figure 13 (a-b). These custom-made tapered mission tiles are being attached to the roof using a special system. This consists of twisted 10-gauge brass or copper wires that run up the roof slope through a new treated roof ridge, and down the other side of the roof. These twisted wires are placed about 12" (30.5cm) apart, and diamond shapes are twisted into them every 6" (15cm). The vertical wires are secured with 10-gauge copper or brass anchors approximately every 4' (1.22m) on center depending on the roof slope. Although these tiles would have originally been laid in mud mortar, this method of attachment is particularly successful in seismic areas. The random placement of the tiles accurately replicates the pattern traditionally used on the early missions. Photos: Gil Sánchez, FAIA.

Preservation and Repair

Identifying Common Problems and Failures

While clay roofing tiles themselves are most likely to deteriorate because of frost damage, a clay tile roof system most commonly fails due to the breakdown of the fastening system. As the wooden pegs that fastened the early tiles to hand-riven battens rotted, they were often replaced with iron nails which are themselves easily corroded by tannic acid from oak battens or sheathing. The deterioration of metal flashing, valleys, and gutters can also lead to the failure of a clay tile roof.

Another area of potential failure of a historic clay tile roof is the support system. Clay tiles are heavy and it is important that the roof structure be sound. If gutters and downspouts are allowed to fill with debris, water can back up and seep under roofing tiles, causing the eventual deterioration of roofing battens, the sheathing and fastening system, or even the roof's structural members (Fig. 15). During freezing weather, ice can build up under tiles and cause breakage during the freeze/thaw cycle. Thus, as with any type of roof, water and improperly maintained rainwater removal and drainage systems are also chief causes for the failure of historic clay tile roofs.

Clay tiles may be either handcrafted or machine-made; in general, roofs installed before the end of the 19th century consist of hand-formed tiles, with machine-made tiles becoming more dominant as technology improved during the 20th century. Clay tile itself, whether made by hand or made by machine, can vary in quality from tile to tile. Efflorescence of soluble salts on the surface may indicate that a tile has excessive porosity which results from underburning during its manufacture. Poor quality porous tiles are particularly susceptible to breaking and exterior surface spalling during freeze-thaw cycles. By letting in moisture, porous tiles can permit the roof battens and roof structure to rot. The problem may be compounded by

waterproof building paper or building felt laid underneath which can, in some instances, prevent adequate ventilation.

Clay roofing tiles can also be damaged by roofers walking carelessly on an unprotected roof while making repairs, or by overhanging tree branches, falling tree limbs, or heavy hail. Broken tiles may no longer provide a continuous waterproof surface, thereby allowing water to penetrate the roofing structure, and may eventually result in its deterioration if the broken tiles are not replaced in a timely manner.

Although modern, machine-made clay tiles are more uniform in appearance than their hand-made counterparts, they also have the potential for failure. Occasionally, entire batches of mass-produced tile can be defective.

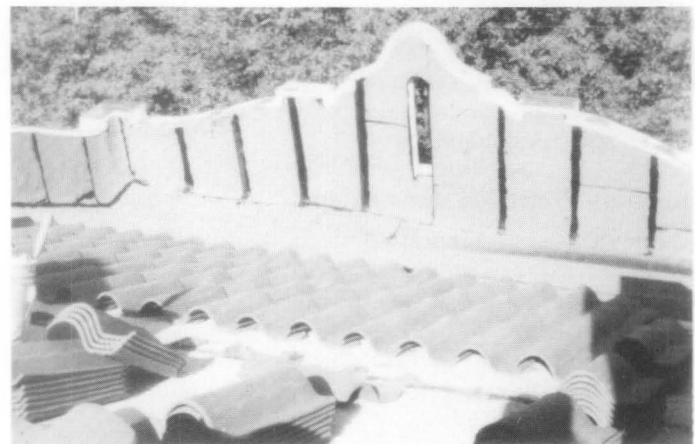

Fig. 14. The Spanish or "S" tiles used to re-roof the Mission Revival style Holy Cross Episcopal Church in Sanford, Florida, have corrugated projections or "teeth" on the underside of the flat portion of each tile which adhere to the cement mortar holding them to the roof sheathing. Photo: Walter S. Marder, AIA.

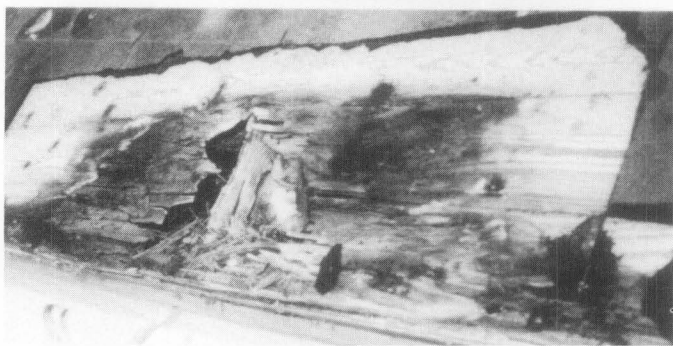

Figure 15. (a) A regular cleaning schedule would have eliminated the plant growth and leaf build-up in this gutter, which, if not removed, will result in serious damage to roof sheathing and structure (b). Photos: (a) Paul K. Williams, and (b) Walter S. Marder. AIA.

Regular Inspection and Maintenance

Broken or missing tiles, or leaks on the interior of the building, are obvious clues that a historic clay tile roof needs repair. Even though it may be clear that the roof is leaking, finding the source of the leak may not be so easy. It may require thorough investigation in the attic, as well as going up on the roof and removing tiles selectively in the approximate area of the roof leak. The source of the leak may not actually be located where it appears to be. Water may come in one place and travel along a roofing member some distance from the actual leak before revealing itself by a water stain, plaster damage, or rotted wooden structural members.

Temporary Protection during Repair

In some instances temporary protection and stabilization may be necessary to prevent further damage or deterioration of a historic clay tile roof. Plywood sheets, plastic, roll roofing, or roofing felt can provide short-term protection until repair or replacement materials can be purchased. Another option may be to erect a temporary scaffold that is encased or covered with clear or semi-transparent polyethylene sheeting over the entire roof. This will not only protect the exposed roofing members during repair or until repairs can be made, but also lets in enough natural light to enable the re-roofing work to take place while sheltering workmen from cold or wet weather.

General Repair Guidance

Once the source and cause of a leak has been identified, appropriate repairs must be made to structural roofing members, wood sheathing, felt or roofing paper if it is part of the roofing membrane, or possibly to vertical roof battens to which the tiles may be attached. If the problem appears limited to gutters and flashing in disrepair, repair or replacement will probably require temporary removal of some of the adjacent tiles to gain access to them. If the roofing tiles are extremely fragile and cannot be walked on even with adequate protection (see below), it may also be necessary to remove several rows or a larger area of tiles and store them for later reinstallation in order to create a "path" to reach the area of repair without damaging existing tiles. Even if most of the tiles themselves appear to be intact but no longer securely attached to the roof substrate due to deterioration of the fastening system or roofing members, all the tiles should be labeled and removed for storage. Regardless of whether the repair project involves removal of only a few damaged tiles, or if all the tiles must be removed and relaid, historic clay roofing tiles are inherently fragile and should be pulled up carefully with the use of a slate ripper. The tiles can be reattached one-by-one with new corrosion-resistant copper nails, copper straps or tabs, "tingles", or another means after the necessary repairs have been made to the roof.

Replacing Individual Tiles

The most difficult aspect of replacing a single broken clay roof tile is doing so without breaking neighboring tiles. While flat shingle tiles can generally be walked on by a careful roofer without likelihood of much damage, high profile pantiles are very fragile and easily broken. By using sheets of plywood, planks, or burlap bags filled with sand to distribute weight, the professional roofer can move about the roof to fix broken tiles or flashing without causing additional damage. Another method involves hooking a ladder on the ridge to support and evenly distribute the weight of the roofer.

A broken tile should be carefully removed with a slate ripper or hacksaw blade inserted under the tile to cut the nail or nails holding it in place. If successive layers of tile are already in place covering the nailholes, it will not be possible to attach the replacement tile with nails through the holes, so an alternative method of attachment will be necessary. By nailing a tab of double thickness copper stripping on the sheathing below the tile, the new replacement tile can be slipped into position and secured in place by bending the copper strip up with a double thickness of the copper over the tile. A slate hook or "tingle" can be used in the same way. This fastening system functions in place of nails (Fig. 16).

When replacing hard-to-match historic tile, and if matching clay tile cannot be obtained, it may be possible to relocate some of the original tiles to the more prominent locations on the roof where the tile is damaged, and insert the new replacement tile in secondary or rear locations, or other areas where it will not show, such as behind chimney stacks, parapets, and dormer windows. Even though replacement tile may initially match the original historic tile when first installed, it is likely to weather or age to a somewhat different color or hue which will become more obvious with time. Thus, care should be taken to insert new replacement tile in as inconspicuous a location as

possible. New, machine-made clay tile or concrete tiles should generally not be used to patch roofs of old, hand-made tile because of obvious differences in appearance.

Sources for Replacement Tiles

When restoring or repairing a clay tile roof it is always recommended that as many of the original tiles be retained and reused as possible. Sometimes, particularly when working with "pan and cover" type tile roofs, while many of the "cover" tiles may be broken and require replacement, it may be possible to reuse all or most of the "pan" tiles which are less susceptible to damage than the "cover" tiles. But, in most cases, unless matching replacements can be obtained, if more than about 30 per cent of the roofing tiles are lost, broken, or irreparably damaged, it may be necessary to replace all of the historic tiles with new matching tiles. When counting the number or percentage of missing or broken tiles that need to be replaced, it is important to order extra tiles to allow for breakage and damage during shipping and on the job site. The size of the tiles must be noted, whether they are all the same size, the same size but laid with different amounts of exposure to compensate for changes in perspective, or of graduated sizes according to horizontal rows—typical, for example, on conical or tower roofs (Fig. 17).

Many late-19th and early-20th century tiles are marked on the back with the name of the company that made them, along with the size and the name of that particular tile shape. Some companies that were in business in the United States at the turn of the century are still producing many of the traditional tile shapes, and may be able to supply the necessary replacements. But it is important to be aware that in some cases, although the name of a particular tile pattern may have remained the same, the actual shape, size, thickness and profile may have changed slightly so that the new tile does not match the historic tile closely enough to permit it to serve as a compatible replacement for missing or broken tiles. While such tiles may be acceptable to use on a secondary or less prominent elevation, or to use when an entire tile roof needs replacement, they would not be suitable to use on an area of the roof that is highly visible.

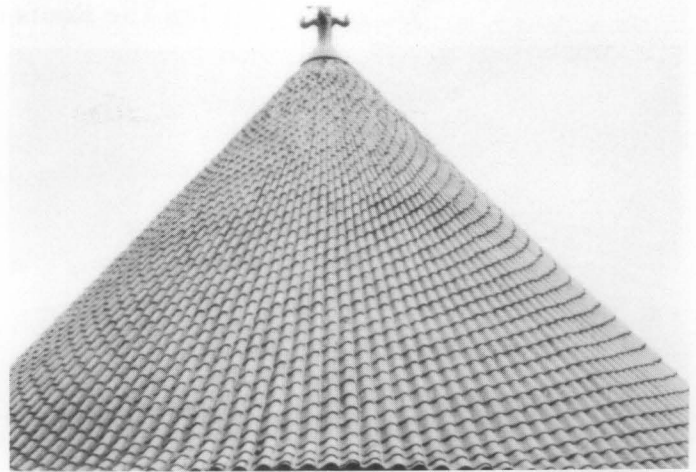

Fig. 17. The rhythm and pattern of these tiles which is so important in defining the character of this roof was created by laying the tiles with different amounts of exposure and using graduated tiles that decrease in size as they reach the top of the cone. Photo: National Park Service Files.

Even if the particular tile is no longer manufactured by a company, the original molds may still exist which can be used to make new tiles to match the historic tiles if the quantity needed is sufficiently large to warrant a custom order. Other companies stock and sell salvaged tile, and keep a variety of old tiles available which can be identified and matched by the number and company imprint on the back of the tiles. Still other companies specialize entirely in custom-made reproduction of historic clay tiles for a specific preservation project.

Modern clay tiles are even more varied than historic tiles. Many shapes and styles are offered in a wide variety of colors and glazes. Several manufacturers produce special color-blended tiles, as well as tiles of different hues that are intended to be carefully mixed when installed. *Yet, it is important to remember that many of these modern tiles may not be appropriate for use on historic clay tile roofs.* The place of manufacture must also be taken into consideration. For instance, tiles made for use in a hot, dry climate may not be able to withstand wet weather, drastic temperature changes or freeze-thaw cycles. Some of the tile shapes, and many of the colors—especially those that are very bright and highly glazed—are completely contemporary in design, and do not represent traditional American styles, and thus, are not suitable for use on historic buildings.

Repairing a Failed Fastening System

Clay roofing tiles, as noted before, frequently outlast their fastening systems. Wood pegs rot, nails rust, and even copper nails that are not adequately driven in can pull out of the roof's structural members. Although it is unusual that all of the clay tiles on a roof need to be replaced unless matching replacements cannot be obtained, it is not uncommon for old tile roofs to be stripped of all their tiles in order to re-lay the tiles with new fastenings and battens. When the fastening system has failed, all the roof tiles must be removed and reattached with new corrosion-resistant fasteners. If possible, all the tiles should be numbered and a diagram should be drawn showing the location of each tile to aid in replicating the original pattern and color variations when the tiles are relaid. Ideally, each tile should be numbered to ensure that it is reinstalled in its original location. But this may not always

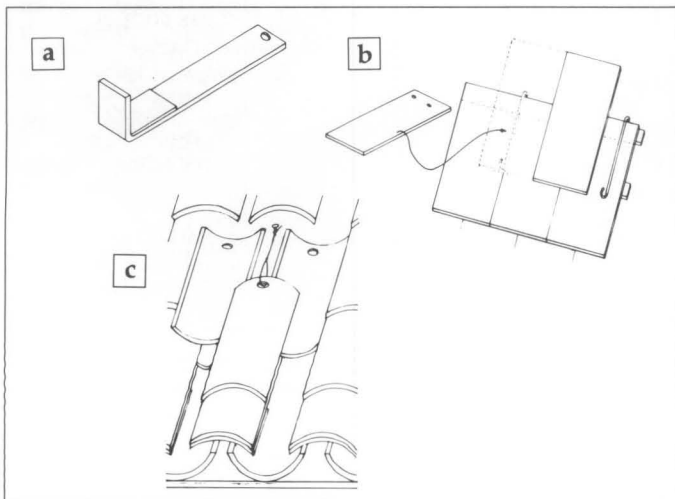
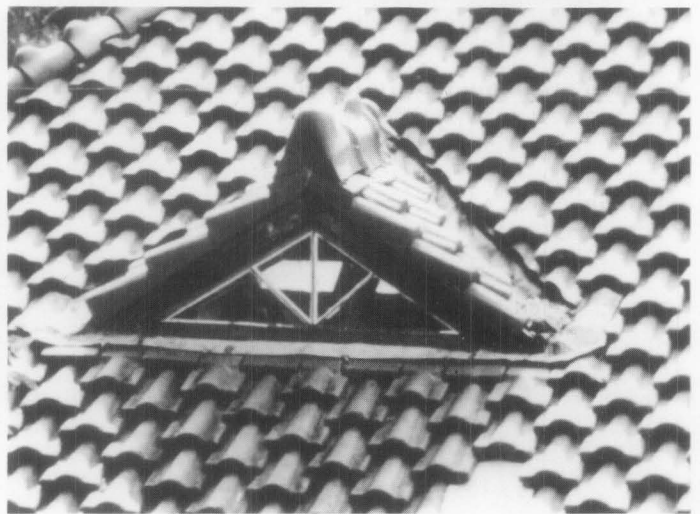
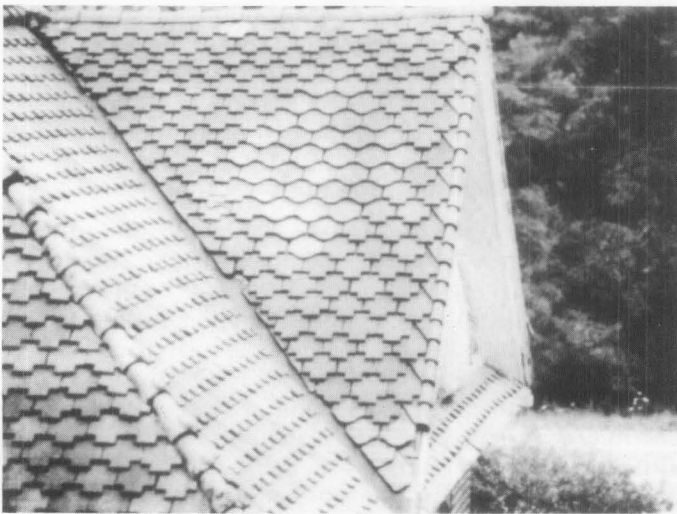
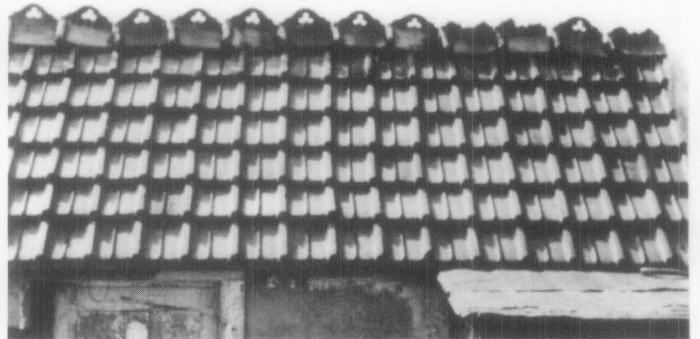
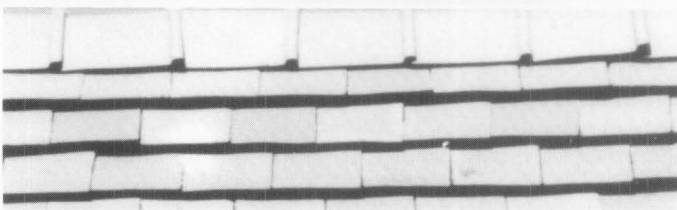
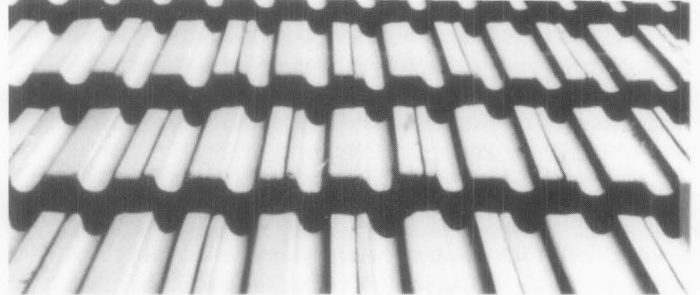

Figure 16. Attachments for repair and replacement of clay tiles include: (a) copper tab, (b) stainless steel or other non-corrosive metal clip, slate hook or "tingle," and (c) nailing and wire nailing. Drawing: Karin Murr Link.

Clay Tile Roofs of Alfred, New York



Taking advantage of high quality local shale ideal for making terra cotta and clay tiles, the Celadon Terra Cotta Company was established in Alfred, New York, in 1889. As a result, an unusually large percentage of historic buildings in this small town are roofed with clay tiles. This includes commercial and residential structures as well as other types of structures not commonly roofed with tile, such as barns and outbuildings. Even early-19th century houses were re-roofed—sometimes incongruously—with clay tiles. Today, the town roofs display an amazing variety of styles and patterns of tiles, many of which may have been factory seconds or experimental designs. In operation for only 20 years when it was destroyed by fire, the company continued manufacturing roofing tiles in New Lexington, Ohio, under the name Ludowici-Celadon. Photos: Terry Palmiter, Courtesy Alfred Historical Society.

be feasible or practical, and it may be enough simply to group the tiles as they are removed by type and size or function—such as field tiles, custom tiles for hips, dormers and ridges, and specially cut pieces. This will help facilitate reinstallation of the tiles. If all of the tiles have to be removed, it is probably a good idea to consider installing a layer of modern roofing felt over the wood sheathing. This will add another layer of waterproofing, while providing temporary protection during re-roofing.

Even if the tiles were originally attached with wooden pegs, it is generally recommended that they be rehung with corrosion-resistant, preferably heavy copper, or aluminum alloy nails or hooks. Today there are numerous non-traditional fastening systems for clay tile roofs, and many of them are patented. Roofing contractors and architects may have individual preferences, and some systems may be better suited than others to fit a particular roof shape or to meet a specific climatic or seismic requirement. Original battens or other roof members that may have deteriorated should be replaced to match the original using pressure-treated wood. Additional support may be necessary, particularly if the original roof was inadequate or poorly designed.

Replacing Flashing

Deteriorated flashing, gutters and downspouts should generally be replaced in kind to match the historic material. Copper or lead-coated copper, if appropriate to the building, or terne-coated stainless steel, is often preferred for use on historic clay tile roofs because of their durability and long lasting qualities. However, copper staining from downspouts can sometimes be a problem on light-colored masonry walls which should be taken into consideration when planning replacements to rainwater removal systems. Clay tile roofs usually have an open valley system where the tiles are separated by metal flashing at intersections of roof sections with different angles. This makes the insertion of new flashing quite easy, as only a few surrounding tiles must be removed in the process. New copper flashing that is too "bright" can be made to blend in and "mellowed" by brush-coating it with boiled linseed oil or proprietary solutions.

Inappropriate Repairs

The most important repair to avoid is replacing broken or missing roof tiles on a historic building with materials other than matching natural clay tiles. Concrete, metal or plastic tiles are generally not appropriate substitutes for clay roofing tiles. They lack the natural color variations of clay tile, and they do not have the same texture, shape, thickness or surface irregularities.

Although much concrete tile and composition tile is produced to resemble the general shape, if not the exact profile, of clay roofing tiles, concrete tile is generally too thick and also lacks the range of colors inherent in natural clay tile. Concrete tile is not a compatible substitute material to repair or replace individual historic clay tiles.

Patching a historic clay tile roof with roofing tar, caulk, asphalt, pieces of metal, or non-matching clay tiles is also inappropriate. Such treatments are visually incompatible. They also have the potential for causing physical damage. Water can collect behind these patches, thus accelerating deterioration of roof sheathing and fastening systems, and

during the expansion and contraction of a freeze-thaw cycle ice build-up at patches can break surrounding tiles.

Summary

Clay roofing tile itself, when correctly installed, requires little or no maintenance. Often, it is the fastening system used to secure the tiles to the sheathing that fails and needs to be replaced rather than the tiles themselves. In fact, because clay tiles frequently outlasted the building structure, it was not unusual for them to be reused on another building. When the fastening system has deteriorated, or the roofing support structure has failed, clay tiles can be removed relatively easily, necessary repairs can be made, and the historic tiles can be re-laid with new corrosion-resistant nails or hooks. Broken or damaged tiles should be replaced promptly to prevent further damage to neighboring tiles or to the roof structure itself.

As with any kind of historic roofing material, regular maintenance, such as cleaning gutters and downspouts, can add to the life of a tile roof. Additional preventive measures may include placing wire mesh over downspout openings or over the entire gutter to prevent debris from collecting and water from backing up. Periodic inspection of the underside of the roof from the attic after a heavy rain or ice storm for water stains may reveal leaks in their early stages which can be eliminated before they escalate into larger, more serious repair problems.

If replacement tile is required for the project, it should match the original tile as closely as possible, since a historic clay tile roof is likely to be one of the building's most significant features. Natural clay tiles have the inherent color variations, texture and color that is so important in defining the character of a historic tile roof. Thus, only traditionally shaped, clay tiles are appropriate for repairing a historic clay tile roof.

Selected Reading

- Azevedo, J. "Tile Roofing." *Fine Homebuilding*. No. 60 (April/May 1990), pp. 36-41.
- Belle, John, John Ray Hoke, Jr., and Stephen A. Kliment, editors. *Traditional Details for Building Restoration, Renovation, and Rehabilitation*. From the 1932-1951 Editions of [Ramsey/Sleeper] *Architectural Graphic Standards*. New York: John Wiley & Sons, Inc. 1991.
- Davis, Charles Thomas. *A Practical Treatise on The Manufacture of Brick, Tiles, Terra Cotta, Etc.* Philadelphia: Henry Carey Baird & Co., 1884.
- Fidler, John. "Tile, Slate and Stone Roofs." *Traditional Homes Technical Information Leaflet*. Number 1. 1991.
- Labine, Clem. "How to Repair an Old Roof." *The Old-House Journal*. Vol. XI, No. 3 (April 1983), pp. 64-69
- Labine, Clem, and Judith Siegel Lief. "The Rise of the Ornamental Roof," and "Traditional Building's SourceList of Traditional Roofing & Specialties." *Traditional Building*. Vol. 5, No. 3 (May/June/1992), pp. 35-46.
- Melville, Ian A., and Ian A. Gordon. *The Repair and Maintenance of Houses*. London: The Estates Gazette Limited, 1973.
- Poore, Patricia. "Tile Roofs." *The Old-House Journal*. Vol XV, No. 5 (September/October 1987), pp. 22-29.
- "Special Roof Issue." *The Old-House Journal*. Vol XI, No. 3 (April 1983).

Sweetser, Sarah M. *Preservation Briefs 4: Roofing for Historic Buildings*. Washington, D.C.: National Park Service, U.S. Department of the Interior, 1978.

Vogel, Neal A. *Roofing Houses of Worship: Roofing Guidance for Church and Temple Administrators*. Information Series No. 59. Chicago: National Trust for Historic Preservation and Inspired Partnerships, 1992.

White, Richard. *Olmsted Park System, Jamaica Plain Boathouse, Jamaica Plain, Massachusetts: Planning for Preservation of the Boathouse Roof*. Preservation Case Studies. Washington, D.C.: Heritage Conservation and Recreation Service, U.S. Department of the Interior, 1979.

Selected Sources of Clay Roofing Tiles

Boston Valley Terra Cotta

6860 South Abbott Road
Orchard Park, NY 14127
Custom-made architectural terra cotta and clay roofing tiles

C.C.N. Clay Roof Tiles (Canteras Cerro Negro S.A.)

8280 College Parkway, Suite 204
Ft. Myers, FL 33919
Distributors of C.C.N. clay roofing tiles from Argentina

Earth/Forms of Alfred

5704 East Valley Road
Alfred Station, NY 14803
Made-to-order reproduction clay roofing tiles

Gladding, McBean & Co.

P.O. Box 97
Lincoln, CA 95648
Manufacturer since 1875 of terra cotta and clay roofing tiles, and custom reproductions

Hans Sumpf Company, Inc.

40101 Avenue 10
Madera, CA 93638
Made-to-order Mission-style clay roofing tiles

International Roofing Products, Inc.

4929 Wilshire Blvd., Suite 750
Los Angeles, CA 90010
New clay roofing tiles, some suitable for historic buildings

London Tile Co.

65 Walnut Street
New London, OH 44851
Made-to-order reproduction clay roofing tiles

Ludowici-Celadon, Inc.

4757 Tile Plant Road
New Lexington, OH 43764
Manufacturer since 1880s of clay roofing tiles, and custom reproductions

M.C.A. (Maruhachi Ceramics of America, Inc.)

1985 Sampson Avenue
Corona, CA 91719
New clay roofing tiles, some suitable for historic buildings

The Northern Roof Tile Sales Company

P.O. Box 275
Millgrove, Ontario LOR 1VO, Canada
Traditional clay roofing tiles imported from England and South America

Raleigh, Inc.

6506 Business U.S. Route 20
P.O. Box 448
Belvidere, IL 61008-0448
Inventory of new and salvage clay roofing tiles

Supradur Manufacturing Corp.

P.O. Box 908
Rye, NY 10580
Imports Spanish ("S") clay roofing tiles from France

TileSearch

P.O. Box 580
Roanoke, TX 76262
Computerized network for new and salvage clay roofing tiles

United States Tile Company

P.O. Box 1509
909 West Railroad Street
Corona, CA 91718
New clay roofing tiles, some suitable for historic buildings

Note: Measurements in this publication are given in both the U.S. Customary System and International (Metric) System for comparative purposes. Metric conversions are, in some cases, approximate and should not be relied upon for preparing technical specifications.

Acknowledgements

Anne Grimmer is a senior Architectural Historian with the Preservation Assistance Division of the National Park Service; **Paul K. Williams** is a Cultural Resource Manager with the Air Force. Both authors wish to thank the following individuals for the technical assistance they provided in the preparation of this publication: Edna Kimbro, Architectural Conservator, Watsonville, CA; Edwin S. Krebs, AIA, K. Norman Berry Associates, Louisville, KY; Melvin Mann, TileSearch, Roanoke, TX; Walter S. Marder, AIA, Division of Historical Resources, Tallahassee, FL; Gil Sánchez, FAIA, Gilbert Arnold Sánchez, Incorporated, Santa Cruz, CA; Terry Palmiter and Sandra Scofield, Alfred, NY; and National Park Service professional staff members. In addition, the authors wish to thank Karin Murr Link, who produced the drawings which illustrate this Brief.

This publication has been prepared pursuant to the National Historic Preservation Act of 1966, as amended, which directs the Secretary of the Interior to develop and make available information concerning historic properties. Comments on the usefulness of this publication may be directed to H. Ward Jandl, Chief, Technical Preservation Services Branch, National Park Service, P.O. Box 37127, Washington, D.C. 20013-7127. This publication is not copyrighted and can be reproduced without penalty. Normal procedures for credit to the authors and the National Park Service are appreciated.

ISSN: 0885-7016

Spring 1993

Cover photograph: Restoration of the 1820s Indian barracks at Mission Santa Cruz in California included custom-made tapered barrel clay roof tiles based on archeological data found at the site. Photo: Ron Starr Photography.