

# History and overview of fabric formwork: using fabrics for concrete casting

*The concept of casting concrete in fabrics, fabric formwork technology, has resurfaced at various times and in different forms throughout the past century. The following paper traces developments that have used fabrics for concrete formwork, including different types of flexible formwork, controlled permeability formwork and pneumatic formwork. This paper presents a comprehensive historical overview of fabric formwork, listing key innovators, technological developments and their advantages, and offering examples of structures built with these methods. The information gathered is used to present a taxonomy of these related formwork technologies as well as a formal definition of the term "fabric formwork" that encompasses them. The paper is intended to introduce readers to these technologies and offer readers already familiar with these methods additional historical background.*

**Keywords:** fabric formwork, flexible membrane, textile mould, structural concrete, history, taxonomy

## 1 Introduction

Fabric formwork is a building technology that involves the use of structural membranes as the main facing material for concrete moulds. Unlike traditional formwork, the material is highly flexible and can deflect under the pressure of fresh concrete. The resulting forms exhibit curvature as well as excellent surface finishes that are generally not associated with concrete structures. By tracing the historical use of fabrics in concrete formwork, all types of this technology are identified and discussed.

## 2 Roman times

The invention of fabric formwork came about as a result of the Industrial Revolution, but it is interesting to note some early parallels in Roman engineering.

For the construction of cofferdams, the Roman architect and engineer *Vitruvius* explains a method of creating two retaining walls that are filled with clay in woven reed baskets. Also, for the construction of vaulting with a plaster finish, *Vitruvius* recommends the use of reeds tied

together to form the lower surface on which a sand mortar is applied. This is the basis for further coats before applying the plaster [1].

Vaults at an aqueduct near the cities of Cherchell and Menacer, Algeria (Fig. 1), and in an underground settling chamber beneath the Villa Medici in Rome (Fig. 2) show impressions and remnants of reeds. It is believed that in the first case, reeds covered the centring, which allowed easy removal of the falsework after the concrete had hardened [2]. In the latter case, it is speculated that the bent, freshly cut reeds formed the centring itself, supporting a primary, thin layer of concrete as it hardened before casting the rest of the structure [3]. In both cases, the reeds were laid in a single direction, probably tied together as *Vitruvius* suggested. Reed was an abundant resource, both lightweight and flexible. It is probable that these building methods were favoured due to the fact that these underground structures were hard to reach with conventional formwork materials, and also had no requirements for the surface finish.



**Fig. 1.** Impressions of reeds in the vault of a channel near Menacer, Algeria. Reproduced by permission of *Cees Passchier*



**Fig. 2.** Reed centring in the Roman concrete vaults beneath the Villa Medici, Rome. Reproduced by permission of *Matthew Bronski*

\* Corresponding author: [veenendaal@arch.ethz.ch](mailto:veenendaal@arch.ethz.ch)

Submitted for review: 22 March 2011

Revised: 18 April 2011

Accepted for publication: 15 May 2011

### 3 Early beginnings: Gustav Lilienthal (1849–1933)

Several crucial developments in fabric formwork took place in the late 18th and the 19th century. Various new technologies of the Industrial Revolution brought about an abundance and wide variety of affordable and quality textiles, concrete and steel.

The first appearance of fabric formwork can be attributed to *Gustav Lilienthal* (1849–1933) [4]. *Lilienthal*, born in Anklam, Germany, first trained as a mason and then studied architecture before becoming something of an inventor, entrepreneur, architect and builder. At some point he built a house in Berlin for his family. He actively promoted the qualities of this house, which led to a series of over 30 buildings during the 1890s, many of which included several of his innovations. *Lilienthal's* proficiency as a builder and inventor, combined with his interest in textiles, led to his invention of a fabric-formed suspended floor, patented in the USA in 1899 (Fig. 3) [5]. This floor featured an impermeable fabric or paper draped over parallel beams, on top of which wire netting was placed before pouring the concrete in successive layers. He already acknowledges an interesting aspect of fabric formwork, observing that the interaction of the wire mesh, paper and wet concrete leads to a surface “similar to that of a sofa cushion”. A 1934 patent by *James Waller* [6] mentions a comparable floor system but expands on the concept. His ideas will be discussed in the following section. A concept almost identical with that of *Lilienthal* was filed for application in India (Fig. 4) [7] in 1937 and identifies the savings on centring and falsework materials and labour as a major advantage. It also focuses on the fact that no skilled labour is necessary. It expands on the possible formwork materials, listing hessian, cotton, wool and paper, and suggests carpets of grass or leaves. A 1971 patent for an entire building [8] uses a combination of sheet material and belts. It recognizes the same economies in construction and also calculates a 20% saving in concrete due to the parabolic shape following the bending moments of the span. As with the previous patents of *Lilienthal* and *Farrar*, reinforcement is also in the form of a wire mesh, but the possibility of prestressing the mesh is mentioned as well.

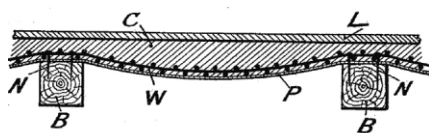

Fig. 3. Patented floor system [5]

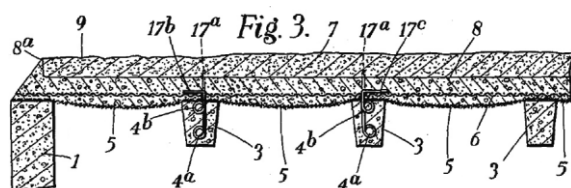

Fig. 4. Patented floor system [7]

### 4 Large-scale applications: James Waller (1884–1968)

Arguably the most prolific inventor in the field of fabric formwork was *James Hardress de Warenne Waller* [9, 10, 11]. Born in Tasmania, he left for his parent's homeland, Ireland, at the age of 20 in order to study engineering at Queen's College Galway and in Cork. He developed an interest in reinforced concrete soon after and started an engineering firm in Dublin. When World War I broke out, he saw service around the Mediterranean in the Royal Engineers, specifically in Turkey, Serbia and Greece. While in Salonika, Greece, *Waller* noticed that cement dust blown onto a wet tent rendered the canvas amazingly strong. It was this incident that resulted in his patented “Nofrango” system. Hessian, or a woven fabric made from any vegetable fibre, is stretched over a timber frame and plastered with cement mortar. The first US patent for this system describes several applications of this idea other than the flooring system mentioned (Fig. 5) [6, 12]. Upon inspection, these examples may be categorized into four distinct types;

- Draped (stretched in one direction) and plastered (floor, roof)
- Stretched and plastered (wall)

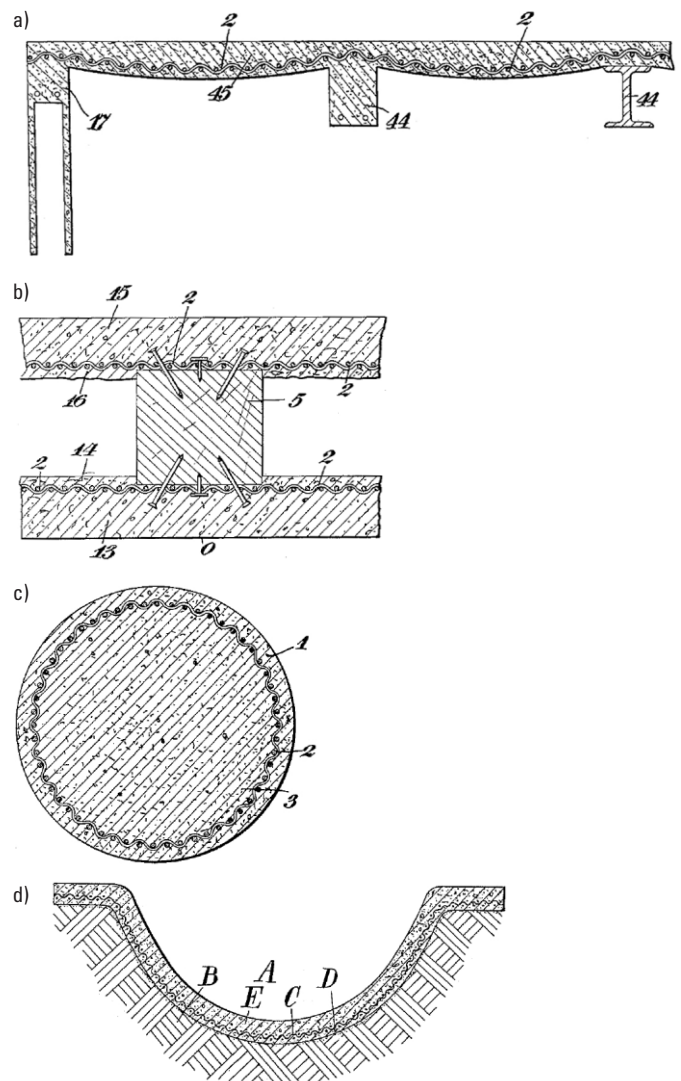

Fig. 5. Four distinct fabric-formed constructions patented by *James Waller* [6, 12]

- Filled and stressed through hydraulic pressure (column)
- Level, lying on the ground (ground floor, liners)

A second patent soon followed and suggests various applications in hydraulic and geotechnical engineering as a liner for embankments, canals, etc. [12]. *Waller* himself noted that this invention allowed for innumerable other structures. He also deviated from the work of *Lilienthal* and *Farrar* in his designs by underlining the tensile strength of the fabric as it formed the sole reinforcement in most cases. *Waller* had uncovered the versatility of fabric formwork, although in these first instances his designs did not reach beyond two dimensions, dealing only with linear or planar elements.

Further inspiration followed a visit in 1922 to the deserts near Baghdad, where he stood in awe of the great Taq-i Kisra arch of the ancient imperial city of Ctesiphon (Fig. 6). He called it the first column-free rectangular building of importance. He held its catenary profile in high regard, keeping a drawing board against his office wall with a chain suspended from two drawing pins [13]. He noted that “engineers are frequently unkind in their treatment of concrete, impolitely regarding its aversion to tensile stress” and that “gravity is destructive to the beam-truss-girder family, but bestows stability upon the arch”. In “rescuing the arch from comparative obscurity”, he needed a construction method to create shells with corrugations for stiffness. He was reminded of the roof construction of a chicken coop with stretched hessian (Fig. 7). The fabric, supported at the eaves and by a system of temporary poles and wires, sagged between the supports. He extrapolated this observation to build shells using parallel falsework arches and allowing the fabric to sag in between to form corrugations (Fig. 8). The first thin coat of cement, and the deflections thus produced, determined the depth of the corrugations together with prestress and rib spacing. He used the purely compressive structural shape of the inverted catenary arch for the ribs to minimize the amount of reinforcement needed to construct the shell of a building. This building method appealed to the rise in demand for unobstructed covered spaces and the wartime shortages of steel. Completed buildings demonstrated simplicity of construction and calculation, relying on just a few unskilled labourers, who could complete the construction work in a short time. Overall, these structures were evidently very competitive, illustrated by the construction of over 50 concrete shells with spans of between 6 and 12 m during the war. *Waller* modified this “Ctesiphon” system in 1954 for the construction of granary domes in Cyprus, called Cyprus bins (Fig. 9). He patented a specific system in 1955 for spans of up to 150 m using prefabricated, external trussed arches from which to suspend the fabric. For these larger spans, reinforcement was necessary and the use of a cement gun was recommended, a precursor to later experiments for building shells with shotcrete. In the end, between the 1940s and 1970s, the Ctesiphon system had been employed in one form or another for housing, storage and factories around the globe, including the UK, Ireland, Zaire, Zimbabwe, Tanzania, Nigeria, Kenya, Australia, Spain, Greece and India. In India, the engineer and shell builder *Gururwayur Ramaswamy* used the Ctesiphon method, but also developed his own method of casting



Fig. 6. The ruins of the Taq-i Kisra palace at the ancient city of Ctesiphon [9]

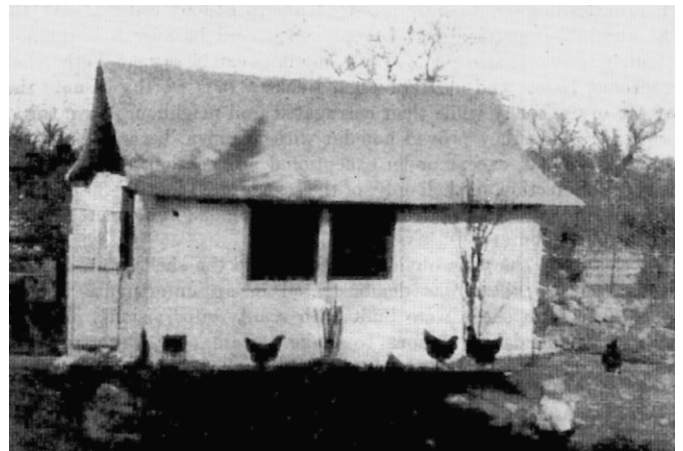

Fig. 7. *Waller's* first fabric-formed roof – and its inhabitants! [9]

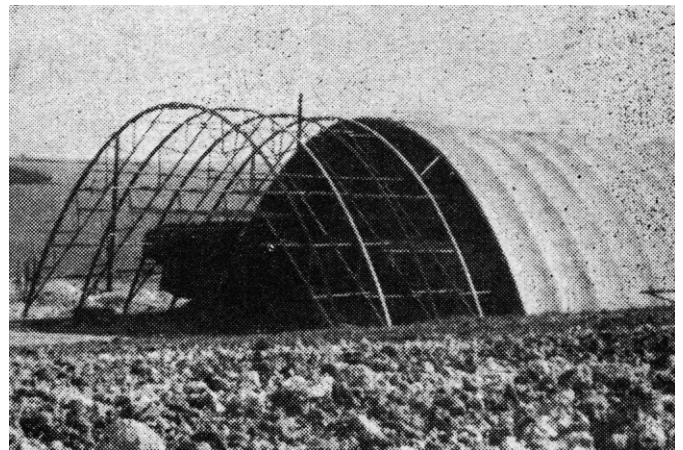

Fig. 8. A Ctesiphon shell under construction [9]

medium-sized modular shells in fabric and inverting them [14, 15].

The disappearance of this building method may be related to the general decline of shell building, but specific criticism of the Ctesiphon system did arise, such as the likelihood of cracking at the top of the ribs [16] and the poor thermal quality [17].

Though few Ctesiphon structures survive today, their legacy may be measured by the inspiration they gave the



Fig. 9. A Cyprus bin under construction in Nakuru, Kenya (photo by Grant Maslen). Reproduced by permission of Hilary Hann

great shell builder *Felix Candela* in his early work. Having graduated in 1935 at the *Escuela Superior de Arquitectura* in Madrid, *Candela* found himself forced to move to Mexico after the Spanish Civil War. He would spend the greater part of the 1940s devoting himself to literature on shell design, analysis and construction. Given the rigour with which he assessed various papers, it should be an honour to the work of *James Waller* that *Candela* selected the Ctesiphon method for his first shell, an experimental vault in San Bartolo, Mexico. He used the method again for a rural school near Ciudad Victoria in 1951, before moving on to other geometries that required other approaches to construction [18].

##### 5 Architectural expression: Miguel Fisac (1913–2006)

Up to this point in history, the use of fabrics in formworks was purely utilitarian, seen as a simple and cost-effective strategy in construction, although *Lilienthal* had commented on the resulting texture of the concrete. The first person to truly acknowledge the architectural and aesthetic possibilities of fabric formwork was the Spanish architect *Miguel Fisac* [19].

It may be no more than a matter of coincidence that *Fisac* graduated from the same *Escuela Superior de Arquitectura* seven years after *Candela*. After steadily growing into his own as an architect and expanding his architectural horizon with visits throughout Europe and later to Japan, *Fisac* would enter his most productive decade in the 1950s. His own ideas led him to new discoveries, first patenting a new type of lightweight brick and later his signature invention of distinctive-looking, hollow post-stressed beams. These beams, reminiscent of bone structures, already led to a preoccupation with the texture of concrete as he “rebelled against the farce that was going on, and in which [he] had participated, of shuttering with boards and borrowing the wood-grained quality of the surface to imprint it, inappropriately, onto the concrete. [He] decided to get rid of this incorrect texture” [19]. In the wake of these inventions and numerous projects throughout Spain, he was able to reconsider radically the material and architectural qualities of concrete, and patented a new idea which he used in 1969 at the Centro de Rehabil-

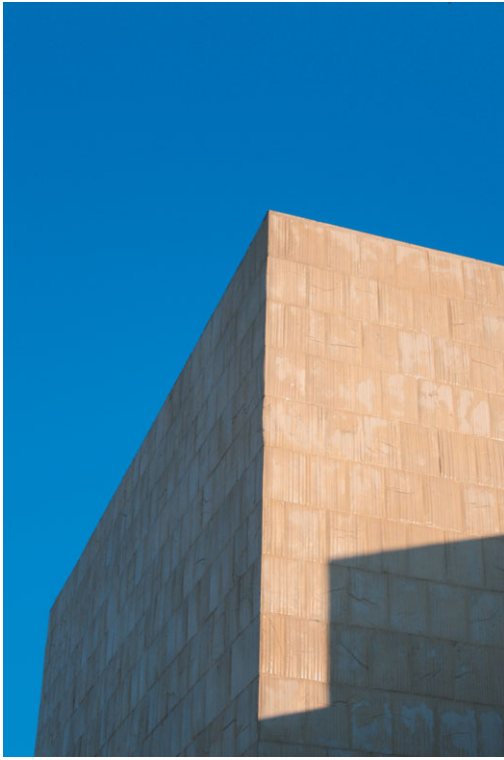

Fig. 10. Centro de Rehabilitación para la MUPAG (1969). Reproduced by permission of Fundación Miguel Fisac.



Fig. 11. Ybarra Hotel Tres Islas (1972). Reproduced by permission of Fundación Miguel Fisac

itación para la MUPAG in Madrid (Fig. 10). He used smooth and flexible polyethylene lamina hanging from a rigid structure as a formwork. “The result that the weight of this soft material gives to the concrete when poured is real and effective; the concrete takes on the texture of the material in a tactile way” [19]. This allowed *Fisac* the freedom to create a variety of new façade panel types, giving each building a specific look and feel when this method was used. This unconventional expression of concrete led to a humorous misunderstanding as investors of the Hotel Tres Islas mistook the concrete for plastic and complained that the “plastic” façade panelling would deteriorate too quickly (Fig. 11) [20]. *Fisac* would use the method throughout the 1970s to great effect, employing it for the last time in 2000 at the Teatro Municipal Miguel Fisac in Castilblanco de los Arroyos (Fig. 12).



**Fig. 12.** Detail of the Teatro Municipal Miguel Fisac in Castilblanco de los Arroyos, Spain (2000). Reproduced by permission of Álvaro E. Gómez González

During the late 1980s and early 1990s, similar use was made of fabric in Canada by the second author, *Mark West*, and by *Kenzo Unno*, both working independently. *Unno*, in search of simple, alternative, low-cost construction methods, discovered the strength of plastic netting as a formwork material and subsequently developed a fabric formwork system for loadbearing walls (Fig. 13). Meanwhile, in Canada, *West* began a series of fabric formwork inventions originating out of sculptural practice, helped by his training as a builder and his education as an architect. This work, which began with column forms, eventually included flexible formwork methods for panels (Fig. 14),

walls, slabs, beams and thin shells, all using flat sheets of fabric (usually woven geotextiles).

## 6 Hydraulic and geotechnical engineering

Applications for fabric formwork were invented in hydraulic engineering quite separately from the developments in building construction. The earliest uses are found in early 20th century patents for concrete-filled burlap mattresses as river or coastal revetments [21, 22] and for a system of filling underwater waterproof bags with concrete for foundations [23]. The novelty of these inventions has to be put in the context of the preceding uses of bags or mattresses filled with sand, stones or other heavy materials.

The introduction of durable woven synthetic fabrics was an event that changed the history of fabric formwork. These fabrics are very inexpensive and very strong; they exhibit high tear propagation resistance and concrete does not adhere to them. They entered the construction market as geotextiles and would allow the current renaissance in fabric formwork technology and applications. Their widespread availability would lead to a large number of new patents beginning in the 1960s with applications by *Hillen* [24, 25, 26]. The most prolific inventors include *Bruce Lamberton* in the 1960s, *Lee Turzillo* in the 1960s and 1970s and *John Scales* in the 1980s, together discussing a wide variety of hydraulic and geotechnical engineering applications, e.g. foundations and injection grouting. One translation from mattresses to building foundations was acknowledged in a patent by *Werner Gebhardt* [27]. His patent was later referenced by *Rick Fearn* in 1993 [28], who has patented several geotechnical applications and seen them used successfully in many buildings throughout Canada and the USA (Fig. 15), as marketed by his company Fab-Form Industries. The company also produces fabric formwork for circular columns, reminiscent of *Waller's* earlier invention, and a wall system, similar to that used by *Kenzo Unno*. *Fearn* worked on these systems roughly around the same time as *West* and *Unno*, but also independently.

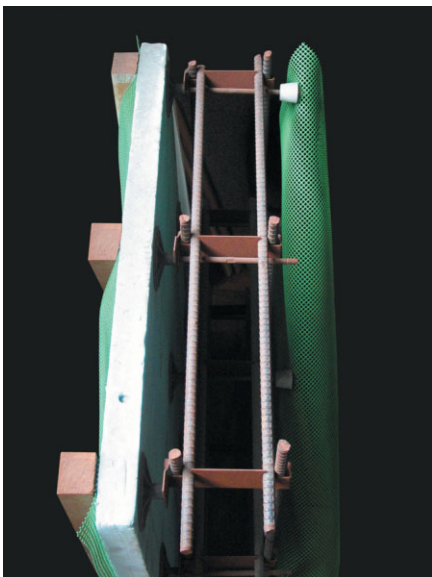

**Fig. 13.** Zero-waste formwork by *Kenzo Unno* and resulting wall in the "URC house with grass" in Edogawa-Ku, Tokyo, Japan (2003)



Fig. 14. Wall panel system developed by CAST



Fig. 15. Black Tree House (2007) during construction of fabric-formed walls and columns, and after completion. Reproduced by permission of Arro Design, Sandy Lawton

The many patents that followed in the footsteps of *Hillen* did not fundamentally change the concept of these fabric-formed structures. However, some notable ideas mentioned in these patents include:

- A concrete-filled tube as an arch form [26]
- Nylon fibre reinforcement for concrete [25] predating modern interests in the use of steel and polymer fibre reinforcement
- The use of dry cement-filled bags that require the addition of moisture instead of pumping concrete into empty bags [29]
- The use of stacked fabric-formed bags as low-cost building walls [30]

The developments in fabric formwork for hydraulic and geotechnical engineering are particularly noteworthy because, contrary to *Waller's* shells and *Fisac's* façade panels, they represent a continuous stream of innovation, with the various contributing engineers acknowledging each other (although conflicting reports have been written on

the origin of fabric formwork within this field). It may be worth noting that engineering perhaps shares the scientific community's tradition of building on previous research, whereas the construction industry relies on competition, and architecture works through the idea of individual authorship and creativity.

Several companies still operate today based on these patents (Fig. 16). The success of these methods can be attributed to the difficulty of using traditional formwork in water. Fabric-formed revetments have also been shown to be economic and structurally superior alternatives to conventional rip-rap, i.e. rubble protection for shorelines [31, 32]. Another notable advantage was the discovery that excess water, escaping through the fabric, led to a higher concrete strength.

## 7 Fabric as a formwork liner

An early appreciation of the permeability of fabrics is found in a 1936 patent by *Karl Billner* [33], who developed



**Fig. 16.** Fabric-formed pyramidal support for pipeline. Reproduced by permission of FoundOcean, *Rebecca Morgan*

a complex vacuum apparatus to extract excess mix water from horizontal concrete surfaces. This improves the concrete strength near the surface by lowering the water-cement ratio and reducing the amount of air bubbles and blowholes. The principle of vacuum improvement of concrete would be developed further by *Billner* and others. Soon after *Billner's* invention, *Arthur Brooks* and *Byron Bender* patented a passive system with an absorptive mould liner [34]. The permeable, non-adherent form liner they developed consisted of multiple layers and an organic fabric.

During the aforementioned patent boom in fabric formwork of the 1960s, the effect of fabric permeability on concrete strength was observed once more, leading to testing performed by *Bindhoff* as part of his master's thesis in 1968. Some additional research has been carried out since then on the effects of permeability in fabric formwork specifically [32, 35, 36]. Meanwhile, the concept of a fabric form liner similar to that of *Brooks* would resurface in 1988 in a series of patents by *Yokota* et al. for extensive use in the Aseishi-Gawa Dam Project [37]. Japanese patents dating back to 1977 are referenced. The renewed interest in turn led to multiple independent lines of research each attributing different names to the concept of fabric liners, such as the textile form method, silk form method, controlled permeability formwork or controlled permeable formwork, or permeable formwork [38]. In general, research indicates positive effects on the rate of carbonation, chloride ion penetration and surface strength, implying superior durability of concrete cast with fabric liners to a degree that depends on the type of fabric, concrete mix and pressure. Fabrics as formwork liners have therefore become a common option in building practice in cases where concrete surface quality and finish are of high importance.

## 8 Pneumatic formwork

Another related technology was started by *Wallace Neff* in 1942 when he pioneered the use of inflatable domes as formwork for concrete bubble houses (Fig. 17) [39, 40]. As with *Waller's* shell, these inflatable domes used a cement

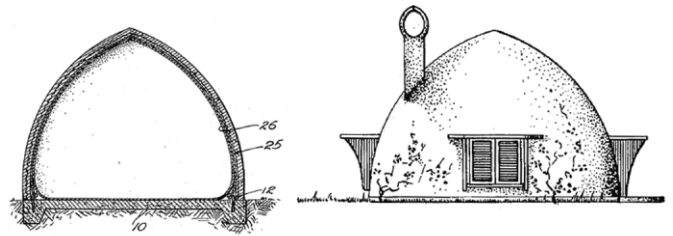

**Fig. 17.** Patent for pneumatically formed concrete shell (*Neff*, 1941)

gun, with the concrete being mixed at the nozzle, i.e. “guniting”. The formwork itself was described in the patent as a rubber-impregnated fabric. The main advantage of this method was that it presented a low-cost way of quickly erecting dome shells by reducing the need for materials and labour. *Neff* envisaged this as a solution to the housing crisis in the 1940s, but also emphasized its aesthetic appeal, saying that “beautiful flowing lines and curves come into being without effort ... The absolute absence of girders, columns and jigsaw trusses startles the imagination”. He felt this method had great potential, and though several were constructed worldwide, few remain, and *Neff* is more commonly remembered as the architect of large Californian mansions, in great demand today among Hollywood's rich and famous [41].

Following *Neff*, *Haim Heifetz* successfully built many shells in Israel during the 1960s using PVC-coated fabrics [42]. At the same time, hundreds of shells constructed by *Dante Bini* in Europe and work by *Horral Harrington* in the USA offered geometric and/or constructional variations on the principle of pneumatically formed shells [43, 44]. The attention given to the concept of inflatable dome shells grew during the 1970s and 1980s, when it was used by various people, one notable example being shell builder *Heinz Isler*. *Isler* had used inflatables for form-finding models, but also developed large-scale experimental buildings in the 1970s. Even today, though the market remains a niche, several companies worldwide specialize in the construction of these types of shells, e.g. Binishells, Pirs, YSM, BB-Con, Monolithic (Fig. 18) and Concrete Canvas. Concrete Canvas uses a patented fibre matrix



**Fig. 18.** Cloud Hidden house, built using pneumatic formwork (2000). Reproduced by permission of the Monolithic Dome Institute

containing a dry concrete mix [45], conceptually similar but more advanced than the 1973 patent of *Kahn* [29].

A related invention, patented by *Raul Mora* in 1968 [46], features a system of multiple, inflated chambers in a wall system, with remaining spaces in the inflated formwork filled with concrete. He based his work on earlier patents by *Charles Ford*, who designed a retractable formwork in 1951, and *Toichi Nose*, who designed an inflatable as a method of constructing pipes in 1926 [47, 48]. *Nose* also mentioned fluids as possible mediums for inflation. *Ford* in turn referenced *Charles Mathews* [49], who used the same principle to create hollow-core concrete structures – an application that proved more popular as it was followed by more patents in the 1970s.

A second related development was the use of under-pressure, or vacuum, to create deflated structures. The earliest use was at Queen's University Belfast in 1970 [50], where several students explored vacuum structures. Other researchers experienced in pneumatic formwork such as *Werner Sobek* have looked into the technology as well [51], and recently it has been considered as a formwork for concrete [50].

## 9 Fabric formwork as a research field

When considering the first decades in the history of formwork making use of fabrics, three things will be noticed:

1. The amount of scientific literature is extremely limited. In general, the best sources on different forms of fabric formwork technology are patents and general articles on their inventors or the resulting buildings. Most papers are found in the field of controlled permeability formworks, dealing with the durability of the ensuing concrete, or pneumatic formworks, dealing mostly with construction aspects such as air pressurization and design methods such as form-finding.
2. Most examples can be distinguished as either non-structural elements used for architectural expression or as structural elements where the fabric formwork offered benefits in construction in terms of saving materials and/or labour.
3. The field is highly dispersed, with most people involved having been unaware of each other. No synergy took place, isolating many of the concepts discussed.

An important change occurred in the 1990s, when *Mark West* of the University of Manitoba in Winnipeg, Canada, founded the Center for Architectural and Structural Technology (CAST), a facility dedicated to the architectural exploration of fabric formwork. While initially unaware of the rich history of fabric-formed structures, their research soon led to contact with both *Rick Fearn* and *Kenzo Unno*, and to the identification of earlier works as detailed in the previous sections. This also led to the first conference on the topic in 2008, held at CAST, the founding of an International Society of Fabric Forming (ISOFF) and the first joint publication detailing the state-of-the-art of fabric formwork [52] by architects and engineers working in the field. This article, too, is an attempt to formalize the field of fabric formwork, and is itself a product of the increasing collaboration among and mutual awareness of researchers in this new field.

Despite these developments and the vast number of projects realized in the past, it must be acknowledged that common uses of fabric formwork are highly specific and specialized, and more recent examples of building structures are rare (Figs. 19 and 20). For fabric formwork to become a more common method in the construction of buildings, significant challenges remain:

- Design: The double-curvature geometries implicit in fabric-formed elements differ significantly from conventional architecture, possibly leading to longer design stages for those who are unfamiliar or uncomfortable with non-orthogonal geometries. Public perception and appreciation of such forms may be a complicating factor that needs to be taken into account.
- Engineering: These types of non-prismatic systems are highly atypical for structural engineering, and standard engineering rules of thumb are not applicable. Both the fabric form-finding and the analysis of complex shapes are difficult and therefore costly exercises in engineering calculus. Analysis is a necessity for the structural use of



Fig. 19. Experimental structure at the Open City, Ritoque, Chile (2003)



Fig. 20. Hanil Guest House, Seoul, South Korea (2009). Reproduced by permission of Byoung Soo Cho architects, *Nicholas Locke*



fabric-formed concrete, especially when it comes to large-scale applications or in cases where the form directly determines the structural behaviour, such as in fabric-formed vaults and shells.

- An additional challenge lies in the state of reinforcement technology, which does not readily lend itself to complex shapes. Experimentation has used developments in reinforcement technologies that lend themselves well to complex shapes, such as passive steel tendons, fibre reinforcement, textile reinforcement and using the formwork fabric itself as permanent external reinforcement.
- Construction: Even when clients, architects and engineers are all enthusiastic about using flexible formwork, builders, who are used to rigid formwork, cannot provide a price for the construction. Builders tend to be conservative and therefore averse to innovation, even where the benefits are clear. Early adopters of new technologies, including fabric formwork, are rare in this industry.

Research into the numerical analysis of fabric formwork has been undertaken on a limited scale and an overview will be presented in a follow-up article. The first author is currently developing a framework for the design and analysis of both the fabric formwork and the resulting concrete structure.

## 10 New explorations in fabric-formed architecture

The line between the purely structural and the purely architectural functions of fabric formwork started to blur during experiments at CAST. Examples of this began with early experiments on highly expressive columns, using spandex at first, geotextiles later, allowing the concrete to bulge outwards at various points. Attention moved to casting beams and floor slabs that varied their shape according to natural force paths, creating a sculptural beauty. This naturally led to experiments with integrated structural systems and efficiently curved bending moment-shaped structures. The past decade of experimentation has also included highly optimized concrete trusses (Fig. 21), double-curvature thin shells and investigations into the aes-



Fig. 21. Fabric-formed truss fabricated at C.-A.-S.-T.

thetic and structural implications of allowing folds and wrinkles in the fabric formwork.

Outside of CAST, the architectural integration of structural and sculptural form provided by a flexible mould material can be found in student experiments and industrial design prototypes. For example, using nylon and plaster, students at the AA in London have mused on the potential of fabric formwork through the creation of models of complex long-span roofs that defy the definitions of columns, beams, slabs or shells (Fig. 22). An experiment at the University of Michigan offers a similar full-scale model employing a rubber membrane (Fig. 23). Another example from a series of tests at the University of Edinburgh reveals a clear trend in the type of fabric formwork shape that is being explored (Fig. 24).

Several industrial designers have used furniture as a method to demonstrate the potential of fabric formwork (Figs. 25, 26, 27 and 28). These examples show interesting shapes with a clear structural function. At first glance, these examples suggest the use of polymers rather than concrete.

Another important investigation is taking place at the University of East London under the supervision of Prof. Alan Chandler. This research is looking into rammed earth fabric-formed walls, using stabilized soil instead of concrete and generally intended for applications in the developing world. Fabric formwork is relatively sustainable due to significant savings on formwork materials, and thus production, storage and transport. Using

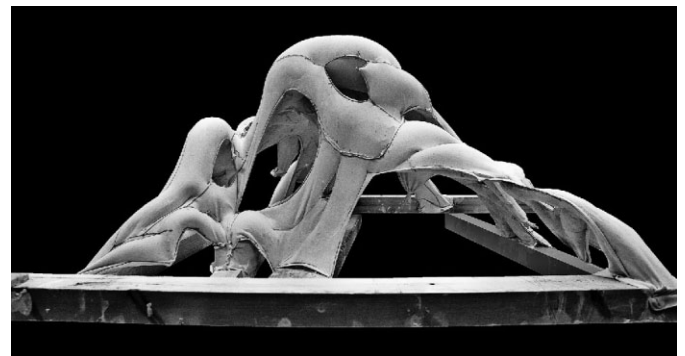

Fig. 22. Gropies, the outcome of a student workshop using nylon and plaster. Reproduced by permission of *Brendon Carlin*, Architectural Association, London



Fig. 23. FattyShell, a student project using rubber and concrete. Reproduced by permission of *Kyle Sturgeon*, University of Michigan



**Fig. 24.** Disruptive Technologies, student project. Reproduced by permission of *Tyler Chan*, University of Edinburgh



**Fig. 25.** Concrete Chair, *Tejo Remy* and *René Veenhuizen*, Reproduced by permission of *Tejo Remy*

rammed earth enhances the sustainability of fabric-formed structures by taking a large amount of cement out of the process.

## 11 Nomenclature, definition and taxonomy

The formwork methods described in this paper are defined here as “fabric formwork” as is the case in most recent



**Fig. 26.** Concrete in a Bag. Reproduced by permission of *Thomas Linssen*



**Fig. 27.** Mass III. Reproduced by permission of *Janwillem van Maele*



**Fig. 28.** Ambiguous Chair. Reproduced by permission of *Anne-Mette Manelius*

publications. These methods have also been referred to as “flexible formwork”, and less commonly as “membrane”, “flexible”, “textile” or “fabric mould”. The latter two terms may lead to confusion because a “textile mould” can also refer to foam-injected moulds, or formwork for textile-reinforced concrete, and a “fabric mould” can refer to historical methods for the production of paper or pottery. The authors propose that a fabric formwork is defined as “a formwork that uses a flexible membrane for the structural

support of fresh concrete or rammed earth”. In this manner, the definition also includes soil, air or fluid pressure-supported formwork as well as the use of different types of fabrics such as non-woven membranes. It excludes the simple use of fabric as a form liner. According to *Abdelgader* et al. [52] four categories grouped by common applications can be distinguished: mattresses, sleeves, shuttering and open troughs. However, these groups do not cover all types of formwork mentioned in this paper.

A new taxonomy is suggested (Fig. 29), based on how the fabric is (pre-)stressed and how the concrete is applied, thus resulting in different geometries. The intention of this taxonomy is not to label and restrict variations within fabric formwork technology, but rather to invite the reader to derive novel applications by thinking about how the fabric can be prestressed and manipulated prior to casting and how it is affected by the amount of concrete applied in the end.

The influence of mechanical prestress is explained in terms of the two prestress directions which typically correspond to the weave directions in woven fabrics. The figure

offers an indication as to what possibilities are inherent in increasing one or both prestress values. Of course, these stresses act relative to the chosen stiffness of the fabric and support conditions.

The Gaussian curvature  $K$  is also shown for some categories, where  $K \neq 0$  denotes double curvature, positive values = convex or concave shapes, and negative values = saddle-like shapes. However, the type of fabric formwork does not necessarily dictate the expression of curvature. If the applied prestress is low, the concrete loads will govern and force the formwork to bulge outwards (forcing positive curvatures).

The figure shows that higher complexity of method and form will generally lead to either the necessity of tailoring or allowing local folding. It is important to note that in each case wrinkling may be introduced intentionally to achieve some effect. Also, hybrids of all these types could be made and, indeed, this has been identified in more recent applications.

Chronological information has been added to demonstrate how the method has developed historically

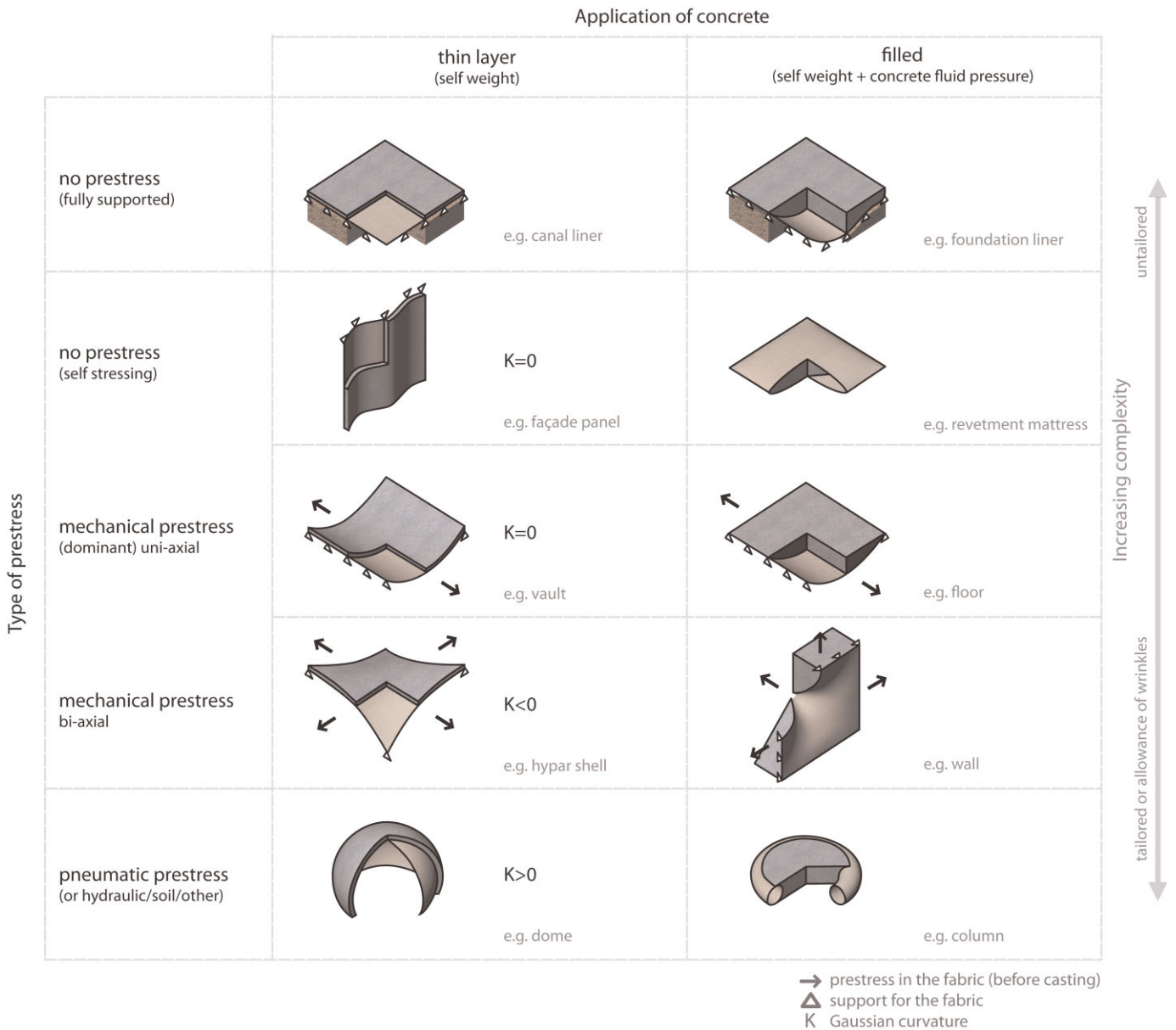

Fig. 29. Taxonomy of fabric formwork and formwork liners

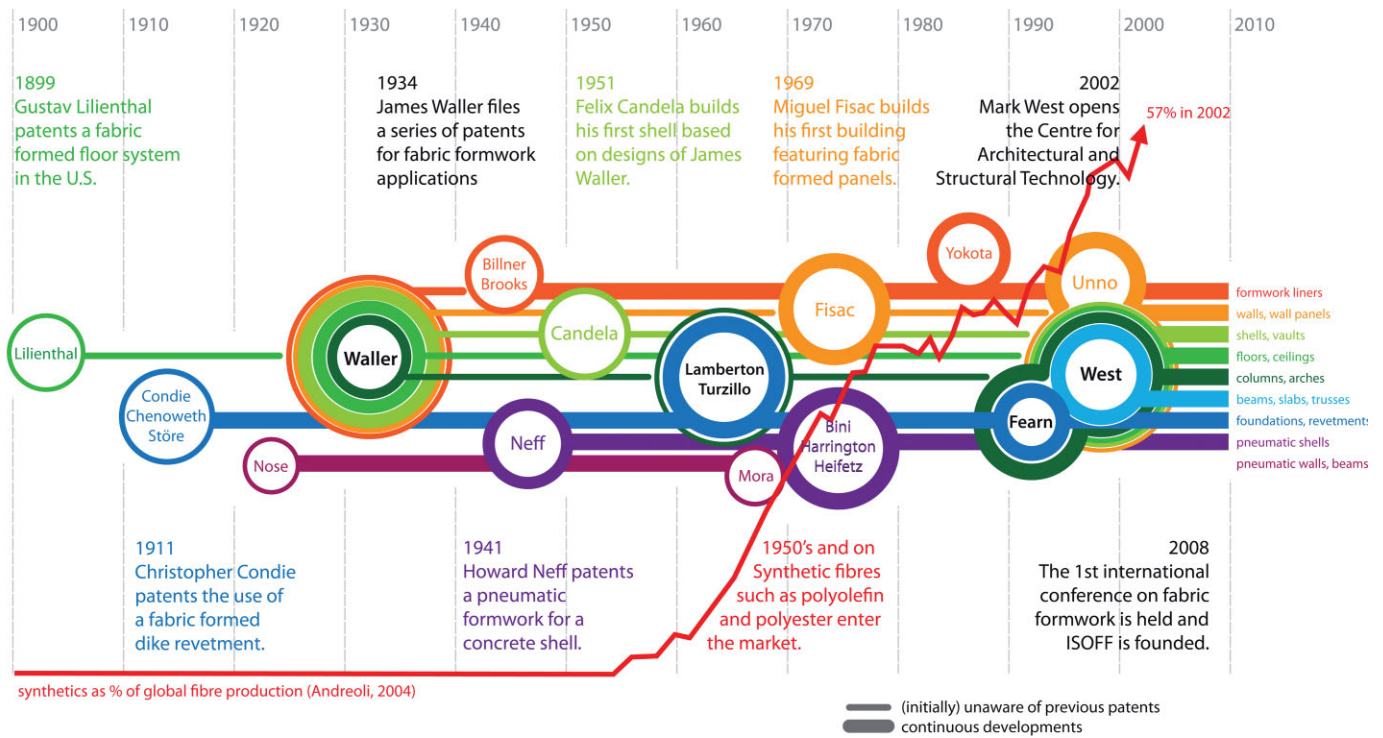

Fig. 30. Chronological diagram of fabric formwork and fabric formwork liners. \*Andreoli, 2004 [53]

through a synthesis of ideas (Fig. 30). Each colour represents a particular type of application and each circle represents single or multiple patents, projects or publications for this application. The lines indicate continuing commercial and academic interest, either inadvertent (thin line) or with each inventor building on previous patents or inventions (thick line). The development and subsequent marketing of synthetic fibres starting around the 1950s is visible as a graph.

## 12 Conclusions

An overview of the historical and technological development of types of fabric formwork has been presented here. Based on the historic overview, a new definition and taxonomy has been suggested to encompass all existing forms of the technology. The history of this technology has been shown to be highly dispersed, divided into different lines of development, with many researchers and inventors who were previously unaware of each other. Many of the initial developments were motivated by a desire to reduce construction time and costs. Increasing availability of synthetic fibres in turn spurred more innovations. The founding of CAST in the 1990s had a similar effect and also led to the growth of a new research community in this field. The extraordinary and surprising concrete shapes made feasible with fabric formwork, explored in particular at CAST and increasingly at other schools of architecture, have attracted fresh attention and subsequent developments. One could suggest that the aesthetic possibilities of fabric formwork are its greatest asset, at least in terms of driving interest in its initial use in buildings. On the other hand, the fact that the term “fabric formwork” can be considered as an oxymoron [54] demonstrates that many preconceived

notions exist regarding what concrete should look like. Indeed, the engineer *Bruce Lamberton*, displaying a not uncommon bias towards prismatic shapes, wrote; “the deeply corrugated or quilted surface of a fabric formwork is an obvious disadvantage”, though he also suggested it posed a positive “challenge to the imaginations of the contractors and engineers of tomorrow” [55]. Others have seen the escape from prismatic geometry as one of the great advantages of flexible concrete moulds in terms of both aesthetics and efficiency.

Seen in this light, fabric formwork generally has two main advantages that do find consensus among those involved. Firstly, potential savings of both formwork materials and reinforced concrete, in turn leading to reductions in transportation, storage and labour as well as dead weight, which can have cascading savings throughout a concrete structure. This in turn can lead to savings in embodied energy and greenhouse gas emissions, making for more sustainable designs. The design of the formwork, the supporting falsework and the attendant concrete shape will determine the degree of these savings. Secondly, the permeability of the fabric will affect the quality of the concrete surface, reducing the numbers of air voids and blowholes, and therefore improving overall durability.

After more than 100 years of developments in fabric formwork technologies, it is possible to conclude that many discoveries have been made, but that current R&D efforts are still largely exploratory and experimental. Modern notions of geometrically complex architecture and sustainable building construction support further development of fabric formwork. Furthermore, decades of engineering tensioned membrane structures has given us appropriate engineering design and analysis tools that may accelerate current research projects undertaken to in-

crease an understanding of the engineering of this technology. Another positive trend is the variety of uses now being employed, the rapid growth in the number of researchers in the field and a higher degree of integration among them and the companies involved. A new synthesis of ideas may be anticipated which may in turn yield unexpected types of fabric formwork as well as new applications for fabric-formed design and architecture.

## Acknowledgements

The authors would like to thank *Juliana Felkner* for her help with the Spanish correspondence with Fundación Miguel Fisac, *Lara Davis* for her comments on the paper, and *Rob Waller* for sharing a few memories of his great uncle, *Jim Waller*.

## References

- Vitruvius*: Ten Books on Architecture. Project Gutenberg, <http://www.gutenberg.org/files/20239/20239-h/29239-h.htm>, 19 Apr 2010, accessed on 7 Sept 2010.
- Passchier, C., Schram, W.*: <http://www.romanaqueducts.info/aquasite/cherchell/index.html>, accessed on 23 Aug 2010.
- Bronski, M.*: <http://vitruviusfootsteps.wordpress.com>, accessed on 23 Aug 2010.
- Liepold, H.*: Das Leben von *Gustav Lilienthal*. In: Miteinander wohnen, Mitteilungsblatt der Gemeinnützigen Baugenossenschaft „Freie Scholle“ zu Berlin eG. May, Aug & Dec, 2007.
- Lilienthal, L. W. G.*: Fireproof Ceiling. U.S. Pat. 619,769, 1899.
- Waller, J. H. de W.*: Method of Building with Cementitious Material Applied to Vegetable Fabrics. U.S. Pat. 1,955,716, 1934.
- Farrar, D., Davidson, J. C. F., Harris, T. G. M.*: Construction of Roofs, Floors, Ceilings and the Like. U.S. Pat. 2,096,629, 1937.
- Parker, S. A.*: Concrete building. U.S. Pat. 3,619,959, 1971.
- Waller, J. H. de W., Aston, A. C.*: Corrugated Shell Roofs. In: ICE Proceedings – Engineering Divisions, vol. 2, No. 4, 1953, pp. 153–182.
- Billig, K.*: 1946. Concrete Shell Roofs with Flexible Moulds. In: Journal of the ICE, vol. 25, No. 3, pp. 228–231
- Anon: Obituary. *James Hardress de Warrenne Waller* (1884–1968). In: ICE Proceedings, vol. 41, No. 3, pp. 443–444.
- Waller, J. H. de W.*: Method of Constructing Canals and the Like. U.S. Pat. 2,015,771, 1935.
- Ross, A. C.*: Correspondence in New Civil Engineer, Thomas Telford, 1975, No. 17, p. 10.
- Ramaswamy, G. S.*: Design and Construction of Concrete Shell Roofs. 1984, pp. 465–466
- Ramaswamy, G. S.* et al.: Casting and Testing a Shell Roof Unit. In: Civil Engineering and Public Works Review. vol. 53, No. 628, 1958, pp. 1155–1157
- Anon: Building in the Tropics. In: The New Scientist, 25 Aug 1960, p. 520.
- Naidu, M. K. S.*: Research in Materials and Construction. In: Journal of the Institution of Engineers (India): Civil Engineering Division, 1963, vol. 44, p. 211.
- Faber, C.*: Candela: The Shell Builder, Reinhold Publishing Corporation, 1963.
- Fundación Miguel Fisac: 2010. Fundación Miguel Fisac, (online) available at: <<http://www.fundacionfisac.org>> (accessed on 7 Sept 2010).
- Fernandez-Galiano, L.* et al.: AV Monografias 101 (2003) Miguel Fisac, Arquitectura Viva, 2003, pp. 101–114.
- Condie, C. C.*: Revetment-Mattress. U.S. Pat. 984,121, 1911.
- Chenoweth, A. C.*: Protective Reinforced Concrete Construction. U.S. Pat. 1,187,502, 1916.
- Störe, J.*: Method of Constructing Subaqueous Concrete Structures. U.S. Pat. 1,421,857, 1922.
- Hillen, H. F. J.*: Form for Constructing a Slab for Talus or Bottom Protection. U.S. Pat. 3,425,227, 1969.
- Lamberton, B. A.*: Method and Arrangements for Protecting Shorelines. U.S. Pat. 3,396,542, 1968.
- Lamberton, B. A.*: Fabric forms for concrete structures. U.S. Pat. 3,425,228, 1969.
- Gebhardt, W.*: Neton- u. Monierbau AG, Verfahren zum saten Anschliessen eines Betonkörpers an eine unregelmässig geformte Fläche unter Verwendung elastischer Schalungen. Germany Pat. 2,062,998, 1972.
- Fearn, R.*: Building Foundation and Floor Assembly. U.S. Pat. 5,224,321, 1993.
- Kahn, L. F.*: Underwater In Situ Placement of Concrete. U.S. Pat. 3,745,775, 1973.
- Dicker, E. T.*: Construction Method of Assembling Bagged, Settable Modules. U.S. Pat. 3,922,832, 1975.
- Koerner, R. M., Welsh, J.*: Fabric forms conform to any shape. In: Concrete Construction Magazine, 1980, vol. 25, No. 5, pp. 401–409.
- Pildysh, M., Wilson, K.*: Cooling ponds lined with fabric-formed concrete. In: Concrete International, 1983.
- Billner, K. P.*: Method of and Apparatus for Treating Concrete, U.S. Pat. 2,046,867, 1936.
- Brooks, A. E., Bender, B. W.*: Absorptive Mold Lining, U.S. Pat. 2,310,391, 1943.
- Al Azwadi Ghaib, M., Górski, J.*: Mechanical properties of concrete cast in fabric formworks. In: Cement and Concrete Research, 2001, vol. 31, pp. 1459–1465.
- Delijani, F.*: The Evaluation of Changes in Concrete Properties Due to Fabric Formwork. Master's thesis, University of Manitoba, Winnipeg, 2010.
- Yokota, T., Horiya, S., Tanaka, K.*: Cloth Faced Form for Forming Concrete, U.S. Pat. 4,787,597, 1988.
- Malone, P. G.*: Use of Permeable Formwork in Placing and Curing Concrete, Technical Report SL-99-12, US Army Corps of Engineers, Washington, 1999
- Neff, W.*: Building construction, U.S. Pat. 2,270,229, 1941.
- Sobek, W.*: Auf Pneumatisch Gestützten Schalungen Hergestellte Betonschalen. PhD dissertation, University of Stuttgart, 1987.
- Daunt, T.*: It's 'dome sweet dome' for pair in mod house. Architect Wallace Neff designed unit as a model for affordable housing. Los Angeles Times, (online) 19 May 2004. Available at: <<http://www.sfgate.com/cgi-bin/article.cgi?f=/c/a/2004/05/19/HOGAU6MV5H1.DTL>> (accessed on 7 Sept 2010).
- Heifetz, H.*: Inflatable Forms, U.S. Pat. 3,643,910, 1972.
- Bini, D.*: Binishells, S.p.A. Method for Erecting Structures, U.S. Pat. 3,462,521, 1968.
- Harrington, H.*: Method and Apparatus for Constructing a Concrete Structure, U.S. Pat. 3,118,010, 1964.
- Brewin, P., Crawford, W.*: Impregnated fabric, European Pat. WO/2007/144559, 2007.
- Mora, R. L.*: Inflatable Construction Panels and Method of Making Same, U.S. Pat. 3,388,509, 1968.
- Ford, C. J.*: Wing-foot Corporation. Retractable Form Structure, U.S. Pat. 2,579,423, 1951.
- Nose, T.*: Process of Constructing Culverts or Pipes of Concrete, U.S. Pat. 1,600,353, 1926.
- Mathews, C. B.* et al.: Inflatable Core for Use in Casting Hollow Concrete Units, U.S. Pat. 2,485,898, 1949.

50. *Huijben, F., Herwijnen, F. van, Nijse, R.*: Vacuumatics 3D-Formwork Systems: Customised Free-Form Solidification. In: Proceedings of International Conference on Textile Composites and Inflatable Structures, Stuttgart, 2009.
51. *Haase, W.* et al.: Vacuumatics – Deflated Forms of Construction. In: Detail, vol. 10, 2007, pp. 1148–1159.
52. *Abdelgader, H., West, M., Górski, J.*: State-of-the-Art Report on Fabric Formwork. In: Proceedings of the International Conference on Construction and Building Technology, Kuala Lumpur, Malaysia, 2008.
53. *Andreoli, C., Freti, F.*: Man-made fibres. Reference books of textile technologies. Fondazione Acimit, Milan, 2004.
54. *Manelius, A.-M.*: Ambiguous Chairs Cast In Fabric Formwork. In: Proceedings of International Conference on Textile Composites and Inflatable Structures, Stuttgart, 2009.
55. *Lamberton, B.A.*: Fabric formwork for concrete. In: Concrete International. Dec 1989, pp. 58–67.



Mark West, Prof., Associate Professor, University of Manitoba  
Centre for Architectural Structures & Technology  
University of Manitoba  
Faculty of Architecture  
Arch-2 Building  
Winnipeg, MB, R3T 2N2, Canada  
Tel. (204) 474-7427  
Fax. (204) 474-7533  
westm@cc.umanitoba.ca



Diederik Veenendaal, MSc, doctoral research assistant, ETH Zurich  
Wolfgang-Pauli-Strasse 15  
HIL E 45.3  
8093 Zurich, Switzerland  
Tel. +41 44 633 28 03  
Fax. +41 44 633 10 41  
veenendaal@arch.ethz.ch



Philippe Block, Prof. Dr., Assistant Professor, ETH Zurich  
Wolfgang-Pauli-Strasse 15  
HIL E 46.1  
8093 Zurich, Switzerland  
Tel. +41 44 633 68 44  
Fax. +41 44 633 10 41  
block@arch.ethz.ch