



Hobie® Mirage®
Compass/Compass Duo

In 1950, Hobie's dream was born in his parents' garage when he decided to apply his love of woodworking to the sport of surfing. Dad backed out the Buick... Hobie carved out his very first surfboard...

Hobie's business of fun had begun.

Anatomy 5

Seating..... 6

MirageDrive® Instructions 10

On the Water..... 13

Lowrance® Ready Option..... 15

Storage and Transport..... 18

Maintenance and Care 21

Kick Up Adjustment..... 23

Safety 24

Warranty 26



**Look for this icon. Online video is available at
www.hobie.com/support**

Please read through the instruction manual before using this product

1. Hull
2. Paddle
3. MirageDrive - (x2 Duo)
4. Seat - (x2 Duo)
5. Cassette Plug - (x2 Duo)
6. Lowrance Ready Kit

1

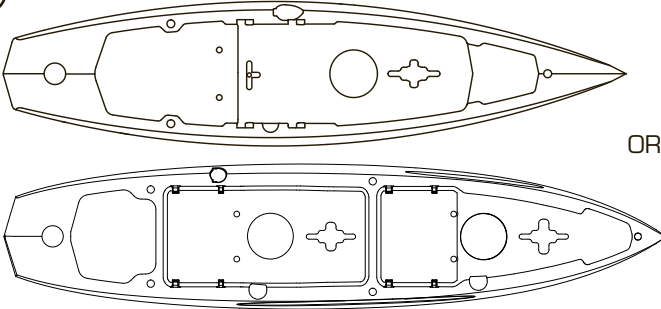

2



3



4

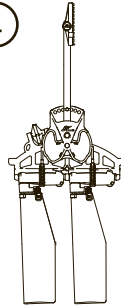

Mirage Drive GT
Kick Up Fins

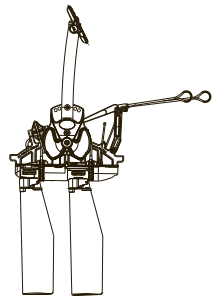

Mirage Drive 180
Kick Up Fins
(Compass Camo Only)

5

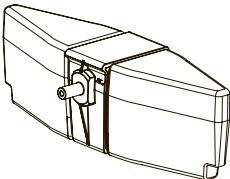

6

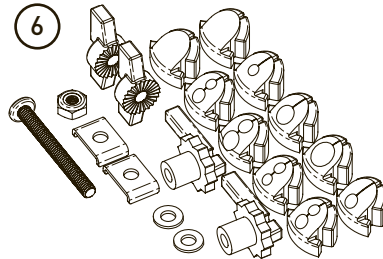

Items not shown to scale

Seating Assembly

①

Line up threaded inserts on seat back frame with holes molded in seat bottom frame.

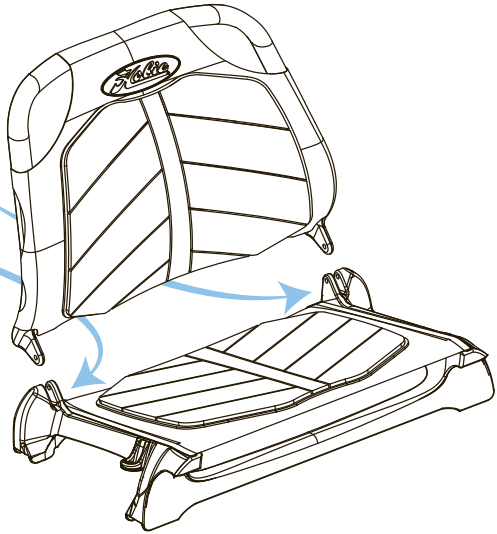

②

Once aligned, insert screws and tighten. Do not over tighten as seat will not be able to pivot.



Seating Anatomy

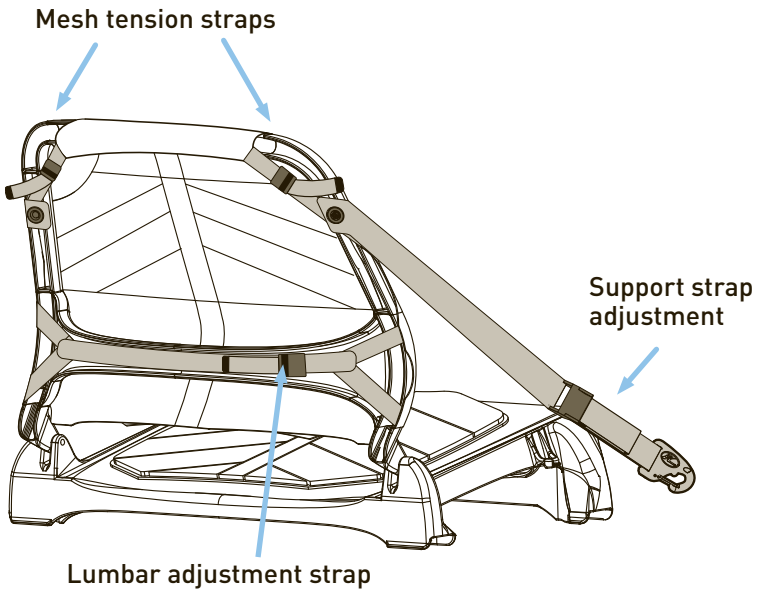
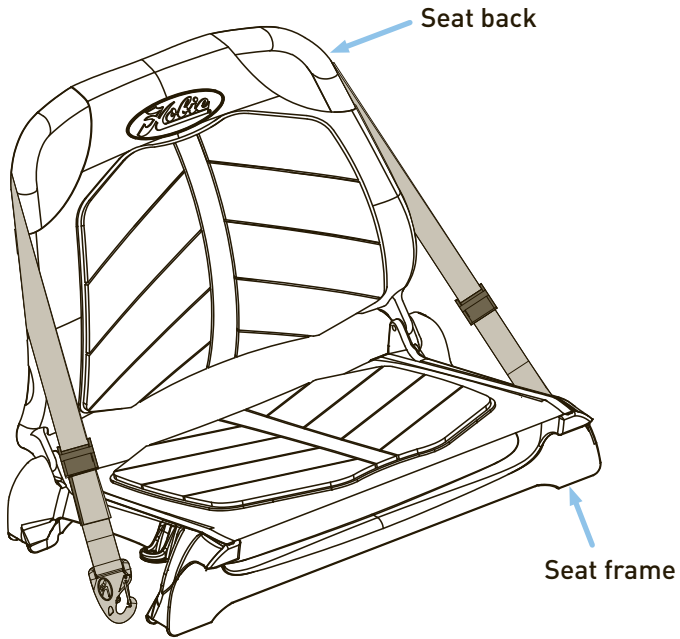

Seat Installation

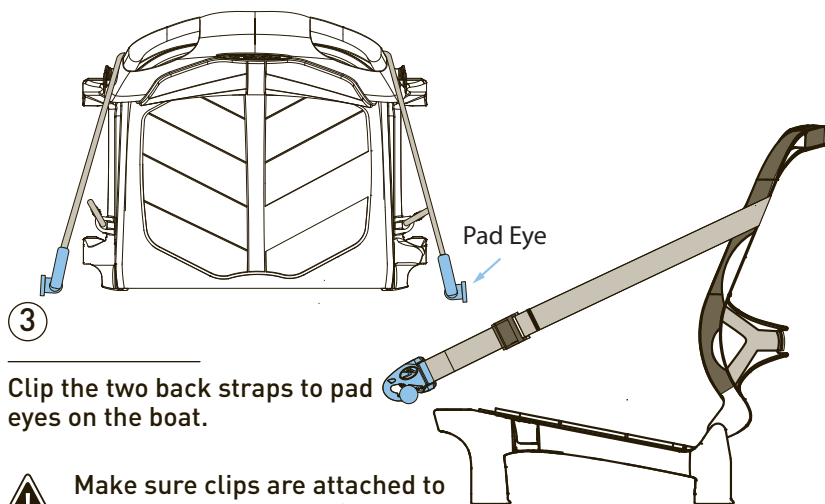
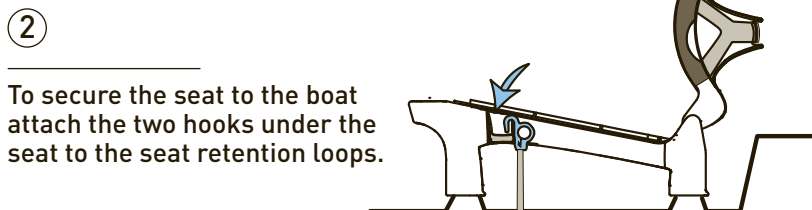
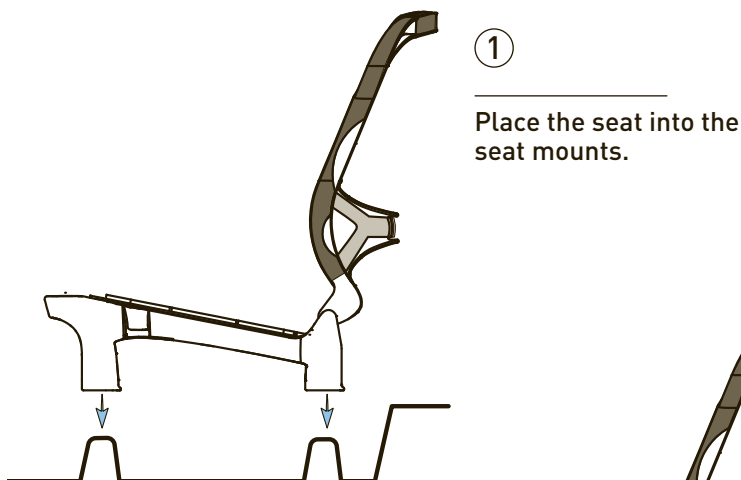

Make sure clips are attached to the boat not the retention loop on the chair itself.

Using the seat outside the boat

①

Unhook the seat retention hooks from the boat and remove the seat.

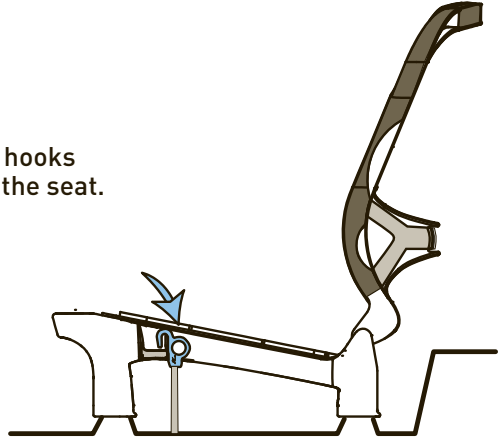

②

Clip the two back straps to the seat retention loop. Adjust strap length so seat is in an upright position.

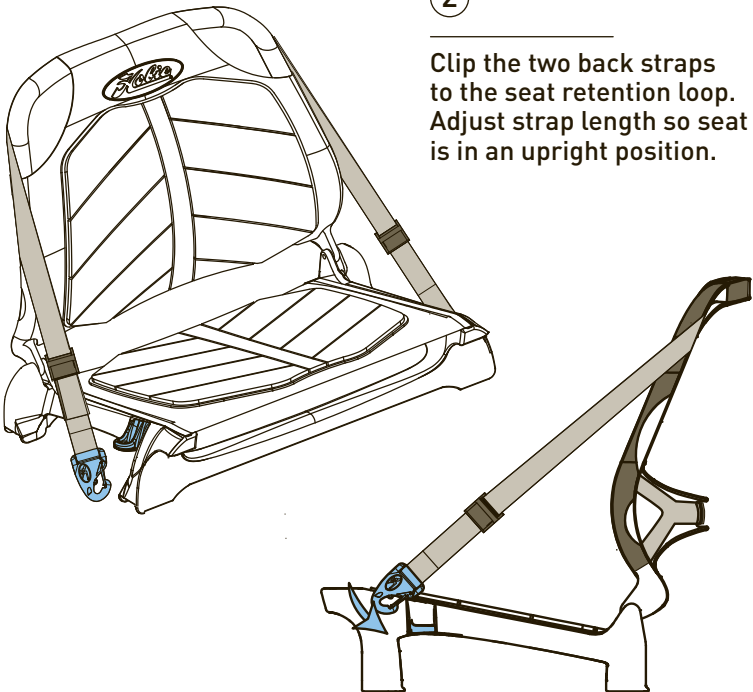

Installation

①

Lower drive straight down making sure the spine is level.

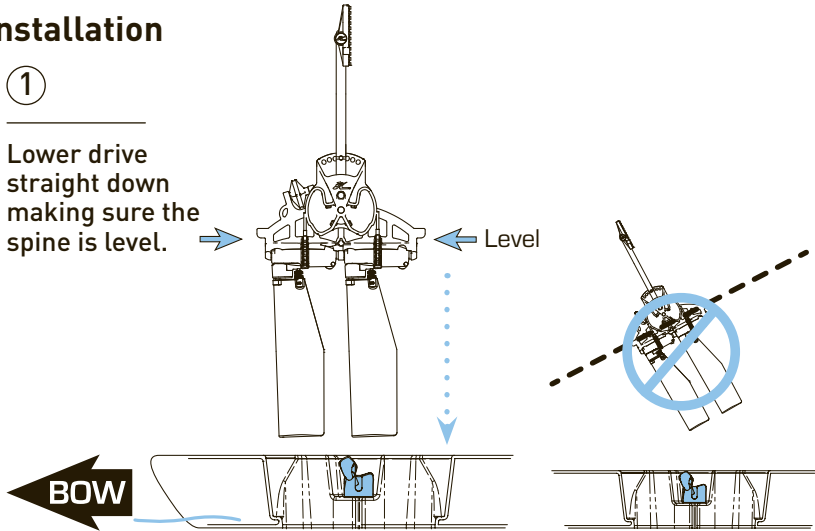

②

Press down and lock drive into Click and Go's. The drive locks automatically when installed.

CLICK

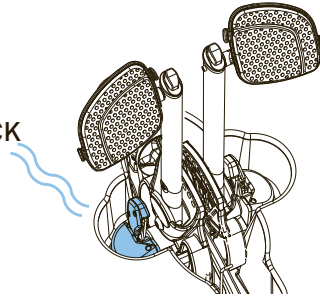

Removal

①

Pull back each Click and Go lever

②

Lift drive straight up

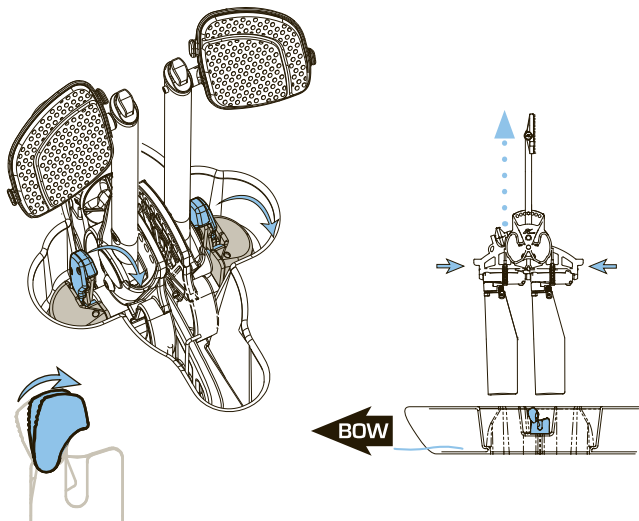

Pedal Adjustment

①

Squeeze
adjuster handle

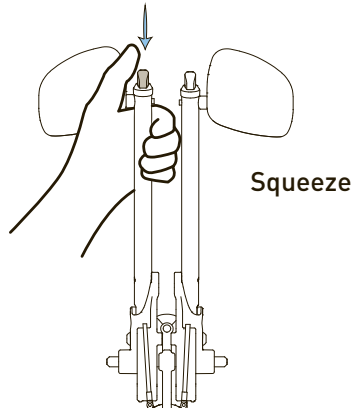

②

Adjust cranks
by rotating and
clicking them
into the desired
position. Make
sure both cranks
are in the same
position number.

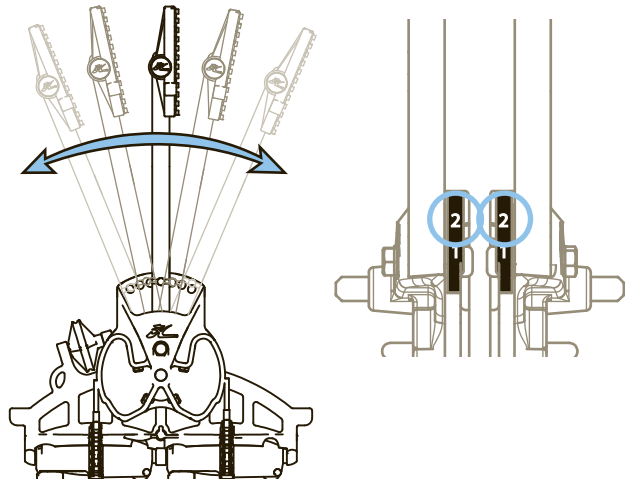

③

With both feet on
the pedals and
together (fins
straight down),
your knees should
be comfortably
bent and not
crunched or over
extended.

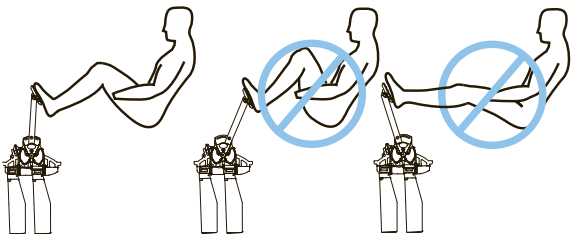

Reverse



Shifting with the fins too far apart can cause interference with the shift. Pull with firm pressure while cranks are close together.

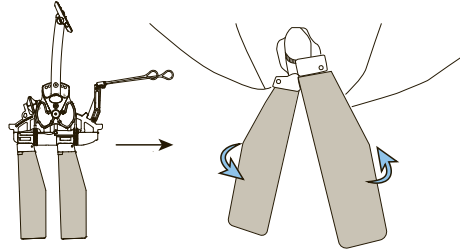
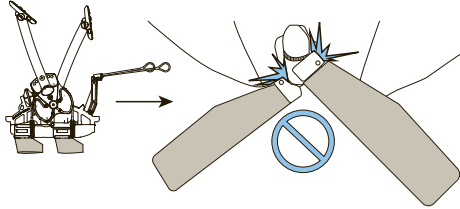

①

From the forward position, pull the right handle to shift the drive into reverse. (This is the longer handle of the two)

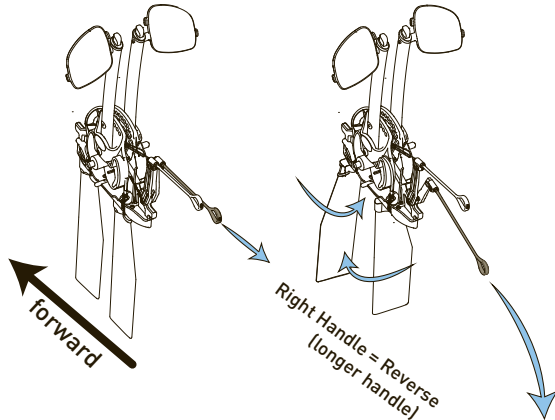

②

From the reverse position, pull the left handle to shift the drive into forward.

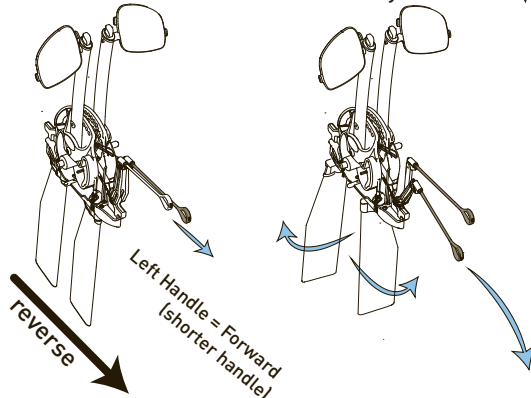

MirageDrive Operation

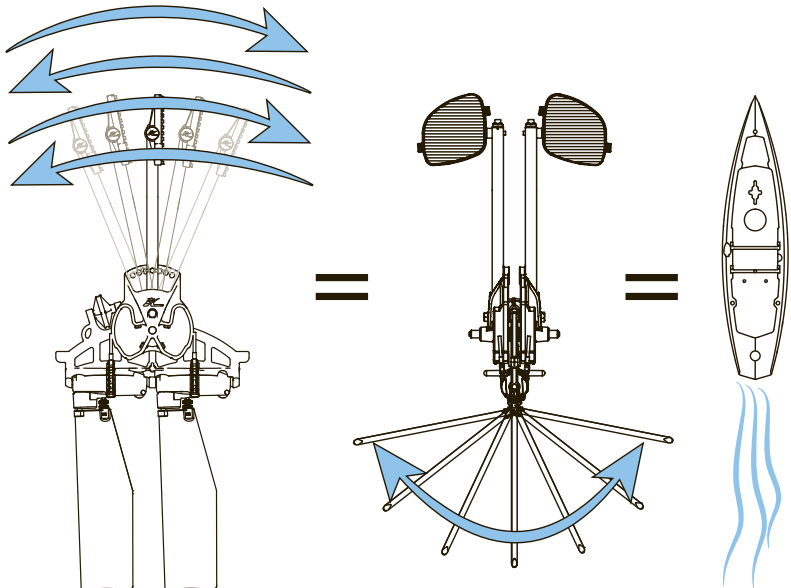

Shallow Water and Beaching

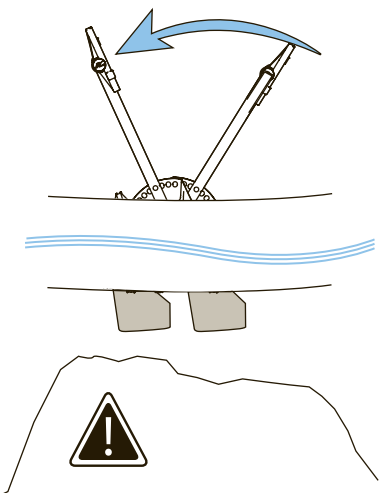

Press either pedal forward in shallow water to raise fins. Pressing one pedal fully forward will orient the fins with the kayak underside.

Kick Up Fins

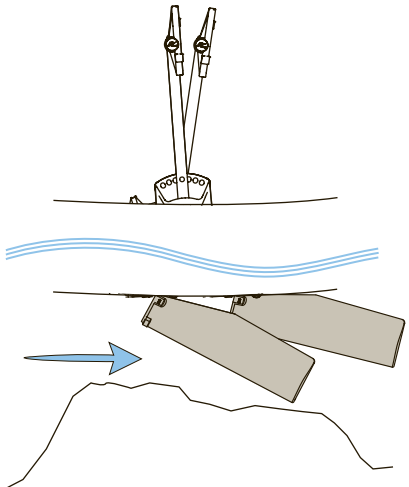

The kick up fins will automatically retract backwards when coming in contact with any object and resume their normal position when clear of obstruction and you pedal.

The 'Rudder' T-Handle is located on the right/ starboard side near the front of the kayak.

Rudder DOWN

Uncleat 'Rudder' T-Handle to deploy rudder.

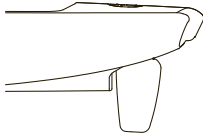
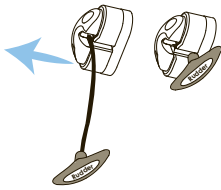

Rudder UP

Pull 'Rudder' T-Handle line through cleat to retract rudder.

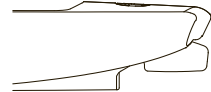
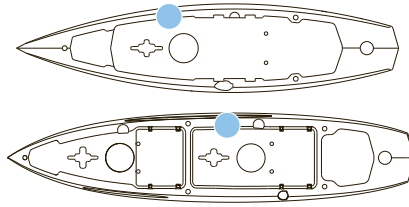

Steering

The steering handle is located in the middle on the left/port side of the kayak.

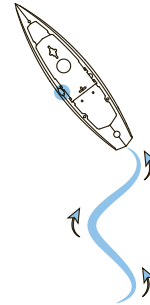
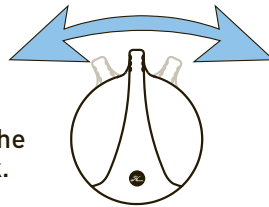

Paddle Storage

Rest paddle on the right side rail for storage.

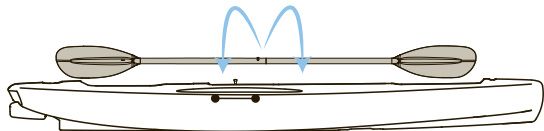

Secure by hooking the shock cord around eyelet post on the hull.

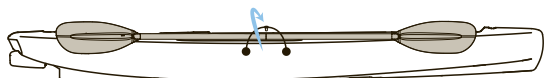

Transducer Install



The transducer is an optional accessory and is not included with boat.

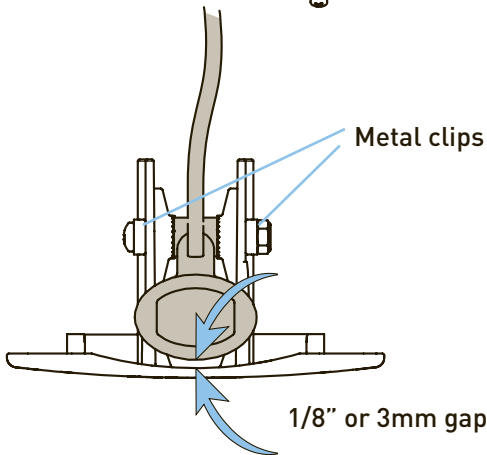
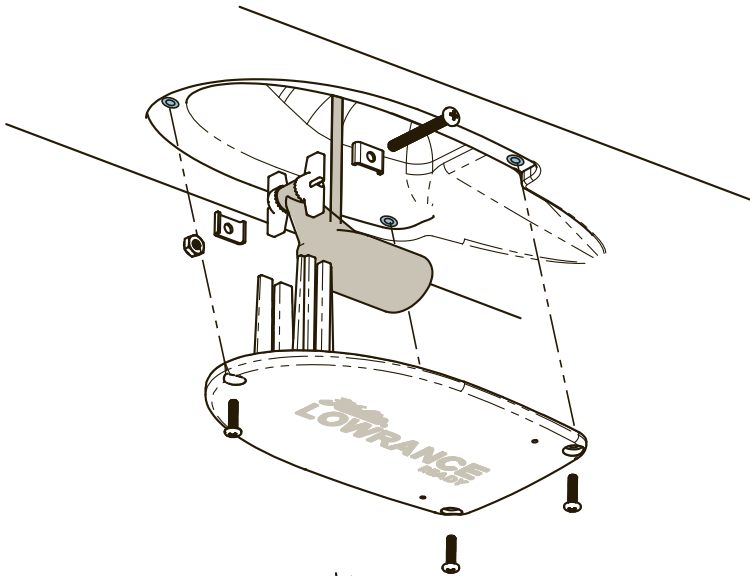
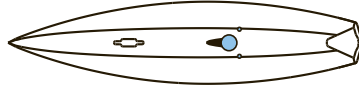

Thru-Hull Plugs Single and 3-way

①

Locate the thru-hull plug and unscrew the nut on the inside of the boat.

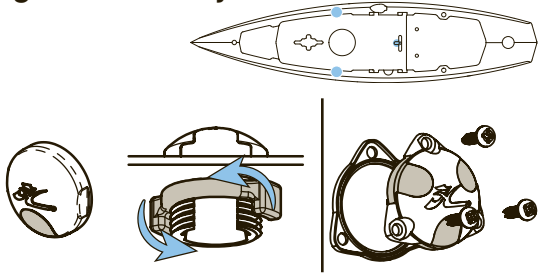

②

Remove the solid rubber plug.

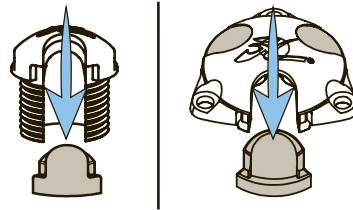

③

Choose the correct plug for your wire size and insert the wire by opening the plug along the slit.

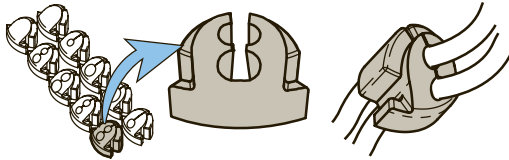

④

Press the new plug with the wire installed into the plastic plug making sure it fits tightly.

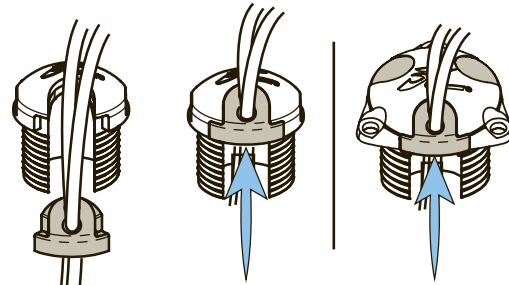

⑤

DO NOT USE A DRILL for the three way plug. Bolt or screw the thru-hull wire assembly to the hull using the nut or screws. Make sure you have the o-ring or gasket installed.

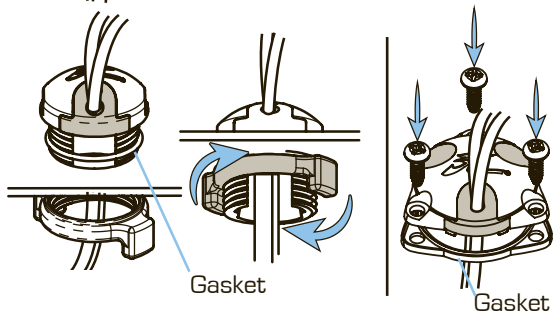

Wire Installation

①

Drill one 1" hole and one 1 3/8" hole using a hole saw in the areas indicated. The forward hole can be drilled on the left or right. The hole location for the Compass Duo is under the front seat.

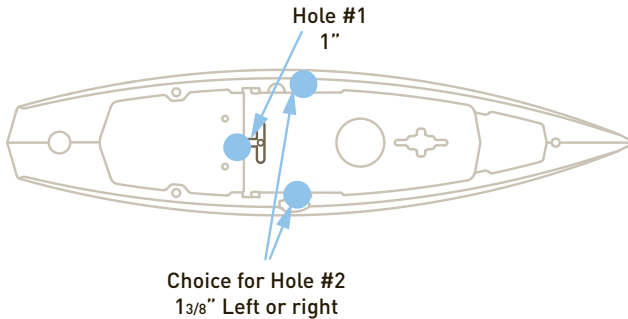

②

Run cable into the plug just in front of the transducer scupper.

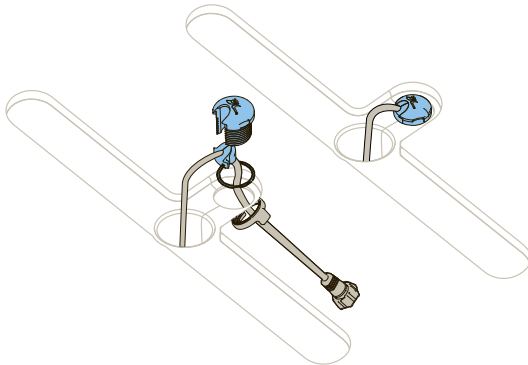

③

Lead the cable through the inside of the hull and exit the cable through the 3-way Thru-Hull Plug. Hand tighten screws to avoid stripping threads.

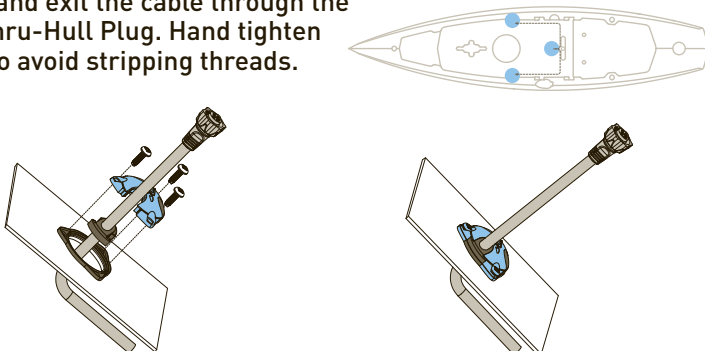

Storage Do's

Storing your boat upside down on crossbars or hanging from wide strapping are two ways to keep the boat stored.

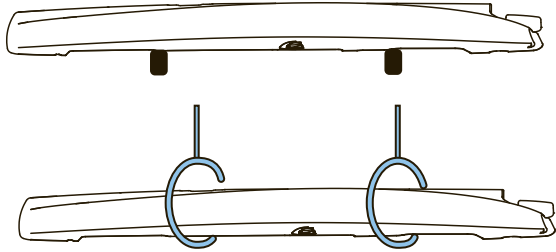

Storage Don'ts

Storing your boat cockpit side up on crossbars can dent the bottom.

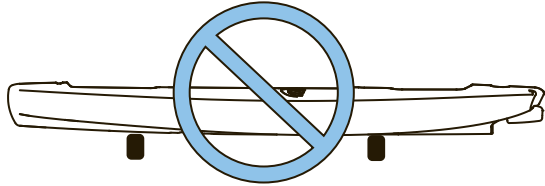

Storing your boat on its side over a long period of time can flatten/dent the sides.

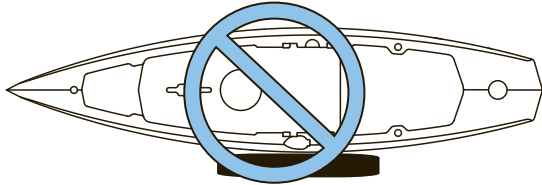

Hanging the boat by the scuppers can distort the scupper holes.

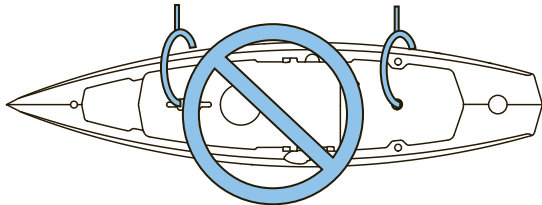

Never hang the boat by handles or pad eyes. They are not designed to handle long-term load and will fail.

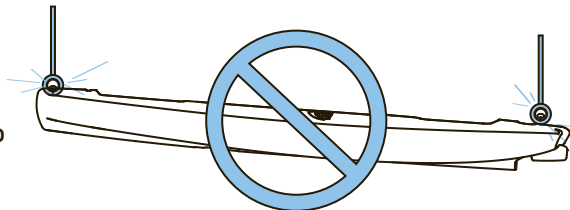

Never use PVC runners or tubes to store boat on.

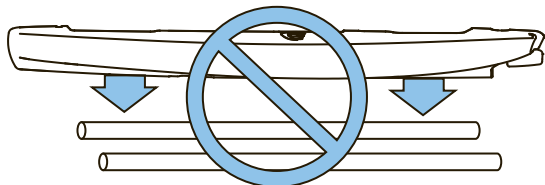

Additional Storage Key Points

- Always remove all water from boat.
- Don't leave tie-down straps tight over a long period of time.
- Storing in non-recommended configurations can result in hull damage and can void your warranty.

Cart

The cart should be used for transportation purposes only and not as a storage platform. Do not leave your boat on the cart for more than one hour (less time in warmer temperatures or direct sunlight).

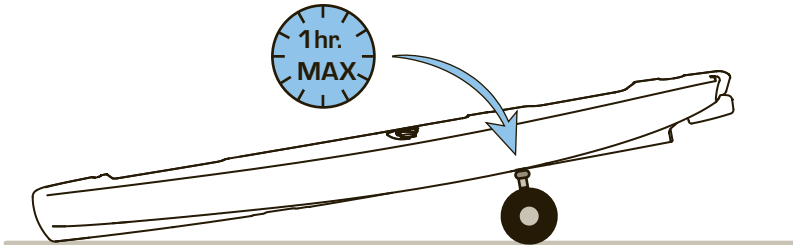

Store out of the Weather

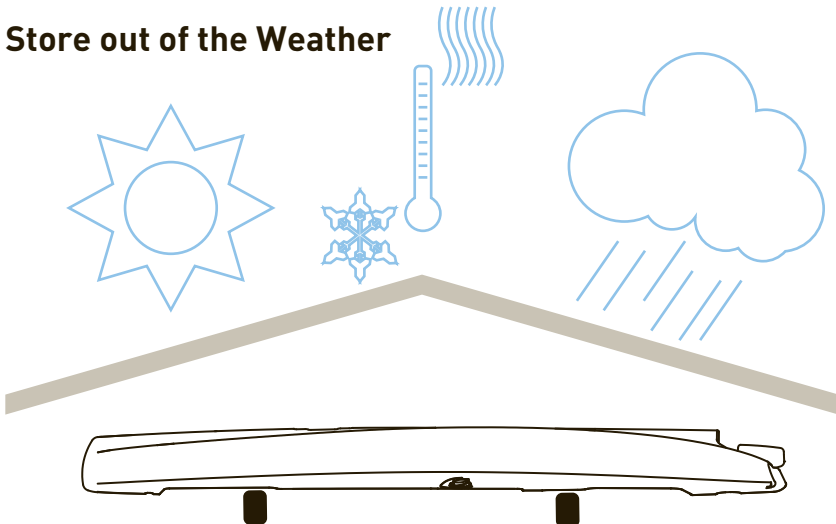

Roof Topping

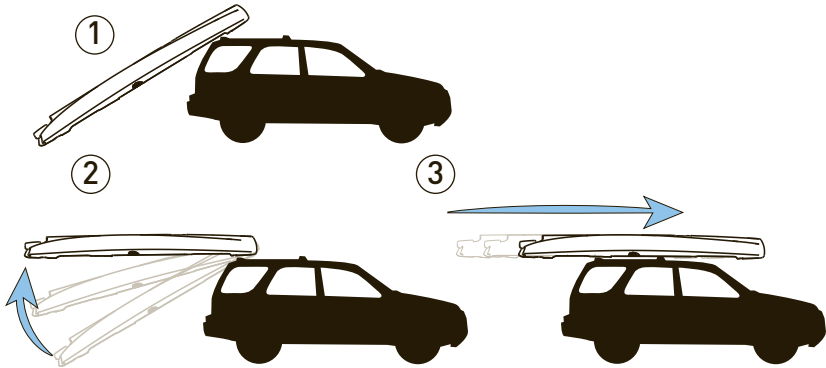

The best way to transport your boat is to purchase a trailer or roof rack from your dealer. Using proper cradles that support the hull, the boat can be transported right side up. Straps can then be laid across the boat and tied to the rack bars. Straps should be tight, but not so tight that they distort the shape of the boat. Avoid using ratchet straps to prevent overtightening.



Be sure to consult your car and roof rack owner's manual to ensure that you comply with all recommendations, precautions and specifications.

Running a line or strap from the bow and stern of the boat to each bumper is required. If your bumpers do not have a gap to pass a rope around, look underneath. There should be a loop of metal, which is used by car transports such as tow trucks.

Many people like to use the scupper holes to tie the boat to the car. This helps prevent the boat from sliding back and forth or the tie-down rope from slipping off the boat. (This is an acceptable method for tying the boat down for transport.)

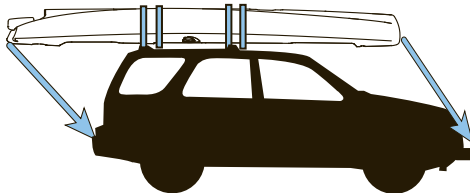

MirageDrive Regular Maintenance

Note: Excessive sediment on the drive can impair function, rinse thoroughly after every use to avoid this.

Use lubricant on the chain components frequently.

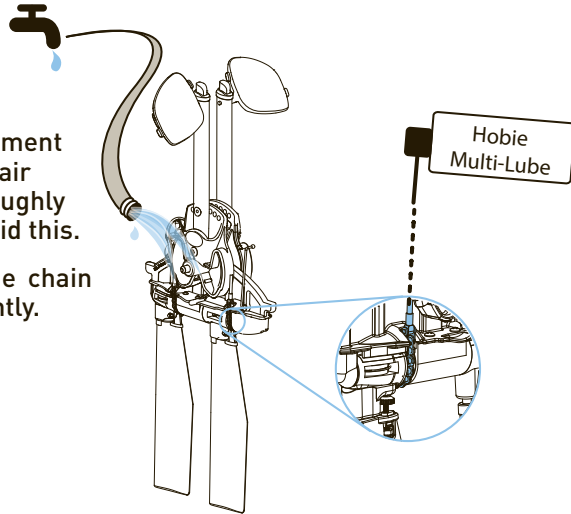

Checking Cable Tension

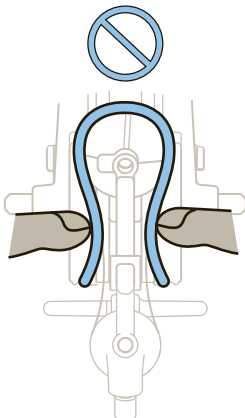
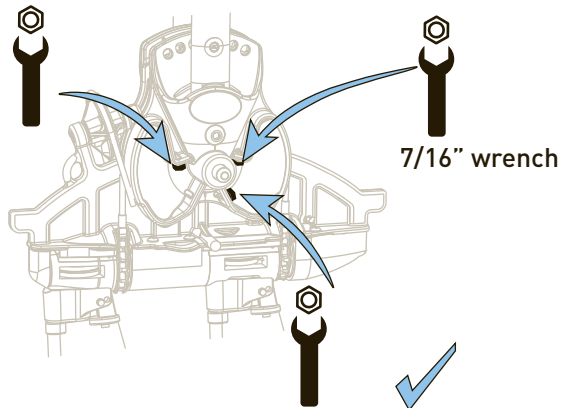

Cables should be tight enough so they can only be slightly squeezed in under firm finger pressure.

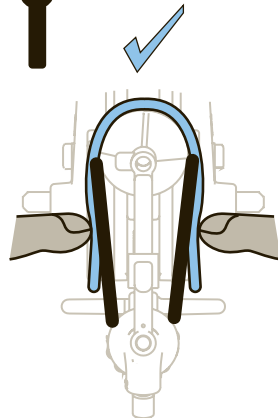

Visit hobie.com/support for information on the MirageDrive.

Rudder Tuning

If the steering feels loose:

①

Pull the rudder into the up position. This makes sure the rudder runs central.

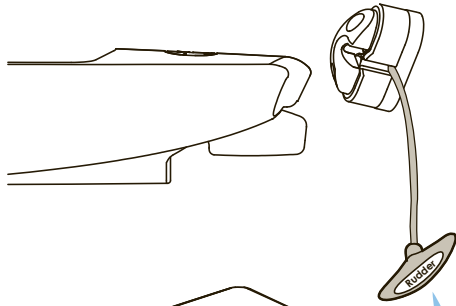

②

Loosen the screw clamping the rudder line.

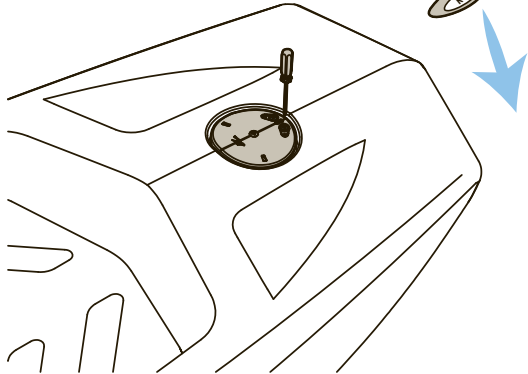

③

Pull the slack out of the rudder line making sure the steering handle is straight.

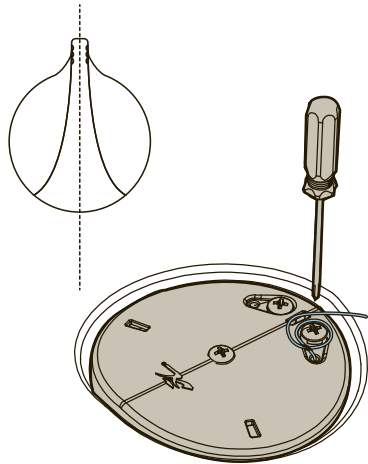

④

Wrap the line twice around the screw. Tighten the screw to clamp the line. Repeat for the other side.

If the fins do not stay locked into position and feel loose, you'll need to adjust the kick-up set screw.

①

The set screw is located in the housing at the base of the fin.

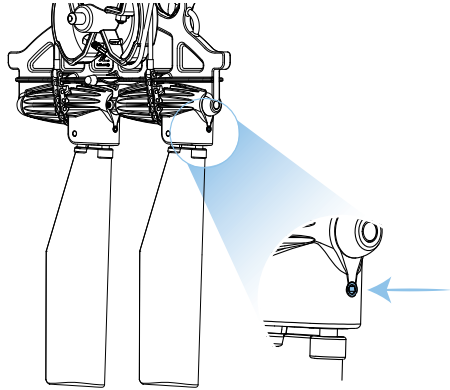

②

Make sure that the fin is completely engaged into the sprocket.

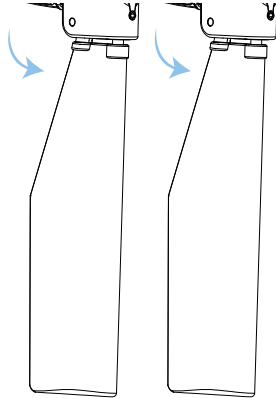

③

Tighten the screw 1/4 turn at a time until the set screw just touches the fin.

Test the fin by moving it in and out of the kick-up position to determine if it needs to be tightened or loosened.

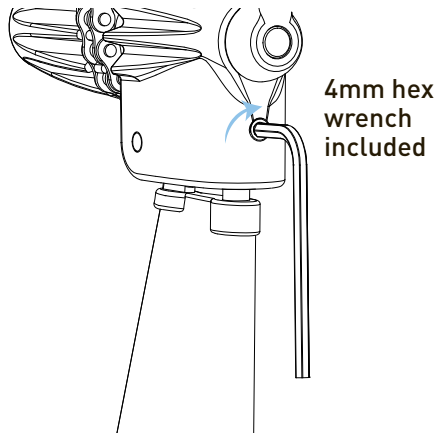

Checklist

Please read through the owner's information package prior to using this product.

The user of this product acknowledges both an understanding and assumption of risk involved in paddle/pedal sports. Consult your physician prior to beginning.

Always:

- Wear a Coast Guard approved personal flotation device (life jacket).
- Dress appropriately for weather conditions; cold water and/or weather can result in hypothermia; apply sunscreen and other sun protective clothing.
- Check your equipment prior to each use for signs of wear or failure.
- Tie a safety leash to your paddle and MirageDrive.
- Scout unfamiliar waters.
- Be aware of river water levels, tidal changes, wind conditions, obstacles in and above the water and weather changes.
- Always make sure that your hatches are secure and closed.
- Carry a pump and/or bailing device.
- Always carry the spare paddle provided with the boat.

Never:

- Never go alone and always file a float plan.
- Never go in flood and/or fast moving water conditions. Hobie kayaks are not designed for fast moving water.
- Never exceed your ability and be aware of your limitations.
- Never use alcohol or mind-altering drugs prior to or while using this product.
- Never open your hatches in unstable water conditions.
- Never remove the foam pieces inside the hull. They are installed for structure, additional flotation and safety.

For your safety, Hobie kayak hulls contain foam blocks for positive flotation. Please do not remove them.

Shakedown Cruise

As with any new product, it is important that you become familiar with the kayak and all its features. It is also important to determine that the kayak is sound before long trips. We recommend that you do what we call a “shakedown cruise” when the kayak is new, after shipping or transport, before long trips and after installing any thru-hull fittings. This test is typically done in shallow, calm conditions where you can familiarize yourself with or test the kayak before taking any long trips into open water. Things you should check or practice are:

- MirageDrive installation, adjustment and removal.
- Rudder operation.
- Closing hatches properly.
- Drain plug locations to make sure they are properly installed.
- Getting in and out of the boat from a capsized state.

Getting into your Kayak

If you fall out of your kayak, stay with the kayak. You should be properly wearing a life jacket/PFD which will keep you afloat. If the kayak is upside-down, it will need to be turned over. To do this, reach across the bottom of the kayak and grab the scupper hole or the Hobie MirageDrive and pull the boat upright. Position yourself so your head is near the cockpit area of the kayak and you are facing the kayak. You will want to be between the seat and the foot well areas of the kayak. Reach across the kayak to the far edge with one hand. Place the other hand on the near-side rail, then kick with your feet, pulling yourself up and onto the kayak. Roll over onto your backside toward the seat, which should place your backside in the seat. Sit up, swing your feet into the foot wells and you’re ready to go.

Mirage Kayak Cassette Plug

Your Hobie is shipped with a Mirage Cassette Plug. The plug is provided as standard equipment in the Mirage Kayak package. Insert the plug into the Mirage well when the MirageDrive is removed to provide added safety and to “fair” the bottom of the hull when paddling.

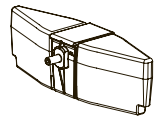

It is very important that you complete and send us your Warranty Registration Card as soon as possible.

This information enables Hobie Cat Company to contact you should there be important product information that needs to be shared with you in a timely manner. Please complete the Warranty Registration Card in your Owner's Packet, or take advantage of our online option at:

<http://www.hobie.com/product-registration>

or

Scan this QR code with your smart phone



If you have a question or issue with your Hobie product, please see your Authorized Hobie Kayak Dealer. They will assess the problem, assist with a repair and file a warranty claim with Hobie Cat Company if needed. All warranty claims must go through your Authorized Hobie Kayak Dealer. The Warranty Registration Card and Warranty Policies are included with each model in the Owner's Packet. Type in the address below to go to our dealer finder webpage.

All specs, colors, graphics and features are subject to change without notice. Please refer to the website for complete details.

<http://www.hobie.com/dealers>

Enjoy the Ride!

Heavy Duty Plug-In Cart



Kayak Cover



Inflatable PFD



H-Crate

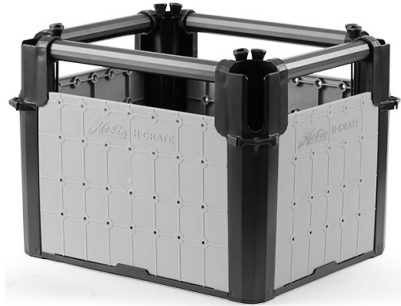

Hobie Vantage Seat bag



Hobie H-bar



Hobie Multi-Lube



Livewell



For more accessories see:
<http://www.hobie.com/catalogs-brochures/>



Hobie Cat Company

Holding Company

Oceanside, California, USA

1-800-HOBIE-49

Hobie Cat Australasia

Subsidiary

Huskisson, New South Wales, Australia

1-800-4-HOBIE

Hobie Cat Europe

Subsidiary

Toulon, France

+33 (0) 494 08 78 78

Hobie Kayak Europe

Independent Distributor

Stellendam, The Netherlands

+31 (0) 187 499 440

Hobie Cat Brasil

Independent Distributor

Porto Belo, Santa Catarina, Brazil

+55 (21) 3942 6815

Hobie.com

PN 81701017

REV 190606