

Hobie® Mirage® Kayaks

Owner's Manual



Welcome to the Hobie Way of Life



Thank you for choosing a Hobie Mirage Kayak. As a member of the Hobie way of life, you are now on the road to pure adventure in pedaling and paddling. This owner's manual is designed to help you get maximum enjoyment from your new Hobie kayak. But more important, it is designed to help you use it safely. The content of this manual covers all Mirage kayaks.

About the Design of your Kayak



Sit-on-top Cockpit

Hobie Mirage Kayaks are open-top cockpit designs. This allows the kayaker to enter and exit the kayak easily from the shore, dock or water. Scupper hole(s) make the kayak self-bailing. The design also eliminates the need to perform an “Eskimo roll” (advanced kayak technique). The contoured seat is fitted with an adjustable backrest for added comfort.

Hull Design

The long center “keel” area encourages the kayak to track straight when pedaling, paddling and coasting. Under moderate paddling conditions, the wider “shoulder” area of the hull rides high at the surface of the water without compromising speed. If the kayak is fully loaded with gear or is being paddled and braced in rough conditions, the “shoulder” areas provide secondary buoyancy and stability.

Maneuverability

Most new Mirage Kayaks come with the patented Twist- and-Stow rudder system. This system comes pre-installed by our factory. This new rudder is designed to flip out of the way during land transport and has an optional larger rudder blade for more turning authority.

Scupper Hole(s)

Drain holes (scuppers) in the cockpit or cargo well allow any water that enters the cockpit to immediately flow back out.

Graphics

Graphics are molded into the kayaks, so they will not peel or flake off for the life of the boat.

Hobie MirageDrive

Drive Installation

1. The Hobie MirageDrive® must be lowered into the opening of the hull near the footwells so it is facing forward and evenly front to back. The front of the MirageDrive can be determined by the location of the fin masts. Tipping the drive forward or aft when lowering can cause it to wedge into the well and possibly cause damage to the hull and/or fins. The MirageDrive alignment pin helps prevent this, so make sure that it properly seats in the groove.

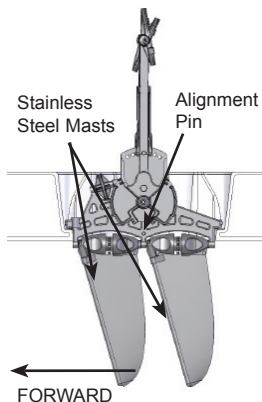

2. To lock the MirageDrive into the hull, lower it into the hull so that the drum shaft posts drop down into the Click and Go cams and lock into place.

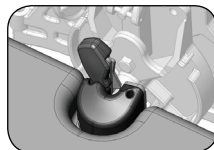
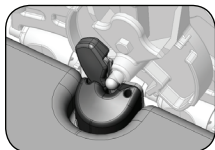

3. To remove the MirageDrive, flip the Click and Go cam back and pull the drive out. The cams should automatically reset themselves for installation, but if they do not, just flip the cam forward.

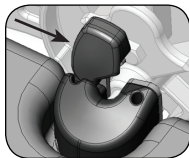

Pedal Adjustment

The pedals of the Hobie MirageDrive are adjustable to accommodate different leg lengths of kayakers. To adjust the pedals:

1. Squeeze the adjuster handles located on the pedal cranks.

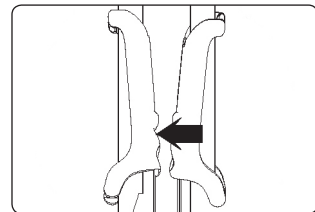

2. While squeezing the adjuster handle, move the pedal crank to the most comfortable position. Similar to a bicycle, it is best to adjust the pedals so your legs do not fully extend causing your knees to lock. Make sure that the metal pin on the crank fully engages the adjustment hole.

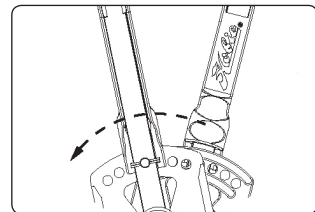

3. Hobie Cat® recommends new users have the pedal length adjustment set in the middle (number 4) to help while installing it into the hull correctly. Once installed you can select your preferred length setting.

Drum Casting

When turning the nut with a 7/16 inch open-end wrench, only giving it one half a turn at a time, then do the same to the remaining three nuts. Re-check the tension and adjust accordingly.

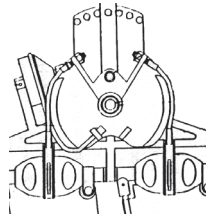

Note: Keep the pedal shafts and masts parallel. When the shafts are together, both masts must be straight down. The idler pulley cable (see item B in the illustration below) will be tightened automatically when the front chain assembly is tightened.

Cable Adjustments

Determining if adjustment is needed...

Occasionally the cables may need to be re-tightened. The cables should be kept taut; however, the front chain should be a little tighter than the rear chain. Push with your thumbs at the points marked (A) with moderate pressure (see the image to the right). The side of the chain should not go beyond the inside edge of the drum casting.

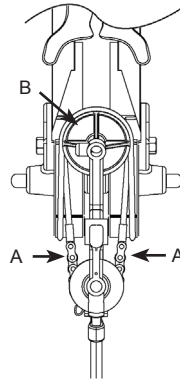

Washing

After using in salt water or dirty water, wash the Hobie MirageDrive with fresh water. Allow to dry, then spray metal parts with WD-40™ or equivalent. Special attention should be paid to threaded cable ends, lock nuts, chain, shafts, pedals, and adjustment pins.

Miscellaneous Maintenance

Periodically check for loose screws or frayed cables. If a cable has a broken strand, replace it with new cable.

CAUTION

Care should be taken to avoid striking objects with the Hobie MirageDrive. If you bend a mast, it usually can be straightened. To straighten, remove the MirageDrive from the boat and insert the Drive into something solid, such as a vise. Remove the fin, then carefully bend the mast until straight. To test for "true", roll the mast on a flat surface and straighten as needed until the masts roll evenly. If the mast cannot be straightened or becomes cracked or fatigued, replace the mast.

Twist and Stow Rudder System

Twist And Stow Rudder Features

The Hobie Twist and Stow rudder system is pre-installed and adjusted at the factory. With extensive use, the rudder system may need to be adjusted. The following information is intended to familiarize you with the rudder and how it works.

The left steering control line is tied off at the screw here.

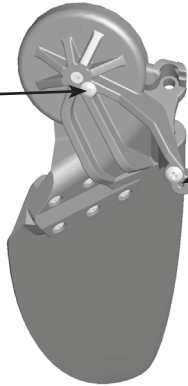

The right steering control line passes up through the hole here and is tightened down with the small screw alongside it.

The left steering control line passes up through the hole in the hex head bolt.

These bolts give you the ability to change between a larger or smaller rudder blade.

For improved performance with the kayak sailing option, an optional larger rudder blade is available.

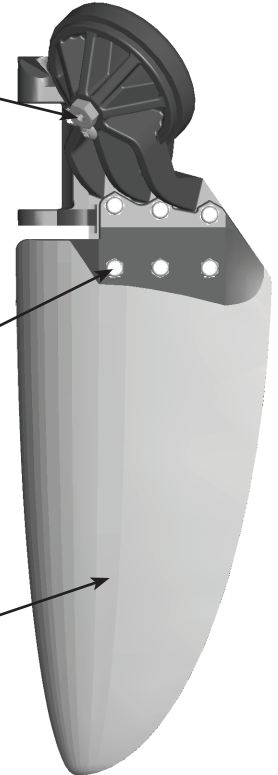

Up/Down Control Assembly/ Operation

The following detail explains how the up/down rudder control is set up inside the kayak.

T Handle: There are two T-handles on the kayak that operate the up/down control function of the rudder. Simply pull on the UP handle on the right to raise the rudder and the DOWN handle on the left to lower the rudder. When the rudder is down, pull the line tight and pull it into the cleat near where the T-handle exits the hull. This will make sure that it firmly stays down.

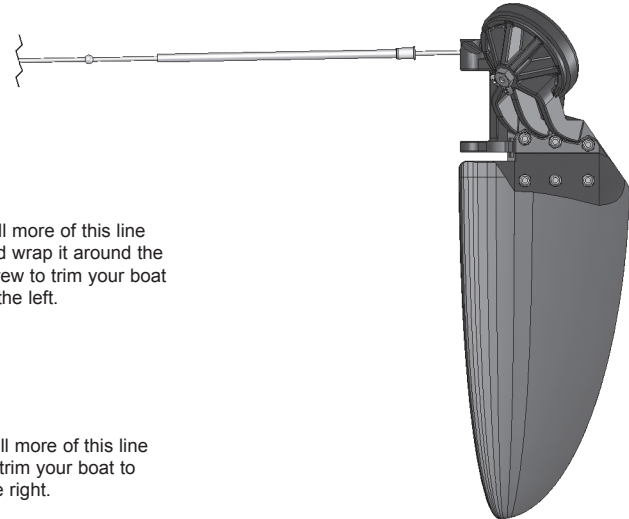
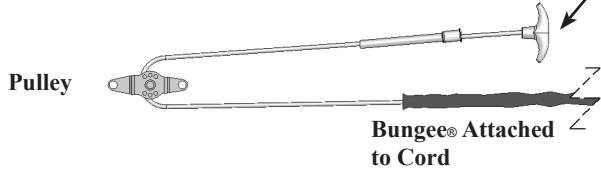

Steering Control Trim

To achieve a good, responsive feel with the steering system, you may occasionally need to adjust the tension of the steering lines (follow the diagram at right).

These two screws hold the end of the line in place. Turn back the screw a couple of times to release the end of the line and tighten the screws back down to hold the line.

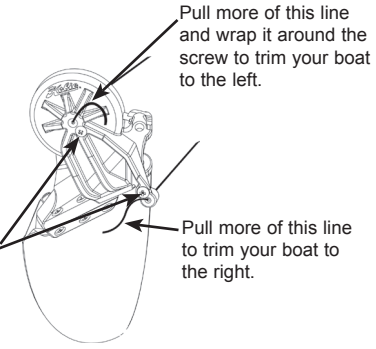

Basic Kayak Information



Basic Kayak Features

The front of the boat is the “bow” and the rear is the “stern”. When looking forward to the bow, the left side of the boat is “port” and the right side is “starboard”. The hull ID number can be found on the bottom of the boat, at the stern.

In the middle of the boat, there is a cockpit area, with the seat (toward the stern) and footwells (toward the bow). Inside the cockpit are scupper hole(s) that go all the way through the boat. These scuppers allow the boat to drain. All Hobie Mirage kayaks have hatches that allow access to the inside of the boat for gear storage.

Alongside the cockpit are a series of small “U” straps, called padeyes. These are used to attach accessories such as backrests.

All Hobie kayaks are made of linear polyethylene, making them repairable and recyclable.

Recommended Equipment for Specific Types of Pedaling and Paddling

Basic Boating: Life Jacket, Paddle, Paddle Leash, Backrest, Safety Whistle, Filled Water Bottle, Appropriate safety equipment depending on weather and location.

Longer Distance Touring: Dry Bags, Chart, Compass.

Additional Equipment for Diving: Dive Flag, Anchor.

Fishing: Rod Holders, Rod Leash, Rod Holder Extensions, Gear Bags, Livewell, Anchor or Stakeout Pole, Fish Grips, Visibility Flag.

Safety

Kayaking can be dangerous and physically demanding. The user of this product should understand that participating in kayaking may involve serious injury or death. Observe the following safety standards when using this product. These are basic safety rules that all boaters should follow. Always use common sense and follow all safety rules at all times.

Safety Checklist

- To avoid damage to the Hobie MirageDrive, push either pedal completely forward before beaching or in shallow water. Use small, partial pedal strokes with one pedal nearly all the way forward until there is adequate water depth for the MirageDrive to have complete clearance in the water.
- Consult your physician prior to beginning paddle/pedal sports.
- Always carry the spare paddle provided with the boat.
- Obtain paddle/pedal sports instructions from your dealer specific to this type of craft.
- Obtain certified first aid training and carry first aid and rescue/safety equipment.
- Always properly wear a Coast Guard approved personal flotation device.
- Wear a helmet where appropriate.
- Dress appropriately for weather conditions; cold water and/or weather can result in hypothermia.
- Check your equipment prior to each use for signs of wear or failure.
- Never pedal or paddle alone and file a float plan.
- Always tie a leash to your paddle.
- Do not pedal or paddle in flood conditions.
- Care must be made to ensure that the access hatches on your kayak remain closed while on the water. Water can enter a hatch that is left open and possibly flood the hull making the boat unstable or cause inadequate flotation for the passenger(s).
- Be aware of appropriate river water levels, tidal changes, dangerous currents, obstacles in and above the water and weather changes.
- Scout unfamiliar waters; portage where appropriate.
- Do not exceed your paddling/pedaling ability; be aware of your limitations.

- Hobie Kayaks were not designed for fast moving water.
- Follow the manufacturer's recommendations for use of this product.
- If additional outfitting is added to this craft, use manufacturer-approved materials only; do not impair entry or exit access.
- Read owner's information package prior to using this product.
- The user of this product acknowledges both an understanding and assumption of the risk involved in paddle/pedal sports.
- When paddling in a new area, check with the locals regarding currents, shoreline conditions and weather patterns. Plan an "escape route" -- an alternative place to get off the water should environmental conditions dictate. Beware of offshore winds that may make it difficult to return to shore.
- DO NOT use alcohol or mind-altering drugs prior to or while using this product.

The Shakedown Cruise

As with any new product, it is important that you become familiar with the craft and all its features. It is also important to determine if the kayak is sound before long trips. We recommend that you do what we call a "shakedown cruise" when the kayak is new, after shipping or transport, before long trips and after installing any through-hull fittings. This test is typically done in shallow, calm conditions where you can familiarize yourself with the boat or test the boat before taking any long trips into open water. Things that you should check or practice are:

- Rudder Operation
- MirageDrive Adjustment
- Getting in and out of the kayak from a capsized state
- Drain plug locations to make sure they are properly installed
- Closing the hatches properly
- Taking the kayak sail down on the water (if applicable)

How to Perform a Self Rescue

If you fall out of your boat, don't panic. Stay with the boat. You should be wearing a life jacket which will keep you afloat. There are many ways to get back up on the boat.

If the boat is upside-down, it will need to be turned over. To do this, reach across the bottom of the boat and grab the scupper hole or Hobie MirageDrive™ and pull the boat upright.

Position yourself so your head is near the cockpit area of the boat and you are facing the boat. You will want to be between the seat and the footwell areas of the boat.

Reach across the boat to the far edge with one hand. Place the other hand on the near-side rail, then kick with your feet, pulling yourself up and onto the boat, so your belly is across the center line of the boat. (Your belly should end up between the footwells and the seat.)

Next, roll over onto your backside toward the seat, which should place your backside in the seat. Sit up, swing your feet into the footwells and you're ready to go.

The key to this method is to keep your center of gravity low and near the centerline of the boat. Your body and head should stay close to the boat.

CAUTION: While righting the Hobie Mirage or climbing back aboard, stay clear of the pedals, pedal shafts, sails and adjustment straps. Avoid being hit by them or getting them hooked on your life jacket.

If your kayak turns over with the kayak sail up, it can be very difficult to turn the kayak over by rolling just the kayak. Make sure that the mainsheet is loose so that the sail is free to move around.

Pedaling

First, adjust the pedals to accommodate your size as shown earlier in these instructions. Adjustments can be made for a variety of leg lengths. Adjust the pedal positions equally. Sit with one pedal all the way forward so your knee stays slightly bent when your leg is fully extended. Then you simply pedal back and forth to propel the boat forward. For pedaling in shallow water, partial strokes with one pedal forward and one aft allow for retraction of the sails in shallow water. When there is adequate water for clearance of the fins, full strokes can be used. For additional speed you can paddle as well as pedal.

Before beaching or launching, push one pedal completely forward to retract the Hobie MirageDrive fins up against the hull and pull up the rudder. To take off from the beach, push out to deeper water or paddle out before putting the rudder down and pedaling the MirageDrive.

If launching from a rocky or wavy shore, paddle into deeper water before installing it to avoid damage to your MirageDrive. (Be sure to tether the MirageDrive to your kayak when it is not installed.) You may also prefer to remove the drive before beaching.

Paddling

You can choose to paddle, pedal or combine the two. These guidelines will help you to get started.

To start, sit in your kayak. Your backside should be all the way back in the seat and your knees comfortably bent. To find the proper footwell, straighten your legs all the way out and then bring them back one footwell. If your legs are too outstretched, you may experience strain on your lower back. If your knees are bent too much, you may end up knocking your kneecaps while paddling.

For proper hand placement on your paddle, start with your hands about a shoulder's width apart. If you place the center of the paddle on top of your head, your elbows should form slightly less than a 90 degree angle. There should be an equal amount of paddle shaft beyond each of your hands.

Some paddles may have the blades offset, or "feathered", at some degree from parallel. A feathered paddle presents less surface area for the wind to catch as that blade moves forward through the air. Some paddles have a flattened spot



along the paddle shaft that will help keep your "control" hand in a fixed position. However, a special technique must be used to get each blade in the water. If the paddle is right-hand controlled (when the right blade is held vertical, the left blade "scoop" is pointed mostly up), the right hand will stay tight and the left hand loose. To learn the process, hold the paddle tight in your right hand and loose in your left. Using the right hand, rotate the paddle blade back and forth; it should spin in your left hand. Now take a stroke on your right, then cock your right wrist back (left hand staying loose and somewhat open) and take a stroke on your left. If using a left-hand control paddle, reverse the process. The left hand stays tight and the right hand loose.

The basic paddle stroke will give you forward power. Place a paddle blade in the water near your toes. Pull the paddle blade back alongside the boat to approximately your hip area while your opposite hand and paddle blade move forward. Then lift the first paddle blade out of the water while lowering the second blade into the water and take a stroke with the other side.

If you pull the paddle out and away from the hull in an arc, it will force the bow of the boat to swing away from the paddle blade. This is called a "sweep stroke" and is used to turn the boat.

Mirage Cassette Plug

You Hobie Mirage kayak is shipped with a Mirage Cassette Plug. The plug is provided as standard equipment in the Mirage Kayak package and is used to fill the space where the Mirage fits into the hull. It is inserted when the MirageDrive is removed to provide added safety and to “fair” the bottom of the hull when paddling.

To install the cassette plug, simply place the plug in the hole for the MirageDrive mechanism and lock it down using the Click and Go cams.

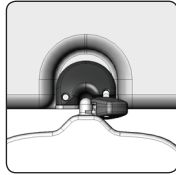
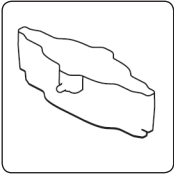

Storing Your Hobie Kayak

Hobie has chosen a blend of plastic that has an added measure of ultraviolet inhibitors to provide superior protection from ultraviolet light. However, to ensure extra years of use and bright colors, avoid storing the boat where it will be exposed to weather or in direct sunlight.

Kayaks should be stored upside down on the cockpit rails, or suspended in the air. When hanging your kayak, make sure that the ropes or straps support most of the weight on the cockpit rails or the side of the boat. A word of caution: hanging by the scupper hole(s) may cause distortion, and hanging from the handles may place undue strain on them. Storing the boat bottom-side down may also cause distortion. Kayak storage systems are available from your dealer. Padeyes are NOT intended for hanging or for use as tie-downs.

To help prevent theft of your kayak, simply run a cable through a scupper hole and lock it to something secure.

Plug-In Seatbacks

Hobie Mirage seatbacks use a locking plug-in method of attaching to the hull.

1. Line up the plugs underneath the venvcro flap on the seat so that they are in line as shown here. Press them into the plugs in the seat area.
2. Press in and turn the seat pegs 90 degrees clockwise to lock them in place.
3. Fold down the plug handles and lay the velcro flap over the plug.

We recommend that the seatbacks be removed while car-topping your kayak.

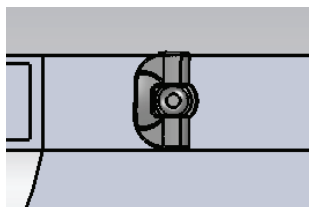
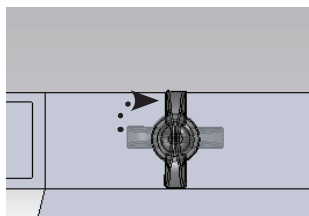
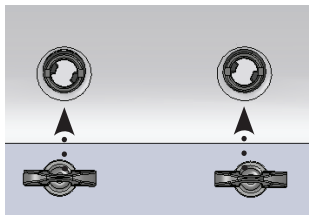

variety of attachments from kayak saddles to stackers. The racks can be used without the attachments but the racks should be padded. To help prevent distortion, place the kayak, cockpit side down, on top of the rack. Straps can then be laid across the boat and tied to the bars. Saddles cradle the boat and often come with their own straps.

An alternative to traditional rack systems are soft racks. They tend to be less expensive and will work with most cars. These are pads mounted on straps that sit between the kayak and the roof of your car. Some styles have a strap that wraps around the kayak and others strap the pad to the roof. To tie the boat to the car, straps are run through the car doors and the boat is tied to the roof as well as the bumpers, front and rear. Over-tightening the straps may cause dents in the roof of the car. Be sure to first consult your owner's manual for the car and roof rack system to ensure that you comply with all of their recommendations, precautions and specifications.

A line run from the bow and stern of the boat to each bumper is required. If your bumpers do not have a gap to pass a rope around, look underneath. There should be a loop of metal, which is used by car transports such as tow trucks.

Many people like to use the scupper holes to tie the boat to the car. This helps prevent the boat from sliding back and forth or the tie-down rope from slipping off the kayak. (This is a perfectly acceptable method for tying the boat down.

Transporting Your Hobie Kayak

The easiest way to transport your Hobie kayak is to purchase a roof rack from your dealer. They come with a wide

Frequently Asked Questions

How can I replace the screw-in fittings (if equipped)?

You may find it necessary to replace some of the padeyes or hooks if they are damaged. To replace them, follow the instructions below.

1. Drill two 3/16" holes opposite one another on the top surface of the screw-in fitting. Be careful not to go all the way through the part and into the kayak.

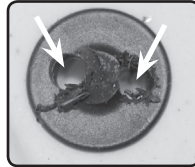

2. Insert the two prongs of a pair of needle nose pliers into the two holes and rotate the part counterclockwise.

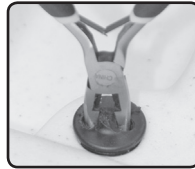

3. Grip the new part with your pliers and install it into the hole. Be sure to put a little pressure into the hole so that the threads on the new part install properly.

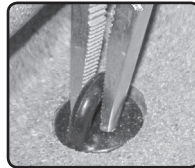

Is my boat repairable?

Hobie kayaks are very durable; however, on occasion they may need some minor repairs. Linear polyethylene is repairable. Check with your dealer concerning repairs for your kayak.

Is my boat recyclable?

Yes, Hobie will recycle your boat when you are done with it. To recycle a Hobie Kayak, it must be cut up so it fits in a box with the following dimensions (for UPS): may not exceed 130" length plus girth, and 108" in height. Ship the boat to:

Hobie Cat Company
4925 Oceanside Blvd.
Oceanside, CA 92056

It is our hope that no Hobie Kayak will ever end up in a landfill!

What is the best way to use the scupper plugs?

The scupper plugs are useful when you would like to keep the inside of your boat dry and is most helpful in calmer water conditions. Simply press the plug firmly into the scupper hole from the top side of the boat. To prevent loss of the plugs, lanyards are provided with the plugs so that you can attach them to the boat.

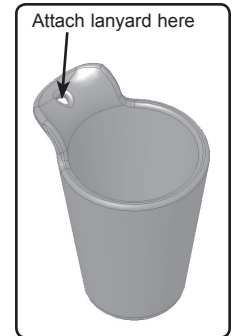

Warranty Information

It is very important that you fill out and send us your Warranty Registration Card as soon as possible. This information enables Hobie Cat Company to contact you should there be important product information that needs to be shared with you in a timely manner. Please complete the Warranty Registration Card in your Owner's Packet, or take advantage of our hassle-free online option at;

<http://www.hobiecat.com/support/warranty-registration/>

To file a warranty claim for a product defect, please see your Authorized Hobie Cat Dealer. They will be able to assess the problem, assist with a repair and file a warranty claim with Hobie Cat Company if needed. All warranty claims must go through your Authorized Hobie Cat Dealer. The Warranty Registration Card and Warranty Policies are included with each model in the Owner's Packet.

HOBIE CAT COMPANY

4925 Oceanside Blvd.

Oceanside, CA 92056

Phone (760) 758-9100

Fax (760) 758-1841

REV D 6/2011
PN 89500

 **H O B I E**

HOBIEKAYAKS.COM