

SWFcontract™

HORIZONTAL BLINDS

- Bali® Cordless 1" Mini
- Bali S3000 1" Mini
- Bali Classics 1" Mini
- Bali CustoMiser® 1" Mini
- Bali S4000 Micro
- Bali Standard Micro
- Bali 2" Heritage™
- Bali 2" School Blind
- Bali Dual Headrail
- Bali Incline Wire
- Bali Specialty Shapes
- Graber® 2" Designer Vinyl

UNITED STATES PRICE LIST
JULY 2015



Table of Contents

Options & Surcharges	3
Bali: Cordless 1" Mini Blinds Price Chart	4
Bali: S3000 & Classics 1" Mini Blinds Price Chart	5
Bali: CustoMiser® 1" Mini Blinds Price Chart	6
Bali: S4000 Micro & Standard ½" Micro Blinds Price Chart	7
Bali: Heritage™ 2" Aluminum Blinds Price Chart	8
Bali: 2" Aluminum School Blinds Price Chart	9
Bali: Dual Headrail Mini Blinds for Skylights and Incline Wire Mini Blinds	10-11
Color Coordination Charts for Incline Wire and Dual Headrail	12
Bali: Dual Headrail and Incline Wire Blind Price Charts	13
Bali: Incline Wire Specialty Shapes: Side Cuts, Inverted Triangles, Angle Top and Bottom Price Charts	14
Bali: Incline Wire Specialty Shapes: Octagons, Triangles Price Charts	15
Bali: Specialty Shapes: Arches Price Chart	16-17
Bali: Specialty Shapes: Circles Price Chart	18-19
Bali: Specialty Shapes: Side Cuts, Inverted Triangles, Angle Top and Bottom Price Chart	20-21
Bali: Specialty Shapes: Octagons and Triangles Price Chart	22-23
Bali: Specialty Shades: How to Make a Template and Template Service	24
Cut-Out Options	25
Color Availability and Coordination Charts for Mini and Micro Blinds	26-27
Graber®: 2" Designer Vinyl Blind	28-29
Graber: 2" Designer Vinyl Valance Options	30-31
Graber: 2" Designer Vinyl Color Coordination Chart	32



BLIND OPTION	CORDLESS	S3000 & CLASSICS MINI	CUSTOMISER®	S4000 & STANDARD MICRO	2" HERITAGE™ ALUMINUM	2" ALUMINUM SCHOOL BLIND	GRABER® 2" DESIGNER VINYL	CHARGES & DETAILS
2 or More Blinds On One Headrail	x	x	x	x	x	x	x	2 blinds – add \$47; 3 blinds – add \$65
Accent Channels	N/A	x	N/A	N/A	N/A	N/A	N/A	Side rails for improved privacy, available in all Classics colors (see page 26) add \$10/lineal foot; call Customer Service for details.
Brackets								
Hidden Brackets	STD	S3000 STD N/A	N/A	S4000 STD	N/A	N/A	N/A	No Charge
Box Brackets	STD	x	STD	x	STD	STD	STD	No Charge
Control Location:								
Tilt Left, Lift Cord Right	STD*	STD	STD	STD	STD	STD	STD	No Charge
Tilt Right, Lift Cord Left	x*	x	x	x	x	x	x	No Charge
All Controls Right	N/A	x	x	x	x	x	x	No Charge
All Controls Left	N/A	x	x	x	x	x	x	No Charge
Cord Tilter	N/A	Classics	N/A	N/A	STD	STD	STD	No Charge
Cut-Outs:								
Bottom Corner	N/A	x	N/A	x	x	x	x	See page 24, add \$67
Bottom Center	N/A	x	N/A	x	x	x	N/A	See page 24, add \$67
Top Corner	N/A	x	N/A	x	x	N/A	N/A	See page 24, add \$67
Direct Screw Mount	x	x	x	x	x	x		No Charge
Double-Slatted Blinds	N/A	x	N/A	N/A	N/A	N/A	N/A	Combinations other than standard colors add 100% to blind cost. Must specify all component colors required
Hold-Down Brackets	x	x	x	x	x	x	x	No charge
Inverted Slat	x	x	x		x	x		\$20
Ladder Tapes								
Cloth Ladder Tapes	N/A	N/A	N/A	N/A	x	N/A	x	See price charts.
Vinyl Ladder Tapes	N/A	N/A	N/A	N/A	N/A	x	N/A	
Multi-Colored Striped Blinds	x	x	N/A	x	x	N/A	N/A	\$25 over base price first extra color; for each additional blind of same width and color add \$10. Must specify all component colors required.
Narrow Width Blinds	N/A	See price charts						
Perforated Slats	N/A	x	x	N/A	N/A	N/A	N/A	See price charts.
Projection Brackets:								
1 ¾" Projection Bracket	N/A	x	x	x	N/A	N/A	N/A	
2 ¾" Projection Bracket	N/A	x	x	x	x	x	x	
4 ¾" Projection Bracket	N/A	x	x	x	x	x	x	
2" Projection Bracket	x	N/A	N/A	N/A	N/A	N/A	N/A	
3 ½" Projection Bracket	x	N/A	N/A	N/A	N/A	N/A	N/A	
Ring Pull	N/A	x	x	x	x	x	x	No Charge
Ring Tilter	N/A	x	x	x	x	x	x	No Charge
Screw Options								
#8 x 5/8" Tek, combo indented hex, 4 per bag - 1 per blind	x	x	x	x	x	x	x	No Charge
#8 x 1 ¼" combo hex, 2 per bag - 2 per blind.	x	x	x	x	x	x	x	No Charge
Telescoping Skylight Pole								
5-10 ft. pole	N/A	x	x	x	x	x	x	Add \$46
3-6 ft. pole	N/A	x	x	x	x	x	x	Add \$70
Template Service	N/A	x	N/A	N/A	N/A	N/A	N/A	\$25 (net price) See page 24 for details.
Tilt Limiter	N/A	x	x	x	N/A	N/A	N/A	No Charge
Top Lock Cord Lock	N/A	x	x	x	N/A	N/A	N/A	No Charge
Turn Clips	N/A	Classics	x	STD Micro	N/A	N/A	N/A	No Charge
Wand Tilt	STD	STD	STD	STD	x	x	x	No Charge

*Tilter only, no cord controls available NOTE: x = Available Option



Horizontal Blinds

Cordless 1" Mini Blinds

All Available Colors – with .006 Inch Thick Slats

HEIGHT UP TO ↓	WIDTH UP TO →																			
	23"	26"	29"	32"	36"	40"	44"	48"	52"	57"	62"	67"	72"	82"	92"	102"	112"	122"	132"	144"
42"	\$155	160	165	179	186	199	213	223	234	251	260	276	290	344	370	406	430	459	518	541
48"	158	164	177	186	198	208	222	235	247	266	278	294	307	363	396	428	454	488	547	576
54"	162	176	183	190	205	219	231	245	255	281	296	308	327	383	417	451	483	515	576	609
60"	173	182	187	204	216	226	242	255	269	295	308	327	340	401	434	478	510	543	606	639
66"	177	186	201	213	222	238	251	267	286	306	323	337	360	420	453	502	533	572	639	675
72"	182	194	206	217	234	247	263	284	296	321	337	356	380	439	480	524	562	604	668	706
78"	190	201	213	222	241	256	275	295	307	333	353	376	394	464						
84"	199	208	219	234	252	267	288	302	321	352	371	390	409							
SURCHARGE: HIDDEN HOLES																				
Hidden Holes Surcharge	\$8	8	8	9	11	12	12	13	13	16	16	17	19	23	24	29	30	33	36	37

NOTE: Smallest width available 18" exact. See color chart on page 26 for color availability. Not available with perforated slats. Cannot exceed 6400 sq. inches as a single blind. Due to weight limitations, blinds that fall to the right of the heavy lines must be manufactured as multiple blinds on one headrail. See guidelines below.

All Available Colors – with .008 Inch Thick Slats

HEIGHT UP TO ↓	WIDTH UP TO →																			
	23"	26"	29"	32"	36"	40"	44"	48"	52"	57"	62"	67"	72"	82"	92"	102"	112"	122"	132"	144"
42"	\$162	165	173	189	196	208	226	237	247	264	276	294	307	363	393	430	458	488	550	572
48"	163	172	187	196	208	221	236	248	261	284	296	312	327	387	420	455	483	519	581	612
54"	170	186	193	200	219	232	243	259	269	298	315	329	349	405	445	482	514	549	613	649
60"	184	192	197	216	228	239	257	269	287	314	329	349	363	427	463	509	544	580	647	680
66"	187	196	213	225	237	253	265	285	302	327	346	360	386	447	485	537	569	614	682	721
72"	191	204	219	230	249	261	281	300	315	344	360	381	406	468	512	561	602	648	715	754
78"	200	215	225	237	257	271	293	314	328	355	378	402	420	496						
84"	209	220	234	249	267	287	306	322	345	376	397	416	439							
SURCHARGE: HIDDEN HOLES																				
Hidden Holes Surcharge	\$8	8	8	9	11	12	12	13	13	16	16	17	19	23	24	29	30	33	36	37

NOTE: Smallest width available 18" exact. See color chart on page 26 for color availability. Not available with perforated slats. Cannot exceed 6400 sq. inches as a single blind. Due to weight limitations, blinds that fall to the right of the heavy lines must be manufactured as multiple blinds on one headrail. See guidelines below.

Cordless Two or More Blinds on One Headrail (.006 and .008)

- Minimum blind width of individual blind – 18"
- Maximum finished blind width of individual blind – 60"
- Maximum finished blind width:
 - Two on one headrail – 120"
 - Three on one headrail – 144"
- Minimum finished blind height – 12"
- Maximum finished blind height – 72"
- Gap between blinds – 3/8"

Clearance for Cordless – 1"

Clearance is the distance from backside of slat stack to back of bracket. This allows the blind to be mounted above window frame for outside mount without projection brackets.



Used on all standard colors.

S3000 1" Mini & Classics 1" Mini Blinds

All Available Colors – with .006 Inch Thick Slats

HEIGHT UP TO ↓	WIDTH UP TO →																										
	12"	23"	26"	29"	32"	36"	40"	44"	48"	52"	57"	62"	67"	72"	82"	92"	102"	112"	122"	132"	142"	152"	162"	172"	182"	192"	
42"	\$94	76	79	87	97	104	114	126	133	142	158	167	180	190	215	237	271	290	317	343	361	386	412	437	462	488	
48"	97	79	87	99	104	116	126	137	145	156	175	184	200	210	237	266	293	317	347	375	398	428	459	490	521	552	
54"	103	87	99	104	108	126	137	145	156	165	190	206	215	231	258	287	319	347	378	404	435	467	499	530	562	562	
60"	114	99	104	108	125	137	145	158	167	180	206	218	235	245	278	307	347	378	408	438	467	502	537	572	607	642	
66"	117	102	108	125	133	145	158	167	180	199	218	235	246	268	299	327	375	402	439	474	506	542	578	614	650	686	
72"	122	106	116	130	139	156	167	180	199	210	235	250	268	287	319	355	398	435	474	506	540	579	618	658	697	736	
78"	131	114	126	137	145	165	176	194	210	221	246	268	287	305	346	378	426	460	503	540	575	615	656	696	736	777	
84"	141	125	133	145	156	175	190	207	218	237	268	286	305	319	366	399	451	493	537	572	609	652	696	740	783	826	
90"	146	130	142	153	165	184	206	215	235	246	278	299	317	343	383	426	474	519	563	607	649	696	743	789	836	883	
96"	152	137	145	158	169	199	212	231	245	266	293	314	340	357	402	448	503	544	597	641	680	728	776	823	871	919	
102"	158	142	156	167	180	206	221	239	258	276	311	330	355	378	426	472	529	575	626	673	721	773	823	874	925	976	
108"	166	149	163	175	190	212	235	250	271	290	322	347	375	394	448	496	557	602	657	706	757	810	861	914	965	1018	
114"	172	156	167	184	200	221	241	266	286	305	343	366	391	415	467	519	580	628	692	753	817	874	931	989	1046	1103	
120"	174	158	175	194	210	235	250	276	296	317	355	378	404	435	493	541	607	662	716	769	823	881	938	995	1053	1109	
126"	180	165	184	206	215	241	268	287	307	327	370	398	426	451	510	563	632	688	743	798	850	909	968	1028	1088	1146	
SURCHARGE: HIDDEN HOLES																											
Hidden Holes Surcharge	\$8	8	8	8	9	11	12	12	13	13	16	16	17	19	23	24	29	30	33	36	37	40	43	46	49	52	

NOTE: Smallest width available 5½". Widths from 5½" to 8⅝" are tilt only.
See color chart on page 26 for color availability.

All Available Colors – with .008 Inch Thick Slats

HEIGHT UP TO ↓	WIDTH UP TO →																										
	12"	23"	26"	29"	32"	36"	40"	44"	48"	52"	57"	62"	67"	72"	82"	92"	102"	112"	122"	132"	142"	152"	162"	172"	182"	192"	
42"	\$102	85	88	96	107	114	126	141	147	156	173	182	200	210	237	262	296	321	347	378	394	425	456	487	518	549	
48"	104	88	96	108	114	129	141	150	160	172	194	206	218	231	262	290	323	347	382	412	438	472	506	540	574	608	
54"	111	96	108	114	118	141	150	160	172	180	210	226	237	254	282	317	352	382	415	446	479	514	549	584	618	653	
60"	125	108	114	118	137	150	160	173	182	200	226	240	259	271	307	338	382	415	447	483	511	550	588	626	664	702	
66"	128	111	118	137	147	160	173	182	200	216	240	259	272	293	328	361	412	443	485	521	557	596	636	675	714	753	
72"	132	115	129	145	151	172	182	200	216	231	259	275	293	317	352	390	438	479	521	557	593	637	680	723	767	811	
78"	142	126	141	150	160	180	196	212	231	244	272	293	317	332	381	415	470	506	554	593	632	677	721	766	811	855	
84"	152	137	147	160	172	194	210	227	240	262	293	315	332	352	402	439	496	542	590	630	670	717	765	813	860	908	
90"	162	145	156	168	180	206	226	237	259	272	307	328	347	378	422	470	521	571	621	668	714	765	816	867	918	968	
96"	167	150	160	173	184	216	233	254	271	290	323	344	375	393	443	493	554	598	657	705	749	801	853	905	957	1009	
102"	172	156	172	182	200	226	244	263	282	306	342	363	390	415	470	519	584	632	687	740	794	850	905	960	1016	1070	
108"	179	164	178	194	210	233	259	275	296	321	355	382	412	435	493	545	613	662	721	777	833	890	948	1004	1062	1120	
114"	187	172	182	206	218	244	267	290	315	332	378	402	431	455	511	571	638	692	761	828	898	962	1026	1090	1154	1216	
120"	190	173	194	212	231	259	275	306	327	347	390	415	446	479	542	594	668	729	787	847	905	968	1032	1096	1160	1224	
126"	198	180	206	226	237	267	293	317	338	361	408	438	470	496	561	621	697	757	817	878	934	999	1064	1129	1194	1259	
SURCHARGE: HIDDEN HOLES																											
Hidden Holes Surcharge	\$8	8	8	8	9	11	12	12	13	13	16	16	17	19	23	24	29	30	33	36	37	40	43	46	49	52	

NOTE: Smallest width available 5½". Widths from 5½" to 8⅝" are tilt only.
See color chart on page 26 for color availability.

Perforated slat option available at 25% surcharge – .008 gauge only.

Perforated colors available: 062P Char Brown, 112P Alabaster, 121P Brushed Aluminum, 205P White Satin, 233P Black Satin

Hidden Holes available on S3000 only.



Used on all standard colors.
Not available on perforated slats.



Horizontal Blinds

CustoMiser® 1" Mini Blinds

All Available Colors – with .006 Inch Thick Slats

HEIGHT UP TO ↓	WIDTH UP TO →																									
	12"	23"	26"	29"	32"	36"	40"	44"	48"	52"	57"	62"	67"	72"	82"	92"	102"	112"	122"	132"	142"	152"	162"	172"	182"	192"
42"	\$82	66	70	77	83	93	99	104	109	121	137	143	156	162	182	202	229	248	270	293	315	338	361	383	406	428
48"	87	70	77	84	92	100	107	115	122	130	149	159	167	179	202	224	251	271	300	324	349	374	399	423	448	473
54"	94	77	84	92	96	107	115	125	135	142	160	171	182	197	219	243	274	298	322	351	380	409	438	467	495	524
60"	100	84	92	96	103	115	125	137	143	156	174	184	200	209	238	262	298	320	352	383	414	445	476	507	538	569
66"	104	89	96	103	109	125	137	143	158	166	186	201	213	228	255	282	317	345	376	409	442	475	508	541	574	607
72"	108	93	101	108	116	133	143	156	166	175	201	215	228	243	274	302	340	370	405	440	475	510	545	580	615	650
78"	114	99	107	115	125	142	153	164	175	190	213	228	243	258	291	322	361	391	428	466	503	540	577	614	651	688
84"	119	104	111	122	135	149	160	175	186	201	228	242	258	274	310	340	383	418	456	495	535	574	613	652	691	730
90"	124	108	121	130	141	158	171	184	200	212	238	255	271	291	328	359	406	442	482	523	564	606	647	688	729	770
96"	132	115	125	138	149	166	179	197	208	226	251	268	286	305	345	382	428	467	508	550	592	634	677	719	761	803
102"	137	121	133	143	156	174	190	204	219	234	266	282	302	320	361	405	450	491	537	582	627	673	718	763	809	854
108"	142	126	138	150	162	181	200	215	232	248	275	298	317	336	382	424	476	515	559	606	652	698	745	791	837	884
114"	146	130	145	159	170	193	208	228	243	262	286	310	333	350	398	441	492	539	585	632	680	727	775	822	869	917
120"	152	137	151	166	179	201	216	238	253	274	301	324	346	364	413	458	513	561	610	660	711	761	812	862	913	963
126"	157	141	160	174	190	209	228	248	264	284	312	338	359	378	428	476	530	585	634	688	742	795	849	902	956	1009

NOTE: Smallest width available 5½". Widths from 5½" to 8¹⁵/₁₆" are tilt only.
See color chart on page 26 for color availability.

All Available Colors – with .008 Inch Thick Slats

HEIGHT UP TO ↓	WIDTH UP TO →																									
	12"	23"	26"	29"	32"	36"	40"	44"	48"	52"	57"	62"	67"	72"	82"	92"	102"	112"	122"	132"	142"	152"	162"	172"	182"	192"
42"	\$90	73	77	85	91	102	109	114	120	133	151	157	172	178	200	222	252	273	297	322	347	372	397	421	447	471
48"	96	77	85	92	101	110	118	127	134	143	164	175	184	197	222	246	276	298	330	356	384	411	439	465	493	520
54"	103	85	92	101	106	118	127	138	149	156	176	188	200	217	241	267	301	328	354	386	418	450	482	514	545	576
60"	110	92	101	106	113	127	138	151	157	172	191	202	220	230	262	288	328	352	387	421	455	490	524	558	592	626
66"	114	98	106	113	120	138	151	157	174	183	205	221	234	251	281	310	349	380	414	450	486	523	559	595	631	668
72"	119	102	111	119	128	146	157	172	183	193	221	237	251	267	301	332	374	407	446	484	523	561	600	638	677	715
78"	125	109	118	127	138	156	168	180	193	209	234	251	267	284	320	354	397	430	471	513	553	594	635	675	716	757
84"	131	114	122	134	149	164	176	193	205	221	251	266	284	301	341	374	421	460	502	545	589	631	674	717	760	803
90"	136	119	133	143	155	174	188	202	220	233	262	281	298	320	361	395	447	486	530	575	620	667	712	757	802	847
96"	145	127	138	152	164	183	197	217	229	249	276	295	315	336	380	420	471	514	559	605	651	697	745	791	837	883
102"	151	133	146	157	172	191	209	224	241	257	293	310	332	352	397	446	495	540	591	640	690	740	790	839	890	939
108"	156	139	152	165	178	199	220	237	255	273	303	328	349	370	420	466	524	567	615	667	717	768	820	870	921	972
114"	161	143	160	175	187	212	229	251	267	288	315	341	366	385	438	485	541	593	644	695	748	800	853	904	956	1009
120"	167	151	166	183	197	221	238	262	278	301	331	356	381	400	454	504	564	617	671	726	782	837	893	948	1004	1059
126"	173	155	176	191	209	230	251	273	290	312	343	372	395	416	471	524	583	644	697	757	816	875	934	992	1052	1110

NOTE: Smallest width available 5½". Widths from 5½" to 8¹⁵/₁₆" are tilt only.
See color chart on page 26 for color availability.

Perforated slat option available at 25% surcharge – .008 gauge only.

Perforated colors available: 062P Char Brown, 112P Alabaster, 121P Brushed Aluminum, 205P White Satin, 233P Black Satin



Used on all standard colors.
Not available on perforated slats.

Horizontal Blinds



S4000 1/2" Micro & Standard 1/2" Micro Blinds

All Available Colors

HEIGHT UP TO ↓	WIDTH UP TO →																									
	12"	23"	26"	29"	32"	36"	40"	44"	48"	52"	57"	62"	67"	72"	82"	92"	102"	112"	122"	132"	142"	152"	162"	172"	182"	192"
42"	\$110	95	100	106	114	132	141	151	161	172	196	206	222	236	266	293	330	361	391	425	459	493	527	561	595	629
48"	115	100	106	118	126	143	153	165	175	187	211	226	245	259	293	323	365	393	431	469	507	545	584	622	660	698
54"	122	106	118	129	134	153	167	176	192	206	227	249	266	283	317	355	394	430	468	507	546	586	625	664	703	743
60"	133	116	126	134	147	165	176	194	206	222	250	266	287	306	346	378	430	465	507	551	594	638	681	724	768	812
66"	141	125	134	147	158	176	194	206	222	237	268	286	310	328	370	410	462	499	544	589	633	678	722	767	812	856
72"	148	132	145	158	168	190	206	222	237	254	286	310	328	355	394	437	493	537	585	633	682	731	780	828	878	926
78"	157	141	153	167	176	204	219	237	254	272	307	325	355	372	422	467	525	569	623	674	724	776	826	878	928	980
84"	166	149	163	175	192	211	227	253	268	287	323	347	372	394	448	494	557	607	662	718	775	830	887	943	999	1056
90"	174	158	172	186	203	222	249	263	286	305	342	367	393	421	474	523	592	642	699	756	814	871	928	986	1042	1100
96"	180	165	176	199	211	237	259	279	299	321	361	387	417	443	501	553	623	674	735	796	856	917	977	1037	1098	1159
102"	190	173	190	206	222	250	272	291	315	335	381	404	437	465	525	581	652	712	776	839	903	966	1030	1094	1158	1222
108"	197	179	199	214	233	262	286	310	332	355	394	426	460	489	553	611	684	747	812	879	946	1012	1079	1145	1212	1279

NOTE: Smallest width available 5 1/2". Widths from 5 1/2" to 8 15/16" are tilt only.
See color chart on page 26 for color availability.



Used on all standard colors.



Horizontal Blinds

2" Heritage™ Aluminum Blinds

HEIGHT UP TO ↓	WIDTH UP TO →																				
	12"	23"	26"	29"	32"	36"	40"	44"	48"	52"	57"	62"	67"	72"	82"	92"	102"	112"	122"	132"	142"
42"	\$113	98	103	110	119	136	145	156	165	179	202	213	231	242	271	303	340	368	400	432	459
48"	118	103	110	124	133	148	161	170	183	197	219	235	252	267	303	330	372	404	443	473	502
54"	126	110	124	133	142	161	170	185	200	210	238	258	271	289	326	362	406	443	481	516	552
60"	140	123	133	142	153	170	185	202	213	233	259	273	296	312	354	388	443	478	523	557	596
66"	145	129	141	153	165	185	202	213	234	247	276	297	316	339	381	421	473	512	558	600	640
72"	153	138	150	163	173	198	212	233	247	263	297	320	339	362	406	450	504	552	600	642	686
78"	161	145	161	170	185	210	228	244	263	281	316	339	362	384	434	478	537	587	639	686	731
84"	170	154	166	183	200	219	238	260	276	297	337	361	384	406	462	505	569	622	676	727	773
90"	179	163	179	194	208	234	258	272	296	314	354	381	404	430	489	537	604	659	714	769	821
96"	186	170	185	204	219	247	267	289	310	335	372	399	426	454	514	566	639	695	755	808	868
102"	198	181	198	212	233	259	281	304	326	350	394	422	450	478	539	600	667	731	798	856	911
108"	203	186	205	220	242	269	296	320	344	368	409	443	473	500	566	630	703	763	834	897	957
114"	213	198	213	234	252	284	310	337	361	384	430	462	496	524	596	659	736	802	875	940	1000
120"	219	204	220	243	263	296	320	347	374	399	450	481	516	550	622	690	770	838	916	981	1046
126"	225	210	234	256	272	310	337	363	390	421	469	500	537	570	646	714	802	871	957	1021	1088

NOTE: Smallest width available 9". Blinds from 9" to 11⁵/₁₆" are center tilt only.

Colors

Alabaster 112	Black Satin 233	Dark Bronze 168	Raw Umber 006
Alabaster Pearl 326	Brushed Aluminum . . . 121	Gray Haze 983	Snowcap White 386
Almond 724	Burgundy 653	Greige 122	Stucco 963
Almost White Gloss . . 065	Char Brown 062	Hunter Green 154	True White 544
Ash Metallic 126	Creamy Beige 670	Lamplight 904	White Gloss 005
		Polished Aluminum . . . 741	White Satin 205

With Cloth Tapes

HEIGHT UP TO ↓	WIDTH UP TO →																				
	12"	23"	26"	29"	32"	36"	40"	44"	48"	52"	57"	62"	67"	72"	82"	92"	102"	112"	122"	132"	142"
42"	\$130	113	118	127	137	156	167	179	190	206	232	245	266	278	312	348	391	423	460	497	528
48"	136	118	127	143	153	170	185	196	210	227	252	270	290	307	348	380	428	465	509	544	577
54"	145	127	143	153	163	185	196	213	230	242	274	297	312	332	375	416	467	509	553	593	635
60"	161	141	153	163	176	196	213	232	245	268	298	314	340	359	407	446	509	550	601	641	685
66"	167	148	162	176	190	213	232	245	269	284	317	342	363	390	438	484	544	589	642	690	736
72"	176	159	173	187	199	228	244	268	284	302	342	368	390	416	467	518	580	635	690	738	789
78"	185	167	185	196	213	242	262	281	302	323	363	390	416	442	499	550	618	675	735	789	841
84"	196	177	191	210	230	252	274	299	317	342	388	415	442	467	531	581	654	715	777	836	889
90"	206	187	206	223	239	269	297	313	340	361	407	438	465	495	562	618	695	758	821	884	944
96"	214	196	213	235	252	284	307	332	357	385	428	459	490	522	591	651	735	799	868	929	998
102"	228	208	228	244	268	298	323	350	375	403	453	485	518	550	620	690	767	841	918	984	1048
108"	233	214	236	253	278	309	340	368	396	423	470	509	544	575	651	725	808	877	959	1032	1101
114"	245	228	245	269	290	327	357	388	415	442	495	531	570	603	685	758	846	922	1006	1081	1150
120"	252	235	253	279	302	340	368	399	430	459	518	553	593	633	715	794	886	964	1053	1128	1203
126"	259	242	269	294	313	357	388	417	449	484	539	575	618	656	743	821	922	1002	1101	1174	1251

1½" Cloth Tape

Beige 2011	Duck White 2136	Moss 2500	Wheat 2710
Black 2033	Forest 2234	Navy 2369	White 2005
Chocolate 2353	Light Beige 2137	Taupe 2659	White Smoke 2617
Cocoa 2297	Maroon 2360	Toffee 2296	



Used on all standard colors.

Horizontal Blinds



2" Aluminum School Blind

HEIGHT UP TO ↓	WIDTH UP TO →																				
	12"	23"	26"	29"	32"	36"	40"	44"	48"	52"	57"	62"	67"	72"	82"	92"	102"	112"	122"	132"	142"
42"	\$130	113	118	127	137	156	167	179	190	206	232	245	266	278	312	348	391	423	460	497	528
48"	136	118	127	143	153	170	185	196	210	227	252	270	290	307	348	380	428	465	509	544	577
54"	145	127	143	153	163	185	196	213	230	242	274	297	312	332	375	416	467	509	553	593	635
60"	161	141	153	163	176	196	213	232	245	268	298	314	340	359	407	446	509	550	601	641	685
66"	167	148	162	176	190	213	232	245	269	284	317	342	363	390	438	484	544	589	642	690	736
72"	176	159	173	187	199	228	244	268	284	302	342	368	390	416	467	518	580	635	690	738	789
78"	185	167	185	196	213	242	262	281	302	323	363	390	416	442	499	550	618	675	735	789	841
84"	196	177	191	210	230	252	274	299	317	342	388	415	442	467	531	581	654	715	777	836	889
90"	206	187	206	223	239	269	297	313	340	361	407	438	465	495	562	618	695	758	821	884	944
96"	214	196	213	235	252	284	307	332	357	385	428	459	490	522	591	651	735	799	868	929	998
102"	228	208	228	244	268	298	323	350	375	403	453	485	518	550	620	690	767	841	918	984	1048
108"	233	214	236	253	278	309	340	368	396	423	470	509	544	575	651	725	808	877	959	1032	1101
114"	245	228	245	269	290	327	357	388	415	442	495	531	570	603	685	758	846	922	1006	1081	1150
120"	252	235	253	279	302	340	368	399	430	459	518	553	593	633	715	794	886	964	1053	1128	1203
126"	259	242	269	294	313	357	388	417	449	484	539	575	618	656	743	821	922	1002	1101	1174	1251

NOTE: Smallest width available 9". Blinds from 9" to 11¹⁵/₁₆" are center tilt only.

Colors

- Alabaster 112
- Almond 724
- Brushed Aluminum 121
- Char Brown 062
- Creamy Beige 670
- Gray Haze 983

- Lamplight 904
- Polished Aluminum 741
- Snowcap White 386
- White Gloss 005
- White Satin 205

1½" Vinyl Ladder Tape

- Char Brown 062
- Creamy Beige 670
- Gray Haze 983

- Lamplight 904
- White 005



Horizontal Blinds

Skylights: Dual Headrail

Dual Headrail Features

- For windows at more than a 45 degree angle
- Blinds are tilt only
- Choose .006 or .008 gauge 1" aluminum slat
- 1" x 1½" steel headrail, box design
- Ring tilt left (standard) or right
- Color-coordinated components provide a finished look (see page 12)
- Multi-colored striped blinds (see page 3)
- Sky Poles available for easy tilting (see page 3)

Dual Headrail Skylight

Ideal for skylights at more than a 45 degree angle.

NOTE: Blind is tilt only, no lift.

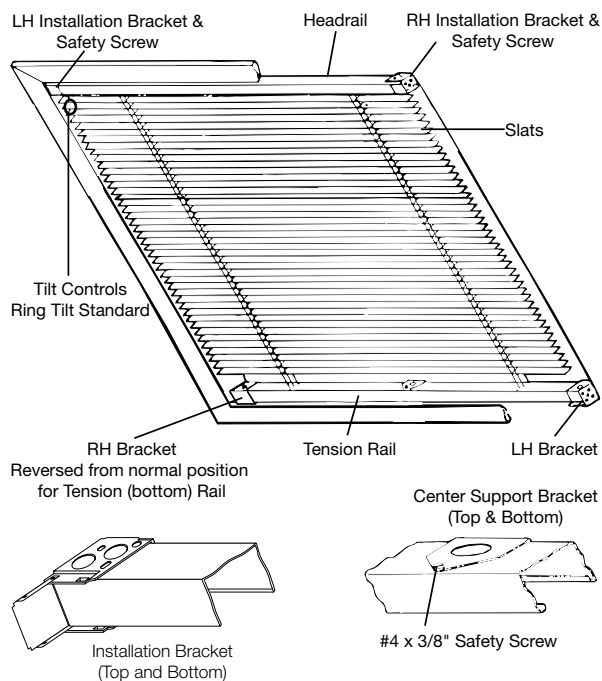

How to Measure

Inside Mount

Measure precise width and height dimensions and specify this as an "opening size, make allowance". Do not deduct for headrail clearance gaps. Manufacturer will make all allowances for both width and height. Headrail, tension rail and slats will be manufactured ½" less than the dimension given as width. Proper deductions will be made for blind height.

Outside Mount

Measure width and height dimensions and specify as "blind size, cut exact". The manufacturer will not make any allowances for width or height. Headrail, tension rail and slats will equal dimensions given as width. Blind height will refer to the distance from the top of the upper bracket to the lower bracket of the installed blind and will equal dimension given as height. Do not deduct for headrail and tension rail clearance gaps.

Dual Headrail Component Diagram

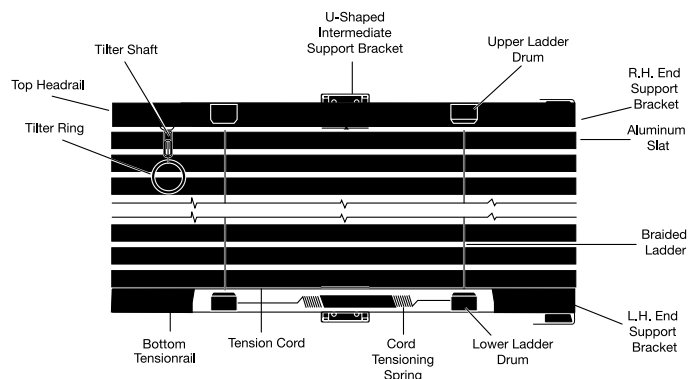

TILT ONLY - NO LIFT

NOTE: Blind height may measure shorter than order states due to the cord tension spring. Proper installation will increase tension and lengthen the blind to completely cover your window opening.

Size Specifications

Dual Headrail		
Minimum Width	9"	
Maximum Width	142"	
Minimum Height	10"	
Maximum Height	Blind Width	Max Height
	9" - 23"	126"
	23½" - 32"	102"
	32½" - 72"	90"
	72½" - 142"	80"

Incline Wire Features

- Degree from vertical cannot exceed 45 degrees
- Choose .006 or .008 gauge 1" aluminum slat
- 1" x 1½" steel headrail, box design
- Torque wand tilter with clear wand
- Wand tilt left (standard) or right
- Durable polyester lift cord
- Lift cord right (standard) or left
- Cord bead stops
- Almost invisible braided polyester support ladders
- Color-coordinated components provide a finished look (see page 12)
- Sky poles available for easy tilting upon request (see page 3)
- Multi-colored striped blinds (see page 3)
- Double-slatted blinds (see page 3)
- Ring tilt may be substituted for wand
- Ring pull is an option

How to Measure

Inside Mount

Measure precise width and height dimensions and specify this as an "opening size, make allowance". Do not deduct for headrail clearance gaps. Manufacturer will make all allowances for both width and height. Headrail, tension rail and slats will be manufactured ½" less than the dimension given as width. Proper deductions will be made for blind height.

Outside Mount

Measure width and height dimensions and specify as "blind size, cut exact". The manufacturer will not make any allowances for width or height. Headrail, tension rail and slats will equal dimensions given as width. Blind height will refer to the distance from the top of the upper bracket to the lower bracket of the installed blind and will equal dimension given as height. Do not deduct for headrail and tension rail clearance gaps.

NOT RECOMMENDED FOR INSTALLATIONS GREATER THAN 45° FROM VERTICAL

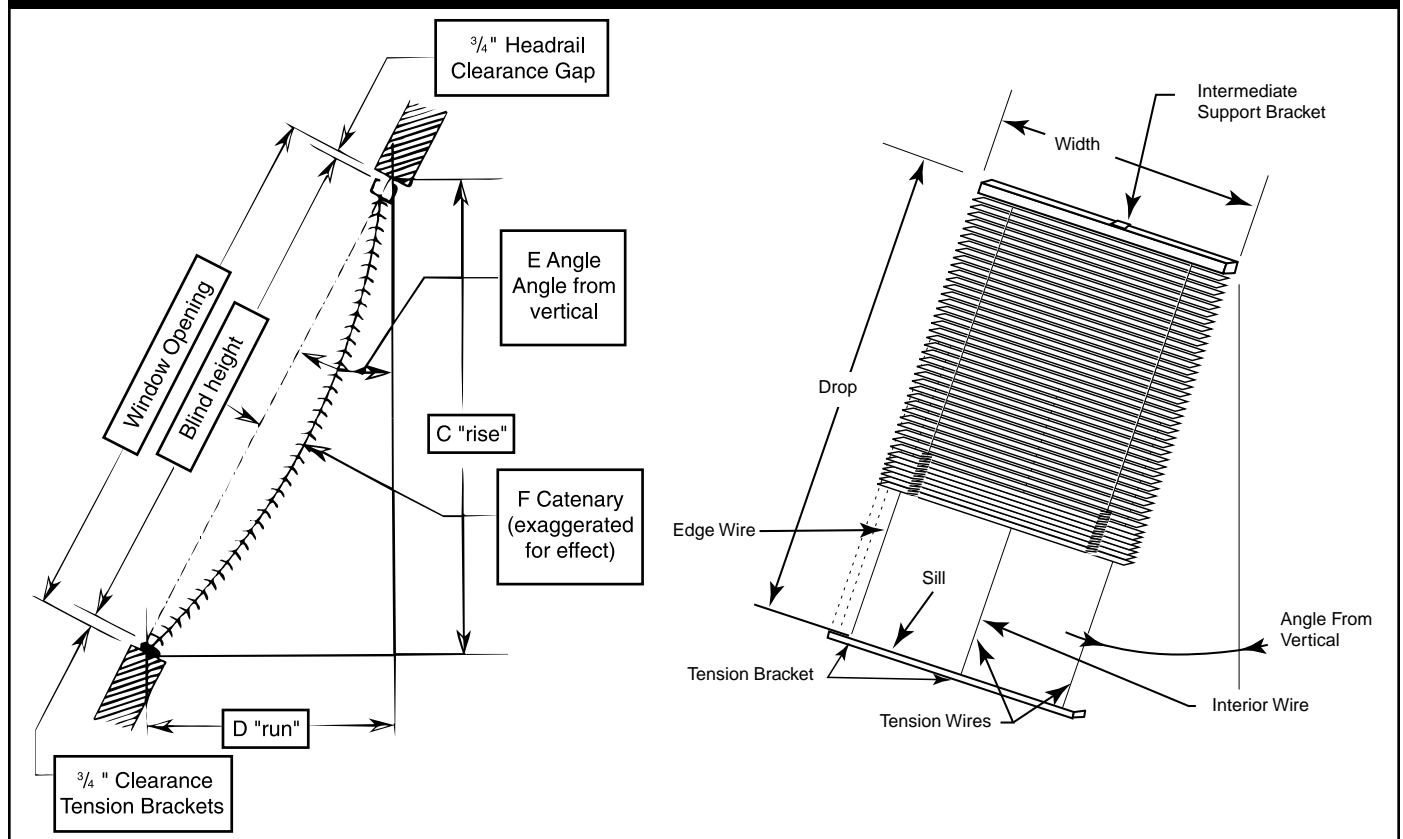

Size Specifications

		Incline Wire	
Minimum Width	9" exact		
Maximum Width	122"		
Minimum Height	10"		
Maximum Height	Blind Width	Max Height	
	9" - 32"	126"	
	32½" - 57"	108"	
	57½" - 92"	102"	
	92½" - 122"	90"	



Horizontal Blinds

Color Coordination Chart

Skylight Blinds: Incline Wire and Dual Headrail

The Bali Skylight blind uses a specially constructed ladder designed for the interlacing of slats. The five ladder colors offered will coordinate with many slat colors.

Interlacing Ladder Color	Slat Color Examples					
Char Brown #062	Char Brown	062	Milk Chocolate	060	Tender Taupe	103
	Granite	044	Raw Umber	006		
Smokey Gray #026	Aluminum	034	Greige	122	Skyline	680
	Black Satin	233	Pitch Black	033	Smokey Gray	026
	Brushed Aluminum	121	Polished Aluminum	741	Stucco	963
	Gray Dawn	405	Rock Gray	399	UN Gray	095
	Gray Haze	983	Silver	737		
Fawn #031	Buff	624	Desert Sand	625	Lamplight	904
	Cameo	607	Fawn	031		
	Creamy Beige	670	Fawn Pearl	327		
White Gloss #005	Burgundy	653	Magnet	648	True Blue	089
	Coconut	630	Mercury	771	True White	544
	Crystal White	629	Midnight Blue	057	White Gloss	005
	Forest Shadow	087	Navajo White	376	White Satin	205
	Hunter Green	154	Real Red	085	White Pearl	637
	Ice	778	Snowcap White	386		
Alabaster #112	Alabaster	112	Ash Metallic	126	Flax	541
	Alabaster Pearl	326	Beige	011	Matte White	042
	Almond	724	Beige Pearl	328	Parchment	535
	Almost White Gloss	065	Birch White	375	Vanilla	100

Dual Headrail and Incline Wire Blinds

.006 Gauge

HEIGHT UP TO ↓	WIDTH UP TO →														132"	142"					
	12"	23"	26"	29"	32"	36"	40"	44"	48"	52"	57"	62"	67"	72"			82"	92"	102"	112"	122"
42"	\$197	179	192	198	208	258	268	275	286	293	344	366	384	394	460	489	532	558	589	635	681
48"	208	192	202	208	217	272	284	292	304	314	366	391	406	422	497	527	572	605	633	685	735
54"	213	198	210	217	231	288	302	310	320	330	391	417	430	450	532	560	611	646	677	734	791
60"	221	206	217	228	242	304	316	324	339	350	413	442	459	473	560	599	656	693	725	785	846
66"	230	213	231	238	253	318	328	343	357	371	437	465	489	502	601	635	699	735	773	837	901
72"	240	223	239	251	265	330	345	359	374	390	459	492	514	531	617	671	742	777	819	885	952
78"	252	235	252	263	279	350	362	375	390	398	490	523	544	567	672	717	797	838	877	949	1020
84"	258	242	259	271	288	359	375	395	409	424	502	539	563	587	699	745	820	868	912		
90"	267	251	271	281	302	375	395	411	425	443	527	563	592	611	734	778	864	911	961		
96"	274	258	279	290	311	391	409	425	443	462	552	589	617	639	766	817					
102"	284	268	289	304	322	408	424	443	465	485	572	611	640	643	801	854					
108"	289	273	297	311	332	421	439	460	481	500	596										
114"	303	285	310	322	345																
120"	310	292	316	330	358																
126"	319	304	324	343	371																

Incline wire available only in sizes to the left of the dotted line.

Dual Headrail available only in sizes above the heavy line.

.008 Gauge

HEIGHT UP TO ↓	WIDTH UP TO →														132"	142"					
	12"	23"	26"	29"	32"	36"	40"	44"	48"	52"	57"	62"	67"	72"			82"	92"	102"	112"	122"
42"	\$213	198	210	216	228	284	293	304	316	323	378	404	422	434	505	537	587	615	647	699	750
48"	225	210	221	228	239	302	312	322	335	344	404	430	447	465	548	580	630	666	697	754	809
54"	233	216	231	239	255	318	328	340	353	365	430	458	474	496	587	617	673	710	746	808	869
60"	243	225	239	252	265	335	349	358	372	386	453	486	504	520	617	659	722	761	798	864	931
66"	251	235	255	263	277	350	362	377	391	408	481	512	537	553	662	699	769	809	852	920	989
72"	263	247	264	275	290	365	381	394	411	429	504	540	565	584	677	740	815	855	903	974	1048
78"	275	259	276	288	308	386	398	414	429	439	539	575	597	625	741	791	875	922	967	1046	1122
84"	281	265	285	297	318	394	414	435	450	467	553	593	620	644	769	819	904	954	1004		
90"	291	275	297	310	328	414	435	451	468	487	580	620	651	673	808	856	950	1003	1056		
96"	301	284	308	320	341	430	450	468	487	506	607	647	677	702	843	901					
102"	310	293	319	335	354	448	467	487	512	532	630	673	705	707	879	939					
108"	318	303	326	341	366	463	482	505	530	550	656										
114"	329	314	340	354	381																
120"	339	322	349	365	392																
126"	351	335	358	377	408																

Incline wire available only in sizes to the left of the dotted line.

Dual Headrail available only in sizes above the heavy line.



Horizontal Blinds

Incline Wire Specialty Shapes: Side Cuts,
Angle Tops and Bottoms

.006 Gauge

HEIGHT UP TO ↓	WIDTH UP TO →																		
	12"	23"	26"	29"	32"	36"	40"	44"	48"	52"	57"	62"	67"	72"	82"	92"	102"	112"	122"
42"	\$496	480	492	497	506	593	603	610	622	664	714	736	755	809	875	904	1018	1046	1074
48"	507	492	501	506	518	607	620	629	639	685	736	762	777	837	912	941	1058	1091	1118
54"	514	497	511	518	531	624	635	644	656	702	762	786	802	865	948	975	1097	1131	1164
60"	523	505	518	528	541	639	652	660	673	720	782	812	829	887	975	1014	1141	1178	1212
66"	530	514	531	539	553	654	664	677	693	742	808	835	860	918	1017	1051	1184	1221	1260
72"	540	524	540	550	565	666	680	695	709	761	829	863	884	946	1030	1085	1226	1263	1305
78"	552	536	552	561	580	686	698	710	725	769	861	894	914	982	1087	1132	1281	1324	1364
84"	557	541	558	570	589	695	710	731	745	796	873	910	934	1001	1114	1160	1306	1354	1398
90"	566	550	570	582	600	710	731	746	761	813	898	934	962	1026	1149	1192	1349	1396	1445
96"	574	557	580	592	610	727	745	761	778	833	922	959	986	1054	1182	1233			
102"	584	567	591	603	622	744	759	778	801	855	944	982	1012	1058	1216	1268			
108"	591	574	597	610	633	757	773	797	816	871	967								
114"	602	587	608	622	646														
120"	608	593	617	631	658														
126"	620	603	625	643	671														

.008 Gauge

HEIGHT UP TO ↓	WIDTH UP TO →																		
	12"	23"	26"	29"	32"	36"	40"	44"	48"	52"	57"	62"	67"	72"	82"	92"	102"	112"	122"
42"	\$514	497	511	516	528	620	630	639	652	695	749	773	794	850	920	952	1072	1101	1132
48"	527	511	523	528	540	635	647	658	668	714	773	802	817	879	962	1000	1115	1153	1182
54"	532	516	531	540	554	654	664	675	690	735	802	828	845	911	1001	1030	1160	1195	1231
60"	544	527	540	552	565	668	685	694	707	757	824	856	875	934	1030	1074	1209	1246	1283
66"	552	536	554	561	579	686	698	711	727	778	852	882	908	969	1077	1114	1255	1294	1336
72"	561	546	563	575	592	701	715	730	746	801	875	911	935	1000	1092	1154	1301	1340	1387
78"	575	558	578	589	607	720	734	749	765	809	910	946	969	1040	1155	1204	1361	1408	1451
84"	582	565	587	597	618	730	749	770	785	837	923	965	989	1059	1184	1234	1388	1440	1489
90"	592	575	597	608	630	749	770	786	804	859	950	989	1021	1088	1222	1271	1436	1487	1541
96"	600	584	607	621	642	766	785	804	821	877	978	1018	1050	1116	1258	1316			
102"	610	595	620	634	655	783	802	821	848	904	1001	1046	1076	1123	1294	1354			
108"	618	601	626	642	666	800	817	842	865	920	1026								
114"	630	612	640	655	680														
120"	639	622	650	664	694														
126"	651	634	658	676	707														

Horizontal Blinds



Incline Wire Specialty Shapes: Octagons, Triangles and Other Shapes

.006 Gauge

HEIGHT UP TO ↓	WIDTH UP TO →																		
	12"	23"	26"	29"	32"	36"	40"	44"	48"	52"	57"	62"	67"	72"	82"	92"	102"	112"	122"
42"	\$594	578	589	595	604	707	717	725	736	798	848	869	887	977	1042	1072	1221	1247	1276
48"	604	589	599	604	615	722	734	744	754	816	869	895	910	1005	1080	1110	1261	1294	1322
54"	610	595	607	615	629	740	750	759	770	834	895	919	934	1032	1115	1143	1301	1334	1367
60"	620	603	615	625	639	754	766	774	788	854	915	945	962	1055	1143	1182	1344	1379	1413
66"	627	610	629	635	651	768	779	794	807	873	940	969	991	1085	1184	1218	1387	1425	1463
72"	638	621	638	647	662	781	797	809	824	894	962	995	1017	1114	1199	1254	1430	1465	1508
78"	650	633	650	659	676	801	812	825	839	903	992	1025	1047	1150	1255	1301	1484	1528	1567
84"	655	639	656	667	686	809	825	846	860	926	1007	1041	1067	1168	1281	1327	1510	1556	1600
90"	663	647	667	677	698	825	846	861	875	946	1029	1067	1093	1194	1318	1361	1551	1599	1649
96"	671	655	676	690	707	842	860	875	894	966	1055	1091	1119	1221	1349	1400			
102"	680	664	689	701	719	859	873	894	915	986	1076	1115	1143	1225	1382	1436			
108"	689	671	695	707	730	871	888	911	931	1004	1099								
114"	699	681	706	719	744														
120"	706	691	713	728	755														
126"	716	701	722	741	768														

.008 Gauge

HEIGHT UP TO ↓	WIDTH UP TO →																		
	12"	23"	26"	29"	32"	36"	40"	44"	48"	52"	57"	62"	67"	72"	82"	92"	102"	112"	122"
42"	\$610	595	607	612	625	734	745	754	766	826	880	907	925	1017	1088	1119	1273	1303	1335
48"	624	607	620	625	638	750	762	772	783	848	907	934	950	1048	1130	1162	1319	1356	1384
54"	630	612	629	638	652	768	779	791	804	868	934	961	977	1078	1168	1199	1362	1399	1434
60"	641	624	638	650	662	783	800	808	821	888	957	987	1008	1102	1199	1241	1411	1449	1485
66"	650	633	652	659	675	801	812	826	842	911	983	1016	1040	1135	1245	1281	1459	1497	1540
72"	659	643	660	672	690	815	831	845	861	932	1008	1042	1069	1166	1261	1322	1503	1543	1590
78"	672	656	673	686	705	835	850	864	879	941	1041	1078	1101	1209	1323	1373	1565	1611	1654
84"	678	662	681	695	714	845	864	885	901	970	1056	1095	1123	1226	1353	1403	1591	1643	1692
90"	690	672	695	706	727	864	885	903	918	989	1083	1123	1154	1256	1390	1438	1639	1690	1745
96"	698	680	705	717	740	880	901	918	936	1012	1111	1150	1182	1285	1426	1483			
102"	708	693	715	731	752	899	916	936	962	1035	1132	1178	1209	1290	1463	1521			
108"	714	699	724	740	763	914	932	957	979	1054	1160								
114"	727	710	736	752	778														
120"	735	719	746	762	791														
126"	748	731	755	773	805														



Horizontal Blinds

Specialty Shapes: Arches

Features

- Choose .006 or .008 gauge 1" aluminum slat
- Use 1" x 1" aluminum headrail
- Valance not available
- A template is required for all arches except Perfect Arches
- Limitations may apply within each blind type. Fax a drawing to Customer Service to determine availability
- May require 4-6 weeks lead time to manufacture
- Available in all Classics colors (see page 26)

Size Considerations

	Arches	Quarter Arch
Minimum Width	10"	12 ³ / ₄ "
Maximum Width	Base 142"	142"
Minimum Height	5"	6"
Maximum Height	170"	170"

Controls

Arches: Standard, Reverse or Same Side
 Quarter Arch: Low Side
 Full Tilt: Lift depends on shape
 Top Lock Cord Lock, Cord Tilt, Ring Tilt and
 Turn Clips: Not Available

Arches

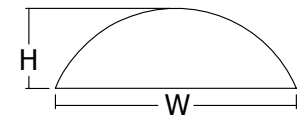
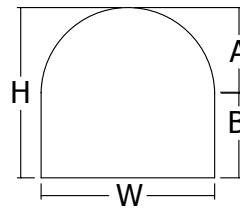
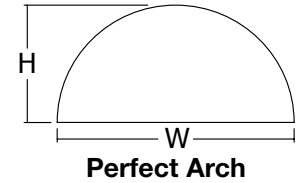
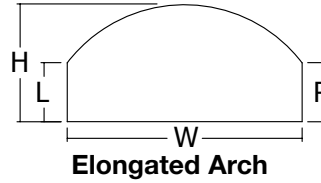

Quarter Arches

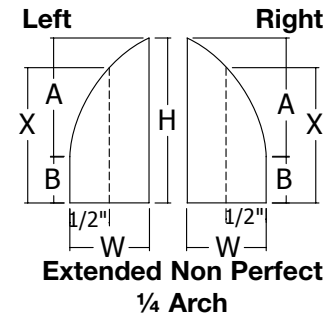
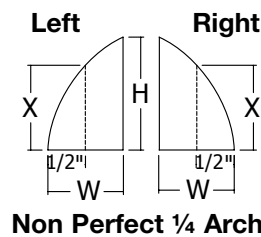
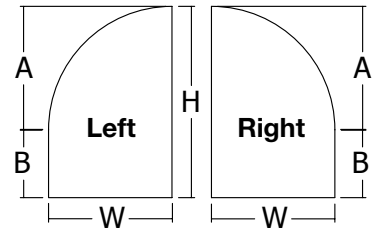
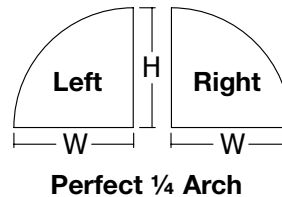

1" Slats .006 Gauge

HEIGHT UP TO ↓	WIDTH UP TO →																				
	12"	23"	26"	29"	32"	36"	40"	44"	48"	52"	57"	62"	67"	72"	82"	92"	102"	112"	122"	132"	142"
42"	\$698	681	686	693	702	709	719	731	829	837	854	863	876	885	911	932	1000	1020	1076	1102	1118
48"	807	792	798	809	815	828	837	848	889	903	920	931	945	987	1017	1042	1110	1131	1197	1224	1247
54"	887	871	882	888	894	911	920	927	975	983	1009	1024	1034	1083	1110	1140	1209	1236	1301	1328	1358
60"	973	957	962	967	982	995	1003	1016	1059	1074	1097	1111	1127	1170	1203	1231	1309	1339	1404	1434	1463
66"	1048	1030	1038	1055	1063	1074	1087	1095	1145	1162	1183	1199	1212	1265	1296	1324	1408	1436	1508	1541	1574
72"	1184	1168	1180	1192	1200	1218	1228	1242	1269	1281	1306	1322	1339	1360	1390	1426	1599	1637	1688	1719	1752
78"	1267	1251	1263	1272	1280	1301	1311	1328	1356	1367	1391	1412	1433	1446	1490	1521	1701	1735	1790	1825	1860
84"	1350	1334	1343	1354	1365	1384	1399	1415	1437	1457	1485	1506	1521	1537	1583	1617	1799	1841	1896	1931	1969
90"	1357	1340	1350	1362	1374	1395	1413	1425	1455	1465	1496	1517	1535	1562	1600	1643	1821	1866	1924	1967	2007
96"	1362	1345	1354	1367	1378	1407	1422	1438	1464	1483	1513	1532	1558	1575	1620	1665	1851	1890	1957	1999	2038
102"	1367	1350	1365	1375	1390	1413	1430	1446	1476	1494	1529	1547	1573	1595	1643	1688	1876	1922	1985	2032	2080
108"	1374	1358	1371	1384	1399	1422	1442	1459	1489	1510	1540	1566	1591	1613	1665	1713	1904	1948	2017	2064	2114
114"	1381	1365	1375	1395	1408	1430	1450	1472	1506	1521	1562	1583	1609	1632	1683	1735	1926	1974	2050	2110	2175
120"	1382	1367	1384	1403	1417	1442	1459	1484	1515	1535	1573	1595	1622	1651	1710	1756	1953	2007	2075	2128	2181
126"	1390	1374	1395	1413	1425	1450	1476	1496	1524	1544	1587	1616	1643	1669	1727	1780	1978	2034	2100	2155	2206

1" Slats .008 Gauge

HEIGHT UP TO ↓	WIDTH UP TO →																				
	12"	23"	26"	29"	32"	36"	40"	44"	48"	52"	57"	62"	67"	72"	82"	92"	102"	112"	122"	132"	142"
42"	\$706	691	694	701	711	719	731	745	843	852	869	877	895	906	932	957	1025	1050	1107	1135	1154
48"	815	800	807	819	825	839	851	861	906	918	939	950	965	1009	1040	1070	1139	1162	1231	1261	1288
54"	897	879	894	899	904	923	934	944	991	1001	1028	1046	1056	1107	1134	1168	1240	1269	1336	1369	1400
60"	982	967	973	977	995	1008	1017	1030	1076	1091	1118	1132	1150	1195	1231	1263	1343	1375	1442	1479	1508
66"	1058	1041	1050	1067	1077	1088	1104	1112	1164	1182	1204	1222	1236	1292	1326	1357	1444	1476	1551	1589	1624
72"	1194	1179	1191	1207	1214	1234	1245	1261	1289	1302	1330	1345	1365	1387	1423	1461	1639	1679	1735	1770	1805
78"	1279	1263	1275	1286	1294	1318	1330	1347	1375	1388	1416	1438	1461	1477	1524	1558	1744	1780	1841	1879	1919
84"	1362	1345	1357	1369	1381	1403	1417	1436	1460	1480	1513	1533	1550	1570	1620	1655	1843	1889	1949	1989	2029
90"	1370	1354	1365	1377	1390	1413	1434	1445	1477	1490	1524	1545	1566	1595	1639	1685	1868	1918	1980	2028	2072
96"	1376	1360	1369	1382	1395	1426	1441	1463	1489	1510	1541	1563	1591	1611	1659	1710	1900	1945	2017	2063	2106
102"	1381	1365	1381	1391	1408	1434	1451	1471	1500	1522	1561	1579	1608	1632	1685	1735	1928	1978	2045	2097	2151
108"	1389	1373	1387	1403	1417	1441	1467	1483	1515	1539	1573	1599	1629	1651	1710	1761	1960	2007	2080	2135	2191
114"	1397	1381	1391	1413	1427	1451	1475	1498	1533	1550	1595	1620	1647	1673	1728	1786	1983	2036	2120	2186	2254
120"	1398	1382	1403	1422	1438	1467	1483	1513	1544	1566	1608	1632	1662	1694	1757	1809	2015	2075	2144	2203	2261
126"	1406	1390	1413	1434	1445	1475	1501	1524	1554	1577	1624	1654	1685	1713	1778	1836	2041	2101	2175	2235	2290



Horizontal Blinds

Specialty Shapes: Circles

Features

- Choose .006 or .008 gauge 1" aluminum slat
- An illustration can be resized
- Use 1" x 1" aluminum headrail
- Valance not available
- A template is required for all non perfect circles
- Limitations may apply within each blind type. Fax a drawing to Customer Service to determine availability
- May require up to 4-6 weeks lead time to manufacture
- Available in all Classics colors (see page 26)

Size Considerations

Minimum Width	12" diameter
Maximum Width	72"

Controls

Controls: Left or Right

Full tilt: No Lift

Top Lock Cord Lock, Cord Tilt, and Turn Clips: Not Available

Circles

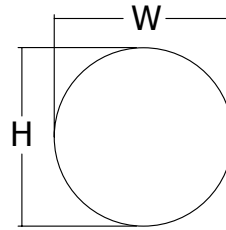

Full Circle

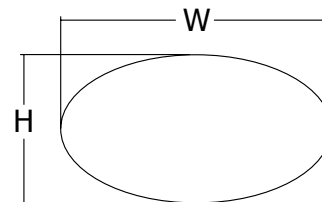

Non Perfect Circle



To price use larger number for width.

1" Slats .006 Gauge

HEIGHT UP TO ↓	WIDTH UP TO →													
	12"	23"	26"	29"	32"	36"	40"	44"	48"	52"	57"	62"	67"	72"
42"	\$663	647	701	758	817	894	971	1051	1134	1210	1310	1404	1501	1596
48"	666	651	706	769	825	907	982	1060	1144	1224	1328	1423	1519	1616
54"	672	656	717	774	829	915	992	1069	1157	1233	1343	1441	1536	1637
60"	684	667	724	779	846	925	1001	1081	1166	1250	1358	1456	1554	1650
66"	687	671	728	797	855	932	1014	1089	1182	1265	1371	1471	1567	1673
72"	692	675	736	802	860	945	1022	1106	1197	1276	1387	1485	1587	1693

1" Slats .008 Gauge

HEIGHT UP TO ↓	WIDTH UP TO →													
	12"	23"	26"	29"	32"	36"	40"	44"	48"	52"	57"	62"	67"	72"
42"	\$671	655	707	766	828	904	982	1063	1148	1224	1327	1421	1519	1616
48"	674	658	714	779	835	918	996	1074	1160	1240	1345	1441	1539	1637
54"	680	664	728	785	839	927	1007	1083	1172	1250	1362	1463	1558	1659
60"	694	677	734	791	859	939	1016	1097	1183	1267	1378	1477	1578	1676
66"	697	680	740	808	868	948	1029	1107	1199	1285	1394	1494	1591	1699
72"	702	686	749	815	872	961	1038	1123	1217	1297	1411	1511	1614	1722



Horizontal Blinds

Specialty Shapes: Side Cuts, Angle Top & Bottom

Features

- Choose .006 or .008 gauge 1" aluminum slat
- An illustration can be inverted or reversed or resized
- Use 1" x 1½" steel headrail
- Valance not available
- Limitations may apply within each blind type. Fax a drawing to Customer Service to determine availability.
- May require up to 2-4 weeks lead time to manufacture
- To order, fax a signed drawing with all dimensions to customer service.
- Available as Incline Wire for Skylights (see page 11)
- Available in all Classics colors (see page 26)

Controls

- Side Cuts: Standard, Reverse or Same Side (straight side only)
- Angle Bottoms: Standard, Reverse or Same Side (dependent on shape)
- Angle Tops & Bottoms: Cord Lock must be Low Side
- Full Tilt: Lift depends on shape
- Cord Tilt: not available
- Top Lock Cord Lock: not available
- Angle Bottoms: Bottom point will have light gap, 60° maximum angle degree

Size Considerations

	Side Cuts	Angle Top and Bottom
Minimum Bottom Rail	4½" Exact	12" Exact
Maximum Width	142"	142"
Minimum Height	6"	6"
Maximum Height	126"	126"

Side cuts, triangles, angle top and bottom

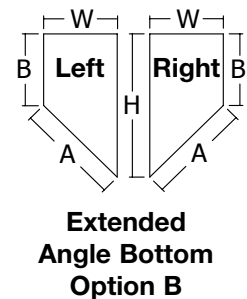
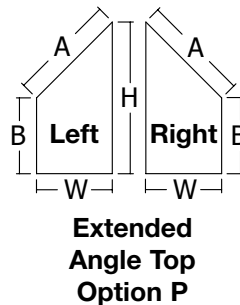
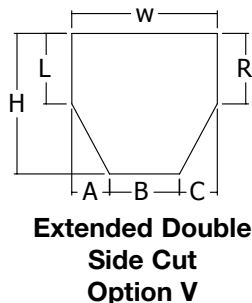
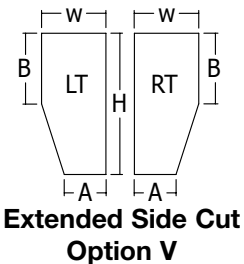
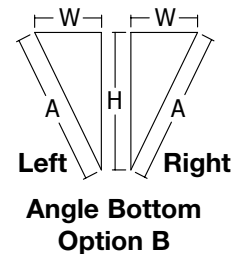
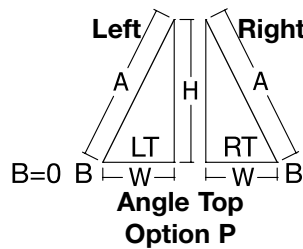
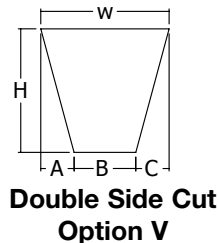
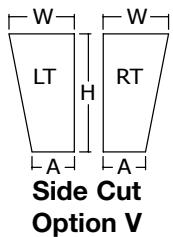



Specialty Shapes: Side Cuts, Angle Top & Bottom

1" Slats .006 Gauge

HEIGHT UP TO ↓	WIDTH UP TO →																				
	12"	23"	26"	29"	32"	36"	40"	44"	48"	52"	57"	62"	67"	72"	82"	92"	102"	112"	122"	132"	142"
42"	\$393	377	379	386	395	439	448	460	468	511	527	536	550	603	629	651	754	773	800	922	939
48"	395	379	386	396	404	451	460	471	478	525	545	554	567	622	651	676	777	800	829	953	977
54"	402	386	396	404	408	460	471	478	490	534	558	574	584	643	668	701	802	829	860	983	1014
60"	413	396	404	408	424	471	478	492	500	550	574	588	603	658	691	717	829	860	888	1017	1046
66"	416	399	408	424	432	478	492	500	515	566	588	603	615	679	710	740	856	884	920	1052	1084
72"	420	405	417	429	437	490	500	515	531	579	603	618	635	701	731	766	879	916	954	1084	1116
78"	429	414	425	435	443	498	511	527	544	591	615	635	656	714	758	788	908	941	983	1116	1153
84"	441	424	432	443	454	510	524	540	552	605	635	655	671	731	777	811	932	974	1017	1149	1186
90"	446	429	440	451	463	520	539	549	567	615	646	666	685	755	796	837	954	1000	1046	1184	1225
96"	451	435	443	456	468	531	546	563	579	633	662	680	707	769	813	860	983	1024	1077	1217	1256
102"	456	440	454	465	480	539	554	572	591	644	677	698	722	788	837	880	1009	1055	1106	1250	1297
108"	463	447	460	474	489	546	567	583	603	659	691	714	742	807	860	907	1037	1081	1135	1281	1332
114"	470	454	465	485	497	554	575	597	620	671	710	732	759	825	876	927	1059	1108	1169	1328	1391
120"	471	456	474	492	506	567	583	608	630	685	722	745	772	846	904	950	1087	1141	1194	1344	1398
126"	479	463	485	502	514	575	600	621	639	695	736	765	794	863	920	974	1112	1168	1221	1373	1425

1" Slats .008 Gauge

HEIGHT UP TO ↓	WIDTH UP TO →																				
	12"	23"	26"	29"	32"	36"	40"	44"	48"	52"	57"	62"	67"	72"	82"	92"	102"	112"	122"	132"	142"
42"	\$399	384	387	394	406	448	460	474	481	525	544	552	567	622	651	673	779	804	829	957	974
48"	404	387	394	408	414	463	474	485	493	541	561	574	588	643	673	703	807	829	864	989	1017
54"	411	394	408	414	418	474	485	493	505	550	579	595	605	666	695	728	834	864	897	1024	1056
60"	423	408	414	418	435	485	493	506	516	567	595	608	626	681	717	749	864	897	927	1060	1089
66"	426	411	418	435	446	493	506	516	532	587	608	626	640	706	741	770	894	923	966	1099	1134
72"	431	416	428	443	450	505	516	532	550	599	626	643	662	728	763	802	919	959	1003	1134	1169
78"	442	425	439	448	458	515	528	546	563	611	640	662	685	745	792	825	950	986	1034	1169	1210
84"	451	435	446	458	471	527	544	560	574	630	662	681	701	763	813	851	977	1022	1070	1207	1246
90"	459	443	454	467	480	539	558	570	592	640	673	697	714	788	833	879	1003	1051	1101	1245	1290
96"	464	448	458	473	485	550	566	588	603	659	693	711	742	805	854	904	1034	1078	1135	1280	1324
102"	470	454	471	481	497	558	578	596	615	672	709	730	758	825	879	927	1062	1112	1166	1316	1370
108"	478	462	477	492	506	566	592	607	630	690	722	749	778	846	904	954	1092	1141	1200	1353	1408
114"	488	471	481	502	516	578	599	624	647	701	745	769	798	867	922	979	1116	1169	1238	1404	1472
120"	489	473	492	511	528	592	607	638	659	714	758	781	812	888	952	1004	1148	1209	1265	1422	1479
126"	496	480	502	524	536	599	626	650	668	727	773	805	835	907	971	1029	1176	1236	1294	1451	1508



Horizontal Blinds

Specialty Shapes: Octagons, Triangles

Features

- Choose .006 or .008 gauge 1" aluminum slat
- An illustration can be inverted or reversed or resized
- Angles must be greater than 30 degrees; headrail is split on many of these shapes
- Use 1" x 1½" steel headrail
- Valance not available
- Limitations may apply within each blind type. Fax a drawing to Customer Service to determine availability
- May require up to 2-4 weeks lead time to manufacture
- To order, fax a signed drawing with all dimensions to customer service.
- Available as Incline Wire for Skylights (see page 11)
- Available in all Classics colors (see page 26)

Controls

- Controls: Standard, Reverse or Same Side (straight side only)
- Full Tilt Left or Right: Lift depends on shape
- Limited Tilt: Available
- Cord Tilt: Not available
- Top Lock Cord Lock: Not available

Size Considerations

	Octagon	Triangle	Other Shapes
Minimum Width	7½" Exact Head Rail	12"	7½" Exact Head Rail
Maximum Width	142" or 192" maximum total combined headrail segments		
Minimum Height	12"	6"	6"
Maximum Height	126"	126"	126"

Octagons, triangles and other shapes

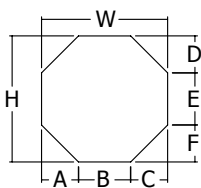

Octagon Option U

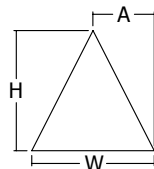

Triangle Option T

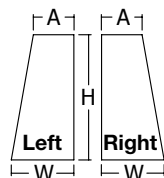

Inverted Side Cut Option I

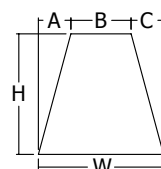

Inverted Double Side Cut Option I

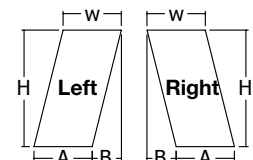

Offset Cut Option I

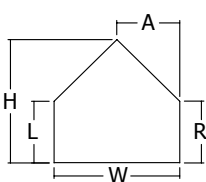

Extended Triangle Option T

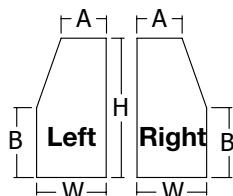

Extended Inverted Side Cut Option I

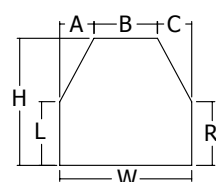

Extended Inverted Double Side Cut Option I

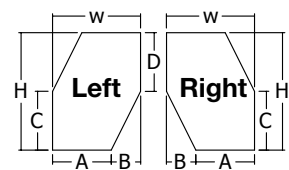

Extended Offset Cut Option I



Specialty Shapes: Octagons, Triangles

1" Slats .006 Gauge

HEIGHT UP TO ↓	WIDTH UP TO →																				
	12"	23"	26"	29"	32"	36"	40"	44"	48"	52"	57"	62"	67"	72"	82"	92"	102"	112"	122"	132"	142"
42"	\$490	474	477	482	493	553	563	575	583	643	659	667	681	770	797	817	957	977	1003	1134	1150
48"	493	477	482	494	500	566	575	587	593	658	676	689	701	791	817	845	979	1003	1032	1165	1188
54"	498	482	494	500	504	575	587	593	604	666	693	706	715	811	837	868	1005	1032	1062	1195	1225
60"	511	494	500	504	521	587	593	605	615	681	706	719	735	825	859	885	1032	1062	1091	1228	1256
66"	514	497	504	521	530	593	605	615	630	699	719	735	748	848	877	907	1059	1087	1124	1264	1296
72"	518	501	514	527	534	604	615	630	646	710	735	750	768	868	899	934	1083	1119	1158	1296	1328
78"	526	511	523	532	540	612	625	642	658	722	748	768	788	882	925	957	1111	1144	1187	1328	1364
84"	537	521	530	540	552	624	639	655	666	740	768	786	804	899	945	978	1135	1178	1220	1361	1398
90"	544	527	537	549	560	634	654	663	681	748	778	800	816	922	962	1005	1158	1202	1247	1396	1437
96"	549	532	540	553	565	646	660	677	694	765	796	813	839	936	981	1026	1187	1226	1280	1429	1468
102"	553	537	552	561	578	654	668	689	705	777	811	829	855	957	1005	1050	1213	1258	1307	1461	1510
108"	560	545	557	570	587	660	681	698	717	792	821	848	873	974	1026	1074	1240	1285	1339	1493	1544
114"	568	552	561	582	595	668	691	711	734	804	843	865	891	992	1046	1095	1263	1310	1373	1540	1603
120"	569	553	570	589	604	681	698	724	745	816	855	876	906	1014	1072	1118	1290	1344	1398	1556	1609
126"	576	560	582	600	610	691	714	735	754	826	869	898	925	1029	1088	1141	1316	1371	1425	1584	1637

1" Slats .008 Gauge

HEIGHT UP TO ↓	WIDTH UP TO →																				
	12"	23"	26"	29"	32"	36"	40"	44"	48"	52"	57"	62"	67"	72"	82"	92"	102"	112"	122"	132"	142"
42"	\$497	481	485	492	502	563	575	589	596	658	675	685	701	791	817	842	982	1007	1032	1168	1186
48"	500	485	492	504	511	579	589	599	607	673	695	706	719	811	842	871	1009	1032	1067	1202	1228
54"	507	492	504	511	515	589	599	607	621	681	710	727	740	834	863	897	1037	1067	1099	1236	1268
60"	521	504	511	515	532	599	607	622	631	701	727	742	759	851	885	916	1067	1099	1131	1272	1302
66"	523	506	515	532	544	607	622	631	647	717	742	759	772	873	908	939	1095	1127	1168	1310	1345
72"	527	512	525	540	548	621	631	647	664	731	759	774	796	897	931	970	1123	1162	1204	1345	1381
78"	539	523	536	546	554	630	643	660	677	745	772	796	816	912	959	992	1154	1190	1237	1381	1422
84"	549	532	544	554	567	642	658	675	690	762	796	815	833	931	981	1018	1180	1225	1272	1417	1459
90"	556	540	552	563	578	654	673	686	706	772	807	828	848	957	1001	1048	1204	1254	1303	1457	1501
96"	561	546	554	569	582	664	680	702	717	792	824	845	873	973	1021	1072	1237	1281	1339	1492	1536
102"	568	552	567	579	595	673	693	710	730	805	842	863	889	992	1048	1095	1265	1316	1370	1528	1582
108"	574	558	574	589	604	680	706	722	745	820	855	880	911	1014	1072	1123	1296	1344	1404	1565	1620
114"	583	567	579	600	612	693	713	740	762	833	876	903	930	1034	1089	1148	1320	1373	1441	1616	1684
120"	585	569	589	607	625	706	722	752	773	848	889	914	945	1056	1119	1170	1350	1411	1468	1633	1690
126"	594	578	600	621	633	713	742	763	783	860	907	936	969	1074	1139	1197	1378	1438	1497	1663	1719



Horizontal Blinds

MAKING A TEMPLATE FOR SPECIALTY SHAPE WINDOWS

1. Tape butcher paper, Kraft or construction paper over the window opening allowing plenty of overlap.
2. Being careful not to press against the template paper while tracing, draw an exact outline of the window opening. Pressing on the template paper may distort the paper and cause the wrong size to be made.
3. Remove the paper from the window opening. If the blind is an outside mount, add the desired amount of overlap to the window outline and draw a second outline around it to match the shape of the finished blind. **Be sure to erase the inside line.**
4. Mark the dimensions on the template. Check that the template dimensions match your measurements of the actual window opening.

NOTE: Make sure the template is of the window opening, not the glass only measurement.
5. **Cut the shape from the paper.**
6. **PLACE THE TEMPLATE BACK INTO THE WINDOW OPENING TO CHECK FOR PROPER FIT COMPLETELY AROUND.**
7. **Indicate on the template**
 - "room side" and "top" on the template
 - purchase order number
 - customer's name
 - your store name and account number
8. Roll up template and place in a mailing tube. **DO NOT FOLD TEMPLATE.**

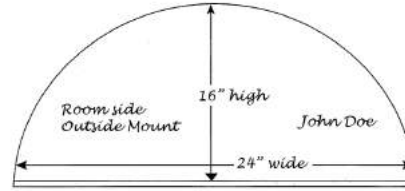

NOTE: This is just a sample for illustration purposes only—other information may be needed for your order.

Mail to: Springs Window Fashions LLC
 33 West Third Street
 Suite 400
 Williamsport, PA 17701
 ATTN: Specialty Dept.

NOTE: When mailing, make sure to get a tracking number and note your return address on the mailing tube.

ACCEPTABLE MATERIALS FOR MAKING TEMPLATES:

Kraft Paper
 Butcher Paper
 Construction Paper

WE WILL NOT ACCEPT TEMPLATES MADE FROM THE FOLLOWING MATERIALS:

Newspaper	Plastic
Wax Paper	Fabric
Tissue Paper	Roofing Paper
Existing Arch Blinds	Wrapping Paper

NOTE: If the material used to make a template stretches, tears easily, will not lay flat or will mark the fabric – IT WILL NOT BE USED.

USING THE TEMPLATE SERVICE

To use the template service, simply:

1. Select Template Service when entering your order online.
2. Use the template worksheet to determine what measurements you need to supply for each shape.
3. Enter the lettered measurements using line item comments. The comments have been pre-programmed to all of the measurements you need to enter for your special shape.

See note at bottom of price grids if Template Service Fees apply.

Cut-Out Options

Cut-Out Blinds

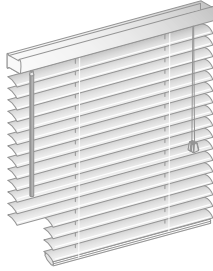

Bottom Corner:

1" and ½" Aluminum: Maximum cut-out is blind width minus 10". A cut-out over 10" requires an intermediate rail.
 2" Vinyl and Aluminum: Maximum cut-out is 1" before the route hole. NOT AVAILABLE WITH CORDLESS.
 "A" minimum is 4½".

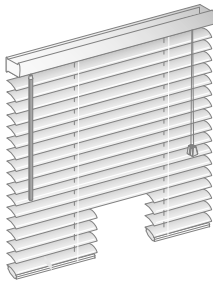
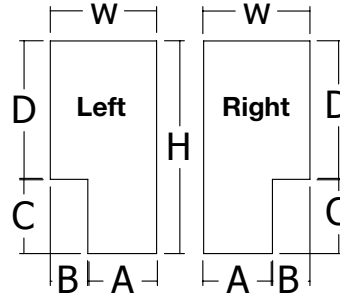

Bottom Center:

NOT AVAILABLE ON 2" BLINDS AND CORDLESS.
 "A" and "C" minimum is 5".
 If "B" is greater than 17", there will be an intermediate rail.

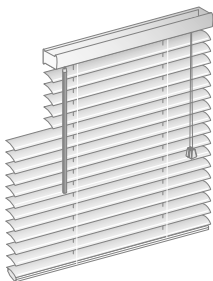
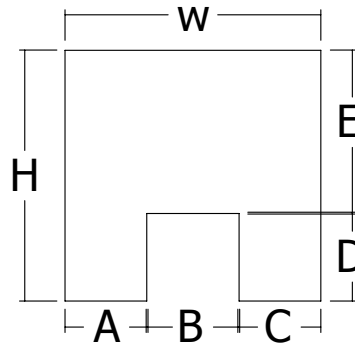

Top Corner:

Maximum cut-out is width is limited to ¼ of total blind width. NOT AVAILABLE ON 2" BLINDS AND CORDLESS.
 "A" minimum is 14".
 If "B" is greater than 8" there will be an intermediate rail.

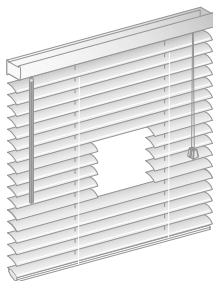
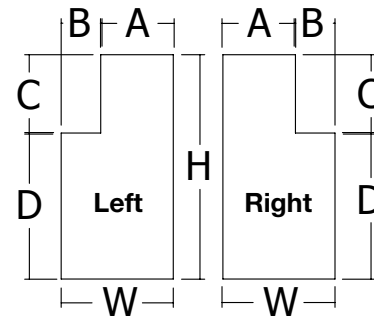

Interior:

"A" and "C" minimum width is 7½". Maximum width for B is blind width minus 15". Intermediate rail is required if B is greater than 17". NOT AVAILABLE ON 2" BLINDS AND CORDLESS.

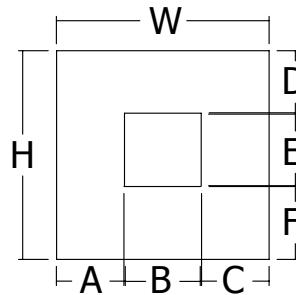

Note: Oversized cut-out could require an intermediate support rail. Slats will not lift below intermediate rail.

Surcharge: \$67



Horizontal Blinds

Color Availability by Product Type – Mini & Micro Blinds

Standard Colors

Color No.	Color Name	S3000	S3000 Cordless	Classics	CustoMiser	S4000	Standard Micro
005	White Gloss	X		X	X	X	X
006	Raw Umber	X		X	X	X	X
011	Beige	X	X	X	X	X	X
026	Smokey Gray	X		X	X	X	X
031	Fawn	X	X	X	X	X	X
033	Pitch Black	X		X	X	X	X
042	Matte White	X		X	X	X	X
044	Granite	X		X	X		
057	Midnight Blue	X		X			
060	Milk Chocolate	X	X	X	X	X	X
062	Char Brown	X	X	X	X	X	X
065	Almost White Gloss	X	X	X	X	X	X
085	Real Red	X	X	X	X		
087	Forest Shadow	X		X	X		
089	True Blue	X	X	X	X		
095	U.N. Gray	X		X	X		
100	Vanilla	X	X	X	X	X	X
103	Tender Taupe	X		X			
112	Alabaster	X	X	X	X	X	X
122	Greige	X		X	X	X	X
154	Hunter Green	X	X	X			
168	Dark Bronze	X		X	X		
170	Silver Mist	X		X	X		
175	Weathered Taupe	X		X	X		
181	Natural Stone	X		X	X		
205	White Satin	X		X	X	X	X
233	Black Satin	X	X	X	X	X	X
375	Birch White	X		X			
376	Navajo White	X		X	X		
386	Snowcap White	X	X	X	X		
399	Rock Gray	X		X			
405	Gray Dawn	X		X			
535	Parchment	X		X	X	X	X
541	Flax	X	X	X	X	X	X
544	True White	X	X	X	X	X	X
607	Cameo	X	X	X	X	X	X
624	Buff	X		X	X		
625	Desert Sand	X	X	X	X		
629	Crystal White	X	X	X	X	X	X
630	Coconut	X	X	X	X		
648	Magnet	X		X			
653	Burgundy	X	X	X	X		
670	Creamy Beige	X		X	X	X	X
680	Skyline	X		X			
724	Almond	X		X			
771	Mercury	X		X			
778	Ice	X		X	X		
904	Lamplight	X	X	X	X	X	X
963	Stucco	X		X	X		
983	Gray Haze	X		X	X	X	X
Metallics							
034	Aluminum	X	X	X	X	X	X
121	Brushed Aluminum	X	X	X	X	X	X
126	Ash Metallic	X		X	X		
737	Silver	X		X	X		
741	Polished Aluminum	X	X	X	X		
Pearltones							
326	Alabaster Pearl	X	X	X	X	X	X
327	Fawn Pearl	X	X	X	X	X	X
328	Beige Pearl	X	X	X			
637	White Pearl	X	X	X		X	X

The following colors are available in perforated slats for S3000, Classics and CustoMiser: 062P Char Brown, 112P Alabaster, 121P Brushed Aluminum, 205P White Satin and 233P Black Satin.

Aluminum Color Coordination Chart

Standard Colors

Color No.	Color Name	Headrail & Bottomrail	Braided Ladder Cord & Lift Tape	Tassel & End Caps
005	White Gloss	005	005	005
006	Raw Umber	006	033	006
011	Beige	011	103	011
026	Smokey Gray	026	026	026
031	Fawn	031	031	031
033	Pitch Black	033	033	033
042	Matte White	042	112	112
044	Granite	044	814	825
057	Midnight Blue	057	008	008
060	Milk Chocolate	060	060	060
062	Char Brown	062	062	062
065	Almost White Gloss	065	112	112
085	Real Red	085	835	025
087	Forest Shadow	087	087	087
089	True Blue	089	089	089
095	U.N. Gray	095	033	591
100	Vanilla	100	112	100
103	Tender Taupe	103	103	103
112	Alabaster	112	112	112
122	Greige	122	026	122
154	Hunter Green	154	154	117
168	Dark Bronze	168	062	716
170	Silver Mist	170	193	170
175	Weathered Taupe	175	126	439
181	Natural Stone	181	181	823
205	White Satin	205	005	005
233	Black Satin	233	033	033
375	Birch White	375	005	005
376	Navajo White	376	112	112
386	Snowcap White	386	005	005
399	Rock Gray	399	026	026
405	Gray Dawn	405	026	026
535	Parchment	535	004	004
541	Flax	541	112	112
544	True White Gloss	544	005	005
607	Cameo	670	031	356
624	Buff	624	031	031
625	Desert Sand	625	029	029
629	Crystal White	629	005	005
630	Coconut	630	112	112
648	Magnet	648	648	648
653	Burgundy	653	106	106
670	Creamy Beige	670	031	356
680	Skyline	680	591	591
724	Almond	724	004	004
771	Mercury	771	026	026
778	Ice	778	778	778
904	Lamplight	904	031	031
963	Stucco	963	026	963
983	Gray Haze	983	026	026
Metallics				
034	Aluminum	034	026	026
121	Brushed Aluminum	034	026	026
126	Ash Metallic	126	126	126
737	Silver	737	026	114
741	Polished Aluminum	034	026	026
Pearltones				
326	Alabaster Pearl	112	112	112
327	Fawn Pearl	031	031	031
328	Beige Pearl	011	103	011
637	White Pearl	205	005	005



Horizontal Blinds

2" Designer Vinyl – Solid Color Crown

Features

- SureClose® headrail for optimum closure
- Non-lead vinyl formulation
- Neutral street side appearance
- White vinyl bottomrail
- Color-coordinated componentry
- All styles coordinate with Graber vinyl vertical blinds
- Cord tilt standard, wand tilt optional
- 2" slat valance (other options available)
- Limited lifetime warranty on headrail and components;
3-year warranty on slats

Colors

Alabaster 3112	Mullen 3009
Carob 3005	Putty 3067
Copper 3442	Satin White 3075
Fern 3101	Tan 3093
Ivory 3325	Whisper 3248
Misty Gray 3050	White 3205
Misty White 3232	White Clover 3010

See page 34 for Color Coordination Chart.

Options

- Cord tilt standard No Charge
- Wand tilt optional No Charge
- Control locations No Charge
- Hold-down brackets (upon request) No Charge
- Projection brackets: 2³/₄" No Charge
4³/₄" No Charge
- Valance returns standard with outside mounts . . No Charge
(Available upon request for inside projection mounts)

Retail Surcharges:

- Cut-outs \$67
- Two blinds on one headrail \$47
- Three blinds on one headrail \$65

Optional Cloth Tapes

1 ¹ / ₂ " Cloth Tape option See price chart	
Beige 2011	Navy 2369
Black 2033	Pecan 2403
Chocolate 2353	Taupe 2659
Cocoa 2297	Toffee 2296
Duck White 2136	Wheat 2710
Light Beige 2137	White 2005
Maroon 2360	White Smoke 2617
Moss 2500	
1" Cloth Tape option See price chart	
Black 1033	Duck White 1136
Cocoa 1297	White Smoke 1617

Horizontal Blinds



2" Designer Vinyl – Solid Color Crown

HEIGHT UP TO ↓	WIDTH UP TO →																		
	12"	23"	26"	29"	32"	36"	40"	44"	48"	52"	57"	62"	67"	72"	82"	92"	102"	112"	120"
42"	\$105	90	96	103	112	125	136	148	155	163	185	196	212	221	253	278	313	346	377
48"	111	96	103	114	123	139	150	159	169	181	205	217	233	247	278	309	346	378	413
54"	118	103	114	123	129	150	159	173	182	196	218	239	253	267	302	334	377	413	448
60"	130	114	123	129	140	159	173	185	196	212	239	255	273	289	324	358	409	448	487
66"	137	119	129	140	152	169	185	196	214	229	259	274	294	313	353	387	440	481	526
72"	144	127	139	152	161	182	196	212	229	243	274	298	313	334	377	414	471	516	561
78"	151	136	150	159	173	194	210	229	243	262	294	313	334	353	401	443	496	543	592
84"	160	144	155	169	182	205	218	243	259	274	310	332	353	377	425	471	528	578	629
90"	168	152	163	178	194	214	239	253	273	289	324	353	373	401	451	496	560	615	671
96"	174	159	173	188	205	229	247	267	286	309	346	369	394	419	476	526	589	646	701
102"	182	167	182	196	212	239	262	278	302	322	364	388	414	443	501	556	617	678	739
108"	191	173	188	208	221	249	273	298	318	339	378	409	440	459	526	582	651	715	776

SURCHARGE: VALANCE OPTION

Double Valance	\$3	3	3	3	3	3	4	4	4	4	4	6	6	6	6	6	6	8	10
----------------	-----	---	---	---	---	---	---	---	---	---	---	---	---	---	---	---	---	---	----

NOTE: Smallest width available 9" exact. Widths from 9" to 11⁵/₁₆" are center tilt only.

Multiple Blinds on One Headrail
Blinds less 84":
Add surcharge:
\$47 two on one headrail
\$65 three on one headrail

Multiple Blinds on One Headrail
Blind widths 84" to 120":
No charge

2" Designer Vinyl – Solid Color Crown with Cloth Tapes

HEIGHT UP TO ↓	WIDTH UP TO →																		
	12"	23"	26"	29"	32"	36"	40"	44"	48"	52"	57"	62"	67"	72"	82"	92"	102"	112"	120"
42"	\$121	104	110	118	129	144	156	170	178	187	213	225	244	254	291	320	360	398	434
48"	128	110	118	131	141	160	173	183	194	208	236	250	268	284	320	355	398	435	475
54"	136	118	131	141	148	173	183	199	209	225	251	275	291	307	347	384	434	475	515
60"	150	131	141	148	161	183	199	213	225	244	275	293	314	332	373	412	470	515	560
66"	158	137	148	161	175	194	213	225	246	263	298	315	338	360	406	445	506	553	605
72"	166	146	160	175	185	209	225	244	263	279	315	343	360	384	434	476	542	593	645
78"	174	156	173	183	199	223	242	263	279	301	338	360	384	406	461	509	570	624	681
84"	184	166	178	194	209	236	251	279	298	315	357	382	406	434	489	542	607	665	723
90"	193	175	187	205	223	246	275	291	314	332	373	406	429	461	519	570	644	707	772
96"	200	183	199	216	236	263	284	307	329	355	398	424	453	482	547	605	677	743	806
102"	209	192	209	225	244	275	301	320	347	370	419	446	476	509	576	639	710	780	850
108"	220	199	216	239	254	286	314	343	366	390	435	470	506	528	605	669	749	822	892

SURCHARGE: VALANCE OPTION

Double Valance	\$3	3	3	3	3	3	4	4	4	4	4	6	6	6	6	6	6	8	10
----------------	-----	---	---	---	---	---	---	---	---	---	---	---	---	---	---	---	---	---	----

NOTE: Smallest width available 9" exact. Widths from 9" to 11⁵/₁₆" are center tilt only.

Multiple Blinds on One Headrail
Blinds less than 84":
Add surcharge:
\$47 two on one headrail
\$65 three on one headrail

Multiple Blinds on One Headrail
Blind widths 84" to 120":
No charge



2" Designer Vinyl Valances

Valance Options

Standard Valance

Adds the finishing touch to your blinds. No charge.



Double Valance

Provides better headrail coverage and a more upscale look. Available on 2" Designer Vinyl only as a surcharge option.



Pricing for Replacement Valances

Solid Color Crown Valance

Width →	12"	23"	26"	29"	32"	36"	40"	44"	48"	52"	57"	62"	67"	72"	82"	92"	102"	112"	120"
Standard	\$18	18	18	18	18	20	20	20	20	23	24	24	29	29	32	35	40	43	43
Double Valance	18	18	18	20	20	20	20	23	23	23	29	29	32	32	35	36	46	46	49

Valances for 2" Designer Vinyl

If requested, valances are supplied with your order in one of the following styles depending on how your blind will be mounted. For a more custom look, the valance and returns may be special ordered to your measurements.

NOTE: Valances with returns are measured and cut from the **INSIDE** of the miter to ensure the most accurate fit when installed over the headrail or window frame.

Blinds ordered as an Outside Mount will be supplied with returns sized to cover the end of the blind back to the mounting surface. If projection brackets are requested when the blind is ordered, longer returns will be sent automatically. Outside mount blinds are available without returns upon request. Blinds ordered as an Inside Mount are supplied without returns and look best when the blind and valance can be completely recessed because the ends of the valance are straight cut. Returns are available if requested at the time of order for inside mount blinds that are not completely recessed.

NOTE: Minimum return length is 1".

Additional ordering information:

- Please state at the time of order if the valance and return measurements are for the exact size required so that no additions or deductions are made.
- Valance projection is different if the blind has a wand tilter or cord tilter. Please refer to the following specifications chart for more information.

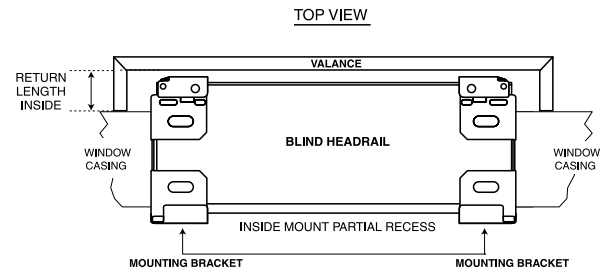
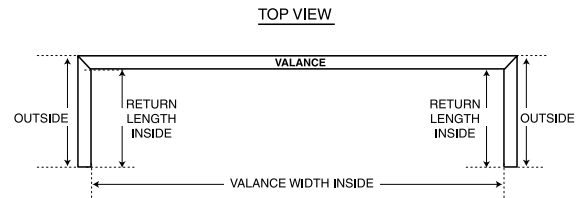

Valance Ordering Information

Blind Type	Valance Style	Tilter Type	Return Length	Full Recess Depth
2" Designer Vinyl	Standard	All	3 ⁵ / ₁₆ "	3 ⁵ / ₁₆ "
2" Designer Vinyl	Double	All	3 ¹⁵ / ₁₆ "	4"

Additional information: All measurements listed above are to the inside.

Valance Size Limits

Slat Size/Style	Inside Mount	Outside Mount
2" Designer Vinyl	120" FBW	120" FBW

FBW = Finished blind width

Please note: Continuous valances wider than sizes shown above will be two or more sections spliced together.

1. Full recess is from front of valance to wall.
2. Return length is from inside miter to wall.
3. Partial recess – subtract actual window recess from return length to arrive at exact return length.



2" Designer Vinyl

Color Coordination Chart

Color No.	Color Name	Standard Blinds		
		Rail & Brackets	Ladders & Cords	Tassels
Crown				
3112	Alabaster	112	112	112
3005	Carob	670	026	026
3442	Copper	670	011	688
3101	Fern	724	031	004
3325	Ivory	112	112	112
3050	Misty Gray	823	026	823
3232	Misty White	386	005	005
3009	Mullen	112	112	112
3067	Putty	670	031	031
3075	Satin White	386	005	005
3093	Tan	670	031	031
3248	Whisper	205	005	005
3205	White	205	005	005
3010	White Clover	112	112	112