

Use & Care Guide

Over the Range Microwave Oven

Guía de Uso y Cuidado

Horno microondas sobre la estufa

Mode d'emploi et d'entretien

Four à micro-ondes au dessus de la cuisinière



 **Electrolux**

Please read and save this guide

Thank you for choosing **Electrolux**, the new premium brand in home appliances. This Use & Care Guide is part of our commitment to customer satisfaction and product quality throughout the service life of your new appliance.

We view your purchase as the beginning of a relationship. To ensure our ability to continue serving you, please use this page to record important product information.

Keep a record for quick reference

Purchase date

Electrolux model number

Electrolux serial number (see picture for location)

NOTE

Registering your product with Electrolux enhances our ability to serve you. You can register online at www.electroluxappliances.com or by dropping your Product Registration Card in the mail.

Questions?

For toll-free telephone support in the U.S. and Canada:
1-877-4ELECTROLUX (1-877-435-3287)

For online support and Internet production information visit <http://www.electroluxappliances.com>

PRECAUTIONS TO AVOID POSSIBLE EXPOSURE TO EXCESSIVE MICROWAVE ENERGY

- (a) Do not attempt to operate this oven with the door open since open-door operation can result in harmful exposure to microwave energy. It is important not to defeat or tamper with the safety interlocks.
- (b) Do not place any object between the oven front face and the door or allow soil or cleaner residue to accumulate on sealing surfaces.
- (c) Do not operate the oven if it is damaged. It is particularly important that the oven door close properly and that there is no damage to the: (1) door (bent), (2) hinges and latches (broken or loosened), (3) door seals and sealing surfaces.
- (d) The oven should not be adjusted or repaired by anyone except properly qualified service personnel.

FINDING INFORMATION	2	Baked Potato chart	19
PRECAUTIONS TO AVOID POSSIBLE EXPOSURE TO EXCESSIVE MICROWAVE ENERGY	2	Sensor Reheat chart	19
TABLE OF CONTENTS	3	AUTO MODES	20-26
IMPORTANT SAFETY INSTRUCTIONS	4	Auto Cook	20
UNPACKING AND EXAMING YOUR OVEN	5	Auto Cook chart	20
GROUNDING INSTRUCTIONS	6	Dinner recipes	21
INFORMATION YOU NEED TO KNOW	7-10	Keep Warm.....	22
About Your Oven	7	Melt, Soften.....	23
About Microwave Cooking.....	7	Melt, Soften chart.....	23
About Safety	8	Snacks	24
About Children and the Microwave.....	8	Snacks chart	24
About Food	9	Auto Reheat	25
About Utensils and Coverings	10	Auto Reheat chart	25
PART NAMES	11	Auto Defrost	26
CONTROL PANEL	12	Auto Defrost chart	26
BEFORE OPERATING	13	CONVENIENT FEATURES	27-29
To Set the Clock.....	13	User Pref	27
Stop/Clear	13	Multiple Sequence Cooking.....	28
MANUAL OPERATION	14-15	More or Less Time Adjustment	28
Time Cooking	14	Add 30 Seconds	28
To Set Power Level	14	Help.....	29
Using the Rack.....	14	Timer	29
Manual Defrost.....	15	Turntable ON/OFF.....	29
SENSOR MODES	15-19	Quick Start	29
Sensor Cook	16	Demonstration Mode	29
Sensor Cook chart	17	Light	29
Popcorn/Fresh Veggies/Frozen Veggies/ Baked Potato/Sensor Reheat	18	Fan	29
Popcorn chart	18	CLEANING AND CARE	30-31
Fresh Veggies chart	19	SERVICE CALL CHECK	32
Frozen Veggies chart	19	SPECIFICATIONS	33
		WARRANTY INFORMATIONS	34

IMPORTANT SAFETY INSTRUCTIONS

When using electrical appliances basic safety precautions should be followed, including the following:



WARNING

To reduce the risk of burns, electric shock, fire, injury to persons or exposure to excessive microwave energy:

1. **Read all instructions before using the appliance.**
2. Read and follow the specific “**PRECAUTIONS TO AVOID POSSIBLE EXPOSURE TO EXCESSIVE MICROWAVE ENERGY**” on page 2.
3. This appliance must be grounded. Connect only to properly grounded outlet. See “Grounding Instructions” on page 6.
4. Install or locate this appliance only in accordance with the provided installation instructions.
5. Some products such as whole eggs and sealed containers—for example, closed glass jars—are able to explode and should not be heated in this oven.
6. Use this appliance only for its intended use as described in this manual. Do not use corrosive chemicals or vapors in this appliance. This type of oven is specifically designed to heat, cook or dry food. It is not designed for industrial or laboratory use.
7. As with any appliance, close supervision is necessary when used by children.
8. Do not operate this appliance if it has a damaged cord or plug, if it is not working properly or if it has been damaged or dropped.
9. This appliance should be serviced only by qualified service personnel. Contact nearest Electrolux Authorized Servicer for examination, repair or adjustment.
10. Do not cover or block any openings on the appliance.
11. Do not store or use this appliance outdoors. Do not use this product near water—for example, near a kitchen sink, in a wet basement, near a swimming pool, or similar locations.
12. Do not immerse cord or plug in water.
13. Keep cord away from heated surfaces.
14. Do not let cord hang over edge of table or counter.
15. See door surface cleaning instructions on page 30 - 31.
16. Do not mount over a sink.
17. Do not store anything directly on top of the appliance surface when the appliance is in operation.
18. To reduce the risk of fire in the oven cavity:
 - a. **Do not overcook food. Carefully attend to appliance when paper, plastic or other combustible materials are placed inside the oven to facilitate cooking.**
 - b. Remove wire twist-ties from paper or plastic bags before placing bag in oven.
 - c. **If materials inside the oven ignite, keep oven door closed, turn oven off and disconnect the power cord or shut off power at the fuse or circuit breaker panel.**
 - d. Do not use the cavity for storage purposes. Do not leave paper products, cooking utensils or food in the cavity when not in use.
19. Liquids, such as water, coffee or tea are able to be overheated beyond the boiling point without appearing to be boiling. Visible bubbling or boiling when the container is removed from the Microwave Oven is not always present. **THIS COULD RESULT IN VERY HOT LIQUIDS SUDDENLY BOILING OVER WHEN A SPOON OR OTHER UTENSIL IS INSERTED INTO THE LIQUID.**

To reduce the risk of injury to persons:

 - a. Do not overheat the liquid.
 - b. Stir the liquid both before and halfway through heating it.
 - c. Do not use straight-sided containers with narrow necks. Use a wide-mouthed container.
 - d. After heating, allow the container to stand in the Microwave Oven at least for 20 seconds before removing the container.
 - e. Use extreme care when inserting a spoon or other utensil into the container.
20. Clean ventilation openings and grease filters frequently—grease should not be allowed to accumulate on ventilation openings, louver or grease filters.
21. Use care when cleaning the louver and the grease filters. Corrosive cleaning agents, such as lye-based oven cleaners, may damage the louver and the grease filters.
22. When flaming food under the hood, turn the fan on.
23. This appliance is suitable for use above both gas and electric cooking equipment 36” wide or less.

SAVE THESE INSTRUCTIONS

Open the bottom of the carton, bend the carton flaps back and tilt the oven over to rest on plasticfoam pad. Lift carton off oven and remove all packing materials, WALL and TOP CABINET TEMPLATES. SAVE THE CARTON AS IT MAY MAKE INSTALLATION EASIER.

1. Remove the feature sticker from the outside of the door, if there is one.
2. Check to see that there is a WALL TEMPLATE and TOP CABINET TEMPLATE. Read enclosures and SAVE the Use and Care Guide.

Check the oven for any damage, such as misaligned or bent door, damaged door seals and sealing surfaces, broken or loose door hinges and latches and dents inside the cavity or on the door. If there is any damage, do not operate the oven and contact your dealer or ELECTROLUX AUTHORIZED SERVICER. See Installation Instructions for more details.

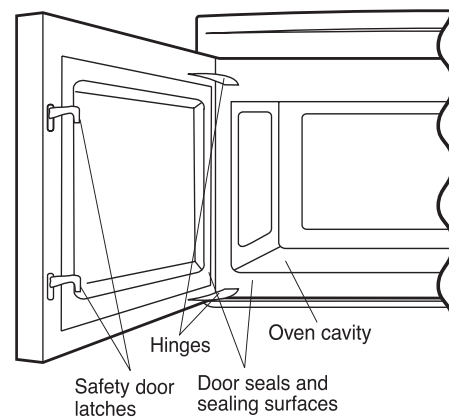

6 GROUNDING INSTRUCTIONS

This appliance must be grounded. This oven is equipped with a cord having a grounding wire with a grounding plug. It must be plugged into a wall receptacle that is properly installed and grounded in accordance with the National Electrical Code and local codes and ordinances. In the event of an electrical short circuit, grounding reduces risk of electric shock by providing an escape wire for the electric current.



WARNING

Improper use of the grounding plug can result in a risk of electric shock.

Electrical Requirements

The oven is equipped with a 3-prong grounding plug. **DO NOT UNDER ANY CIRCUMSTANCES CUT OR REMOVE THE GROUNDING PIN FROM THE PLUG.**

DO NOT USE AN EXTENSION CORD.

If the power supply cord is too short, have a qualified electrician or serviceman install an outlet near the appliance.

The Power Supply Cord and plug must be connected to a separate 120 Volt AC, 60 Hz, 15 Amp, or more branch circuit, single grounded receptacle. The receptacle should be located inside the cabinet directly above the Microwave Oven mounting location as shown in Figure 1.

NOTES:

1. If you have any questions about the grounding or electrical instructions, consult a qualified electrician or service person.
2. Neither Electrolux nor the dealer can accept any liability for damage to the oven or personal injury resulting from failure to observe the correct electrical connection procedures.

Radio or TV Interference

Should there be any interference caused by the microwave oven to your radio or TV, check that the microwave oven is on a different electrical circuit, relocate the radio or TV as far away from the oven as feasible or check position and signal of receiving antenna.

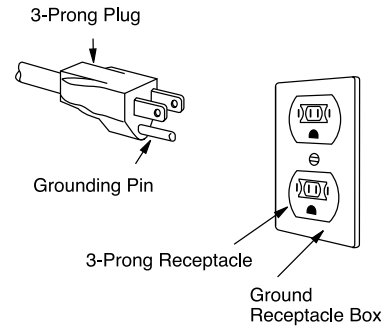
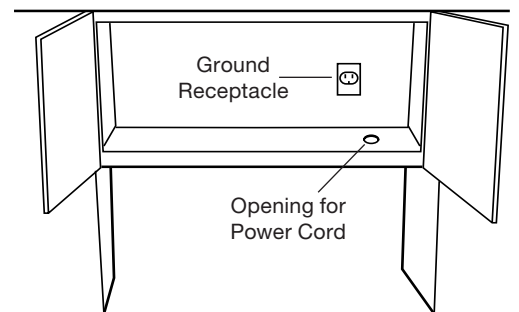

Figure 1



About Your Oven

This Use and Care Guide is valuable: read it carefully and always save it for reference.

NEVER use the oven without the turntable and support nor turn the turntable over so that a large dish could be placed in the oven. The turntable will turn both clockwise and counterclockwise.

ALWAYS have food in the Microwave Oven when it is on to absorb the microwave energy.

When using the oven at power levels below 100%, you may hear the magnetron cycling on and off. It is normal for the exterior of the oven to be warm to the touch when cooking or reheating.

Condensation is a normal part of microwave cooking. Room humidity and the moisture in food will influence the amount of moisture that condenses in the oven. Generally, covered foods will not cause as much condensation as uncovered ones. Ventilation openings must not be blocked.

The Microwave Oven is for food preparation only. It should not be used to dry clothes or newspapers.

Your Microwave Oven is rated 1000 watts by using the IEC Test Procedure. In using recipes or package directions, check food a minute or two before the minimum time and add time accordingly.

About Microwave Cooking

- Arrange food carefully. Place thickest areas towards outside of dish.
- Watch cooking time. Cook for the shortest amount of time indicated and add more as needed. Food severely overcooked can smoke or ignite.
- Cover foods while cooking. Check recipe or cookbook for suggestions: paper towels, wax paper, microwave plastic wrap or a lid. Covers prevent spattering and help foods to cook evenly.
- Shield with small flat pieces of aluminum foil any thin areas of meat or poultry to prevent overcooking before dense, thick areas are cooked thoroughly.
- Stir foods from outside to center of dish once or twice during cooking, if possible.
- Turn foods over once during microwaving to speed cooking of such foods as chicken and hamburgers. Large items like roasts must be turned over at least once.
- Rearrange foods such as meatballs halfway through cooking both from top to bottom and from the center of the dish to the outside.
- Add standing time. Remove food from oven and stir, if possible. Cover for standing time which allows the food to finish cooking without overcooking.
- Check for doneness. Look for signs indicating that cooking temperatures have been reached.
Doneness signs include:
 - Food steams throughout, not just at edge.
 - Center bottom of dish is very hot to the touch.
 - Poultry thigh joints move easily.
 - Meat and poultry show no pinkness.
 - Fish is opaque and flakes easily with a fork.

About Safety

- Check foods to see that they are cooked to the United States Department of Agriculture's recommended temperatures.

Temp	Food
145°F (63°C)	For beef, lamb or veal cut into steaks, chops or roasts MEDIUM RARE
160°F (71°C)	For fresh pork, ground meat, fish, seafood, egg dishes, frozen prepared food and beef, lamb or veal cut into steaks, chops or roasts cooked to MEDIUM
165°F (74°C)	For leftover, ready-to-reheat refrigerated, deli and carry out "fresh" food, whole chicken or turkey, chicken or turkey breasts and ground poultry used in chicken or turkey burgers, boneless white poultry. NOTE: Do not cook whole, stuffed poultry. Cook stuffing separately to 165°F.

To test for doneness, insert a meat thermometer in a thick or dense area away from fat or bone. NEVER leave the thermometer in the food during cooking, unless it is approved for microwave use.

- ALWAYS use potholders to prevent burns when handling utensils that are in contact with hot food. Enough heat from the food can transfer through utensils to cause skin burns.
- Avoid steam burns by directing steam away from the face and hands. Slowly lift the farthest edge of a dish's covering and carefully open popcorn and oven cooking bags away from the face.
- Stay near the oven while it's in use and check cooking progress frequently so that there is no chance of overcooking food.
- NEVER use the cavity for storing cookbooks or other items.
- Select, store and handle food carefully to preserve its high quality and minimize the spread of foodborne bacteria.
- Keep waveguide cover clean. Food residue can cause arcing and/or fires.
- Use care when removing items from the oven so that the utensil, your clothes or accessories do not touch the safety door latches.
- Keep aluminum foil used for shielding at least 1 inch away from walls, ceiling and door.

About Children and the Microwave

Children below the age of 7 should use the microwave oven with a supervising person very near to them. Between the ages of 7 and 12, the supervising person should be in the same room.

The child must be able to reach the oven comfortably; if not, he/she should stand on a sturdy stool.

At no time should anyone be allowed to lean or swing on the oven door.

Children should be taught all safety precautions: use potholders, remove coverings carefully, pay special attention to packages that crisp food because they may be extra hot.

Don't assume that because a child has mastered one cooking skill he/she can cook everything.

Children need to learn that the microwave oven is not a toy. See page 27 for Child Lock feature.

About Food

Food	Do	Don't
Eggs, sausages, nuts, seeds, fruits & vegetables	<ul style="list-style-type: none"> • Puncture egg yolks before cooking to prevent “explosion”. • Pierce skins of potatoes, apples, squash, hot dogs and sausages so that steam escapes. 	<ul style="list-style-type: none"> • Cook eggs in shells. • Reheat whole eggs. • Dry nuts or seeds in shells.
Popcorn	<ul style="list-style-type: none"> • Use specially bagged popcorn for microwave cooking. • Listen while popping corn for the popping to slow to 1 or 2 seconds or use special popcorn pad. 	<ul style="list-style-type: none"> • Pop popcorn in regular brown bags or glass bowls. • Exceed maximum time on popcorn package.
Baby food	<ul style="list-style-type: none"> • Transfer baby food to small dish and heat carefully, stirring often. Check temperature before serving. • Put nipples on bottles after heating and shake thoroughly. “Wrist” test before feeding. 	<ul style="list-style-type: none"> • Heat disposable bottles. • Heat bottles with nipples on. • Heat baby food in original jars.
General	<ul style="list-style-type: none"> • Cut baked goods with filling after heating to release steam and avoid burns. • Stir liquids briskly before and after heating to avoid “eruption”. • Use deep bowl, when cooking liquids or cereals, to prevent boilovers. 	<ul style="list-style-type: none"> • Heat or cook in closed glass jars or air tight containers. • Can in the microwave as harmful bacteria may not be destroyed. • Deep fat fry. • Dry wood, gourds, herbs or wet papers.

About Utensils and Coverings

It is not necessary to buy all new cookware. Many pieces already in your kitchen can be used successfully in your new Over the Range Microwave Oven. Make sure the utensil does not touch the interior walls during cooking.

Use these utensils for safe microwave cooking and reheating:

- glass ceramic (Pyroceram®), such as Corningware®.
- heat-resistant glass (Pyrex®)
- microwave-safe plastics
- paper plates
- microwave-safe pottery, stoneware and porcelain
- browning dish (Do not exceed recommended preheating time. Follow manufacturer's directions.)

These items can be used for short time reheating of foods that have little fat or sugar in them:

- wood, straw, wicker

DO NOT USE

- metal pans and bakeware
- dishes with metallic trim
- non-heat-resistant glass
- non-microwave-safe plastics (margarine tubs)
- recycled paper products
- brown paper bags
- food storage bags
- metal twist-ties

Should you wish to check if a dish is safe for microwaving, place the empty dish in the oven and microwave on HIGH for 30 seconds. A dish which becomes very hot should not be used.

The following coverings are ideal:

- Paper towels are good for covering foods for reheating and absorbing fat while cooking bacon.
- Wax paper can be used for cooking and reheating.
- Plastic wrap that is specially marked for microwave use can be used for cooking and reheating. DO NOT allow plastic wrap to touch food. Vent so steam can escape.
- Lids that are microwave-safe are a good choice because heat is kept near the food to hasten cooking.
- Oven cooking bags are good for large meats or foods that need tenderizing. DO NOT use metal twist ties. Remember to slit bag so steam can escape.

How to use aluminum foil in your Over the Range Microwave Oven:

- Small flat pieces of aluminum foil placed smoothly on the food can be used to shield areas that are either defrosting or cooking too quickly.
- Foil should not come closer than one inch to any surface of the oven.

Should you have questions about utensils or coverings, check a good microwave cookbook or follow recipe suggestions.

Accessories

There are many microwave accessories available for purchase. Evaluate carefully before you purchase so that they meet your needs. A microwave-safe thermometer will assist you in determining correct doneness and assure you that foods have been cooked to safe temperatures. Electrolux is not responsible for any damage to the oven when accessories are used.

FRONT VIEW

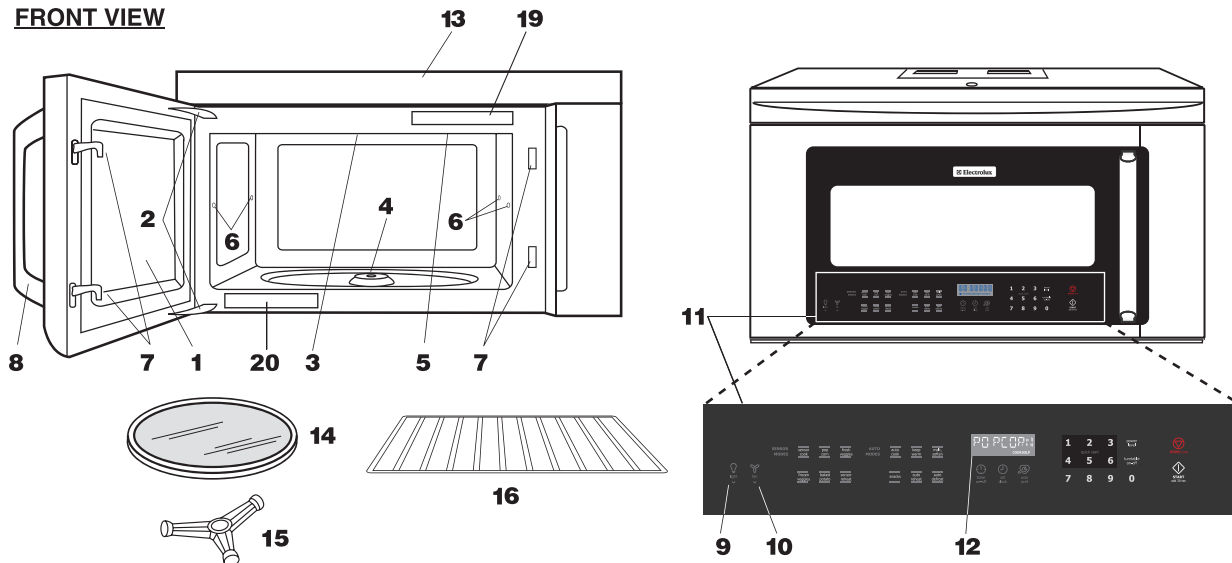

BOTTOM VIEW

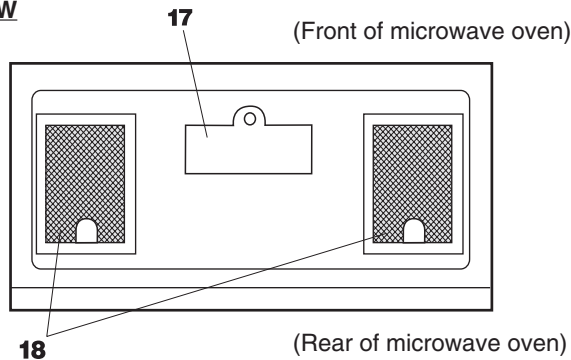

- | | |
|---|--|
| <p>1 Microwave oven door with see-through window</p> <p>2 Door hinges</p> <p>3 Waveguide cover:
DO NOT REMOVE.</p> <p>4 Turntable motor shaft</p> <p>5 Microwave oven light
It will light when microwave oven is operating or door is open.</p> <p>6 Rack holders</p> <p>7 Safety door latches
The microwave oven will not operate unless the door is securely closed.</p> <p>8 Handle</p> <p>9 Light pad
Touch the light pad once for high, twice for medium, three times for low and four times to turn off the light.</p> <p>10 Fan pad
Touch the fan pad once for high speed, twice for medium speed, three times for low speed and four times to turn off the fan.</p> | <p>11 Auto-Touch control panel</p> <p>12 Time display: Digital display, 99 minutes, 99 seconds</p> <p>13 Ventilation openings</p> <p>14 Removable turntable
The turntable will rotate clockwise or counter-clockwise. Only remove for cleaning.</p> <p>15 Removable turntable support
First, carefully place the turntable support in the motor shaft in the center of the microwave oven floor. Then, place the turntable on the turntable support securely.</p> <p>16 Rack for 2-level cooking/ reheating</p> <p>17 Light cover</p> <p>18 Grease filters</p> <p>19 Menu label</p> <p>20 Rating label (model and serial number)</p> |
|---|--|

Words in the lower portion of the display will light to indicate what function is in progress.

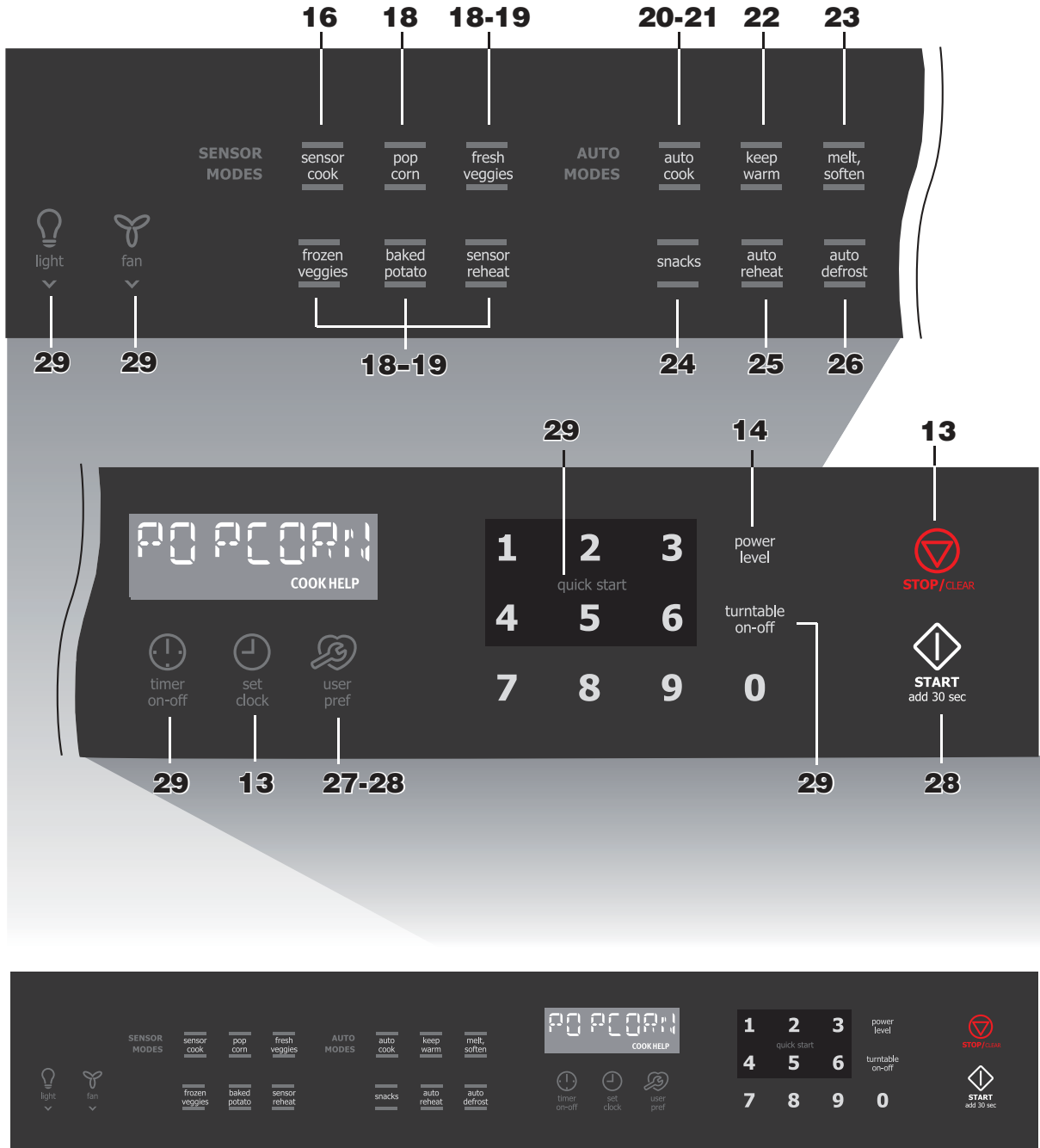



Number next to the control panel illustration indicates pages on which there are feature descriptions and usage information.

- Before operating your new oven make sure you read and understand this Use and Care Guide completely.
- Before the Over the Range Microwave Oven can be used, follow these procedures:
 1. Plug in the oven. Close the door. The oven display will show *ENJOY YOUR OVEN TOUCH CLEAR AND TOUCH CLOCK*.
 2. Touch the **STOP/CLEAR** pad. will appear.
 3. Set clock. See below.

To Set the Clock

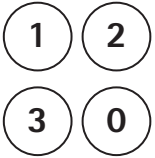
- Suppose you want to enter the correct time of day 12:30 (A.M or P.M.).

Procedure	
Step	Touch
1. Touch the set clock pad.	
2. Enter the correct time of day by touching the numbers in sequence.	
3. Touch the set clock pad again.	

This is a 12 hour clock. If you attempt to enter an incorrect clock time, *ERROR* will appear in the display. Touch the **STOP/CLEAR** pad and re-set the clock.

- If the electrical power supply to your microwave oven should be interrupted, the display will intermittently show after the power is reinstated. If this occurs during cooking, the program will be erased. The time of day will also be erased. Simply touch **STOP/CLEAR** pad and reset the clock for the correct time of day.

NOTE

Your Over the Range Microwave Oven can be programmed with the door open except for **START add 30 sec, popcorn, fresh veggies, frozen veggies, baked potato and sensor reheat.**

Stop/Clear



Touch the **STOP/CLEAR** to:

1. Erase if you make a mistake during programming.
2. Cancel timer.
3. Stop the oven temporarily during cooking.
4. Return the time of day to the display.
5. Cancel a program during cooking, touch twice.



Time Cooking

Your Over the Range Microwave Oven can be programmed for 99 minutes 99 seconds (99.99). Always enter the seconds after the minutes, even if they are both zeros.

- Suppose you want to cook for 5 minutes at 100%.

Procedure	
Step	Touch
1. Enter cooking time.	
2. Touch the START add 30 sec pad.	

- Suppose you want to defrost for 5 minutes at 30%.

Procedure	
Step	Touch
1. Enter defrosting time.	
2. Touch the power level pad eight times to enter a power level of 30%.	
3. Touch the START add 30 sec pad.	

When the defrost time is complete, cooking completion signal will sound and END will appear in the display.

To Set Power Level

There are eleven preset power levels. Using lower power levels increases the cooking time which is recommended for foods such as cheese, milk and long slow cooking of meats. Consult cookbook or recipes for specific recommendations.

Touch power level pad number of times for desired power	Approx. Percentage of power	Common words for power levels
power level x 1	100%	High
power level x 2	90%	
power level x 3	80%	
power level x 4	70%	Medium High
power level x 5	60%	
power level x 6	50%	Medium
power level x 7	40%	
power level x 8	30%	Med Low/Defrost
power level x 9	20%	
power level x 10	10%	Low
power level x 11	0%	

Using the Rack

The rack allows several foods to be cooked or reheated at one time. However, for the best cooking and reheating, use Turntable ON function and cook with SENSOR MODES or AUTO MODES without the rack. When the rack is used, set time and power level manually. Allow plenty of space around and between the dishes. Pay close attention to the cooking and reheating progress. Reposition the foods and reverse them from the rack to turntable and/or stir them at least once during any cooking or reheating time. After cooking or reheating, stir if possible. Using a lower power level will assist in better cooking and reheating uniformity.

Avoid:

- Storing the rack in the microwave oven when not in use.
- Popping popcorn with the rack in the microwave oven.
- Using any browning dish on the rack.
- Using SENSOR MODES and AUTO MODES with the rack.
- Cooking directly on the rack—use microwave-safe cookware.

NOTE

Turntable ON/OFF function can be used in Manual Operation. See page 29.

Manual Defrost

If the food that you wish to defrost is not listed on the Defrost chart or is above or below the limits in the Amount column on the Defrost chart (see page 26), you need to defrost manually.

You can defrost any frozen food, either raw or previously cooked, by using Power Level for 30%. Follow the exact 3-step procedure found under To set power level. Estimate defrosting time and touch **power level** pad eight times for 30% power.

For either raw or previously cooked frozen food the rule of thumb is approximately 4 minutes per pound.

For example, defrost 4 minutes for 1 pound of frozen spaghetti sauce.

Always stop the oven periodically to remove or separate the portions that are defrosted. If food is not defrosted at the end of the estimated defrosting time, program the oven in 1 minute increments on power level 30% until totally defrosted.

When using plastic containers from the freezer, defrost only long enough to remove from the plastic in order to place in a microwave-safe dish.

SENSOR MODES

The sensor is a semi-conductor device that detects the vapor (moisture and humidity) emitted from the food as it heats. The sensor adjusts the cooking times and power level for various foods and quantities.

Using Sensor Settings:

1. After oven is plugged in, wait 2 minutes before using Sensor Settings.
2. Be sure the exterior of the cooking container and the interior of the oven are dry. Wipe off any moisture with a dry cloth or paper towel.
3. The oven works with foods at normal storage temperature. For example, popcorn would be at room temperature.
4. Any Sensor Settings selection can be programmed with More or Less Time Adjustment. See page 28.
5. More or less food than the quantity listed in the chart should be cooked following the guidelines in any microwave cookbook.
6. During the first part of SENSOR MODES, food name will appear on the display. Do not open the oven door or touch **STOP/CLEAR** during this part of the cycle. The measurement of vapor will be interrupted. If this occurs, an error message will appear. To continue cooking, touch the **STOP/CLEAR** pad and cook manually.

When the sensor detects the vapor emitted from the food, remainder of cooking time will appear. Door may be opened when remaining cooking

time appears on the display. At this time, you may stir or season food, as desired.

7. If the sensor does not detect vapor properly when popping popcorn, the oven will turn off, and the correct time of day will be displayed. If the sensor does not detect vapor properly when cooking other foods, *ERROR* will be displayed, and the oven will turn off.
8. Check food for temperature after cooking. If additional time is needed, continue to cook manually.
9. Each food has a cooking hint. Touch **user pref** pad when the *HELP* indicator is lighted in the display.

Covering Foods:

Some foods cook better when covered. Use the cover recommended in the food charts.

1. Casserole lid.
2. Plastic wrap: Use plastic wrap recommended for microwave cooking. Cover dish loosely; allow approximately 1/2 inch to remain uncovered to allow steam to escape. Plastic wrap should not touch food.
3. Wax paper: Cover dish completely; fold excess wrap under dish to secure. If dish is wider than paper, overlap two pieces at least one inch to cover.

Be careful when removing any covering to allow steam to escape away from you.

SENSOR MODES has 6 functions, such as Sensor Cook, popcorn, fresh veggies, frozen veggies, baked potato and sensor reheat.

NOTES

1. SENSOR MODES can be programmed with More or Less Time Adjustment. Touch the **power level** pad once or twice before cooking is started. See page 28.
2. Each food has a cooking hint. Touch the **user pref** pad when the *HELP* indicator is lighted in the display.
3. Should you attempt to enter more or less than the allowed amount, an error message will appear in the display.
More or less than the quantity listed in the chart should be cooked following the guidelines in any microwave cookbook.
4. The final cooking result will vary according to the food condition (e.g. initial temperature, shape, quality). Check food for temperature after cooking. If additional time is needed, continue to cook manually.
5. When sensor detects the vapor emitted from the foods, manipulation message or remaining cooking time will be displayed.
6. Stay near the oven while it's in use and check cooking progress frequently so that there is no chance of overcooking food.



Sensor Cook

There are 5 foods (frozen entrees, ground meat, rice, flash/seafood, and chicken breast) under the SENSOR COOK that uses the sensor.

You can cook many foods by touching the **sensor cook** pad and the food number. You don't need to calculate cooking time or power level.

- Suppose you want to cook Frozen Entrees.

Procedure

Step	Touch
1. Touch the sensor cook pad, number 1 for Frozen Entrees.	 
2. At end, follow the directions in the display.	
3. Touch the START add 30 sec pad.	

Sensor Cook chart

Food	Amount	Procedure															
1. Frozen Entrees*	6 - 17 oz 170 - 480 g	Use this pad for frozen, convenience foods. It will give satisfactory results for most brands. You may wish to try several and choose your favorite. Remove package from outer wrapping and follow package directions for covering. After cooking, let stand, covered for 1 to 3 minutes.															
2. Ground Meat*	0.25 - 2.0 lb 0.2 - 0.9 kg	Use this setting to cook ground beef or turkey as patties or in a casserole to be added to other ingredients. Place patties on a microwave-safe rack and cover with wax paper. Place ground meat in a casserole and cover with wax paper or plastic wrap. When oven stops, turn patties over or stir meat in casserole to break up large pieces. Re-cover and touch the START add 30 sec pad. After cooking, let stand, covered, for 2 to 3 minutes.															
3. Rice*	0.5 - 2.0 cups	Place rice into a deep casserole dish and add double quantity of water. Cover with lid or plastic wrap. After cooking, stir, cover and let stand 3 to 5 minutes or until all liquid has been absorbed. <table border="1" style="margin-left: auto; margin-right: auto;"> <thead> <tr> <th>Rice</th> <th>Water</th> <th>Size of casserole dish</th> </tr> </thead> <tbody> <tr> <td>.5 cup</td> <td>1 cup</td> <td>1.5 quart</td> </tr> <tr> <td>1 cup</td> <td>2 cups</td> <td>2 quart</td> </tr> <tr> <td>1.5 cups</td> <td>3 cups</td> <td>2.5 or 3 quart</td> </tr> <tr> <td>2 cups</td> <td>4 cups</td> <td>3 quart or larger</td> </tr> </tbody> </table>	Rice	Water	Size of casserole dish	.5 cup	1 cup	1.5 quart	1 cup	2 cups	2 quart	1.5 cups	3 cups	2.5 or 3 quart	2 cups	4 cups	3 quart or larger
Rice	Water	Size of casserole dish															
.5 cup	1 cup	1.5 quart															
1 cup	2 cups	2 quart															
1.5 cups	3 cups	2.5 or 3 quart															
2 cups	4 cups	3 quart or larger															
4. Fish/Seafood*	0.25 - 2.0 lb 0.2 - 0.9 kg	Arrange in ring around shallow glass dish (roll fillet with edges underneath). Cover with plastic wrap. After cooking, let stand, covered, 3 minutes.															
5. Chicken Breast*	0.5 - 2.0 lb 0.3 - 0.9 kg	Cover with vented plastic wrap. When oven stops, turn over. Shield with small, flat pieces of aluminum foil any areas that are cooking too rapidly. Re-cover and touch the START add 30 sec pad. After cooking, let stand, covered 3 to 5 minutes. Chicken should be 160°F.															

* It is not necessary to enter amount.

Popcorn/Fresh Veggies/Frozen Veggies/Baked Potato/ Sensor Reheat

- Suppose you want to cook popcorn.

Procedure	
Step	Touch

<Regular>

Touch the **popcorn** pad once.



<Snack>

Touch the **popcorn** pad twice.



- Suppose you want to reheat soup.

Procedure	
Step	Touch

Touch the **sensor reheat** pad for soup.

sensor reheat

NOTES

1. Fresh veggies is same procedure for popcorn and can be selected by touching the pad once or twice depending on Soft or Hard. See Fresh Veggies chart on page 19.
2. Frozen veggies, baked potato are same procedure for sensor reheat. Follow the above procedure.
3. The popcorn, fresh veggies, frozen veggies, baked potato and sensor reheat can only be accepted within 3 minutes after cooking, opening and closing the door or touching the **STOP/CLEAR** pad to prevent from misusing.
4. Cooking can be also started by touching the **START add 30 sec** pad within 2 seconds after touching the desired pad.

Popcorn chart

Food	Amount	Procedure
Popcorn	1 package Regular: 3.0 - 3.5 oz, 85 - 100 g Snack: 1.5 - 1.75 oz, 45 - 50 g	Use only popcorn packaged for the microwave. Try several brands to decide which you like. Do not try to pop unpopped kernels. The amount is selected by pressing the pad once (Regular) or twice (Snack).

Fresh Veggies chart

Food	Amount	Procedure
1. Fresh Vegetables, soft	0.25 - 2.0 lb, 0.2 - 0.9 kg	Wash and place in casserole. Add no water if vegetables have just been washed. Cover with lid for tender vegetables. Use plastic wrap for tender-crisp vegetables. Touch the fresh veggies pad once. After cooking, stir, if possible. Let stand, covered, for 2 to 5 minutes.
Broccoli	0.25 - 2.0 lb, 0.2 - 0.9 kg	
Brussels sprouts	0.25 - 2.0 lb, 0.2 - 0.9 kg	
Cabbage	0.25 - 2.0 lb, 0.2 - 0.9 kg	
Cauliflower (flowerets)	0.25 - 2.0 lb, 0.2 - 0.9 kg	
Cauliflower (whole)	1 medium	
Spinach	0.25 - 1.0 lb, 0.2 - 0.45 kg	
Zucchini	0.25 - 2.0 lb, 0.2 - 0.9 kg	
Baked apples	2 - 4 medium	
2. Fresh Vegetables, hard	0.25 - 2.0 lb, 0.2 - 0.9 kg	
Carrots, sliced	0.25 - 1.5 lb, 0.2 - 0.6 kg	
Corn on cob	2 - 4 pcs.	
Green beans	0.25 - 1.5 lb, 0.2 - 0.6 kg	
Winter squash		
- diced	0.25 - 1.5 lb, 0.2 - 0.6 kg	
- halves	1 - 2	

Frozen Veggies chart

Food	Amount	Procedure
Frozen Veggies*	0.25 - 1.25 lb 0.2 - 0.5 kg	Add no water. Cover with lid or plastic wrap. After cooking, stir and let stand, covered, for 3 minutes.

* It is not necessary to enter amount or number.

Baked Potato chart

Food	Amount	Procedure
Baked Potato*	1 - 8 pieces (medium)	Pierce with fork in several places. Place on paper towel on turntable. After cooking, remove from oven and let stand wrapped in foil for 5 to 10 minutes.

* It is not necessary to enter amount or number.

Sensor Reheat chart

Food	Amount	Procedure
Sensor Reheat*	4 - 36 oz 0.12 - 1.0 kg	Place in dish or casserole slightly larger than amount to be reheated. Flatten, if possible. Cover with lid, plastic wrap or wax paper. Use covers such as plastic wrap or lids with larger quantities of more dense foods such as stews. After reheating, stir well, if possible. Re-cover and allow to stand 2 to 3 minutes. Foods should be very hot. If not, continue to heat with variable power and time.

* It is not necessary to enter amount or number.

AUTO MODES has 6 functions, such as auto cook, keep warm, melt/soften, snacks, auto reheat and auto defrost.

NOTES

1. AUTO MODES except keep warm can be programmed with More or Less Time Adjustment. Touch the **power level** pad once or twice before cooking is started. See page 28.
2. Each food has a cooking hint. Touch the **user pref** pad when the *HELP* indicator is lighted in the display for a helpful hint.

Auto Cook

Auto cook is divided into 2 parts, Quick Meal (frozen breakfast, scrambled eggs, hot cereal, soup) and Dinner Recipes (yellow rice & chicken, dressed-up meat loaf, herb roast pork, creamy seafood pasta and orzo vegetarian medley).

- Suppose you want to cook hot cereal for 1 serving with Less Time Adjustment.

Procedure	
Step	Touch
1. Touch the auto cook pad, number 3 for hot cereal.	 

2. Repeat touching same number pad at Step 1 to increase quantity. Ex: 1 serving.

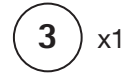

3. Touch the **power level** pad twice for Less Time Adjustment.



4. Touch the **START add 30 sec** pad.



5. Midway through the cooking, cooking stop melody will be heard and your oven will stop. Open the door, follow the instruction shown in the display and close the door.

6. Touch the **START add 30 sec** pad to continue cooking.



NOTES

1. Skip Step 3, when More or Less Time Adjustment is not needed.
2. Scrambled eggs, hot cereal and soup are same procedure. Follow the above procedure.
3. Frozen breakfast is not needed to enter amount or number. Skip Step 2.
4. If mute is set, the melody will not be heard at Step 5. See 2, Audible Signal Elimination on page 27.

Auto Cook chart

Food	Amount	Procedure
1. Frozen Breakfast*	3 -6 oz 85 - 170 g	This setting works well for frozen breakfast entrees, pancakes, waffles, burritos etc. Follow manufacturer's directions for how to prepare for microwaving. Allow to stand 1 or 2 minutes after cooking.
2. Scrambled Eggs	1 - 8 eggs	For each egg, use 1 teaspoon of butter or margarine and 1 tablespoon of milk. Place butter or margarine in dish, measuring cup or casserole large enough for the egg to expand. Mix egg and milk together. Pour on to butter or margarine in dish. Cover with wax paper. Place in oven and program. Touch number 2 to increase quantity and touch the START add 30 sec pad. When oven stops, stir egg mixture moving the cooked portion to the center of the dish, uncooked portion to the outside, close the door and touch the START add 30 sec pad. After cooking, stir and let stand, covered, until set. Note that eggs will be slightly undercooked when removed from the oven.
3. Hot Cereal	1- 6 servings	Use individual packets or bulk cereal in your favorite variety: oatmeal, oat bran, cream of wheat, farina or wheatena. Follow package directions for the correct amount of water or milk. To prevent boilovers, it is very important to choose a large container because microwave cooking of cereal causes high boiling. Touch number 3 to increase quantity and touch the START add 30 sec pad. When oven stops, stir and touch the START add 30 sec pad. After cooking, stir and let stand, covered, for 2 minutes.
4. Soup	1 - 8 cups	Place in bowl or casserole. Cover with lid or plastic wrap. Touch number 4 to increase quantity and touch the START add 30 sec pad. At end, stir, recover and let stand 1 to 3 minutes.

* It is not necessary to enter amount or number.

Dinner recipes (recipes serve 6)

5. YELLOW RICE AND CHICKEN

Place in a 3 quart casserole:

- 1 package (5 - 8 ounces) yellow rice mix with flavor packet
- 2 cups chicken broth

Stir well and cover. Touch the **auto cook** pad, number 5 and touch the **START add 30 sec pad**.

At pause, stir well and add:

- 1 cup frozen peas
- 1 red pepper, diced
- 1¹/₄ pounds boneless chicken cutlets, sliced into thin strips

Re-cover. Touch the **START add 30 sec pad**.

At end, garnish with parsley.

6. DRESSED-UP MEAT LOAF

Mix together well:

- 1¹/₂ pounds lean ground beef
- 1/2 cup soft bread crumbs
- 1/2 cup red wine
- 1 egg, beaten
- 2 tablespoons chopped onion
- 1/2 teaspoon salt
- 1/2 teaspoon dry mustard
- 1/4 teaspoon pepper
- 1 teaspoon instant beef bouillon
- 2 tablespoons chopped green pepper

Place in a 9 x 5-inch glass loaf dish.

Touch the **auto cook** pad, number 6 and touch the **START add 30 sec pad**.

If desired, spread top of meat loaf with 1/2 cup catsup during last 2 minutes of cooking time.

At end, remove from oven, cover with foil and allow to stand 3 to 5 minutes before serving.

7. HERB ROAST PORK

Combine in small dish:

- 1 tablespoon butter, melted
- 2 cloves garlic, minced
- 1 teaspoon dried marjoram leaves, crushed
- 1/2 teaspoon dried oregano leaves, crushed
- 1/2 teaspoon pepper

Stir well. Brush on:

- 1 (3 pound) boneless, pork loin, center cut

Place loin in a 13 x 9 x 2-inch casserole. Cover with vented plastic wrap.

Touch the **auto cook** pad, number 7 and touch the **START add 30 sec pad**.

8. CREAMY SEAFOOD PASTA

Place in a 3 quart casserole:

- 8 - 9 ounces fresh tortellini
- 2 cups water

Stir well and cover. Touch the **auto cook** pad, number 8 and touch the **START add 30 sec pad**.

At pause, stir well and add:

- 1 jar (17 ounces) creamy Alfredo sauce or 1³/₄ cups of medium, white cheese sauce
- 1¹/₄ pounds combination raw shellfish, fresh or thawed (shrimp, bay scallops, crabmeat)
- 3 cups mixed, fresh vegetables (sliced mushrooms, thinly julienned carrots, green beans)

Re-cover. Touch the **START add 30 sec pad**.

At end, garnish with:

- 1/3 cup grated Parmesan cheese

9. ORZO VEGETARIAN MEDLEY

Place in a 3 quart casserole:

- 1 cup orzo or other tiny shaped pasta
- 3¹/₂ cups vegetable or chicken broth
- 1/4 cup pesto sauce (fresh or reconstituted from dry)
- 1/2 cup small pieces of sundried tomatoes
- 1 tablespoon minced garlic
- 1 tablespoon Italian seasoning

Stir well and cover. Touch the **auto cook** pad, number 9 and touch the **START add 30 sec pad**.

At pause, stir well and add:

- 3 cups chopped green, red, orange or yellow peppers
- 1 onion, thinly sliced
- 1 can (14 ounces) artichoke hearts, drained and quartered
- 1 can (3 ounces) pitted, ripe olives, drained and halved

Re-cover. Touch the **START add 30 sec pad**.

At end, stir and garnish top with:





- 1/2 cup freshly shredded Parmesan cheese
- 1/4 cup pine nuts

Keep Warm

Keep warm allows you to keep food warm for 30 minutes at the maximum.

Direct use

- Suppose you want to keep a cup of soup warm for 30 minutes.





Procedure	
Step	Touch
1. Touch the keep warm pad.	
2. Enter the desired time. Ex : 30 minutes.	 
3. Touch the START add 30 sec pad.	

The oven will start. The display will show *30.00* and count down. *KEEP WARM* will be displayed every 10 seconds during the countdown.

You can program Keep warm with manual cooking to keep food warm continuously after cooking.

With manual cooking

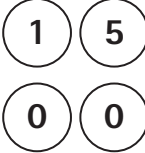
- Suppose you want to cook a cup of soup for 2 minutes at 70% and keep the soup warm for 15 minutes.

Procedure	
Step	Touch
1. Enter cooking time.	
2. Touch the power level pad 4 times for 70% power.	 x 4
3. Touch the keep warm pad.	
4. Enter the desired time by touching the number pads 1, 5, 0 and 0 for 15 minutes.	
5. Touch the START add 30 sec pad.	

The operation will start. When the cooking time is complete, cooking completion melody will sound and Keep warm will start. *KEEP WARM* will appear in the display every 10 seconds and count down for 15 minutes.

NOTES





- Keep warm cannot be programmed in conjunction with SENSOR MODES or AUTO MODES.
- Keep warm can be used in conjunction with sequence cooking in Auto Start function. See Auto Start on page 27.
- Turn table ON/OFF function can be used in keep warm. See page 29.

Melt, Soften

Melt, soften automatically compute the correct heating time and microwave power level for melting and softening foods shown in the chart.

There are 4 foods (butter, chocolate, ice cream and cream cheese) under the melt, soften.

- Suppose you want to melt 1 square of chocolate with More Time Adjustment.

Procedure	
Step	Touch
1. Touch the melt, soften pad once, number 2 for chocolate.	 
2. Repeat touching same number pad at Step 1 to select quantity. Ex: Touch number 2 two more times for 1 square.	 x 2
3. Touch the START add 30 sec pad.	

NOTES

1. To melt, soften other food or foods except the quantity listed in the melt, soften, use manual operation.
2. Skip Step 2, if More Time Adjustment is not needed.
3. Butter, chocolate, ice cream and cream cheese are same procedure. Follow the procedure on the left side.

Melt, Soften chart





Food	Amount	Procedure
Melt		
1. Butter	2 tbsp	Use a Pyrex measuring cup. Cover with plastic wrap. Stir after cooking. After touching the melt, soften pad, touch number 1 two times for 2 tbsp.
	1/2 cup	After touching the melt, soften pad, touch number 1 three times for 1/2 cup.
2. Chocolate	1 cup chips	After touching the melt, soften pad, touch number 2 two times for 1 cup chips.
	1 square	After touching the melt, soften pad, touch number 2 three times for 1 square.
Soften		
3. Ice cream		DO NOT COVER.
	1 pint	After touching the melt, soften pad, touch number 3 two times for 1 pint.
	1/2 gallon	After touching the melt, soften pad, touch number 3 three times for 1/2 gallon.
4. Cream cheese		Use a small plate. DO NOT COVER.
	3 oz, 85 g	After touching the melt, soften pad, touch number 4 two times for 3 oz or 0.085 kg.
	8 oz, 225 g	After touching the melt, soften pad, touch number 4 three times for 8 oz or 0.225 kg.

Snacks



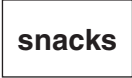

Snacks are for cooking/heating foods that take a short amount of time!

There are 7 foods (frozen mw pizza, hand held snacks (3-4 oz / 0.085-0.113 kg), hand held snacks (5-6 oz / 0.142-0.17 kg), chicken nuggets, hot dogs, frozen kind's meal and pizza) under the snacks.

- Suppose you want to reheat a slice of pizza with snacks.

Procedure	
Step	Touch
1. Touch the snacks pad and number 7 for pizza.	 
2. Repeat touching same number pad at Step 1 to increase quantity.	 x1
3. Touch the START add 30 sec pad.	

- Suppose you want to heat 0.3 pound or 0.3 kilogram chicken nuggets with snacks.

Procedure	
Step	Touch
1. Touch the snacks pad and number 4 for chicken nuggets.	 
2. Enter amount by touching the number 3. Ex: 0.3 lb or 0.3 kg chicken nuggets.	
3. Touch the START add 30 sec pad.	

NOTES

1. Above other 6 foods except chicken nuggets under the snacks is same procedure. Follow the procedure on the left side. Frozen mw pizza, hand held snacks and Frozen Kid's Meal are not needed to enter amount or number. Skip Step 2.
2. When 1.0 pound chicken nuggets is heated, touch number 1 and 0 at Step 2.

Snacks chart





Food	Amount	Procedure
1. Frozen MW Pizza*	6 - 8 oz 170 - 225 g	Use for frozen microwave pizza. Remove from package and unwrap. Follow package directions for use of package and/or silver crisping disk.
2. Hand Held Snacks*	3 - 4 oz 85 - 113 g	Use for frozen French fries, cheese sticks, appetizers etc. Remove from outer package. Arrange on flat plate. Follow package directions for how to wrap or cover. Be careful when removing from the oven as snack may be very hot.
3. Hand Held Snacks*	5 - 6 oz 142 - 170 g	Use for frozen French fries, cheese sticks, appetizers etc. Remove from outer package. Arrange on flat plate. Follow package directions for how to wrap or cover. Be careful when removing from the oven as snack may be very hot.
4. Chicken Nuggets	0.3 - 1.0 lb 0.2 - 0.4 kg	Place frozen chicken nuggets on a flat plate allowing space between each. It is not necessary to cover them. When oven stops, rearrange and touch the START add 30 sec pad.
5. Hot Dogs	1 - 6 pieces	Place hot dog in bun. Wrap each with paper towel or napkin. Touch number 5 to increase quantity and touch the START add 30 sec pad.
6. Frozen Kid's Meal*	6 - 8 oz 170 - 225 g	Use this pad for frozen, convenience foods. It will give satisfactory results for most brands. You may wish to try several and choose your favorite. Remove package from outer wrapping and follow package directions for covering. After cooking, let stand, covered for 1 to 3 minutes.
7. Pizza	1 - 6 slices	Use this setting to reheat refrigerated leftover pizza, 1 slice is approximately 1/8th of a 12-inch pizza or 1/12th of a 16-inch pizza. Arrange on flat plate. Touch number 7 to increase quantity and touch the START add 30 sec pad.

* It is not necessary to enter amount.

Auto Reheat

There are 4 foods (fresh rolls/muffins, frozen rolls/muffins, pasta and beverage) under the auto reheat.

- Suppose you want to reheat 2 fresh muffins with auto reheat.

Procedure	
Step	Touch
1. Touch the auto reheat pad and number 1 for fresh muffin.	 
2. Repeat touching same number pad at Step 1 to increase quantity. Ex : 2 muffins.	 x2
3. Touch the START add 30 sec pad.	

NOTES

1. Auto reheat can be programmed with More or less time adjustment. See page 28.
2. Fresh rolls/muffins, frozen rolls/muffins, pasta and beverage are same procedure. Follow the left side procedure.

Auto Reheat chart







Food	Amount	Procedure
1. Fresh Rolls/ Muffins	1 - 10 pieces	Use this pad to warm rolls, muffins, biscuits, bagels etc. Large items should be considered as 2 or 3 regular size. Arrange on flat plate; cover with paper towel. For refrigerated rolls or muffins, it may be necessary to double the entered amount to ensure the proper serving temperature. For example, enter quantity of 2 for 1 refrigerated muffin. Touch the auto reheat pad and number 1 to increase quantity and touch the START add 30 sec pad.
2. Frozen Rolls/ Muffins	1 - 10 pieces	Use this pad to warm rolls, muffins, biscuits, bagels etc. Large items should be considered as 2 or 3 regular size. Arrange on flat plate; cover with paper towel. Touch the auto reheat pad and number 2 to increase quantity and touch the START add 30 sec pad.
3. Pasta	1 - 6 cups	Use this pad to reheat refrigerated canned or homemade pasta with sauce. For room temperature pastas, use Less option. Pasta without sauce double the quantity per setting. For example, measure 2 cups of cooked noodles and program for 1 cup. Cover with lid or plastic wrap. Touch the auto reheat pad, number 3 to increase quantity and touch the START add 30 sec pad. After cooking, stir and let stand, covered 2 to 3 minues.
4. Beverage	0.5 - 2.0 cups	This setting is good for restoring a cool beverage to a better drinking temperature. Stir liquid briskly before and after heating to avoid "eruption". Touch the auto reheat pad, number 4 to increase quantity and touch the START add 30 sec pad.

Auto Defrost

There are 6 foods (ground meat, stakes/chops/fish, chicken pieces, roast, casserole and soup) under the auto defrost.

Auto defrost automatically defrosts all the foods found in the Defrost chart below.

- Suppose you want to defrost a 1.8 pound or 1.8 kilogram steak.

Procedure	
Step	Touch
1. Touch the auto defrost pad and number 2 for steak.	 
2. Enter weight by touching number 1 and 8. Ex: 1.8 lb or 1.8 kg steak.	 
3. Touch the START add 30 sec pad.	
4. Midway through the cooking, cooking stop melody will be heard and your oven will stop. Open the door, follow the instruction shown in the display and close the door. Touch the START add 30 sec pad.	

After defrost cycle ends, let stand, covered.

Auto Defrost chart

Food	Amount	Procedure
1. Ground Meat	0.5 - 3.0 lb 0.3 - 1.3 kg	Remove any thawed pieces after each stage. Let stand, covered, for 5 to 10 minutes.
2. Steaks/Chops/ Fish	0.5 - 4.0 lb 0.3 - 1.8 kg	After each stage, rearrange and if there are warm or thawed portions, shield with small flat pieces of aluminum foil. Remove any meat or fish that is almost defrosted. Let stand, covered, for 10 to 20 minutes.
3. Chicken Pieces	0.5 - 3.0 lb 0.3 - 1.3 kg	After each stage, rearrange pieces or remove portions should they become warm or thawed. Let stand, covered, for 10 to 20 minutes.
4. Roast	2.0 - 4.0 lb 1.0 - 1.8 kg	Start defrosting with fat side down. After each stage, turn roast over and shield the warm portions with aluminum foil. Let stand, covered, for 30 to 60 minutes.
5. Casserole	2 - 6 cups	After audible signal, stir if possible. At end, stir well and let stand, covered, for 5 to 10 minutes.
6. Soup	1 - 6 cups	After audible signal, stir if possible. At end, stir well and let stand, covered, for 5 to 10 minutes.

NOTES

1. To defrost other food or foods above or below the weights allowed on the Defrost chart, use time and 30% power. See Manual defrost on page 15.
2. If you attempt to enter more or less than the amount as indicated in the chart below, an error message will appear in the display.
3. Check foods when your oven stops. After final stage, small sections may still be icy. Let stand to continue thawing. Do not defrost until all ice crystals are thawed.
4. If mute is set, the melody will not be heard at Step 4. See 2, Audible Signal Elimination on page 27.
5. Shielding prevents cooking from occurring before the center of the food is defrosted. Use small smooth strips of aluminum foil to cover edges and thinner sections of the food.
6. Touch number 5 to enter 0.5 pound or 0.5 kilogram at Step 2.
7. Touch desired number for casserole and soup at Step 2.

User Pref

User pref provides 4 features that make using your oven easy because specific instructions are provided in the interactive display.

1. Child Lock

The Child Lock prevents unwanted oven operation such as by small children. The oven can be set so that the control panel is deactivated or locked. To set, touch the **user pref** pad, the number 1 and then touch the **START add 30 sec** pad. Should a pad be touched, **LOCKED** will appear in the display.

To cancel, touch the **user pref** pad and the **START add 30 sec** pad. Child Lock will not be canceled if other pads except the **START** pad are touched after touching the **user pref** pad.

2. Audible Signal Elimination







If you wish to have the oven operate with no audible signals, touch the **user pref** pad, number 2 and the **STOP/CLEAR** pad.











To cancel and restore the audible signal, touch the **user pref** pad, number 2 and the **START add 30 sec** pad.

3. Auto Start

If you wish to program your oven to begin cooking automatically at a designated time of day, follow this procedure:

- Suppose you want to start cooking a stew for 20 minutes on 50% and set keep warm 15 minutes at 4:30. Before setting, check to make sure the clock is showing the correct time of day.

Procedure	
Step	Touch
1. Touch the user pref pad.	
2. Touch number 3.	
3. Enter the start time. Ex : 4:30	  
4. Touch the set clock pad.	

Procedure	
Step	Touch
5. Enter cooking time. Ex : 20 minutes	   
6. Touch the power level pad six times for 50% power.	 x 6
7. Touch the keep warm pad.	
8. Enter desired time. Ex : 15 minutes	   
9. Touch the START add 30 sec pad.	

NOTES

- Auto Start can be used for manual cooking and keep warm set in conjunction with sequence cooking if clock is set.
- If the oven door is opened after programming Auto Start, it is necessary to touch the **START add 30 sec** pad for Auto Start time to appear in the display so that the oven will automatically begin programmed cooking at the chosen Auto Start time.
- Be sure to choose foods that can be left in the oven safely until the Auto Start time. Acorn or butternut squash are often a good choice.
- If you wish to know the time of day, simply touch the **set clock** pad.
- After programming Auto Start, open the door and close the door to cancel auto start function.

4. Language Selection

The oven comes set for English and U.S. Customary Units. Your oven can be selected 3 Languages, English, Spanish or French, and 2 units, pounds or kilograms for each language. To change, touch the **user pref** pad and number 4. Continue to touch the number 4 until your choice is selected from the table below. Then, touch the **START add 30 sec** pad.

Press the user pref pad and number 4	Language	Units
once		
twice	English	LB
3 times	English	KG
4 times	Spanish	LB
5 times	Spanish	KG
6 times	French	LB
7 times	French	KG
8 times	English	LB

Multiple Sequence Cooking

Your oven can be programmed for up to 4 automatic cooking sequences, switching from one power level setting to another automatically.

Sometimes cooking directions tell you to start on one power level and then change to a different power level. Your oven can do this automatically.

- Suppose you want to cook roast beef for 5 minutes at 100% and then continue to cook for 30 minutes at 50%.

Procedure	
Step	Touch
1. Enter cooking time for 1st stage.	
2. Touch the power level pad once for 100% power for 1st stage.	
3. Enter second cooking time for 2nd stage.	
4. Touch the power level pad 6 times for 50% power for 2nd stage.	

- Touch the **START add 30 sec** pad for 2nd stage.

**START
add 30 sec**

NOTES

- If the **power level** pad is touched, *HIGH* will be displayed.
- If 100% is selected as the final sequence, it is not necessary to touch the **power level** pad.
- Keep warm can be programmed even if 4 cooking sequences have been set.

More or Less Time Adjustment

Should you discover that you like any of **SENSOR MODES** or **AUTO MODES** slightly more done, touch the **power level** pad once after touching your choice of pads or before touching the **START add 30 sec** pad. The display will show *MORE*.

Should you discover that you like any of **SENSOR MODES** or **AUTO MODES** slightly less done, touch the **power level** pad twice after touching your choice of pads or before touching the **START add 30 sec** pad. The display will show *LESS*.

Add 30 Seconds

Add 30 seconds allows you to cook for 30 seconds at 100% by simply touching the **START add 30 sec** pad. You can also extend cooking time in multiples of 30 seconds by repeatedly touching the **START add 30 sec** pad until maximum 99 minutes during manual cooking.

- Suppose you want to heat a cup of soup for 30 seconds.

Procedure	
Step	Touch
Touch the START add 30 sec pad.	

NOTES

- To use **add 30 seconds**, touch the pad within 3 minutes after cooking, closing the door, touching the **STOP/CLEAR** pad or during cooking.
- Add 30 seconds cannot be used with **SENSOR MODES** and **AUTO MODES**.



Help

Each setting has a cooking hint. If you wish to check, touch the **user pref** pad whenever *HELP* is lighted in the Interactive Display for these and other manual operation hints.

Timer

You can easily use Timer function as independent kitchen timer or while using microwave for cooking.

- Suppose you want to time a 3-minute long distance phone call.

Procedure	
Step	Touch
1. Touch the timer on-off pad.	
2. Enter time.	
3. Touch the timer on-off pad. The timer will count down.	
4. At end of timer, 3 long beeps will sound and words Timer / End will flash in the display. This tells you the timer is completed. To cancel, just touch any key pad. The time of day clock will then appear in display.	

NOTES

- Timer on-off pad** acts as an independent kitchen timer. It can be used before microwave is started for cooking or after microwave has already been started cooking. Timer can not be set while microwave cooking is programming.
- Timer is always started as example above - touch **timer** pad, enter desired time, press **timer** pad again to start count down.
- Canceling the Timer function is completed as follows - touch timer pad, then touch **STOP clear** pad. **Timer** is cancelled. This must be done within 4 seconds after touching timer pad. See Timer Operation Table below.
- When Timer function is completed, 3 long beeps will sound and words Timer / End will flash in the display. This tells you the timer function is completed. To cancel, just touch any key pad. The time of day clock will then appear in display.
- If using timer when cooking with microwave, when timer is completed, 3 long beeps will sound and words Timer / End will flash in the display. This will continue until timer is cancelled by pressing any key pad. The microwave cooking time will then appear in display.
- If using timer when cooking with microwave, and cooking is completed and canceled, Timer remaining time will be displayed and continue counting down.

Turntable ON/OFF

Turntable OFF function is useful when a rack or a large casserole which stop the turntable's rotating are used, for example lasagne or meat. Reposition the foods and/or stir them at least once during any

cooking or reheating time. After cooking or reheating, stir if possible. Using a lower power level will assist in better cooking or reheating uniformity.

Turntable ON/OFF function can be used in Manual Cooking and keep warm in AUTO MODES. When Turntable ON is set, Turntable is turned on and when Turntable OFF is set, Turntable is stopped. When SENSOR MODES and AUTO MODES are selected, Turntable ON is automatically set.

Turntable ON/OFF can be set during Manual Cooking and cooking programming by touching the turntable on-off pad.

Quick Start

Quick start is very useful function to start or add to cook from 1 minute to 6 minutes by touching number from 1 to 6 at 100% power without touching the **START add 30 sec** pad. Touch number from 1 to 6 within 3minutes after cooking, closing the door, touching the **STOP/CLEAR** pad.

- Suppose you want to cook 2 minutes at 100% power.

Procedure	
Step	Touch
Touch number 2.	

Demonstration Mode

To demonstrate, touch the **set clock** pad, number 0 and then touch the **START add 30 sec** pad and hold for three seconds. *DEMO ON DURING DEMO NO OVEN POWER* will appear in the display. Cooking operations and specific special features can now be demonstrated with no power in the oven. For example, touch the **START add 30 sec** pad and the display will show .30 and count down quickly to **END**.

To cancel, touch the **set clock** pad, number 0 and the **STOP/CLEAR** pad. If easier, unplug the oven from the electrical outlet and replug.

Light

Touch the **light** pad once for high, twice for medium, three times for Low and four times to turn off.

Fan

The fan will automatically start when heat rises from range surface units or burners. This protects the Over the Range Microwave Oven from excessive temperature rise. The fan will stay on until the temperature decreases. It cannot be turned off manually during this time.

For other uses, touch the **fan** pad once for high speed, twice for medium speed, three times for low speed and four times to turn off.

Timer Operation Table

	Display	To see timer counting	How to cancel Timer	How to stop or cancel cooking
Timer use only	Timer counting down	Appears in display at all times	Press STOP clear pad once	-
Microwave cooking and timer being used at same time	Microwave cooking is counting down	Press timer on-off pad. Remaining time will appear for 4 seconds, then will change back to microwave cook time.	Press timer on-off pad, then STOP clear pad once. This must be completed within 4 seconds after timer on-off pad.	Stop: Press the STOP clear pad once. Cancel: Press the STOP clear pad twice.

Disconnect the power cord before cleaning or leave the door open to deactivate the oven during cleaning.

EXTERIOR

The outside surface is precoated steel and plastic. Clean the outside with mild soap and water; rinse and dry with a soft cloth. Do not use any type of household or abrasive cleaner.

DOOR

Disconnect the power cord or deactivate the oven with setting Child Lock before cleaning to prevent unexpected manipulation. See Child Lock on page 27. Wipe the window on both sides with a soft cloth to remove any spills or splatters. Metal parts will be easier to maintain if wiped frequently with a soft cloth. Avoid the use of spray and other harsh cleaners as they may stain, streak or dull the door surface.

EASY CARE™ STAINLESS STEEL (SOME MODELS)

Your microwave oven finish may be made with Easy Care™ Stainless Steel (some models). Clean the stainless with warm soapy water using a clean sponge or cloth. Rinse with clean water and dry with a soft clean cloth. **DO NOT** use ANY store bought cleaners like Stainless Steel cleaners or any other types of cleaners containing any abrasive, chlorides, chlorines or ammonia. It is recommended to use mild dish soap and water or a 50/50 solution of water and vinegar.

INTERIOR

Cleaning is easy because little heat is generated to the interior surfaces; therefore, there is no baking and setting of spills or spattering. To clean the interior surfaces, wipe with a soft cloth and warm water. **DO NOT USE ABRASIVE OR HARSH CLEANERS OR SCOURING PADS.** For heavier soil, use baking soda or a mild soap; rinse thoroughly with hot water. The rack can be cleaned with hot soapy water, rinsed and dried.

WAVEGUIDE COVER

The waveguide cover is located on the ceiling in the microwave oven cavity. It is made from mica so requires special care. Keep the waveguide cover clean to assure good microwave oven performance. Carefully wipe with a damp cloth any food splatters from the surface of the cover immediately after they occur. Built-up splashes may overheat and cause smoke or possibly catch fire. **DO NOT REMOVE THE WAVEGUIDE COVER.**

ODOR REMOVAL

Occasionally, a cooking odor may remain in the microwave oven. To remove, combine 1 cup water, grated peel and juice of 1 lemon and several whole cloves in a 2-cup glass measuring cup. Boil for several minutes using 100% power. Allow to set in microwave oven until cool. Wipe interior with a soft cloth.

TURNTABLE/TURNTABLE SUPPORT

The turntable and turntable support can be removed for easy cleaning. Wash them in mild, sudsy water; for stubborn stains use a mild cleanser and non-abrasive scouring sponge. They are also dishwasher-proof. Use upper rack of dishwasher. The turntable motor shaft is not sealed, so excess water or spills should be wiped up immediately.

GREASE FILTERS

Filters should be cleaned at least once a month. Never operate the fan or microwave oven without the filters in place.

1. Pull down slightly on the tab toward the front of the microwave oven and remove the filter. Repeat for the other filter.
2. Soak the filters in a sink or dish pan filled with hot water and detergent. **DO NOT** use ammonia or other alkali; they will react with the filter material and darken it.
3. Agitate and scrub with a brush to remove embedded dirt.
4. Rinse thoroughly and shake dry.
5. Replace by fitting the filter back into the opening.

BOTTOM VIEW

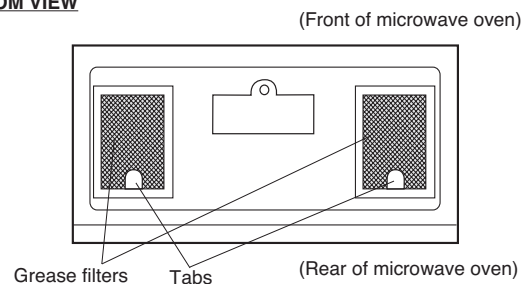

Disconnect the power cord before cleaning or leave the door open to deactivate the oven during cleaning.

CHARCOAL FILTERS

Charcoal Filters, which are attached with Hood Louver, are used for nonvented, recirculated installation. The filter should be changed every 6 to 12 months depending on use.

1. Disconnect power to the microwave oven at the circuit breaker panel or by unplugging.
2. Remove three Hood Louver Screws.
3. Push the upper tabs and pull the louver away from the unit.
4. Remove the charcoal filters from hood louver and replace new charcoal filters by piercing tabs into the holes in charcoal filters.
5. Carefully push the louver back into place and replace the screws removed at step 2.

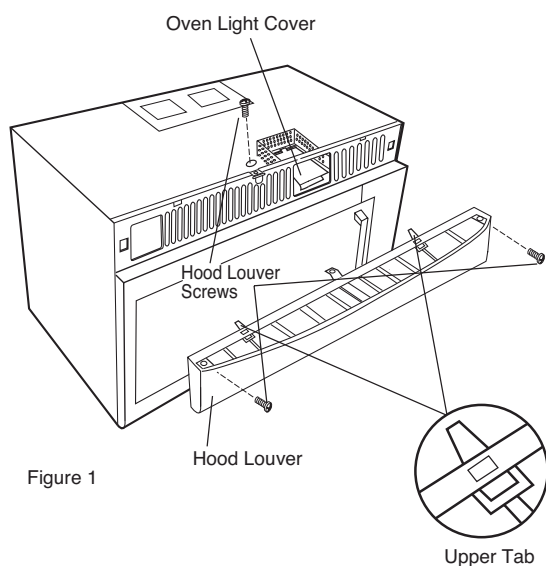

Figure 1

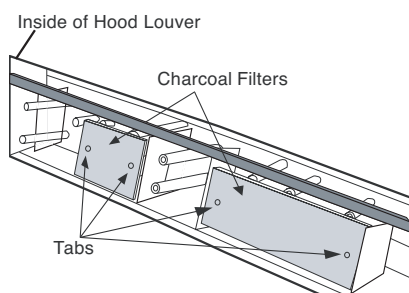

Figure 2

MICROWAVE OVEN LIGHT

Remove the louver per instructions 1-3 above, if used.

1. To replace an old krypton light bulb, first disconnect power to the microwave oven at the circuit breaker panel or by unplugging.
2. Open oven light cover by carefully pulling up on the front edge. See figure 1.
3. Remove an old light bulb and replace a new 40 watts krypton light bulb. **DO NOT USE BULB LARGER THAN 40 WATTS.**
4. Close the Oven Light Cover by carefully pushing into place. Push the louver back into place (engaging both the bottom and top tabs) and replace three Hood Louver Screws.

LIGHT BULB

1. To replace an old krypton light bulb, first disconnect power to the microwave oven at the circuit breaker panel or by unplugging.
2. To open Light Cover, remove the screw on the light cover. (See Figure 3.)
3. Replace the old 40 watts krypton light bulb with new one. **DO NOT USE A BULB LARGER THAN 40 WATTS.**
4. Close the Light Cover and secure with screw removed at step 2.

BOTTOM VIEW

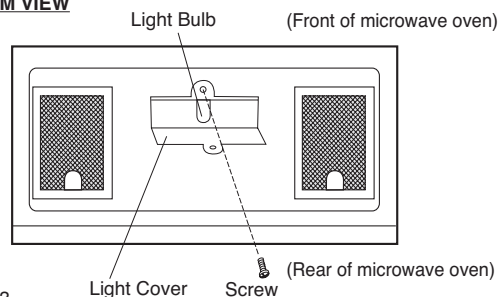

Figure 3

CAUTION

Light Cover may become very hot. Do not touch glass when light is on.

Please check the following before calling for service:

Place one cup of water in a glass measuring cup in the oven and close the door securely.

Operate the oven for one minute at HIGH 100%.

- | | | | |
|---|---|----------|---------|
| A | Does the oven light come on? | YES ____ | NO ____ |
| B | Does the cooling fan work?
(Put your hand over the left side of louver.) | YES ____ | NO ____ |
| C | Is the water in the oven warm? | YES ____ | NO ____ |

If “NO” is the answer to any of the above questions, please check electrical outlet, fuse and/or circuit breaker. If they are functioning properly, CONTACT YOUR NEAREST ELECTROLUX AUTHORIZED SERVICER.

A microwave oven should never be serviced by a “do-it-yourself” repair person.

NOTES

1. If time appearing in the display is counting down very rapidly, check Demonstration Mode on page 29 and cancel.
2. If the oven is set for 40 minutes and over at 80, 90 or 100 percent power level, after the first 40 minutes the power level will automatically adjust itself to 70 percent power to avoid overcooking.

AC Line Voltage:	Single phase 120V, 60Hz, AC only
AC Power Required:	1650 W 14.3 amps. (for EI30BM55H) 1500 W 13.0 amps. (for EI30BM5CH)
Output Power:*	1000 watts
Frequency:	2450 MHz (Group 2/Class B)**
Outside Dimensions (including handle):	29 15/16"(W) x 17 1/16"(H) x 18 15/32"(D)
Cavity Dimensions:	22 1/2"(W) x 10 1/16"(H) x 14 31/32"(D)
Microwave Oven Capacity***:	2.0 Cu. Ft.
Weight:	Approx. (net) 61 lb, (gross) 73 lb

* The International Electrotechnical Commission's standardized method for measuring output wattage. This test method is widely recognized.

** This is the classification of ISM (Industrial, Scientific and Medical) equipment described in the International Standard CISPR11. (for EI30BM5CH)

*** Internal capacity is calculated by measuring maximum width, depth and height. Actual capacity for holding food is less.

In compliance with standards set by:

FCC - Federal Communications Commission Authorized.

DHHS - Complies with Department of Health and Human Services (DHHS) rule, CFR, Title 21, Chapter I, Subchapter J.

NHW - Department of National Health and Welfare of Canada. (for EI30BM5CH)



- This symbol on the nameplate means the product is listed by Underwriters Laboratories, Inc.



- This symbol on the nameplate means the product is listed by Underwriters Laboratories, Inc. for use in USA or Canada.

Major Appliance Warranty Information

Your appliance is covered by a one year limited warranty. For one year from your original date of purchase, Electrolux will repair or replace any parts of this appliance that prove to be defective in materials or workmanship when such appliance is installed, used, and maintained in accordance with the provided instructions. In addition, the magnetron tube of your appliance is covered by a two through five year limited warranty. During the 2nd through 5th years from your original date of purchase, Electrolux will provide a replacement magnetron tube for your appliance which has proven to be defective in materials or workmanship when your appliance is installed, used, and maintained in accordance with the provided instructions.

Exclusions

This warranty does not cover the following:

1. Products with original serial numbers that have been removed, altered or cannot be readily determined.
2. Product that has been transferred from its original owner to another party or removed outside the USA or Canada.
3. Rust on the interior or exterior of the unit.
4. Products purchased "as-is" are not covered by this warranty.
5. Food loss due to any refrigerator or freezer failures.
6. Products used in a commercial setting.
7. Service calls which do not involve malfunction or defects in materials or workmanship, or for appliances not in ordinary household use or used other than in accordance with the provided instructions.
8. Service calls to correct the installation of your appliance or to instruct you how to use your appliance.
9. Expenses for making the appliance accessible for servicing, such as removal of trim, cupboards, shelves, etc., which are not a part of the appliance when it is shipped from the factory.
10. Service calls to repair or replace appliance light bulbs, air filters, water filters, other consumables, or knobs, handles, or other cosmetic parts.
11. Labor or in-home service costs during the additional limited warranty periods beyond the first year from your original date of purchase.
12. Pickup and delivery costs; your appliance is designed to be repaired in the home.
13. Surcharges including, but not limited to, any after hour, weekend, or holiday service calls, tolls, ferry trip charges, or mileage expense for service calls to remote areas, including the state of Alaska.
14. Damages to the finish of appliance or home incurred during transportation or installation, including but not limited to floors, cabinets, walls, etc.
15. Damages caused by: services performed by unauthorized service companies; use of parts other than genuine Electrolux parts or parts obtained from persons other than authorized service companies; or external causes such as abuse, misuse, inadequate power supply, accidents, fires, or acts of God.

DISCLAIMER OF IMPLIED WARRANTIES; LIMITATION OF REMEDIES

CUSTOMER'S SOLE AND EXCLUSIVE REMEDY UNDER THIS LIMITED WARRANTY SHALL BE REPAIR OR REPLACEMENT AS PROVIDED HEREIN. **CLAIMS BASED ON IMPLIED WARRANTIES, INCLUDING WARRANTIES OF MERCHANTABILITY OR FITNESS FOR A PARTICULAR PURPOSE, ARE LIMITED TO ONE YEAR OR THE SHORTEST PERIOD ALLOWED BY LAW, BUT NOT LESS THAN ONE YEAR.** ELECTROLUX SHALL NOT BE LIABLE FOR CONSEQUENTIAL OR INCIDENTAL DAMAGES SUCH AS PROPERTY DAMAGE AND INCIDENTAL EXPENSES RESULTING FROM ANY BREACH OF THIS WRITTEN LIMITED WARRANTY OR ANY IMPLIED WARRANTY. SOME STATES AND PROVINCES DO NOT ALLOW THE EXCLUSION OR LIMITATION OF INCIDENTAL OR CONSEQUENTIAL DAMAGES, OR LIMITATIONS ON THE DURATION OF IMPLIED WARRANTIES, SO THESE LIMITATIONS OR EXCLUSIONS MAY NOT APPLY TO YOU. THIS WRITTEN WARRANTY GIVES YOU SPECIFIC LEGAL RIGHTS. YOU MAY ALSO HAVE OTHER RIGHTS THAT VARY FROM STATE TO STATE.

If You Need Service

Keep your receipt, delivery slip, or some other appropriate payment record to establish the warranty period should service be required. If service is performed, it is in your best interest to obtain and keep all receipts. Service under this warranty must be obtained by contacting Electrolux at the addresses or phone numbers below.

This warranty only applies in the USA, Puerto Rico and Canada. In the USA and Puerto Rico, your appliance is warranted by Electrolux Major Appliances North America, a division of Electrolux Home Products, Inc. In Canada, your appliance is warranted by Electrolux Canada Corp. Electrolux authorizes no person to change or add to any obligations under this warranty. Obligations for service and parts under this warranty must be performed by Electrolux or an authorized service company. Product features or specifications as described or illustrated are subject to change without notice.

USA

1-877-435-3287

Electrolux Major Appliances North America
P.O. Box 212378
Augusta, GA 30907

Canada

1-800-265-8352

Electrolux Canada Corp.
5855 Terry Fox Way
Mississauga, Ontario, Canada L5V 3E4

