



## Horoscope Of Sample

Date	01/01/1990
Time	05:30:00
Place	DELHI
Latitude	028.39.N
Longitude	077.13.E

Zodiac Sign	CAPRICORN
Lunar Sign	AQUARIUS
Nakshatra Sign	DHANISTHA
Pada	3

Provided by :-

**Triple-S Software**

Website:-<http://www.horosoft.net>

Email:[sales@horosoft.net](mailto:sales@horosoft.net) , [horosoft@yahoo.com](mailto:horosoft@yahoo.com)

Printed On : October 12,2010

# OM SHREE GANESHAYAE NAMAH

1

NAME	Sample	GR.FATHER'S NAME	
SEX	MALE	FATHER'S NAME	
DATE OF BIRTH	01/01/1990	MOTHER'S NAME	
DAY OF BIRTH	MONDAY	CASTE	
TIME OF BIRTH	05:30:00	GOTRA	
TIME OF BIRTH	55: 39: 37		
(In Ghati)			
PLACE OF BIRTH	DELHI	VIKRAMI SAMVAT	2046
LATITUDE	028.39NORTH	SAKA SAMVAT	1911
LONGITUDE	077.13EAST	MONTH	PAUSA
LOCAL BIRTH TIME	05:08:52	LUNAR PAKSHA	SUKLA
LOCAL BIRTH DATE	01/01/1990	LUNAR TITHI	4
SUN RISE	7: 14: 9	TITHI AT SUNRISE	3
SUNSET	17: 35: 3	TITHI ENDING TIME	9: 28: 6
DAY DURATION	10: 20: 54	NAK. AT SUNRISE	SRAVANA
SIDERIAL TIME	11: 50: 22	NAK. ENDING TIME	12: 22: 4
BHAYAT	42:49:50	YOGA AT SUNRISE	HARSANA
BHABHOG	60:1:25	YOGA ENDING TIME	8: 6: 32
SEASON	SHISIR	KARAN AT SUNRISE	GARA
BALANCE OF DASA	MAR 2Y 0M 6D	KARAN ENDING TIME	9: 28: 6

## AVAKHADA CHAKRA

## GHAT CHAKRA

LAGAN	SCORPIO
LAGAN LORD	MARS
SIGN	AQUARIUS
SIGN LORD	SATURN
NAKSHATRA	DHANISHTHA
NAKSHATRA LORD	MARS
CHARAN	3
PAYA	IRON
YOGA	VAJRA
KARAN	VISTI
GAN	RAKSHAS
YONI	SIMHA
NADI	MADHYA
VARAN	SUDRA
VASHYA	MANAV
VARG	MARJHAD(CAT)
NAME ALPHABET	GU
YUJA	ANTYA
HANSAK	VAYU

MONTH	CHAITRA
TITHI	3- 8- 13
DAY	THURSDAY
NAKSHTRA	ARDRA
YOGA	GANDA
KARAN	KINTUGHANA
PRAHAR	3
VARGA	MOOSHAK(RAT)
MOON	SAGITTARIUS

### LUCKY DAY, STONE

LUCKY DAY	TUESDAY
LUCKY NO.	4
LUCKY COLOR	WHITE
LUCKY STONE	PEARL
METAL FOR STONE	SILVER
FINGER FOR STONE	RING FINGER

**Triple-S Software**

Website:-<http://www.horosoft.net>

Email:[sales@horosoft.net](mailto:sales@horosoft.net) , [horosoft@yahoo.com](mailto:horosoft@yahoo.com)

## PLANET'S POSITION AT BIRTH TIME

PLANET	SIGN	DEGREE	POSITION	LORD	NAKSHATRA	PAD	LORD S.	LORD
ASC	SCORPIO	21 54 56		MAR	JYESTHA	2	MER	SUN
SUN	SAGITTARIUS	16 35 07		JUP	P.ASADHA	1	VEN	MON
MON	AQUARIUS	02 49 37		SAT	DHANISHTHA	3	MAR	VEN
MAR	SCORPIO	15 55 58		MAR	ANURADHA	4	SAT	JUP
MER	CAPRICORN	02 04 13		RET	SAT	2	SUN	JUP
JUP	GEMINI	11 29 20		RET	MER	2	RAH	SAT
VEN	CAPRICORN	12 33 26		RET	SAT	1	MON	RAH
SAT	SAGITTARIUS	21 52 54	COM	JUP	P.ASADHA	3	VEN	JUP
RAH	CAPRICORN	23 08 09		RET	SAT	4	MON	SUN
KET	CANCER	23 08 09		RET	MON	2	MER	MON
URA	SAGITTARIUS	12 02 18		JUP	MOOLA	4	KET	MER
NEP	SAGITTARIUS	18 18 07		JUP	P.ASADHA	2	VEN	RAH
PLU	LIBRA	23 21 17		VEN	VISAKHA	2	JUP	SAT

CHITRAPAKSHA AYANAMSA 23: 43: 9 DEGREE

TRUE POSITION OF RAHU AND KETU IS GIVEN

## LAGAN CHART

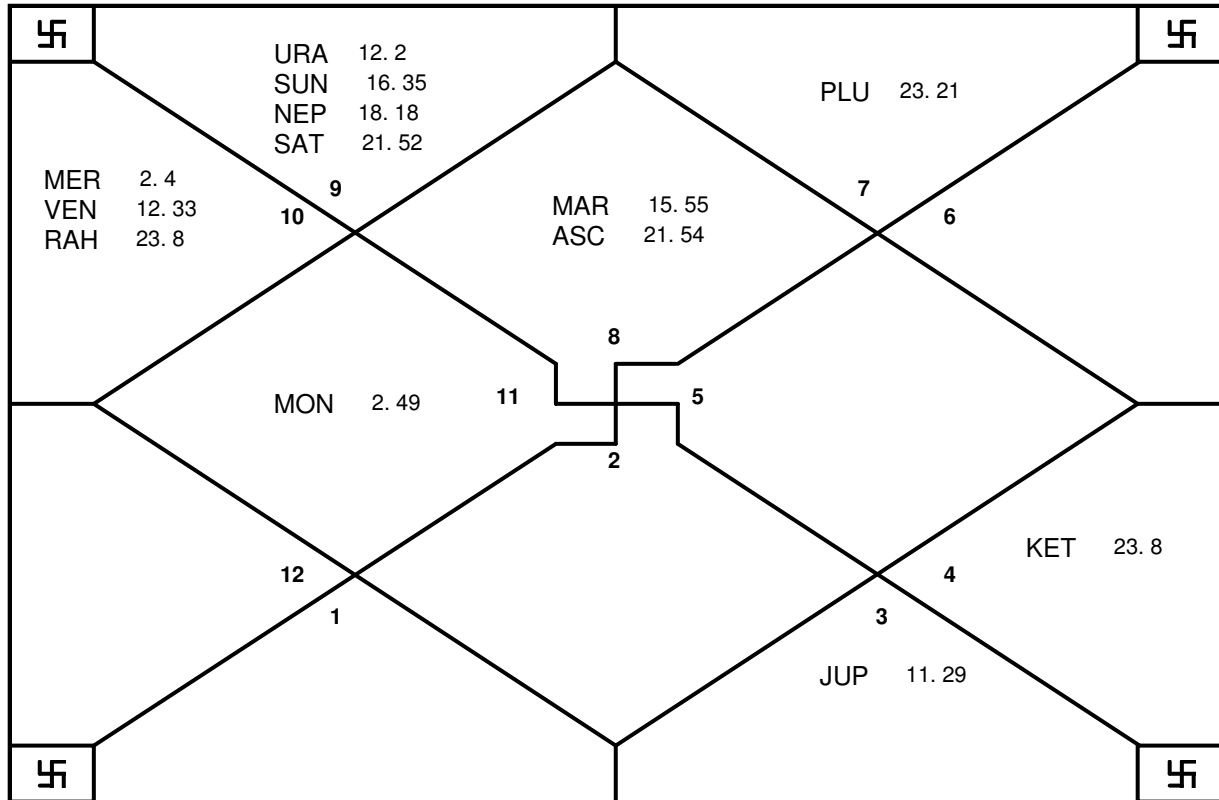

Sample

**KARAKA, AVASTHA**

PLANET	KARAKA		AVASTHA	
	CHAR	STHIR	BALADI	SHYANADI
SUN	AMATYA	PITRA	YUVA	SABHA
MON	GNATI	MATRA	BALAK	SABHA
MAR	BHATR	BHRATRA	YUVA	NIDRA
MER	DARA	GNATI	MRIT	NETRAPANI
JUP	PUTRA	DHAN	KUMAR	BHOJANA
VEN	MATRA	KALATRA	YUVA	NETRAPANI
SAT	AATMA	AYUSH	VRIDH	KAUTUKA
RAH		GYAN	KUMAR	KAUTUKA
KET		MOKSH	KUMAR	NIDRA

**TARA CHAKRA**

JANMA	SAMPAT	VIPAT	KSHEM	PRATYRI	SADHAK	VADH	MITRA	ATIMITRA/
DHANISH	SATABHI	P.BHADR	U.BHADR	REVATI	ASHWINI	BHARANI	KRITTIK	ROHINI
MRIGASI	ARDRA	PUNARVA	PUSHYA	ASLESA	MAGHA	P.PHALG	U.PHALG	HASTA
CHITRA	SVATI	VISAKHA	ANURADH	JYESTHA	MOOLA	P.ASADH	U.ASADH	SRAVANA

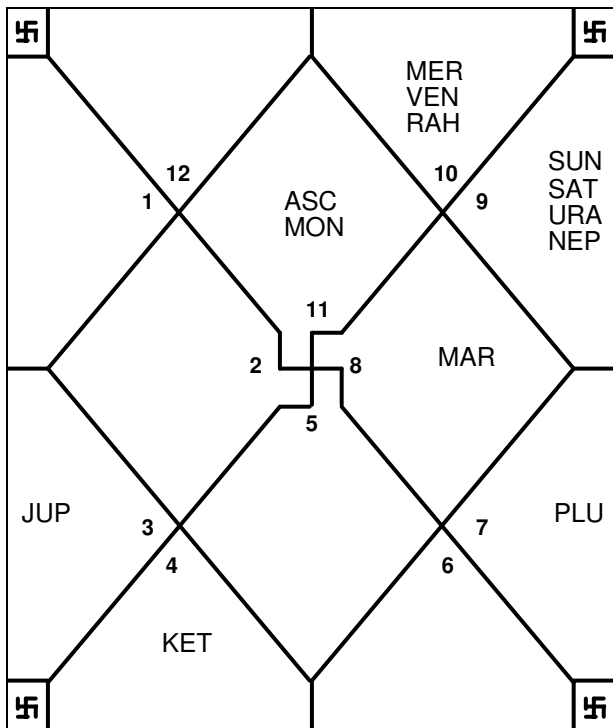
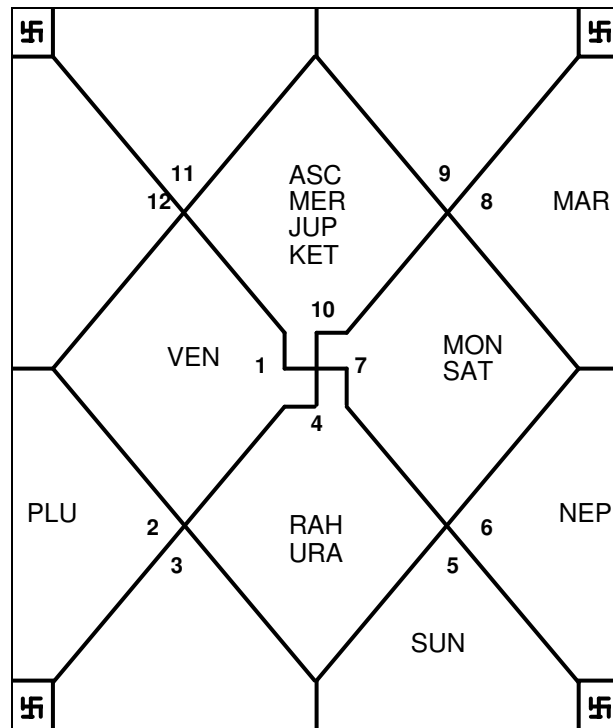
**MOON CHART****NAVAMSA****Triple-S Software**Website:-<http://www.horosoft.net>Email:[sales@horosoft.net](mailto:sales@horosoft.net) , [horosoft@yahoo.com](mailto:horosoft@yahoo.com)

Sample

**BHAVA**

BHAVA	ARAMBHA		MADHYA		ANTYA	
FIRST	SCORPIO	8 52	SCORPIO	21 54	SAGITTARIUS	8 52
SECOND	SAGITTARIUS	8 52	SAGITTARIUS	25 49	CAPRICORN	12 47
THIRD	CAPRICORN	12 47	CAPRICORN	29 44	AQUARIUS	16 42
FOURTH	AQUARIUS	16 42	PISCES	3 39	PISCES	16 42
FIFTH	PISCES	16 42	PISCES	29 44	ARIES	12 47
SIXTH	ARIES	12 47	ARIES	25 49	TAURUS	8 52
SEVENTH	TAURUS	8 52	TAURUS	21 54	GEMINI	8 52
EIGHTH	GEMINI	8 52	GEMINI	25 49	CANCER	12 47
NINTH	CANCER	12 47	CANCER	29 44	LEO	16 42
TENTH	LEO	16 42	VIRGO	3 39	VIRGO	16 42
ELEVENTH	VIRGO	16 42	VIRGO	29 44	LIBRA	12 47
TWELFTH	LIBRA	12 47	LIBRA	25 49	SCORPIO	8 52

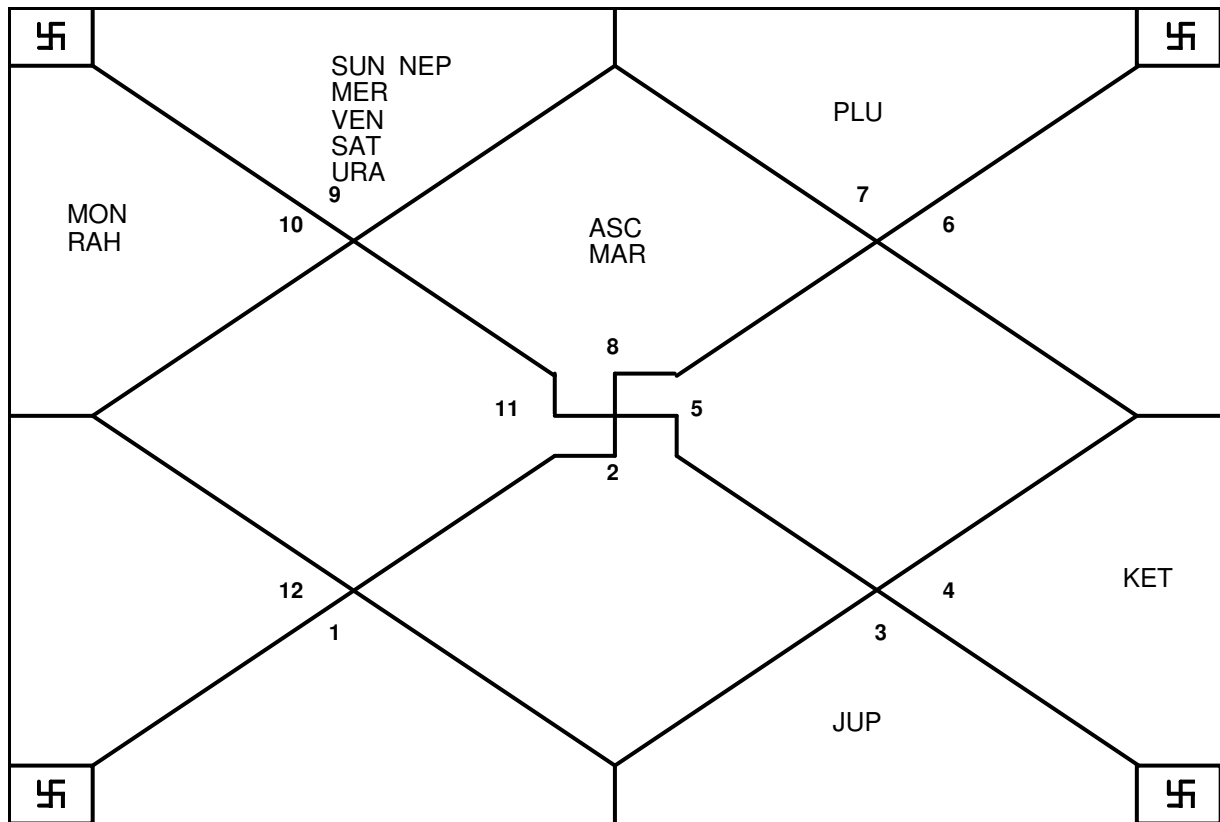
**BHAVA (CHALIT)****Triple-S Software**Website: -<http://www.horosoft.net>Email: [sales@horosoft.net](mailto:sales@horosoft.net) , [horosoft@yahoo.com](mailto:horosoft@yahoo.com)

# SHODASHVARGA

**LAGAN CHART**

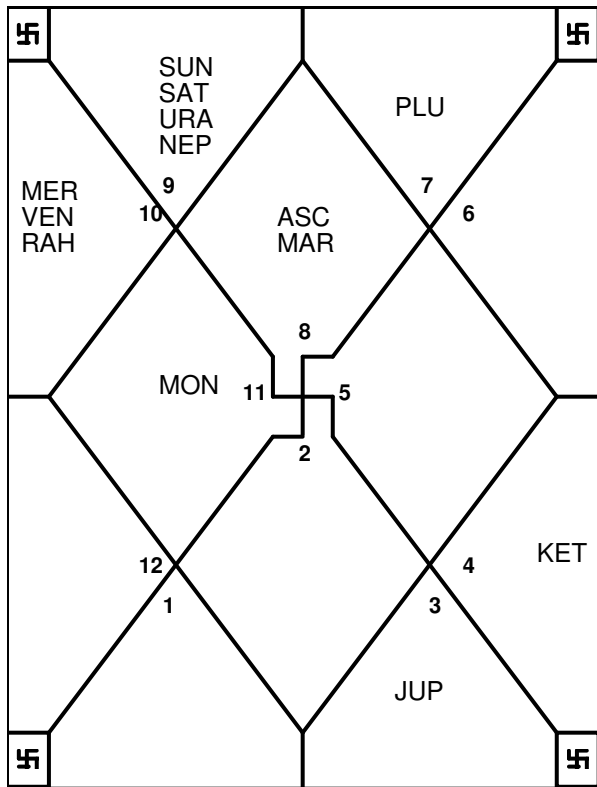

**HORA (FOR WEALTH)**

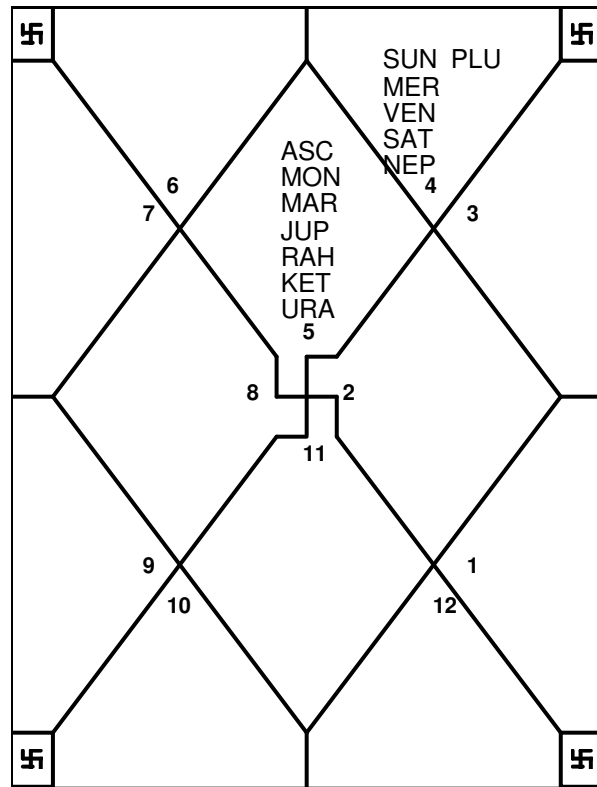

**DRESHKANA (BROTHERS AND SISTERS)**

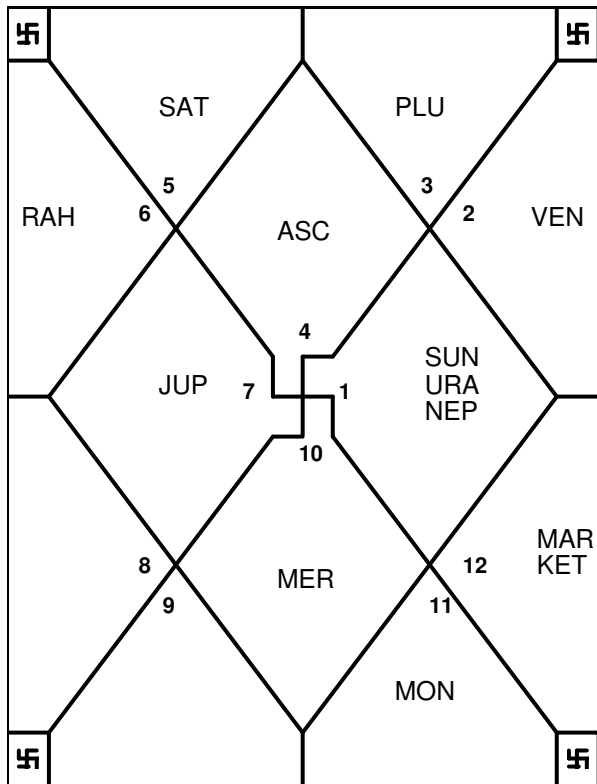

**CHATURTHAMSA (FOR FORTUNES)**

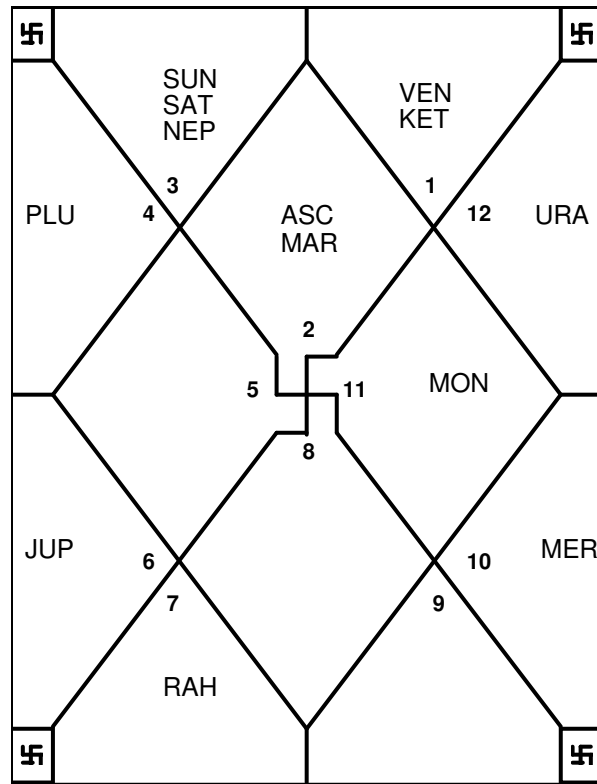

# SHODASHVARGA

**SAPTAMSA (FOR CHILDREN)**

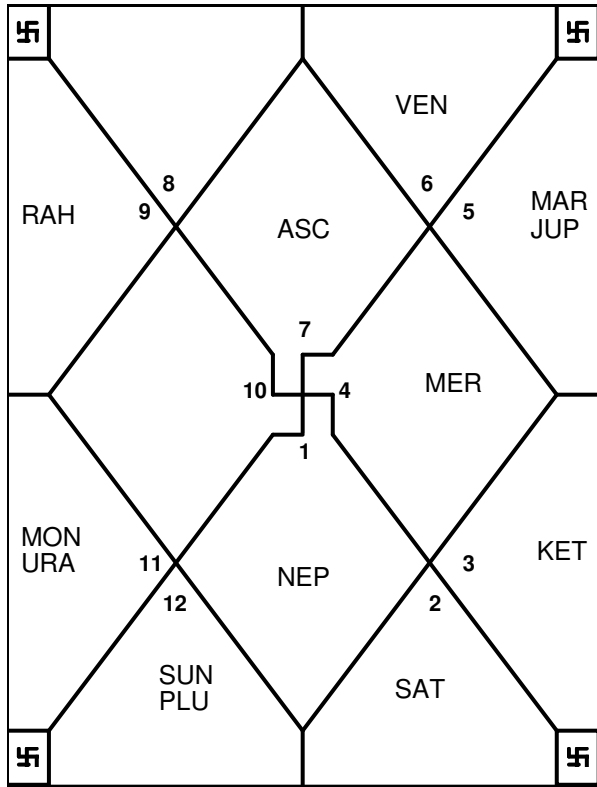

**NAVAMSA**

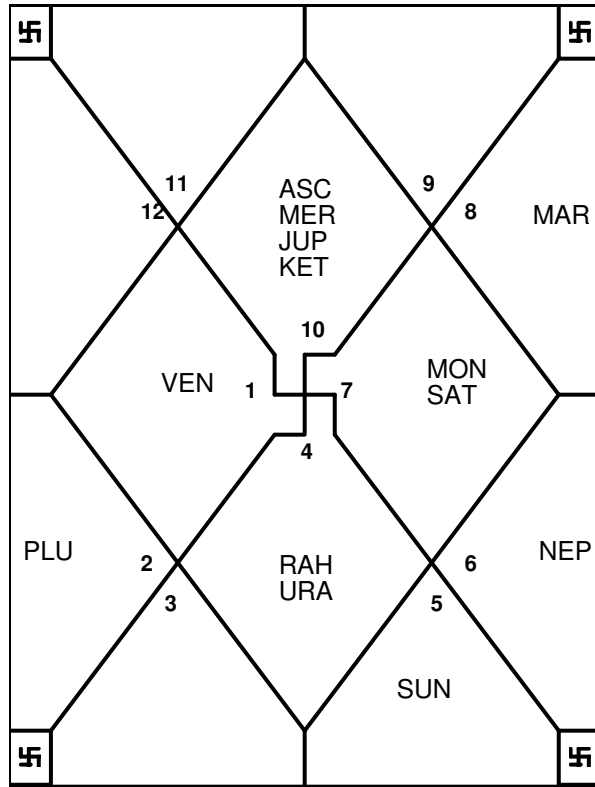

**DASAMSA (FOR LIVELIHOODS)**

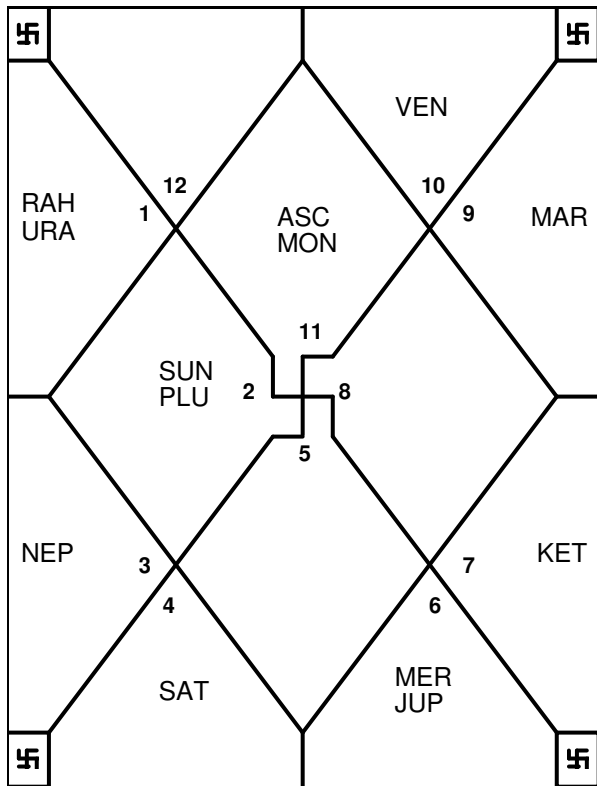

**DWADASAMSA (FOR PARENTS)**

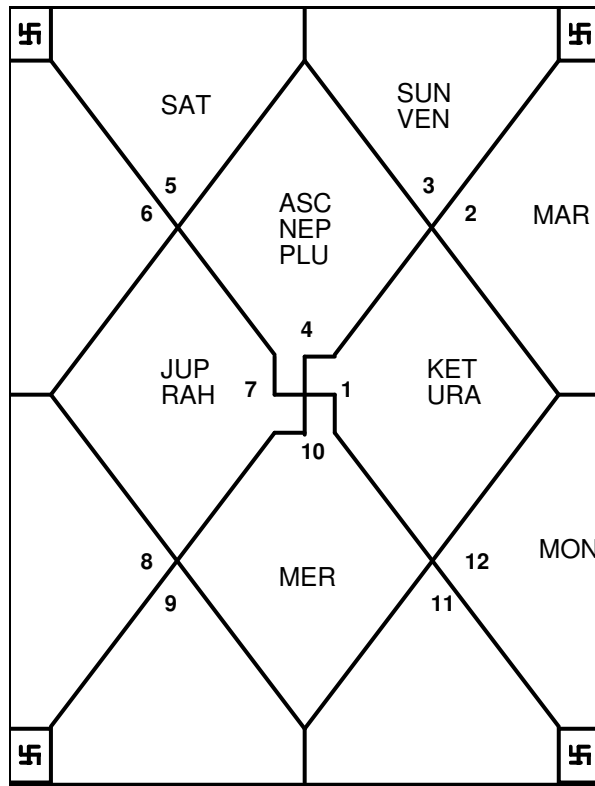

# SHODASHVARGA

**SHODASAMSA (FOR CONVEYANCE)**

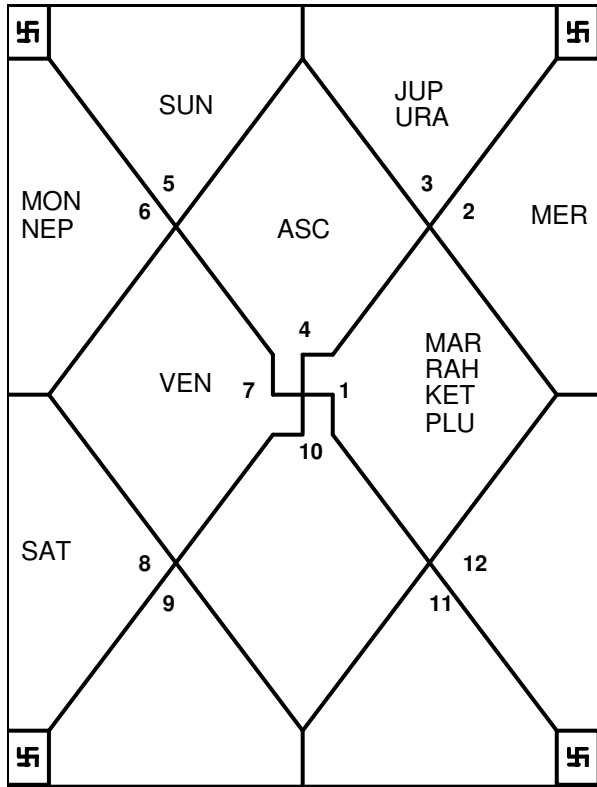

**VIMSAMSA (FOR WORSHIP)**

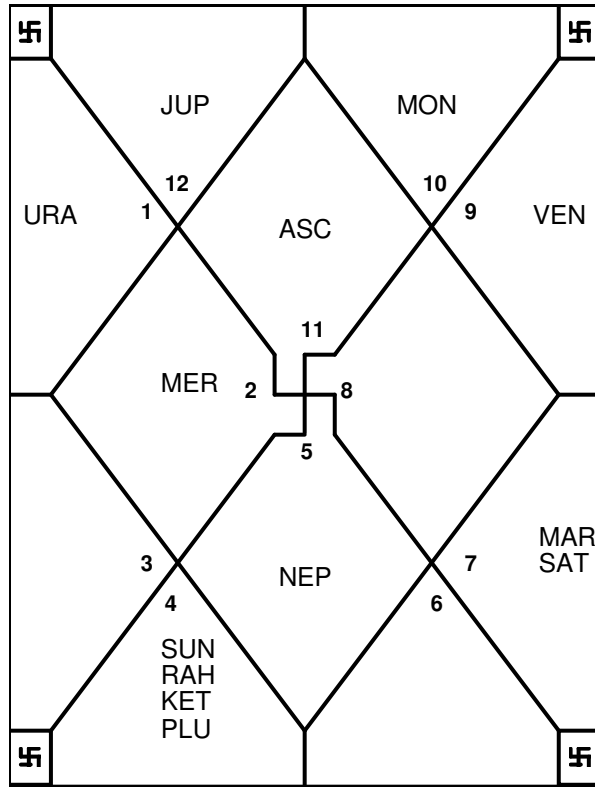

**CHATURVIMSAMSA (FOR EDUCATION)**

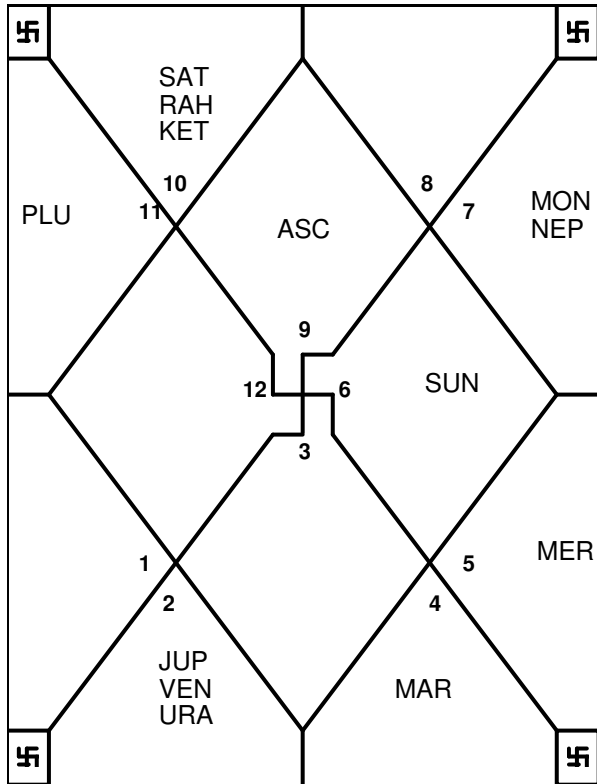

**SAPTAVIMSAMSA (FOR STRENGTH)**

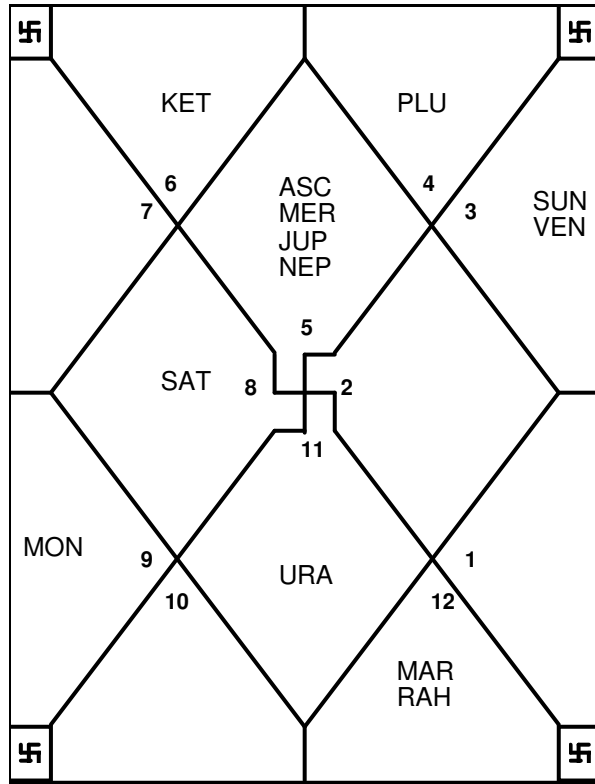



# SHODASHVARGA

**TRIMSAMSA (FOR MISERIES)**

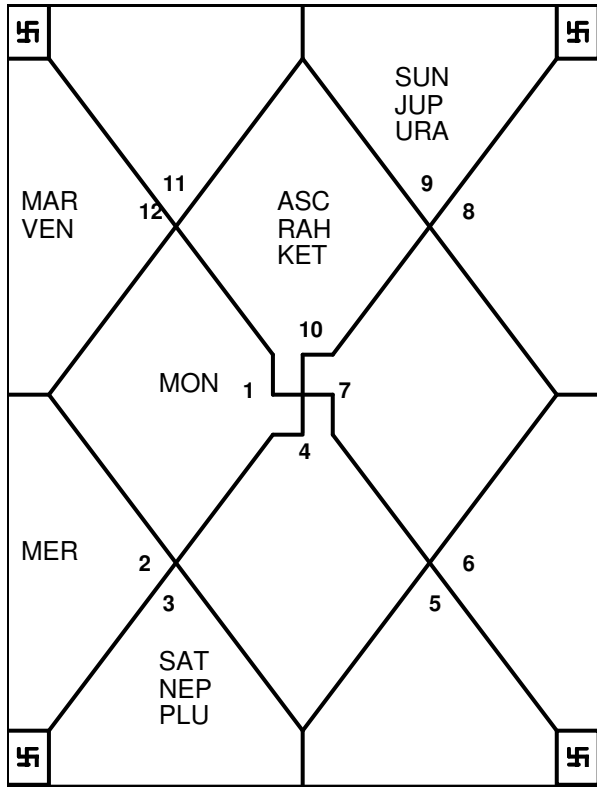

**KHAVEDAMSA (GOOD AND BAD PERIODS)**

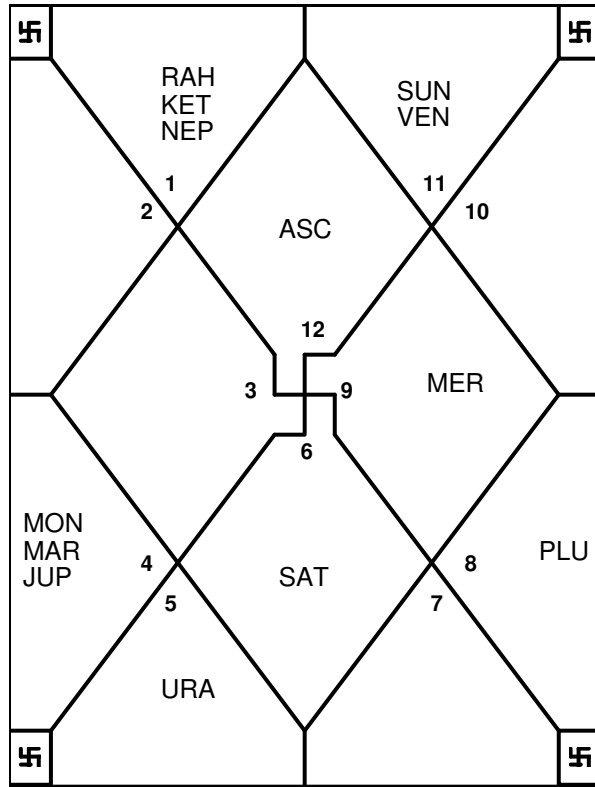

**AKSHAVEDAMSA ( ALL CONDITIONS)**

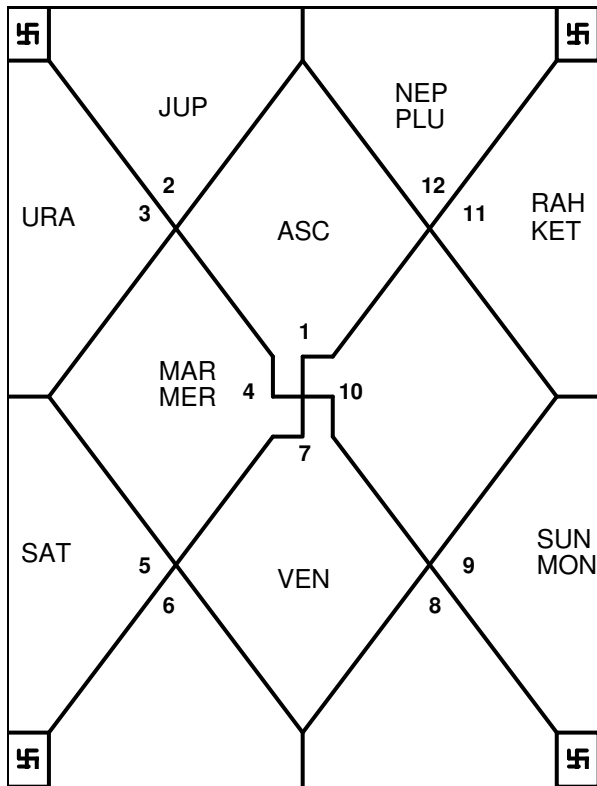

**SHASTIAMSA (FOR ALL CONDITIONS)**

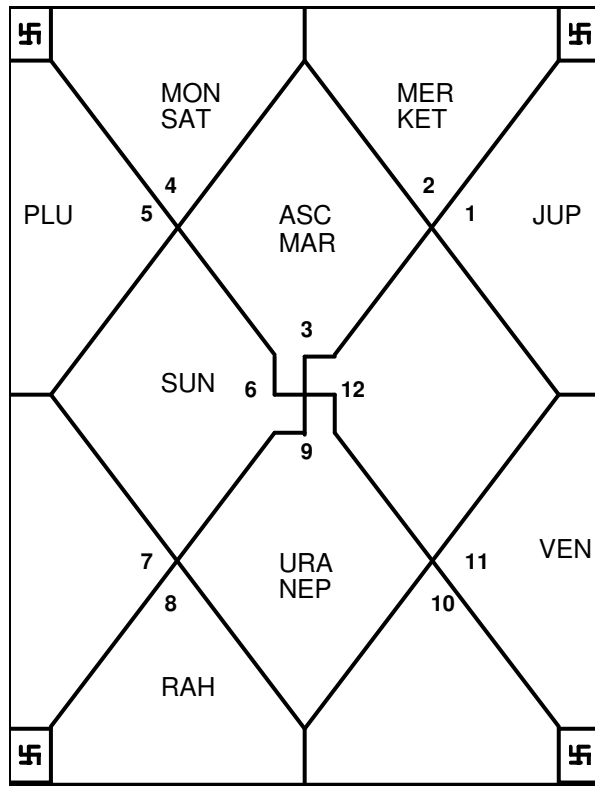

## VIMSOTTARI DASA

### MAR 7 YEAR

MAR	00/00/0000 - 00/00/0000
RAH	00/00/0000 - 00/00/0000
JUP	00/00/0000 - 00/00/0000
SAT	00/00/0000 - 00/00/0000
MER	00/00/0000 - 00/00/0000
KET	00/00/0000 - 00/00/0000
VEN	01/01/1990 - 31/01/1991
SUN	31/01/1991 - 08/06/1991
MON	08/06/1991 - 07/01/1992

### RAH 18 YEAR

RAH	07/01/1992 - 19/09/1994
JUP	19/09/1994 - 12/02/1997
SAT	12/02/1997 - 20/12/1999
MER	20/12/1999 - 08/07/2002
KET	08/07/2002 - 27/07/2003
VEN	27/07/2003 - 27/07/2006
SUN	27/07/2006 - 21/06/2007
MON	21/06/2007 - 19/12/2008
MAR	19/12/2008 - 07/01/2010

### JUP 16 YEAR

JUP	07/01/2010 - 25/02/2012
SAT	25/02/2012 - 07/09/2014
MER	07/09/2014 - 13/12/2016
KET	13/12/2016 - 19/11/2017
VEN	19/11/2017 - 20/07/2020
SUN	20/07/2020 - 08/05/2021
MON	08/05/2021 - 07/09/2022
MAR	07/09/2022 - 14/08/2023
RAH	14/08/2023 - 07/01/2026

### SAT 19 YEAR

SAT	07/01/2026 - 10/01/2029
MER	10/01/2029 - 20/09/2031
KET	20/09/2031 - 29/10/2032
VEN	29/10/2032 - 29/12/2035
SUN	29/12/2035 - 10/12/2036
MON	10/12/2036 - 12/07/2038
MAR	12/07/2038 - 21/08/2039
RAH	21/08/2039 - 27/06/2042
JUP	27/06/2042 - 07/01/2045

### MER 17 YEAR

MER	07/01/2045 - 06/06/2047
KET	06/06/2047 - 02/06/2048
VEN	02/06/2048 - 03/04/2051
SUN	03/04/2051 - 07/02/2052
MON	07/02/2052 - 08/07/2053
MAR	08/07/2053 - 06/07/2054
RAH	06/07/2054 - 22/01/2057
JUP	22/01/2057 - 30/04/2059
SAT	30/04/2059 - 07/01/2062

### KET 7 YEAR

KET	07/01/2062 - 05/06/2062
VEN	05/06/2062 - 05/08/2063
SUN	05/08/2063 - 11/12/2063
MON	11/12/2063 - 11/07/2064
MAR	11/07/2064 - 07/12/2064
RAH	07/12/2064 - 26/12/2065
JUP	26/12/2065 - 02/12/2066
SAT	02/12/2066 - 11/01/2068
MER	11/01/2068 - 07/01/2069

### VEN 20 YEAR

VEN	07/01/2069 - 08/05/2072
SUN	08/05/2072 - 09/05/2073
MON	09/05/2073 - 07/01/2075
MAR	07/01/2075 - 09/03/2076
RAH	09/03/2076 - 09/03/2079
JUP	09/03/2079 - 07/11/2081
SAT	07/11/2081 - 07/01/2085
MER	07/01/2085 - 08/11/2087
KET	08/11/2087 - 07/01/2089

### SUN 6 YEAR

SUN	07/01/2089 - 27/04/2089
MON	27/04/2089 - 26/10/2089
MAR	26/10/2089 - 03/03/2090
RAH	03/03/2090 - 26/01/2091
JUP	26/01/2091 - 14/11/2091
SAT	14/11/2091 - 26/10/2092
MER	26/10/2092 - 01/09/2093
KET	01/09/2093 - 07/01/2094
VEN	07/01/2094 - 07/01/2095

### MON 10 YEAR

MON	07/01/2095 - 07/11/2095
MAR	07/11/2095 - 07/06/2096
RAH	07/06/2096 - 07/12/2097
JUP	07/12/2097 - 08/04/2099
SAT	08/04/2099 - 07/11/2100
MER	07/11/2100 - 09/04/2102
KET	09/04/2102 - 08/11/2102
VEN	08/11/2102 - 08/07/2104
SUN	08/07/2104 - 07/01/2105

(Pratyantar)

**VIMSOTTARI DASA****JUP - JUP**

JUP	07/01/2010 - 21/04/2010
SAT	21/04/2010 - 22/08/2010
MER	22/08/2010 - 11/12/2010
KET	11/12/2010 - 25/01/2011
VEN	25/01/2011 - 04/06/2011
SUN	04/06/2011 - 13/07/2011
MON	13/07/2011 - 16/09/2011
MAR	16/09/2011 - 31/10/2011
RAH	31/10/2011 - 25/02/2012

**JUP - SAT**

SAT	25/02/2012 - 21/07/2012
MER	21/07/2012 - 29/11/2012
KET	29/11/2012 - 22/01/2013
VEN	22/01/2013 - 25/06/2013
SUN	25/06/2013 - 10/08/2013
MON	10/08/2013 - 26/10/2013
MAR	26/10/2013 - 19/12/2013
RAH	19/12/2013 - 07/05/2014
JUP	07/05/2014 - 07/09/2014

**JUP - MER**

MER	07/09/2014 - 03/01/2015
KET	03/01/2015 - 20/02/2015
VEN	20/02/2015 - 08/07/2015
SUN	08/07/2015 - 18/08/2015
MON	18/08/2015 - 26/10/2015
MAR	26/10/2015 - 14/12/2015
RAH	14/12/2015 - 16/04/2016
JUP	16/04/2016 - 04/08/2016
SAT	04/08/2016 - 13/12/2016

**JUP - KET**

KET	13/12/2016 - 02/01/2017
VEN	02/01/2017 - 28/02/2017
SUN	28/02/2017 - 17/03/2017
MON	17/03/2017 - 15/04/2017
MAR	15/04/2017 - 04/05/2017
RAH	04/05/2017 - 25/06/2017
JUP	25/06/2017 - 09/08/2017
SAT	09/08/2017 - 02/10/2017
MER	02/10/2017 - 19/11/2017

**JUP - VEN**

VEN	19/11/2017 - 01/05/2018
SUN	01/05/2018 - 18/06/2018
MON	18/06/2018 - 07/09/2018
MAR	07/09/2018 - 03/11/2018
RAH	03/11/2018 - 29/03/2019
JUP	29/03/2019 - 06/08/2019
SAT	06/08/2019 - 07/01/2020
MER	07/01/2020 - 24/05/2020
KET	24/05/2020 - 20/07/2020

**JUP - SUN**

SUN	20/07/2020 - 04/08/2020
MON	04/08/2020 - 28/08/2020
MAR	28/08/2020 - 14/09/2020
RAH	14/09/2020 - 28/10/2020
JUP	28/10/2020 - 06/12/2020
SAT	06/12/2020 - 21/01/2021
MER	21/01/2021 - 04/03/2021
KET	04/03/2021 - 21/03/2021
VEN	21/03/2021 - 08/05/2021

**JUP - MON**

MON	08/05/2021 - 18/06/2021
MAR	18/06/2021 - 16/07/2021
RAH	16/07/2021 - 28/09/2021
JUP	28/09/2021 - 01/12/2021
SAT	01/12/2021 - 17/02/2022
MER	17/02/2022 - 27/04/2022
KET	27/04/2022 - 25/05/2022
VEN	25/05/2022 - 14/08/2022
SUN	14/08/2022 - 07/09/2022

**JUP - MAR**

MAR	07/09/2022 - 27/09/2022
RAH	27/09/2022 - 18/11/2022
JUP	18/11/2022 - 02/01/2023
SAT	02/01/2023 - 25/02/2023
MER	25/02/2023 - 14/04/2023
KET	14/04/2023 - 04/05/2023
VEN	04/05/2023 - 30/06/2023
SUN	30/06/2023 - 17/07/2023
MON	17/07/2023 - 14/08/2023

**JUP - RAH**

RAH	14/08/2023 - 24/12/2023
JUP	24/12/2023 - 19/04/2024
SAT	19/04/2024 - 05/09/2024
MER	05/09/2024 - 07/01/2025
KET	07/01/2025 - 27/02/2025
VEN	27/02/2025 - 23/07/2025
SUN	23/07/2025 - 05/09/2025
MON	05/09/2025 - 17/11/2025
MAR	17/11/2025 - 07/01/2026

**FRIENDSHIP****PERMANENT**

	SUN	MON	MAR	MER	JUP	VEN	SAT	RAH	KET
SUN	--	FRIEND	FRIEND	NEUTRAL	FRIEND	ENEMY	ENEMY	ENEMY	ENEMY
MON	FRIEND	--	NEUTRAL	FRIEND	NEUTRAL	NEUTRAL	NEUTRAL	ENEMY	ENEMY
MAR	FRIEND	FRIEND	--	ENEMY	FRIEND	NEUTRAL	NEUTRAL	ENEMY	FRIEND
MER	FRIEND	ENEMY	NEUTRAL	--	NEUTRAL	FRIEND	NEUTRAL	NEUTRAL	NEUTRAL
JUP	FRIEND	FRIEND	FRIEND	ENEMY	--	ENEMY	NEUTRAL	NEUTRAL	NEUTRAL
VEN	ENEMY	ENEMY	NEUTRAL	FRIEND	NEUTRAL	--	FRIEND	FRIEND	FRIEND
SAT	ENEMY	ENEMY	ENEMY	FRIEND	NEUTRAL	FRIEND	--	FRIEND	ENEMY
RAH	ENEMY	ENEMY	ENEMY	NEUTRAL	NEUTRAL	FRIEND	FRIEND	--	ENEMY
KET	ENEMY	ENEMY	FRIEND	NEUTRAL	NEUTRAL	FRIEND	ENEMY	ENEMY	--

**TEMPORARY**

	SUN	MON	MAR	MER	JUP	VEN	SAT	RAH	KET
SUN	--	FRIEND	FRIEND	FRIEND	ENEMY	FRIEND	ENEMY	FRIEND	ENEMY
MON	FRIEND	--	FRIEND	FRIEND	ENEMY	FRIEND	FRIEND	FRIEND	ENEMY
MAR	FRIEND	FRIEND	--	FRIEND	ENEMY	FRIEND	FRIEND	FRIEND	ENEMY
MER	FRIEND	FRIEND	FRIEND	--	ENEMY	ENEMY	FRIEND	ENEMY	ENEMY
JUP	ENEMY	ENEMY	ENEMY	ENEMY	--	ENEMY	ENEMY	ENEMY	FRIEND
VEN	FRIEND	FRIEND	FRIEND	ENEMY	ENEMY	--	FRIEND	ENEMY	ENEMY
SAT	ENEMY	FRIEND	FRIEND	FRIEND	ENEMY	FRIEND	--	FRIEND	ENEMY
RAH	FRIEND	FRIEND	FRIEND	ENEMY	ENEMY	ENEMY	FRIEND	--	ENEMY
KET	ENEMY	ENEMY	ENEMY	ENEMY	FRIEND	ENEMY	ENEMY	ENEMY	--

**FIVE-FOLD**

	SUN	MON	MAR	MER	JUP	VEN	SAT	RAH	KET
SUN	--	INTMATE	INTMATE	FRIEND	NEUTRAL	NEUTRAL	BITTER	NEUTRAL	BITTER
MON	INTMATE	--	FRIEND	INTMATE	ENEMY	FRIEND	FRIEND	NEUTRAL	BITTER
MAR	INTMATE	INTMATE	--	NEUTRAL	NEUTRAL	FRIEND	FRIEND	NEUTRAL	NEUTRAL
MER	INTMATE	NEUTRAL	FRIEND	--	ENEMY	NEUTRAL	FRIEND	ENEMY	ENEMY
JUP	NEUTRAL	NEUTRAL	NEUTRAL	BITTER	--	BITTER	ENEMY	ENEMY	FRIEND
VEN	NEUTRAL	NEUTRAL	FRIEND	NEUTRAL	ENEMY	--	INTMATE	NEUTRAL	NEUTRAL
SAT	BITTER	NEUTRAL	NEUTRAL	INTMATE	ENEMY	INTMATE	--	INTMATE	BITTER
RAH	NEUTRAL	NEUTRAL	NEUTRAL	ENEMY	ENEMY	NEUTRAL	INTMATE	--	BITTER
KET	BITTER	BITTER	NEUTRAL	ENEMY	FRIEND	NEUTRAL	BITTER	BITTER	--

Sample

**ASHTAKAVARGA TABLES**

	ARI	TAU	GEM	CAN	LEO	VIR	LIB	SCO	SAG	CAP	AQU	PIS	SUM
SUN	3	2	5	5	4	5	5	4	6	3	3	3	48
MON	7	5	2	5	4	5	4	3	3	4	3	4	49
MAR	4	4	4	2	4	4	2	5	4	1	2	3	39
MER	4	6	4	3	5	6	3	7	5	4	3	4	54
JUP	4	5	6	3	5	6	4	5	5	3	6	4	56
VEN	5	3	3	4	2	6	6	4	2	5	5	7	52
SAT	5	2	3	2	3	4	5	4	4	3	2	2	39
ASC	6	3	2	2	4	6	4	6	3	4	5	4	49
Total	38	30	29	26	31	42	33	38	32	27	29	31	386
Total (WITHOUT LAGAN)	32	27	27	24	27	36	29	32	29	23	24	27	337

**REDUCED ASHTAKAVARGA TABLES**

	ARI	TAU	GEM	CAN	LEO	VIR	LIB	SCO	SAG	CAP	AQU	PIS	SUM
SUN	0	0	2	2	1	2	2	1	3	1	0	0	14
MON	4	1	0	2	1	1	1	0	0	0	1	1	12
MAR	0	3	2	0	0	2	0	3	0	0	0	1	11
MER	0	2	1	0	1	1	0	4	1	0	0	0	10
JUP	0	2	2	0	1	2	0	2	1	0	2	0	12
VEN	3	0	0	0	0	3	3	0	0	2	2	3	16
SAT	0	0	1	0	0	1	3	2	1	1	0	0	9
ASC	0	0	0	0	1	3	2	4	0	1	3	2	16

**PIND**

	SUN	MON	MAR	MER	JUP	VEN	SAT
RASI PIND	98	91	92	84	103	125	64
GRAH PIND	70	5	44	52	56	34	48
SODYA PIND	168	96	136	136	159	159	112

**Triple-S Software**Website:-<http://www.horosoft.net>

Email:sales@horosoft.net , horosoft@yahoo.com

Sample

**COMPATIBLE TABLE**

TO SEE YOUR COMPATIBILITY WITH YOUR (PROPOSED) SPOUSE, PLEASE LOOK UP HIS/HER NAKSHTRA AND PAD IN THE GIVEN TABLE FOR GUNAS AND DOSH

NAKSHATRA	PAD	GUN	DOSH NO.	RESULT
ASHWINI	1 - 4	20		MEDIUM.
BHARANI	1 - 4	10	1,3,2	NOT GOOD.
KRITTIKA	1 - 1	25		MEDIUM.
KRITTIKA	2 - 4	29		GOOD.
ROHINI	1 - 4	25	-1	MEDIUM.
MRIGASIRAS	1 - 2	18	3	NOT GOOD.
MRIGASIRAS	3 - 4	12	3,5	NOT GOOD.
ARDRA	1 - 4	19	1,+5	MEDIUM.
PUNARVASU	1 - 3	19	+5	MEDIUM.
PUNARVASU	4 - 4	12	6	NOT GOOD.
PUSHYA	1 - 4	04	3,6	NOT GOOD.
ASLESA	1 - 4	17	6	NOT GOOD.
MAGHA	1 - 4	24		MEDIUM.
P.PHALGUNI	1 - 4	10	1,3	NOT GOOD.
U.PHALGUNI	1 - 1	18	1	NOT GOOD.
U.PHALGUNI	2 - 4	17	-1,6	NOT GOOD.
HASTA	1 - 4	16	-6	NOT GOOD.
CHITRA	1 - 2	16	3,6	NOT GOOD.
CHITRA	3 - 4	18	3,5	NOT GOOD.
SVATI	1 - 4	21	+5	MEDIUM.
VISAKHA	1 - 3	24	+5	MEDIUM.
VISAKHA	4 - 4	24		MEDIUM.
ANURADHA	1 - 4	11	3	NOT GOOD.
JYESTHA	1 - 4	24		MEDIUM.
MOOLA	1 - 4	29		GOOD.
P.ASADHA	1 - 4	15	1,3	NOT GOOD.
U.ASADHA	1 - 1	23	1	MEDIUM.
U.ASADHA	2 - 4	16	+1,4	NOT GOOD.
SRAVANA	1 - 4	17	0,4	NOT GOOD.
DHANISHTHA	1 - 2	17	3,4	NOT GOOD.
DHANISHTHA	3 - 4	28	3	MEDIUM.
SATABHISAJ	1 - 4	33		GOOD.
P.BHADRAPAD	1 - 3	20	-1	MEDIUM.
P.BHADRAPAD	4 - 4	16	1,4	NOT GOOD.
U.BHADRAPAD	1 - 4	06	1,3,4	NOT GOOD.
REVATI	1 - 4	14	4,2	NOT GOOD.

**FAULT LEGEND**

0 RANDRA DOSH : 1 GAN MAHA DOSH : 2 YONI VAR DOSH

3 NADI DOSH : 4 DVIDVA DOSH : 5 NAVPANCH DOSH : 6 BHAKUT DOSH

**Triple-S Software**

Website:-<http://www.horosoft.net>

Email:sales@horosoft.net , horosoft@yahoo.com

## GENERAL CHARACTERISTICS

---

### SCORPIO IS YOUR LAGAN SIGN

You are born in Scorpio ascendent. Scorpio is the 8th sign of the zodiac. You have a healthy body, broad chest and sound eyes. You are extremely clever. You may face opposition from your brothers. You are very in-compassionate and hard-hearted. You refrain from speaking the truth in case it serves your interest. You are able to read other people's mind. You are fond of astrology. You would have had some sufferings in the early part of your life but will enjoy a lot of happiness in the later part of life. You will have a long life. You are reserved and hot-tempered. You are very ambitious and will use many ways to prosper. Your character is susceptible. You are rude and very authoritative. You will rise even in adverse circumstances. You are always active and don't like to remain idle. You will work very hard till you achieve your goal. You have a good imagination. You are forceful and victorious. You may have mental worries and tensions. You are prone to the disease relating brain. You may suffer from inflammation, injuries, burns, falls or accidents. You are very good in doing research. You are sensual and are fond of beauty. You are practical and don't accept things unless they are proved. You are very broad-minded and open to all kinds of ideas but respect your family customs. You always put off things till the last moment. You progress in your projects by your laborious and intellectual deeds. You possess an angry temperament. You are a competent sports-person.

As you were born in Dhanistha nakshatra you will be fond of music be generous, rich, valiant, wealthy, respected and loved by your spouse. You will be brave and will have great love for your brothers and relatives. The lucky years in your life are the 15th, 23rd, and 29th years.

### INFLUENCE OF PLANET SUN

Master of the 10th house, Sun in the 2nd house indicates that you may own land and property, acquire wealth and are regarded with esteem and respect. You are an important member of the family. You earn through your business/occupation. You do grand deeds, use your full strength to earn wealth and research deeply in old and serious things and inherit gains. You are a learned man. Your eyes may be affected and you may suffer from disease of the face.

Sun in the 2nd house shows you will be generous but extravagant. You will not have a good complexion. You will have eye troubles. You will be rash and will waste a lot of money.

Sun in Sagittarius: You gamble and have criminal tendencies. You satisfy your desires. You are idealistic, moral and avoid quarrels. You will intervene on behalf of others. You are a good conversationalist and are an interesting

## GENERAL CHARACTERISTICS

---

narrator. You are quick, witty, proud and self independent. There will be an increase of self earned wealth, power, position, fame and political success.

### INFLUENCE OF PLANET MOON

Master of the 9th house, Moon in the 4th indicates that you are religiously inclined and of a charitable disposition. Active and energetic, you will devote considerable time towards helping your friends and the poor and needy. You are wise and combined with the powers of destiny. You will enjoy fame and wealth. You are respectful towards your elders, hard working and diligent.

Moon in 4th house: Your mother will have a long life. You will build a nice house and will own many vehicles. You will like to shift your residence very often. You will have a fortune in land and agriculture. You will be over indulgent in physical pleasures. You will be famous and popular. You will perform virtuous and benevolent deeds.

Moon in Aquarius: you are of medium stature, having hands full of hair, a prominent neck and bones, large thighs and feet and a black mole or mark either on your face or armpit or leg. You are obliging, clever, active, loving but deceitful. You will have clandestine affairs. You are fond of perfumes, flowers, travelling and friends. You are strong in daytime. The 3rd, 8th and 13th Hindu "tithis" are bad for you whereas Saturdays are lucky for you. You may suffer from a cough. You may have an accident in water. You will join a secret society and/or a recreation society. You are interested in education, astrology, science and politics.

### INFLUENCE OF PLANET MARS

Mars in 1st house: You enjoy the company of the opposite sex, are gallant and have immense wealth and property. You have a brown complexion. You have a sound constitution. You have brown eyes and a peevish nature. You have rash tendencies. You suffer from ill-health and indulge in in-compassionate acts. There will be journeys, wanderings and body injuries.

Mars in Scorpio: you are a competent businessperson. You will have some bad associates who will cause you great harm. You suffer from eye trouble. You have a limited number of issues. Your body may be afflicted. You face obstacles in whatever efforts you make for betterment.

### INFLUENCE OF PLANET MERCURY

Master of the 8th and 11th house Mercury in the 3rd house indicates that you will suffer from ill-health and will feel very weak. Friends and brothers will oppose you. You will elevate the name of your family. You will be fortunate



## GENERAL CHARACTERISTICS

---

and popular. You will be energetic and tactful. You are also very secretive. Mercury in 3rd house: You are cunning, have knowledge of astrology, are interested in occultism, are fond of physical pleasures. You like cosmetics and sweet fruits. Your life is comfortable. Your voice is subdued. Mercury causes birth of brothers. Sometimes you feel weak, fatigued and unhappy. You will travel. You will have good brothers and sisters, will be hard working and will have good connections with businessperson. You will love the opposite sex. Your handwriting is good. You enhance your wealth through travels. Sometimes you indulge with undesirable people.

Mercury in Capricorn: You are fearful and sometimes you may refrain from speaking the truth. There will be deficiency in family happiness.

### INFLUENCE OF PLANET JUPITER

Master of the 2nd and 5th house, Jupiter in the 8th house indicates that you will inherit money. You will work very hard to earn money. You may gain in speculations. Your mind will be wavering. You will face obstacles in acquiring education. You will have a lot of worries. You will feel very restless. You will not get happiness from your family and children.

Jupiter in 8th house: You will have a stout body and a long life. You should be careful of dysentery and asthma. Jupiter causes poverty, failure in attempts, loss of wealth, weak acts and sorrow.

Jupiter in Gemini: You have an interest in the sciences you enjoy sudden gain of wealth or fame. You are respected in family and society. You are a good writer and behave well with other people.

### INFLUENCE OF PLANET VENUS

Master of 7th and 12th house, Venus in 3rd house indicates that you will get unhappiness from sons. You are very strong. You are liked by your relatives. Your spouse is very passionate. Your spouse will have good relations with your brother. There may be disputes regarding paternal property and there may be separation from the family. You will not have regular meals. You pay a lot of attention to your health. You may get some unhappiness from your brothers and elders. You will live away from your brothers. You will spend for your sisters. Sometimes you will try to use wrong ways to earn money. You like to dress well. You will travel a lot. You prosper in foreign countries. You will rise in your life by your own efforts.

Venus in the 3rd house indicates that you are a very timid person. You are fond of poetry and literature. You will earn by your hard work and intelligence and will enjoy luxuries. You will be very fond of milk. You will most probably have a tense relationship with your spouse. You have a jovial nature. You will

## GENERAL CHARACTERISTICS

---

have many sisters and brothers. Venus in the 3rd house also causes hardships, poverty and misery. You will have children but will get unhappiness from them. You will be courageous. You will not be very wealthy. You will have good friends. You will be fond of luxuries.

Venus in Capricorn indicates that you are a careful spender. You may have heart trouble. You will get some deficiency in happiness and will give importance to your self-respect. You are very solemn and thoughtful.

### INFLUENCE OF PLANET SATURN

Master of 3rd and 4th house, Saturn in 2nd house indicates you are very strong and fortunate. You are respected in government and society. You are famous in your community. You feel some weakness and deficiency in the paternal wealth. You will have disputes with your relatives. You are a bit quarrelsome. You will have many children. You will earn huge wealth and honours. You can't keep money and spend and invest in properties. You are of a wavering mind. You get hindrances in acquiring political or social fame due to your instability of thoughts and policy. You are a moderate eater. You impress others through your work. You are an expert in getting your work done by your tactful and intellectual policy. You also spend for others. You help the needy and get pleasure. You do not care much for your spouse and hence there are quarrels in the house. You are happy from the occupation point of view. You are fond of doing big ventures. You are highly learned in shastras and philosophy. You collect wealth and spend for the welfare of family members. You are interested in wealth. You get hindrances in stability of wealth. You are very proud. You will acquire lands and property. You have a big family. Sometimes you have opposition of views with your father.

Saturn in 2nd house indicates you will most probably be dumb. Your spouse may get dog bites and will have sickness. You may suffer from eye troubles. There will be hindrances and obstacles in acquiring education. You will have quarrels with the opposite sex. Sometimes you get financial troubles and worries. You will be very good at flattering. Your teeth may be long and ugly. You are fond of spicy foods and like to take wine, fish and meat. Saturn also causes evil and criminal tendencies, misery, loss of wealth and health. You are attracted to the opposite sex. You may not be very good-looking. You will visit foreign countries and will earn wealth and enjoy many comforts. You may be separated from your family and will live far from your native place. You will have enough wealth. You will not be liked by people in high places.

Saturn in Sagittarius: you get fame through your children. You get happiness in later part of your life. You are very shrewd.

## GENERAL CHARACTERISTICS

---

### INFLUENCE OF PLANET RAHU

Rahu in 3rd house indicates you are very active and daring. There will be disputes and quarrels with brothers and neighbours. You are victorious and peevish. You will appear as a very simple person in public but actually you are very wealthy. You are laborious. You may be irregular in your meals. There may be ill-health or death of brothers and sisters. You will acquire high position and honours. You will progress by your daring deeds and earn huge wealth. You will enjoy many physical pleasures. You are a yogi and a bhogi. You feel some hindrances in acquiring progress in your occupation with brothers. You feel some hindrances and obstacles in acquiring education. You may suffer from ear troubles. You defeat your rivals by your mysterious and intricate policies. You travel to distant places and acquire gains. You are a bit carefree. You command many people. You are happy with wealth and other necessary things.

### INFLUENCE OF PLANET KETU

Ketu in the 9th house indicates that you will be henpecked by your spouse. You will manage the affairs of a town or village or will be the head of a project. You will travel to many places. You feel some deficiency in the happiness of brothers and friends. You enjoy high honours and fame in government, society and foreign countries. You are religious and kind-hearted. You may be defamed and get setbacks in honours and respect due to your bad associates. You are very sharp in your mental work. You are a competent speaker and very brave and give much importance to self-respect. You are strong and of a some what peculiar nature. There will be sudden gains.

## VARSH PHAL

PLANESIGN	DEGREE	NAKSHATRA	PAD	PLANETSIGN	DEGREE	NAKSHATRA	PAD		
ASC	SCORPIO	21 54 56	JYESTHA	2	ASC	CAPRICORN	06 08 26	U.ASADHA	3
SUN	SAGITTARIL	16 35 07	P.ASADHA	1	SUN	SAGITTARIUS	16 35 07	P.ASADHA	1
MON	AQUARIUS	02 49 37	DHANISHTHA	3	MON	GEMINI	21 09 09	PUNARVASU	1
MAR	SCORPIO	15 55 58	ANURADHA	4	MAR	CANCER	24 47 28	ASLESA	3
MER	CAPRICORN	02 04 13	U.ASADHA	2	MER	SAGITTARIUS	24 51 19	P.ASADHA	4
JUP	GEMINI	11 29 20	ARDRA	2	JUP	AQUARIUS	02 23 06	DHANISHTHA	3
VEN	CAPRICORN	12 33 26	SRAVANA	1	VEN	SAGITTARIUS	14 00 58	P.ASADHA	1
SAT	SAGITTARIL	21 52 54	P.ASADHA	3	SAT	VIRGO	10 30 17	HASTA	1
RAH	CAPRICORN	23 08 09	SRAVANA	4	RAH	SAGITTARIUS	27 04 27	U.ASADHA	1
KET	CANCER	23 08 09	ASLESA	2	KET	GEMINI	27 04 27	PUNARVASU	3

### LAGAN CHART

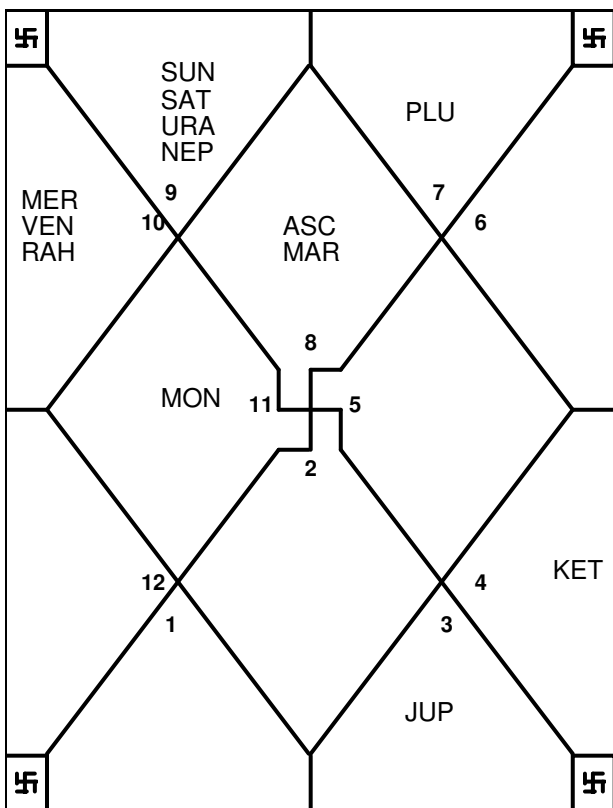

### VARSH LAGAN

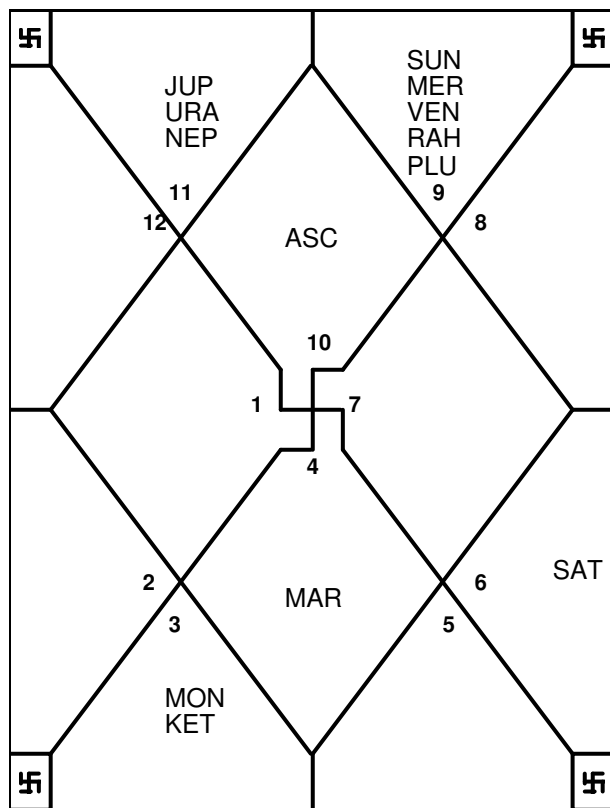

**IN THE VARSH LAGAN YOUR MUNTHA IS IN HOUSE NO. 7**

The first seven months are not too good and you and your spouse will suffer from physical ailments. You will lose money and shall face failure and disappointment. You will be tense and quarrelsome.

**01/01/2010-19/02/2010 IN THIS PERIOD YOU WILL BE UNDER JUP VARSHDASHA AND IN THE VARSHLAGAN JUP IS IN HOUSE NO. 2**

During this period, a substantial gain in income will be quite evident. You are inclined to sacrifice your money for the good of others, especially for family members. You will be popular among everybody. An increase in the family is also possible. You will be able to overcome your enemies. A gift or inheritance may come your way. Your taste of fine arts, poetry and literature will intensify in this period. You will also do well in your field of interest. Over all happiness is assured.

**19/02/2010-17/04/2010 IN THIS PERIOD YOU WILL BE UNDER SAT VARSHDASHA AND IN THE VARSHLAGAN SAT IS IN HOUSE NO. 9**

You will be quite happy during this period as your efforts will start giving you good results. You will enjoy a good relationship with your parents, seniors and government authorities. Long distance travel shall be rewarding. Your friends and associates will assist you in your pursuits. Your mind will bend towards spiritualism or the higher philosophy of life. There are chances of yours entering into a new business or a changed job. Your opponents will not be able to do you any harm. Minor health ailments are quite possible.

**17/04/2010-08/06/2010 IN THIS PERIOD YOU WILL BE UNDER MER VARSHDASHA AND IN THE VARSHLAGAN MER IS IN HOUSE NO. 12**

This period will give you some mental anxiety. Your opponents may try to damage your reputation. Your expenditures will go on increasing and sudden losses are also possible. Even health problems might disturb you and the family atmosphere may also not be harmonious. You may have to be involved in unprofitable deeds. Eventually, your mind will bend towards spiritualism. You must try to develop resistance towards odds. A tendency of taking risk should be curbed and all kinds of speculations must be avoided.

**08/06/2010-29/06/2010 IN THIS PERIOD YOU WILL BE UNDER KET VARSHDASHA AND IN THE VARSHLAGAN KET IS IN HOUSE NO. 6**

During this period, you will do extremely well in your business/trade etc. If employed then service conditions will improve. An expansion of business is likely to take place. Your reputation will definitely be enhanced. During this

period you will get respect from all circles. The attitude of family members will be cordial towards you. You will come out with flying colours in competitions. Your opponents will have no courage to face you. Unexpected travel will bring good luck. Your health will be good. As this being a good period, make every attempt to gather all the luck coming your way.

**29/06/2010-29/08/2010 IN THIS PERIOD YOU WILL BE UNDER VEN VARSHDASHA AND IN THE VARSHLAGAN VEN IS IN HOUSE NO. 12**

During this period, you will spend money on luxuries and comforts. Conjugal happiness of high order will be there. It would be better to do all this within limitations, other wise instead of enjoying you may run into trouble. A minor health ailment could disturb your peace of mind. Be slow in love affairs. Your opponents and adversaries will try to do you harm. You will tend to feel unconcerned but are advised to do so. Financially, this is not a bad period but expenses should be checked. The health of a family member may cause some anxiety.

**29/08/2010-17/09/2010 IN THIS PERIOD YOU WILL BE UNDER SUN VARSHDASHA AND IN THE VARSHLAGAN SUN IS IN HOUSE NO. 12**

During this period, you must avoid being impulsive. You should take time over your decisions else you may have to suffer on account of wrong decisions taken by you. You might indulge yourself in unnecessary expenses. You may have to face some bad news regarding your business. There are indications of heavy losses. Care must be taken regarding health. Maintain good relations with friends or relatives, as there is possibility of straining relations with them. Speculations must be avoided or else they may cause financial losses.

**17/09/2010-17/10/2010 IN THIS PERIOD YOU WILL BE UNDER MON VARSHDASHA AND IN THE VARSHLAGAN MON IS IN HOUSE NO. 6**

Ventures/projects that you may undertake during this time period may not bear any fruit. Your enemies may try to tarnish your image. Your Service conditions may also deteriorate. Health problems will disturb your peace of mind. Rashness should be checked. The health of your family members may cause anxiety.

**17/10/2010-07/11/2010 IN THIS PERIOD YOU WILL BE UNDER MAR VARSHDASHA AND IN THE VARSHLAGAN MAR IS IN HOUSE NO. 7**

During this period, you might face difficulties in your day to day pursuits. Your enemies will try to tarnish your image. Disputes with partners and associates are strongly indicated. Family life also will not be happy. You must take care

of your health. Travels may be disappointing in this period. The health of your spouse may cause some concern to you. During this period, your life will be full of troubles and turmoil.

**07/11/2010-01/01/2011 IN THIS PERIOD YOU WILL BE UNDER RAH VARSHDASHA AND IN THE VARSHLAGAN RAH IS IN HOUSE NO. 12**

Change of job or residence is indicated in this period. Heavy expenditure will make you frustrated and quarrels with your own people are possible. Travels may be tiring and unrewarding. The attitude of family members will be indifferent. Your enemies may try to harm you. The tendency of unworthy act in a secret manner should be totally crushed. Be careful of wicked friends as your reputation could be made to suffer on their account. The ill-health of a family member may be another cause of anxiety. Therefore, do not plan a journey now.

LAGAN CHART

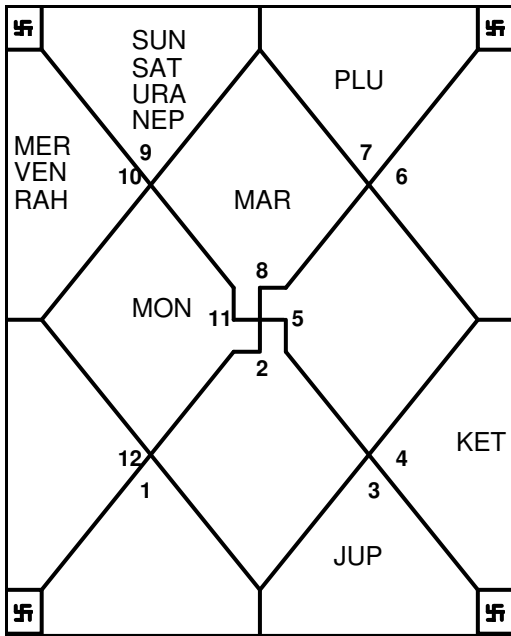

LALKITAB CHART 2010 - 2011

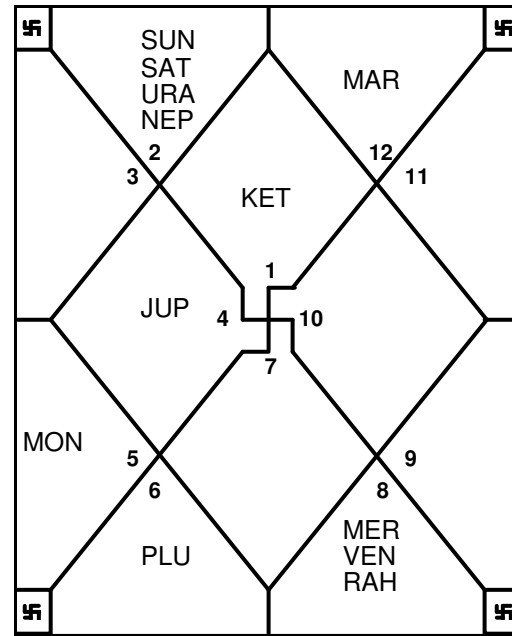

## LALKITAB REMEDIES

SUN: Do not take any white coloured items free e.g. milk, silver, rice, white clothes etc.

MON: Whenever you are stressed or tense, visiting a nearby hilly, greeny area will make you feel relaxed.

MAR: Consume a little honey early in the morning, without brushing your teeth.

MER: Bury a glass bottle filled with honey in an isolated place.

JUP: Do not show your bare body to others.

VEN: Go to religious places regularly. Do not indulge in illicit relations.

SAT: Apply a tilakam of curd on the forehead to get out of financial crisis.

RAH: Do not wear blue pants. Keep a square silver piece in your pocket to get rid of uninvited tensions.

KET: Do not live in the last house of the lane.



## STONE SUGGESTIONS

---

STONE	METAL	FINGER	DAY	TIME	NAKSHATRA
RUBY	GOLD	RING	SUN	MORN	KRITTIKA, U.PHAL, U. SHAD
PEARL	SILVER	LITTLE	MON	MORN	ROHINI, HASTA, SRAVANA
CORAL	GOLD	RING	TUE	MORN	MRIGSH, CHITRA, DHANISHT
EMERALD	GOLD	LITTLE	WED	MORN	ASHLESA, JYESHTA, REVATI
Y.SAPPHIRE	GOLD	INDEX	THU	MORN	PUNRAVASU, VISHAKHA, P.
DIAMOND	PLATINUM	LITTLE	FRI	MORN	BHARANI, P.PHAL, P.SHADA
B.SAPPHIRE	SILVER	MIDDLE	SAT	EVEN	PUSHYA, ANURADHA, U.BHAD
GOMED	SILVER	MIDDLE	SAT	NIGHT	ARDRA, SWATI, SHATBHISHA
CAT'S EYE	SILVER	RING	THU	NIGHT	ASHWINI, MAGHA,MOOLA

### LUCKY STONES

Stone increases the benefic aspects by absorbing rays of the planets and flowing them into human body. These are the three stones which help you in acquisition of wealth, good health, comforts of life, professional success and favour of luck.

LIFE STONE : B.SAPPHIRE

LUCKY STONE : EMERALD

BENEFIC STONE : DIAMOND

## STONE SUGGESTIONS

STONE	MANTRA
RUBY	OM HRAN HREEN HROWN SAH SURAYAYAE NAMAH
PEARL	OM SHRAN SHREEN SHROWN SAH CHANDERMASE NAMAH
CORAL	OM KRAN KREEN KROWN SAH BHAUMAYAE NAMAH
EMERALD	OM BRAN BREEN BROWN SAH BUDHAYAE NAMAH
Y.SAPPHIRE	OM GRAN GREEN GROWN SAH GURAVAYAE NAMAH
DIAMOND	OM DRAN DREEN DROWN SAH SHUKRAYAE NAMAH
B.SAPPHIRE	OM PRAN PREEN PROWN SAH SHANAYAE NAMAH
GOMED	OM BHRAN BHREEN BHROWN SAH RAHVE NAMAH
CAT'S EYE	OM STRAN STREN STRON SAH KETVE NAMAH

Wearing of stone should be taken as ceremonial following a specified method by invoking all blessings of your God through performing POOJA (meditation). Wearing of stone in the specified Nakashatra while Moon is waxing on the specified day and time enhances the benefic effects of the stone. Clean the ring in fresh milk and holy water. With your eyes closed call your God and perform POOJA and recite the specified Mantras 108 times on to your string of beads. Then wear the ring on to your specified finger of your right hand and celebrate offering Prasad (Sweets) to your well-wishers.

Sample

**NUMEROLOGY**

---

<b>RADICAL NUMBER</b>	: 1
<b>LUCKY NUMBER</b>	: 3
<b>FAVOURABLE PERIOD</b>	: March 21 - April 28, July 21 - August 28
<b>FAVOURABLE DAYS</b>	: Sunday and Monday.
<b>FAVOURABLE DATES</b>	: 1, 4, 7, 10, 13, 19, 28.
<b>IMPORTANT YEARS</b>	: 10, 19, 28, 37, 46, 55, 64, 73.
<b>FAVOURABLE COLORS</b>	: All Shades of Gold, Yellow, Bronze, Golden Brown.
<b>LUCKY STONE</b>	: Topaz, Amber, Yellow Diamond and all stones of these colors.
<b>HEALTH</b>	: You may have problems due to irregular circulation and suffer from high blood pressure and palpitation. Likely to have trouble in eyes.
<b>CAREER</b>	: You can shine in government jobs, jobs in semi-government organisations. Judiciary, politics, medical, jewellery, engineering are also favourable to you.
<b>FAULTS</b>	: Pride, anger, conceit, egoism, despotism.

**Triple-S Software**Website:-<http://www.horosoft.net>Email:[sales@horosoft.net](mailto:sales@horosoft.net) , [horosoft@yahoo.com](mailto:horosoft@yahoo.com)

## NUMEROLOGY

---

You are a very ambitious person. You gain progress in any work that you undertake. You do not like anybody ordering or commanding you. You will lead your life with your own way and on your own terms. You usually desire to be the head of a project and be the best in your profession so that the people respect you. In other words, you care a lot about your image and social status. You are fond of luxuries and like to lead an extravagant life. You are sometimes very critical about others, but yet you encourage your colleagues to progress. You should try to seek the help of other people in work unknown to you and try not to be a celebrity by struggling or performing the work alone. You should avoid being boastful in your life. Health wise, you may be prone to heart diseases. You should get your eyesight checked regularly. You may have problems related to circulatory system and high blood pressure in the later part of your life. Having oranges, cloves, ginger and barley will be helpful to you. You should also have as much honey as possible. You should look after your health during the months of October, December and January. You should not over work yourself during this period. You are very sharp minded and possess a huge potential. You have a huge friends circle and many relatives, yet you may sometimes feel lonely and alone in this wide world. You always expect attention from other people. You possess a very positive nature and are very confident. Overall, you are a very optimistic person and never accept failure easily. You should always start your important work and assignments on the 1st, 10th, 19th and 28th of every month.