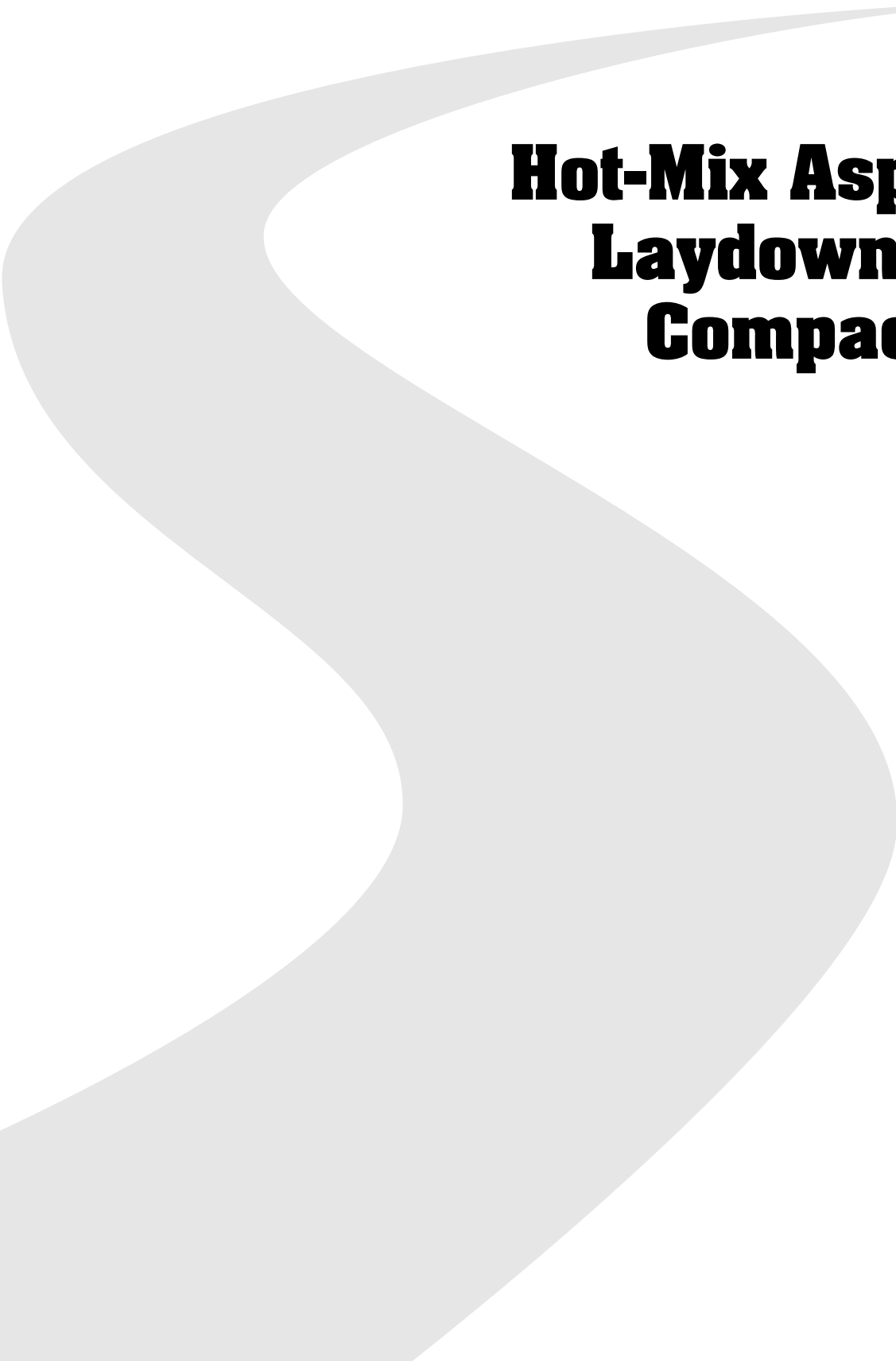

PART

A large, light grey, S-shaped graphic that curves from the top right towards the bottom left, framing the title text.

Hot-Mix Asphalt Laydown and Compaction

13 Mix Delivery

The purpose of the haul vehicle is to transport the asphalt mixture from the asphalt plant to the paver. This must be done without delay and with minimal change in the characteristics of the mix during the delivery process, and without segregation. Three primary types of trucks are usually employed to transport HMA—end-dump, bottom- or belly-dump, and live-bottom. The loading of the three types of trucks, either directly from the pugmill at a batch plant or from the surge silo at a batch or drum-mix plant, is reviewed in Section 11, with emphasis on techniques for preventing segregation. This section focuses on the unloading of the mix at the paving site from each type of truck; use of a material transfer vehicle is also briefly discussed. A review of hauling procedures is then presented.

UNLOADING OF MIX

End-Dump Trucks

An end-dump truck delivers the HMA directly from the truck bed into the hopper of the paver. The mix is unloaded by raising the truck bed and allowing the mix to slide down the bed into the hopper. When the bed is raised, it should not come into contact with the hopper and should not be carried by or ride on any portion of the paver. For smaller-capacity end-dump trucks, contact with the paver is normally not a problem. Such contact can be a problem, however, when large tractor-semitrailer units are used as haul vehicles, particularly when the truck bed is extended to its highest point. When a portion of the weight of the truck is being carried by the paver, the screed tow points of the laydown machine may be changed, which in turn will affect the smoothness of the finished mat. A typical end-dump truck is shown in Figure 13-1.

An end-dump truck can also be used to deliver the mix to a windrow on the roadway in front of the paver. The windrow can be formed in one of two ways. First, a spreader box or windrow sizer can be used. In this case, the mix is deposited into the box and is uniformly metered out onto the roadway as the truck moves for-

ward, typically pulling the windrow box behind it. The amount of HMA placed in the windrow is determined by the setting of the discharge opening in the box. This procedure provides the most accurate means of keeping a constant supply of mix in front of the paver. The mix is then picked up from the roadway surface by a windrow elevator attached to the front of the paving machine.

A second means of creating a windrow using an end-dump truck is to use a windrow blender device, which is usually attached to a small front-end loader. In this case, the mix is dumped onto the existing pavement surface across the full width of the truck bed. The amount of HMA discharged from the truck is controlled by both the width of the opening of the truck bed tailgate, which is chained to prevent full opening, and the forward speed of the truck. The mix is folded into a windrow by the blending unit as that device is pushed forward by the loader. As a result of the tumbling action that occurs as the mix is being shaped into the windrow, some remixing of the material occurs, and segregation may be reduced or eliminated. The size of the windrow is controlled by the height of the discharge opening at the back of the blender. Because of the length of the wings on the windrow blender, mix can be carried for some distance if the truck deposits too much mix at some point on the existing pavement surface.

Bottom- or Belly-Dump Trucks

A bottom- or belly-dump truck delivers its load onto the roadway in front of the paver. The mix is deposited from underneath the truck bed into a windrow, as seen in Figure 13-2. For this method of mix delivery, it is important that the correct amount of material be placed down the length of the windrow to match the paving width and depth being placed without allowing the hopper to run out of mix or become overloaded. Continuous operation of the paver, which must be equipped with a pickup machine (windrow elevator) (see Figure 13-3), can be accomplished only if a continuous and consistent supply of mix is available. It is more difficult, however, to maintain a consistent amount of mix in the paver hopper for leveling courses of HMA, which are necessarily





FIGURE 13-1 Typical end-dump truck.

of variable thickness, than for courses whose thickness is more constant.

Control of the amount of HMA discharged from a bottom-dump truck is based on the width of the gate opening under the truck and the speed of the truck. The amount of mix deposited at any time is therefore highly dependent on the skill of the person controlling the discharge gates and on the truck driver's attention to operating the truck at the required speed. Manual control of the discharge requires constant attention to ensure that neither too little nor too much mix is fed into the paver hopper (the hopper should be filled to a level above the top of the flow gates or tunnel openings at all times). The amount of mix needed in the windrow depends on the width and thickness of the layer being placed. Thus a different gate opening on the truck bed is needed according to variations in project conditions and truck speed.

The amount of mix available to be picked up by the windrow elevator on the front of the paver should be



FIGURE 13-2 Typical bottom- or belly-dump truck.



FIGURE 13-3 Material pickup machine.

consistent. Should the amount of mix being delivered to the paver become out of balance with the quantity of mix needed by the paver, an adjustment must be made in the discharge operation of the bottom-dump truck. If the problem is noticed before the paver is under- or overloaded, the amount of mix deposited on the roadway can easily be altered by changing the width of the gate opening on the truck or by adjusting the forward travel speed of the truck during discharge.

Should the paver run out of mix in the hopper, additional HMA should be placed in the hopper without the paver moving forward. Depending on the equipment available to the contractor at the paving site, such as a small loader, doing so may be very difficult. In some cases, the paver operator may have to raise the paver screed and then move the paver forward to pick up mix. When enough mix is in the hopper, the paver must be backed up, the screed set back down, more mix placed in the windrow in front of the paver, and paving started once again. Needless to say, this is not good paving practice and does not usually result in placement of a smooth mat.

Should the hopper become overloaded with mix, some of the material in the windrow in front of the paver must be removed so that the paver can move forward without additional mix being picked up. Once the mix in the hopper has reached the desired level, the paver must again start picking up additional mix from the windrow.

The ability of the paver to place a smooth mat will be affected by the uniformity of the volume of mix being fed to it. Because of the difficulty in adjusting the quantity of mix needed by the paver when the hopper is either under- or overloaded, it is important that the size of the windrow of mix produced by the bottom-dump truck be as consistent as possible. Keeping the

size of the windrow constant is easier than correcting the problem of too little or too much mix in the paver hopper.

One method to better control the amount of material in the paver hopper is to form a windrow that is a little short of that needed by the paver. An additional bottom-dump truck is then kept just in front of the laydown machine, traveling over the windrow placed by the earlier truck or trucks, to supplement the amount of mix in the windrow as needed. This type of operation overcomes the potential problem of under- or overfilling the paver hopper and greatly speeds up the paving process.

Live-Bottom Trucks

A live-bottom truck (also known as a flow-boy or horizontal-discharge truck) employs a conveyor belt or slat conveyor in the bottom of the truck bed to discharge the mix without the need to raise the bed. This type of truck usually deposits the mix directly into the hopper of the paver, as does an end-dump truck, but it can also deliver the mix to the existing pavement surface for pickup by a windrow elevator on the paver, as does a bottom-dump truck. Further, the live-bottom truck moves the HMA in a mass, which minimizes segregation as compared with end-dump trucks. Because the bed of this type of truck is not raised, there is no potential problem with the bed pressing on the paver hopper. A typical live-bottom truck is shown in Figure 13-4.

Material Transfer Vehicle

An additional method used to deliver mix to the paver is a material transfer vehicle (MTV) (see Figure 13-5). An MTV is basically a surge bin on wheels that can hold up to 32 000 kg (35 tons) of mix, depending on the



FIGURE 13-4 Typical live-bottom truck.



FIGURE 13-5 Material transfer vehicle.

size of the unit. HMA is deposited from an end-dump or live-bottom truck into the hopper on the front of the vehicle, which may be equipped with a remixing auger or augers. The purpose of the auger system is to reblend the coarse and fine particles of the HMA and reduce any segregation and temperature variation that may have occurred in the mix as a result of the operation of the surge or storage silo or truck-loading procedures (see Section 11). The mix is carried from the hopper through the augers and then to a conveyor, which delivers the mix into a vertical extension or insert in the hopper.

The MTV should allow the paver to operate almost continuously, without stopping between truckloads of mix, as long as a continuous supply of mix is available from the asphalt plant. Therefore, the paver operator can keep the head of material in front of the screed constant by supplying a continuous amount of mix back to the screed and obtain a smoother mat. Use of an MTV also eliminates the problems of the haul truck bumping the paver and the truck driver holding the brakes on the truck when being pushed by the paver. As noted, however, the MTV is essentially a mobile surge bin; when it runs out of material, the paver must stop, and a continuous paving operation is not possible. Keeping a constant stream of trucks in front of the paver or MTV is therefore necessary if a continuous paving operation is to be achieved. If a gap occurs, the MTV should be stopped without being completely emptied when waiting for trucks, so that a consistent minimum amount of mix is retained on the augers to mix with the new, possibly segregated, material delivered from the next haul truck. In addition, the paver should be stopped with the hopper half full so that the amount of HMA in front of the paver screed remains constant and the proper smoothness of the mat is achieved. Indeed, the head of



material in front of the paver screed is the most important factor in obtaining a smooth-riding pavement layer (see Section 16).

The MTV can be operated directly in front of the paver or off to one side. Because of the weight of this piece of equipment when full of mix, it is necessary to determine ahead of time that the pavement over which this machinery will be operated can support the loaded weight without being overstressed and damaged. Several smaller, simpler MTVs have been developed by various equipment manufacturers. Because of the limited surge capacity of most of these smaller devices, however, it is more likely that the paving operation will have to stop because of the MTV running out of material.

HAULING PROCEDURES

Cleaning of the Bed and Application of Release Agent

The bed of the haul truck, whether an end-dump, bottom-dump, or live-bottom truck, should be free of all deleterious materials before mix is placed in it. Any debris in the bed from previous use of the truck should be removed. The bed should be reasonably smooth and free of any major indentations or depressions where the truck bed release agent and HMA could accumulate.

Once the bed is clean, it should be coated with a release agent to prevent the HMA from sticking to the bed. Nonpetroleum-based materials, such as limewater or one of a variety of commercial products, should be used for this purpose. The release agent should be sprayed uniformly over the sides and bottom of the truck bed and should be used in the minimum quantity necessary to cover most of the surface area of the bed without runoff. Any excess agent should be drained from the bed before the truck is loaded with mix.

Diesel fuel should not be used as a release agent for the truck bed (see Figure 13-6). If an excessive amount of diesel fuel is used and accumulates in depressions in the bed of the truck, it can cause changes in the properties of the binder material with which it comes in contact. If an area of the finished HMA mat contains excessive diesel fuel, a soft spot and maybe a pothole will result (see Figure 13-7). In addition, use of diesel fuel can contribute to environmental problems as the fuel evaporates or if it soaks into the ground. Thus, although often convenient and economical, diesel fuel should not be used as the release agent in the bed of a haul truck.

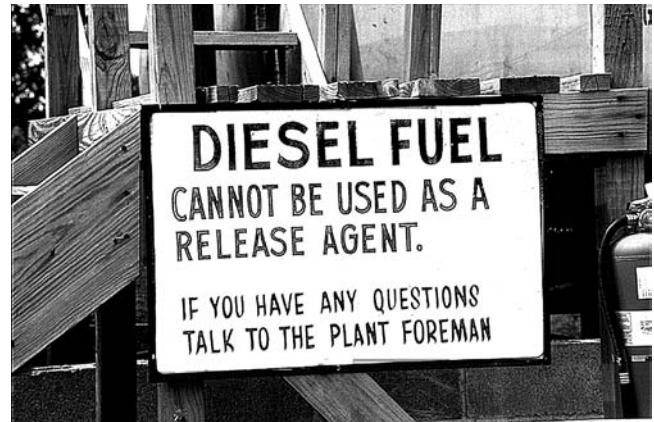

FIGURE 13-6 Diesel fuel is an unacceptable release agent.

Insulation

If warranted by environmental conditions, the sides and bottom of the truck bed should be insulated. The insulation should be tight against the body of the bed, and there should be no gaps between the side of the truck and the insulation through which wind could enter. The insulation material should be protected on its outside face with plywood or a similar cover. Missing or torn insulation should be replaced.

Some coarse-graded mixes, such as friction courses, stone-matrix asphalt, and coarse-graded Superpave, tend to cool more quickly than fine-graded mixes, and mixes containing polymer tend to stiffen more quickly as they cool. A well-insulated truck will help minimize any temperature loss.



FIGURE 13-7 Pothole caused by overlaying of spilled diesel fuel.

Use of Tarpaulins

Every haul truck should be equipped with a tarpaulin that can be used as needed to protect the HMA in case of inclement weather. The tarp should be made of a water-repellent material, be of sufficient weight and strength to resist tearing, and be in good condition with no holes or tears. Most important, the tarp should be large enough to cover the top of the load and extend down over the sides and the tailgate of the truck at least 0.3 m (1 ft) all around the truck bed to ensure that the mix is protected adequately from wind and rain. The tarp should also have enough tie-down points so that it will be properly secured and will not flap in the wind during delivery of the mix from the plant to the paver.

Some trucks are equipped with tarps that run from the front to the back of the truck in a rail atop the sideboards of the truck. The rail keeps the tarp stretched across the top of the load of mix and covers the mix without the tarp having to extend over the sides of the truck bed. As long as the tarp is tight, this arrangement can provide adequate cover for the mix. For safety reasons, it is desirable to use tarps that can be extended by mechanical means over the length of the bed of the truck without the driver having to climb up the sides of the vehicle.

A tarp that does not completely cover the load during transport may be worse than having no tarp at all on the load. Research has shown that unless the tarp extends over the sides of the truck, airflow under the tarp will increase the rate of cooling of the mix. In addition, any water that falls on the tarp during rainy weather will run into the truck bed instead of off the side of the vehicle. Indeed, even when the tarp covers the bed, if there is any water on the tarp when the truck is ready to discharge mix into the paver hopper, the water should first be removed by raising the bed of the truck and letting the water run off before the truck backs into the hopper. This water removal operation should not be done on the pavement in front of the lay-down machine.

Tarps are not normally necessary in warm weather and for relatively short haul distances between the plant and the paver. If a tarp is used, however, it should be removed from the top of the bed before the truck is unloaded into the laydown machine. Doing so allows the mix to be inspected visually for defective material, such as uncoated aggregate or excessive asphalt content, before being discharged into the paver.

Crusting of the Mix

There is no set limit on how far a load of HMA can be transported. Many variables affect the maximum haul distance, but the key factors are the workability of the mix while it is passing through the paver and the ability to compact the mix once it has been placed by the paver. Both of these factors are highly dependent on the temperature of the mix.

HMA in a mass, such as when the mix is confined in a truck bed, will maintain a reasonable temperature for as long as 2 or 3 hours. The rate of cooling of the mix depends on such variables as its temperature at the time of production, the ambient air temperature, and the efficiency of any insulation used on the sides and bottom of the truck. When hauled long distances without being covered by a tarp, HMA will cool and develop a crust on the top. The crust serves as an insulating layer for the rest of the mix in the truck bed and reduces the rate of cooling for the remainder of the material. Thus within limits, crust formation can be beneficial. However, the crust must be completely broken down before reaching the paver, or tears and pulls in the finished mat surface will occur.

If the load of mix is properly tarped, the amount of crust buildup will be minimized because the wind will have significantly less effect on the rate of cooling of the mix. The slight crust thickness that does form during transport will usually be broken up completely as the mix is discharged from the haul vehicle into the paver, carried by the slat conveyors back to the augers, and passed under the paver screed. As long as chunks of asphalt mix do not affect the quality of the mat behind the paver, the crust that forms on top of the mix during delivery will not be detrimental to the long-term performance of the mix. If chunks of mix can be seen behind the screed, however, changes need to be made in the mix production temperature, the amount of insulation on the truck bed, the covering of the load with the tarp, the paving schedule (waiting for warmer ambient temperatures), or any combination of these factors. It has also been shown that using an MTV results in some remixing, which helps break down any chunks that may exist.

Rain

Judgment is required when rain occurs at the paving site and mix is still in the trucks waiting to be unloaded. One alternative is to stop paving and return any mix in the trucks to the plant to be recycled at a later date. If the rain is relatively light and appears likely to continue for some



time, and if the pavement surface has been tacked and does not contain puddled water, the trucks can be unloaded as quickly as possible and the rollers brought up directly behind the paver to compact the mix before it cools completely. If the existing pavement surface contains puddles of water, however, placement of the HMA should not be continued.

Some specifications permit the contractor to place mix that is “in transit” on the roadway even during a rainstorm. Although most of the HMA placed during rain performs adequately over time, it is better practice to refrain from placing the mix if the rain is heavy and the pavement surface is very wet or standing water exists on the surface. With the advent of pavement recycling, the material not placed can easily be recycled later. The only cost involved is that of hauling the mix back to the plant and reprocessing it through the plant. Any mix that is placed during rain will cool very quickly as a result of the rapid heat transfer from the mix to the wet underlying pavement surface and the cooling of the mix by the rain itself. It is thus very difficult to obtain proper density in the mix because of its low temperature. A lack of compaction, and therefore a high air void content in the mix, leads to poor pavement performance.

If the rain appears to be of short duration—a passing shower—the mix can be held in the haul truck instead of being dumped into the paver hopper. It should then be laid after the shower has passed and the pavement surface is free of puddles. Again, because of the mass of mix in the truck bed, the mix will lose temperature slowly if the load is properly tarped—no water can get into the bed. Once the rain has stopped and any puddles of water have been swept from the roadway surface, the mix can be unloaded from the waiting trucks into the paver and laid down. As long as chunks of mix do not appear behind the screed and the rollers can properly densify the mix, little harm is done by holding the mix in the haul trucks for even 2 or 3 hours, depending on environmental conditions.

Bumping of the Paver

When an end-dump or live-bottom truck is used to deliver mix to the paver, the truck driver should back the truck up to the laydown machine but stop just short of touching the paver. Once the truck has come to a halt and the driver has released the brakes on the vehicle, the paver operator should start the machine moving forward, picking up the stopped truck. The key to this process is that the paver picks up the truck instead of the truck backing into and bumping the paver. Use of this procedure will reduce the incidence of screed marks and roughness in the mat. Given the smoothness specifications now

being implemented in most states, it is imperative that the truck-unloading operation not add to the problem. Upon being told why it is important not to bump the paver, most truck drivers will use the correct unloading techniques.

Unloading

If an end-dump truck is used and if the mix being delivered to the paver has a tendency to segregate, the bed of the truck should be raised a short distance to break the load to the rear and allow the mix in the bed to shift and slide back against the tailgate before it is opened. This practice will cause any segregated coarse aggregate material to be incorporated back into the mass of mix rather than being delivered first into the paver hopper. Once the tailgate is opened, this procedure will also allow the mix to be discharged from the truck in a mass and to flood the hopper of the paver, further reducing the possibility of segregation behind the paver screed. In addition, raising the bed before the truck backs into the paver reduces the time required to unload the truck and makes the truck exchange more efficient.

The same procedure should be employed, if possible, when a live-bottom truck is used to transport the mix. On some such trucks, it may be possible to start the belt or slat conveyor for a few seconds before the end gate on the truck is opened. Doing so will create a mass of material that can be delivered to the hopper, instead of allowing any coarse aggregate particles that have rolled to the end gate to exit into the hopper first.

For bottom-dump trucks, the gates on the bottom of the truck bed should be opened wide to allow a mass of mix to be discharged, instead of only some of the mix dribbling out if the gates are partially opened. The size of the windrow should then be controlled by the forward speed of the haul truck. If only a small amount of mix is needed in the windrow, the gates can be chained so they do not fully open, thus limiting the amount of HMA deposited on the roadway and creating the correct-size windrow. These procedures all require coordination between the paver crew and the truck driver.

SUMMARY

The following key factors should be considered when monitoring truck loading, hauling, and unloading operations:

- The truck bed should be free of all contaminants. The bed should be lightly and uniformly coated with a

nonpetroleum release agent; diesel fuel should not be used for this purpose.

- If insulation around the truck bed is required, it should be tight to the sides and bottom of the truck.

- The truck should be equipped with a tarpaulin that is in good condition, without tears and holes. The tarp should be large enough to cover the bed and wrap over its sides and end. The tarp should have enough fasteners so that it can be tied down completely and will not flap in the wind. If side rails are used to hold the tarp in place, the tarp should be stretched tightly over the load of mix.

- End-dump and live-bottom discharge trucks should stop short of the paver and allow that machine to pick up the truck on the move, instead of bumping into the stopped paver.

- The bed on an end-dump truck should be raised a short distance and the mix in the truck allowed to break

and slide against the tailgate before the tailgate is opened to discharge mix into the paver hopper. The belt or slat conveyor on a live-bottom truck should be started a few seconds before the end gate is opened, if possible, to discharge a mass of asphalt mix into the hopper instead of just a dribble of coarse aggregate particles.

- The load carried in a bottom-dump truck should be deposited uniformly on the roadway in front of the paver so that the amount of mix picked up by the windrow elevator enables the paver operator to maintain a uniform head of material in front of the paver screed. Alternatively, the windrow should purposely be built slightly short of mix and one truck kept in front of the paver, acting as a mobile surge bin to provide any additional mix needed by the paver.

- End-dump trucks should not be allowed to contact or transfer any weight to the paver hopper.



14 Surface Preparation

The performance of HMA under traffic is directly related to the condition of the surface on which the pavement layers are placed. For a full-depth asphalt pavement, if the condition of the subgrade soil is poor (particularly if it is wet and rutted under the haul trucks), the ultimate life of the roadway may be significantly reduced. For HMA layers placed on top of a new, untreated granular base course, that base material should be stable, the surface should be dry, and the base should not be distorted by the trucks carrying mix to the paver. For mix laid on top of existing asphalt layers, that surface should be properly prepared—potholes filled, cracks sealed, and the surface cleaned. A tack coat should also be used to ensure a bond between the existing pavement surface and the new asphalt overlay.

BASE PREPARATION FOR NEW HMA PAVEMENTS

Subgrade Soil

If the asphalt pavement is to be placed directly on the subgrade soil, that subgrade material should meet all applicable requirements for moisture content, density, structural support, and smoothness. After the subgrade soil has been determined to be ready for paving and before paving is allowed to commence, the subgrade should be checked to ensure that it will be able to support the weight of the haul traffic. The subgrade must provide a firm foundation before the asphalt paving begins. If distortion of the subgrade soil occurs during the paving operation, placement of the mix should be stopped until the condition of the soil can be corrected.

There is generally no need to place a prime coat of asphalt emulsion or cutback asphalt on the subgrade soil. This is especially true when the soil is a silty clay or clay material because the prime coat material cannot be absorbed into that subgrade material. The use of a prime coat on sandy subgrade soils is also questionable. If the sandy material displaces excessively under the wheels of the haul trucks, it should be stabilized with some type of binder material before paving to achieve the required load-bearing properties. In such cases, the application of

a prime coat will generally not be enough to hold the sandy soil in place during paving operations. A prime coat should not be used as a substitute for proper preparation of the subgrade soil.

Granular Base Course

If the asphalt layer is to be constructed directly on a new or existing untreated granular base layer, that base material should meet all the requirements for moisture content, density, structural strength, and smoothness. Proof rolling should be done, however, on top of the granular base material, and the amount of deflection of the base and the amount of indentation of the truck wheels in the granular base course material should be noted. If the base material is stable and dry and does not deflect and indent significantly under the wheels of a loaded tandem-axle truck, placement of the prime coat or the new asphalt mix should be permitted to start. If the condition of the granular material is not satisfactory, the base course should be reworked or stabilized until it is in the proper condition for overlaying.

The prime coat acts as a temporary waterproofing layer that protects the base course and prevents it from absorbing excess moisture during rain before paving. It also allows the base course to be used for light traffic, binds together any dust on the surface of the granular base layer, promotes the bond between the base-course material and the new HMA overlay, and prevents slippage of thin overlying pavement layers. However, the purpose of a prime coat is to protect the underlying materials from wet weather. If the underlying materials can be covered prior to the rainfall, then a prime coat is not needed. When a prime coat is used, the prime coat material should be applied to the base course with a pressure distributor at least 48 hours before paving is to begin. Typically, a cutback asphalt (MC-30 or MC-70) is used as the prime coat material, if available. An inverted asphalt emulsion (emulsion containing limited amounts of cutter stock material) also has been applied successfully. The application rate should vary with the openness (porosity) of the base course material. Typical application rates range from 0.65 l/m² (0.15 gal/yd²) or less for a very tight surface to 1.8 l/m² (0.40 gal/yd²) for an open



surface. No more prime coat material should be applied than can be absorbed completely by the granular base course in 24 hours. If all of the prime coat material is not completely absorbed, the excess should be blotted with sand or removed.

PREPARATION OF EXISTING SURFACES FOR HMA OVERLAYS

HMA over HMA

The degree of preparation needed for an existing asphalt pavement depends on the condition of that surface. At a minimum, failed areas should be removed and replaced; potholes properly patched; cracks cleaned out and sealed; and ruts filled in or, preferably, removed by cold milling.

Pavement Replacement and Patching

It is generally inadvisable to attempt to bridge failed areas with new overlay material unless a very thick overlay is to be constructed. Removal and replacement should be carried out on all existing pavement areas where severe load-related distress has occurred. All HMA and granular base materials that have failed should be excavated or cold milled and then either recycled or wasted. Subgrade distortion should be repaired by undercutting and replacement with suitable backfill material. Proper subsurface drainage should be installed as necessary. New granular base course material, stabilized base course layers, or HMA mix should be placed in order to bring the strength of the pavement structure in each failed area to the same level as the surrounding good pavement layers. If HMA is used to patch a large area, it should be placed with a paver and compacted with one or more large rollers (see Figure 14-1).

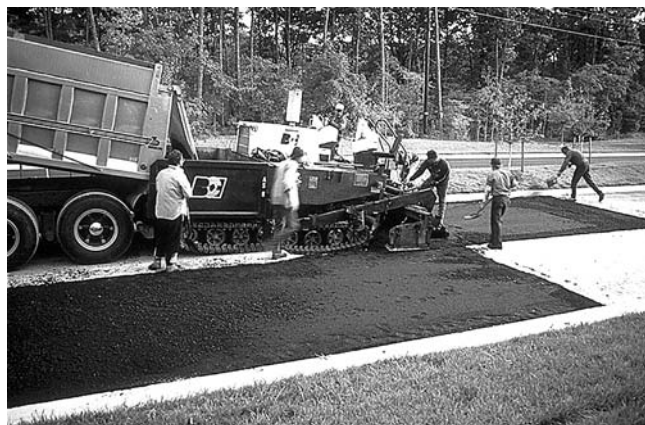

FIGURE 14-1 Patches placed with paving machine.

Localized failed areas should be patched properly. Each should be cut back to sound pavement and squared up, with the sides as vertical as possible, the loose material and water in the hole removed, a tack coat applied to the sides and bottom of the hole, the mix placed in the hole, and the new material adequately compacted, preferably with a roller (see Figures 14-2 and 14-3). If the pothole is deeper than 100 mm (4 in.), the mix should be placed in more than one layer and each layer compacted properly.

Crack Filling

Badly cracked pavement sections, especially those with pattern cracking (e.g., map or alligator), must be patched or replaced. The benefits of filling other cracks in the existing surface depend, in part, on the width of the cracks. If the cracks are narrow [less than 10 mm ($\frac{3}{8}$ in.) in width], it is doubtful that the crack-sealing material will actually enter the crack instead of pooling on the pavement surface. Such cracks can be widened, if desired, with a mechanical router before sealing is attempted. If wider cracks are present, they should be blown out with air and cleaned of debris. The crack-sealing material should be inserted when the cracks are clean and dry. The level of the crack-filling material should be slightly lower than that of the surrounding pavement surface and should not spill over the top of the crack, where it could create a bump in the new pavement layer during the rolling process (see Figure 14-4).

Depending on the cause of the cracking, the amount of reflective cracking that occurs in an overlay can sometimes be reduced by the use of a surface treatment (seal coat) on the existing pavement. If that pavement structure contains a great number of cracks, consideration should be given to applying a surface treatment instead of filling



FIGURE 14-2 Removal of existing pavement prior to patching.



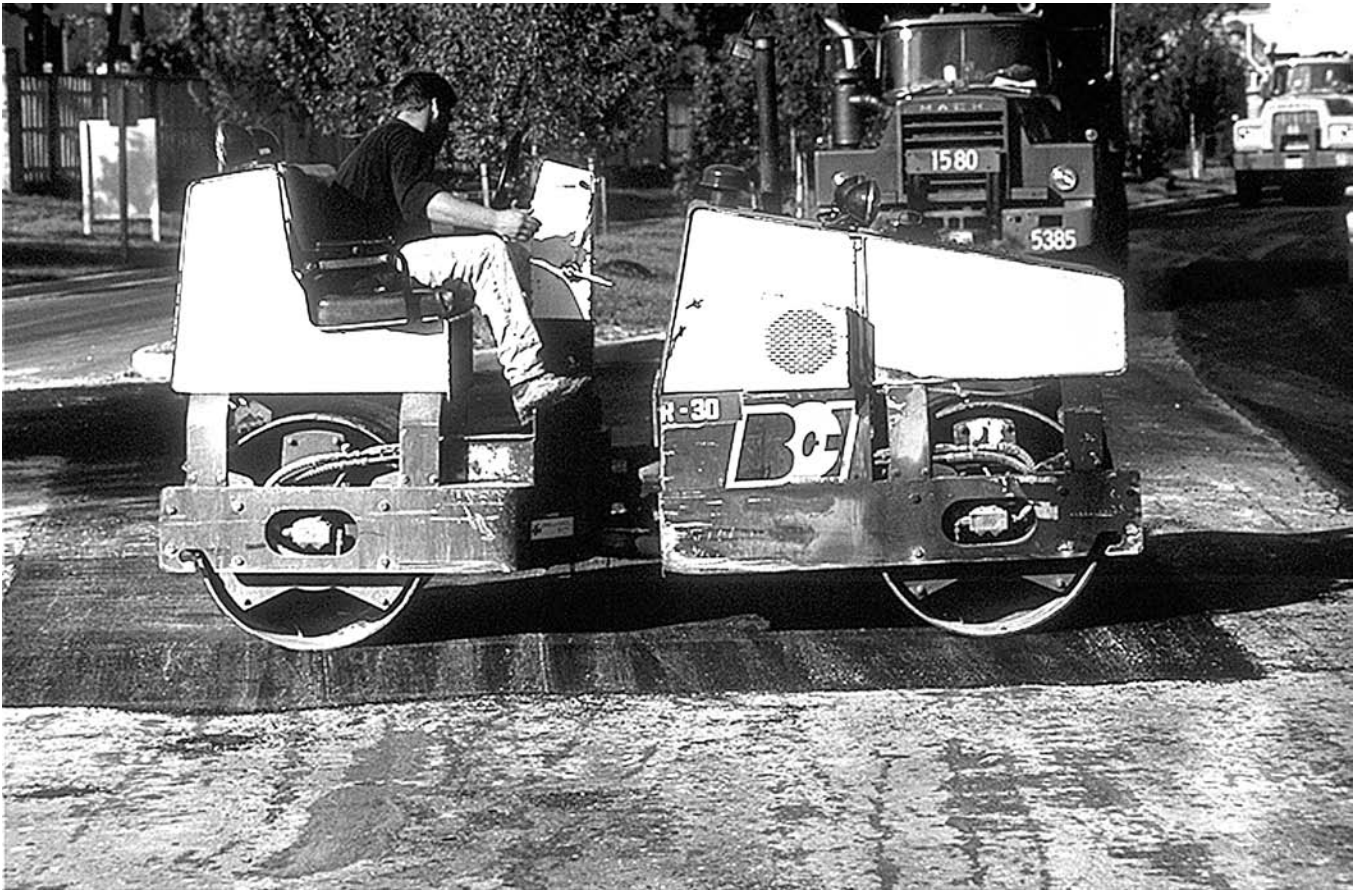

FIGURE 14-3 Compaction of patch.

individual cracks. The cracks should be cleaned, if feasible, by being blown out with air. The surface treatment should be applied when the pavement surface is clean and dry and should consist of a single application of asphalt binder material (asphalt cement, cutback asphalt, or asphalt emulsion) and cover aggregate. Alternatively, a

slurry seal consisting of an asphalt emulsion, fine aggregate, and water may be used.

Leveling Courses

Common practice in the past has been to place a leveling course on the existing pavement surface to improve the rideability of the pavement structure. This leveling course, sometimes called a wedge and level course or a scratch course, is designed to fill in the low spots on the pavement surface. This leveling action is accomplished using the floating screed on the paver, with more HMA being placed in the low spots than on the high spots in the existing pavement surface. The areas with thicker mix, however, typically compact more than areas with thinner mix. This problem, termed differential compaction, requires that multiple courses be constructed over a pavement surface that is badly out of shape before a smooth surface can be obtained. As the mix passes from under the paver screed, it is in loose condition. Compaction by the rollers reduces the thickness of the newly placed layer. The rule of thumb is that conventional mixes will compact approximately 6 mm per 25 mm ($\frac{1}{4}$ in. per 1 in.)



FIGURE 14-4 Bump caused by use of excessive crack sealant.



of compacted thickness. Thus to achieve a compacted course 25 mm (1 in.) thick, about 31 mm (1¼ in.) of mix would have to be placed by the paver. Similarly, approximately 95 mm (3¾ in.) of mix would need to pass from under the paver screed to construct a layer with a compacted thickness of 75 mm (3 in.).

When a leveling course is placed, the HMA laid in the low areas (in the wheelpaths if the pavement is rutted) will be thicker than the mix placed over the high points in the surface (between the wheelpaths). The thicker mix will compact more under the rollers, particularly if a pneumatic tire roller is used, than will the mix that is thinner. Thus, low spots will still exist in the wheelpaths where the mix has been compacted to a different degree (and thus a different air void content) than the mix between the wheelpaths. Because of the problem of differential compaction, multiple layers of mix are usually needed to completely eliminate the roughness in the existing pavement surface. A rule of thumb is that one layer after compaction will remove approximately 80 percent of a low spot. Two layers, each being compacted separately, will remove approximately 95 percent of a low spot.

Milling

Milling, also called cold planing, can be used to remove the high points in the existing surface in lieu of placing a leveling course (filling in the low spots). Milling can be accomplished in any width necessary, from 150 mm (6 in.) to more than 4 m (13 ft). Figure 14-5 illustrates a typical milling machine. If equipped with automatic grade and slope controls similar to those used on an asphalt paver, the milling machine is capable of producing a level surface in one pass over the existing surface. The RAP produced by the milling process can be hauled



FIGURE 14-5 Typical milling machine.

back to the asphalt plant for future recycling. In addition, if the milled surface is properly cleaned, its texture can enhance the bond between the new and old layers and may reduce the possibility of slippage of the overlay over the existing surface.

A pavement surface that has been milled is typically very dusty and dirty. Once the pavement has dried, multiple sweepings with a mechanical broom are usually needed to remove all of the residual grit from the milled surface. In some cases, it may be necessary to dampen the milled surface before sweeping or to air blow or flush the milled surface with water to remove dust and very fine material completely. Any dust and dirt left on the milled surface will greatly affect the bond between that course and the new asphalt overlay. Because of the increased surface of the milled pavement (from the grooves left by the cutting teeth on the milling machine), an additional quantity of tack coat material may be required to ensure an adequate bond between the old and new layers (see Figure 14-6). That increased quantity is a function of the type, number, condition, and spacing of the teeth on the cutting mandrel of the milling machine but is typically in the range of 20 to 30 percent more than for an unmilled surface.

HMA over Portland Cement Concrete

When HMA is placed over a portland cement concrete (PCC) pavement, the PCC surface should likewise be properly prepared. Any severely distressed areas in the concrete slabs should be cut out, removed, and replaced with either PCC or HMA using full-depth slab repair techniques. Corrective work should also be completed on the underlying subbase or subgrade material, if necessary. Any severely spalled areas at joints should be repaired using partial-depth slab replacement methods.



FIGURE 14-6 Tack coat on milled surface.



PCC should be used for partial-depth repairs. Rocking slabs should be stabilized. Depending on the condition of the PCC pavement, procedures such as crack and seat, break and seat, or rubblizing of the existing pavement can be used before the overlay is placed, particularly if the slabs are rocking under traffic loading. Consideration can also be given to the use of a crack-relief layer between the existing PCC pavement and the new overlay.

For joints that are poorly sealed, the old seal material should be removed and the joints cleaned. When dry, the joints should be resealed with appropriate joint-sealing material. Care should be taken not to overfill the joints, particularly in cool weather when they are open wide. In all cases, as with crack sealant, the final level of the joint-sealing material should be below the top of the surrounding pavement surface. Once the patching and re-sealing have been accomplished, the surface of the PCC pavement should be cleaned completely using mechanical brooms and air blowing or water flushing, or both, where needed.

Tack Coat

The purpose of a tack coat is to ensure a bond between the existing pavement surface and the new asphalt overlay. The tack coat should not be used in lieu of cleaning the existing surface—removing accumulated dust and dirt by mechanical brooming or by flushing with air or water. If a good bond is not formed between the existing surface and the new overlay, slippage may occur. The new overlay may be shoved in a longitudinal direction by traffic, particularly at locations where the traffic accelerates or where vehicle brakes are applied. Thus the pavement surface must be clean before the tack coat is applied.

The tack coat material—which is normally asphalt emulsion but can also be asphalt cement or cut-back asphalt—should be applied by a pressure distributor, as shown in Figure 14-7. All nozzles on the distributor should be fully open and functioning and should be turned at the same angle to the spray bar, approximately 30°. In addition, the spray bar should be at the proper height above the pavement surface to provide for a double or triple lap of the liquid asphalt material. The result will be the proper amount of overlap between the nozzles and a uniform application of the tack coat to the road surface. The tack coat material should be heated to the proper temperature so that it is fluid enough to be sprayed uniformly from the nozzles instead of coming out in strings.



FIGURE 14-7 Distributor applying tack coat.

Application Rate Versus Residual Rate

Uniformity of application and a proper application rate are key to achieving a successful tack coat. Figure 14-8 illustrates a tack coat application that is uneven as a result of improper equipment operation, with too much tack coat in some areas and not enough in others. If the correct amount of tack coat is sprayed on the surface, some of the existing surface will still be visible through the tack coat; not all of the existing pavement surface will be covered. Use of a diluted asphalt emulsion tack coat (slow-setting asphalt emulsion diluted 1:1 with water) will result in complete coverage and a very thin residual asphalt film on the pavement surface. Proper tack coat application will leave a residual asphalt cement content of approximately 0.18 to 0.27 l/m² (0.04 to 0.06 gal/yd²) on the roadway. The amount of residual tack coat needed will depend on the condition of the pavement surface. An open-textured surface requires more tack coat than a surface that is tight



FIGURE 14-8 Improperly adjusted distributor.

or dense, and a dry, aged surface requires more tack coat than a surface that is “fat” or flushed. In addition, more tack coat may be needed on a milled surface because of the increased surface area, as discussed earlier; a residual rate of as much as 0.36 l/m^2 (0.08 gal/yd^2) of asphalt cement may be needed to ensure a proper bond.

It is essential to differentiate between the residual tack coat rate (the amount of asphalt cement remaining on the pavement surface after the water has evaporated) and the application rate (the amount of emulsion sprayed from the distributor). Most asphalt emulsions contain 60 to 65 percent residual asphalt cement and 35 to 40 percent water, plus a small amount of emulsifying agent. For ease of calculation, it can be assumed that an asphalt emulsion is approximately two-thirds asphalt cement and one-third water. The amount of asphalt cement left on the pavement surface after the water has evaporated from the emulsion is the most important factor in obtaining a bond between the existing pavement surface and the new overlay. To determine the application rate for the tack coat material, start with the amount of residual asphalt cement required on the pavement surface and work backward.

As an example, suppose that the present pavement surface is relatively tight and dense. It is determined that the residual amount of asphalt cement on the pavement surface needs to be 0.18 l/m^2 (0.04 gal/yd^2). If an undiluted SS-1 asphalt emulsion is used for the tack coat, the application rate for that material should be approximately 0.27 l/m^2 (0.06 gal/yd^2), calculated as $(0.18) \div (\frac{2}{3}) = 0.27 \text{ l/m}^2$ [$(0.04) \div (\frac{2}{3}) = 0.06 \text{ gal/yd}^2$]. If the SS-1 asphalt emulsion has been diluted with equal parts water, the application rate needed to obtain the same amount of residual asphalt on the pavement surface will be different. Using a 1:1 dilution rate, the application rate for a residual amount of 0.18 l/m^2 (0.04 gal/yd^2) will be 0.54 l/m^2 (0.12 gal/yd^2). Thus with the use of a 1:1 diluted emulsion, twice as much emulsion must be applied to the pavement surface from the distributor to have the same amount of residual asphalt when all of the water has evaporated.

If the amount of water in an asphalt emulsion is not taken into account when determining the application rate from the distributor, the correct degree of adhesion may not be achieved. Too little tack coat will not provide sufficient bond between the old and new pavement layers. On the other hand, too much tack coat may contribute to slippage of the overlay on the existing pavement surface and bleeding of the tack coat material through a thin overlay.

If asphalt cement instead of an asphalt emulsion is used as the tack coat material, the residual amount of asphalt on the pavement surface should be the same as the applied amount. Thus if 0.18 l/m^2 (0.04 gal/yd^2) of residual binder material is desired, the application rate from the distributor should also be 0.18 l/m^2 (0.04 gal/yd^2).

Breaking and Setting Time

When an asphalt emulsion is applied as a tack coat, it is brown in color because it contains both asphalt cement and water. After a very short period of time, the emulsion will break—change color from brown to black—and the water will begin to evaporate. The rate of evaporation will depend on the type and grade of the emulsion used, the application rate, the temperature of the existing pavement surface, and environmental conditions. Once all the water is gone, the emulsion is said to have “set.” The rate of set depends on the same conditions that control the rate of break of the emulsion. Under most circumstances, an emulsion will set in 1 to 2 hours.

There is some controversy about whether HMA can be placed on top of an asphalt emulsion before the emulsion is set—while some water is still retained on the pavement surface. There is even more controversy about whether HMA can be placed on top of an asphalt emulsion before it has broken—while the asphalt cement and water are still combined. In the past, it was generally believed that the emulsion should be completely set before new mix is laid on top of the tack coat material. Experience has shown, however, that new HMA can usually be placed on top of an unset tack coat and even over an unbroken tack coat emulsion with no detrimental effect on pavement performance; the bond will still be formed. Indeed, in Europe the emulsion tack coat is often applied to the pavement surface underneath the paver—from a spray bar located just behind the paver drive tires or tracks and just before the head of HMA in front of the paver screed. With this tack coat application point, the emulsion will be unbroken when the mix is laid on top of it, but the emulsion will break immediately upon contact with the new HMA. The water, 0.36 l/m^2 (0.08 gal/yd^2), typically will evaporate and escape as steam through the loose hot mix. There is not enough water to lower the mat temperature significantly.

While it is believed that the asphalt emulsion can be properly paved over before being fully set, and even before being broken, it is also important that the tack coat material remain on the pavement surface to create the bond between the layers. If the tack coat material is not



set and a significant amount of haul truck traffic runs over the unset material, much of the tack coat may be picked up by the truck tires and tracked down the roadway. Thus either the tack coat should be allowed to set before haul truck traffic is permitted to run over it, or the amount of truck traffic should be minimized.

If asphalt cement is used as the tack coat material, it will cool to ambient temperature very quickly. Further, because there is no carrier material (water) to evaporate, paving may immediately follow the asphalt cement tack coat application.

If the overlay is to be constructed under traffic, the tack coat is normally placed only a short distance in front of the paver—within the lane closure and far enough ahead for the tack to set properly before the HMA is laid on top of it. Traffic is kept off of the tack coat at all times. If the roadway being paved is closed to traffic, the tack coat can be placed as much as 24 hours ahead of the laydown operation. Doing so will ensure that the tack coat is completely set before the mix is placed on top of it. Under unusual circumstances, if traffic must travel over the tack coat before the overlay is placed, a light layer of sand can be spread on top of the tack coat to prevent its pickup by traffic. The application rate of the sand should be in the range of 2.2 to 4.4 kg/m² (4 to 8 lb/yd²), depending on the application rate of the tack coat material and the gradation of the sand. Excess sand should be broomed from the pavement surface before the overlay is placed to ensure a proper bond between the overlay and the existing surface.

If equipment problems (plant or paver breakdowns) prevent tack coat material that has been applied from the distributor from being paved over before traffic must use the roadway, it is suggested that posted speed limits on that section of roadway be significantly reduced until the overlay operation can take place. It is not good practice to place the tack coat one day, permit traffic to run over the tack coat for a period of time, and then place the overlay at a later date. Depending on the amount of residual asphalt cement on the pavement surface and environmental conditions, the level of friction available for traffic at the pavement surface may be greatly reduced by the presence of the tack coat material. The excess tack will also be thrown on vehicles, creating a major public relations problem. In addition to lowering the posted speed limits, it may be advisable to apply sand to the tacked surface as discussed above.

The application of tack coat material is essential when an overlay is being constructed on an old existing pavement surface—either HMA, PCC, or surface treatment. A tack coat often is not needed, however, when a layer of new mix is being placed over another layer of

asphalt pavement that has been laid within a few days, as long as the underlying new layer has not become dirty under traffic or from windblown dust. If a tack coat is used on a recently placed HMA layer, the residual asphalt content should be minimal—in the range of 0.09 l/m² (0.02 gal/yd²), or half of what is needed for most old, tight, existing surfaces. Thus the application rate for an undiluted SS-1 emulsion should be only approximately 0.14 l/m² (0.03 gal/yd²). Additional tack coat material is not necessary since the material will not be absorbed into the new underlying pavement surface.

SUMMARY

The following key factors should be considered when monitoring surface preparation operations:

- A prime coat is generally not needed on subgrade soil. There is a difference of opinion on the benefits of using a prime coat on a granular base course, but in many cases a prime coat can be eliminated without detrimental effect on the performance of the pavement structure.

- Before paving an existing surface, any failures in the surface must be removed and replaced or repaired by patching unless a very thick overlay is constructed.

- If there are cracks in an existing asphalt pavement surface, they generally should be sealed individually, or some type of surface treatment should be applied to the whole roadway area. Joints in PCC pavement that are poorly sealed should be routed out and sealed. Rocking PCC slabs should be stabilized.

- A rough, uneven asphalt surface should be leveled with asphalt mix (using a paver to place the mix) to fill in the low spots in the surface or should be cold milled with a milling machine to remove the high spots.

- Once the needed repairs have been completed, the pavement surface should be cleaned of all dust, dirt, and other debris. This should be accomplished using multiple passes of a mechanical broom. If brooming does not remove all accumulated dirt, flushing with air or water may be required.

- The application of a tack coat must be accomplished before an overlay is constructed on an existing asphalt or PCC surface. The distributor used should be checked to ensure that all the nozzles are open and set at the correct angle and that the spray bar is at the proper height above the pavement surface.

- The application rate for the tack coat should be based on the desired residual amount of asphalt cement on the road surface, which should be between 0.18 and 0.27 l/m² (0.04 and 0.06 gal/yd²) for normal surfaces.



The application rate should also be based on the actual amount of asphalt cement in the emulsion—whether the emulsion is diluted or not before it is applied. An undiluted SS-1 emulsion should be applied from the distributor at a rate of 0.27 l/m^2 (0.06 gal/yd^2) to obtain 0.18 l/m^2 (0.04 gal/yd^2) of residual asphalt on the pavement surface.

■ Milled pavements may need a greater amount of residual tack coat. Too little tack coat will not provide the needed bond between the old and new layers. On the other hand, too much tack coat may promote slippage of the new overlay on the old pavement or bleeding of the tack material through a thin overlay.

■ HMA usually can be placed on top of an emulsion tack coat before it has completely set, and even before it has broken—changed color from brown to black. The tack coat should not be picked up and tracked by the haul trucks, however.

■ Tack coat should not be left exposed to traffic. If doing so is necessary, proper precautions, such as reducing the posted speed limit on the roadway and sanding the surface, should be taken.

■ A tack coat is normally not needed between layers of new HMA. If used, the amount of residual asphalt on the roadway surface should be approximately half that appropriate for an old, tight, existing pavement surface.



15 Mix Placement

The primary purpose of the paver is to place the HMA to the desired width, grade, cross slope, and thickness and to produce a uniform mat texture. The paver should also be able to place the HMA in a manner that results in improved rideability and smoothness of the roadway.

There are two types of pavers—track (crawler) and rubber-tire—which are basically the same and perform similar functions in a paving operation. The track paver, whose tracks may be all steel, steel equipped with rubber pads, or an endless rubber track, offers a high degree of flotation and traction when traveling across weak underlying pavement structures by providing an increased area over which to spread the weight of the paver. This type of paver is therefore typically used when paving on a soft or yielding base. A rubber-tire paver is generally used when placing HMA over well-compacted granular base course layers or over existing HMA or PCC pavements. In addition, if the paver is to be moved regularly under its own power between paving locations, a rubber-tire paver or track paver with an endless rubber track is generally used because the travel speed of these vehicles is much greater than that of the other types of track pavers.

The paver consists of two primary parts—the tractor unit and the screed unit. The tractor unit provides the motive power to the paver and pushes the haul truck in front of the paver during the unloading process if the mix is being delivered directly from the truck into the paver hopper (see Section 13). The tractor unit also transfers the asphalt mixture from the receiving hopper on the front of the machine to the augers at the back of the paver. The screed unit is attached to the tractor unit at only one point on each side of the paver and “floats” on the HMA. The screed provides the initial texture and compaction to the HMA as it passes out from under the unit. Figure 15-1 is a schematic showing the tractor and screed units.

TRACTOR UNIT

The tractor unit fulfills all of the functions necessary to receive the asphalt mix directly from the haul trucks or to pick the mix up from a windrow, carry it through the

machine back to the augers, and then distribute it across the width of the screed. The tractor unit, equipped with either rubber tires or tracks, is powered by its own engine and provides the propulsion energy required to move the machine forward, pushing the haul vehicle ahead of it if necessary. It has the following major components: the truck push rollers, and a material feed system consisting of a mix-receiving hopper, slat conveyors, material flow gates (usually), and a pair of augers. The tractor unit also provides the motive power for the screed by pulling it behind the tractor.

Push Rollers

The push rollers, located on the front of the paver hopper, are used to maintain contact with the tires of the haul truck and to push that truck ahead of the paver. The rollers must be clean and free to rotate in order to allow smooth forward travel of the paver. If the push rollers are not cleaned periodically and do not rotate freely, the truck tires will slide on the rollers and increase the load on the paver. Moreover, if one roller rotates freely and the other does not, the paver may be more difficult to steer.

Many pavers are equipped with a truck hitch that is located underneath or incorporated into the push rollers on the front of the paver. The purpose of the hitch is to keep the truck in contact with the paver and thereby prevent the truck driver from pulling away from the paver and inadvertently dumping mix on the pavement in front of the paver. The hitch, controlled by the paver operator, has arms, with rollers attached, extending forward. The rollers are retracted into the truck tire rim and against the tire itself, preventing the truck from losing contact with the paver during the unloading process. Once the truck bed has been emptied of mix, the truck hitch is withdrawn, and the truck is able to pull away from the paver.

Material Feed System

The material feed system on the tractor unit plays a very important part in producing a consistent, high-quality mat behind the laydown machine. In this section the



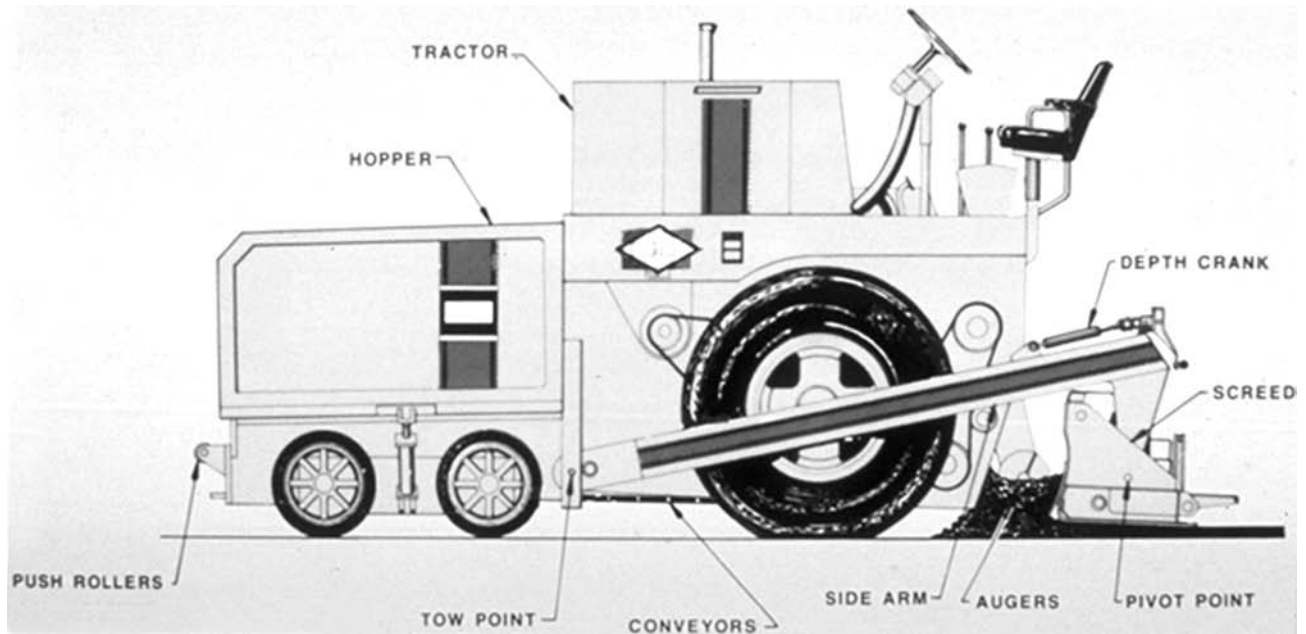

FIGURE 15-1 Schematic of HMA paver.

components of the material feed system and its basic operation are reviewed.

Material Feed System Components

As noted, the material feed system typically consists of a paver hopper, slat conveyors, material flow gates, and a pair of augers.

Paver Hopper The paver hopper, shown in Figure 15-2, is used as a temporary storage area for the asphalt mix delivered from the haul vehicle, the windrow elevator, or the material transfer vehicle (MTV). The hopper capacity compensates for the fluctuating material demands encountered when paving over irregular grades



FIGURE 15-2 Loaded HMA paver hopper.

and thus helps maintain a constant paving speed. When mix is delivered with a haul vehicle, the hopper must be wide enough to allow the body of the haul vehicle to fit within it. In addition, particularly for smaller pavers, the hopper must be low enough to permit the truck bed to be raised without the bed placing weight on the front of the hopper.

The front of the hopper is designed to minimize the spillage of mix out of the hopper during operation or while dumping the hopper wings. Overflow guards or flashing further reduces spillage out of the hopper during raising or dumping of the paver wings. The condition of these guards should be checked regularly since they are often damaged by haul truck beds as HMA is unloaded. In addition, for certain types and sizes of haul trucks, the shape of the guards may need to be changed to prevent spillage of the mix onto the existing pavement surface.

If a windrow elevator (see Figure 15-3) is used to feed mix to the paver, the hopper should have enough volume so that the paver can temporarily store the HMA if the demand for mix at the screed varies, such as when placing a leveling course. In addition, since the amount of mix in the windrow itself may vary, the hopper must be large enough to hold fluctuating amounts of mix delivered to it without overflowing or allowing the screed to run out of material. The blades on the slat conveyor of the windrow elevator must be set at the right level to pick up as much of the mix that has been placed on the existing pavement as possible. Essentially no mix should be left in the windrow, except perhaps a minimal





FIGURE 15-3 Windrow elevator.

amount in the low spots on the pavement surface when a leveling course is being placed. Any thin layer of material remaining will cool quickly and may result in difficulties in compacting the HMA. In addition, longitudinal streaks may occur in the mat behind the paver at the same location as the outside edges of the windrow.

The amount of mix in the paver hopper should always be kept at a level above the top of the flow gates or tunnel openings at the back of the hopper. Doing so permits the paver operator to keep the conveyors on the paver full and thus maintain a constant head of HMA in front of the paver screed, providing for a smooth mat behind the screed. This practice is particularly important between truckloads of mix in order to reduce segregation problems.

As shown in Figure 15-4, the sides, or wings, of the hopper are movable. Any mix left to stand for a long period of time in the corners of the hopper will cool and may appear as chunks of material in back of the screed



FIGURE 15-4 HMA paver with wings lifted.

when it passes through the paver. Thus the mix is periodically moved from the sides of the hopper into the middle of the hopper by folding the wings (sides) and depositing the mix on top of the area of the conveyors.

Many paver operators dump (fold) the wings of the paver after each truckload of mix has been emptied into the hopper. This is not good practice and should generally be avoided. Moreover, to prevent spillage of the mix out of the front of the hopper when the wings are folded, the operator often pulls down the amount of mix left in the hopper by continuing to run the slat conveyors to feed mix back to the augers after the truck has pulled away from the paver. This practice may result in the slat conveyor running nearly empty and can lead to increased mat problems if segregated mix is deposited on the conveyor slats, either from the paver wings or from the haul truck, and is carried back to the augers and screed. Thus it is not good practice to dump the paver wings after each truckload of mix has been delivered or to deposit the mix held in the wings into the empty paver hopper, because either procedure can significantly decrease the quality and smoothness of the finished mat.

To minimize segregation, the paver operator should fold the wings as infrequently as possible—only often enough to keep the material sufficiently hot for proper placement and compaction. The frequency with which the wings are dumped depends on the rate of delivery of the mix to the paver, the temperature of the mix, and environmental conditions. The wings should be emptied before the mix that collects in the corners of the hopper has cooled to the point where chunks are formed that cannot be broken up as that mix moves through the paver to the augers and under the screed. On colder and windier days, the hopper wings must be dumped more frequently than on warmer and calmer days.

When it is necessary to dump the wings, the sides of the hopper should be slowly raised as soon as the haul truck has been emptied and has pulled away from the paver. A steady forward paving speed of the laydown machine should be maintained as the hopper sides continue to rise. The wings should be fully elevated before the amount of mix remaining in the hopper is lower than the top of the flow gates or the openings at the back of the hopper. (The slat conveyors should never be visible at the time the wings are raised—or at any other time during the paving operation.) The paver should be stopped before the tunnel openings or flow gates are visible, and the sides of the hopper then lowered. This procedure minimizes the segregation problem that often occurs when the sides of the hopper are emptied, while still

cleaning the cooler mix out of the corners of the hopper. As discussed later, keeping the hopper relatively full between truckloads of mix maintains a constant head of asphalt mix in front of the paver screed and also reduces any segregation that might be present in the mix. In addition, the wings should not be “banged” repeatedly as they are emptied.

To prevent the HMA from collecting in the corners of the paver hopper and thus avoid having to dump the hopper wings to remove the cold material, a fillet can be placed in each corner of the hopper. A triangular piece of sheet steel can be bolted to the sides of the hopper, reaching from the top back corner to the floor of the hopper just outside the flow gate opening, and also to the lower front corner of the hopper. This fillet prevents mix from being carried in the corners of the hopper and eliminates the need to empty the hopper wings. The fillet can be sized and located so that it is still possible to completely fit the apron of an end-dump truck bed into the paver hopper and empty the truck without the truck bed coming in contact with the hopper.

It is also possible simply not to empty the wings of the paver at all during the paving day. If the HMA is allowed to collect in each wing, it will cool and build up a natural angle of repose. This cold HMA will then prevent new mix from the haul trucks, windrow elevator, or MTV from collecting in the wings. At the end of the day, the cold material can be removed from each wing area by raising and shaking the sides of the hopper. The two big chunks of mix can then be transported back to the asphalt plant for recycling. Although this method does prevent mix from collecting in the hopper wings following the initial buildup, it is better practice to install a fillet in each wing to eliminate both the collection and need for disposal of HMA in the wing area.

Slat Conveyors At the bottom of the paver hopper there is typically a set of slat conveyors consisting of heavy chains and flight bars (see Figure 15-5). The slat conveyors are a continuous system, with the slats being rotated back to the bottom of the hopper underneath the paver itself. These devices are used to carry the asphalt mix from the hopper through the tunnels on the paver and back to the augers. The slat conveyor on one side of the paver operates independently from that on the other side. On most newer pavers, the conveyor system operates independently of the speed of the paver, and on some pavers, the speed of the conveyors is also independent of the speed of the augers. Thus the amount of mix being carried back through the paver on one side may differ from that being delivered on the other side, and the paver



FIGURE 15-5 Slat conveyors at bottom of paver hopper.

operator can feed more or less material to either side of the paver to pave ramps, mailbox turnouts, and tapers.

On some pavers, the slat conveyor system has been replaced by a screw conveyor system. The purpose of this latter system is to remix the HMA in the paver hopper and reduce segregation behind the screed. Two parallel screw conveyors—one with left-hand pitch and one with right-hand pitch—run longitudinally down the length of the paver, one on each side of the machine, pulling the mix from the paver hopper and discharging it to the transverse augers in front of the screed. The screw conveyors are equipped with mixing paddles to blend the mix from side to side as it is moved along by the conveyor. For this system to function properly, however, there must be enough mix retained in the paver hopper between truckloads of mix—the level of mix remaining in the hopper should be above the level of the flow gates or tunnel openings at the back of the hopper—so that there is material to blend together. If the screw conveyors are visible between truckloads of mix, this system will not properly address the potential segregation problem.

To carry the mix farther back to the augers when the mix is delivered by the slat conveyors, some pavers are equipped with an extended floor plate at the rear end of the conveyor system. This plate is used to deposit the mix closer to the augers instead of letting it fall quickly to the underlying pavement surface when it comes off of the conveyors. This system is used to eliminate longitudinal segregation at the auger gearbox.

Flow Gates At the back of the paver hopper on most pavers is a set of flow gates. These gates, one over each of the two slat conveyors, are used to regulate the amount of mix that can be delivered by each conveyor



to the corresponding auger on the paver. Flow gates are found on pavers on which the speed of the slat conveyor system and that of the auger on each side of the machine are interlocked, so that the speed of the auger increases when that of the slat conveyor is increased. The gates can be moved vertically, either manually or mechanically (electrically). Depending on the vertical setting of the gates, more or less mix is permitted to enter each paver tunnel. The location of the flow gates is shown in Figures 15-6 and 15-7.

The flow gates should be adjusted to provide a uniform head of material (at a level at or just above the center of the auger shaft) in front of the screed for each particular mat width, mat thickness, and paving speed. If the demand for mix is different on each side of the machine (different paving width or mat thickness), the elevation of the flow gates should differ on each side of the hopper accordingly. On some pavers, a sensor is located behind the flow gates to monitor the amount of mix passing into the tunnel and alert the operator of a low- or a no-material flow condition.

Flow gates are not used with pavers on which the conveyor and the auger on each side of the machine are driven separately. On such machines, the speed of each conveyor can be adjusted independently of the speed of the corresponding auger. If more mix is required on one side of the machine than on the other, the speed of the conveyor on that side is increased by the paver operator or by the automatic flow control system to deliver more HMA back to the augers, thus keeping the head of material in front of the screed consistent.

Augers The mix carried to the back of the tractor unit by the slat conveyors is deposited in front of the augers (see Figures 15-8 and 15-9). Like the two slat conveyors, the augers on each side of the paver are

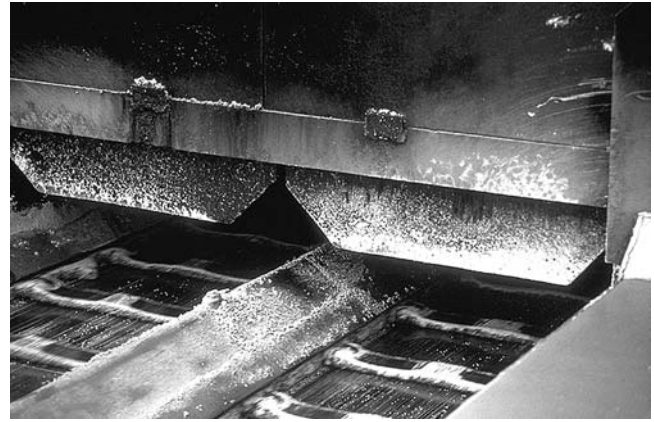

FIGURE 15-7 Flow gates at back of paver hopper.

operated independently of one another. The auger on one side of the paver, however, is usually run in conjunction with the slat conveyor on that same side of the paver (unless a paver with independent conveyor and auger drive motors—and no flow gates—is used). In addition, the paver operator has the option of running the left or right conveyor and auger system in either manual or automatic mode. In automatic mode, a feed control sensor on that side of the machine controls the level of material at the outside edge of the auger. It is extremely important that the augers carry a consistent amount of mix across the front of the screed so that the head of material in front of the screed remains as constant as possible.

The mix placed in the auger chamber from the slat conveyors is distributed across the width of the paver screed by the movement of the two independent augers. At the junction of the two augers in the center of the

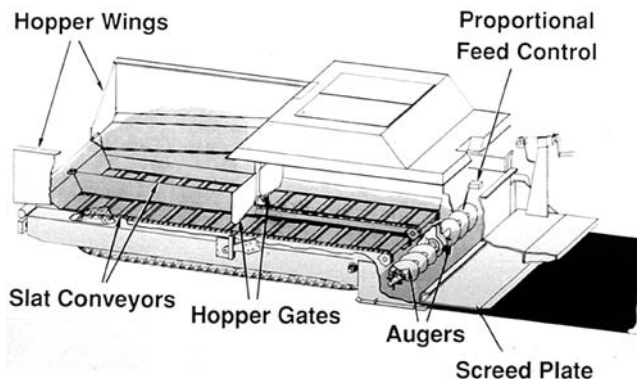

FIGURE 15-6 Material flow through paver.



FIGURE 15-8 Paver auger.

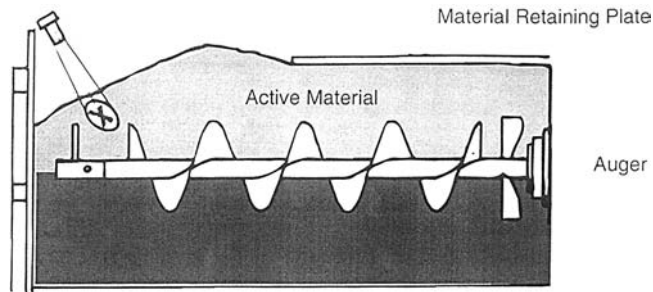

FIGURE 15-9 Schematic of paver auger.

paver, adjacent to each side of the auger gearbox, there typically is a different-shaped auger (reverse auger) or a paddle used to tuck mix under the gearbox and ensure that the mix placement at this location is the same as that across the rest of the width of the mix being laid. A paver equipped with a pair of reverse paddles is shown in Figure 15-10.

If sufficient mix is not placed under the center of the screed because of a lack of mix being tucked under the gearbox, a longitudinal streak may be seen behind the paver at the center of the screed. It is sometimes thought that such a streak is a form of segregation because the surface texture of the mat at that location is more open than that of the adjacent mix and is generally darker in color. This, however, is not really a segregation problem. Rather, the rougher texture and darker color are generally caused by a lack of mix placed under the gearbox and thus passing under the screed at that point. Indeed, if carefully measured, the elevation of the mix in the streak will be slightly below that of the surrounding mix—the streak is a low spot in the mat surface. If a gearbox streak is visible at the center of the main paver screed, installation of a reverse auger or paddle system on the paver should be considered if such a system is

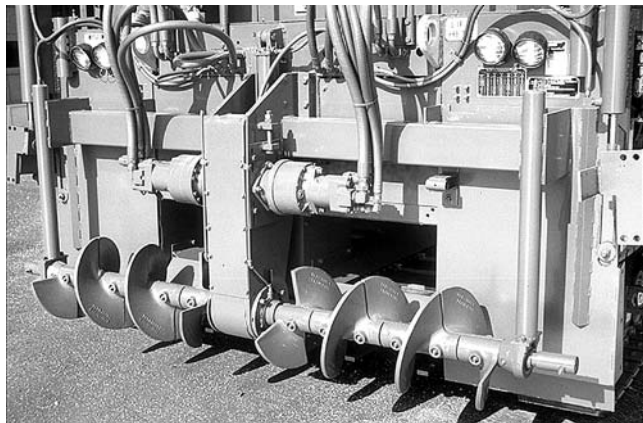

FIGURE 15-10 Paver auger with gearhousing at midpoint equipped with reverse paddles.

not already present. If the reverse augers or paddles are present, adjustments should be made to tuck more mix under the gearbox; worn augers or paddles should be replaced if necessary.

Newer pavers are equipped with variable-height augers—the elevation of the auger can be changed. The height of the auger is normally set in accordance with the paving depth. As a general rule, the augers should be set as low as possible to minimize the amount of mix carried in the auger chamber. The elevation of the bottom of the auger, however, should never be even with or lower than the top of the mix being laid, as this may result in differences in mat texture.

Operation of Material Feed System

The amount of mix carried in the auger chamber should be as constant as possible. The proper depth of material on the augers is at the center of the auger shaft, as seen in Figure 15-11. The level of material carried in front of the screed should not be so low as to expose the lower portion of the screw conveyor flights. Further, the level of mix delivered to the screed should never be so high as to cover the upper portion of the auger, as shown in the figure.

If the feed system is set and operating properly, the slat conveyors and augers on each side of the paver will rarely shut off; they will operate in a slow continuous manner. This continuous action of the conveyors and augers is accomplished by setting the proper position for the hopper flow gates (if any) and determining the correct speed setting for the slat or screw conveyors and for the augers. *The key to placement of a smooth pavement layer is use of the material feed system to maintain a constant head (level) of material in front of the screed, primarily by keeping the slat conveyors and augers running as close to 100 percent of the time as possible.* Intermittent operation of the slat conveyor and auger systems may cause roughness in the mat, as well as both auger shadows and ripples in the mat behind the screed, as discussed elsewhere in this section.

There are two types of material feed control systems conventionally used on paving machines—constant speed and variable or proportional speed. Many newer pavers have an automatic feed system based on sonic control.

Constant Speed As noted earlier, the slat conveyor and auger on one side of the paver act independently from the slat conveyor and auger on the other side of the paver. On older pavers, the speed of the slat conveyors

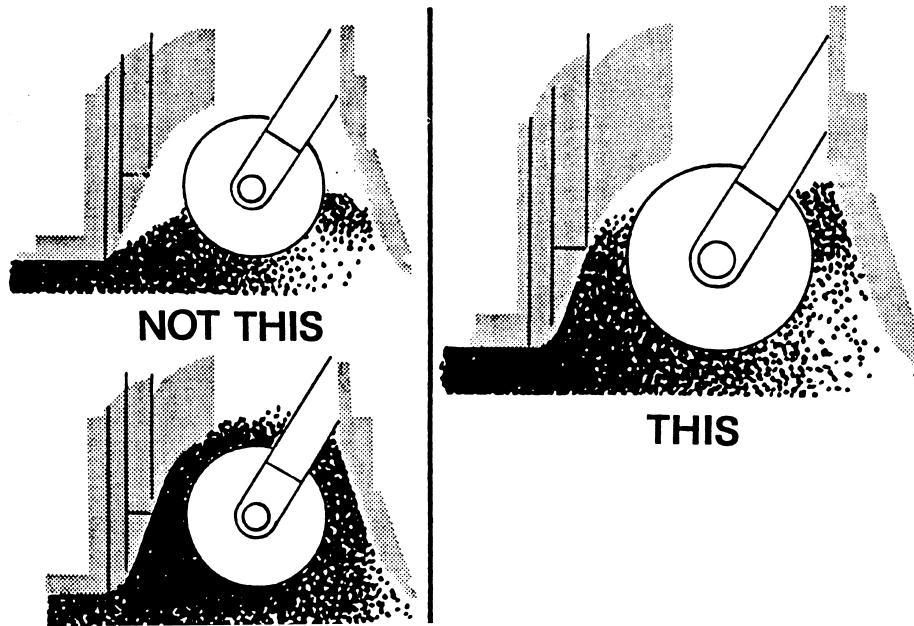

FIGURE 15-11 Correct and incorrect mix levels in paver auger chamber.

and augers is constant in manual mode. The paver operator can control the amount of mix being carried back to the screed only by adjusting the height of the flow gates.

If the gates are set too high, the material feed system will provide too much asphalt mix to the augers whenever the slat conveyors and augers are running. The result will be a significant increase in the head of material in front of the screed and increased pressure on the screed. This increased pressure will in turn change the angle of attack of the screed and increase the thickness of the mat being placed, and the angle of attack of the screed will be increased slightly as the screed rotates around its pivot point. On the other hand, if the gates are set too low, the material feed system will not be able to deliver enough material to the augers, thus reducing the head of mix in front of the screed and the force pushing on the screed. The result will be a reduction in the thickness of the mat being placed as the screed rotates around its pivot point and a decrease in the angle of attack of the screed.

As noted, with these older systems, the only way the operator can control the head of material in front of the screed is by proper setting of the flow gates at the back of the paver hopper. The flow gates and feeder on-off switches must be set at a position that allows the slat conveyors and augers on each side of the machine to run as close to 100 percent of the time as possible. For most paving operations, if the flow gates are properly set for

the paver speed, paving width, and mat thickness, the conveyor and auger systems will typically run about 80 to 90 percent of the time under manual control.

A flow control sensor or paddle can be placed on each side of the paver near the outer ends of the augers. This sensor monitors the amount of mix being carried in front of the screed and activates the corresponding slat conveyor and auger when mix is needed. This flow control system is really a limit switch in which a mechanical wand or paddle floats on top of the mix and rotates the limit switch shaft as the level of mix in front of the screed changes. When too much mix is sensed in front of the screed, the limit switch shuts off the mix delivery system. When mix is needed, the paddle rotates downward on top of the lesser quantity of mix in front of the screed, and the conveyor-auger system starts up. Even with use of a flow control sensor, however, the amount of mix delivered to the screed is actually controlled only by the position (elevation) of the flow gate on the back of the paver hopper. The height of each flow gate is set to keep the head of HMA in front of the screed constant—near the center of the auger shaft—and the delivery system running as close to full time as possible. This is very difficult to accomplish, especially if the paver is being used to level an existing pavement surface and the demand for mix is variable.

Changes in the head of material may result from the off-on-off-on operation of a constant-speed feed control system. These changes may in turn cause surface shad-

ows and ripples in the surface of the mix. This problem can be avoided through use of a variable-speed or sonic automatic feed control system.

Variable (Proportional) Speed Some pavers are designed so that in manual mode, the paver operator can select one of several speeds for the slat conveyors, each essentially a percentage of the maximum conveyor speed. Once the conveyor speed has been selected, the speed of the auger is set proportionately. The operator is responsible for controlling the speed of the slat conveyors and augers to keep a constant level of asphalt mix in front of the paver screed. The flow of material to the screed is still essentially regulated by the height of the hopper flow gates, however, and by the starting and stopping of the slat conveyor and auger on each side of the paver. With this manual system, changes in demand for mix are met by changing the speed of the feed system.

A flow or feed control sensor can also be used with this system to monitor the amount of HMA in the auger chamber in front of the screed. As the level of HMA in front of the screed rises and falls, the speed of the feed system increases or decreases to maintain a constant level and uniform flow of mix across the width of the screed.

For the automatic feed control system to function properly, the feed sensor paddle or wand should be located as close to the outside ends of the augers as possible. If rigid paver screed extensions are used, the control arm should be mounted beyond the ends of the augers, just inside the end gate on the paver screed. If a hydraulically extendable screed is used, the location of the feed sensor control arm should be such that the amount of mix carried in front of the extensions is minimized. In most cases, this means the sensor should be mounted on the end gate of the paver screed and the sensor paddle or wand hung only a short distance in front of the end of the extendable screed.

For rear-mounted hydraulic screed extensions, discussed later in this section, it is important to minimize the amount of mix carried in front of the screed on the extension. A flow control sensor system should be employed to severely limit the amount of HMA carried in front of the screed extension. That sensor should be mounted on the end gate of the screed just in front of the leading edge of the screed.

Sonic Control Newer pavers are often equipped with an automatic feed system that uses ultrasound to monitor the amount of mix being carried on the augers. This system basically operates on the same basis as a variable-speed limit switch system by measuring the

amount of mix in front of the screed and controlling the speed of the slat conveyors and auger system to maintain a constant head of material at the screed. The sonic feed system uses reflected sound waves to sense the level of mix. The system sends out pulses several times per second. A timing circuit is started when the pulse is sent out and is stopped when the first echo is received back. The length of time between when the pulse is sent out and the echo is received is used to calculate the distance to the material being sensed—the head of material in the auger chamber. The controller then varies the speed of the conveyors and augers on each side of the machine proportionally to maintain a constant level of mix across the front of the screed.

SCREED UNIT

The screed unit, which is towed by the tractor unit, establishes the thickness of the asphalt layer and provides the initial texture to the new surface. In addition, through its weight and vibratory action, the screed imparts some level of density to the material being placed. Figure 15-12 shows the paver screed and tow arms.

The concept of the free-floating paver screed was developed in the early 1930s. That concept allows the paver screed, which is attached to the tractor unit at only one point on each side of the machine, to average out changes in grade or elevation experienced by the wheelbase (rubber tires or crawler tracks) of the tractor unit. The floating-screed concept is employed on all modern asphalt pavers in use today.

Tow (Pull) Points

The screed unit is attached to the tractor unit at only one point on each side of the paver. This point, shown in Figure 15-12, is called the tow (or pull) point. The tow points are really pin-type connections that allow the leveling arms (also called side arms or pull arms) of the screed to rotate or pivot around those points. This pin connection reduces the transmission of movement between the tractor and screed units.

The concept of the tow points and the free-floating screed allows the tractor unit to provide the wheelbase for the screed unit. The screed then pivots around the tow points, which are located in the center of the length of the wheelbase on the tractor unit and respond to the average grade being spanned by the tractor wheelbase. When paving over irregular grades, the tractor can pivot much like a see-saw without changing the line of pull for the screed.



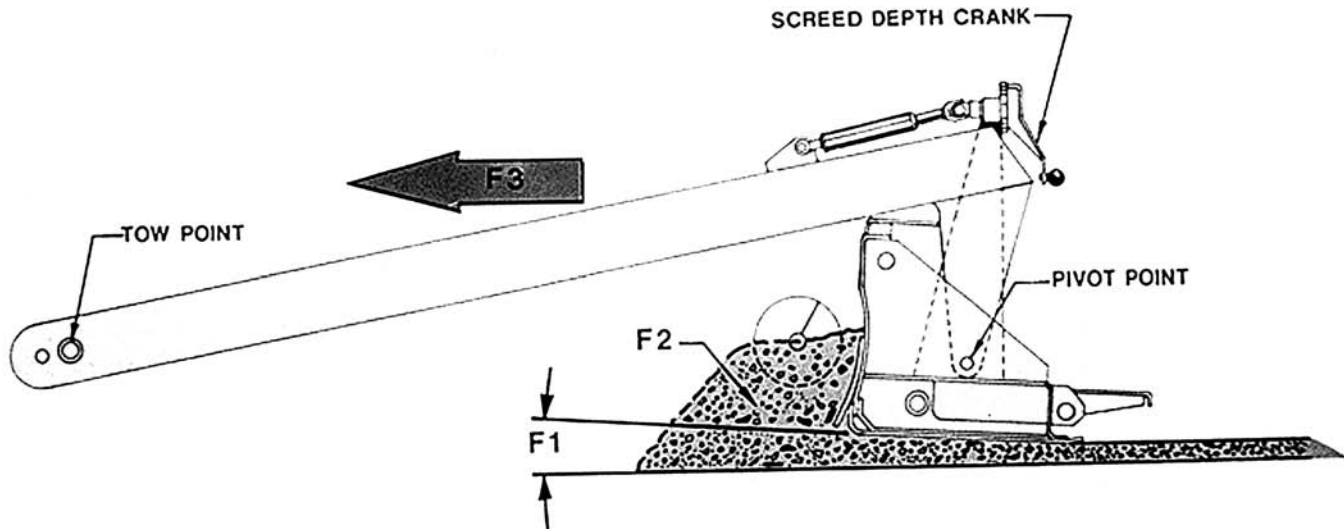

FIGURE 15-12 Action of paver screed and tow arms.

For the floating-screed principle to work properly under manual control, it is important that the tow points on both sides of the tractor be at the same level above the ground. (Automatic screed control is addressed in Section 16.) The position of the tow points can be altered by raising or lowering the rods on which the tow points are mounted. For most asphalt mixtures, the tow points are positioned near the center of the rod. For some asphalt mixtures, however, such as those that are very stiff or very tender, it may be advantageous to raise or lower the elevation of the tow points to improve the texture of the mat being placed. (If the paver is being operated under automatic grade and slope control, as discussed in the following section, the elevation of the tow points is typically centered when paving begins. The location then changes as paving proceeds to maintain the proper angle of attack of the screed.)

When some pavers are operated under manual control and the tow points are too high, the front of the screed is tilted down to maintain the proper angle of attack for the desired mat thickness. This can result in premature wear on the strike-off and the leading edge of the screed, a reduction in the smoothness of the mat, and a decrease in the degree of compaction imparted to the mix. When the tow points are too low, on the other hand, the front of the screed is tilted up to maintain the correct thickness of the asphalt mix being placed. Additional wear can then occur on the trailing edge of the screed.

For a paver not equipped with automatic screed controls, there is typically an 8:1 ratio between the movement of the tow points and the change in the angle of attack of the front edge of the paver screed. Thus if the tow

points are moved upward 25 mm (1 in.), the angle of attack of the screed will be increased by 3 mm ($\frac{1}{8}$ in.). As discussed in detail below, the paver must move forward approximately five lengths of the leveling arms before the screed moves up to the new level of the tow points and the forces on the screed are again in equilibrium.

The combination of the screed pivot points at the ends of the leveling arms attached to the tractor and the thickness control device at the screed makes it possible to adjust the angle of attack of the screed unit. The angle of attack is illustrated in Figure 15-13. Because of the way the screed is attached to the tractor, the screed acts in a manner similar to that of a water skier being pulled by a speedboat. As the motorboat goes faster, the water skier comes farther out of the water, and the angle of attack of the water skis decreases. Similarly, as the paver goes faster, the angle of attack of the screed decreases, and the mat being placed by the paver is thinner. If the skier is traveling over a calm water surface, the angle of attack of the skis will remain constant. If the skier attempts to cross the wake of the boat, however, the angle of attack of the

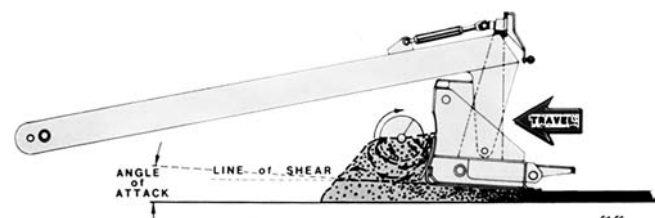

FIGURE 15-13 Angle of attack for paver screed.

skis will increase as the skis climb up over the wave. Similarly, if the head of material in front of the paver screed increases, the angle of attack of the screed will increase as the screed reacts to the increase in force on it. The result will be a thicker mat being placed by the paver.

Manual screed control is discussed in detail later in this section. First, however, forces acting on the screed and the effects of starting and stopping the paver are reviewed.

Forces Acting on the Screed

Two primary forces constantly act on the paver screed as the paver places the mix. The first is the towing force of the tractor, which varies as the speed of the paver increases and decreases. The second is the head of material pushing against the screed. As the amount of asphalt material in the auger chamber that pushes against the screed changes, the net force acting on the screed also changes. As the forces acting on the screed change, the screed must come to a new angle of attack to compensate for the change in force acting on it. In addition, the line of pull—the angle at which the tractor pulls the screed forward—will influence the attack angle of the screed.

The forces on the screed must be in equilibrium (the sum of all forces equal to zero) for the screed to remain at a constant angle of attack as it is towed by the tractor unit. When a change in any one force occurs, the screed will rise or fall, and the thickness of the mat being placed will change accordingly. A change in the angle of attack of the screed will also result. The screed will react to the change in the force against it until it reaches a new equilibrium elevation where the forces are in balance.

Paver Speed

Because the speed of the paver has a major effect on the angle of attack of the paver screed, it is good paving practice to keep the speed as consistent as possible during lay-down operations. Under manual material flow control and screed control, if the other forces on the screed remain constant, an increase in the paver speed results in a decrease in the thickness of the asphalt layer being placed. This occurs at the faster paver speed because the angle of attack of the screed has changed. As the speed is increased, the angle of attack of the screed decreases, and the thickness of the mat placed also decreases until an equilibrium condition is again reached. Similarly, a decrease in the speed of the paver causes an increase in the thickness of the mat. The screed then climbs to a new elevation until its equilibrium is reestablished.

The above occurs, however, only as long as no other changes are made in the system—if the level of the tow points and the amount of mix in the auger chamber remain constant. It should be noted, however, that as the paver speed is increased or decreased, the rate of feed of HMA through the paver must also be changed to maintain a constant head of material in the auger chamber. As the paver speed increases, if no additional mix is delivered by the slat conveyors to the augers to compensate for the change in demand for mix, less mix is available to pass under the screed, and the thickness of the layer is further reduced.

If the paver operator manually changes the amount of mix fed back to the augers or if the feed control sensors accomplish the same function automatically, the angle of attack of the screed remains constant because of the effect of the head of material in front of the screed. As discussed above, however, the thickness of the mat placed still changes because of the change in paver speed. To maintain a constant mat thickness with a change in paver speed, therefore, a manual change must be made in the setting of the thickness control screws (depth cranks) located at the paver screed. For an increase in paver speed, the depth crank must be turned so that the screed rotates around its pivot point, and the angle of attack is increased manually to compensate for the decrease in angle of attack that naturally occurs when the speed is increased. Similarly, for a decrease in paver speed, the depth crank must be turned in the opposite direction so that the angle of attack of the screed is manually decreased to compensate for the automatic increase in the angle of attack that occurs when the speed of the paver is decreased. The amount of manual change needed in the setting of the thickness control screws, up or down, depends on the amount of change in the speed of the paver, faster or slower, respectively.

Those not familiar with the forces acting on the paver screed often assume that the thickness of the mat being placed increases as the speed of the paver increases (for a constant head of material maintained in front of the screed). This assumption is incorrect, as explained above. In fact, the opposite is true. Thus to fully understand the effect of a change in the speed of the paver on the angle of attack of the screed, one must remember that for the forces on the screed to be in equilibrium, each change in force must be accompanied by an equal, but opposite, change in force.

It is highly desirable to keep the speed of the paver constant in order to maintain a constant angle of attack of the screed and thus a constant thickness of the mat being placed. The speed of the paver should thus be matched to



the production rate of the asphalt plant and to the thickness and width of the mat being placed. The maximum paver speed can be determined for different combinations of plant production rates and mat thicknesses.

As an example, for a mat that is 3.7 m (12 ft) wide, the paver should be operated at a speed of only 4.6 m (15 ft) per minute in order to place all of the mix provided by a plant producing HMA at a rate of approximately 91 tonnes (100 tons) per hour at a compacted layer thickness of 25 mm (1 in.). Similarly, for a plant production rate of 454 tonnes (500 tons) per hour, for the same mat width of 3.7 m (12 ft) and for a compacted layer thickness of 50 mm (2 in.), the maximum paver speed should be approximately 11.5 m (38 ft) per minute.

As noted earlier, to achieve the smoothest possible mat behind the paver screed, it is essential to keep the paver moving at a constant speed at all times. There is no sense in running the paver faster than necessary to place all of the delivered mix and then stopping to wait for the next haul truck to arrive at the paving site. The subject of slowing the paver down or stopping it between truckloads of mix is discussed further below.

Head of Material

If the volume of mix in the auger chamber is increased, the force on the screed also increases, causing the screed to rotate around its pivot point and thus rise. This action then causes the angle of attack of the screed to increase until a new equilibrium position is reached, resulting in placement of a thicker mat. If the amount of material being carried on the augers is decreased, the thickness of the mat is reduced, all other factors being equal, as the angle of attack of the screed decreases. Thus one of the primary factors affecting the consistency of the thickness of the layer being constructed is the consistency of the head of material (amount of HMA) in front of the paver screed.

The head of material in the auger chamber is directly affected by the operation of the slat conveyors and augers on each side of the paver. When the slat conveyors and augers are operating, the mix is pulled from the paver hopper, through the tunnel, and is distributed across the front of the screed by the augers. As long as this flow of material is relatively constant, the head of material pushing against the screed remains relatively constant as well, and the mat being placed has a smooth and consistent texture.

If the head of material is allowed to vary, however, the screed moves up and down in relation to and reac-

tion to the forces acting on it. As the amount of mix being carried by the augers is decreased because the slat conveyor and auger systems are shut off, the screed moves downward, thus reducing the thickness of the mat behind the screed. As the slat conveyor and auger systems come on, more mix is carried back to the augers and across the front of the screed. This increases the force on the screed and causes it to rise to a new elevation, resulting in a thicker mat. Thus, the position or elevation of the flow gates is very important in regulating the amount of mix in front of the screed.

The head of material is affected each time the slat conveyors and augers are turned off and on. This is true particularly if the position of the flow gates is not properly set initially. For this reason, as suggested earlier, the use of a variable-speed or sonic automatic feed control system is important because these types of devices keep the slat conveyors and augers running as much of the time as possible, provided the flow gates are properly set. This in turn keeps the head of material relatively constant and allows the screed to place a mat of consistent thickness. A constant head of material against the paver screed also significantly reduces the occurrence of ripples and auger shadows.

If the paver is not equipped with flow gates, the speed of the conveyors and augers must be controlled so that the head of material is kept constant. For either type of system, however, with or without flow gates on the paver, a consistent head of material in front of the screed is associated with a consistently smooth mat behind the paver.

Another factor that affects the uniformity of the head of material in front of the screed is the temperature of the mix. If a cold load of material is deposited in the paver hopper and carried back to the screed by the slat conveyors and the augers, the colder, stiffer mix increases the force acting on the screed and causes the screed to rise, increasing the thickness of the layer placed. If, on the other hand, a hot load of mix is delivered to the paver, the decrease in viscosity of the binder material reduces the stiffness of the HMA and reduces the force of the mix on the screed when the mix is deposited in front of it. This situation causes the screed to fall and reduces the layer thickness.

Line of Pull

The line of pull refers to the angle at which the screed is pulled forward. A smoother pavement surface is generally placed when the towing force is applied relatively

parallel to the grade over which the tractor unit is running. Thus the elevation of the tow points should be set in relation to the thickness of the mat being constructed. As a general rule, thin lifts of HMA require a lower initial tow point setting, while thick lifts of mix require a higher initial setting. Setting the initial tow point height to match the thickness of the material being placed results in the towing forces applied to the screed being relatively parallel to the grade. Unwanted influences that might cause texture and smoothness problems are not applied to the screed.

For a relatively thin mat, if the tow point setting is extremely high, the towing forces are applied at an upward angle that increases the lift forces acting on the screed. To maintain a given thickness of material, the angle of attack of the screed must then be decreased to compensate for the increased lift. In this condition, the screed runs at a slightly nose-down angle of attack. Only the front portion of the screed is then compacting and finishing the HMA being placed; the result is poor mat texture and extreme wear on the front portion of the bottom of the screed plate. In addition, when the paver stops, the screed has more of a tendency to rock or teeter as the tractor relaxes the tension on the screed. This may increase the amount of settling of the screed and introduce bumps into the mat.

For a relatively thick mat, if the tow point setting is extremely low, the towing forces are applied at a downward angle that decreases the lift forces applied to the screed. To maintain a given thickness of HMA, the angle of attack of the screed must then be increased to compensate for the decreased lift. In this condition, the screed runs at a slightly nose-up angle of attack, with only the rear portion of the screed compacting and finishing the mix being placed. This causes poor mat texture and extreme wear on the rear portion of the bottom of the screed plate. Increased control of the forces applied to the screed is thus gained by setting the tow points in relation to the thickness of the mat being placed.

Effects of Stopping and Starting the Paver

Short Stops

If the paver can be operated continuously at a constant speed without stopping, the smoothness of the mix placed should be excellent, as long as the screed operator does not continually change the angle of attack of the screed by turning the thickness control cranks and the head of material in front of the screed remains constant.

If bottom-dump trucks are used to deliver the mix from the plant to the laydown machine, there is a chance that the paving operation can be continuous if there is a long enough windrow of mix out ahead of the paver. If the next truck does not arrive at the paving site before the end of the windrow is reached, however, the paver will obviously have to stop and wait until more HMA is windrowed by the truck and is available to be picked up by the windrow elevator on the paver.

If an MTV is used to deliver mix from the haul vehicles to the paver hopper, there is also a chance that the paving operation can be continuous as long as the haul trucks arrive at the MTV before it runs out of mix. Since the MTV is essentially a surge bin on wheels, as discussed in Section 13, the amount of mix it can carry is limited, even taking into account the additional mix in the extended hopper on the paver. If the next haul truck does not arrive in time to keep the MTV and the paver hopper from becoming empty, the paving operation must come to a halt.

If end-dump or live-bottom trucks are used to deliver the mix to the hopper on the paver, there is little chance that a continuous paving operation can be accomplished unless the paving speed is very slow. Since the speed of the paver affects the angle of attack of the screed, and therefore the smoothness of the mat being placed, maintaining a constant speed without stopping is a desirable but unrealistic goal. For the paver to be able to keep moving forward at the selected paving speed while the truck exchange process was being completed, the following things would have to occur very efficiently if end-dump trucks were being used: the bed of the empty truck would have to be lowered, that truck would have to pull out away from the paver, the next truck would have to back up to the paver, the bed of that truck would have to be raised (if not done ahead of time, as it should be in order to move the mix back against the tailgate of the truck; see Section 13), and the tailgate would have to be opened and mix delivered into the paver hopper. All of this would have to happen before the amount of mix in the paver hopper had been reduced to a level below the top of the hopper flow gates so that the head of material in front of the screed would not be affected. On real paving projects, this level of efficiency is not normally obtained consistently.

Typically, the paver operator starts to slow the paver down once the haul truck is empty, the windrow runs out, or the MTV is almost empty. The operator usually hopes that the next truck will arrive before the paver is out of mix. Sometimes that occurs, but often it does not,



and the paver is stopped. As the paver is gradually slowed down, however, the angle of attack of the screed changes (increases), and the thickness of the mat increases slightly. If the hopper is emptied of mix, the head of material in front of the screed is reduced, the angle of attack of the screed is decreased, and the thickness of the mat is also decreased—a gradual dip is built into the pavement surface.

Once new mix has been delivered into the empty paver hopper, either from the haul vehicle, from the windrow elevator, or from the MTV, the paver operator usually starts the slat conveyors on the paver and pulls a slug of mix back to the augers. The head of mix in the auger chamber builds up, and the paver is quickly brought back to paving speed by the operator. The high head of material causes the screed to rise and the mix thickness to increase. Because the paver reaches paving speed quickly, the paver speed has little effect on the angle of attack of the screed, given the delayed reaction time of the screed. The net effect of the high head of material and the quick increase in paver speed is a thicker pavement section—a bump is built into the pavement surface.

If the mix in the haul truck is segregated, and if that segregated mix is delivered into the empty paver hopper from both the end of one truckload and the beginning of the next truckload, the segregated coarse aggregate particles will be carried back to the augers and dumped on the pavement surface immediately in front of the low spot just constructed by the screed. If this occurs, truckload-to-truckload segregation (see Section 13) will be both felt (as a gradual dip and then a bump in the pavement surface) and seen.

If the paver needs to be stopped because additional mix is temporarily not available, it should be stopped as quickly and smoothly as possible, and before the level of mix in the hopper is drawn down below the top of the flow gates or the tunnel openings. This will keep the head of material in front of the screed constant at the same time that the effect of the change in the paver speed on the angle of attack of the screed is minimized because of the rapid speed change.

When more HMA arrives, it should be placed into the “half-full” paver hopper from the haul truck, windrow elevator, or MTV. The paver operator should then return the laydown machine to the desired paving speed as quickly as possible, again minimizing the effect of the change in paver speed on the angle of attack of the screed. Since the head of material has been kept constant, a smooth mat will be constructed—no dip, no bump, and no segregation. It has been found that the “rapid stop, rapid start” procedure for stopping the

paver provides for good mat smoothness and consistent mat thickness.

Longer Stops

If there is going to be a long delay before the arrival of the next haul vehicle, consideration should be given to constructing a transverse joint, as discussed in Section 17. The acceptable length of a delay so that it is still possible to place and compact the mix to obtain the required level of smoothness and density will depend on a number of factors, including the environmental conditions (air temperature, surface temperature, and wind velocity) at the paving site, the temperature of the mix in the paver hopper, and the uncompacted thickness of the mat beneath the screed.

If it is decided not to construct a transverse joint but to put the paving operation on temporary hold until the next haul truck arrives, the paver should be stopped with the hopper as full as possible—above the level of mix that is typically kept in the hopper (above the top of the flow gates or tunnel openings) during short stops. Keeping the hopper full will reduce the rate of cooling of the mix during the waiting time because the mix will remain in a mass. In addition, the paver should not be moved forward during the waiting period, but should remain in one position until the new mix is available.

There is a tendency for the paver operator to sit in one spot for a while, move the paver forward a short distance, and then wait again. If the next truck does not arrive shortly, the operator often repeats this process until the paver hopper is empty. This practice is incorrect and can lead to the construction of a significant length of poor-quality pavement.

While the paver is sitting in one spot, the mix in the paver hopper will cool. The rate of cooling will be reduced if the amount of mix in the hopper is kept constant; as suggested above, the greater the mass of mix, the slower will be the rate of temperature loss. If the paver is moved forward periodically and the amount of mix in the hopper is decreased as some of the mix is laid by the paver, the rate of cooling of the remaining mix will increase. Depending on when the next haul truck arrives and how many moves the paver makes, the level of mix left in the paver hopper may become very low and the material quite cold.

Further, while the paver is stopped, a certain amount of mix will be retained in the auger chamber—the head of material in front of the screed. Since a portion of this HMA is in contact with the underlying pavement surface, cooling of this material will take place. In addi-



tion, the HMA that is actually under the paver screed and in contact with the existing surface will cool—even more rapidly than the mix in the auger chamber—because of the thinner layer and lesser volume of the uncompacted mix under the screed. Further, there will be some distance of mix behind the paver screed that cannot be reached by the rollers. Typically this length is about 1 m (3 ft) and is related to the amount of overhang of the walkway on the back of the screed and the curvature of the roller drum or tires. For most pavers, the total length of mix from the front of the auger chamber to the front edge of the roller drum that will cool quickly and be uncompacted will range from 2 to 3 m (6 to 9 ft). If the paver remains in one spot while waiting for the next truck to arrive, that distance of mix will usually have a lower level of density than the rest of the mat since the compactive effort of the rollers cannot be applied in this area, and the mix will be cooler when the paver finally moves forward.

Even more low-density mix will be placed if the paver moves forward periodically while awaiting the arrival of more mix. Each time the paver moves and stops, another distance of mix in contact with the existing pavement surface between the augers and the rollers will cool quickly, and proper density will probably not be achieved. In addition, as the hopper is periodically emptied, not only will the remaining mix lose temperature more rapidly, but the head of material in front of the screed will be reduced, and a low spot or dip will be built into the pavement surface. Good paving practice therefore dictates that the paver remain in one position, with the hopper as full as possible and the head of material constant, until additional mix arrives.

Manual Screed Control

In this section, procedures involved in manual screed control are reviewed. Automatic screed control and the ways in which it differs from manual control are covered in Section 16.

Thickness Control Cranks

As noted earlier, the screed is attached to the leveling or tow arms on each side of the paver through pivot points. The thickness control mechanism, usually either a crank or a handle, allows the screed to be moved or rotated around the pivot points. The key to the leveling action of the screed is its ability, by rotating around the pivot points and being attached to the tractor unit only at the tow points, to establish an equilibrium position based on the forces applied to it. As the mix passes under the

screed plate, the screed floats on the mix, establishing the mat thickness and the texture of the material, as well as providing the initial compaction of the HMA.

For a constant position of the tow points (the tractor unit running on a level surface and without automatic screed controls), altering the setting of the thickness control devices changes the angle of attack of the screed and the forces acting on the screed. This in turn causes the screed to move up or down to a new elevation as the paver moves forward, thus altering the thickness of the mat being placed. The reaction of the screed to changes in the position of the thickness control settings, however, is not instantaneous. Rather, there is a lag in the reaction that allows the screed to average out variations in the input forces acting on it.

Yield

There is a tendency for the screed operator to continually turn the thickness control cranks in order to control the amount of mix being placed. This is particularly true of paving projects on which the yield—the amount of mix available to be laid (set up in the plans) over a given area—is tightly controlled. Frequently the screed operator will check the mat thickness using a rod or ruler (depth gauge) at a given point. On the basis of that single reading, the operator often will then adjust the setting of the thickness control cranks, changing the angle of attack of the screed and thus the thickness of the mat. When a subsequent check is done a short time later and the depth measured does not match the required uncompacted thickness, another change is made in the setting of the thickness control cranks and the angle of attack, so that the thickness of the mat is altered once again. This approach of using individual measurements to set the screed does not accomplish the desired goal of obtaining a smooth mat, nor does it typically accomplish the goal of correctly controlling the amount of mix placed along a given length of pavement.

Because of the delayed reaction time of the screed, discussed further below, there is a significant lag between the time the thickness control cranks are turned and the time the screed attains the new equilibrium point at the new thickness level. A single mat depth measurement should not be used to justify a change in the angle of attack of the screed. Indeed, even two or three measurements should not be averaged to determine whether a change in the setting of the thickness control cranks is needed. If the uncompacted thickness of the mat is to be checked using a depth gauge, the mat thickness behind the screed should be measured at least five times at 2-m



(6-ft) intervals longitudinally. The thickness control cranks should then be turned only if the average measured thickness is more than 6 mm ($\frac{1}{4}$ in.) less or more than the desired uncompacted thickness of the mat.

A better way to check yield, if it must be measured periodically, is to determine the distance that the amount of mix in 10 truckloads of HMA should cover, based on the width and uncompacted thickness being laid. This distance is then compared with the length the paver has actually placed using the same number of tonnes (tons) of mix. If the distance covered is significantly less than it should have been, the setting of the thickness control cranks should be changed to slightly decrease the angle of attack of the screed, decreasing the amount of mix placed and therefore increasing the distance a given amount of material will cover. If the distance covered is significantly greater than it should have been, the thickness control cranks should be turned a small amount in the opposite direction to thicken the mat.

Screed Reaction Time

Figure 15-14 shows the reaction time of the screed when a change is made in its angle of attack, either at the screed or at the tow points. After the tow points have been raised, it takes approximately five times the length of the leveling or tow arms on the paver screed for the screed to complete 99 percent of the change, up or down, to the desired new elevation. This means that if the length of the leveling arms is 3 m (10 ft), the paver must move forward at least 15 m (50 ft) before the required input to the thickness control device is completely carried out by the paver screed. The same applies if the angle of attack of the screed is changed by turning the thickness control cranks on the back of the paver at the screed itself.

Changing the Screed Pivot Point As an example, assume that it is desired to increase the thickness of the mat being placed from 25 mm (1 in.) to 37 mm ($1\frac{1}{2}$ in.). An input is made to the thickness control crank by turning it to change the angle of attack of the screed. The movement of the thickness control mechanism causes the screed to move around the pivot points and increases the angle of attack.

As shown in Figure 15-14, approximately 63 percent of the thickness change in the mat is accomplished after the paver has moved forward a distance equal to one leveling arm length, or 3 m (10 ft) in this example. As the paver moves forward another 3 m (10 ft), about 87 percent of the desired thickness change is completed. Approximately 95 percent of the thickness change is accomplished by the time a distance of 9 m (30 ft) has been traveled—three leveling arm lengths of 3 m (10 ft) each. Only when the paver has moved down the roadway a distance equal to at least five leveling arm lengths, however, is some 99+ percent of the thickness change completed.

The above example applies also to a reduction in the thickness control settings at the screed. A screed operator desiring to reduce the depth of the asphalt layer turns the thickness control crank in the opposite direction and causes the screed to rotate around the pivot points. As the paver moves forward, the decreased angle of attack of the screed causes it to move downward, thereby reducing the amount of mix being fed under the screed. The screed continues its downward movement until the forces acting on it are again in equilibrium. If the pavement layer depth were being changed from 37 mm ($1\frac{1}{2}$ in.) to 25 mm (1 in.), the paver would still have to move more than five lengths of the leveling arm before 99+ percent of the thickness change would be completed.

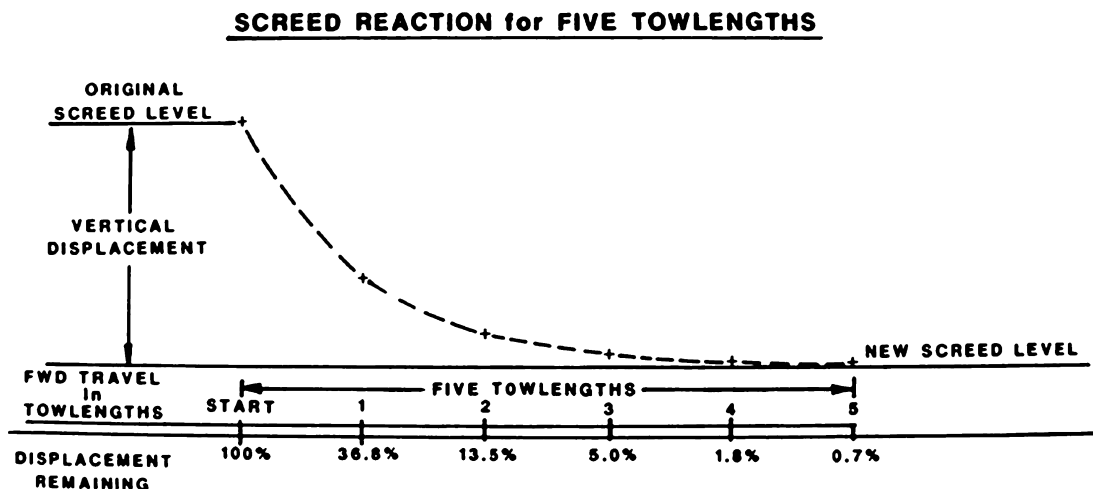

FIGURE 15-14 Screed reaction time.

The reaction time of the screed is the same regardless of the amount of change input to the thickness control cranks. Thus whether the cranks are turned enough times to increase the thickness from 25 mm (1 in.) to 50 mm (2 in.) or more times to increase the thickness from 25 mm (1 in.) to 75 mm (3 in.), at least five times the length of the tow arm will be required for the change to be completed. The reaction time is also the same if the thickness is decreased, from any level to any other thickness, regardless of the actual amount of the thickness change.

When a paver is being operated manually, it is essential for the screed operator to be aware of this lag in the reaction time of the screed. As noted, the paver must move forward at least one leveling arm length before 63 percent of the thickness change is completed. If a second change in the setting of the thickness control crank is made before the first change has been accomplished, the first change will never be completed, and it will still take an additional five times the length of the leveling arm for the second thickness change to be carried out. For this reason, continual changes in the setting of the thickness control devices are likely to be highly detrimental to the development of a smooth mat.

Changing the Tow Point Elevation The above discussion applies to a change in the location of the tow points of the screed leveling arm where it is attached to the tractor unit. If the tow points are displaced, the change in their elevation translates to a change in the angle of attack of the paver screed. The paver must still move forward for a distance of approximately five times the length of the leveling arm on the machine for the screed to react to the change in the location of the tow points and move up or down to the new elevation.

As a roadway is being paved without the use of automatic grade and slope controls, the tractor unit moves upward and downward in response to the grade of the underlying pavement. The vertical movement of the tractor translates into vertical movement of the tow points on the sides of the paver. Each time the tractor goes over a hump or into a dip in the existing pavement surface, the elevation of the tow points changes. This in turn alters the angle of attack of the screed, causing the amount of material flowing under the screed to be decreased or increased. The fact that it takes five times the length of the leveling arm before the screed reacts completely to a change in the location of the tow points allows the screed to reduce the thickness of the asphalt mix being placed over the high places in the existing surface and to place more mix in the low spots on the present roadway. It is this averaging or leveling action

that forms the basis for the floating-screed principle discussed earlier.

The use of automatic paver controls, discussed in the next section, allows the paver to construct a smoother pavement by keeping the location of the screed tow points constant, relative to a predetermined reference, as the tractor unit moves up and down vertically in response to small changes in the grade of the underlying pavement surface. By maintaining the tow points at a constant relationship to the predetermined reference while the tractor moves vertically, the force on the screed remains constant, and the angle of attack of the screed is consistent in comparison with the reference. This allows the screed to carry out the leveling action needed over a longer reference length in order to reduce the roughness of the existing surface through the application of the new asphalt layer.

Screed Strike-Offs

The screed on some pavers is equipped with a device on its front edge called a strike-off (or sometimes a pre-strike-off). The purpose of this device is to control the amount of HMA allowed to pass under the nose of the screed, thereby affecting the screed's angle of attack. The strike-off is also used to reduce the wear on the leading edge of the screed. The proper positioning of the strike-off assembly is illustrated in Figure 15-15.

When the strike-off is attached to the front of the screed, its position becomes important relative to the ability of the screed to handle the asphalt mix properly. If the strike-off is set too high, as shown in the figure, extra material is fed under the screed, causing the screed to rise. The resulting increase in the mat thickness must be overcome by manually reducing the angle of attack of the screed, using the thickness control cranks. This in turn causes the screed to pivot around its pivot points and ride with a slight nose-down-lower angle of attack. Rapid wear of the screed nose plate results. Moreover, only the front portion of the screed is compacting and finishing material being placed, and this often leads to inconsistent mat texture. In addition, the screed settles when the paver is stopped between truckloads of mix because the screed's weight is carried only on its front.

On the other hand, when the strike-off is set too low, the thickness of the lift is reduced because not enough HMA is allowed to pass under the screed. To maintain the proper mat thickness, the angle of attack of the screed must be altered, causing the screed to ride on its tail in a slight nose-up attitude. This increases the wear on the back edge of the screed and reduces the compactive effort applied by the screed. It also causes the screed to settle whenever the paver is stopped because



Main Screed Strike-Off

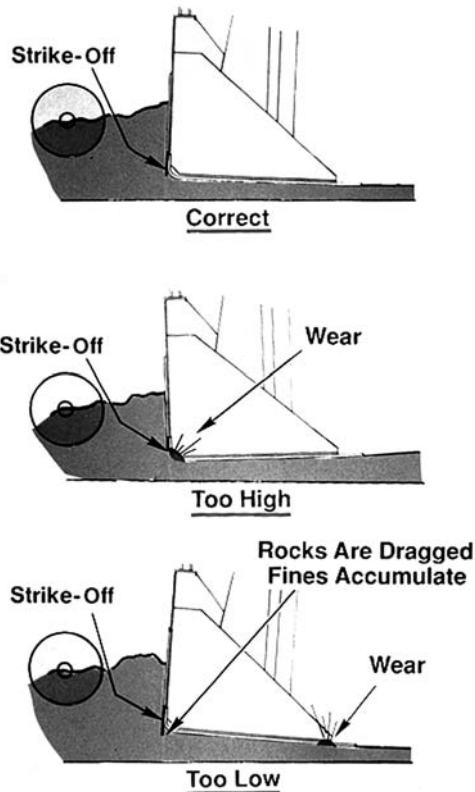

FIGURE 15-15 Proper positioning of strike-off assembly.

of the concentration of the screed's weight on a smaller surface area. The exact location of the strike-off depends on the make and model of paver being used and on the depth of the layer being placed by the paver. For relatively thin layers of pavement [25 mm (1 in.) thick or less], the strike-off is usually placed lower than when thicker lifts of mix are being placed. Similarly, for thick lifts of asphalt pavement [greater than 50 mm (2 in.)], the strike-off assembly is usually raised slightly above the normal position. In general, the strike-off is located in the range of 5 to 13 mm ($\frac{3}{16}$ to $\frac{1}{2}$ in.) above the bottom plane of the main screed plate. No compaction of the mix occurs under the strike-off.

Screed Heaters

The screed is equipped with two or more heaters or burners, depending on the age and model of the paver. The purpose of the heaters is to preheat the plate on the bottom of the screed to the temperature of the HMA being laid. The screed should be heated before paving operations begin and at any time the screed has been raised out of the mix for an extended period. The screed must be at

nearly the same temperature as the asphalt material passing under it to ensure that the mix does not stick to the screed plate and tear, imparting a rough texture to the mat. A properly heated screed provides for a more uniform mat surface texture and a more consistent mat thickness.

To preheat the screed, the burners are normally operated for a period of 10 to 20 minutes before the lay-down operation begins. Care should be taken to avoid overheating, which can cause permanent warping of the screed plate. Electric screed heaters are now sometimes used and tend to provide more uniform heating of the screed. Usually within 10 minutes after paving has begun, the temperature of the screed plate has increased to the point at which it can generally be maintained by the temperature of the mix passing under it. Thus the burners are not needed and are shut off. A major misconception is that the heaters can be used to heat up cold material as it passes under the screed. This is simply not true: at the very best, only the very top surface of the mix is warmed up slightly, while the bottom of the screed may be superheated to the point of warping. For the same reasons, the screed heaters should not be used in an attempt to increase the temperature of the mix sitting under the screed for a period of time while awaiting the arrival of the next haul truck.

In cool weather—during start-up when the plant is cold, the haul truck beds are cold, and the paver metal is cold—it is sometimes advantageous to start paving with the second or third truckload of mix delivered to the paver, rather than the first load produced and delivered. This second or third load of mix is typically higher in temperature than the first load and will therefore serve to heat the paver more and reduce the amount of tearing that might occur under the screed. Placing the second or third truckload of mix first can provide for a more uniform surface texture when paving must be accomplished in lower ambient temperatures.

Screed Crown Control

The screed can be angled at its center to provide for positive or negative crown. The amount of crown that can be introduced into the screed varies with the width of the screed and with the make and model of the equipment. The crown is typically adjusted using a turnbuckle device to flex the bottom of the screed and impart the desired degree of crown. When rigid extensions are used in conjunction with the screed, the crown being placed in the pavement by the paver can usually be altered as well at any of the points where the extensions are joined. If a hydraulically extendable screed is being used with the paver, the crown can be introduced not only in the cen-

ter of the screed, but also at the points between the screed and the hydraulic extensions.

Most of the paver manufacturers recommend that the screed be warped slightly, from front to back in its center, to facilitate the passage of mix under the screed and to obtain a more uniform texture on the asphalt mat. This process involves setting the lead crown on the screed slightly above the tail crown on the screed. In general, there should be more lead than tail crown, but the amount of difference depends on the make of paver and the type of screed. Normally the lead crown setting is 1 to 5 mm ($\frac{1}{32}$ to $\frac{3}{16}$ in.) greater than the tail crown setting, with 3 mm ($\frac{1}{8}$ in.) being the average difference between the crown settings.

For hydraulically extendable screeds, discussed below, some paver manufacturers do not recommend setting any amount of lead crown into the front edge of the screed. Because of differences in the recommendations for different makes and models of pavers, it is suggested that the manufacturer's operation manual be consulted before the crown is set into the screed.

Screed Vibrators

The amount of compaction imparted to the asphalt mix by the screed is a function of many variables. The properties of the mix itself are important—its stiffness, its temperature, and the amount of asphalt cement and moisture it contains all affect the ability of the screed to densify the mix. The degree of compaction achieved is also affected by the amount of bearing pressure applied to the mix by the screed, as well as the thickness of the HMA passing under the screed.

Two factors within the screed itself also contribute to the degree of compaction achieved: the frequency of vibration (number of vibrations per minute) and the amplitude (amount of force) imparted by the screed. The frequency of vibration is controlled by the rotary speed of the vibrator shaft and is adjusted by turning a control valve located on the screed. Increasing the revolutions per minute of the shaft will increase the frequency of the vibration and thus the compactive effort. In general, the vibrators should be used at the highest frequency setting to obtain the maximum compactive effort from the screed.

The applied amplitude is determined by the location of the eccentric weights on the shaft. The position of the eccentric weights can be altered to increase or decrease the amount of compactive effort applied to the mix by the screed, as illustrated in Figure 15-16. Typically, the amplitude setting selected is related to the thickness of

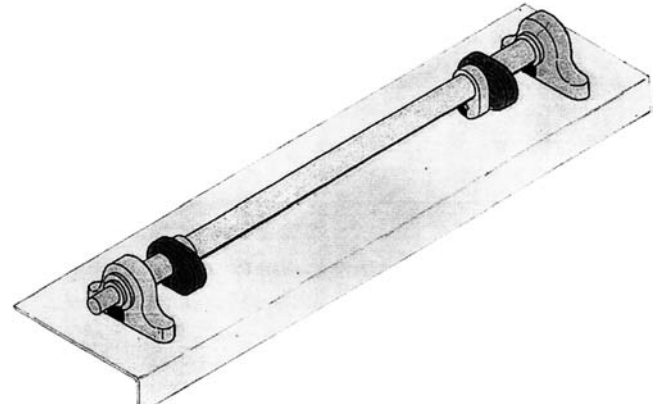

FIGURE 15-16 Screed vibration shaft with weights.

the mat being placed—lower amplitude for thinner lifts and higher amplitude for thicker lifts.

The density achieved by the paver screed is also a function of the speed of the paver. As the paver moves faster, the screed dwells for less time over any particular point in the new mat, and thus the amount of compactive effort applied by the screed decreases. It can be expected that approximately 75 to 85 percent of the theoretical maximum density of the HMA will be obtained when the mix passes out from under the paver screed.

On some paving projects, the screed is not used in the vibratory mode—the vibration is shut off. This is often done so that members of the paving crew can walk across or ride on the screed in relative comfort; it is difficult to ride on the screed all day if it is vibrating. To derive the benefits of the screed in obtaining the density of the mat, however, the screed should be operated in the vibratory mode, and the crew members should find another means of traveling along the length of the paving site.

Screed Extensions, Cut-Off Shoes, and End Plates

Rigid Extensions When the basic width of the screed [2.4 m (8 ft) for small pavers and 3.0 m (10 ft) for larger machines] needs to be changed to accommodate increased paving widths, rigid screed extensions can be used, as illustrated in Figure 15-17. These extensions come in several widths, usually 150 mm (6 in.), 0.3 m (1 ft), 0.6 m (2 ft), and 0.9 m (3 ft). To keep the paver in balance, the width of the rigid extensions added to the paver screed should be approximately equal on both sides of the machine, if possible.

It is important that the screed extensions be attached securely to the screed. Further, it is essential





FIGURE 15-17 Rigid screed extension.

that the extensions be set at the same elevation and angle as the screed to prevent the presence of a transition line or ridge at the intersection of the screed and the extensions or between the different extensions. Alignment of the front edge of an extension is typically controlled independently of the alignment of the rear edge.

Whenever a rigid extension is used on the screed, auger extensions and the accompanying auger tunnel extensions should also be used. The length of all the auger and tunnel extensions should in general be the same as that of the screed extensions to allow room between the end of the auger and the end plate of the screed. Typically, the distance between the end of an auger extension and the end plate should be about 450 mm (18 in.). Further, whenever rigid screed extensions are employed on a paver with a strike-off, a strike-off assembly must also be added to the extensions and set at the same elevation as the strike-off on the screed.

Strike-Off Extensions Strike-off extensions are often used to increase the paving width on projects that do not require an actual screed extension with heat and vibratory compaction capability. Such strike-off extensions are used for driveway and mailbox turnouts and for some types of intersection paving where variable widths are frequently encountered. Typically, this type of extension is merely a vertical blade that cuts off the mix as it passes under the strike-off unit (see Figure 15-18). In some cases, a very short section of horizontal plate is attached to the strike-off assembly.

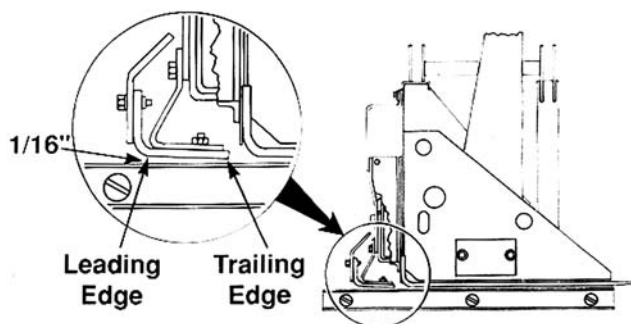

FIGURE 15-18 Strike-off extension.

When correctly installed and adjusted, strike-off extensions can be extended and retracted without influencing the mat directly behind the screed. When these strike-off extensions are extended, the HMA placed by the extensions must be thicker than the mix that passes under the screed because the mix laid by the extensions is not compacted as is that under the screed. The difference in the two thicknesses should be adjusted, depending on the properties of the mix being placed, so that after compaction by the rollers, no difference remains in the compacted thickness of the two portions of the mat. In addition, the mix laid by the strike-off extension will typically have a significantly rougher texture than the mix laid by the screed, as shown in Figure 15-19. Sometimes this difference in texture will remain visible even after the mix has been compacted.

It is suggested that strike-off extensions not be used for mainline paving so that the surface texture and compaction of the entire traveled width will be consistent. Thus for a typical lane 3.7 m (12 ft) wide, the screed should be extended either with rigid extensions or with a hydraulically extendable screed.

End Plates and Cutoff Shoes An end plate (or end gate or edger plate) is attached to the end of the screed to restrict the outward movement of the mix around the end of the screed, as shown in Figure 15-20. The vertical alignment of the end gate is adjustable so that mix can be bled out from under the gate if necessary. In typical operating mode, however, the end plate is positioned tight to the surface being paved to retain the mix and control the width of material being placed.

Cutoff shoes can be used, if necessary, to reduce the width of mix placed so it is less than the screed width.



FIGURE 15-19 Difference in texture under strike-off extension.

Standard cutoff shoes are attached to the paver end gate. Typically, the cutoff shoes come in widths of 0.3 m (1 ft) or 0.6 m (2 ft) and are adjustable in increments of 37 mm (1½ in.) or 75 mm (3 in.), depending on the paver manufacturer.

Hydraulically Extendable Screeds Most paver manufacturers have developed hydraulically extendable screeds that trail the main screed on the paver. One make of pavers, however, is equipped with an extendable screed that places the extendable portion of the screed in front of the main screed. An example of an extendable screed is shown in Figure 15-21.

For all hydraulically extendable screeds, it is important that the height and the angle of attack of the extendable screeds (on each side of the main screed) be properly set. If the extensions on the extendable portion of the

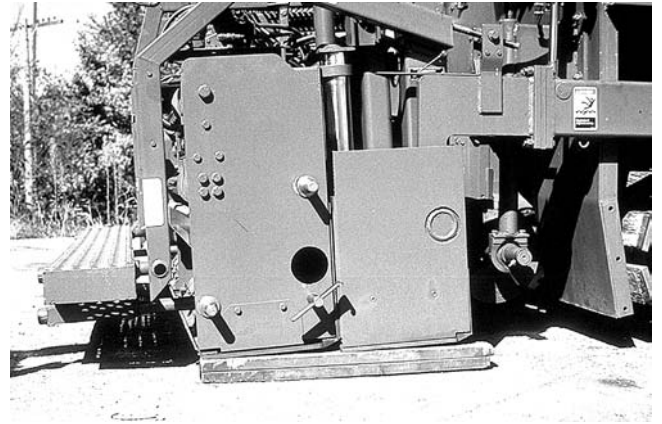

FIGURE 15-20 End plate on paver.

screed are not properly aligned with the main screed, a longitudinal mark or ridge will occur in the surface of the mix at the junction between the two screeds, indicating a difference in thickness. This mark can easily be eliminated by adjusting the elevation of the extendable screed in relation to that of the main screed. In addition to the longitudinal mark, a mismatch in elevation between the two screeds can result in a difference in surface texture, as well as a difference in the degree of compaction obtained. For front-mounted extensions, the extendable screed is usually set at a height slightly below the main screed. For rear-mounted extensions, the height of the extendable portion of the screed is normally set at the same height as the main screed, but the extensions usually have a slightly more positive attack angle as compared with the main screed. In general, however, the forces that act on the extendable screeds and the main screed are similar.



FIGURE 15-21 Hydraulically extendable screed.



Further, if a strike-off assembly is used on the main screed, similar strike-off devices should be used on the extendable screed sections.

If a front-mounted hydraulically extendable screed is to be used at a fixed extended width for a period of time, the paver should be equipped with auger extensions equal to the width of the extended screed and ending approximately 450 mm (18 in.) from the end plate. Use of these auger extensions will enhance the distribution of the asphalt mix across the width being paved and help maintain a constant head of material pushing on the entire width of the screed. Auger tunnel extensions should also be added to the paver.

For pavers equipped with a rear-mounted hydraulically extendable screed, auger extensions often are not employed even when the screed will be used at a fixed extended width for a period of time. If auger extensions are used on such pavers, an excess of mix may build up in front of the screed extensions, as shown in Figure 15-22. This condition may result in several problems with the mat behind the screed, such as nonuniform texture and variable mat thickness, and therefore should not be allowed to occur. With rear-mounted extensions, the HMA material will naturally flow out to the end of the screed without assistance from auger extensions. In addition, without auger extensions, less mix will typically be carried in front of the extendable section of the screed. For rear-mounted extensions, the material feed sensors must be mounted on the end gate of the screed to limit the amount of mix carried in front of the extendable portion of the screed.

If a hydraulically extendable screed—especially a front-mounted extension—is to be employed where the width being paved changes frequently, some paver man-



FIGURE 15-22 Buildup of excess mix in front of extended screed.

ufacturers recommend that the machinery be equipped with kickout paddles or augers at the end of the main auger. This device helps push the mix out to the end of the extendable screed and keeps the head of material in front of the screed as constant as possible. Other pavers are equipped with augers that extend automatically as the screed is extended. For either type of paver, the material feed sensors should be mounted on the end gate of the screed to ensure that an adequate amount of material is delivered to the outside edge of the screed.

SUMMARY

The following key factors should be considered in monitoring mix placement operations:

- If the mix is being delivered by a haul truck that dumps it directly into the paver hopper, the truck should stop just short of the paver. The paver should be moving forward when it comes in contact with the truck—the paver should pick up the truck instead of the truck backing into the paver. When raised, the bed of the haul truck should not rest on any portion of the paver.

- Before the tailgate on the haul truck is opened to deliver mix to the paver hopper, the truck bed should be raised slowly until the mix in the bed moves against the tailgate. This procedure allows the mix to move in a mass into the paver hopper when the tailgate is opened and reduces the amount of segregation behind the screed. If the tailgate-opening lever cannot be reached when the truck bed is raised, it should be modified to allow for operation from ground level when the bed is raised.

- If a windrow elevator is used to gather mix from a windrow on the roadway and deliver it to the paver hopper, the slat conveyors should pick up essentially all of the mix that is in the windrow, leaving none on the existing surface. For the placement of a leveling course, it may be necessary to leave some minimum amount of mix on the pavement surface under the windrow elevator because of the unevenness of the existing pavement surface.

- The windrow should be sized so that the amount of mix in the paver hopper is always above the top of the flow gates or the tunnel openings.

- When a paver must be stopped to wait for trucks, it should be stopped as quickly and smoothly as possible. Enough mix should remain in the paver hopper to be at least at the level of the top of the flow gates or tunnel openings. In no case should the hopper be emptied to the point that the slat conveyors at the bottom of the hopper are visible. The slat conveyors also should never



be visible when a windrow elevator or MTV is used to deliver mix to the paver hopper. The amount of mix in the hopper should be consistent so that the head of material in front of the paver screed remains constant.

- When the paver is stopped to allow the next truckload of mix to move into position, the wings on the paver may be folded, but only when necessary to prevent buildup of cold mix in the hopper corners. The wings should not be banged repeatedly as they are emptied. The wings should be dumped into a relatively full paver hopper: the amount of HMA in the hopper should be above the top of the flow gates or tunnel openings when the wings are emptied. Dumping the wings into a relatively full hopper may result in some mix spilling out of the front of the hopper; overflow guards should be used to contain as much mix as possible.

- Once a new truckload of mix has begun to be emptied into the hopper, the paver should be brought up to paving speed as quickly as feasible and operated at a constant speed in accordance with the amount of mix being delivered from the plant. This practice will keep the head of material in front of the screed as constant as possible.

- The paver should not be operated at a slower-than-normal speed while the truck exchange is being completed. If the paver continues to move forward while one truck is leaving and the next is moving into delivery position, the amount of mix in the hopper will be drawn down, possibly to the point that the hopper is emptied. This procedure will cause the amount of mix at the augers to be reduced, in turn causing the angle of attack of the screed and thus the thickness of the mat to decrease. Reducing the speed of the paver from normal paving speed to crawl speed between truckloads will also change the forces acting on the screed, further altering the thickness of the asphalt layer. In addition,

when the newly delivered mix is emptied into the hopper and pulled back to the augers by the slat conveyors, the large mass of mix (head of material) against the screed will cause the screed to rise, increasing the thickness of the mat. Thus slowing the paver down between truckloads of mix while emptying the hopper should be avoided because it causes significant changes in the forces acting on the screed and accompanying changes in the thickness of the layer being constructed.

- The flow gates on each side of the machine on the back of the paver hopper should be set at a height that permits the slat conveyors and corresponding augers to operate as close to 100 percent of the time as possible. The key to a smooth layer of mix is maintaining a constant head of material in front of the screed. The key to a constant head of material is a constant paver speed and continuous operation of the paver augers.

- If the paver is equipped with automatic flow control devices, that equipment should be set at a location near the end plate in order to maintain a constant head of mix in front of the screed by keeping the auger running continuously. The location of the device is important to preventing too much or too little mix from being carried at the outside edge of the screed.

- If the paver screed is being operated under manual control, the screed operator should not change the angle of attack of the screed by turning the thickness control cranks except to increase or decrease the thickness of the layer being placed. Once the controls have been turned, it takes at least five times the length of the tow arm on the paver before the screed completes the input change in thickness. If the paver is being operated under automatic grade and slope control, the screed operator should not attempt to change the angle of attack of the screed by turning the thickness control cranks at all.



16 Automatic Screed Control

As discussed in Section 15, the screed unit on the paver is attached to the tractor unit at only one point on each side of the paver, called the tow (or pull) point. As the tractor follows the existing grade with its rubber tires or crawler tracks, the length of the paver wheelbase becomes the reference for the screed. Because of the reaction time required for the screed, the screed will respond more slowly to changes in grade than will the tractor. Thus under manual screed control (covered in Section 15), the screed will average out deviations in the roughness of the underlying pavement layer, placing more mix over the low points and less mix over the high points in the existing pavement.

Automatic screed controls are used to keep the elevation of the tow points on the paver at a predetermined elevation relative to the reference (either a preset string-line or a long mobile ski). Deviations in the pavement surface are averaged out over the length of the reference. As the tractor unit moves up and down over the existing grade, the elevation of the tow points moves over a smaller range than would be the case if the relatively short wheelbase of the tractor provided the reference. Keeping the elevation of the tow points constant in direct relationship to the reference permits the screed to maintain a more consistent angle of attack, which in turn provides for a smoother mat behind the screed. It should be noted, however, that many factors affect the smoothness of the mix placed by the paver. The use of automatic screed controls by itself does not ensure that the mat constructed will be smooth. Proper attention to the operation of the paver, as discussed in Section 15, is extremely important to obtaining a smooth-riding pavement layer.

MANUAL VERSUS AUTOMATIC SCREED CONTROL

If the paver always moved over a level grade, the forces on the screed would be constant as long as the paver was moving at a constant speed and there was a consistent head of material in front of the screed. The towing force on the screed would be stable and the head of material in

front of the screed consistent as long as the feed control system was set to operate as much of the time (close to 100 percent) as possible. Under these conditions, a very smooth asphalt mat could be obtained from behind the paver without the screed operator ever changing the setting of the thickness control cranks on the back of the screed. Indeed, once the angle of attack of the screed had been set when the paver started up in the morning, no changes to the setting of the thickness control cranks would ever be needed.

In the real world, however, the tractor unit operates over a variable grade. As the elevation of the existing surface moves up and down, the wheelbase of the tractor unit follows that grade (see Section 15). This vertical movement of the tractor as it moves forward causes the elevation of the tow points on the tractor to change in direct relation to the movement of the tractor unit. As the location of the tow points is thus altered, the angle of attack of the screed changes.

If the elevation of the tow points is raised, the screed will be rotated upward relative to the change in elevation of the tow points. As the paver moves forward a distance equal to at least five times the length of the leveling or tow arms on the machine, the screed will float up to the new elevation, and the asphalt mat placed will be thicker. If the tractor unit moves into a dip in the existing pavement surface, the elevation of the tow points will be lowered, reducing the angle of attack of the screed. If no other changes are made in the forces acting on the screed, the screed will move downward as the paver travels forward, lessening the thickness of the layer being placed.

The self-leveling action of the screed takes place continuously as the tractor unit travels over the roadway. The thickness of the mat being laid is determined by the reaction of the screed to the location of the tow points, the speed of the tractor, and the head of material in the auger chamber. The entire operation occurs without the thickness control cranks on the screed ever being changed. The floating-screed principle permits the paver to reduce the thickness of the mix placed on high points in the existing pavement surface and to increase the depth of the material deposited on low points.



If the thickness control cranks or handles are turned by the screed operator, the screed will react (change its angle of attack) by rotating around the hinge or pivot points where it is attached to the leveling arms and thus to the tow points of the screed. As the paver moves forward, the screed will float up to or down to the new elevation. As with a change in elevation of the tow points on the leveling arms, the paver must travel forward a distance of at least five lengths of the leveling arms before the change in the depth of the mat is fully realized.

On many projects, particularly those involving the resurfacing of an existing pavement, the screed operator is forced by the job specifications to maintain a certain yield of asphalt mix per square yard or per station. It is not uncommon to see a screed operator continually checking the thickness of the mat being placed by the paver and adjusting the setting of the thickness control cranks to increase or decrease the amount of mix being placed. These changes in the setting of the thickness control system are made without regard to the simultaneous changes to the screed as the elevation of the tow points changes while the tractor unit moves forward over the variable grade.

Two inputs, then, are being provided to the self-leveling system at the same time. The first is the vertical movement of the tow points of the screed in reaction to changes in the movement of the paver wheelbase. The second is the screed operator's manual changing of the thickness control cranks, illustrated in Figure 16-1. These two inputs may be in the same direction, or they may be in opposite directions, even canceling each other out.

Under manual screed operation, the ability of the screed operator to produce a consistently smooth asphalt layer is dependent on a number of factors. The first is the frequency at which the operator adjusts the setting of the thickness control cranks: the more the screed operator changes the angle of attack of the screed, the more un-

even the resulting pavement will be. The second factor is the roughness of the existing pavement surface: the more the screed operator tries to assist the self-leveling action of the screed, the rougher the resulting pavement surface will be. Third is the need to meet a certain maximum yield specification. It is difficult, particularly for thin courses, to produce a smooth pavement layer while staying within a certain volume of material usage. This is particularly true if a minimum overlay thickness is specified along with the yield criteria. This problem is discussed in detail later in this section. The fourth factor is related to the screed operator's need to match the elevation of the longitudinal joint in the adjacent lane. As paving speeds have increased because of higher plant production rates, it has become more difficult to manually maintain the level of the new mat relative to the adjacent mat.

When it is desired to produce a constant cross slope across the width of the lane being paved, automatic grade and slope controls can be used to control the elevation of the tow points of the screed on both sides of the paver at the same time. This is very difficult to do manually, even with two experienced screed operators. A grade control can be used on both sides of the machine; more commonly, a grade control is used on one side of the paver and a slope control on the other.

The primary purpose of automatic screed controls is to produce an asphalt pavement layer that is smoother than the paver can accomplish by itself using only the wheelbase of the tractor unit and the free-floating screed, and smoother than a screed operator can achieve by continually changing the setting of the thickness control cranks. As noted, automatic screed controls function by maintaining the elevation of the screed tow points in relation to a reference other than that of the wheelbase of the paver itself. That reference is typically longer than the wheelbase of the tractor unit. Figure 16-2 illustrates a screed and attached ski.

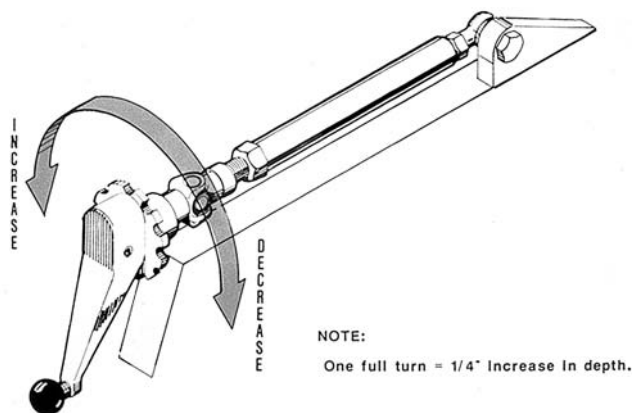
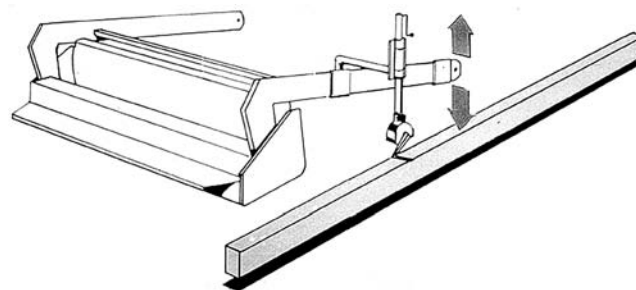

FIGURE 16-1 Thickness control crank.



GRADE SENSOR MOUNTING POSITION #1—SIDE ARM MOUNT

FIGURE 16-2 Screed and attached ski.



The elevation of the tow points is kept constant in relation to a given grade reference. The automatic system does not permit the relative position of the tow points to change even though the tractor unit is moving up and down vertically in response to the roughness of the surface over which it is traveling. By maintaining the tow points at a constant elevation, the angle of attack of the screed is also maintained at a constant setting. This allows the screed to ride at a consistent angle, permitting it to do an even better job of reducing the quantity of mix placed over the high spots in the existing pavement surface and increasing the amount of mix laid in the low spots.

Before the automatic screed control is engaged and before paving starts, the screed should be “nulled” (i.e., angle of attack set at a flat or zero angle position). Once the paver is moving, the proper angle of attack should then be set for the thickness being placed, and the control engaged. If automatic controls are being used on the paver, the screed operator should not try to change the angle of attack of the screed manually by turning the thickness control cranks. If such an attempt is made while the machine is moving, the automatic grade and slope controls will attempt to compensate for the manual input by changing the elevation of the tow points. Manual input will be needed only if the tow point actuator (hydraulic ram) has reached the limit of its travel—if the tow point ram is at its upper or lower limit. In this case, the paver should be stopped and the tow arm reset at the centerpoint of its length of travel. The screed should be nulled, the paver restarted, and the proper angle of attack input to the screed before paving continues.

Note that when a superelevated curve that requires a change from the existing cross slope is being paved, it is necessary to run the grade sensor on one side of the paver automatically and the slope sensor on the other side of the paver manually. This practice allows changes to be made in the amount of superelevation and provides the required degree of cross slope.

GRADE CONTROL

Types of Grade References

Grade sensors are used to monitor the elevation of the existing pavement surface in a longitudinal direction. Three basic types of grade references can be used to maintain the elevation of the screed tow points: (a) erected stringline, (b) mobile reference or ski, and (c) joint matching shoe. On some paving projects with proper sight distance, such as an airport runway or large vehicle test pad, a laser system can also be used.

Each type of grade reference can be used alone on either side of the paver; each can also be used on both sides of the paver at the same time. The same type of grade reference can be used on both sides of the machine, or a different type can be mounted on each side. For example, a preset stringline can be used on one side and a mobile reference on the other. This use of double grade references makes it possible to average out the variations in the profile of the existing pavement surface on both sides of the lane being paved. However, use of double grade references generally will not produce a uniform cross slope for the new asphalt layer unless a preset stringline is used on both sides of the laydown machine. An effective approach is to combine the use of grade and slope controls. When a grade reference is used in conjunction with a slope control device, the grade sensor is typically positioned on the centerline side of the paver, with the slope control determining the depth of the mat on the outside edge of the pavement.

The grade sensor or wand is in contact with the reference in all but sonic systems. As the grade of the reference changes, the wand senses that change and sends an electrical signal to the control panel on the paver. A signal is then sent, in turn, to the tow points on either side of the paver, and their elevation is changed relative to the change sensed by the grade sensor.

If a sonic or noncontact system is used, a sound pulse is sent out from a transducer toward the reference—stringline, mobile reference, or existing pavement surface. When the sound pulse hits the reference, a portion of that pulse is reflected back to the transducer, which also acts as a receiver. The time required for the sound to travel to the reference and back is measured, and the distance is calculated on the basis of the speed of sound. Thus the elevation of the tow points is controlled without the sensor actually coming in contact with the reference itself. On one sonic system, a “working window” is used to prevent the system from making a major change in the elevation of the tow points when a false signal is received. This window is plus or minus 61 mm (2.4 in.) from the elevation of the reference. If the distance measured by the sonic system is greater than the window range, the control of the grade sensor is switched to manual, and no changes are sent to the tow points.

Erected Stringline

The use of an erected stringline, shown in Figure 16-3, provides for placement of the smoothest possible asphalt mat behind the paver screed. The stringline can be made of wire or nylon cord. This method of supply-





FIGURE 16-3 Stringline for grade control.

ing elevation input provides the most consistent reference for the paver tow points, enabling a predetermined grade to be matched very accurately if the controls are used properly.

In application, the use of an erected stringline has a number of drawbacks that may offset the increased smoothness obtained. First, the elevation of the erected stringline must be set by a surveying crew. The accuracy of the elevation of the line and the resulting pavement smoothness are directly dependent on the care taken during erection. If the grade set by the surveyors is incorrect in any way, the paver screed will duplicate that error in the pavement surface. On horizontal curves, it is very difficult to use an erected stringline to control the grade of the new pavement layer. Since the string cannot be set in a curve, a series of chords must be used to simulate the radius of the curve. This in turn requires the positioning of a large number of support posts and rods, usually at intervals of 1.5 to 6.0 m (5 to 20 ft), around the curve.

The stringline must also be very taut when it is set. Typically, the string is supported at intervals of 8 m (25 ft) on metal posts and rods. The string or wire is first anchored at one end of its length and then pulled tight and anchored at the other end. It is extremely important that there be no dips or sags between the support rods. If the string is not stretched tightly, the sensor wand on the paver, which can run either atop or below the stringline, will react to the sags in the line and duplicate those sags in the new pavement surface. Even when high-strength line is used, it is not always possible to keep the line tight enough to prevent small sags from occurring.

It should be noted that any sags in the stringline will not be duplicated at the exact same longitudinal location in the pavement surface because of the delay in the reaction time of the screed once an input has been made to the

elevation of the tow points (see Section 15). As the grade sensor travels over the dip in the stringline, the elevation of the tow points changes. The paver must travel a distance equal to five times the length of the tow arm, however, before the change in the mat thickness is fully completed. Thus any sag in the stringline will be manifested in the pavement surface, but at some length down the roadway from the position of the sag in the stringline.

Another disadvantage of the erected stringline is that the haul trucks and all paving personnel must keep away from the line and not disturb it in any way. Once the line has been set at the proper elevation, it must remain untouched both before and after passing of the paver sensor over the line. Any change in the elevation of the line will result in a change in the input to the grade sensor and movement of the tow points on the paver leveling arms.

With a properly set and maintained stringline, the mat placed by a paver equipped with automatic screed controls can be very smooth and at the correct elevation, primarily because of the extended length of the reference being used as compared with the more limited length of a mobile reference. However, unless smoothness or compliance with a predetermined grade reference is extremely important, as with an airport runway where a consistent longitudinal and transverse profile is required, it is questionable whether the added expense of erecting and maintaining a stringline is cost-effective for the typical HMA paving job. Thus for the vast majority of highway paving projects, an erected stringline is not used.

Mobile Reference

The various paver manufacturers use different types of mobile reference devices to extend the relative wheelbase for the automatic screed control system. The operation of these reference systems, however, is essentially the same. The purpose of the mobile reference is to average the deviations in the existing pavement surface out over a distance that is greater than the wheelbase of the tractor unit itself.

One version of a mobile reference employs a rigid tubular grade reference (pipe) that is 6.1, 9.1, or 12.2 m (20, 30, or 40 ft) in length, as seen in Figure 16-4. For this version, the pipe or tube rides directly on the existing pavement surface. A spring-loaded wire is typically stretched along the ski on top of the pipe. The grade sensor that inputs the electrical signal to the paver tow points rides on top of the wire. As the ends of the pipe move up and down over the existing grade, the stretched wire on the ski is used to average out the differences in elevation that occur under the mobile reference.





FIGURE 16-4 Paver with mobile reference employing rigid pipe.

The primary problem with the use of a rigid pipe or any rigid reference is the fact that if a singular high point is present in the pavement under the reference, the front end of the pipe will ride up over the hump until the midpoint on the length of the pipe is reached. At that time, the pipe will break over, and its front end will tip downward, like a seesaw. That change in slope will continue until the back end of the reference is off of the high point. The bump duplicated in the mat behind the paver may be more pronounced than it would have been if a floating-beam reference had been used.

A floating-beam mobile reference consists of a series of feet or shoes attached to the bottom of a beam, as shown in Figure 16-5. One or more of the feet can pass over a singular high or low point in the existing pavement surface without altering the slope of the entire beam. The feet are spring loaded so they can be deflected by a large stone on the pavement surface, for example, without pushing the whole beam upward. The grade sensor usually rides directly on the beam at its midpoint. As with the other types of mobile references, this floating-beam system averages out the variation of the existing grade over a 9.1- or 12.2-m (30- or 40-ft) distance.

Another type of floating-beam mobile reference system is illustrated in Figure 16-6. The beam is normally 9.1 or 12.2 m (30 or 40 ft) in length. Instead of multiple feet spread out along the length of the beam, however, a series of shoes is placed at each end of the beam. These shoes are allowed to rotate and can be individually displaced by isolated disruptions in the existing pavement surface without changing the elevation of the entire beam. Thus the beam can average the grade of the surface over the length of the reference without being influenced by the presence of a single high point or dip.



FIGURE 16-5 Floating-beam mobile reference.

On mobile reference systems other than the floating-beam type, the grade sensor should be located in the center of the length of the beam to ensure that the input to the paver tow points will be made equally over the length of the reference. If the grade sensor is not located in the center of the length of the mobile reference, the ski will not average out the changes in elevation in the existing pavement surface uniformly. As suggested earlier, the ski can be thought of as a seesaw, and the location of the grade sensor can be regarded as similar to the seesaw's pivot point. If the sensor is offset (closer to one end of the ski than the other), a change in elevation at the longer end of the reference will be magnified and result in a greater input change to the elevation of the tow points. Conversely, a change in elevation on the shorter end of the ski will result in a lesser change in the location of the screed tow points. Thus, except for unusual circumstances, the grade sensor should be located in the center of the length of the ski.



FIGURE 16-6 Floating-beam mobile reference with shoes at ends of beam.

Of the mobile reference devices described above, the floating-beam type with multiple feet or shoes typically results in a smoother pavement because of its ability to ignore isolated deviations in grade (a rock on the roadway, for example). Moreover, the longer the grade reference used, within reason, the better the paver will average out variations in the elevation of the existing pavement surface. A mobile reference will not, however, ensure that the mix being placed is at the proper elevation. The elevation is controlled by the elevation of the underlying pavement surface and the thickness of the mat being laid.

One paver manufacturer has produced a mobile reference ski that is 16.8 m (55 ft) in length from front to back, termed an over-the-screed reference (see Figure 16-7). On this device, part of the reference beam is located in front of the screed. This portion of the reference is basically a floating-beam system, equipped with a series of spring-loaded shoes, that senses the grade of the existing pavement surface. To the rear of the screed, riding on a series of spring-loaded wheels or large shoes, is another floating beam that is used to reference the grade

of the newly placed asphalt mix. A set of intermediate bridge beams that extends up and over the screed is used to join the two parts of the floating beam. The grade sensor rides on one of the intermediate bridge beams and transmits the average grade of the front and back beams to the paver tow points to control their elevation.

Another version of the over-the-screed reference is available. On this device, the front ski consists of a floating beam in front of the screed that rides on the existing pavement surface. Another floating beam rides on the newly placed mat behind the screed. Instead of the bridge beams connecting the two beams, however, a stringline or wire is used. The grade wand rides on the stringline and senses the average change in grade between the front and back reference beams.

Because of its greater length relative to the other types of reference, the over-the-screed reference provides for a smoother mat. In addition to the greater length of the reference, however, the fact that the rear ski rides on the new mix is also important for smoothness. Since the new mat should be significantly smoother than the existing pavement surface, the average variation sensed by the grade wand is limited, resulting in fewer changes to the elevation of the tow points as the paver moves down the roadway. This device may not be practical, however, in hilly terrain or on pavement that has a large number of vertical curves.

Joint-Matching Shoe

The joint-matching shoe, shown in Figures 16-8 and 16-9, consists of a short shoe or ski [approximately 0.3 m (1 ft) long] that is used to reference the grade of an adjacent pavement lane. This type of mobile reference is used only when the grade being sensed is relatively smooth. The shoe rotates around its own pivot point and when displaced supplies an electrical input signal to the paver tow points. The shoe should be checked to ensure that it is free to rotate properly.

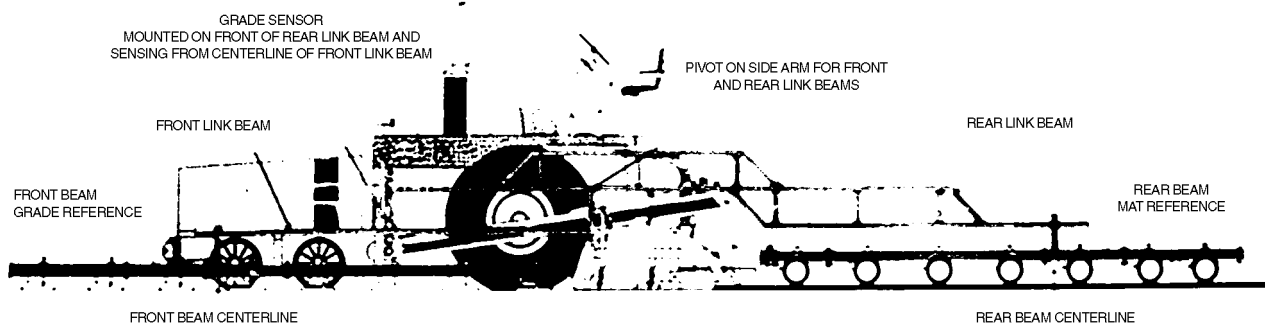

FIGURE 16-7 Over-the-screed reference.



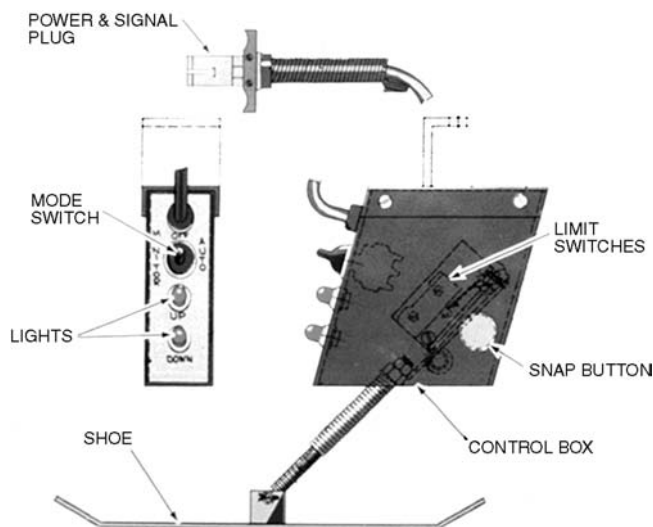

FIGURE 16-8 Shoe for matching joints.

Because of its short length, the joint-matching shoe will not significantly reduce major variations in the pavement surface. Indeed, the purpose of the shoe is to duplicate the grade of the adjacent surface. This grade-control device should be used with caution because pebbles, rocks, and other obstructions over which the shoe may ride will result in grade changes being input to the screed tow points. Further, because of the delay in the reaction of the screed once the tow point elevation has been changed (see Section 15), the input from the pavement surface over which the joint-matching shoe is passing will not be duplicated at the same longitudinal location in the new pavement surface. The joint-matching shoe thus does not truly match the joint. However, if the shoe is placed at the tow point, the screed is about 1 baseline length behind the shoe, and 63 percent of any thick-

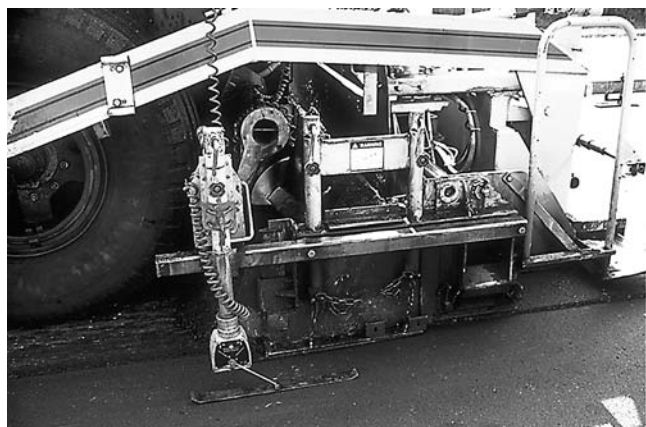

FIGURE 16-9 Operation of joint-matching shoe.

ness change will occur when the screed arrives at the point where the shoe called for the change.

When placing the second lane of a base course or a binder course layer, it may be better to use a longer mobile reference [a ski 9.1 m (30 ft) long] instead of a joint-matching shoe. The mobile reference will provide better input for constructing a smooth pavement surface than will the joint-matching shoe. For a surface course layer, however, the joint-matching shoe may be used to ensure that the elevation of the mix on both sides of the longitudinal joint is the same, although the use of a longer mobile reference is still better paving practice.

Lasers

Laser technology has been used successfully on a number of paving projects. For locations where the sight distance is adequate and the pavement being placed has a constant slope, a laser system can be employed to control the elevation of the tow points on the paver. A transmitter sends a laser signal to a receiver unit on the lay-down machine. This signal controls the grade of the mat by regulating the tow point location in relation to the laser beam. When used properly, the laser grade control system is capable of providing a very smooth mat behind the paver. To keep the tow points from moving randomly if a haul truck or other object passes through the laser beam, a delay is built into the control system so that the beam can be interrupted briefly without changing the position of the tow points.

Location of Grade Reference

The various paver manufacturers make different recommendations regarding placement of the grade-control sensors. In the past, it was often suggested that the sensor be mounted adjacent to the tow point on the side(s) of the paver on which the grade control was being used. Because of the delayed reaction time of the screed, however, it has been found that a better place to mount the grade sensor is either part of the way up the leveling arm of the screed or near the screed. The grade sensor is sometimes hung at the tow point when used in conjunction with a joint-matching shoe, but it is suggested that, even with the latter type of reference, a better place to locate the sensor is on the leveling arm, one-third to two-thirds of the way between the tow point and the screed.

The tow arm or side mounting position typically is recommended when long vertical deviations in the present pavement surface need to be corrected. When

the sensor is located on the leveling arm, less time is required to react to changes in grade, and the angle of attack of the screed is altered quickly. On some occasions, particularly for wide paving, it is best to mount the grade sensor near or on the paver screed. To function properly, the sensor must be located in front of the pivot or hinge point of the screed.

The location of the grade sensor makes a difference in the reaction of the tow points and the screed to the grade being sensed. There is no set rule, however, for the proper location in which to place the grade sensor. It is recommended, therefore, that the paver manufacturer's suggested placement be used. If no location is suggested, it is recommended that the sensor be hung on the leveling arm, at a point one-third to two-thirds the length of the arm between the tow point and the screed.

The operation of the grade-control sensor should be checked regularly. The sensor wand should be lifted a very short distance, less than 3 mm ($\frac{1}{8}$ in.), when the machine is stopped and the movement of the tow points is observed. Manually moving the sensor should result in a corresponding movement of the tow points. If the wand is raised or lowered and the actuator or ram does not move, either the system is turned off, or the sensitivity of the sensor is set too wide. In the latter case, the dead-band range or the sensitivity setting is too great.

When the paver is moving, the up and down lights on the grade sensor should blink to indicate that a signal is being sent to the tow point actuator. If the grade sensor uses a meter instead of lights, the reading on the meter should change when the sensor wand is moved, as well as when the paver is placing mix on the roadway. In addition, the elevation of the tow points should change occasionally, depending on the roughness of the existing pavement surface, so that the angle of attack of the screed will remain constant as the tractor unit follows the underlying pavement grade. The change in elevation of the tow points, however, should be smooth. The tow points should not be moving up and down rapidly or constantly as the paver travels forward.

SLOPE CONTROL

As noted earlier, paving that is done with automatic screed controls is usually accomplished with a combination of grade control on one side of the paver and slope control to determine the grade on the other side of the machine. The slope control operates through a slope sensor that is located on a cross-beam between the two side arms of the screed. One side of the screed is con-

trolled by the grade sensor, while the other is controlled by the slope controller. In almost every case, the inside or centerline edge of the mat is controlled by grade and the outside edge by slope, because it is much more difficult to subsequently match the centerline joint if slope control is used on that side of the paver.

When slope control is used, the thickness of the mat on the side of the machine that is controlled by the slope sensor may be variable in depth, depending on the condition of the existing pavement surface. The desired degree of cross slope is dialed in to the slope controller, shown in Figure 16-10. This cross slope is then regulated by a pendulum device that is part of the slope-control system. Without regard to the grade of the existing pavement, the slope controller maintains a constant cross slope regardless of the resulting thickness of the asphalt layer placed. If there is a high point in the present pavement surface, the slope controller causes the screed to place less material over that location; if there is a low point in the existing pavement, the slope controller causes the screed to deposit more mix in that location. It is good practice to check the slope of the lane routinely with a carpenter level or other method (Figure 16-11).



FIGURE 16-10 Slope-control device.





FIGURE 16-11 Checking slope of mat surface behind paver.

For a wide pavement, such as an airport runway, it is good practice to check the elevation of the outside edge of the mix being placed after two passes of the paver in the longitudinal direction. If the slope is not set properly or the slope sensor setting is changed accidentally, the error may be compounded in the slope setting all the way across the pavement. The result may be a very thick or very thin layer of mix on the edge of the runway. Use of one or more stringlines across a wide pavement can help provide the proper cross slope.

YIELD, MINIMUM THICKNESS, AND SCREED CONTROLS

The paving specifications for HMA overlay projects are written in a variety of ways. The specifications may call for a minimum thickness of mix to be placed. In such cases, it is usually necessary that the paver place a mat thickness that is greater than the minimum depth required in the contract for the minimum thickness specification to be met at all points in the pavement layer. The amount of extra thickness depends on the roughness of the existing pavement: the more uneven the surface being paved, the greater will be the volume of mix needed to ensure compliance with the minimum thickness requirement.

To illustrate, if the existing pavement is relatively even and a minimum HMA overlay thickness of 25 mm (1 in.) is required, the paver thickness-control system must be set to place an average depth of uncompacted HMA of approximately 38 mm (1½ in.). This means the angle of attack of the screed must be such that the average thickness placed will ensure the minimum depth of mix over all the high spots in the pavement surface.

A second type of specification calls for placement of a given amount of mix, in terms of kilograms of mix per square meter (pounds of mix per square yard), over the pavement surface area. In this case, the thickness requirement is an average, not a minimum, depth. If the specifications for a project call for placement of 60 kg of mix per m² (approximately 110 lb per yd²) or approximately 25 mm (1 in.) of compacted thickness for an HMA mixture, the paver screed need not be set at as great an angle in order to place the mix to an average compacted depth of 25 mm (1 in.), as compared with a minimum specification thickness of 25 mm (1 in.).

The paver screed, if left to operate without human intervention on the thickness-control cranks and running either with or without automatic controls, will typically overyield mix. This means the paver will require more material than would otherwise be expected in order to react to variations in the grade of the existing pavement and to place less mix on the high spots and more on the low spots. To meet the yield requirement, therefore, it is usually necessary to reduce somewhat the thickness of the mat being placed, and this means that any minimum thickness requirement will not be met.

Conversely, if the paver is allowed to operate on its own, the machine will be able to place a smooth mat, but the amount of mix required will typically be greater than plan quantity. In this case, an extra quantity of mix must be available beyond that calculated from the length, width, and thickness of the paving project area. Such an operation will thus not be practical for a project with a yield specification.

An additional problem with a yield specification is the longitudinal distance used to determine the yield value. In some cases, yield is checked after every truckload of mix. This frequency of checking often leads to continual changes in the thickness-control cranks on the paver. Yield should be checked only periodically—for example, the tons of mix placed over a distance of 300 m (1,000 ft). Another option is to check the yield no more than once per hour of paving.

A third type of specification requires a certain degree of smoothness for the finished pavement surface. Many such specifications exist. Most are related to the amount of deviation permitted from a straightedge of a given length, or a certain maximum number of millimeters (inches) of roughness per unit of length, typically a kilometer (mile) or some fraction thereof. Although it is normally possible to meet such smoothness requirements through the use of automatic screed controls, ultimate success in doing so will depend on the amount of mix available to be placed, the condition of the existing pavement, and the number of layers of mix to be laid. The

amount of mix necessary to meet a smoothness requirement will usually be greater than the amount needed to meet a given yield requirement. For most existing pavement surfaces, it is not reasonable to expect to achieve a smooth overlay if only one resurfacing course is placed. Indeed, if the existing pavement surface is quite rough, it may be difficult to meet a smoothness requirement even after two new layers of mix have been constructed. Smoothness specifications should therefore be related to the condition of the present pavement surface unless the existing surface is milled or the overlay consists of at least two layers.

A significant problem arises when it is necessary to meet some specified yield requirement and a minimum thickness or smoothness requirement simultaneously. Because of the principle of the floating screed (see Section 15), it generally is not possible to meet both of these requirements at the same time on the same project, depending on the smoothness of the pavement being overlaid. This is particularly true for thin overlays. The governing criterion (yield, minimum thickness, or smoothness) should be determined at the time the job is designed and should be stated in the contract documents. That same criterion should also be discussed and agreed upon between contractor and agency representatives before paving begins (during the preconstruction meeting).

SUMMARY

The following factors should be considered in monitoring automatic screed control operations:

- The screed operator should not attempt to make manual changes in the angle of attack of the screed by turning the thickness-control cranks, because the automatic controls will attempt to change the elevation of the tow points to compensate for the manual input to the screed.

- The grade sensor should be checked to ensure that it is working properly. If the wand (which rides on the stringline or mobile reference beam) is raised 3 mm ($\frac{1}{8}$ in.), there should be a corresponding movement of the actuator or ram at the tow points on the paver. If the wand is raised (or lowered) and the actuator does not move, either the system is not turned on or the sensitivity of the sensor is set too wide—with too great a dead-band or sensitivity setting.

- When the sensor is set on the grade reference and the paver is moving forward, the up and down lights on the sensor should blink occasionally or the constantly

blinking lights should change in intensity occasionally, both top and bottom, to indicate that a signal is being sent from the sensor to the tow point cylinder. On grade sensors that use a meter, the meter should indicate a change in reading as the paver travels down the roadway. Further, the movement of the tow point actuator should be smooth, without constant or rapid up and down movement.

- If a stringline or wire is used as the grade reference, the line should be very taut; there should be no sags in the line, particularly between the vertical support locations. Tautness can be checked by sighting down the line. The grade sensor wand should ride easily over the stringline and not be displaced in a vertical direction when it passes over a support arm. Every effort should be made to keep all personnel and equipment from coming in contact with the stringline and disturbing it, either longitudinally or vertically.

- If a mobile reference is used for grade control, the sensor should ride on the reference at the midpoint of the reference length. This placement allows the input to the paver to be made equally over the length of the mobile reference. If the mobile reference is equipped with multiple feet or shoes, each device should be checked to ensure that it is clean and free to move or rotate around its own hinge or spring point. The length of the mobile reference should be as long as practical to provide for the greatest averaging out of variations in the elevation of the existing roadway surface. The length of the reference should be longer than the wheelbase of the tractor unit.

- If a joint-matching shoe is used for grade control, it should be checked to ensure that it is free to move or rotate around its own hinge or spring point.

- If the automatic control system includes grade control on one side of the paver and slope control on the other, the layer being placed should be checked regularly to ensure that the proper elevation is being built into the pavement layer by the paver. This regular checking is particularly important on very wide pavements, such as an airport runway.

- On most paving projects, the grade-control sensor should be hung on the leveling (tow) arm of the paver, typically between one-third and two-thirds of the distance between the tow point and the screed. On some projects, the sensor can be placed just in front of the screed, but it should never be placed behind the pivot point of the screed. The sensor, except when used in conjunction with a joint-matching shoe, should generally not be located at the tow point.



17

Joint Construction

During the construction of HMA pavements, two types of joints are encountered. The first is a transverse joint, which is constructed whenever the paving operation is interrupted for a period of time—anywhere from 15 minutes to several weeks or more. The second is a longitudinal joint, which is built when a lane of HMA is constructed adjacent to a previously placed lane of mix. The techniques for constructing each type of joint are discussed in this section.

TRANSVERSE JOINTS

Suspension of Paving

The way a transverse joint is constructed depends primarily on whether traffic will be traveling over the asphalt mix before the paving is restarted. If traffic will not be passing over the end of the pavement, a vertical butt joint can be constructed; otherwise, a tapered joint must be built. In either case, the operation of the paver is essentially the same, but the construction of the joint itself is different.

It is important that the paver be run in normal fashion right up to the point at which the transverse joint is constructed. This means the head of material in front of the screed should remain as consistent as possible up to and at the location of the joint, so that the forces acting on the screed will be constant, and a consistent angle of attack will be maintained for the screed. The result will be a uniform mat thickness at the joint—the same thickness as that of the previously placed mix.

It is common but incorrect practice to empty out the paver hopper when a transverse joint is to be built. The paver operator runs the hopper out of mix, and the transverse joint is constructed at the point where the empty paver has stopped. As the hopper is emptied, however, the amount of mix carried on the augers is reduced until it is minimal. This process reduces the head of material in front of the paver screed, causing the screed angle to fall. The thickness of the mat then gradually decreases as the joint location is approached. The transverse joint is thus built at a low point in the new pavement surface, resulting in a dip that will be felt by traffic.

It is much better practice to locate the transverse joint at a point where the head of material in front of the screed is normal. This type of operation, however, requires more work on the part of the paving crew. If the joint is made where the pavement thickness (head of material) is constant, the paver screed is simply raised up at the point where the joint is to be built. Doing so leaves a great deal of mix on the roadway—the amount of mix that was in front of the screed. Except for the amount of mix needed to construct a taper, this material will have to be removed and then wasted or returned to the asphalt plant to be used as RAP. In addition, it will be necessary to dispose of the amount of mix remaining in the paver hopper. The advantage of this practice, however, is a smooth transition across the joint instead of a dip.

Butt Joints

For a butt joint (Figure 17-1), a vertical face is constructed by hand across the width being paved. This operation consists of raking, shoveling, and then removing the mix that is located downstream of the selected joint location. The mix thus removed is discarded or returned to the plant to be recycled. The mix that is in place upstream of the joint is not touched in any manner.

Compaction of the mix on the upstream side of the joint is accomplished in normal fashion. It is necessary, however, for the rollers to compact the mix immediately adjacent to the joint. For this to be done properly, runoff boards must be placed next to the joint. The thickness of the boards should be approximately equal to the compacted thickness of the layer being placed. In addition, the boards must be wide and long enough to support the full size of a roller. The compaction equipment passes over the mix at the joint and onto the boards before the rolling direction is reversed. This practice ensures that the transverse joint receives the same degree of compaction as the rest of the mix in the pavement layer.

If runoff boards are not used, the front wheel of the compaction equipment is normally run up to the transverse joint, stopping just short of the joint. The roller di-

17

Joint Construction

During the construction of HMA pavements, two types of joints are encountered. The first is a transverse joint, which is constructed whenever the paving operation is interrupted for a period of time—anywhere from 15 minutes to several weeks or more. The second is a longitudinal joint, which is built when a lane of HMA is constructed adjacent to a previously placed lane of mix. The techniques for constructing each type of joint are discussed in this section.

TRANSVERSE JOINTS

Suspension of Paving

The way a transverse joint is constructed depends primarily on whether traffic will be traveling over the asphalt mix before the paving is restarted. If traffic will not be passing over the end of the pavement, a vertical butt joint can be constructed; otherwise, a tapered joint must be built. In either case, the operation of the paver is essentially the same, but the construction of the joint itself is different.

It is important that the paver be run in normal fashion right up to the point at which the transverse joint is constructed. This means the head of material in front of the screed should remain as consistent as possible up to and at the location of the joint, so that the forces acting on the screed will be constant, and a consistent angle of attack will be maintained for the screed. The result will be a uniform mat thickness at the joint—the same thickness as that of the previously placed mix.

It is common but incorrect practice to empty out the paver hopper when a transverse joint is to be built. The paver operator runs the hopper out of mix, and the transverse joint is constructed at the point where the empty paver has stopped. As the hopper is emptied, however, the amount of mix carried on the augers is reduced until it is minimal. This process reduces the head of material in front of the paver screed, causing the screed angle to fall. The thickness of the mat then gradually decreases as the joint location is approached. The transverse joint is thus built at a low point in the new pavement surface, resulting in a dip that will be felt by traffic.

It is much better practice to locate the transverse joint at a point where the head of material in front of the screed is normal. This type of operation, however, requires more work on the part of the paving crew. If the joint is made where the pavement thickness (head of material) is constant, the paver screed is simply raised up at the point where the joint is to be built. Doing so leaves a great deal of mix on the roadway—the amount of mix that was in front of the screed. Except for the amount of mix needed to construct a taper, this material will have to be removed and then wasted or returned to the asphalt plant to be used as RAP. In addition, it will be necessary to dispose of the amount of mix remaining in the paver hopper. The advantage of this practice, however, is a smooth transition across the joint instead of a dip.

Butt Joints

For a butt joint (Figure 17-1), a vertical face is constructed by hand across the width being paved. This operation consists of raking, shoveling, and then removing the mix that is located downstream of the selected joint location. The mix thus removed is discarded or returned to the plant to be recycled. The mix that is in place upstream of the joint is not touched in any manner.

Compaction of the mix on the upstream side of the joint is accomplished in normal fashion. It is necessary, however, for the rollers to compact the mix immediately adjacent to the joint. For this to be done properly, runoff boards must be placed next to the joint. The thickness of the boards should be approximately equal to the compacted thickness of the layer being placed. In addition, the boards must be wide and long enough to support the full size of a roller. The compaction equipment passes over the mix at the joint and onto the boards before the rolling direction is reversed. This practice ensures that the transverse joint receives the same degree of compaction as the rest of the mix in the pavement layer.

If runoff boards are not used, the front wheel of the compaction equipment is normally run up to the transverse joint, stopping just short of the joint. The roller di-

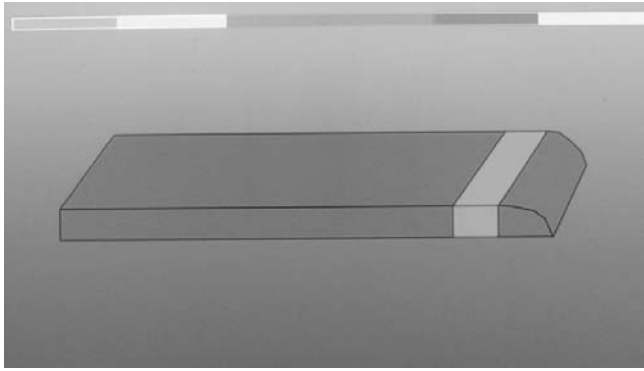

FIGURE 17-1 Construction of transverse butt joint.

rection is then reversed and the rest of the mat compacted. Occasionally, one wheel of the roller will be driven over the end of the course, over the vertical face of the joint. If a roller passes over the edge of the transverse joint with no board being in place beyond the edge to support the weight of the rollers, rounding of the edge of the joint will result. The extent of rounding will depend on the number of times the roller runs off the edge of the joint and the thickness of the layer being constructed. Two problems result in such cases. First, the rounding of the edge of the butt joint prevents the construction of a proper vertical joint face when paving is restarted. Second, the amount of compactive effort applied to the asphalt mix adjacent to (upstream of) the joint is typically inadequate. The lack of proper compaction in turn results in a high air void content in the mix upstream of the joint and a weak spot and dip in the pavement surface.

Runoff boards should therefore be used in the construction of butt transverse joints. If runoff boards are not used, however, one way to overcome the end-rounding problem is to cut back the mix to a location where the mat thickness is constant and the density meets specifications. This practice is illustrated in Figures 17-2 and 17-3. The rounded end of the butt joint is cut back, and the excess material removed and discarded. However, because no release paper has been placed under the mix that will be cut back and removed, it is often difficult to remove that mix. Thus the best practice is to build the transverse joint properly in the first place.

After materials have been removed and discarded, the area adjacent to the joint should be cleaned of all dust and other loose particles. The exposed edge should be lightly tacked with an acceptable tack coat.



FIGURE 17-2 Removal of material at butt joint.

Tapered Joints

If traffic will be passing over the transverse joint, a tapered joint or ramp must be built. For this type of joint, as for the butt joint, it is important that the paver operator keep the head of material in front of the paver screed as consistent as possible up to the point at which the joint is to be built to ensure that the thickness of the mix being placed will be uniform up to the joint. This can be accomplished more easily with a tapered than with a butt joint because a portion of the mix left in the paver hopper and in front of the screed can be used to build the taper.

At the location of the transverse joint, the asphalt mix downstream of the joint is temporarily pushed longitudinally away from the joint. A vertical edge is formed at the upstream face of the mix. If the taper is to be removed before construction continues, treated release paper or some similar material to which the asphalt mix will not stick is then placed downstream of the joint directly on



FIGURE 17-3 Application of tack at butt joint.



the existing pavement surface (see Figure 17-4). The length of the paper depends on the thickness of the course just placed, but is typically about 1 to 1.5 m (3 to 4 ft) and equal to the width of the lane being paved. If the paper is too short, the roller may tend to shove the mix, causing rounding of the joint at the upstream side of the paper. Once the paper is in place, the asphalt mix is shoveled back over it, and a taper is formed in this mix with a lute or rake. Any mix not used to construct the taper is discarded. If the joint is to be left in place permanently, the taper is constructed in the same manner, except that the treated paper is not used.

Sand or dirt from the edge of the roadway is sometimes used as a substitute for treated paper. This is not good practice. Although the sand or dirt does prevent the asphalt material in the taper from sticking to the underlying pavement surface, it is very difficult to remove the sand or dirt from the surface completely once the mix in the taper has been removed.

Typically, some of the bond-breaking material remains on the existing surface even after the surface has been swept with a hand broom. This dirty surface provides a slip plane for the new asphalt mix, and a shoving failure may occur at that point when the new pavement is subjected to traffic. This is true even if a tack coat is applied on top of the dirty surface to improve the bonding of the new mix to the existing pavement. Indeed, in many cases an extra amount of tack coat is applied near the joint to compensate for the dirt at that location. The extra material, particularly if not broken before the new mix is placed on it, can increase the chances for slippage at that point. Constructing a temporary tapered transverse joint using sand or dirt as the bond-breaking medium is therefore not acceptable paving practice.

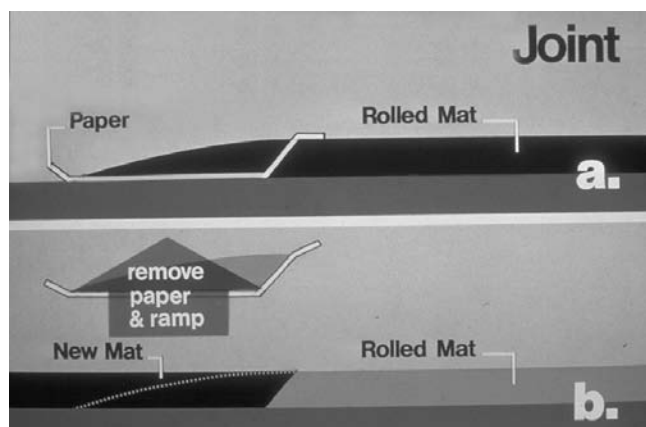

FIGURE 17-4 Use of treated paper in construction of tapered transverse joint.

Another type of tapered joint is the nonformed, sawed joint. For this type of joint, the paver operator keeps the paver operating normally until there is no more mix in the hopper or in the auger chamber. At the point where the mix becomes nonuniform across the width of the lane being paved, a taper is constructed with the leftover mix. No vertical face is formed, and the mix is merely tapered from the proper layer thickness to the level of the adjacent existing pavement. Any mix not needed to make the taper is removed and wasted. When it is time for construction to continue, a saw cut is made at the point at which the taper begins. All material from the taper is removed and wasted, although it is difficult to remove this material because it is typically bonded to the underlying layer (see the section below on "Removal of Taper"). As discussed further below, the vertical face where the saw cut was made should be treated with tack coat before construction continues.

One advantage of the tapered joint is the fact that the compaction equipment can run over the edge of the joint and down the taper without rounding the joint. Because the rollers can pass over the end of the mat easily, the compaction of the mix upstream of the joint is usually superior to that of the mix adjacent to a butt joint. A second advantage is that there generally is less mix to shovel from the joint because some of the extra mix is used to make the taper. The disadvantage of this kind of joint is that the mix must eventually be removed before paving restarts downstream of the transverse joint.

The length of a tapered joint is related to the thickness of the compacted pavement layer: the thicker the HMA lift, the longer the taper. Many agencies use a minimum ratio of 12:1 for the length of the taper and the thickness of the mat. For a mix that is 25 mm (1 in.) thick, therefore, the length of the taper should be at least 300 mm (1 ft). For a layer that has a compacted thickness of 50 mm (2 in.), the taper should be at least 600 mm (2 ft) long. This ratio allows traffic to travel safely from one pavement level to the adjacent higher or lower level.

Handmade Joints

In areas where the new HMA layer abuts an existing structure, such as a bridge deck, it is often necessary to place the mix adjacent to the joint by hand. The mix needed to complete the joint is deposited in the area to be paved either by the paver or by a haul truck. To avoid overworking the mix and possibly causing segregation, the mix should be placed as close as feasible to its final location. The mix is then spread by hand, using shovels, rakes, or lutes.

For such handwork, the mix must be left high to allow for compaction of the material by the rolling equipment. Because the mix is being placed by hand, it will not be as compacted as it would be if laid by the paver. Most paver-placed dense-graded HMA will compact roughly 6 mm ($\frac{1}{4}$ in.) for each 25 mm (1 in.) of compacted mat thickness. Mix placed by hand, however, will be fluffier and not nearly as dense as machine-laid material. To permit proper compaction of the mix and ensure that it will be at the right elevation to match the adjacent structure, the level of the mix should be approximately 9 mm ($\frac{3}{8}$ in.) higher than the surrounding pavement for each 25 mm (1 in.) of compacted layer thickness.

The handwork area must be rolled by the compaction equipment as soon as possible after the mix is in the proper location. Because of the time required to place the mix, rolling will normally be delayed, and the mix will be cooling during the placement process. To achieve the required density, therefore, extra rolling may be needed.

Restart of Paving

Removal of Taper

If a tapered transverse joint has been constructed, the mix in the taper must be removed before paving can be restarted. For a taper built with treated paper, there is little bond between the mix in the taper and the underlying pavement. The paper and mix are readily removed and returned for recycling. A vertical face is left at the upstream edge of the joint.

As noted earlier, if a nonformed tapered transverse joint is built, a transverse saw cut must first be made in the asphalt mat where the taper begins. An advantage of this type of joint is that the saw cut can be made at any longitudinal point in the asphalt layer to ensure that the thickness of the layer is constant. Once the joint has been cut completely through the asphalt mat, a front-end loader is used to pry up the mix that is downstream of the saw cut. As discussed above, one disadvantage of this type of joint is that it is often very difficult to remove the mix from the existing roadway downstream of the saw cut. As an alternative, before construction resumes, a cold-milling machine can be used both to form the vertical edge of the transverse joint and to remove the mix in the taper.

A straightedge should be used to determine the condition of the transverse joint before paving begins. If the mix upstream of the joint is level, the location of the transverse joint is fine. If the straightedge indicates that the previously placed mix is not level, the location of the transverse joint should be moved upstream to a point

where the pavement layer is of the proper thickness and smoothness. The mix downstream of the new joint location should be removed and discarded or recycled.

Application of Tack Coat

The existing pavement surface downstream of the transverse joint should be cleaned and made as free as possible of all loose materials and dust. As noted earlier, a tack coat should be applied to the vertical face of the transverse joint before paving starts (see Figure 17-3); the rate of application of the tack coat should be adjusted to the amount of dust remaining on the pavement surface. The tack coat should be permitted to break, but not necessarily set, before paving begins.

Use of Starting Blocks

As a rule of thumb, HMA is expected to densify approximately 20 percent under the action of compaction equipment. This means that the mix must be placed about 30 mm ($1\frac{1}{4}$ in.) thick to produce a compacted mix that is 25 mm (1 in.) thick. This rule must be applied when the paver is used to place mix at a transverse joint.

If the layer being placed is to be 50 mm (2 in.) thick, the mix passing out from under the screed should be approximately 65 mm ($2\frac{1}{2}$ in.) thick to allow for compaction. It is therefore improper practice to set the paver screed directly on the old mat upstream of the transverse joint and start placing the new mix by dragging the screed off of the previously placed material. If this is done, an insufficient amount of mix will be placed on the downstream side of the joint, and a dip in the compacted pavement surface will result. Instead, proper paving practice requires that the paver screed be placed on a set of starting blocks, or strips of wood on the upstream side of the transverse joint. These blocks should be about 6 mm ($\frac{1}{4}$ in.) thick for each 25 mm (1 in.) of compacted lift thickness, as stated above.

The starting blocks should be placed completely under the length of the screed, front to back, as illustrated in Figure 17-5. At least four strips of wood should be used for a standard screed up to 3.65 m (12 ft) wide equipped with rigid extensions. If the width of the screed with rigid extensions is greater than 3.65 m (12 ft), at least five or six blocks should be used, depending on the width of the screed. If the paver is equipped with hydraulically extendable screeds, either front or rear mounted, at least four blocks should be placed under the main screed and two additional blocks under each extension.

If the paver is starting out at a new location where there is no old mat on which to set the starting blocks



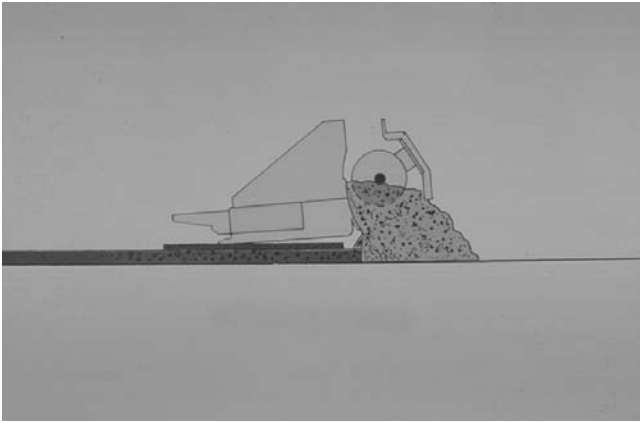

FIGURE 17-5 Use of starting blocks for paving at a transverse joint.

and screed, the thickness of the starting blocks must be increased to compensate for the lack of mix on the upstream side of the joint. In this case, if a compacted layer of mix 50 mm (2 in.) thick is being constructed, the blocks should be about 65 mm (2½ in.) thick to allow for the compaction of the mix by the rollers. For a compacted mat 75 mm (3 in.) thick, the starting blocks should be approximately 95 mm (3¾ in.) thick. Thus the thickness of the starting blocks should be about 125 percent of that of the compacted HMA layer.

Nulling the Screed and Setting the Angle of Attack

After having been set on starting blocks of the proper thickness, the screed should be nulled. This means the screed's angle of attack should be set in the neutral or flat position. It should be possible to turn the thickness control cranks slightly in both directions when the screed is in the nulled position without putting any pressure on the screed and without setting its angle of attack.

Once the screed has been nulled, the angle of attack should be set. This is done by turning the thickness control cranks approximately one full turn (depending on the make and model of the paver) and introducing an up angle to the front of the screed. Both thickness control cranks or handles (one on each side of the machine) must be adjusted for the screed to be set properly.

Before the paver leaves the starting blocks, the material feed system should be activated and mix deposited in the auger chamber in front of the screed. To provide the proper head of material in front of the screed, enough mix should be deposited to cover the augers up to the center of the auger shaft. Once the auger chamber has been properly filled, the paver is started, the screed is

pulled off of the starting blocks, and the paver is brought up to the desired laydown speed as quickly as feasible. As the paver moves down the roadway, the angle of attack of the screed is adjusted, as necessary, to provide the proper loose thickness of the asphalt mat. If the paver screed is nulled and the angle of attack set correctly while the screed is on the starting blocks, any necessary adjustment to the screed should be minimal.

Raking the Joint

If the transverse joint has been constructed properly up to this point, the amount of raking required will also be minimal, as shown in Figure 17-6. If the paver screed starts out on blocks and if the head of material against the screed is constant, the thickness of the mat downstream of the joint will be correct. Very little mix, if any, will need to be brushed back from the joint. There is never any reason to rake a transverse joint excessively (Figure 17-7).

When a joint is raked, there is a tendency for the raker to reduce the thickness of the new, uncompacted mat to match the elevation of the compacted pavement on the upstream side of the transverse joint by pushing the mix at the joint downstream farther onto the new mat. When the level of the new, uncompacted mat is the same as that of the old, compacted mat, however, the final elevation of the newly placed material, after compaction by the rollers, will be below that of the mix on the upstream side of the joint. The result will be a dip in the pavement surface at the transverse joint. Thus only minimal raking should be done.

Before the material on the downstream side of the joint is compacted, a straightedge should be used to determine whether the joint is smooth, as seen in Figure 17-8. The straightedge should rest on the uncom-



FIGURE 17-6 Raking of transverse joint.



FIGURE 17-7 Excessive raking of transverse joint.

packed mat and extend over the already compacted mix. The distance between the bottom of the straightedge and the top of the compacted mat should be equal to the amount of rolldown that will occur during the compaction process—approximately 6 mm per 25 mm ($\frac{1}{4}$ in. per 1 in.) of compacted mat thickness. The straightedge should be used again to check the level of the joint once the compaction process has been completed. Obviously, the compacted mix should be level on both sides of the finished transverse joint.

Compacting the Joint

Ideally, a transverse joint should be compacted transversely (see Figure 17-9). This means the equipment used to roll the joint should operate across the width of the lane instead of longitudinally down the mat. If the



FIGURE 17-8 Checking smoothness at transverse joint.

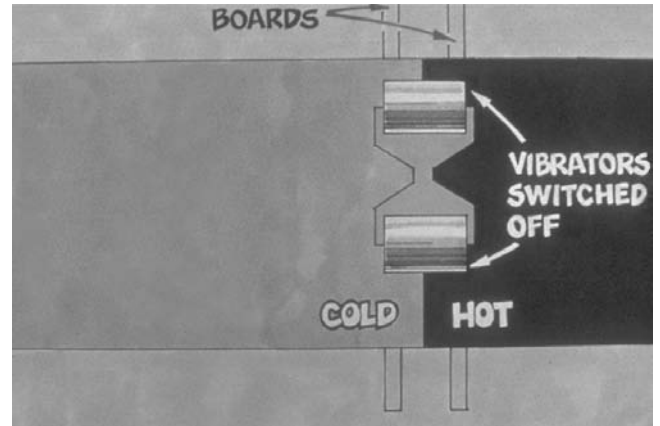

FIGURE 17-9 Horizontal rolling of transverse joint.

rolling is done transversely, however, runoff boards must be used to support the roller as it moves beyond the longitudinal edge of the pavement. The roller should be operated so that the entire width of the joint receives equal compactive force. This is difficult to accomplish unless the wooden boards placed on each side of the lane are long enough to allow the roller to move completely off the mix on both sides of the pavement. Moreover, site restrictions, such as an adjacent guardrail or a steep side slope, may prevent the roller from operating in a transverse direction, and a safety problem is often created by operating the roller in a transverse direction if traffic is being maintained on the adjacent lane.

For these reasons, the transverse joint is usually rolled in the longitudinal direction (Figure 17-10). The initial (breakdown) rolling should be accomplished, however, as quickly as possible after the paver has moved off the



FIGURE 17-10 Longitudinal rolling of transverse joint.



joint. The roller should pass slowly and completely over the joint before the machine is reversed. If the joint has been constructed properly, the compaction process for the transverse joint is no different from that for any other part of the asphalt mixture.

LONGITUDINAL JOINTS

Construction of the First Lane

Two key factors that affect the long-term durability of a longitudinal joint are built into the pavement during construction of the first lane. One is the importance of running the paver in a straight line so the joint can be matched on the next pass of the paver. The other is the need to properly compact the unconfined edge of the first lane (see also the detailed discussion of compaction in Section 18).

If the paver operator does not provide a straight line of mix that can be matched on the adjacent pass of the laydown equipment, it will be extremely difficult to construct a long-lasting longitudinal joint. It is suggested that the paver operator use a stringline to guide the paver as the first lane is being placed. In addition, if an extendable screed is used, its width must be kept constant; if the extendable screed is moved in and out, it will create an uneven edge that will be very difficult to match.

The compaction of the unconfined edge of the first lane is also extremely important. If the proper degree of density is not obtained in the first lane, the joint will deteriorate under traffic. It is critical that the roller make the same number of passes over the edge of the first lane as are made over the rest of the width of the lane. The edge of the drums of the vibratory or static steel wheel roller should extend over the free edge of the lane by at least 150 mm (6 in.). This practice will ensure that the compactive effort of the roller is applied in a vertical direction on the unconfined edge and will greatly reduce any tendency for the HMA mix to shove sideways during the compaction operation.

At no time should the edge of the drums of a vibratory or static steel wheel roller be located just on top of or just inside the unconfined edge of the lane. In either of these two positions, the mix may shove laterally under the forward movement of the roller, particularly if the mix is tender. If the mix does move, not only will the compaction of the mix adjacent to the unconfined edge be significantly less than required, but a dip will also be formed along the joint.

If a pneumatic tire roller is used in the breakdown position, the edge of the outside tire should not be placed

either on top of or over the edge of the mix. Rather, the outside edge of the tire should be about 150 mm (6 in.) inside the unconfined edge of the mat. This will prevent rounding of the edge of the mat, prevent the mix from shoving laterally as a result of the high pressure in the pneumatic tires, and prevent excessive pickup when the rubber tires pass over the edge. Compaction of the mix at the unconfined edge must then be accomplished with a steel wheel roller, in either the vibratory or static mode.

It is important to note that most of the mass of a core cut from a longitudinal joint to measure joint density is actually taken out of the first lane of pavement, not the second. The unconfined edge of the mix that passes out from the end gate on the paver typically slopes at an angle of about 60 degrees. The mix placed in the adjacent lane is then laid against this slope. When a core is taken for density, however, it is typically drilled from the top of the joint that is visible at the pavement surface—half on each side of the joint line.

Cutting Back of the Joint

In some cases, before the longitudinal joint between two adjacent lanes of pavement is constructed, the longitudinal edge of the previously placed mix is cut back for a distance of 50 to 150 mm (2 to 6 in.). This is accomplished with a cutting wheel that is usually attached to a roller (Figure 17-11), but may be attached to a grader or front-end loader. The purpose of this operation is to remove that portion of the mix at the longitudinal joint that may have a lower density than the main portion of the mat because of the lack of confinement of the mix during the compaction process. This lack of density is normally due to improper overhang of the edge of the roller over the unconfined edge of the first lane during con-



FIGURE 17-11 Cutting wheel used to construct longitudinal joint.

struction. If the first lane is cut back, a tack coat should be placed on the newly exposed face of the longitudinal joint just before the adjacent lane is placed.

During this process, a vertical face, instead of the normal 60-degree inclined face, is formed at the longitudinal joint. This practice generally permits an increase in density to be obtained in the newly placed mat adjacent to the cut joint. Adequate joint density, however, can be obtained without cutting back the longitudinal joint—by properly compacting the first lane, as discussed above, and by properly overlapping and compacting the mix in the second lane, as discussed below.

Application of Tack Coat

If the free edge of the first lane is not cut back and the mix along the joint is clean, a tack coat is normally not needed. Although some agencies require that the edge of a longitudinal joint be tack coated before the next lane is constructed, many others do not. A tack coat along the joint, if not applied too heavily, should help create a bond between the two adjacent mats. On the other hand, there is no evidence that use of a tack coat significantly increases the durability of the joint under traffic. Other operational techniques generally affect the longevity of the joint more than the presence or absence of a tack coat.

Overlapping of the Joint

One key to the construction of a good longitudinal joint between lanes of HMA is the amount of overlap between the new and previously placed mats. The typical overlap at longitudinal joints is not more than 25 to 38 mm (1 to 1½ in.), as shown in Figure 17-12. This amount of overlap provides just enough material on top of the joint to allow for proper compaction without having extra mix

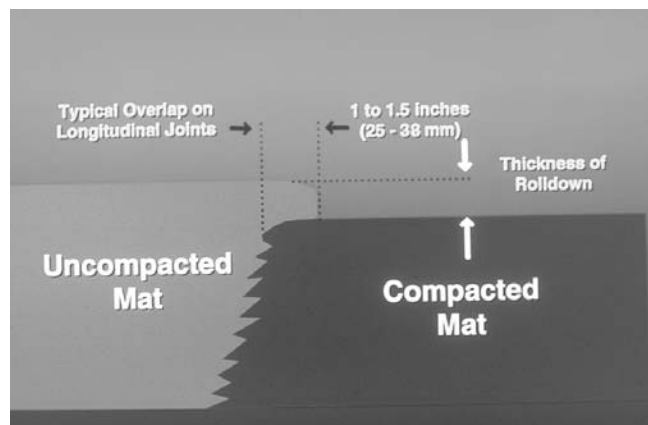

FIGURE 17-12 Thickness increase for uncompacted mix at longitudinal joint.

that must then be pushed back from the joint by a raker. If properly done, however (see Figure 17-13), raking normally allows for increased compaction at the joint. The height of the new mix above the compacted mix should be 6 mm for each 25 mm (¼ in. for each 1 in.) of compacted mix.

As the mix is carried out to the sides of the paver by the augers, the HMA is pushed toward the end gate on the paver screed. Since the augers do not extend across the full width of the screed, however, the mix immediately adjacent to the end gate along the longitudinal joint is much less dense than the mix that passes under the main screed or the center portion of an extendable screed. In addition, because the mix at the end gate is not confined for as long a period of time as the mix that is along the interior of the screed, the mix at the former location is typically less dense. And because of the fluffier nature of the mix at the end gate, less mix is actually placed at that location. Consequently, many paver manufacturers have recently modified the design of the end gate to provide for greater confinement of the mix.

One problem that can occur with longitudinal joint construction is an excessive amount of overlap of the paver screed over the previously placed mat. This problem may arise because the screed operator simply has the end gate on the screed hanging too far over the first lane. It also may result, in part, from a ragged or wavy longitudinal edge on the first paver pass. Because the extra HMA cannot be pushed into the already compacted mat of the first lane, it is normally raked or luted onto the new mat. If the longitudinal edge of the first lane is straight and if the correct amount of overlap is used, the amount of raking required will be minimal.

The importance of putting the right amount of mix in the right place when constructing a durable joint cannot be overemphasized. If the amount of overlap of the first

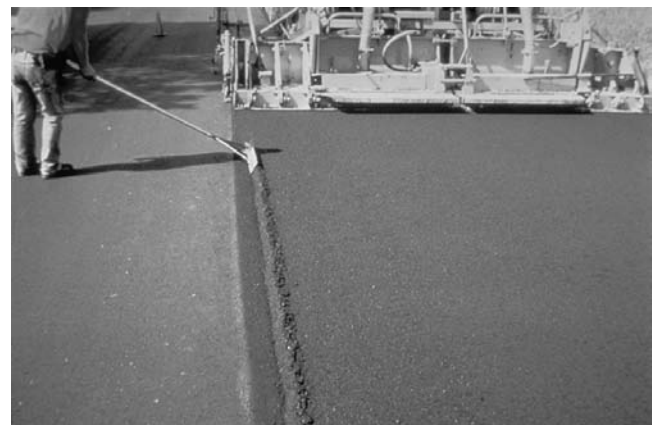

FIGURE 17-13 Raking of longitudinal joint.



lane is correct [no more than 40 mm (1½ in.) at the top of the joint] and if the height of the mix is correct [no more than 6 mm per 25 mm (¼ in. per 1 in.) of compacted mat thickness], there will be no excess mix to push away from the joint onto the new mat. The small amount of mix that overlaps the first lane will blend easily into the joint during rolling.

Raking of the Joint

There are those who believe it is always necessary to rake a longitudinal joint. As discussed above, however, if the right amount of mix is put in the right place, there should be minimal, if any, raking required. Raking may, of course, be required when driveway or mailbox turnouts are being paved, when an intersection is being constructed, or when it is necessary to match the grade of existing drainage inlets or manholes. As discussed earlier, however, raking should never be excessive, and the amount of mix moved should be consistent, especially along the longitudinal joint.

Some believe a raker should “bump” the joint, pushing the mix off the top of the first lane and onto the new mat directly over the joint, leaving a small mound of mix humped up for the rollers to compact. If too much material is left over the joint, the roller will tend to ride on the top of the hump and not come in contact with the adjacent mix, which also needs to be compacted. Further, because there is no place for this extra mix to go, a small bump usually remains along the joint after the compaction process has been completed. In addition, if the amount of mix overlapped on the first lane is not consistent, the volume of the bump created will be variable, and this variability will also affect the consistency of the joint density and evenness. Excessive mix at the joint is therefore not recommended.

Raking is generally not performed consistently. The rake or lute is typically used to push mix off the first lane and onto the new one. Sometimes the mix is deposited only a short distance from the joint, while at other times it is tossed halfway across the width of the new lane. If the adjacent lane is overlapped too far and too much mix is deposited on the old mat, the excess material should be pulled away from the joint instead of being pushed onto the new mix. The extra mix should not be broadcast across the new lane, but should be picked up and discarded. Better yet, it should not have been placed over the top of the first lane initially.

The raker typically places the rake or lute flat on the existing pavement surface, outside the edge of the new

mix on top of the first lane. As the rake is moved transversely into the mix and across the top of the joint, all the mix is cleaned off the existing mat and pushed onto the new mat.

Because the raker does not lift the rake at the joint but moves the rake back and forth in a continuous sweeping or rocking motion, there is a lack of mix at the joint. The mix that should have been in place and ready to be compacted along the joint is now located partly across the width of the new mat. In most cases, the level of the uncompacted mix adjacent to the joint on the new mat is at the same elevation as the compacted mix on the other side of the joint. In some cases, so much mix is raked off the joint that a dip occurs at the longitudinal joint even before compaction of the mix begins. When either of these two problems occurs, it becomes impossible to obtain the required degree of density at the joint because there is not enough mix at the joint for compaction by the rollers. Moreover, when mix that is pushed off the longitudinal joint is deposited on the new asphalt mat, it changes the surface texture of the mat where it is deposited. Depending on the gradation of the mix being placed, the result can be a significant difference in the texture of the mat from one side of the lane to the other.

Excessive raking of the longitudinal joint is highly detrimental to the long-term performance of the joint because of the effect on the density along the joint. Excellent longitudinal joints can be constructed with minimal or no raking, if the proper amount of overlap of the new mix on the previously placed mat is achieved. It is therefore recommended that raking of the longitudinal joint be eliminated if proper overlap and compaction can be obtained.

Compaction of the Longitudinal Joint

If the level of the new, uncompacted mix is even with or below the level of the compacted mix in the adjacent lane, steel wheel compaction equipment will not be able to properly densify the mix along the joint. Whether the first pass of the roller is on the hot side of the joint or on the cold side (Figure 17-14), part of the weight of the roller drums will be supported on the previously compacted mat. As a result, the compaction equipment will bridge the mix at the joint, leaving it essentially uncompacted or only partially compacted. Thus, the level of the mix at the longitudinal joint must be above that of the compacted mix by an amount equal to approximately 6 mm for each 25 mm (¼ in. for each 1 in.) of



FIGURE 17-14 Starting compaction of longitudinal joint from the cold side, no longer a recommended practice.

compacted pavement if proper compaction of the mix at the joint is to be accomplished.

The use of a steel wheel roller, operated in either the vibratory or static mode, to compact the longitudinal joint generally results in bridging of the mix at the joint, and therefore a lack of density due to a lack of mix. Density can be obtained along the joint through the use of a pneumatic tire roller. The outside rubber tire on this type of compaction equipment can be placed directly over the mix at the joint. The compactive force applied by this tire can significantly increase the density obtained at that point. Nevertheless, a dip in the pavement surface will still occur along the joint if there is a lack of mix at that location. If proper density is to be achieved along the joint, there must be enough HMA there to compact, regardless of the type of roller used.

Rolling from the Hot Side

The most efficient way to compact a longitudinal joint is to place the roller on the hot (new) mat and overlap the joint by a distance of approximately 150 mm (6 in.) over the cold mat. The majority of the compaction equipment weight is where it is needed most—on the new mat. The mix at the joint is compacted into the joint area by the roller as long as the new mix at the joint is of the proper height. The slope along the edge of the first lane and the lower density of the mix placed beside the paver end gate provide the volume required for the mix to be blended in along the joint without leaving a hump at the joint. Any type of roller used for the breakdown rolling of the mix—vibratory or static steel wheel roller or pneumatic tire roller—can be used to compact the longitudinal joint as

long as the elevation of the mix at the joint is above that of the cold mat and the new mix is still hot. Figure 17-15 shows a longitudinal joint being compacted with a pneumatic tire roller.

Sometimes the first pass of the roller is completed with the edge of the equipment about 150 mm (6 in.) away from the longitudinal joint (see Figure 17-16), in the belief that the mix will be shoved toward the joint by the roller, and better compaction will thereby be obtained. If the mix being placed is stable enough, however, the roller should not be able to move the material laterally to any significant extent. Thus if the mix design is proper, this method of compacting the joint provides no advantage over performing the first pass of the roller 150 mm (6 in.) outside the joint. Even if the mix is tender, there is no advantage to this method of compaction. If the mix can be moved laterally by the



FIGURE 17-15 Compaction of longitudinal joint with pneumatic tire roller.





FIGURE 17-16 Compaction with edge of equipment inside longitudinal joint.

roller, the mix design should be reviewed to determine whether a more stable mix can be produced. If the mix does move toward the joint, excess mix in the form of a hump will be present along the joint, resulting in turn in a lack of mix just outside the edge of the roller drum, between the roller and the joint. When the roller moves over to compact the mix at the joint, the drums will ride on top of the excess mix, trying to shove the mix back where it came from. With this procedure, the level of density obtained at the joint may be highly variable.

In summary, there appears to be no advantage to performing the first pass of the roller inside the joint by some distance. Lapping the roller over the adjacent old pavement typically is the most efficient way to provide roller coverage for the entire pavement width. Further, the overlap method provides for a more uniform density level at the longitudinal joint than does performing the first pass of the roller inside the joint.

Rolling from the Cold Side

In the past it was common practice to do the initial rolling of the longitudinal joint from the cold (previously placed mat) side of the joint, as seen in Figure 17-14. With this method, the major portion of the weight of the roller is supported by the cold, compacted mat. Only about 150 mm (6 in.) of the width of the roller hangs over the fresh mat, compressing the mix along the joint. The majority of the compactive force is wasted because the roller is essentially applying its compactive force to an already compacted HMA material.

While the roller is operating on the cold side of the longitudinal joint, the mix on the hot side of the joint, as well as the rest of the mix in the course being laid, is cooling. Depending on environmental conditions and

the thickness of the mix being placed, compacting the joint from the cold side often hampers the ability to obtain the desired density over the entire pavement width.

The reason often given for rolling the joint from the cold side is that this method allows the rollers to “pinch” the joint so a greater degree of density is obtained. One edge of the roller drum rides on the new mix, while the other edge is in contact with the old mix some distance away across the first lane. More weight from the roller is thus applied to the new mix, which supposedly results in more density. Recent research, however, has indicated that the same density can be obtained at the longitudinal joint whether the initial rolling is accomplished from the hot or the cold side. Since it is more efficient to compact the whole mat, as well as the joint, from the hot side, compaction from the cold side is not recommended.

Regardless of the method used to compact the longitudinal joint, the level of density obtained at that location is typically at least 2 percent below the average density that can be produced in the main portion of the mat. This difference occurs primarily because the first lane has an unconfined edge that tends to move laterally. Even if the unconfined edge of the first lane is compacted, allowing the roller to hang over the edge, the density at the joint typically will still be less than that achievable in the main portion of the mat. If a particular level of joint density is to be required in the specifications, the percentage of the theoretical maximum density of the mix at the joint should be less than that required for the rest of the mat.

Wedge Joints

If traffic is allowed to cross a longitudinal joint before the second lane is constructed, some agencies limit the compacted depth of HMA that can be placed. In such cases, a wedge joint may be specified.

The wedge is usually formed during the first pass of the paver by attaching a metal form to the end gate of the paver screed. The degree of slope on the wedge varies, typically from 6:1 to 12:1 horizontally to vertically. The top of the wedge should have a notch so that sufficient material for compaction can be placed directly in the joint during the second pass. Formation of the wedge is not particularly problematic.

The cross slope of the wedge is different from that of the mainline mat. In addition, the wedge is quite narrow. Thus it is difficult to obtain adequate density on the HMA in the wedge before the adjacent lane is placed. If the rollers used to compact the rest of the mat width are used to compact the wedge, rounding of the edge may

occur. This in turn will make it significantly more difficult to match the top of the joint when the next lane is constructed.

Different types of small rollers have been used to compact the mix in the wedge. Figure 17-17 illustrates one such attempt. In general, because of the lack of weight of this type of compaction equipment, it cannot be used to attain the desired level of density in the wedge material. However, when the adjacent lane is placed, the heat softens the wedge, allowing for some additional compaction.

Another potential problem associated with joints relates to the ability to match the joint uniformly when the adjacent lane is placed. There are two reasons for this problem. First, if the edge has been rounded during the compaction operation, the resulting ragged edge will be difficult to match with the second pass. Further, it will be necessary to feather out the mix in the new lane and attempt to blend that material into the mix in the first lane. Depending on the size of the aggregate incorporated into the mix, this feathering process may not be uniformly successful. When the second lane is placed and the mix is blended into the first lane, the larger aggregate particles in the mix will be exposed where the mix is feathered. The result may be a much rougher surface texture in the joint area and potential crushing of the coarse aggregate under the rollers. Significant raveling of the mix will then occur under traffic. Because of the feathering of the new mix into the old mix at the wedge joint, then, the performance of some wedge joints under traffic has been less than desirable.

One way to improve the performance of a wedge joint is to construct a short vertical face on the edge of the first lane before the wedge is formed. In this case, the depth and size of the wedge are reduced. Typically one-half of



FIGURE 17-17 Compaction of mix in wedge joint.

the uncompacted lift thickness is constructed vertically by a metal form attached to the end gate on the paver screed; the remaining thickness is shaped into a wedge by the same form. This type of wedge joint has several advantages. First, since the amount of mix in the wedge is reduced, there is less mix at the longitudinal joint with lower density than the full wedge joint. Second, because of the vertical face on the upper portion of the joint, it is easier to tie in the mix in the second lane without having to make a feathered joint. The potential for raveling of the new mix at the joint is thereby greatly reduced. Further, the surface texture of the mix at the joint is uniform since the mix does not have to be feathered, and the coarse aggregate in the mix will not be crushed by the rollers.

The wedge joint built with a short vertical face also works well from the standpoint of traffic safety during construction. The key to good performance at the joint is to ensure that adequate density is obtained. The joint construction process should ensure good joint density.

Echelon Paving

If echelon paving (two pavers running next to each other in adjacent lanes) is used, construction of the longitudinal joint is changed so that the compaction of the unconfined edge of the first lane is delayed until the second lane is placed. The amount of overlap between the first and second lanes is also modified. The distance that the screed end gate of the trailing paver extends over the uncompacted mat behind the first paver should be no more than 25 mm (1 in.). The end gate of the second paver screed must be set at the same level as the bottom of the screed plate of the first paver. Doing so will prevent the end gate of the screed of the second paver from dragging on the mix placed by the first or leading paver and changing the surface texture of the mix in the area of the overlap.

No raking of the joint is needed. The compaction process is modified so that the rollers densifying the mix behind the lead paver are required to stay about 150 mm (6 in.) away from the free edge of the mat on the side toward the second paver. Once the mix from the second or trailing paver has been placed against the uncompacted edge of the mix from the first paver, the rollers compacting the second lane are used to densify the mix across the joint. With proper lapping and compaction, it is usually difficult to see the position of the longitudinal joint produced by the echelon paving process. In addition, use of this technique normally results in the density of the longitudinal joint being equal to that of the adjacent mat.



SUMMARY

The following factors should be considered in monitoring joint construction operations:

- If a transverse butt joint is to be built, the paver operator should maintain a constant head of material in front of the screed to a point downstream of the location where the joint is to be constructed. To prevent a decrease in the layer thickness upstream of the transverse joint, the operator should not be allowed to run the hopper, slat conveyors, and augers empty of mix before the joint location is reached.

- For the construction of a transverse butt joint, provision must be made for compacting the mix adjacent to the butt joint to the same degree as the previously placed mix without rounding off the end of the mix at the joint.

- For the construction of a tapered transverse joint, the thickness of the layer should be maintained to a point downstream of the location where the vertical face of the joint will eventually be constructed. Treated release paper, not sand or dirt, should be used as a bond-breaking material under the mix in the taper.

- When paving is restarted, the asphalt mix in the taper should be removed and then discarded or recycled. A vertical face should be present at the selected joint location, or the mix should be cut back to create a vertical face. A tack coat should be applied to the existing pavement surface at the joint location.

- The screed of the paver should be set on starting blocks on the cold side of the transverse joint. The thickness of the starting blocks should be 6 mm ($\frac{1}{4}$ in.) for each 25 mm (1 in.) of compacted layer thickness when the blocks and paver screed are set on another pavement layer. If the paver is starting to place mix at a new location, the thickness of the starting blocks should be the same as that of the compacted new layer plus 6 mm per 25 mm ($\frac{1}{4}$ in. per 1 in.) of compacted layer thickness. It is impossible to construct a proper transverse joint if blocks are not used to bring the screed to the proper elevation on the cold side of the joint before paving is started.

- The mix on the downstream side of the transverse joint must be higher than that on the previously compacted side of the joint to allow for adequate rolldown of the freshly placed mix.

- Minimal raking is needed at a properly constructed transverse joint.

- Ideally, a transverse joint should be compacted with the roller in a transverse direction. On a practical basis and for safety reasons, however, a transverse joint can be compacted properly with the roller running in a longitudinal direction as long as the initial elevation of the new mix is above that of the old mix on the cold side of the joint.

- To achieve proper density at the longitudinal joint, it is essential to compact the unconfined edge of the first lane correctly. The edge of the drum on a vibratory or static steel wheel roller should extend out over the edge of the mix a minimum of 150 mm (6 in.) when the first lane is being densified.

- During the construction of a longitudinal joint, the end gate of the paver should overlap the previously placed lane by no more than 40 mm ($1\frac{1}{2}$ in.). Any increase in the overlap beyond this distance will result in excess material that will need to be raked off of the joint. The new mix should be 6 mm per 25 mm ($\frac{1}{4}$ in. per in.) thicker than the compacted mix.

- Minimal or no raking of the longitudinal joint should be necessary if the overlay of the paver screed on the adjacent lane is 40 mm ($1\frac{1}{2}$ in.) or less. The mix should not be bumped against the joint since it will then be impossible to blend the extra mix into the new mix during the compaction process. In no case should the raker broadcast the mix across the width of the new lane.

- Compaction of the longitudinal joint should be accomplished by rolling from the hot side of the layer with the roller wheels lapping approximately 150 mm (6 in.) over onto the cold mat. It is not recommended that the initial pass of the roller on the hot side of the joint be inside of the joint. It is much more efficient to have the first pass of the roller extend over the joint for a short distance onto the cold side of the joint.

- If a wedge joint is constructed, a short vertical face should be formed into the top of the joint to minimize the amount of mix contained in the wedge and permit the mix in the second lane to be placed and compacted against the first lane. This procedure will also minimize the amount of raveling that can occur at this type of joint if the second lane is feathered into the first.



18 Compaction

Compaction is the most important factor in the performance of an HMA pavement. Adequate compaction of the mix increases fatigue life, decreases permanent deformation (rutting), reduces oxidation or aging, decreases moisture damage, increases strength and stability, and decreases low-temperature cracking. An HMA mixture with all the desirable mix design characteristics will perform poorly under traffic if it has not been compacted to the proper density level. Indeed, a properly compacted mix with marginal properties will often outperform a mix with desirable properties that has been inadequately compacted.

DEFINITIONS

The *density* of a material is simply the weight of the material that occupies a certain volume of space. For example, an HMA mixture containing limestone aggregate might have a compacted density of 2355 kg/m³ (147 lb/ft³). This density, or unit weight, is an indication of the degree of compaction of the mixture. Paving materials made with different aggregates can have significantly different densities. An HMA mixture manufactured with lightweight aggregate, for example, might have a compacted density of only 1362 kg/m³ (85 lb/ft³).

Compaction is the process by which the asphalt mix is compressed and reduced in volume. Compaction reduces air voids and increases the unit weight or density of the mix. As a result of the compaction process, the asphalt-coated aggregates in the mix are forced closer together; this increases aggregate interlock and interparticle friction and reduces the air void content of the mix.

It is possible, under controlled laboratory conditions, to determine the density of HMA required to provide zero air voids. At this point, called the theoretical maximum density, no air voids would remain in the mix. Theoretical maximum density can be calculated from the percentages and specific gravity of each component of the mix. It can also be determined from a laboratory test, ASTM Test Method D2041, Theoretical Maximum Specific Gravity and Density of Bituminous Paving Mixtures, sometimes called the Rice test. The latter procedure

is preferred for determining the theoretical maximum density compared with the mix component calculations.

On the roadway it is not possible to compact a well-designed mix to a voidless condition; therefore, all asphalt mixes will contain some air voids once the compaction process has been completed. The air void content of the mix is simply the volume of the spaces between the asphalt-coated particles. Because this volume cannot be measured directly, a ratio of the unit weight of the compacted mixture to the theoretical maximum density is used. Air void content is determined from the ratio of the bulk specific gravity of the mix to the theoretical maximum density as given by the following formula: percent air voids = 100[1 – (bulk specific gravity/theoretical maximum specific gravity)]. Thus if the bulk density is 95 percent of the theoretical maximum density, the mix has 5 percent air voids.

As an example, assume that the compacted density of an HMA mix is 2355 kg/m³ (147.0 lb/ft³) and that the maximum theoretical density of the same mix is 2467 kg/m³ (154.0 lb/ft³). The air void content of the mix will be the difference between the two values, 2467 – 2355 = 112 kg/m³ (154.0 – 147.0 = 7.0 lb/ft³), divided by the value of the maximum theoretical density of 2467 kg/m³ (154.0 lb/ft³), that is, 4.5 percent.

FACTORS AFFECTING COMPACTION

Four primary factors affect the ability of the compaction equipment to densify an asphalt mixture: properties of the materials in the mixture, environmental variables, conditions at the laydown site, and type of compaction equipment used. Each of these factors is discussed below.

Properties of the Materials

Aggregates

The compactibility or stiffness of an HMA mixture is influenced by the nature of the aggregate particles and aggregate gradation in the mix. Three properties of the coarse aggregate particles used in an asphalt mixture can affect the ability to obtain the proper level of density:



surface texture, particle shape, and number of fractured faces. With increases in aggregate angularity, nominal maximum size of the aggregate, and hardness of the aggregate (granite compared with limestone, for example), the compactive effort needed to obtain a specific level of density increases. Angular particles offer more resistance to reorientation by rollers than do rounded particles; hence, increased angularity increases resistance to densification from applied compactive effort.

The surface texture of the individual aggregate particles is also important. Aggregates that have a rough surface texture are more difficult to compact than aggregates with a smooth surface texture. The compactive effort required is affected as well by the shape of the aggregate. A cubical or block-shaped aggregate requires greater compactive effort than does a rounded particle before a given density level is achieved.

A continuously graded (dense-graded) aggregate, from coarse to fine, is generally easiest to compact. Open-graded or cap-graded mixes typically require a significant increase in compactive effort to obtain the desired level of density. An oversanded or finely graded mix, because of its inherent tender nature, may be difficult to compact.

Mixes that contain an excess of midsize fine aggregate [between the 0.60- and 0.3-mm (No. 30 and No. 50) sieves or between the 0.425- and 0.180-mm (No. 40 and No. 80) sieves] also are difficult to compact because of their lack of internal cohesion. These mixes tend to displace laterally rather than compress vertically. In addition, dust content [amount of aggregate passing the 0.75-mm (No. 200) sieve] affects the compactive effort needed. A mix designed with a high dust content will generally be more difficult to compact than one with a lower dust content, depending on the angularity and fineness of the dust particles.

In general, aggregates with properties that improve resistance to fatigue and permanent deformation require increased compaction effort to obtain a desired density.

Asphalt Cement

The grade and amount of asphalt cement used in a mix affect the ability to densify the mix. An asphalt cement that is higher in viscosity or lower in penetration will generally cause a stiffer mix at a given mix temperature, which will require a greater compactive effort to achieve density. Thus a mix produced with an AC-20 viscosity-graded asphalt will typically be stiffer, at a given temperature, than a similar mix containing an AC-10 asphalt cement. Within the PG binder classification system (see Section 3), a mix produced with a PG 70-22 graded binder

will usually be stiffer, at a given temperature, than a mix produced using a PG 58-22 binder material. The stiffer the mix, the more compactive effort is needed to achieve a given density level.

The degree of hardening (aging) that occurs in asphalt binder during manufacture of the mix also affects the compactibility of the mix. Various asphalts age differently during the mixing process, depending, in part, on the chemical properties of the asphalt cement. Aging is also influenced by the type and operating characteristics of the HMA plant—more hardening will typically occur when a drum-mix plant is operating at partial capacity than when it is operating at full capacity. Moreover, higher manufacturing temperatures generally produce somewhat stiffer mixes.

The asphalt cement content of the mix also influences its compactibility. In general, a mix with too little asphalt cement may be stiff and require increased compactive effort, whereas a mix with too much asphalt cement will compact easily or may become tender and shove under the rollers.

Mix Properties

A mix that is at a higher temperature when laid [for example, 150°C (300°F)] will be easier to compact than a mix that is at a lower temperature [for example, 125°C (260°F)]. If the initial mix temperature is too high, however, the mix may be tender and difficult to compact until the temperature decreases and the viscosity of the asphalt binder increases. Conversely, if the mix temperature is too low at the time the initial compactive effort is applied, increased compactive effort will be needed to obtain the required density; indeed, the required density may never be achieved.

The workability of the mix is also affected by the temperature susceptibility (sensitivity of mix stiffness to temperature) of the asphalt cement. For highly temperature-susceptible asphalt binder, less time will be available for compaction because the mix will increase in stiffness more quickly with a decrease in temperature than mix containing a less temperature-susceptible asphalt.

The fluids content of the mix also affects the compactive effort needed. The fluids content is the sum of the asphalt cement content and the moisture content of the mix. If the amount of moisture in the mix from the plant is high (greater than 0.2 percent, by weight of mix), the extra fluids content will act like asphalt binder and may make the mix unstable and difficult to compact. Thus, the moisture content of plant-produced mix should be measured regularly. Most specifications require that moisture



content be less than 0.5 percent, by weight of mix, when the mix is discharged from the plant. If the mix characteristics are marginal, however, a residual moisture content of as little as 0.2 percent may significantly alter the tenderness of the mix, and therefore its compactibility.

Environmental Variables

Research completed in the early 1970s determined the time available for compaction of various HMA mixes. The time available for compaction is defined as the time, in minutes, for a mix to cool from its laydown temperature when it passes out from under the paver screed to a minimum compaction temperature. Minimum compaction temperature for that study was set at 80°C (175°F). It was found that below this temperature, little density gain was achieved with the application of additional compactive effort. Any additional rolling with steel wheel rollers, except to remove roller marks, may result in fracture of the aggregate in the mix and a decrease in density. It is emphasized, however, that rolling should occur at as high a temperature as possible, given the properties of the asphalt mix, in order to achieve the required level of density with minimum compactive effort. At temperatures near 80°C (175°F), the probability of significantly increasing density or reducing air voids is very low. This lower cutoff temperature may vary somewhat with grades of asphalt.

In the 1970s study, six variables were found to have an effect on the rate of cooling: layer thickness, air temper-

ature, base temperature, mix laydown temperature, wind velocity, and solar radiation. "Cooling curves," shown in Figures 18-1 and 18-2, illustrate the amount of time available for compaction under different combinations of these variables. For these two figures, it is assumed that the material being compacted is a dense-graded HMA mix. The surface temperature of the underlying pavement is assumed to be equal to the ambient air temperature. A constant wind velocity of 10 knots [about 18 km/h (11 mph)] and a constant degree of solar radiation are also assumed. The curves then show the estimated time, in minutes, required for the mix to cool from its laydown temperature to the minimum compaction temperature of 80°C (175°F) for different compacted layer thicknesses.

To use these graphs, three input variables are needed: initial mix laydown temperature, base surface temperature (assumed to be equal to the ambient air temperature), and compacted layer thickness. Figure 18-1 is to be used for mix laydown temperatures of both 121°C and 149°C (250°F and 300°F). Figure 18-2 is to be used when the mix laydown temperature is 107°C or 135°C (225°F or 275°F). The range of base temperatures for each set of curves is from -12°C to 15°C (10°F to 60°F). The range of mix layer thicknesses is from 13 to 150 mm ($\frac{1}{2}$ to 6 in.).

Layer Thickness

Layer thickness is probably the single most important variable in the rate of cooling of asphalt mixtures. Dur-

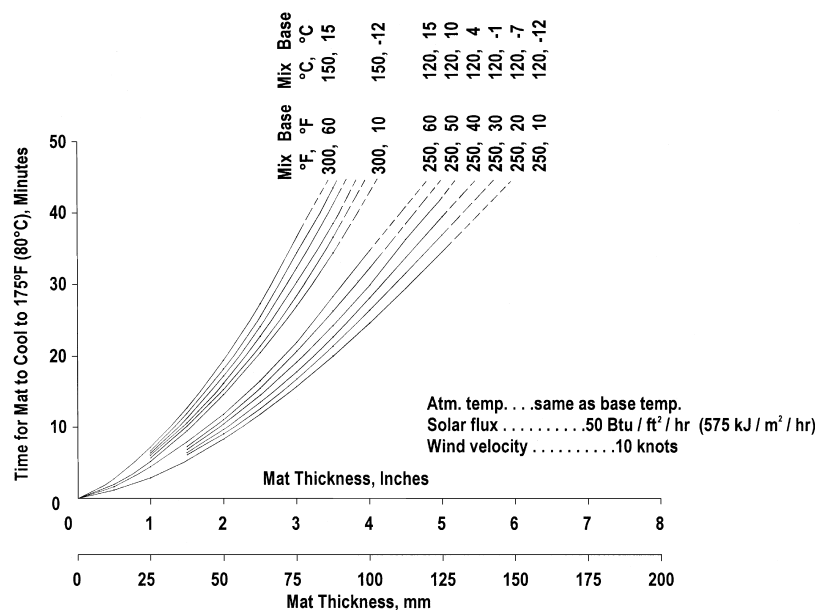

FIGURE 18-1 Time for mat to cool to 80°C (175°F) versus mat thickness for lines of constant mix and base temperatures [121°C (250°F) or 149°C (300°F) behind paver].



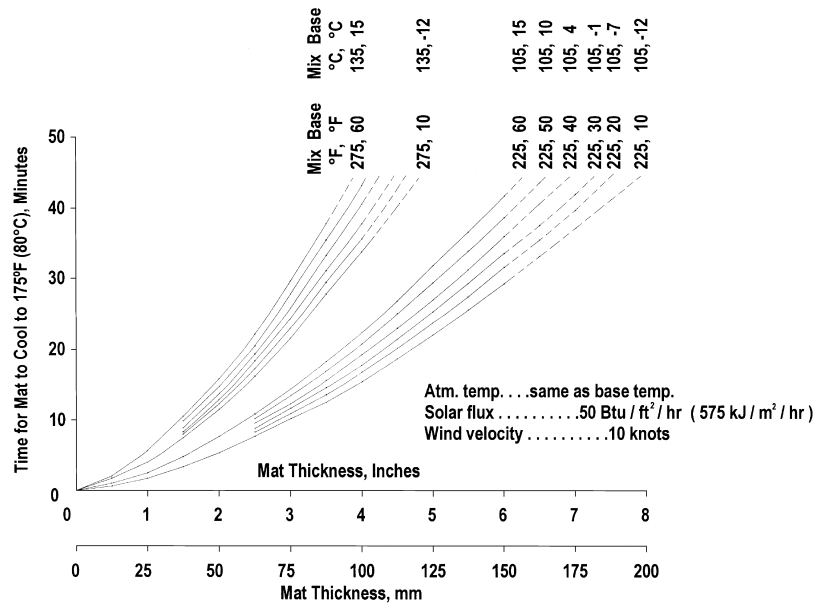

FIGURE 18-2 Time for mat to cool to 80°C (175°F) versus mat thickness for lines of constant mix and base temperatures [107°C (225°F) behind paver].

ing early spring and late fall, thin lifts are difficult to compact properly. Layers of mix less than 50 mm (2 in.) in compacted thickness are highly susceptible to premature failure because of the inability to densify the mix adequately before it cools. The desired density is very difficult to obtain on thin lifts of mix in cool weather because of the mix’s rapid decline in temperature.

As the thickness of the layer being placed increases, the time available for compaction also increases. For example, referring to Figure 18-1, for a mix laydown temperature of 121°C (250°F) and a base temperature of 5°C (40°F), a mat 25 mm (1 in.) thick will cool to the 80°C (175°F) compaction cut-off temperature point in less than 4 minutes. For a layer 50 mm (2 in.) thick under the same mix and base temperature conditions, it will take about 10 minutes for the material to cool to 80°C (175°F). Doubling the lift thickness from 25 to 50 mm (1 to 2 in.) increases the time available for compaction from 4 to 10 minutes. If the layer depth is 100 mm (4 in.), the time to cool becomes about 29 minutes, a significant increase in available compaction time under similar temperature conditions.

Referring again to Figure 18-1, the relative effect of pavement lift thickness is the same for a mix laydown temperature of 149°C (300°F) and a base temperature of 5°C (40°F). As the depth is decreased from 100 to 50 to 25 mm (4 to 2 to 1 in.), the time available for the mix to cool from 149°C (300°F) to 80°C (175°F) decreases

from more than 40 to 16 to only 6 minutes, respectively. From these data, it is apparent that the time available to compact a thin layer of HMA is extremely limited in cold weather.

Air and Base Temperature

A portion of the heat in the asphalt layer is lost to the air. Heat is also lost to the layer on which the new material is placed. Cooling of the mix near the base is more rapid than near the surface. Thus, base temperature is actually more important than air temperature in determining the time available for compaction.

Most specifications require a minimum air temperature for paving and compaction operations. It is often assumed that air and base temperature are the same. This is not necessarily true, particularly in cool weather. In early spring, the base temperature (surface temperature of an existing pavement layer) will be lower than the ambient air temperature early in the morning. The air temperature might be 5°C (40°F) and rising, but the base temperature might be 3°C to 6°C (5°F to 10°F) below the air temperature. The low base temperature will reduce the time available to achieve adequate density. On the other hand, base temperatures are often higher in the late fall than in the early spring for the same overnight air temperature. Thus, a given thickness of material is easier to compact in the fall than in the spring for the same air temperature conditions.

A moist base layer significantly increases the cooling rate of the new overlying asphalt layer. Heat is lost from the mix to the moisture, turning water into steam and increasing the rate of heat transfer. Paving on a wet surface therefore hampers the ability to gain proper density in the mix.

As the temperature of the ambient air and existing pavement surface increases, the time for the mix to cool from the laydown temperature to 80°C (175°F) also increases. Referring to Figure 18-2, for a mix temperature of 135°C (275°F) and a lift thickness of 75 mm (3 in.), it takes only 22 minutes for the mix to cool when the base and air temperatures are both -7°C (20°F). The time available is extended slightly to 25 minutes for a base/air temperature of 5°C (40°F) and to 30 minutes for a base/air temperature of 15°C (60°F).

Again referring to Figure 18-2, for a lift thickness of 50 mm (2 in.), using the same mix laydown temperature of 135°C (275°F), the time to cool to 80°C (175°F) increases from 11 to 13 to 15 minutes for a base/air temperature of -7°C, 5°C, and 15°C (20°F, 40°F, and 60°F), respectively. Thus the temperature of the ambient air and base surface is important, though not nearly as important as mat lift thickness, in determining the time available for compaction.

Mix Laydown Temperature

Asphalt mixes are usually produced at temperatures between 130°C and 165°C (270°F and 325°F). Depending on environmental conditions and the length of the haul, the mixture can decrease in temperature from 3°C to 14°C (5°F to 25°F) between the plant and the paver. The plant mixing temperature is not important in determining the time available for compaction, but mix temperature as it comes out from under the paver screed is. As the initial mix laydown temperature is increased, the time available for compaction also increases. Thus within limits, the mixing temperature should be determined by the laydown and compaction temperature requirements.

Referring to Figure 18-1, for a lift thickness of 50 mm (2 in.) and a base/air temperature of 5°C (40°F), the time to cool to 80°C (175°F) increases from 9 to 16 minutes as the laydown temperature increases from 121°C (250°F) to 149°C (300°F). For a lift thickness of 100 mm (4 in.) and a base/air temperature of 15°C (60°F), a change in laydown temperature from 149°C (300°F) to 121°C (250°F) reduces the time available for compaction from 36 to 21 minutes.

The effect of mat laydown temperature is more significant for thinner mats and lower base temperatures.

As the time to cool to 80°C (175°F) becomes shorter, an increase in the mix laydown temperature extends the compaction time significantly in most cases.

Wind Velocity

A thin layer of mix will cool more quickly when there is a strong wind than when there is little or no wind. Wind has a greater effect at the surface of the mix than within and can cause the surface to cool so rapidly that a crust will form. This crust must be broken down by the rollers before the compaction process can begin. The velocity of the wind is more of a concern for thin layers of mix placed in cool weather than for thicker layers laid in warmer weather.

Solar Flux

The amount of radiant energy available from the sun (solar flux) depends on many variables, including the position of the sun above the horizon, the distance above sea level of the paving project, the amount of haze in the air, and the degree of cloud cover. A mix will cool more slowly on a sunny than on a cloudy day. The amount of solar flux has more effect on base temperature than on mix temperature. For a given ambient air temperature, the base temperature will be higher on a sunny day than on a day with heavy cloud cover. The higher base temperature will reduce the rate of cooling of the mix and increase the time available for compaction.

Obtaining Proper Density Under Varying Environmental Conditions

Compaction of asphalt mix requires common sense. If lift thickness, air and base temperatures, laydown temperature, or solar flux decreases or the wind increases, less time will be available to obtain the required level of density before the mix cools to 80°C (175°F). Thus a significant change in any one of these factors can make the difference between constructing a durable pavement and building one that will be subject to early failure.

If possible, the best solution to a potential compaction problem is to increase the thickness of the material being placed. A layer 25 mm (1 in.) thick cools so quickly, even in good environmental conditions, that proper density is difficult to obtain. The minimum course thickness that should be specified under the best of circumstances is 38 mm (1½ in.). For paving conducted in early spring or late fall, at least 50 mm (2 in.) of compacted asphalt mix should be placed in a single lift, if possible.



The easiest solution to a potential time availability problem is to increase the discharge temperature of the asphalt mix at the plant, if doing so does not cause other problems with the mixture. The higher discharge temperature will permit an increase in the laydown temperature of the mix behind the paver screed, thereby allowing more time for the mix to cool to 80°C (175°F), all other factors being constant. It is also important to remember that as temperature rises, aging of binder and absorption increase, so increasing the mix temperature requires careful consideration. Increasing the mix temperature may not be enough, however, to provide adequate time for compaction under adverse environmental conditions and for thin layers of material. If the mix temperature is increased too much, the mix may be tender under the compaction equipment, and smoke or other emissions may become a problem. The mix must then be allowed to cool before the compaction process can begin. Thus there is an upper limit to the temperature increase to which the mix can be subjected.

Compaction effort can be increased simply by using more rollers to compact the pavement layer. In addition, wider or heavier rollers can be substituted for narrower or lighter equipment. A double-drum vibratory roller, for example, that is 2.1 m (7 ft) wide can be used in place of a static steel wheel tandem roller that is only 1.4 m (4½ ft) wide.

Another means of achieving desired compaction levels is to use the compaction equipment more effectively. Depending on the width being paved and the width of the rollers, the rollers can be placed almost side by side instead of end to end. Two rollers running in this fashion can cover a given area much more quickly than two rollers operating in the conventional manner. Density will increase because more compactive effort can be applied before the asphalt mat cools to 80°C (175°F). In essence, this method provides for two breakdown rollers instead of one breakdown and one intermediate roller. To obtain the required density levels, however, use of an intermediate roller or rollers may still be necessary. Increasing the speed of the rollers is not a good means of improving compaction. Two passes at high speed are less effective than one pass at half the speed.

If two different types or sizes of rollers (such as a vibratory and a pneumatic tire roller) are used for echelon rolling, it is important that each roller cover all of the mix surface. This may mean that the rollers must cross back and forth and run different roller patterns and numbers of passes. In addition, if one of the rollers is compacting a longitudinal joint, this must be considered in setting the

rolling pattern for each piece of compaction equipment. It is very important that all rollers be able to keep up with the speed of the paver and that the density obtained be measured to ensure that the required level of compaction is achieved uniformly across the width of the mat.

One procedure that should *not* be used in an attempt to increase the level of density in the mix is to increase the asphalt cement content of the mix arbitrarily. Although the additional asphalt cement may be beneficial in increasing the workability of the mix, it defeats the purpose of mix design and has been linked to long-term performance problems for the mix under traffic, such as rutting and shoving.

Laydown Site Conditions

A number of factors at the laydown site directly affect the ability of the compaction equipment to create the required level of pavement density. As discussed previously, the most important of these factors is the thickness of the layer being placed. The relationship between lift thickness and nominal maximum aggregate size in the mix is also important. If the course depth is at least three times the nominal maximum aggregate size, adequate density can be achieved with normal compactive effort.

Uniformity of lift thickness is another factor to be considered. Density is much easier to obtain in an asphalt layer that has a constant thickness as compared with one that varies in depth. A variable thickness layer is often difficult to densify to a given air void content uniformly, especially when placed over a rutted or uneven pavement surface. Static steel wheel rollers tend to bridge over ruts, particularly if the ruts are relatively deep and narrow. Vibratory rollers tend to be supported by the high points in the surface, although the vibratory action has some beneficial effect in compacting the mix in the ruts. Thus adequate density is usually not obtained throughout the mix with steel wheel rollers, particularly in rutted areas where it is needed the most. Use of a pneumatic tire roller is very helpful in achieving density in both ruts and high spots if proper tire inflation pressure and wheel load are used.

Compaction Equipment

The type of equipment used to compact the asphalt mix obviously has a significant effect on the density that can be obtained with a given number of passes. Three primary types of self-propelled compaction equipment are currently being used—static steel wheel rollers, pneumatic tire rollers, and vibratory steel wheel rollers. A

combination roller, equipped with both a vibratory drum and a set of four pneumatic tires, is also sometimes used.

Static Steel Wheel Rollers

Static steel wheel rollers, shown in Figure 18-3, normally range in weight from 2.7 to 12.7 tonnes (3 to 14 tons) and have compression drums that vary in diameter from approximately 1.0 m (3.3 ft) to more than 1.5 m (5 ft). The gross weight of the roller can usually be altered by adding ballast, but this adjustment cannot be made while the roller is operating and is not normally made during the course of a paving project. For this type of roller, both the gross weight of the machine and the contact area of the drums with the mix are important in determining the compactive effort applied by the roller to the surface of the new mat.

Effective contact pressure, in terms of kilopascals (kPa) [pounds-force per square inch (psi)] over the contact area, is the key variable for this type of equipment and is dependent on the depth of penetration of the drums into the mix: the greater the depth of penetration, the greater is the contact area and so the less is the contact pressure. Thus on the first pass of the roller, when the indentation of the drums into the mix is the greatest, the roller exerts less compactive effort on the mix. On subsequent passes as the mix becomes more dense, the drums penetrate to a lesser degree, and the compactive effort of the roller is increased.

Drawbar pull is defined as the horizontal force required to move the roller forward. The most efficient roller is that with the smallest drawbar pull. Rollers with large-diameter drums have lower drawbar pull (rolling resistance) because they do not tend to penetrate as far into the mix to develop a contact area as a roller with smaller-diameter drums.



FIGURE 18-3 Static steel wheel roller.

Once the size and weight of a static steel wheel roller have been selected, the variables under the control of the roller operator are the speed of the roller, the position of the roller on the mat in relation to the paver, operation with the drive wheel or drum toward the paver, and the number of passes made with the roller over each point in the pavement surface.

Pneumatic Tire Rollers

Pneumatic rollers are usually operated in the intermediate roller position, behind a vibratory or static steel wheel breakdown roller and in front of a static steel wheel finish roller. Pneumatic rollers are sometimes used, however, for initial rolling of the mix, and occasionally for finish rolling.

For a pneumatic roller, shown in Figure 18-4, the compactive effort applied to the mix is a function of the wheel load of the machine, the tire pressure, the tire design (tire size and ply rating), and the depth of penetration of the tires into the mix. All of the tires on the roller should be the same size, ply, and tire pressure. The area of each tire footprint and the wheel load of the roller are the primary factors in the effectiveness of a pneumatic tire roller. The greater the contact pressure between the tire and the mix, the greater is the compactive effort applied by the roller.

To be effective when used in the breakdown roller position, rollers with larger tires should be used. Rollers equipped with tires 7.50×15 or smaller are normally not effective as breakdown rollers. If pneumatic tire rollers are used as intermediate rollers, the minimum tire ply rating should be 12, and the tire pressure should be 400 kPa (60 psi) or greater.

The tire pressure used depends in part on the number of plies in the tires. In general, a 6-ply tire is limited to a



FIGURE 18-4 Pneumatic tire roller.



tire pressure of 400 kPa (60 psi), whereas a 10-ply tire can carry a pressure of up to 600 kPa (90 psi). A 12-ply tire, normally used on most large pneumatic tire rollers, can be inflated up to 800 kPa (120 psi) to compact asphalt mixes. The minimum weight of the pneumatic tire roller should be 13.6 tonnes (15 tons).

If the mix is tender, use of a lower tire pressure will displace the mix less than will use of a higher pressure. For a stiff mix, a higher tire pressure can be used because the mix will be stable enough to support the weight of the roller without shoving laterally under the tires. Tire pressure is normally kept constant for a given project, but the level selected should be dependent on the properties of the mix being compacted and the position of the roller on the mat. Tire pressure should not necessarily be the same if the pneumatic tire roller is used in the breakdown position as if used in the intermediate position. Higher tire pressure can often be employed when the pneumatic tire roller is used in the intermediate position because the mix should be stiffer at the lower temperatures in this stage of the process and can thus support more compactive effort without distortion.

The tires on the pneumatic roller will pick up the mix if the roller moves into the mix when the tires are cold. The tires will also often pick up the mix when an oversanded surface course mix is being compacted. Pickup may be a significant problem as well when the mix has been modified with polymer additives. If the mix contains a rubber additive, the pickup problem may be so severe that this type of roller cannot be used. If pickup of the mix on the tires is found to be a major problem, it should be determined whether the mix contains a modified binder material, although if the asphalt cement has been formulated to meet a PG binder grade, the binder supplier may be unwilling to reveal its composition for proprietary reasons.

Attempts are frequently made to eliminate the pickup problem by spraying water or a release agent on the tires during the rolling process. This practice does not always solve the problem. If the roller is not damaging the mat, a better solution is to allow the tires on the roller to reach the same temperature as the mix being compacted without spraying water or release agent on the tires. Pickup will be minimized or eliminated. Skirts consisting of pieces of plywood or rubber sheeting, shown in Figure 18-5, are sometimes hung from the sides of the roller around the tires to shield the tires from the wind and prevent them from cooling off. This approach is effective, especially on windy, cool days.

If a pneumatic tire roller is to be used as the breakdown roller in the roller train at the start of paving in



FIGURE 18-5 Pneumatic tire roller with skirts.

the morning, it is suggested that to minimize pickup, the roller be run back and forth for 10 to 15 minutes on the cold pavement before the paver begins to lay mix in order to start building up heat in the tires. Once paving begins, the roller should be operated in the intermediate position, behind a static steel wheel or vibratory roller, for another 10 minutes while the temperature of the tires increases to the same level as that of the mix. No water or release agent should be applied to the tires during this warmup time.

During the heating process, some pickup of the mix on the tires may occur. Once the tires have reached the same temperature as the mix, however, the amount of pickup will decrease. At this time, the roller should be briefly moved off of the paving lane, the tires quickly cleaned off, and the roller moved back onto the hot mix. The pneumatic tire roller can then be moved into the breakdown position and should be able to operate successfully without pickup of the mix. If the paving process is interrupted for any significant length of time, however, this preheating startup procedure will have to be repeated. In no case should the pneumatic tire roller be parked on the hot mat in an attempt to keep the tires warm while waiting for the paving operation to restart.

Once the size of the pneumatic tire roller and the tire pressure to be used have been selected, the only variables that can be controlled easily by the operator are the rolling speed, the location of the roller with respect to the paver, and the number of roller passes over each point in the pavement surface. If the compactive effort applied by the pneumatic tire roller is not adequate, the operator should alter the wheel load on the tires or change the inflation pressure, or both.

Vibratory Rollers

Vibratory rollers (see Figure 18-6) come in a variety of configurations. Single-drum vibratory rollers are manufactured with both a rigid and an articulated frame. Double-drum vibratory rollers come with rigid, single-articulated, and double-articulated frames. These rollers can be operated in any of three modes: static (with the vibrators off), with one drum vibrating and one drum static, and with both drums vibrating.

Vibratory rollers apply two types of compactive effort to the HMA—static weight and dynamic (impact) force. The compactive effort derived from the static weight of the roller is caused by the weight of the drums and frame. The compactive effort derived from the dynamic force is produced by a rotating eccentric weight located inside the drum (or drums). As the eccentric weight rotates about the shaft inside the drum, a dynamic force is produced. This force is proportional to the eccentric moment of the rotating weights and the speed of rotation. Changing the eccentric moment arm or adjusting the eccentric mass has a directly proportional effect on the dynamic force.

Although it is possible to combine the static weight and dynamic force to determine a total applied force, this procedure is not recommended for comparing vibratory rollers of the same or different classes. Rather, components of the total applied force should be evaluated separately. The elements of comparison for the dynamic component of a vibratory roller are the magnitude of the centrifugal force, its vibrating frequency, the nominal amplitude, and the ratio of the vibrating and nonvibrating masses acting on the drum. Nominal amplitude is defined as the weight of the drum divided by the eccentric moment of the rotating weight and is a function of the weight of the drum and the location of the eccentrics.

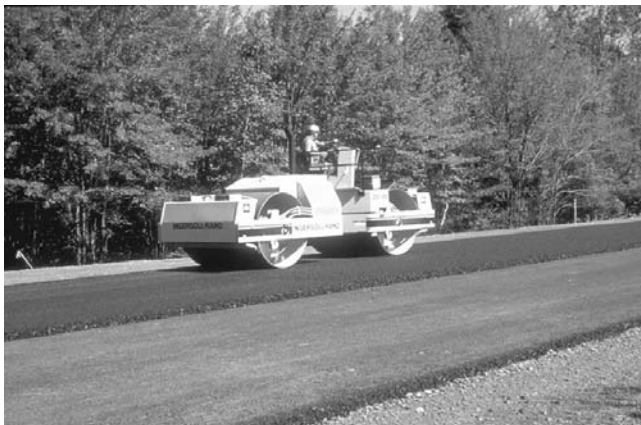

FIGURE 18-6 Vibratory steel wheel roller.

Normal values of nominal amplitude range from 0.25 to 1.02 mm (0.01 to 0.04 in.). Some rollers can operate at only one fixed amplitude. Others have high and low amplitude positions. For these rollers, the low nominal setting is typically 50 percent of the high setting. On some vibratory rollers, several (up to eight) different amplitude settings can be selected. The actual amplitude differs from the nominal amplitude because of the variation in the damping effect of different materials at different states of compaction. An increase in the applied nominal amplitude of vibration increases the compactive effort applied to the asphalt mixture. For a given frequency, changing the amplitude setting has a proportional effect on the dynamic force. For a given amplitude, changing the frequency influences the dynamic force to the second power.

The effectiveness of an increase in the amplitude value, however, is sometimes dependent on the thickness of the layer being densified. For relatively thin layers of mix, generally less than approximately 30 mm (1¼ in.) in compacted thickness, the vibratory roller should typically be operated in the static mode—without vibration. Otherwise, as the mix densifies under the applied compactive effort of the vibratory roller, the drums will begin to bounce. This in turn may cause the mix to shove and decompact instead of densifying, depending in part on the stiffness of the underlying pavement structure. In addition, when the roller is operated in the vibratory mode on a thin lift, some of the aggregate in the HMA will be crushed.

In general, for layers with a thickness of 30 mm (1¼ in.) or more, a low amplitude setting should be used on the vibratory roller. This setting should be maintained unless the compacted thickness of the layer is at least 65 mm (2½ in.). As the thickness of the layer increases beyond this level, the amplitude setting on the roller can generally be raised to increase the compactive effort applied to the mix. It should be noted, however, that very few layers of HMA are more than 65 mm (2½ in.) in compacted thickness.

If there is a problem in achieving density quickly, roller operators will sometimes raise the amplitude setting on the roller. This is not necessarily the correct practice. In most cases, particularly for lifts 65 mm (2½ in.) or less, increasing the applied force may cause the aggregate in the mix to fracture and actually reduce rather than increase density. Better practice is to increase the number of passes made over the mix with the vibratory roller operated at the low amplitude setting. The vibratory roller should be operated at low amplitude unless high amplitude is needed to achieve a particular density level. If



so, the mix should be stiff and internally stable enough to support the added compactive effort without checking of the mix or fracturing of the aggregate.

Vibration frequency is the number of complete rotations per minute of the eccentrics: the faster the rotation, the greater the frequency. Some vibratory rollers can operate at only one frequency; others have a choice of two or more frequency settings. Most older vibratory rollers can operate with frequencies in the range of 1,600 to 2,400 vibrations per minute, whereas newer rollers can operate at up to 3,600 vibrations per minute. In general, to apply adequate compactive effort to the HMA without introducing ripples or roughness into the surface of the layer, a vibratory roller should be operated at a frequency of at least 2,000 vibrations per minute. Further, with few exceptions, the vibratory roller should be operated at as high a frequency setting as possible.

Spacing of the impacts depends on the frequency of the vibration and the travel speed of the roller. As frequency decreases and roller speed increases, the distance between impacts on the surface of the mix increases. Conversely, an increase in the vibratory frequency and a decrease in the roller speed both cause the number of impacts per foot of distance to increase, thereby increasing the compactive effort applied by the roller. A smaller impact spacing (a greater number of impacts per foot) is usually preferred. It must be realized, however, that the productivity of the roller can decrease as the roller speed is reduced.

Several roller manufacturers suggest that the ideal impact spacing is in the range of 30 to 40 impacts per meter (10 to 12 impacts per foot) in order to provide a balance between roller productivity and layer smoothness. This spacing can be determined by dividing the roller speed by the frequency of vibration: impact spacing = roller speed in meters (feet) per minute, divided by frequency of vibrations. An applied force of 30 impacts per meter is equal to approximately 33 mm between impacts, whereas 40 impacts per meter is equal to 25 mm between impacts (an applied force of 10 impacts per foot is equal to 1.2 in. between impacts, while 12 impacts per foot is equal to 1.0 in. between impacts).

At a frequency of 2,400 vibrations per minute, a roller speed of about 4.8 km/h (80 m/min) will result in an impact spacing of 33 mm (30 impacts per meter), and a roller speed of about 3.6 km/h (60 m/min) will result in an impact spacing of 25 mm (40 impacts per meter) (at a vibratory frequency of 2,400 vibrations per minute, a roller speed of approximately 2.7 mph will result in an impact spacing of 10 impacts per foot, and a roller speed of about 2.3 mph will result in an impact spacing

of 12 impacts per foot). If the vibratory frequency is set at 3,000 vibrations per minute, the corresponding roller speeds will be approximately 5.6 and 4.2 km/h for impact spacings of 30 and 40 impacts per meter, respectively (if the vibratory frequency is set at 3,000 vibrations per minute, the corresponding roller speeds will be about 3.4 and 2.8 mph for an impact spacing of 10 and 12 impacts per foot, respectively).

As noted, the vibratory roller should generally be operated at as high a frequency as possible. A roller capable of 2,000 to 2,400 vibrations per minute, for example, should be operated at the upper end of this frequency range. Using the highest possible frequency of vibration increases the number of impacts per meter (foot) at a given roller speed. For the vast majority of paving projects encountered, the properties of the HMA will not affect the selection of the frequency setting, nor will the thickness of the layer being compacted, as long as the thickness is greater than 25 mm (1 in.). Most vibratory rollers are designed so that the highest frequency can be used at the highest amplitude setting, although for some rollers, it is necessary to operate at a somewhat lower frequency when the roller is used at the highest amplitude setting. The optimum combination of vibratory amplitude, vibratory frequency, and roller speed will provide for the greatest gain in density for each pass of the roller and also the greatest smoothness for the pavement surface.

When using a vibratory roller, the operator is in control of more variables than when using the other types of rollers and thus should be well versed in the proper selection and interaction of those variables. Nominal amplitude and frequency can be varied in addition to the roller speed, the location of the roller with respect to the paver, and the number of passes made over each point on the pavement surface.

For double-drum vibratory rollers, the operator can vibrate either one or both drums. Thus the operator can control the compactive effort applied to the mix to a greater degree than is possible with either static steel wheel or pneumatic tire rollers. In most cases, it is most efficient to operate both drums of a double-drum vibratory roller in the vibratory mode. The only exception is when the roller is moving up or down a steep hill, in which case it may be necessary to run only one drum in the vibratory mode so the roller can maintain forward motion on the hill without sliding off the mat.

Some roller operators run in the vibratory mode while moving only in one direction behind the paver—usually toward the paver. When the roller is moving away from the paver, the operator switches off the vibration and runs in the static mode. For the vast majority of HMA mixes, there is no reason to operate the



roller in the static mode and reduce the compactive effort of this type of roller.

Construction of a roller test strip may be necessary to determine the optimum combination of roller speed and vibratory amplitude for a particular set of project conditions. If the required density cannot be achieved, the speed of the roller typically should be decreased and the nominal amplitude setting changed, unless the roller is already at the lowest amplitude setting.

Care should be taken when a vibratory roller is operated in the vibratory mode if underground utilities or drainage structures are directly beneath the pavement layer being compacted. If there is any chance that those utilities or structures might be damaged by the vibrations from the roller, the equipment should be operated in the static mode.

Combination Rollers

Combination rollers combine a vibratory roller drum on the front of the roller and a set of four rubber tires on the back. It has been suggested that these rollers are the best of both worlds since they combine two distinctly different types of compactive effort—vibratory force and pneumatic tire kneading action. In reality, however, this type of roller may produce a significant variation in density across the width of the lane being compacted.

The outside width of the rubber tires is generally equal to the width of the vibratory drum. The problem is, however, the gaps between the four rubber tires on the back of the roller. Unlike a standard pneumatic tire roller in which the tires on the back of the roller fit into the spaces left by the gaps between the front tires, the combination roller has no extra tires to fill in the gaps. It would be unrealistic to expect the roller operator to be able to overlap each succeeding pass of the roller by exactly one tire width to obtain uniform density across the entire lane width. This type of roller should therefore be used with caution when compacting HMA.

COMPACTION VARIABLES UNDER OPERATOR CONTROL

For all types of rollers, the primary compaction variables that can be controlled during the rolling process are roller speed, number of roller passes, rolling zone, and rolling pattern. For vibratory rollers, direction of travel and mode of operation are also under the operator's control. Each of these factors has an effect on the level of density achieved under the compactive effort applied to the mix.

Roller Speed

The more quickly a roller passes over a particular point in the new asphalt surface, the less time the weight of the roller “dwells” on that point. This in turn means that less compactive effort is applied to the mixture. As roller speed increases, the amount of density gain achieved with each roller pass decreases. The roller speed selected is dependent on a combination of factors: paver speed, layer thickness, and position of the equipment in the roller train.

Static steel wheel rollers can operate at speeds of 3 to 9 km/h (2 to 5 mph); pneumatic tire rollers typically run at 3 to 11 km/h (2 to 7 mph); and vibratory rollers can operate at speeds of 3 to 6 km/h (2 to 3½ mph). In the breakdown position, each type of roller should be operated at the lower end of its speed range. In the intermediate position, the speed of the roller can be increased somewhat, typically to the middle of the speed range. In the finish rolling position, the roller can be near the upper end of its speed range. Table 18-1 shows the range of roller speeds for three different types of rollers and three different operating positions. Rollers can move more quickly or more slowly than these speeds, but compactive effort is significantly improved at slower roller speeds.

Roller speed is also governed by the lateral displacement or tenderness of the asphalt mix. If the mixture moves excessively under the rollers, the speed of the compaction equipment should be reduced. In addition, roller speed affects the impact spacing for vibratory rollers. As discussed earlier, this spacing is important for controlling the amount of dynamic compaction energy applied to the mix, as well as for obtaining the proper surface smoothness.

Roller speed is usually established by the speed of the paver. Too often if the paver pulls away from the rollers, the rollers increase speed to catch up, which causes density in the asphalt mixture to be lower after applying the same number of roller passes. Paver speed should be selected to match the production rate of the asphalt plant, and that speed should be kept constant. The speed for each roller should then be determined based on the paver speed and the number of passes each roller must apply.

TABLE 18-1 Range of Roller Speeds (mph)

Type of Roller	Operating Position		
	Breakdown	Intermediate	Finish
Static steel wheel	2–3½	2½–4	3–5
Pneumatic	2–3½	2½–4	4–7
Vibratory	2–3	2½–3½	—

Note: 1 mph = 1.6 km/h.



Changing roller speed merely causes variations in density. “Slow and steady” is the key to proper compaction.

If the paver continually pulls ahead of the rollers, several courses of action can be taken. First, paver speed can be reduced to match both plant and roller production. Too often the paver is operated on a “hurry and wait” basis between truckloads. If plant production capacity necessitates continued higher paver speeds, additional rollers are required to achieve adequate density. Wider rollers can also be employed. For example, a vibratory roller 2.1 m (7 ft) wide can be used in place of a tandem roller 1.4 m (4½ ft) wide. The type of roller used can be changed as well; for example, a double-drum vibratory roller can be used instead of a single-drum vibratory or static steel wheel roller.

The breakdown roller and sometimes the intermediate roller may stop whenever the paver stops to wait for trucks, even though the rollers have not completed their roller patterns. When the next truck arrives and the paver again starts moving, the rollers also restart and finish compacting the mix. While the rollers have been idle, however, the mix on the roadway has cooled, and the density obtained in the cooled area will usually be less than that in the surrounding area. The roller should keep rolling until the established pattern and number of passes over each point have been completed.

Number of Roller Passes

To obtain the target air void content and uniform density in an asphalt mixture, each point in the pavement must be rolled a certain number of times. The number of required passes depends on many variables, including, most important, the type of compaction equipment. Three-wheel steel wheel rollers, tandem steel wheel rollers, pneumatic tire rollers, and single- or double-drum vibratory rollers all have different capabilities. At the same time, the capabilities of each type of roller depend on mat thickness, mix temperature, mix design properties (binder content, binder stiffness, and aggregate characteristics), and environmental conditions. Finally, the number of passes required depends on the position of the roller in the roller train.

One or more test strips should be constructed at the start of any major paving project to determine the minimum number of roller passes needed to achieve proper density levels. Different combinations of rollers and roller patterns should be tried to determine the optimum combination of compaction variables that will achieve the required density level as efficiently as possible. Rarely will the first trial combination of rollers, roller passes, and

rolling zones provide the most economical rolling sequence, unless the mix is one the contractor has used many times in the past.

Roller passes must be distributed uniformly over the width and length of the mat. All too often the center of the paver lane (the area between wheelpaths of a single-lane pavement) receives adequate roller coverage, whereas the edges of the mat receive considerably less compactive effort. As discussed further below in the section on rolling patterns, the uniformity of roller passes across the lane width is just as important as the number of passes.

Rolling Zone

Compaction must be achieved while the viscosity of the asphalt binder in the mix and the stiffness of the mix are low enough to allow for reorientation of the aggregate particles under the action of the rollers. In other words, the mat must still be hot enough for effective compaction. As discussed earlier, the rule of thumb commonly used is that the proper level of air voids should be obtained before the mix cools from its laydown temperature to 80°C (175°F).

To obtain the required density level most quickly, initial compaction should occur directly behind the laydown machine. If the asphalt mixture is stable enough, breakdown rolling can be carried out very close to the paver, while the mat temperature is still high. More density is obtained with one pass when the mix temperature is 120°C (250°F) than when it is 110°C (230°F). Thus the front of the rolling zone should be as close as possible to the back of the paver.

Sometimes when a tender mix is placed, initial rolling is delayed to avoid excessive shoving or checking of the mix by the rollers. Depending on mix characteristics, the required density can be achieved as long as the proper combination of rollers and compactive effort is applied. In some cases, however, the mix is so tender that rolling must be delayed to the point that the desired density level cannot be achieved. In this case, other solutions must be tried. When a tender mix is encountered, the cause of the tenderness must be determined and changes made in the mix production and paving operation to ensure adequate density. Compaction of tender mixes is discussed later in this section.

Rolling Pattern

Rollers should be operating most of the time. The question is whether they are operating correctly and effectively. Compaction is frequently not applied in the right



place. Numerous compaction studies have shown that the middle of the width of the paver pass typically receives much more compactive effort than the edges. Unfortunately, traffic uses the wheelpath areas near the edge of the pavement more often than the center of a lane.

For example, on an actual HMA paving project on an Interstate roadway, the mixture was placed in a trench section 3.7 m (12 ft) wide in two compacted lifts 75 mm (3 in.) thick. Initial or breakdown rolling on the first layer was accomplished using a vibratory roller 2.1 m (7 ft) wide. For the 3.7-m (12-ft) wide paver pass, two passes of the vibratory roller could cover the whole mat width, with about a 0.5-m (2-ft) overlap in the center. To gain adequate density, the operator of the breakdown roller had to keep the vibratory roller tight to each side of the trench. To cover the complete width of the lane, the operator would need only to make a roller pass on each side of the lane directly toward and then away from the paver without ever attempting to roll the center of the lane.

Instead, the roller operator made his first pass, 3.7 m (7 ft) wide, up the left-hand side of the mat. Upon reaching the back of the paver, the operator reversed direction, changed lateral direction slightly, and moved away from the paver by traveling down the center of the mat, with 0.8 m (2½ ft) of free area on each side of the roller. The third pass, again toward the paver, was along the right-hand edge of the driving lane. The fourth pass (away from the paver) was once more down the center, similar to the second pass. The final pass, to catch up to the paver, was a reversal of the fourth—up the center of the lane. The roller operator continued to repeat this five-pass pattern as the paver moved down the roadway.

Five passes of this breakdown roller were applied to the center of the 3.7-m (12-ft) wide area, an area not used by traffic. Only one pass was applied over each wheelpath and each outside edge of the lift. The roller was simply not being used properly. A future failure was built into this pavement structure because proper density was not obtained in the wheelpaths where it was needed. If the number of roller passes made on each edge of the lane being compacted is adequate to meet specifications, the density level in the center of the lane will always be more than enough to also meet specifications. Thus roller patterns should be designed to ensure proper, uniform compaction of the entire lane width.

For each roller used on a project, the mat width can be divided by the width of the compaction drums to determine the number of passes needed to cover each transverse point in the surface. A pass is defined as one trip of

the roller in one direction over any one spot. Multiple passes are needed to completely compact each point in the pavement surface over the transverse width of the lane being paved to the required level of density.

If the width of the roller drums (or tires) is 2.1 m (7 ft), only two passes are needed to cover a lane 3.7 m (12 ft) wide, including an overhang 150 mm (6 in.) wide over each edge of the pavement. Two passes of the 2.1-m (7-ft) wide roller overlap for a distance of about 300 mm (12 in.) in the center of the lane. If allowance is made for the fact that the roller operator may not always be able to maintain a 150-mm (6-in.) overhang on the edge of the pavement, the 300-mm (12-in.) wide overlap in the center of the lane is still sufficient to permit the entire pavement width to be compacted in two passes with a minimum 150-mm (6-in.) wide overlap needed between roller passes.

A roller that is 1.8 m (6 ft) wide cannot cover a complete 3.7-m (12-ft) lane width in only two passes. Two passes do not allow for any overhang at the edge of the lane or any overlap at the center. Thus three passes of a 1.8-m (6-ft) wide roller are necessary to compact the lane properly.

If the roller has drums or tires that are only 1.5 m (5 ft) wide, three passes of the roller are required, as with a roller with 1.8-m (6-ft) wide drums. If 150 mm (6 in.) is allowed for the edge-of-lane overhang, the amount of overlap between roller passes should be about 300 mm (12 in.). This overlap allows for ample steering variation by the roller operator and permits a 3.7-m (12-ft) lane width to be covered with three passes of the 1.5-m (5-ft) wide roller.

A roller with drums 1.4 m (4.5 ft) wide needs to make four passes across the width of a 3.7-m (12-ft) lane to completely cover the lane width. If this roller overhangs each edge of the pavement by 150 mm (6 in.) and only three passes across the lane width are made, the roller drums will overlap only 75 mm (3 in.) between the first and second passes and 75 mm (3 in.) between the second and third passes across the width. This amount of overlap between passes is not adequate to ensure uniform compaction. Thus four passes of the 1.4-m (4.5-ft) wide roller are necessary to properly compact a paving lane 3.7 m (12 ft) wide.

In a longitudinal direction, the rollers should not stop at the same transverse end point with each pass of the roller; the reversal points should be staggered to prevent shoving of the mix. A slight change in direction, or curl, may be beneficial at each reversal spot to further reduce the tendency of the mix to shove under the compactor and to eliminate the possibility of a bump at the point where



the roller reversal occurs. The roller should not sit and wait while parked on the hot mat. A long delay caused by a lack of haul trucks at the paver or filling of the compactor with water allows the roller to indent the new mat. It is generally impossible to roll out these marks once the mat has cooled. Thus when idle, all rollers should be parked on the shoulder or at an angle back on the cooler mat.

Many old compaction specifications require the compaction process to start at the low side of the pavement lane and proceed toward the high or upper side on subsequent passes of the roller. With modern compaction equipment and more stable asphalt mixes, this requirement is usually unnecessary, but it may be advisable for superelevations and lifts that are thick in relation to maximum particle size. In addition, some older specifications stated that the rollers had to overlap the width of the previous pass by at least half the width of the roller. This procedure leads to nonuniform compaction across the width of the pavement lane and a distinct lack of density on the outside edges of the lane. Modern standard practice is to have each roller overlap its own pass by a minimum of 150 mm (6 in.).

Determination of the rolling pattern is discussed in detail in the next section.

Direction of Travel and Mode of Operation for Vibratory Rollers

When using a single-drum vibratory roller, the compression drum should normally be operated toward the paver. This practice ensures that the maximum compactive effort of the compression drum is placed on the mat before the lesser compactive effort of the steering drum. In addition, this practice results in a denser layer to better resist displacement of the mix caused by the continual movement of the tiller drum during the steering action. A single-drum articulated-frame roller should also be operated with the driven drum toward the laydown machine, again to ensure that the maximum compactive effort is applied to the mix as quickly as possible.

When only one drum of a double-drum roller is operated in vibrating mode, the roller is often operated with the vibrating drum toward the laydown machine and the static drum trailing. A double-drum articulated-frame roller that has two driven drums (a vibratory tandem roller) operates the same in either direction. Thus for this type of roller, the direction of travel is not a consideration.

For harsh or stiff mixtures, breakdown rolling is normally accomplished with both drums of a double-drum

roller vibrating. Subsequent passes are made in the full vibratory mode as well. For mixtures with normal stability, breakdown rolling with a vibratory roller should also generally be accomplished in the full vibratory mode. For tender mixtures, as discussed below, initial breakdown rolling is sometimes accomplished in the static mode or in a combination mode. Subsequent passes are usually made in the combination mode if mixture displacement is not too great. When operating in the combination mode for tender mixtures, the trailing drum instead of the front drum is usually vibrated.

DETERMINATION OF ROLLING PATTERN

Different mixes may require considerably different levels of compactive effort and thus different compaction equipment and rolling procedures. Different types or combinations of rollers may be needed to achieve a required level of density for an asphalt mix containing large aggregate, for example, than for a mix made with smaller-size coarse aggregate.

As suggested earlier, the rolling pattern to be used on a particular paving project should be determined at the start of the project through the construction of one or more roller test strips. The strip(s) should be located at a convenient point where the pavement layer placed will remain as part of the final pavement structure. The mix should be representative of the material to be produced for the project; generally the plant should produce mix for a short period of time before the mix for the compaction test section is made so the mix will be as consistent as possible. The thickness of the layer compacted should be the same as that to be used for the rest of that layer, and the length of the test strip(s) should be at least 100 m (330 ft). The condition of the underlying layers should be representative of that on the rest of the project.

Due consideration should be given to the selection of the rollers to be used. The combination of rollers used on a previous project might not be the most cost-efficient or effective for the variables involved in the present job. Although vibratory rollers are generally used for breakdown rolling and pneumatic tire rollers for intermediate rolling, a greater degree of density with fewer roller passes may be obtained for some stiff mixes when a large pneumatic tire roller is used in the breakdown position, with the vibratory roller following in the intermediate position.

If a large pneumatic tire roller is used in the breakdown position, it is generally difficult to determine the degree of density obtained in the mat by using a nuclear gauge (discussed below) because of the uneven surface of the mat after the first several passes of the pneumatic tires. Nuclear readings must be taken after the mix has

been smoothed out with the intermediate steel wheel roller, either vibratory or static. A compaction test strip should be used to determine the most effective sequence of rollers to achieve the required degree of compaction, smoothness of the mat, and economical production.

Desired density levels are easier to obtain when the asphalt mix is hot. As discussed earlier, instead of using the rollers in the traditional roller train formation, consideration should be given to using two breakdown rollers, preferably of the same type, instead of a breakdown roller followed by an intermediate roller. This practice is particularly beneficial on thin layers of mix under unfavorable environmental conditions.

As noted earlier, two breakdown rollers can be operated side by side to expedite rolling. Depending on the width of each roller and the width of the lane, complete compaction across the paving width can normally be accomplished very quickly. If two different rollers are employed side by side in the breakdown position—a double-drum vibratory roller and a pneumatic tire roller, for example—it is important that each roller cover the whole width of the lane at some point during the compaction process. The two rollers will have to leapfrog each other for this to be accomplished, but with a little practice, the operation can be done easily. Again, the purpose of using two rollers, both running in the breakdown position, is to apply compactive effort to the mat before it cools.

Calculation of Rolling Pattern

To determine the optimum rolling pattern, the first calculation needed is the paver speed, which is based on the amount of mix to be produced by the plant, the width of the pavement lane, and the depth of the mix. Once the average paver speed is known, the maximum speed of the rollers should be selected. The speed selected for each roller will depend on the type of roller and its width, as well as its position in the rolling sequence. The selected speed will also depend on the ability of the roller to strike a balance among achieving density, smoothness, and a uniform pavement surface.

The second calculation involves comparing the width of the layer being placed and the width of the rollers to be used in order to determine the number of transverse roller lanes needed to cover the entire width of the pavement. The number of passes must be matched to the speed of the paver. (A pass is defined as a trip of the roller in one direction over any point on the pavement surface.) Given the paver speed, the roller speed, and the number of transverse lanes needed to obtain full-width coverage of the roadway surface, it is possible to determine the number of

passes each roller can make over each point in the pavement while still keeping up with the paver.

As discussed earlier, the number of roller passes needed over each point on the pavement surface depends on a large number of variables. One of the most important of these is the level of density required in the pavement layer. If a method specification is being used, the required number of passes can simply be counted. What is not known, however, is the degree of density (air void content) that will be obtained in the mix after the specified number of passes has been completed. If a certain percentage of laboratory density or theoretical maximum density is required, the higher is the required percentage, the more compactive effort will have to be applied to the pavement layer.

The type of breakdown roller used will also be very important. Under some conditions, one vibratory roller may be sufficient to achieve the required density, depending on the properties of the mix. In other cases, say, if the mix is tender and checking occurs, several passes of a pneumatic tire roller may be necessary to achieve the required density level. One or more passes of a static steel wheel roller are normally needed to remove roller marks, particularly if a pneumatic tire roller has been used. Because of the number of variables involved, it is impossible to generalize about the best combination of rolling and roller pattern to use in all cases.

Some contractors always use the same rollers in the same order making the same number of passes over the mix, regardless of the project variables. The same overall compactive effort is applied to a thin lift as to a thick lift, to a mix placed during hot summer months as to one placed during the cool spring or fall season, to a mix placed on top of a very strong foundation and to one placed on top of a weak base, and to a mix that is very stiff and one that is tender. As noted, however, different mixes and different project conditions require different compactive efforts to obtain the same degree of density.

Monitoring Density

The most common method of monitoring changes in density with roller passes is with a nuclear density gauge, shown in Figures 18-7 and 18-8. Density is estimated by transmitting gamma rays into the mix and measuring the amount of radiation reflected back to the device in a given amount of time. The data obtained can be related to the relative density of the layer. Nuclear gauge readings should be taken after each pass of each roller, and the rate of increase in density after each pass determined. When no appreciable increase in density is obtained with



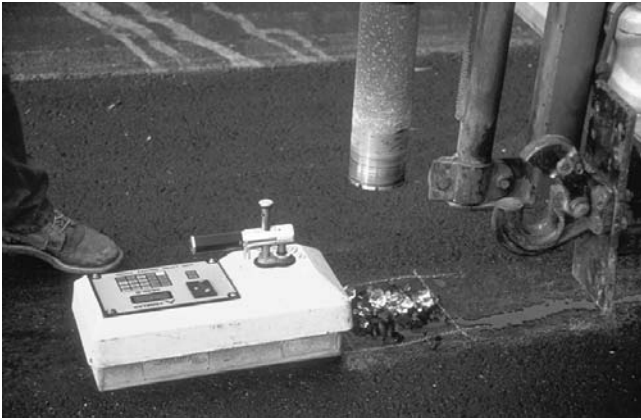

FIGURE 18-7 Nuclear gauge for monitoring density.

the application of additional roller passes, the maximum relative density for that mix has usually been obtained. As noted above, when a pneumatic tire roller is used in the compaction process, particularly in the breakdown mode, it is often very difficult to obtain an accurate density reading with a nuclear gauge. One or more passes with a steel wheel roller may be necessary before a valid nuclear gauge reading can be obtained.

The density value determined with a nuclear gauge is relative and is generally not the same as the density value obtained from cores cut from the pavement. A correlation must be made between the nuclear density reading and the actual unit weight of the pavement using cores that are cut from the test section after the rolling process has been completed. The actual unit weight must be compared with the maximum theoretical unit weight of the mix or the laboratory chemistry to determine whether the required density was achieved.

Because different nuclear gauges provide different readings, a single gauge should be used throughout the project. If more than one gauge is used, each should be

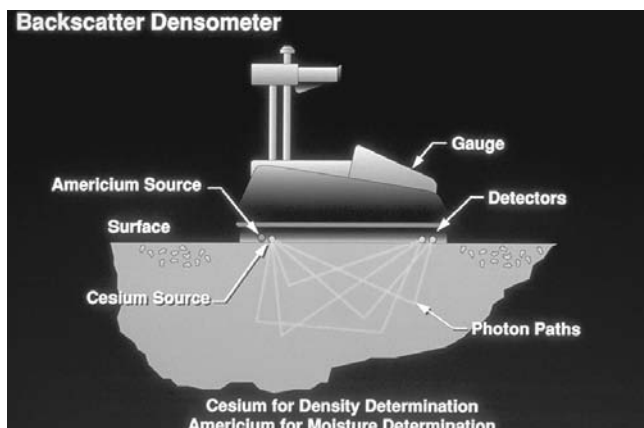

FIGURE 18-8 Schematic of nuclear gauge.

properly correlated to the core density so that the nuclear readings from each will accurately monitor the level of density being obtained in the mat. A new correlation relationship should be developed each time there is a significant change in the design of the HMA mix, the thickness of the layer being compacted, or the stiffness of the underlying pavement structure.

Usually a nuclear density gauge is correlated to unit weight by extracting cores from one of the test strips at the start of the project. A number of locations—10 locations are commonly used—are selected by random number. Multiple density readings are taken on top of each marked spot. Cores are then cut and tested to determine density. A graph is made, with the average nuclear density reading at each location plotted on one axis and the corresponding core density plotted on the other. A best-fit correlation line is drawn through the data points. Later, when the nuclear gauge is used to monitor density, the gauge reading is converted to a core density using the best-fit line.

To obtain a correlation, some operators calculate the average nuclear density reading and compare it with the average core density. In effect, they assume that there is a constant difference between the two methods. In fact, the difference is not constant but depends on the nuclear gauge reading. Therefore, a constant offset should not be used.

Compaction of Stiff Mixes

HMA mixtures that are properly designed will be reasonably stiff and stable and will require a considerable amount of compactive effort to attain the required degree of density. This type of mix will support the weight of the compaction equipment directly behind the paver. If the mix is placed at a temperature of 135°C (275°F) or higher, the rollers will typically be able to compact the mix properly before it cools to a temperature of 80°C (175°F).

Most often, three rollers are used—a breakdown roller, an intermediate roller, and a finish roller. For breakdown rolling, as discussed above, a vibratory steel wheel roller is most often used. For intermediate rolling, a pneumatic tire roller is generally employed, although sometimes a second vibratory roller is used. Finish rolling is normally done with a static steel wheel roller.

The breakdown and intermediate rollers should stay close to the paver. If the mix is stable, a bow wave will not occur in front of the vibratory roller drum, and the mix will not exhibit any cracking or checking. With a relatively stiff mix, the finish roller should also be close to the paver since there will be minimal marks from the breakdown and intermediate rollers to be removed.

For very stiff mixes or when a high degree of density is desired, a pneumatic tire roller should be used for breakdown rolling. For intermediate rolling, a vibratory steel wheel roller should follow directly behind the pneumatic tire roller, and the finish rolling should be done with a static steel wheel roller. Because of the internal stability and strength of the stiff mix, more compactive effort may be needed to obtain a given level of density (percent of theoretical maximum density), but the mix will not move under the compaction equipment during the rolling process.

Compaction of Tender Mixes

A tender mix is generally an internally unstable mix that will not properly support the weight of the compaction equipment when hot and will move under the applied compactive effort. The movement of the mix can take various forms. First, a bow wave may occur in front of the steel wheel on both a vibratory and static steel wheel roller as these rollers move longitudinally up and down the mat. Second, the mat may widen out when the rollers are used to compact the unsupported edge of the lane—mix placed 3.7 m (12 ft) wide, for example, may squeeze out to a width of 3.9 m (12½ ft) or more. Third, checking—short, transverse cracks that develop during the compaction process—may occur in the mix. Fourth, longitudinal humping up and checking of the mix may occur immediately outside of the edges of the steel wheel on the rollers.

Tenderness usually comes in one of two forms. Classical tenderness occurs when the breakdown roller is unable to approach the paver without the mixture beginning to move. Mid-temperature range tenderness occurs when the mixture behind the paver will support the roller but begins to move when the mixture starts to cool off.

When classical tenderness is encountered, roller operators do not approach the back of the paver. They trail some distance behind the paver waiting for the mixture to cool sufficiently until the roller is supported. The main approach to handling classical tenderness is to allow the mixture to cool. The best method is to redesign the mixture. If the mixture is used on a high-traffic route, the mix should be redesigned because classical tenderness is usually a sign of a non-rut-resistant mixture.

When mid-temperature range tenderness is encountered, the rollers can approach right up to the paver. The characteristics of mid-temperature range tenderness normally show up under breakdown rolling if the temperature of the mix at that point is above approximately 115°C (240°F). Whether the initial rolling is completed

by a vibratory or pneumatic tire roller, the mix is generally stable at higher temperatures. When the temperature of the mat drops below this level, however, the mix may become very unstable and tender. A bow wave may be seen in front of the steel wheel rollers, checking may occur in the surface of the mat, and the mix may hump up outside the edges of the steel drums on the rollers. Further, the mix may start to creep out transversely along any unsupported longitudinal edge of the mat.

The mix may continue to exhibit these tenderness characteristics as the temperature of the mat decreases to approximately 90°C (193°F) or lower. If rolling is attempted in this middle temperature range, the mix will decompact instead of compacting. It is not until the mix is quite cool, generally less than 90°C (193°F), that it becomes stiff enough to again support the weight of the compaction equipment. Finish rolling can often be accomplished at temperatures of 70°C (158°F) or less. Further, it is typically difficult for the finish roller to completely remove all of the roller marks left in the mix by the breakdown and intermediate rollers.

It should be noted, however, that the temperatures cited above—115°C (240°F) down to 90°C (193°F)—do not represent exact values. Initial tenderness of the mix may be evident at temperatures as high as 120°C (248°F) or as low as 110°C (230°F), depending on the characteristics of the mix. Further, the mix may continue to exhibit tenderness characteristics at temperatures as high as 95°C (203°F) or as low as 80°C (175°F).

Several different techniques can be used to compact mid-temperature tender mixes to the required level of density. First, tender mixes generally do not become tender until the mix temperature falls. This means a significant amount of compactive effort can be applied to the mix before it becomes tender and starts to move. If a vibratory roller is used as the breakdown roller, it should be kept as close to the paver as possible. The roller should make as many passes as possible over the mat, as quickly as possible, before the mix begins to move, check, or mark. Once the movement starts, additional passes of the breakdown roller should not be made. For most tender mixes, three to five passes of the breakdown roller can be made over each point in the mat surface before the movement or checking begins.

Second, if the mix is moving under the rollers in the middle temperature range, steel wheel rollers, either vibratory or static, should be kept off the mix until it cools to the point where it is again stable enough to support the weight of the compaction equipment. If rolling is continued when the mat is moving, even more movement will typically occur; the mix will become less stable with the



application of additional compactive effort. For some mixes, severe shoving of the mix may occur at the outside edge of a steel wheel roller drum with continued rolling.

In the middle temperature range at which decompaction of a tender mix will occur if steel wheel rolling is carried out, a pneumatic tire roller can be used. The rubber tires on this roller are less likely to shove or check the mix, and a bow wave will not develop. The pneumatic tire roller thus can be used to gain density in the middle temperature range.

The static steel wheel finish roller should be kept well back of the paver. This roller should move up toward the paver, compacting the mix and taking the roller marks out, until the temperature is reached at which the mix begins to move or check under the applied compactive effort. When the checking or bow wave starts, the finish roller should be backed off, and finish compaction should be carried out at lower temperatures.

If a pneumatic tire roller is not available for use once the mix has begun moving and checking, two double-drum vibratory rollers can be used together, in echelon formation or side by side, immediately behind the paver. The use of two rollers will permit more passes of the two breakdown rollers to be made over each point in the mat surface before the mix cools to the temperature at which movement and checking occur. Because each of the two rollers has less surface area to compact, it is often possible to make five to seven passes over each point in the mat before the decompaction process begins. For a tender mix, this is usually sufficient to obtain the required density level. Finish rolling is accomplished only to remove any roller marks, with extreme care taken to roll at a low enough temperature not to disturb the already compacted mix.

Tender Zone

Many contractors have observed a tender zone when using Superpave mixes, referred to earlier as mid-temperature tender mixes. The following comments about the tender zone were taken from National Asphalt Pavement Association *Special Report 180*:

On some Superpave designed mixtures, a tender zone has been identified in temperature ranges of approximately 200–240°F (93–115°C). The mixture can be satisfactorily compacted above this range or below this range, but the mixture is tender within the temperature range and cannot be adequately compacted. This is not true for all mixtures, but it has been observed for some Superpave designed mixtures. The mixture can be sat-

isfactorily rolled with rubber-tire rollers within this tender range but, as stated earlier, these rollers may have a pick-up problem when modifiers are used. Contact the roller manufacturers regarding procedures for eliminating asphalt pick-up on rubber-tire rollers.

When a mixture is being produced that is tender within the mid-temperature range, the preferred compaction method is to obtain density prior to cooling to the tender zone. This may require an additional breakdown roller or other changes in rolling techniques, but obtaining density prior to reaching the tender zone is preferable. In some cases, the mixture temperature may be increased slightly to provide more compaction time. However, excessive temperatures will magnify the problem. Another alternative is to use a vibratory steel-wheel breakdown roller above the tender zone, followed by a rubber-tire roller which can be operated in the tender zone. The finish roller should be used after the mixture has cooled below the tender zone. This second method may not be satisfactory if the rubber-tire roller picks up excessively.

Another possibility is to breakdown with a steel wheel roller above the tender zone then complete the rolling process after the HMA has cooled to below the tender zone. This has been used on a number of projects, but problems may occur due to differential cooling of the mixture and due to excessive aggregate breakdown when rolling in the vibratory mode after the mixture has cooled to below 200°F. Therefore, vibratory rolling should not be used below approximately 200°F.

If the tenderness problem yields a pavement with poor in-place density, or if the paving train length is excessively long due to the time required for the mixture to cool, adjustments to the mixture design must be made to eliminate, or at least reduce, the temperature tenderness zone. It is important that the paving crew working at the laydown site communicate with plant personnel.

SUMMARY

The following factors should be considered in monitoring the compaction process (the factors that should be considered when monitoring joint construction, as outlined in Section 17, apply here as well):

- To compact an asphalt layer properly, the rollers should be used efficiently while the mix is still above the minimum compaction temperature.
- The time available for compaction is related primarily to the thickness of the layer being placed. An increase in lift thickness can substantially increase the time available for the roller to densify the mix.

- An increase in the laydown temperature of the mix behind the paver can also increase the amount of time available for compaction. The feasibility of this approach, however, depends on the properties of the asphalt mix at that elevated temperature and the tenderness of the mix under the compaction equipment.

- A decrease in the speed of the rollers will increase the compactive effort applied to the mix.

- The breakdown and intermediate rollers should be operated as close to the paver as possible to obtain density before the mix cools to a minimum temperature of 80°C (175°F).

- If the mix cannot support the weight of the compaction equipment, the mix should be redesigned or the compaction procedures changed.

- The rolling pattern should be monitored to ensure that the compaction equipment is applying the same amount of compactive effort at all points transversely across the lane being paved.

- The speed of the compaction equipment will depend on the type of roller being used and its position in the compaction process. For static steel wheel and pneumatic tire rollers in the breakdown position, the maximum speed should not exceed 4.0 km/h (2½ mph). For a vibratory roller in the same position, the maximum speed should not exceed 6 km/h (3½ mph), depending on the frequency of vibrations.

- A vibratory roller should be operated at the maximum possible vibratory frequency in order to increase the number of impacts per foot. At least 30 to 40 impacts per meter (10 to 12 impacts per foot) are needed to obtain adequate density and layer smoothness.

- The nominal amplitude setting on the vibratory roller should be determined in accordance with the characteristics of the mix and the thickness of the layer being compacted. In general, vibratory rollers should be operated in the static mode when the compacted lift thickness is less than about 30 mm (1¼ in.). For greater lift thicknesses, the roller should normally be operated at low nominal amplitude. If density cannot be obtained, the nominal amplitude may be increased to determine whether additional compactive effort will be beneficial in achieving the required density level. In general, the nominal amplitude setting can be increased in proportion to the increase in compacted thickness of the layer.

- The optimum combination of rollers and rolling patterns for a past project may not be the same as that for a current project or even for a different type or layer of mix on the same project. One or more test sections should be constructed to determine the most efficient and effective combination of compaction equipment and rolling patterns to use for each combination of job variables.

- Two similar rollers run side by side (in echelon) will typically produce a greater level of density in the mix with the same number of roller passes than will result with the same two rollers operated end to end as breakdown and intermediate rollers.

- If the rollers cannot keep up with the speed of the paver, more rollers should be used, or the paver should be slowed down.

- A mid-temperature tender zone has been identified for some Superpave mixes. These mixes show tenderness in the approximate temperature range of 95°C to 115°C (200°F to 240°F). Close attention to rolling procedures can minimize this problem.



19 Mat Problems

Mat problems can be defined as defects that occur in the asphalt mixture during or soon after the laydown and compaction operations have been completed. These problems fall into two primary categories: (a) equipment-related problems and (b) mixture-related problems. In this section, major mat problems are reviewed and a description of each problem is presented, including its causes, solutions, and effects on long-term pavement performance.

Table 19-1 summarizes the problems reviewed. The first column lists the various problems, while the remaining columns enumerate possible causes for each. The checks indicate equipment-related causes, while the x's indicate mix-related causes, which should generally be corrected by changes in the mix design. Provided throughout the discussion of causes are cross-references to earlier sections where greater detail can be found. Note that because of the interaction of various equipment-related and mix-related causes, no attempt has been made to rank the various causes.

SURFACE WAVES

Description

An asphalt surface can have two types of waves: short and long. Short waves, also sometimes called ripples or auger shadows, are generally 0.3 to 0.9 m (1 to 3 ft) apart, with 0.45 to 0.60 m (1½ to 2 ft) being the most common separation. Long waves are considerably farther apart. The distance between them may correspond to the distance between truckloads of mix. Long waves may also be associated with the reversal points of the compaction equipment, particularly on thick-lift construction or when the HMA being placed is tender and moving longitudinally under the compaction equipment.

An additional type of defect in the pavement surface is a roughness or washboard effect caused by improper operation of a vibratory roller. The distance between these waves is generally very small, typically less than 75 or 100 mm (3 or 4 in.).

Causes

A major cause of short waves or ripples is a fluctuating head of material in front of the paver screed. The variation in the amount of mix being carried back to the augers by the slat conveyors and deposited in front of the screed causes the screed to rise and fall as the force pushing against it changes. Too much mix (at the top of the augers) and then too little mix (at the bottom of the augers) being carried in the auger chamber in front of the screed causes the wavy surface as the screed reacts to this variation in force. The fluctuating head of material causes the screed to rotate around its pivot point and “hunt” for an angle of attack. As the angle of attack of the screed changes, the thickness of the mat being placed also changes, and the smoothness of the new layer is directly affected. (See Section 15.)

Another cause of short waves is a screed that is in poor mechanical condition—one with excessive play in the screed control connections. Short waves can also be formed in the mat by improper mounting or sensitivity of the automatic grade control on the paver or by use of an inadequate grade reference device. Or the problem may be related to a mobile reference (floating beam) that is bouncing, or to the truck driver's holding the brakes while the truck is being pushed by the paver. (See Section 16.)

Short waves can also be related to the mix design, particularly with a mix that varies in stiffness as a result of changes in the mix temperature or composition. (See Section 3.) As the stiffness of the mix varies, the forces of the mix pushing on the screed vary as well, causing the screed to rise and fall and resulting in a mat with short waves. Finally, if the mix design is improper in aggregate gradation, asphalt content, mix temperature, or moisture content (the mix is tender), the rollers may shove and displace the mix during the compaction process. Normally, however, short waves are placed in the mat by the paver because of either its operation or changes in mix stiffness, rather than by the operation of the compaction equipment.

Long waves are caused by some of the same variables that result in short waves. Fluctuation in the amount of material in front of the screed and variation in mix stiff-

Solutions

Short waves (ripples) can be eliminated only by preventing their formation. The most important factor in preventing short waves is to keep the amount of mix (head of material) in front of the screed as consistent as possible. In addition, the stiffness of the mix, which is related to both its temperature and its composition, should be maintained as constant as possible. The amount of mix is controlled by properly setting the hopper flow gates and by keeping the slat conveyors and augers operating as much of the time as possible (close to 100 percent) while the machine is moving forward. Mix stiffness is controlled at the asphalt plant by keeping the mix temperature, aggregate gradation, and fluids content (asphalt content plus moisture content) as constant as possible. Any factors that cause either the volume or stiffness of the mix at the screed to change can cause short waves or ripples in the HMA mat.

Surface waves caused by problems with automatic grade controls can be detected by shutting off the grade controls and determining whether the waves continue to form. If the grade controls are at fault, the operation and maintenance manual supplied with those controls should be consulted to determine the proper corrective action. Sags in a stringline reference can be found by sighting down the line as the grade sensor wand passes along the string. Short or long waves caused by the mechanical condition or operation of the paver screed can usually be detected by careful observation of the paver during mix laydown. The long waves formed by incorrect operation of the haul truck or compaction equipment can also be detected easily by observing those operations.

If washboarding is caused by incorrect operation of a vibratory roller, a change should be made in one or more of the following: the vibratory amplitude setting, the vibratory frequency, and the speed of the roller.

Effects on Performance

Long-term pavement performance is affected by surface waves, both short and long, in two ways. First, the waves reduce the smoothness of the pavement, which lowers the pavement condition rating or the present serviceability index of the roadway. The structural performance of the pavement will be changed, however, only if the waves are severe enough to increase the dynamic or impact loading of the pavement under heavy truck traffic. Second, short waves and the factors that cause them can affect pavement density levels. A tender mix is generally more difficult to compact properly than is a stable mix; the re-

sult may be a decrease in density and a corresponding increase in air void content.

Washboarding is basically roughness built into the pavement surface during the compaction operation. Because it affects the degree of density obtained during the compaction process, this type of defect can significantly reduce the long-term durability of the pavement layer. In addition, washboarding contributes to a rough ride for the vehicles using the pavement.

TEARING (STREAKS)

Description

There are three general types of mat tearing, or pulling of the asphalt mix under the screed of the paver. The three types are defined by the location of the tear marks in the mat: (a) in the center of the lane, (b) on the outside edges, and (c) across the full lane width.

Causes

A gearbox streak can sometimes be seen in the surface of the mat directly behind the center of the main screed. This streak is typically 150 to 200 mm (6 to 8 in.) wide and is normally caused by a lack of asphalt mix being pushed under the auger gearbox located in front of the center of the screed. This lack of mix may be the result of improper flow gate settings—not enough mix being fed back to the screed. It is more likely to be caused, however, by missing, worn, or improperly set reverse augers or paddles on the augers (located adjacent to the gearbox) that are used to force mix underneath the gearbox. (See Section 15.)

A gearbox streak is often thought to be a type of segregation. It is not. The rough surface texture is the result of a lack of mix at that point in the pavement width—less mix passes under the screed at the auger gearbox than passes under the screed on either side of the gearbox. The rougher texture, or tearing, makes the surface appear more open or segregated. Gearbox streaks are more prevalent with harsher mixes—those containing larger-size aggregate, more crushed aggregate, or lesser amounts of asphalt.

A centerline streak can also be caused by improper setting of the crown on the main paver screed. The appearance of streaks behind the screed is caused primarily by an improper relationship between the crowns at the leading (front) and trailing (back) edges of the screed. A tearing or open texture about a meter (several feet) wide in the center of the mat may be caused by a



lack of lead crown in the screed. Conversely, a tearing or open texture along both outside edges of the asphalt mixture is normally caused by an excess of lead crown in the screed. For most mixes, the lead crown of the screed should be set slightly higher [approximately 3 mm ($\frac{1}{8}$ in.)] than the tail crown. A proper relationship between lead and tail crowns will result in a uniform texture of the mat across its full width. Edge streaks can be caused by improper flow gate settings or incorrect installation of the screed extensions. Partial-width tearing can also result from a cold screed plate if the screed has not been uniformly preheated before paving begins. (See Section 15.)

Full-width tearing of the mat can be attributed to a number of factors. One such factor is warped or worn screed plates. Another is the forward speed of the paver being too high for a particular mix. The use of a mixture with aggregate that is large compared with the mat thickness being laid can also be responsible for full-width tearing of the mat. A good rule of thumb for the relationship between the maximum aggregate size in the mix and the minimum compacted course thickness is that the depth of the compacted layer should be at least twice the largest coarse aggregate particle size or three times the nominal maximum aggregate size. Thus a mix containing a maximum aggregate size of 19.0 mm ($\frac{3}{4}$ in.) [nominal maximum aggregate size of 12.5 mm ($\frac{1}{2}$ in.)] should be placed at least 38 mm ($1\frac{1}{2}$ in.) thick. Lastly, cold mix temperatures, particularly when combined with a cold paver screed, can significantly affect the amount of tearing that occurs. (See Section 15.)

Solutions

A gearbox streak can usually be eliminated only by changing the amount of mix being forced under the screed at the auger gearbox. This change is made by installing reverse paddles or reverse augers on each side of the gearbox in order to push more mix under the gearbox. If the paver is already equipped with such devices, they should be checked to see whether they are worn and need to be replaced.

Constant center or outside edge mat tearing can usually be eliminated by adjusting the relationship between the lead and tail crowns on the paver screed. If this change does not solve the problem, the setting of the paver flow gates should be modified. Full-width tearing can be eliminated by increasing the mix temperature, preheating the screed properly before paving starts, replacing warped or worn screed plates, or increasing the lift thickness.

Effects on Performance

Tearing of the mat affects long-term pavement performance by causing changes in density in those areas where the tearing has occurred. Torn areas may appear segregated and are usually deficient in mix quantity. Pavement performance will be reduced in relation to the degree to which the tearing reduces the density and increases the air void content of the mat. In addition, the torn areas will be more susceptible to raveling and to the effects of moisture (stripping).

NONUNIFORM TEXTURE

Description

Nonuniform mat texture (see Figure 19-1) can be described as differences in the appearance of the mix, both transversely and longitudinally, as it is placed and compacted. Normally, minor differences in surface texture will be apparent because of differences in the alignment of the larger coarse aggregate particles as the mix passes out from beneath the paver screed. In addition, a mix with a higher fine aggregate (sand) content will have a more uniform surface texture than a mix containing a larger percentage of coarse aggregate.

Causes

Many factors related to the operation of the asphalt paver affect the uniformity of the surface texture of the mix. (See Section 15.) A variable amount of mix against the screed, caused by overloading the augers or running the hopper empty between truckloads, can cause variations in the amount of mix tucked under the screed and thus produce a nonuniform texture. Improper screed maintenance,



FIGURE 19-1 Nonuniform mat texture after compaction.



including worn or loose screed plates or screed extensions incorrectly installed, as well as low screed vibratory frequency, may alter the mat texture and cause nonuniformity. In addition, a low mix temperature, caused either by plant problems or by the paver sitting too long between truckloads of mix, can be a factor in uneven mat texture, especially if the paver screed is also cold. The tearing that results when the compacted layer thickness is less than twice the dimension of the largest aggregate particles (as discussed above) is still another contributing factor.

A soft or yielding base under the course being constructed may cause the new layer to have a variable surface texture (see Section 14). Moreover, segregation of the mix caused by poor mix design (Section 3) or improper handling of the mix during mixing (Section 3), loading (Section 11), hauling (Section 11), unloading (Section 13), or placing (Section 15) operations can contribute to a nonuniform surface texture. The variability of the texture will be affected as well by any factors that cause nonuniformity in the mix, such as deviations in aggregate gradation, asphalt content, or mix temperature (see Section 3).

Solutions

The solutions for nonuniform surface texture are as varied as the causes. Paver operation, particularly with regard to the need for a constant head of material in front of the screed, should be monitored closely. The paver and screed should both be well maintained and in good operating condition. The compacted thickness of the mat being placed should be designed so that it is at least twice the size of the largest coarse aggregate particles incorporated into the mix. Finally, a mix that is tender, variable in aggregate gradation or asphalt content, or easily segregated should be modified to increase its stiffness and improve its properties before it is produced at the plant and delivered to the paver for laydown.

Effects on Performance

Nonuniform surface texture is usually associated with nonuniform density. The same compactive effort will generally achieve lower density in areas in which the coarse aggregate has been dragged by the paver screed or segregation of the mix has occurred, as compared with areas having uniform surface texture. As density decreases and air void content increases, the durability and serviceability of the asphalt mat decrease markedly.

SCREED MARKS

Description

Screed marks are transverse indentations in the surface of the asphalt mat. They occur when the paver stops between truckloads of mix. Depending on the mixture being placed, some screed marks are barely noticeable, whereas others are very distinct and deep. Screed marks can also occur in the longitudinal direction when rigid or hydraulic extensions are used and the elevation of the extension is not the same as that of the main screed.

Causes

There are several causes of transverse screed marks. (See Section 15 for a discussion of screed operations.) One is excessive play in the mechanical connections on the screed. Such marks also result when the screed is set up incorrectly and rides heavily on its rear end. If the asphalt mix is tender and if the paver is equipped with a very heavy screed, such as hydraulic extensions with additional rigid extensions attached, the screed will tend to settle into the mix and leave marks. If any of these causes are involved, the screed marks will be visible each time the paver stops.

Another cause is the haul truck bumping into the paver when preparing to discharge the mix or the truck driver holding the brakes on the truck when the paver starts to push the truck. In these cases, the screed marks will appear only when the truck–paver interchange is improper.

Longitudinal screed marks are caused by improper setting of the screed extensions relative to the main screed. When extensions are used, their vertical position and angle of attack must be the same as those of the main screed. If rigid extensions are set at the wrong elevation, a longitudinal mark will occur at the point where the different screed sections are joined. If hydraulic extensions are used, two longitudinal marks may occur—one at the end of the main screed and one at the inside edge of the extension on each side of the machine.

Solutions

If the transverse screed marks are a result of the mechanical condition or improper setup of the paver screed, the screed should be repaired. If the marks are caused by the truck bumping into the paver, the laydown operation should be altered so that the paver picks up the haul truck instead of the truck backing into the paver. In addition, once the paver has established contact with the truck, the



truck driver should apply only enough pressure to the brakes to keep the truck in contact with the paver.

In some cases, particularly if the mix is very tender, screed marks can be eliminated by not stopping the paver between truckloads of mix. This can be accomplished by using a windrow elevator or material transfer vehicle to deliver mix to the paver hopper. If dump trucks are used to haul the mix, however, it is generally better to stop the paver between truckloads of material (stopping and restarting the paver as quickly as practical) instead of allowing the paver operator to run the paver hopper dry, reduce the head of mix in front of the paver screed, and increase the opportunity for truckload-to-truckload segregation.

To achieve uniform surface texture, the elevation and angle of attack of the screed extensions must be matched to those of the main screed. Longitudinal screed marks caused by improperly setting the elevation of the extensions can be eliminated by correcting the position of each extension relative to that of the main screed. Adjustments to both the vertical position and the angle of attack of the extensions may be needed. These adjustments should be made whenever hydraulic or rigid extensions are used.

Effects on Performance

Transverse screed marks generally are not detrimental to the durability of the mat. They may, however, affect the ride by creating a bump whenever the marks cannot be completely rolled out by the compaction equipment. In many cases, the screed marks have less of an effect on the performance of the mix than does the slowdown and startup of the paver when the operator attempts to keep it moving as the empty truck pulls away and the loaded truck backs into the hopper.

Longitudinal screed marks indicate that the level of the mix under the screed extensions is different from that under the main screed. If the screed marks are severe, differential compaction may occur across the mark or “joint,” with the compaction equipment initially riding on the higher mat. The marks can leave a ridge in the mix if they cannot be completely rolled out.

SCREED RESPONSIVENESS

Description

As the thickness control cranks on the screed are changed, the screed’s angle of attack increases or decreases. As the paver moves forward to place the mix, the screed moves

up or down to the new equilibrium point for the newly set mat thickness. When the screed fails to respond to changes in the setting of the thickness control cranks, the operator is unable to alter the depth of the layer being placed. The paver also loses its inherent ability, through the principle of the floating screed, to provide the self-leveling action needed to place a smooth asphalt mat.

Causes

An extremely high paver speed [more than 25 m (83 ft) per minute for thin lifts or more than 15 m (50 ft) per minute for layers more than 63 mm (2½ in.) thick] may cause a lack of responsiveness of the screed (see Section 15). The mechanical condition of the screed affects its ability to react. The screed riding on its lift cylinders or loose connections on the thickness control cranks will cause the screed to be unresponsive. If automatic grade controls are used (see Section 16), an incorrect sensor location will render the screed unable to react to input signals from the grade sensors.

If the maximum aggregate size used in the mix is too great compared with the depth of mix being placed, the screed will ride on or drag the largest aggregate pieces. As a result, the screed will be unable to change its angle and will thus be unresponsive to changes in the thickness control settings. Variations in mix temperature will also cause the screed to be unresponsive to changes in the angle of attack because the mix stiffness variations themselves will cause the screed to continually seek new equilibrium levels for the forces acting on it.

Solutions

The paver and screed must be in good operating condition. The sensor for automatic grade controls must not be located either at the tow points or behind the pivot points of the screed; rather, it should be located in the area between one-third and two-thirds of the length of the leveling arms. If the mix texture is uniform (indicating a proper relationship between course thickness and maximum aggregate size), the screed will be able to respond to changes in the thickness control settings.

Effects on Performance

An unresponsive screed causes a rough asphalt mat. The screed is unable to react to manual changes in the thickness settings. It also loses its ability to self-level on an existing pavement surface because it cannot reduce the thickness of mix placed over the high points in that surface and increase the thickness placed in the low areas.



Thus the rideability of the course being placed can be affected significantly if the paver screed is unresponsive.

SURFACE (AUGER) SHADOWS

Description

Surface (auger) shadows are dark areas that appear in the surface of an HMA mix. In most cases, the shadows cannot be seen until some time after the pavement has been used by traffic and some of the asphalt cement film has been worn off the exposed aggregate particles by the vehicle tires. Surface shadows are seen most easily when the sun is low on the horizon and the pavement is viewed when looking toward the sun. The shadows are also visible when the pavement surface is damp or when the surface is viewed from the shoulder of the roadway at night and vehicle headlights are shining on the surface.

In severe cases, surface shadows may be visible immediately behind the screed during the laydown operation. Even in this latter case, the shadows will disappear when the mix is being compacted by the rollers, only to be visible again later under the conditions described above. The shadows may be completely across the lane width being placed, or they may be only partially across the width. The extent of the shadows depends on how the paver is operated, particularly the portion of on to off time of the augers on each side of the machine.

Causes

Surface shadows are caused primarily by overloading of the augers on the paver (see Section 15). If the head of material in the auger chamber is large enough to “bury” the augers, the screed will react to the variable forces acting on it. The spacing between the shadows will normally correspond to the starting of the augers when operated in a stop–start manner. Whenever the amount of mix in front of the screed is at or above the top of the augers, the shadows will be formed and seen later in the pavement.

On most pavers it is possible to adjust the distance between the screed and the tractor unit. This is accomplished by unbolting connections on the leveling or tow arms of the paver and moving the tractor forward (or backward) while the screed remains stationary on the pavement surface. Depending on the make and model of the paver, there is typically a 100-mm (4-in.) length of slide for the screed connection. The severity of surface shadows may increase with the screed in the back position—when more mix is being carried in the auger chamber and the augers are being overloaded.

The shadows are thought to be the result of a slight increase in mix density caused by the restarting of the augers and the subsequent forcing of additional mix under the screed. There is no difference in surface texture associated with the location of the surface shadows; they can be seen only from an angle. Their intensity often increases when a tender mix is being laid.

Solutions

The HMA mixture carried in the auger chamber should be maintained at a level near the center of the auger shaft. This means the flow gates should be set so that the augers operate as close to 100 percent of the time as possible and stopping and starting of the augers is minimized. In no case should the top of the augers be completely covered with mix. Further, the location of the screed should be set as far forward as possible so that the amount of material in the auger chamber is reduced and the head of material in front of the screed is kept to a minimum. The screed should not be set in the back position unless a large-stone mix [one in which the maximum size of the aggregate is more than 37.5 mm (1½ in.)] is being placed.

Effect on Performance

Surface shadows are not necessarily detrimental to the performance of the mix, except for a minor effect on rideability. The difference in the density of the mix in areas with and between shadows is generally not great enough to be determined accurately. The main concern with surface shadows is the visual appearance of the mix to vehicle drivers.

POOR PRECOMPACTION

Description

A modern asphalt paver is normally equipped with a vibratory screed. This type of screed allows the mix to be partially compacted as it passes beneath the screed. Depending on such variables as forward paver speed, layer thickness, mix temperature, and ambient environmental conditions, the density of the asphalt mixture measured behind the screed before compaction is usually in the range of 70 to 80 percent of the theoretical maximum density (a voidless mix).

A few pavers are equipped with combination screeds, which have both tamper bars and vibrators. At slow paver speeds, the combination screed typically achieves greater compaction of the mix than is obtained with the vibratory screed alone. At paver speeds greater than 7.5 m (25 ft)



per minute, however, the increased compactive effort achieved with the tamper bar is typically lost, and the degree of compaction obtained is similar to that achieved with a simple vibratory screed.

Causes

The amount of precompaction achieved with the screed decreases as the paver speed increases (see Section 15). Precompaction generally increases slightly as the frequency of the screed vibration increases. Precompaction decreases significantly, however, if the screed is riding on the screed lift cylinders, thereby limiting the available compactive effort. The level of precompaction obtained is also limited if the mat is too thin for the maximum aggregate size used in the mix (less than twice the largest-size aggregate; see the earlier discussion of nonuniform texture), if the mix being placed is too cold, or if the base on which the new layer is being laid is soft and yielding.

Solutions

Decreasing the paver speed and increasing the frequency of vibration of the screed should, within limits, increase the level of precompaction achieved during the laydown operation. It is also possible on some pavers to increase the amplitude of the vibration in order to increase the impact force of the screed on the mix. Proper maintenance of the screed helps as well in obtaining a uniform compactive effort from the screed.

Effects on Performance

As long as the required density level is obtained using conventional rollers behind the paver, the level of precompaction accomplished by the screed will not affect the long-term performance of the HMA layer. It may be possible, however, to reduce the number of roller passes needed to meet the density and air void content criteria if the amount of precompaction obtained by the screed is higher. In addition, increased precompaction density can reduce the amount of differential compaction that occurs in low spots and rutted areas.

JOINT PROBLEMS

Description

Poor transverse joints are associated either with a bump at the joint, a dip in the pavement surface several meters (feet) beyond the joint, or both. Poor longitudinal joints (Figure 19-2) between passes of the paver are

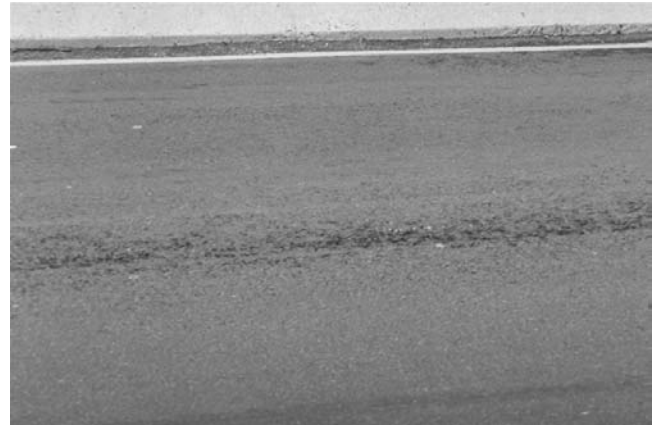

FIGURE 19-2 Poor longitudinal joint due to unsatisfactory workmanship.

usually characterized by a difference in elevation between the two lanes, by a raveling of the asphalt mix at the joint, or both. The area adjacent to the longitudinal joint is usually depressed below the level of the surrounding pavement surface.

Causes

Joint problems are caused by poor construction of the joint, inadequate compaction of mix placed along the joint, improper start-up procedures when paving resumes after a stoppage, or improper construction and removal of tapers.

Solutions

One key to a good transverse joint is to construct the joint at the end of the paving day at a location in the mat where the layer thickness is constant. (See Section 17 for a discussion of joint construction.) This means the compacted thickness of the mat at the end of the paver run is the same as that of the previously placed mat.

At the start of paving the following day, the paver screed should be placed on blocks on the cold side of the transverse joint. The thickness of the blocks should be related to the depth of the course being laid—approximately 5 mm ($\frac{1}{4}$ in.) thick for each 25 mm (1 in.) of compacted layer thickness. The front edge of the paver screed should then be placed directly over the vertical face of the joint. Once the paver pulls away from the joint, the right amount of mix should be in the right place, and only minimal raking, if any, normally needs to be done. The mix at the joint should then be compacted as quickly as possible.

For longitudinal joint construction, it is extremely important to compact the edge of the first lane properly. Doing so requires that the vibratory or static steel wheel



roller hang out over the unsupported edge of the mat by about 150 mm (6 in.). This practice provides the most compactive effort along the unconfined edge without causing undue lateral displacement of the mix along the edge of the pavement.

When placing the second (adjacent) pavement lane, the end plate on the paver screed should overlap the first lane by 25 to 40 mm (1 to 1½ in.). Minimal raking, if any, should be done on the mix placed over the first lane. The rollers—vibratory, pneumatic tire, and static steel wheel—should operate on the hot side of the joint and extend over the joint on the cold side by approximately 150 mm (6 in.). The same number of roller passes should be made over the longitudinal joint as over each point in the interior of the HMA mat.

Effects on Performance

A poor transverse joint will not affect pavement performance to any significant degree if proper density levels are obtained by the compaction equipment. A poor ride will usually be the only negative result. An improperly constructed longitudinal joint, however, can seriously decrease the serviceability of the pavement structure. A poorly placed and compacted joint will ravel and cause one side of the joint to be lower than the other. If the density level is too low, the whole pavement layer thickness at the longitudinal joint may wear away under the action of traffic. A poor joint will also be porous, allowing water to enter the underlying pavement courses.

CHECKING

Description

Checking can be defined as short transverse cracks, usually 25 to 75 mm (1 to 3 in.) in length and 25 to 75 mm (1 to 3 in.) apart, that occur in the surface of the HMA mat at some time during the compaction process (see Figures 19-3 and 19-4). The checks are not visible immediately behind the paver screed. Rarely does checking occur during the first or second pass of the compaction equipment over the mat. If checking is going to occur, it will normally take place after the mix has cooled to a temperature of less than 115°C (240°F) and additional passes of vibratory or static steel wheel rollers (or both) are made over the mat. Checking does not usually occur when the mix is compacted with a pneumatic tire roller.

Most HMA mixtures do not check at all during compaction, whereas others exhibit tender characteristics and check readily. As checking becomes severe, the cracks

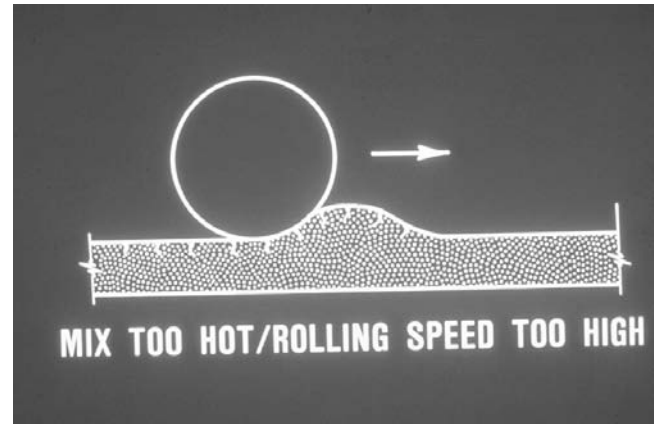

FIGURE 19-3 Roller checking during compaction.

become longer and are spaced closer together. The cracks do not extend completely through the depth of the course, but are only 10 to 13 mm ($\frac{3}{8}$ to $\frac{1}{2}$ in.) deep.

Causes

A mix that checks during compaction is a tender mix. The mix shoves or moves in front of the drums on either vibratory or static steel wheel rollers. Checks or cracks are formed when a bow wave occurs in front of the roller drums as the mix moves longitudinally before the roller reaches that location.

Checking may be caused by two primary factors: (a) excessive deflection of the pavement structure under the compaction equipment (see Section 14) and (b) one or more deficiencies in the asphalt mix design (see Section 3). A mix that checks is not internally stable enough—does not have enough internal strength at elevated temperatures—to support the weight of the compaction equipment during the rolling process.



FIGURE 19-4 Hairline cracks caused by roller checking.

When a yielding foundation is the cause of the checking problem, the underlying pavement on which the new HMA layer is being placed is weak and yields under the movement of the compaction equipment (see Section 14). The weight of the rollers causes the layers in the pavement structure to move, shove, and bend excessively, placing the new mix in tension at its surface. The check marks are then formed when the surface of the new HMA is pulled apart as the pavement structure deflects during the rolling operation. The checks should appear in the new mix surface only at locations where there is movement of the pavement structure under the compaction equipment. If the paver passes over a soft spot in the underlying structure, for example, the checking should occur only where the soft spot exists.

A more common cause of checking is one or more deficiencies in the HMA mixture: (a) an excess of fluids in the mix—too much asphalt cement or too much moisture in the mix, or both; (b) a hump in the sand gradation curve—too much midsize sand material [1.18-mm and 0.600-mm (No. 16 and No. 30) sieve size] and too little fine sand material [0.300-mm and 0.150-mm (No. 50 and No. 100) sieve size]; and (c) a lack of room in the aggregate gradation for the asphalt cement (low VMA).

An excess of fluids in the HMA mix makes the mix tender and allows it to be displaced easily under the applied compactive effort of the rollers. The mix will be tender if the binder content is too high for the gradation and characteristics of the aggregate used, particularly if the mix has a low VMA content. If the mix contains too much moisture because the aggregate was not completely dried when passing through the batch plant drier or drum mixer (parallel flow or counter flow), the excess moisture will act as asphalt cement at elevated temperatures and overlubricate the mix. The moisture remaining in the aggregate pores will prevent the binder material from entering those pores in the aggregate, in effect leaving more binder material between the aggregate particles instead of partly inside the aggregate.

If tenderness is due to an excess of asphalt cement in the mix, checking should occur in the mix on a regular, daily basis. If tenderness is due to an excess of moisture in the mix, checking should occur whenever the plant is not being operated properly. For example, checking may occur in the mat the day after a rain, but not the day before. If operations at the asphalt plant do not include removing the extra moisture in the aggregate resulting from the rainfall on the stockpiles, that moisture will add to the asphalt binder fluids and cause the mix to be tender.

A hump in the fine aggregate gradation curve—an excess of midsize sand in the mix—can also cause the

mix to be tender. In addition, mixes low in VMA content will generally be tender and move easily under the force of a vibratory or static steel wheel roller. Further, the various characteristics of the aggregate particles, such as surface texture, angularity, crushed faces, and amount of dust coating, can play a major role in the amount of checking that occurs during compaction. Mixes that are deficient in fine aggregate gradation or lack adequate VMA content will normally check continuously, not periodically. If the sand gradation is variable, however, checking may occur only when the sand gradation is improper.

The above mix deficiencies are compounded, and the amount of checking that occurs may be increased, when the mix temperature is too high for the particular asphalt cement grade being used in the mix. As the mix temperature increases, the viscosity of the asphalt cement decreases, causing the mixture to be more tender. An additional factor that can affect the amount of checking is the temperature susceptibility of the asphalt cement itself: the greater the degree of temperature susceptibility of the binder material, the more checking may occur in the HMA mix.

Occasionally, checking can be caused by temperature differentials within a layer of HMA mix (heat checking). On a cool day and under windy conditions, the temperature of the mix that is in contact with the existing pavement surface may decrease quickly. The top surface of the mix will also cool quickly. The temperature of the mix in the middle of the layer, however, will remain high. This temperature differential can cause the mix to check under the compactive effort of the rollers.

There are also a number of secondary causes of checking. One is a mix whose temperature is too high: the mix was overheated in the plant. In addition, improper rolling techniques can cause checking—rolling too fast, stopping too quickly, making sharp turns on the hot mat, or making an excessive number of passes with the finish roller or finish rolling when the mat is still at too high a temperature (see Section 18). Finally, checking may be increased by a poor bond between the new mat and the underlying surface because of a dirty surface or the lack of a tack coat.

Solutions

If checking is caused by the presence of a yielding foundation underneath the new HMA layer, the solution is to repair and properly prepare the existing pavement structure before the new HMA layer is placed. Soft spots should be removed and replaced. All areas of excessive deflection should be removed and replaced or



stabilized. Uniform support is needed in the underlying pavement structure if the new pavement layers are to perform adequately.

If checking is caused by a deficiency in the mix design—an excess of fluids in the mix or a problem with the gradation of the fine aggregate or the VMA content of the mix—the long-term solution is to change the mix properties. Those changes must be made at the asphalt plant and cannot be made at the paving site. If the mix contains an excess of fluids—either asphalt cement or moisture—the binder content should be reduced or the aggregate properly dried to remove all of the moisture. In some cases, the production rate of the plant will have to be reduced for the moisture to be completely removed from the aggregate. In other cases, plant operating conditions may need to be changed (e.g., flights, drum angle).

If checking is caused by the gradation of the fine aggregate incorporated into the mix, the gradation should be changed. It may be necessary to increase or decrease the amount of fine aggregate used, add a small amount of fine aggregate with a different gradation, increase the angularity of the fine aggregate, or use a completely different material from a different source. If checking is caused by a lack of VMA in the HMA mix, changes need to be made to increase the VMA.

Checking is often thought to result from the mix being too hot. This is only partially correct; the mix is too hot at some temperatures to support the weight of the compaction equipment because the mix lacks internal strength and stability. If the mix were properly designed, it would not be too hot to be compacted at any temperature below about 150°C (300°F). Most checking occurs when the mix temperature is decreasing from about 115°C (240°F) down to about 90°C (190°F); rarely does checking occur when the mix temperature is above approximately 115°C (240°F) or below approximately 90°C (190°F).

In the short term, changes in both the rolling zone and the type of rollers used to densify the mix can be made to reduce the amount of checking that occurs. If the mix is tender because of excess fluids, a problem with the fine aggregate gradation, or lack of VMA, it may be possible to densify the mix properly at an elevated temperature without causing the checking.

A mix that checks is tender, but this mix can usually be compacted satisfactorily at high temperatures—above 120°C (250°F). The required level of density can generally be obtained if enough roller passes can be applied to the mix before it cools to the point at which the checking begins. This can be done by using two breakdown rollers instead of one—using two rollers operating in echelon (side by side) instead of using a breakdown roller fol-

lowed by an intermediate roller. The two breakdown rollers each apply their compactive effort to one side of the newly placed lane. Many passes are made over each point in the pavement surface before the mix begins to check. Once checking starts, the rolling process is temporarily suspended.

If compaction operations are attempted when the mix is moving, shoving, and checking under the action of vibratory or static steel wheel rollers, the mix will decompact rather than compact. Rolling should not be carried out with steel wheel rollers when the mix is tender and checking. Most tender mixes will remain tender until the surface of the mix cools to a temperature of approximately 90°C (190°F). At this temperature, the mix has cooled sufficiently so that the viscosity of the asphalt binder has increased to the point where the mix can again support the weight of the compaction equipment. Static steel wheel rollers can then be used to achieve the final density in the mix and remove any roller marks in the pavement surface.

When a tender mix is in the middle temperature range, between about 115°C (240°F) and 90°C (190°F), rolling should not be attempted, as discussed above, with either vibratory or static steel wheel rollers. A pneumatic tire roller, however, can be used in this temperature zone since the rubber tires on this roller will typically not shove the mix and a bow wave will not form in front of the tires. The tender mix will densify, instead of check, under the compactive effort of the pneumatic tire roller. Finish rolling using a static steel wheel roller can be completed once the mix has cooled to a temperature below about 90°C (190°F).

In most cases when checking occurs in the mix, the roller operators tend to back off the mix and allow it to cool. This is the wrong approach to the problem. Delaying the compaction permits the mix to cool and stiffen but most often does not then allow enough time for the mix to achieve the required level of density. With a tender mix, it may not be possible to accomplish both objectives (no checking and adequate density) at the same time if the mix is allowed to cool before rolling operations are started. It is much better to compact the mix as much as possible before checking starts, stay off the mix in the middle temperature zone when checking is most likely to occur, and then finish roll the mix once it has cooled enough to support the weight of the final roller.

If the mix delivered to the paver is too hot—above 165°C (325°F)—it should be allowed to cool after lay-down before the compaction process is started. Improper rolling techniques should be corrected. The surface of the underlying pavement should be clean and properly tack coated before placement of the new mix begins.



None of the solutions to the checking problem will work in all cases. Each mix will have its own compaction characteristics. For some extremely tender mixes, checking may occur at a wider range of temperatures, from as high as 130°C (270°F) down to as low as 75°C (170°F). As noted, mixes that lack internal stability will generally check under steel wheel rollers (operated in either the vibratory or static mode), and thus these mixes should be redesigned.

Effects on Performance

Although checks extend only a short distance down from the surface, they are highly detrimental to long-term performance because the tender mix characteristics affect the level of density obtained. If the rollers are kept back from the paver in an attempt to decrease the amount of checking that occurs, the level of density obtained by the compaction equipment will normally be reduced significantly. Thus the air void content of the HMA mat will increase. A mix that contains checks will therefore lack density and have a greatly reduced pavement life under traffic.

SHOVING AND RUTTING

Description

Shoving of an HMA layer is displacement of the mixture in a longitudinal direction. Such displacement may take place during the compaction operation or later under traffic. In most cases, shoving during construction is accompanied by a large bow wave in front of the breakdown roller, particularly if that roller is a vibratory or static steel wheel machine. Shoving may also occur in conjunction with mix checking if the mix is tender enough as a result of faulty aggregate gradation or excess fluids (asphalt binder or moisture) content. Finally, mat or mix shoving can occur at the reversal point of the rollers, especially at the location closest to the paver. A pavement layer that has shoved under the action of traffic is shown in Figure 19-5.

Rutting, illustrated in Figure 19-6, shows displacement of the mixture in both vertical and transverse directions. Rutting occurs when heavy traffic passes over an unstable mix. In a few cases, the rutting is purely vertical (consolidation rutting). In this situation, the mix was not adequately compacted at the time of construction, and the traffic loads are essentially finishing the compaction process. The most common form of rutting is transverse distortion—the mix distorts or shoves



FIGURE 19-5 Shoving due to unsatisfactory mix.

transversely as a result of lateral flow of the mix under applied traffic loads.

Causes

Shoving and rutting are due primarily to an unstable HMA mixture (see Section 3). This instability can be caused by the same variables that are responsible for checking—an excess of fluids (asphalt binder or moisture) in the mix, a hump in the fine aggregate grading curve, or the properties of the aggregate and the asphalt cement. A mix that has a high Marshall or Hveem stability may still distort longitudinally under the compaction equipment and later both longitudinally and transversely under traffic. Shoving and rutting can be highly prevalent when a sand mix is placed in a thick layer [more than 40 mm (1½ in.)] at a high temperature [more than 140°C (280°F)]. Further, thicker lifts in pro-



FIGURE 19-6 Rutting of unstable asphalt mixture.



portion to the maximum-size aggregate used in the mix will tend to shove more than thinner lifts with the same aggregate size and grading.

Improper roller operation, particularly sudden reversal of the roller, can also contribute to the shoving of the mix during construction (see Section 18). If a vibratory roller is run at too great a speed and the impact spacing is too far apart, the mat may develop a washboard effect, where the peak-to-peak distance is equivalent to the impact spacing. Washboarding or shoving is more likely to occur at normal frequencies but at high speeds where the impact force is greater. If a pneumatic tire roller with high tire pressure is used for breakdown compaction, a tender mix may shove laterally under the tires. Shoving can occur under any roller that is operated improperly.

Another possible cause of shoving is an excess of tack coat material that may be pulled into the mix. In a similar manner, excess asphalt from a bleeding underlying surface or from joint filler material can be pulled into the mix and increase its fluidity and tenderness. Shoving may occur as well when the underlying surface is dusty or dirty—a slippage failure. (See Section 14.)

Solutions

The solution to a mix that shoves under the compaction equipment is to increase its internal stability. This can be accomplished by reducing the fluids content (asphalt or moisture, or both) of the mix, but only after determining the effect of a change in asphalt binder content on the mechanical properties of the mix. The internal friction can be increased by lowering the mix temperature. Alternatively, the internal friction among the aggregate particles can be increased by changing the aggregate gradation or increasing the amount of angular (crushed) particles in the mix.

The compaction process for a tender mix should be changed, as discussed above under checking, to obtain sufficient density at the time of construction. An increase in the density achieved during the construction process will generally reduce the amount of shoving and rutting that may occur later under applied traffic. Sand mixes, because of their inherent tender nature, should be placed in several thin layers instead of one thick layer when used as base or binder courses.

The compaction equipment should be operated properly so as to reduce the opportunity to displace the mix during the rolling operation. Further, if the underlying pavement surface is dirty, it should be cleaned and a proper tack coat applied.

Effects on Performance

Mats that tend to shove under the compaction equipment are basically unstable. These mixtures will usually continue to distort under traffic, both longitudinally and laterally. Shoving of the HMA mixture during construction is a strong indication that the pavement will rut later and not perform properly under traffic.

BLEEDING AND FAT SPOTS

Description

Bleeding of an asphalt mixture (see Figure 19-7) occurs when the asphalt cement flows to the top of the mix surface under the action of traffic loading. Bleeding is often seen as two flushed longitudinal streaks in the wheelpaths of the roadway. Fat spots in an asphalt mixture (Figure 19-8) are isolated areas where asphalt cement has come to the surface of the mix during the lay-down and compaction operation or later under traffic. These spots can occur erratically and irregularly, or they may be numerous and in a fairly regular pattern.

Causes

Fat spots are caused primarily by excessive moisture in the mix (see Section 3). The problem is more common with mixtures that contain a high percentage of fine aggregate (oversanded mixes) and those that contain aggregates with a high porosity. If all the moisture in the coarse and fine aggregate is not removed during the drying and mixing operation at the asphalt plant, the moisture vapor will force asphalt cement to the surface of the mix behind the paver as the moisture escapes from the mix and evaporates. Fat spots occur more frequently when aggregate stockpiles are wet or when the moisture



FIGURE 19-7 Asphalt bleeding in travel lane.



FIGURE 19-8 Fat spot caused by localized excess asphalt.

content varies in different portions of the stockpiles. Fat spots sometimes occur in areas where petroleum products, such as oil and diesel fuel, were spilled onto the pavement surface prior to overlay (see Figure 19-9; see also Section 14) or have contaminated the mix. In addition, fat spots can be associated with segregated areas in the mix. If the mix deposited on the roadway by the paver is segregated, areas in which excess asphalt cement is present in the mix can result in free binder material on the top of the layer being placed.

The causes of bleeding normally fall into two categories. The first is an excess of fluids in the asphalt mixture—either asphalt cement or moisture or both. Under traffic, the extra moisture and asphalt cement will be pulled to the surface by the passage of vehicle tires. This bleeding phenomenon usually occurs on new mix and during hot weather when the viscosity of the asphalt cement is at its lowest level. Typically the bleeding occurs shortly after traffic is allowed to travel over the fresh mix—while there is still some moisture in the mix



FIGURE 19-9 Fat spot caused by fuel oil spill prior to overlay construction.

and while the viscosity of the asphalt cement binder is still relatively low.

Bleeding may also be associated with a lack of adequate space in the mix for the asphalt cement. If the VMA content and air void content of the mix do not provide enough room for the binder material, bleeding can occur as the mix is densified by traffic, both shortly after construction and later. The traffic compaction process will decrease the air void content of the mix and may, in turn, squeeze some of the asphalt cement out of the mix. The “extra” asphalt will appear as a longitudinal streak or fat spot throughout the length of each wheelpath.

One additional possible cause of bleeding is the condition of the pavement layer on which the new mix is placed. If the underlying layer has excess asphalt on its surface or excess crack seal material in the cracks and joints, some of this material may be drawn up through a thin new mix layer. Further, if too much tack coat is applied to the original pavement layer, the excess material may be pulled up through a thin overlay and contribute to the bleeding problem.

Solutions

Variations in the asphalt mix temperature behind the paver indicate that the moisture content of the mix may also be variable. Where moisture has evaporated, the temperature is lower. This latter phenomenon can contribute to both the bleeding of the mix later under traffic and the generation of fat spots in the mix during construction. It is important, therefore, that the aggregate used in the mix be relatively dry and that the moisture content of the mix upon discharge from the asphalt plant be as low as possible, but not more than 0.5 percent. Extra care needs to be taken in drying when producing mixtures that incorporate highly absorptive aggregate.

Bleeding problems caused by excess asphalt cement in the mix can most easily be solved by reducing the asphalt content, consistent with other properties of the mix, such as air voids, VMA, and strength or stability. Bleeding problems that occur in conjunction with pavement rutting usually can be solved, however, only by a complete redesign of the asphalt mixture, with emphasis on proper air void content and VMA criteria.

Effects on Performance

Occasional fat spots in the mix should not affect the ultimate durability of the pavement to a significant degree. A large number of fat spots or bleeding in the wheelpaths does affect pavement performance, however, because of variable asphalt and air void content in different parts of



the mix. In addition, other mix problems, such as shoving, rutting, and loss of skid resistance, may occur in a mix that contains many fat areas or bleeding in the wheel-paths. The design of the asphalt mixture, the operation of the asphalt plant (more complete removal of moisture), or both should be checked to ensure that the mix produced will provide adequate pavement performance under vehicular loading.

ROLLER MARKS

Description

During the compaction process—whether vibratory static steel wheel or pneumatic tire rollers are used—longitudinal creases or marks are left in the surface of the mix. Once the mix has cooled to a temperature range of 70°C to 60°C (160°F to 140°F), these marks are typically removed by the finish roller. Roller marks are indentations that remain in the surface of the mix after rolling has been completed (see Figure 19-10).

Roller marks may also exist in the asphalt surface when any roller is parked on the hot mat for a period of time or when a vibratory roller is vibrated in place. Particularly when used in the breakdown position, pneumatic tire rollers can leave visible longitudinal marks that can still be seen after the finish rolling has been completed. Vibratory washboard marks may be visible if that roller is operated at an improper vibratory amplitude, frequency setting, or speed, as shown in Figure 19-11.

Causes

Roller marks can be an indication that the proper number of roller passes has not been made over the mix (see

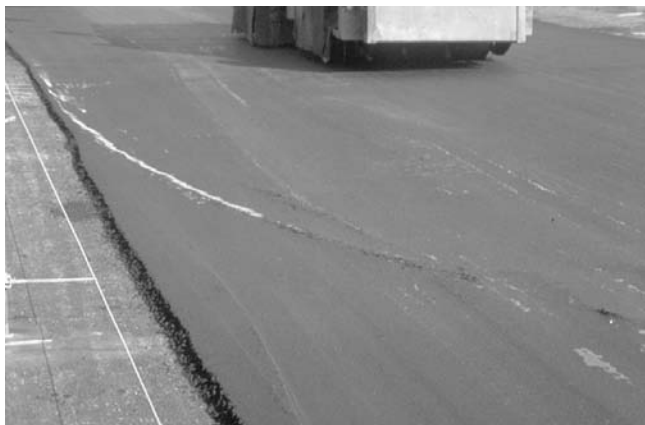

FIGURE 19-10 Roller marks in freshly laid asphalt pavement.



FIGURE 19-11 Washboard marks left by improperly operated vibratory roller.

Section 18). If the compaction process is halted before the required amount of rolling has been completed or if the mix cools before the compaction process has been finished, the longitudinal marks or creases made by the rolling process will remain in the surface of the mix.

Roller marks left in an asphalt layer also may indicate a tender mix (see Section 3). The roller operator will normally be unable to remove all the marks left by the compaction equipment if the mix is tender or unstable. A tender mix usually will not support the weight of the finish roller until it has cooled to the point at which the viscosity of the asphalt cement has increased enough to stiffen the mix. By the time the mix has decreased in temperature to this point, however, the required level of density can generally no longer be achieved because the mix has lost its workability. For this reason, the roller marks or indentations left during the breakdown and intermediate roller passes usually cannot be removed during the finish rolling process. All of the asphalt cement, aggregate, and mix properties that contribute to the formation of a tender mix, as discussed above, also contribute to the inability of the finish roller to eliminate roller marks.

Solutions

If the cause of roller marks is inadequate compaction, additional roller passes should be made with the breakdown, intermediate, or finish rollers to properly densify the mix. The solutions for inadequate compaction related to mix design deficiencies all involve changes to the mix design and to the production of the mix at the asphalt plant. Asphalt cement quality and content, aggregate properties and characteristics, and mix temperature all play a significant role in the workability and stability of the asphalt material under the compaction equipment.

Roller marks normally cannot be removed from a tender mix until the mix temperature has decreased to a relatively low level—usually less than 70°C (160°F).

Sometimes it is possible, depending on environmental conditions and the properties of the mix, to remove roller marks left in the mix by using a pneumatic tire roller. If the surface of the mix is hot enough [60°C (140°F) or more], several passes with a pneumatic tire roller can be made to “iron out” the surface of the pavement. Finally, roughness or washboarding caused by incorrect operation of a vibratory roller should be eliminated by using proper operating techniques with this equipment.

Effects on Performance

Roller marks are normally an indication that the proper level of compaction has not been achieved. In terms of ultimate pavement durability, the air void content or density of the mix is the single most important characteristic that governs the performance of the asphalt mixture under traffic. If the air void content of a dense-graded mix is high—the density is too low—the pavement generally will not perform well under traffic.

SEGREGATION

Description

Segregation is the separation of the coarse aggregate from the rest of the mix in an HMA mix. Segregation results from mishandling the mix at any of several points during the mix production, hauling, and placing operations. When segregation occurs in a paving project, it is likely to lead to forms of long-term pavement distress such as wavy surface and poor compaction. It can occur as the mix is delivered from the asphalt plant to a surge silo, as the mix is deposited into the haul truck from the silo, and as the mix is discharged from the truck into the paver hopper. Segregation that is evident behind the paver screed generally takes one of three forms: it may consist of areas of coarse aggregate (rock pockets) that occur randomly across the length and width of the layer; it may occur at a transverse location across the width of the lane (truckload-to-truckload segregation); or it may occur along one side of the paver width (longitudinal or side-to-side segregation).

Causes

The cause of segregation behind the paver is directly related to the type of segregation involved. Rock pockets are generally caused by improper handling of the ag-

gregate in the stockpiles, cold-feed bins, or storage of the HMA at the asphalt plant (see Section 6). They seldom occur when a batch plant is used to produce the mix (without a silo), because the screens and hot bins in the plant recombine any segregated material before it is fed into the pugmill (see Section 8). Further, the pugmill blends all the aggregates together and normally eliminates any segregation that might have occurred previously. If a silo is used on a batch plant, however, the mix may segregate for all the same reasons that affect a mix produced in a drum-mix plant and passed through a surge or storage silo (see Section 11).

Rock pockets and random segregation are occasionally found on the roadway when the mix was manufactured in a drum-mix plant (see Sections 9 and 10). If the loader operator places a bucketful of segregated aggregate in a cold-feed bin, that material can pass through the drum, surge silo, haul truck, and paver without being completely mixed in with the other aggregate. This is because the drum-mix plant operates on a continuous-flow instead of a batch basis. If the aggregate in the cold-feed bins is segregated, that material will show up on the roadway in a random pattern both transversely and longitudinally.

Some mixes are more prone to segregation than others (see Section 3). Asphalt mixes that have large maximum-size coarse aggregate [25 mm (1 in.) or greater], have low asphalt cement content, or are gap-graded will tend to segregate more readily when handled than a dense-graded mix containing optimum asphalt content and a smaller maximum-size coarse aggregate.

Segregation that occurs on one side of the paver (side-to-side segregation) when a batch plant without a silo is used to produce the mix is normally caused by improper loading of the haul truck from the pugmill (see Section 11). If the mix is not loaded in the center of the width of the truck bed, the coarse aggregate particles in the mix may roll to one side of the truck and accumulate along that side. When the mix is delivered to the paver hopper, the segregated mix will be placed on the roadway along the same side, and the segregation will appear as a longitudinal streak on one side of the paver only.

Segregation that occurs on one side of the paver when a batch plant with a silo or a drum-mix plant is used to produce the mix is typically caused by improper loading of the mix into the surge silo (see Section 11). As the mix is deposited into the silo from the conveying device (slat conveyors, belt conveyor, or bucket elevator), the mix is thrown to one side of the silo, and the coarse aggregate particles are separated from the finer



materials. When the silo is emptied, the coarse aggregate is deposited on only one side of the truck. This segregated material then passes through the paver and is seen on one side of the mix after laydown. Further, as with a batch plant, if the truck is not loaded in the center of its width under the silo, rolling of the coarse aggregate particles may occur, and longitudinal segregation will then appear on one side of the new mat.

Truckload-to-truckload segregation has many potential causes (see Section 11). The most common is improper loading of the haul truck from the silo. If mix is placed in the truck bed in one drop from the silo, the coarse aggregate particles in the mix have a tendency to run to both the front of the bed and the back tailgate. This rolling of the coarse aggregate is exacerbated if the plant operator continuously opens and closes the silo gates near the end of the truck-loading procedure to ensure that the full weight of mix is placed on the truck.

Some believe that truckload-to-truckload segregation can also be caused by improper discharge of the mix into the silo. Mix that is dribbled into the silo from the conveying device is said to be susceptible to segregation inside the silo. Even if this occurs, the mix that is segregated in the silo will appear only as random rock pockets in the layer behind the paver, instead of in a systematic manner between truckloads of mix delivered to the paver. Thus it is doubtful that any segregation of the mix that occurs during the continuous process of loading the silo will appear on the roadway in a discontinuous pattern—only at the beginning or the end, or both, of a truckload of mix.

Temperature segregation of the mix has also been shown to be a problem. The mix cools more quickly near the edge, bottom, and top of the truck during haul. This cooler material is not always remixed with the hotter HMA, leading to temperature segregation during the laydown operation. The result can be more variability in density during construction and a nonuniform surface. This problem can be monitored by infrared technology.

Solutions

The solution to each type of segregation is related to its cause. For random rock pockets that appear intermittently in the mat, the method of stockpiling the coarse aggregate at the asphalt plant and the charging of that material into the cold-feed bins by the front-end loader should be checked to ensure that proper aggregate handling techniques are used. Further, all points in the mix-production system at which coarse aggregate particles might accumulate should be inspected to determine whether the flow of the coarse and fine aggregate pieces is uneven. A

batcher should be used at the top of the silo to direct the mix into the center of that piece of equipment.

For longitudinal (side-to-side) segregation, the loading of the haul truck from the batch plant pugmill or from the silo at either the batch or drum-mix plant should be monitored to ensure that the mix is being delivered into the center of the width of the vehicle. When a drum-mix plant is used to manufacture the mix and the segregation always appears on one side of the paver, several trucks should be loaded at the silo while facing in the opposite direction from their normal loading procedure. When the mix is passed through the paver, the longitudinal segregation should change sides—go from one side of the paver lane to the other. If the transverse position of the longitudinal segregation does change (and it should), the solution to the side-to-side segregation problem must take place at the top of the silo. The mix deposited into the silo from the conveying device must be directed into the center of the silo instead of to one side, so that the coarse aggregate particles in the mix are not thrown to only one side of the silo. This solution requires some changes in the configuration of the equipment at the top of the silo. If the transverse position of the longitudinal segregation does not change, the segregation is probably caused by a paver problem.

Most truckload-to-truckload segregation can be reduced significantly by using multiple drops of mix to load the haul trucks. If a tandem-axle truck is being loaded, at least three different drops of mix should be made—into the front of the truck near the front bulkhead, into the back of the truck near the tailgate, and into the center of the truck bed between the first and second drops. If a larger truck is used, additional drops of mix should be made—the first into the front of the truck bed and the second near the tailgate. One of the main solutions for truckload-to-truckload segregation is to minimize the distance the coarse aggregate particles can roll. This is accomplished by making multiple drops of mix into the truck.

The plant operator should be prohibited from topping off the load of mix at the end of the loading process. Each time the silo gates are opened and a little bit of mix is dribbled into the truck, the coarse aggregate particles will tend to separate from the finer material. This problem can be eliminated only by preventing it from occurring.

If segregation does take place during the loading of the truck and there is an accumulation of coarse aggregate particles at the tailgate of the truck, at the front of the bed, or both, the amount of segregation that appears on the roadway can usually be reduced by proper unloading of

the haul truck at the paver. First, the truck bed should be raised a short distance, before the tailgate of the truck is opened, so that the mix can shift in the bed and slide against the tailgate. This procedure surrounds any coarse particles that have rolled to the tailgate area with non-segregated mix. Instead of only the coarse aggregate being deposited first into the paver hopper, a mass of mix is discharged when the truck tailgate is opened, flooding the hopper with mix and typically incorporating the segregated coarse aggregate into that mass of HMA mix.

The operation of the paver can also increase or reduce the amount of segregation that occurs behind the screed. If the paver hopper is emptied of mix, if the slat conveyors are visible, and if the wings of the hopper are dumped after each truckload of mix, any coarse aggregate particles that have collected at the tailgate of the next truckload of mix will be deposited into the bottom of the hopper and then carried directly back to the empty auger chamber in front of the screed. This segregated material will appear behind the screed as soon as the paver moves forward. This transverse segregation, therefore, does not really occur at the end of the truckload, but rather at the beginning of the next truckload of mix.

Segregation can be reduced by keeping the hopper full of mix between truckloads. The mass of mix that floods the hopper from the haul truck will be blended with the mix already in the paver hopper. Any segregated material will be further incorporated in the mix that is pulled back to the augers by the slat conveyors and passed under the paver screed. The amount of truckload-to-truckload segregation can be decreased significantly, but not always eliminated completely, by good paver operating techniques. The problem should really be solved during the truck-loading procedure.

The use of MTVs has also shown some benefit in reducing segregation. The MTV remixes the HMA, and this reduces aggregate segregation, as well as differential temperatures within the mix (also known as temperature segregation).

Effects on Performance

Segregation can affect pavement durability directly by increasing the air void content of the mix in the segregated areas and increasing the potential for moisture damage. Further, the segregated locations are very susceptible to raveling and, if bad enough, to total disintegration under traffic. Segregation, whether in the form of rock pockets, longitudinal (side-to-side) segregation, or transverse (truckload-to-truckload) segregation, is

extremely detrimental to the long-term performance of the pavement.

POOR MIX COMPACTION

Description

The HMA mixture should be compacted so that the in-place air voids are at an acceptable level. If the air voids are above 7 to 8 percent, the mix will be permeable to air and water and will not have the required durability. If the initial compaction results in air voids of approximately 4 percent or lower, the mix may become unstable under traffic after additional densification; the result will be shoving and rutting of the mixture, as discussed earlier. Most mixes require a significant level of compaction to reach the desired 7 to 8 percent or less air voids.

Causes

When the mix is too stiff or too tender, compaction is difficult. The primary cause of poor compaction is low design mix density (high design air voids) (see Section 3). Other causes include inadequate underlying support (Section 14), improper type and weight of rollers (Section 18), improper tire pressure in rubber tire rollers (Section 18), improper rolling procedure (Section 18), improper mix design (Section 3), mix segregation (see above), moisture in the mix (Section 3), variation in mix temperature, and low mix temperature.

Solutions

Solutions to compaction problems include taking the necessary steps to ensure adequate support, producing an acceptable mixture, and using satisfactory laydown and rolling techniques. When support is inadequate, the compaction requirements may have to be relaxed, or the mix may have to be redesigned to allow for satisfactory compaction.

When the asphalt content is too high, the mix may compact too easily, resulting in low air voids (which leads to rutting; see the earlier discussion). When the asphalt content is too low, the mix may be stiff and difficult to compact to the specified density. A satisfactory mix design will produce a mix with optimum asphalt content that can be compacted with reasonable effort to the required density.

Good laydown and rolling techniques, as discussed earlier, are necessary for good compaction. Density can normally be increased by reducing the speed of the paver



or rollers. Density can also be increased by increasing the weight and number of rollers. The compaction process must be adjusted to produce optimum density.

Effects on Performance

When the compaction is inadequate (more than 7 to 8 percent air voids) the mix will be permeable to air and water. Water can flow through the HMA and reduce the strength of the underlying base course. The high voids also result in excessive oxidation of the HMA, which leads to raveling, cracking, and general deterioration of the HMA over a period of time.

When the air voids are excessively low after compaction (less than 4 percent) the mix is likely to rut and

shove under traffic. The low voids are the result not of too much compaction, but of an unsatisfactory mixture.

OTHER PAVEMENT PROBLEMS

The above discussion has addressed only those problems that occur at the time of the asphalt mix production, laydown, and compaction. A number of other deficiencies can occur on an asphalt pavement structure with time and traffic loading once construction has been completed. Those distresses include fatigue cracking, rutting, shoving, raveling, and disintegration. A discussion of such distresses is beyond the scope of this handbook.

