



HOT TUB OWNER'S MANUAL
MODEL:

PINNACLE PLUS – PN 631, PN 740, PN 741,
PN 743, PN 850, PN 855

LUXURY – LX 4000, LX 5000,
LX 8000, LX 9000,
LX 11000



6101 45th St. N.
St. Petersburg, FL 33714
800.304.9684

www.PinnacleSpas.com

Patent Number - D658774

Part Number 7636
SKUs: (1001-1011)
Revised 03/15

Owner's Information

Dealer:

Date Purchased: _____
Company: _____
Address: _____
Telephone: _____

Installer:

Date Installed: _____
Company: _____
Address: _____
Telephone: _____

Hot Tub:

Date Delivered: _____
Model: _____
Color: _____
Serial Number: _____

Your unique hot tub serial number is located on a data plate outside the cabinet at ground level directly below the topside control panel. When calling for service, have your serial number in hand.



Pinnacle Spas Hot Tub Owner's Manual

Table of Contents

Introduction	2
Important Safety Information	3
Location and Installation	7
Electrical Specifications	9
Startup	21
Topside Control	29
Cover	42
Water Management	43
Frequently Asked Questions	44
Troubleshooting	47
Maintenance and Care	48
Shutdown / Winterizing	55
Glossary.....	56
Specifications.....	57
Certificate of Verification.....	65

Important: Pinnacle Spas is dedicated to offering you the best in customer satisfaction and service. Be sure to read, complete, sign, and **send in the limited warranty card within 30 days of purchase** to ensure you understand what you are entitled to in terms of service. If you have any questions, you can call our customer care center, at 800.304.9684.

Printed in the U.S.A.

Version 4.0

Revised 03/2015

Part Number 7636

Patent Number - D658774

Copyright © 2011, Pinnacle Spas. All rights reserved. No portion of this manual may be reproduced in any manner without express written permission of Pinnacle Spas. Pinnacle Spas™ and Thermazone™ are trademarks of Pinnacle Spas. All other brands, product names, company names, trade names, trademarks, and service marks used are the property of their respective owners. Pinnacle Spas may make product modifications and enhancements. Specifications may change without notice. International products may be configured differently to meet local electrical requirements. Dimensions are approximate. Pinnacle Spas hot tubs are covered by U.S. Patent No. D573,261. Other patents pending.

Introduction



Your choice of a Pinnacle Spas™ hot tub indicates that you are devoted to excellence. The management and staff appreciate your patronage and takes pride in the tradition of quality hot tubs that our company represents.

To properly acquaint yourself with your hot tub, we suggest that you take time to read through this manual before hook up and operation. Doing so will familiarize you with important operating and safety procedures, thereby ensuring an enjoyable experience right from the start.

If you need any more information than this manual provides, feel free to visit our Web site at www.PinnacleSpas.com or call our customer care center, at 800.304.9684.

⚠ WARNING: This manual was written to ensure the proper use and installation of your hot tub. Any modifications to the procedures outlined in this manual may result in voiding your warranty.

This manual and its contents are subject to change without notice. Although we have prepared this manual as accurate as possible, we are not liable for errors or omissions; loss, injury, or damages caused by improper installation; or use of hot tub (improper or otherwise).

You new hot tub is made with quality synthetic cabinet materials. Synthetic materials won't fade and are nearly invulnerable to mold and mildew. Where wood splits, cracks, and stains, synthetic materials stand in timeless perfection.

Important Safety Information

IMPORTANT SAFETY INSTRUCTIONS SAVE THESE INSTRUCTIONS

Your physiological response to hot water depends on subjective factors such as age, health, pregnant women, temperature sensitivities, chemical sensitivities, and medical history. Always consult a physician before using a hot tub to understand your particular tolerance and limitations.

READ AND FOLLOW ALL INSTRUCTIONS





WARNING – To reduce the risk of injury, do not permit children to use this product unless they are closely supervised at all times.

A wire connector is provided on this unit to connect a minimum 8 American Wire Gauge (AWG) (8.4mm²) solid copper conductor between this unit and any metal equipment, metal enclosures of electrical equipment, metal water pipe, or conduit within 5 feet (1.5 m) of the unit.

*** For cord connected / convertible units:**  **Danger – Risk of injury.** Replace damaged cord, immediately. Do not bury cord. Connect to a grounded, grounding type receptacle only.













**** For units with GFCI:**  **Warning** – This product is provided with a ground-fault circuit interrupter located in the main panel. The GFCI must be tested before each spa use.

DANGERS

-  **RISK OF ACCIDENTAL DROWNING:** Extreme caution must be exercised to prevent unauthorized access by children. To avoid accidents, ensure that children cannot use this spa unless they are supervised at all times. Always cover the hot tub and use safety locks when it is not in use.
-  **RISK OF INJURY:** The suction fittings in this spa are sized to match the specific water flow created by the pump. Should the need arise to replace the suction fittings or the pump, be sure that the flow rates are compatible. Never operate the spa if the suction fittings are broken or missing. Never replace a suction fitting with one rated less than the flow rate marked on the original suction fitting.
-  **RISK OF ELECTRIC SHOCK:** Install at least 5 feet (1.5 m) from all metal surfaces. As an alternative, a spa may be installed within 5 feet of metal surfaces if each metal surface is permanently connected by a minimum 8 AWG (8.4 mm²) solid copper conductor to the wire connector on the terminal box that is provided for this purpose.
-  **RISK OF ELECTRIC SHOCK:** Do not permit any electric appliance, such as a light, telephone, radio or television, within 5 feet (1.5 m) of a spa. Do not operate such an appliance from either inside the hot tub or when you are wet, unless such appliances are built-in by the manufacturer.

WARNINGS

TO REDUCE THE RISK OF INJURY:

- The water in a spa should never exceed 40°C (104°F). Water temperatures between 38°C (100°F) and 40°C (104°F) are considered safe for a healthy adult. Lower water temperatures are recommended for young children and when spa use exceeds 10 minutes.
 - Since excessive water temperatures have a high potential for causing fetal damage during the early months of pregnancy, pregnant or possible pregnant women should limit spa water temperatures to 38°C (100°F).
 - Before entering a spa/hot tub, the user should measure the water temperature since the tolerance of water temperature regulating devices varies.
 - The use of alcohol, drugs or medication before or during spa/hot tub use may lead to unconsciousness with the possibility of drowning.
 - Obese persons and persons with a history of heart disease, low or high blood pressure, circulatory system problems, or diabetes should consult a physician before using a spa.
 - Persons using medication should consult a physician before using a spa/hot tub since some medication may include drowsiness while other medication may affect heart rate, blood pressure and circulation.
-  Do not connect auxiliary components (such as headphones, cables, and additional speakers) to the stereo (if equipped).
-  Do not use a hot tub immediately following strenuous exercise.
-  Do not use your hot tub alone.
-  Lock the cover on your hot tub when not in use.
-  Persons with infectious diseases should not use a hot tub.
-  Replace audio components only with identical components.
-  Do not leave the CD access door open on the stereo (if equipped).
-  Some types of hair dye can react with the sanitizers in your hot tub water causing your hair to change color. Use at your own risk.
-  Water normally splashes out of a hot tub during typical use. Install an adequate perimeter that provides sound footing.
-  Do not turn your hot tub on/off from a wall switch, ground fault circuit interrupter, circuit breaker, fuse, or by plugging/unplugging it.
-  Remove all jewelry, metal, and watches from your person before entering your hot tub.
-  Keep all breakables away from the hot tub area.
-  Maintain water balance in accordance with instructions.

WARNING SIGN



Warning Sign Must Be Posted – The red WARNING sign like the one shown is packed with your new hot tub. This sign must be posted in a prominent place in close proximity to the hot tub installation site immediately upon completion of hot tub installation.

Important: It is extremely important that this sign be permanently placed in clear view of persons using the hot tub. Occasional hot tub users may not be aware of some of the dangers hot water poses to pregnant women, small children, seniors, and people under the influence of alcohol. If you did not receive a warning sign or your sign has become damaged, please call your local dealer for a replacement.

HYPERTHERMIA

To reduce the risk of injury, the water temperature in a hot tub should never exceed 104°F (40°C). Water temperatures between 100°F (38°C) and 104°F (40°C) are considered safe for a healthy adult. Lower water temperatures are recommended for young children, senior citizens, persons with sensitivities, and when hot tub use exceeds 10 minutes.

WATER TEMPERATURE IN EXCESS OF 100°F (38°C) MAY BE INJURIOUS TO YOUR HEALTH.

Hyperthermia occurs when the internal temperature of the body reaches a level several degrees above the normal body temperature of 98.6°F (37°C). The symptoms of hyperthermia include drowsiness, lethargy, and an increase in the internal temperature of the body. The effects of hyperthermia include:

- ⚠ Unawareness of impending hazard
- ⚠ Failure to perceive heat
- ⚠ Failure to recognize the need to exit hot tub
- ⚠ Physical inability to exit hot tub
- ⚠ Fetal damage in pregnant women
- ⚠ Unconsciousness and danger of drowning

If you sense any of the symptoms of hyperthermia, safely exit the hot tub immediately.

SAVE THESE INSTRUCTIONS

BASIC SAFETY GUIDELINES

Your hot tub is meant to be enjoyable, healthful, and relaxing. Below are some basic safety guidelines to follow every time you use your hot tub.

- Always check the temperature of your hot tub before entering. High water temperatures can be hazardous to your health.
- Persons suffering from heart disease, diabetes, high or low blood pressure, and pregnant women should consult a doctor before using

your hot tub.

- Persons under the influence of medication, drugs, or alcohol should not be allowed into your hot tub.
- Remove all jewelry, metal, and watches from your person before entering your hot tub.
- Do not allow children to use your hot tub without continuous supervision of an adult.
- Do not use your hot tub alone.
- Test the ground fault circuit interrupter (GFCI) breaker prior to using your hot tub each time to ensure it operates properly.
- Any electrical devices near your hot tub must be GFCI protected and out of reach from inside the hot tub.
- Keep all breakables away from the hot tub area.
- Lock the cover on your hot tub when not in use.
- Enter and exit the hot tub slowly. Wet surfaces can be slippery.
- Prolonged immersion can be hazardous to your health.

Maintain water chemistry in accordance with manufacturer's instructions.

- The hot tub is not to be used by persons with reduced physical, sensory or mental capabilities, or lack of experience and knowledge, unless they have been given supervision or instruction

BASIC WATER QUALITY GUIDELINES

- *During the initial filling of the spa, add a sequestering agent to combat suspended minerals in the water. Allow water to circulate and filter for at least 12 hours before adding any other chemicals.*
- *Test water for PH, total Alkalinity, and Calcium hardness. The PH should be 7.2-7.8 and the total Alkalinity 80-180 PPM. Calcium hardness levels should be maintained between 150 and 400 PPM. Adjust PH and total Alkalinity (TA) utilizing the directions on the chemical bottles. Wait 15-30 minutes, test and adjust if necessary.*
- *Add 2 ounces of concentrated chlorinating granules (sodium Dichlor-s-triazinetreone) on initial start up to begin sanitizing the spa water. It is important not to add the chlorinating granules until the PH, alkalinity and calcium hardness have been adjusted to their proper levels.*
- *Check spa water with test strip for proper sanitation levels and adjust accordingly to the proper levels. Free chlorine should be 2-4 PPM.*
- *We recommend a minimum level of 2 PPM residual chlorine be*

maintained in spa water. Be sure the pumps are running when adding chlorine or non-chlorine shock/oxidizer.

- *Add 1 ounce of non-chlorine shock/oxidizer or ½ ounce of chlorine to the spa water after each spa use.*

FOR HOT TUBS EQUIPPED WITH AUDIO COMPONENTS

Audio components are optional and not available on all models.

⚠ WARNING: Prevent Electrocuton: Do not connect any auxiliary components – for example, cable, additional speakers, headphones, etc., – to the system.

⚠ Caution: Risk of Electric Shock: Do not leave audio compartment door open. Replace audio components only with identical components.



Location and Installation

Proper planning is an important consideration when installing your new hot tub. Site selection is a critical step and requires serious thought. Planning ahead makes the installation process easier. The following information is provided to assist you in site preparations.

- 1) Always comply with local building codes and obtain any necessary permits. You may also need to consult with an engineer to address your specific design needs.
- 2) Contact an electrician to assess your electrical needs, install wiring, and assure a safe operation.
- 3) Position your hot tub with proper access to water, drainage, and electricity.
- 4) Place your hot tub on a uniform solid, flat surface designed to properly support its weight. For external installations, a 4-inch (10 cm) thick cement pad suffices. See page 9 for conduit entry locations for your model hot tub.
- 5) For internal installations, check the load carrying capabilities of the floor on which the hot tub will reside. Most homes meet the requirement of 80 pounds per square foot.

- 6) Assure that your hot tub will fit into the space you have chosen and the delivery route will accommodate its large size.
- 7) Provide adequate ventilation for the humidity created by your hot tub. In most cases, a Hot Tub Hard Cover is sufficient.
- 8) Protect the pump and all equipment from the weather by ensuring the cabinet panels are secure at all times.
- 9) Allow 36 inches (1 meter) of unobstructed access to all sides of your hot tub for normal servicing. Your hot tub is not designed to be recessed in the ground or in a deck.

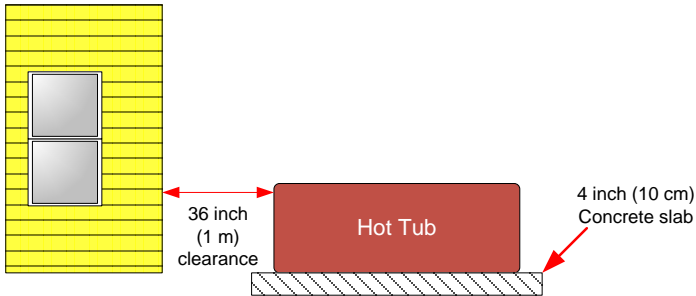

Figure 1 – Clearances and Support

The following dimensions can be used to determine the proper location of submerged conduits in concrete slab installations. All dimensions are made from the outside of the hot tub's frame with the access panels removed. The topside control panel is shown at bottom of diagram for reference.

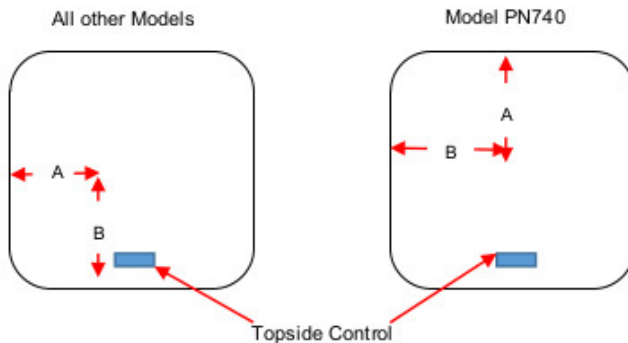

Figure 2 – Conduit Entry Location Reference Points

Model	Dimension A	Dimension B
LX 4000 (1006)	22" (56 cm)	22" (56 cm)
LX 5000 (1004)	18" (46 cm)	11" (28 cm)
LX 8000 (1001B)	20" (51 cm)	13" (33 cm)
LX 9000 (1003)	20" (51 cm)	13" (33 cm)
LX 11000 (1002)	22" (56 cm)	12" (30 cm)
PN 631 (1011)	12" (30.5 cm)	9" (23 cm)
PN 741 (1007)	29" (73.5 cm)	15" (38 cm)
PN 743 (1009)	27" (68.5 cm)	13" (33 cm)
PN 850 (1008)	25" (63.5 cm)	13" (33 cm)
PN 855 (1010)	28" (71 cm)	14" (35.5 cm)
PN 740 (1012)	34" (85 cm)	11" (28 cm)

Table 1 – Conduit Entry Location Dimensions

- 10) Consider positioning your hot tub out of or adequately protecting it from the wind. Just as people can get cold on cool/windy days so can your hot tub. Windy environments can significantly increase operating costs.
- 11) Consider using an insulating pad. In cold climates, the ground can rob heat from the hot tub and increase your operating costs. Consider using a suitable, outdoor insulating pad in such environments.

Electrical Specifications

Important – Qualified and licensed electricians must perform all electrical hookups. The following specifications must be followed in order to ensure proper performance and safety.

All hot tubs can supplied with Balboa or Gecko control and must be wired with a 50 or 60 Amp breaker (or according to IEE wire regulations for export models). Failure to do so will cause equipment damage and will not be covered under your warranty. All hot tubs must be over current protected with a built-in GFCI (or RCD for export models) in the service panel.

Model	Volts (V)	Freq. (Hz)	Rating (A)	GFCI (A)	Wire size from GFCI to Main Panel [†]	Equipment Pack
LX 4000, LX 5000	240	60	40	50	6-3 plus ground (up to 130') 4-3 plus ground (up to 230') 2-3 plus ground (up to 360')	VS515Z or VS500Z or BP501X, TP600CE*
LX 8000, LX 9000, LX 11000, PN 741,740, 743, 850, 851, 855	240	60	48	60	"	VS510SZ or BP501X, TP600CE*
PN 631	240	60	40	50	"	VS500Z or BP501X, TP600CE*

Table 2 – Domestic (US/Canada) Wire Size Chart

Model	Volts (V)	Rating (A)	RCD (A)	Wire size from RCD to Main Panel [‡]	Equipment Pack
LX 4000, LX 5000, LX 8000, LX 9000, LX 11000, PN631, PN741, PN740, PN743, PN850, PN851, PN855	220- 240	1x32 2x16	IEE Wire Regulation	3x4 mm ² 5x1.5 mm ²	GS510SZ or BP601X, TP600CE*

Table 3 – Export Wire Size Chart

****For Spas with TP600CE see included 7876A insert.**

⚠ WARNING: Starting an incorrectly wired hot tub could cause severe damage to the mechanical equipment or even bodily harm. Have your licensed electrician verify GFCI (or RCD) wiring with the schematics on pages 10-20 prior to starting the hot tub or call the technical support line at 800.304.9684.

⚠ Caution: Failure to abide by specifications listed may result in damage to the equipment and will void the warranty.

⚠ WARNING: Disconnect the electrical power before servicing. Before obtaining access to terminals, all supply circuits must be disconnected.

⚠ Caution: Test the GFCI (or RCD) before each use.

* Wire size may need to be reduced at GFCI to fit into the breaker

† Solid copper

‡ Wire size may need to be reduced at GFCI to fit into the breaker

§ Solid copper



Our hot tubs are certified by Intertek Testing, SNAa Ltd. Ontario, Canada to CSA-C22.2 No. 218.1-M89 and ANSI/UL 1563 standards.



Parts with extra low voltage not exceeding 12v must be inaccessible to a person in the hot tub. Earthed appliances must be permanently connected to fixed wiring. Parts incorporating electrical components, except remote control devices, must be located or fixed so that they cannot fall into the hot tub.

Means for disconnection must be used in fixed wiring in accordance with wiring rules.

Important – To allow the 240V GFCI to function properly, connect the white Neutral wire from the hot tub to the Neutral terminal on the GFCI breaker, not the Neutral bus in the GFCI breaker box. An improperly connected Neutral causes the GFCI breaker to trip.

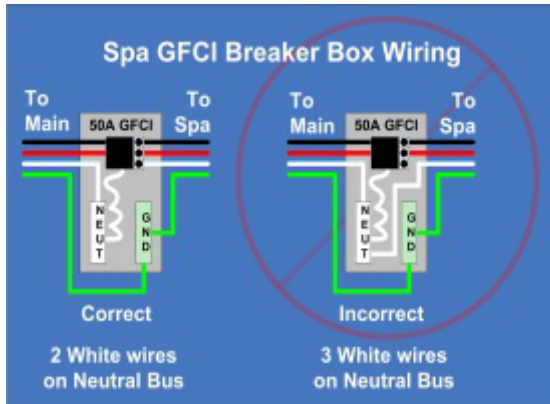
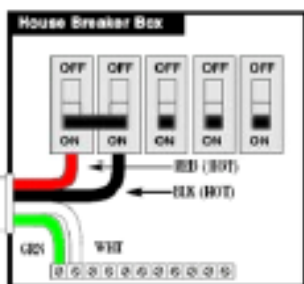
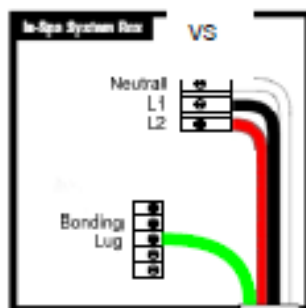
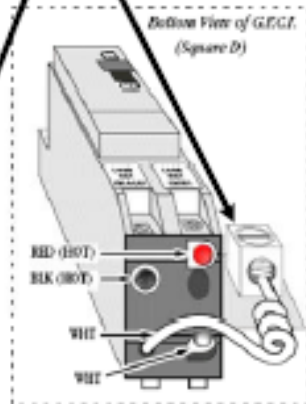
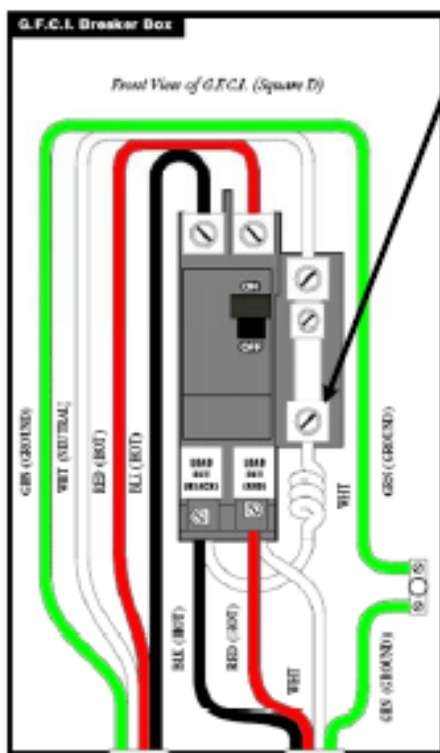

Figure 3 – GFCI Wiring



Important: Installation of this GFCI Circuit Breaker, including Ampere sizing and selection of conductor size and type, must be performed by a qualified electrician in accordance with the National Electrical Code, or the Canadian Electrical Code, and all federal, state, and local codes and regulations in effect at the time of installation.

Note: The white Neutral wire from the back of the GFCI must be connected to the incoming Line Neutral. The internal mechanism of the GFCI requires this neutral connection. The GFCI will not work without it.



IN.XE Spa Pack

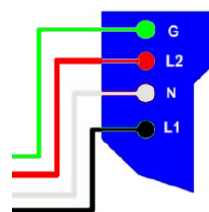

Figure 4 – U.S. and Canada Wiring Diagram

See wire size chart on page 9.

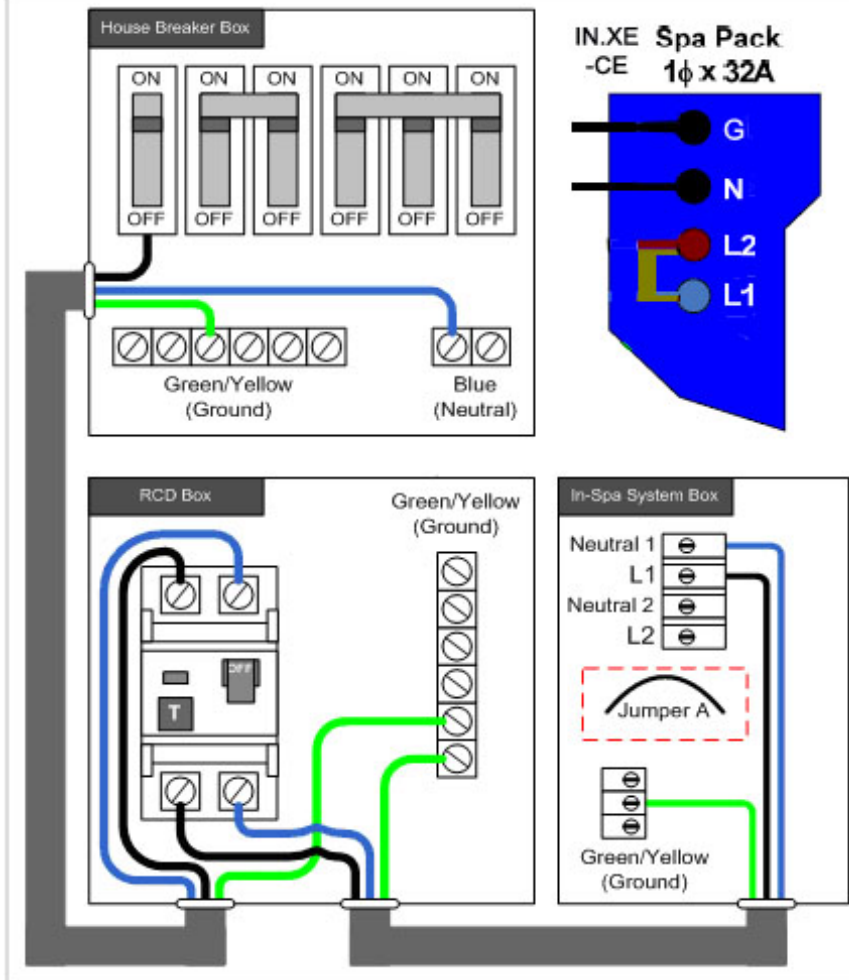

Figure 4 – European 1x32A Wiring Diagram

All wiring is 3x4mm², solid copper
See wire size chart on page 10.

Note: Make sure that the DIP switches in the hot tub Pack are properly set for 50Hz operation and Jumper A is in place.

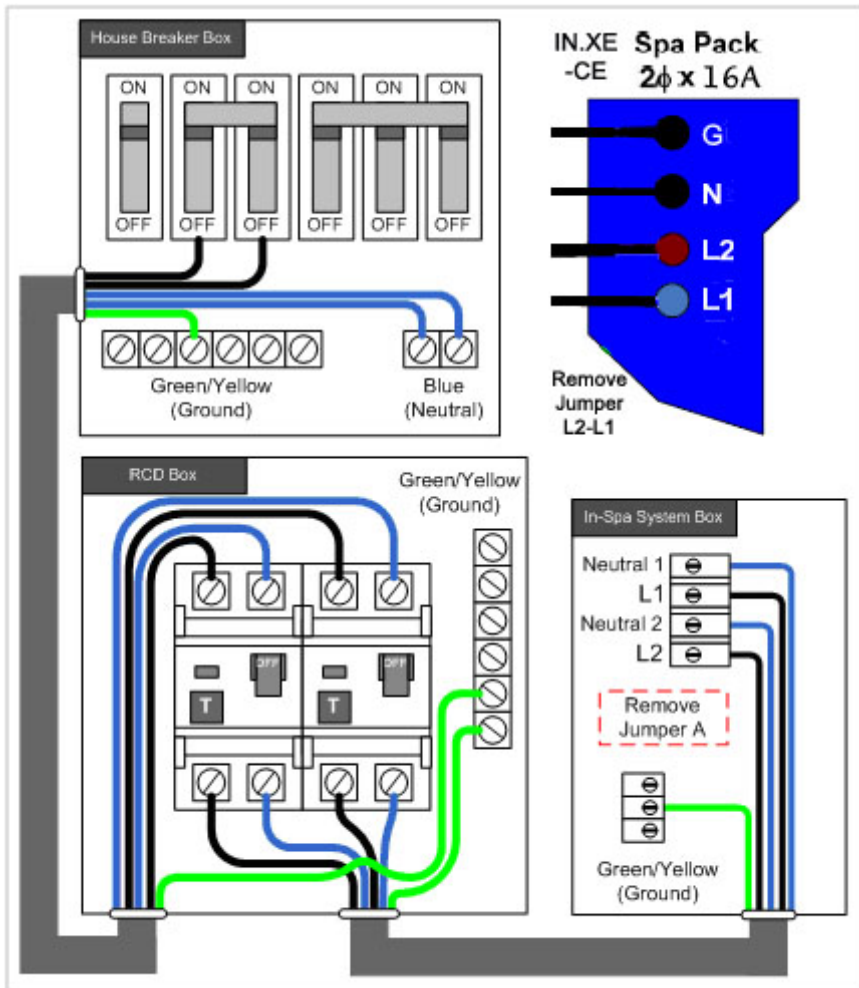

Figure 5 – European 2x16A Wiring Diagram

All wiring is 5x1.5mm², solid copper
See wire size chart on page 10.

Note: Make sure that the DIP switches in the hot tub Pack are properly set for 50Hz operation and Jumper A is removed.

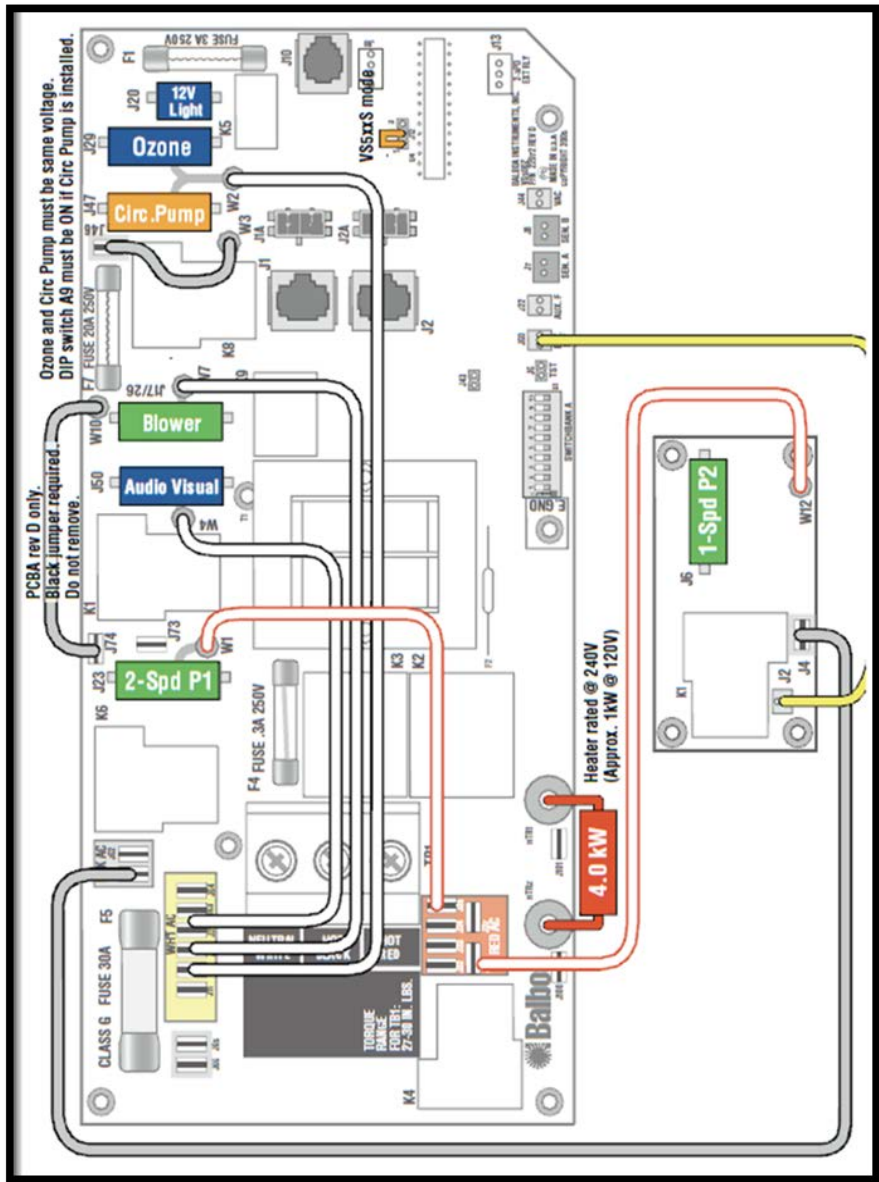

Figure 7 – Domestic Wiring Diagram for LX 8000, LX 9000, LX 11000, PN740, PN741, PN743, PN850, PN851, PN855 (option) Models. Single-phase 240V with Balboa VS510SZ Control Pack.

See wire size chart on page 10.

WARNING: Main Power to system should be turned OFF BEFORE adjusting DIP switches.
WARNING: Persistent Memory (J43) must be RESET to allow new DIP switch settings to take effect.

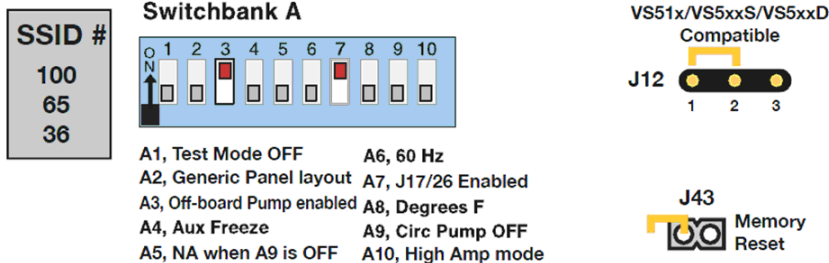
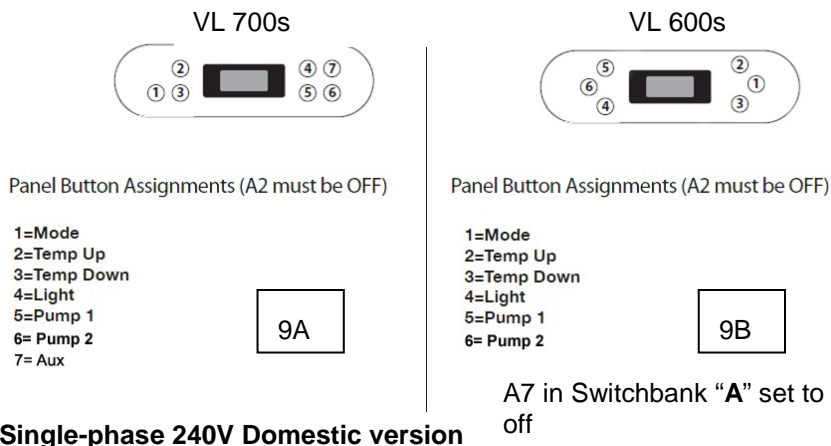

Figure 8 – Board Diagram for LX 8000, LX 9000. LX 11000 with VL 700s and PN740, PN741, PN743, PN850, PN851 With VL 600s

WARNING:

- Setting DIP switches incorrectly may cause abnormal system behavior and/or damage to system components.
- Refer to Switchbank illustration on Wiring Configuration page for correct settings for this system.



Single-phase 240V Domestic version

Figure 9A – Panel Button Positions for LX 8000, LX 9000 and LX 11000 Models Single-phase 240V Domestic version

Figure 9B – Panel Button Positions for PN740, PN741, PN743, PN850, PN851, and PN855

SSID 100 65 36

Base Model VS500SZ-VS501SZ-VS510SZ

DIP Switch Key

- A1 Test Mode (normally OFF)
- A2 "ON" position: Long Serial Standard panel (customer specific)
"OFF" position: Generic Balboa Serial Standard panel layout
- A3 "ON" position: off-board pump enabled *
"OFF" position: off-board pump disabled
- A4 Aux Freeze (must be OFF)
- A5 Disabled when A9 is OFF
"ON" position: Two-speed pump 1
"OFF" position: One-speed pump 1 (A9 must be On and a Circ Pump installed)
- A6 "ON" position: 50Hz operation
"OFF" position: 60Hz operation
- A7 "ON" position: J17/26 equipment enabled *
"OFF" position: J17/26 equipment disabled
- A8 "ON" position: temperature is displayed in degrees Celsius
"OFF" position: temperature is displayed in degrees Fahrenheit
- A9 "ON" position: 24 Hour Circ Pump with 3°F shut off, Ozone runs with Circ Pump
"OFF" position: no Circ Pump, Ozone runs with Pump 1-low during filter cycles only
- A10 "ON" position: heater is disabled while any high-speed pump or blower is running (low amperage mode)
"OFF" position: heater can run while any/all high-speed pumps or blowers are running (high amperage mode)

Jumper Key

- J12** Jumper on Pin 1 and 2 will enable VS51x/V55xxS/V55xxD compatibility mode.
Jumper on Pin 2 and 3 will enable VS50x compatibility mode (Do not use with Standard or Deluxe Panels).
 - J43** When jumper is placed on 2 pins during power-up, system will reset persistent memory.
Leave on 1 pin only to enable persistent memory feature.
-

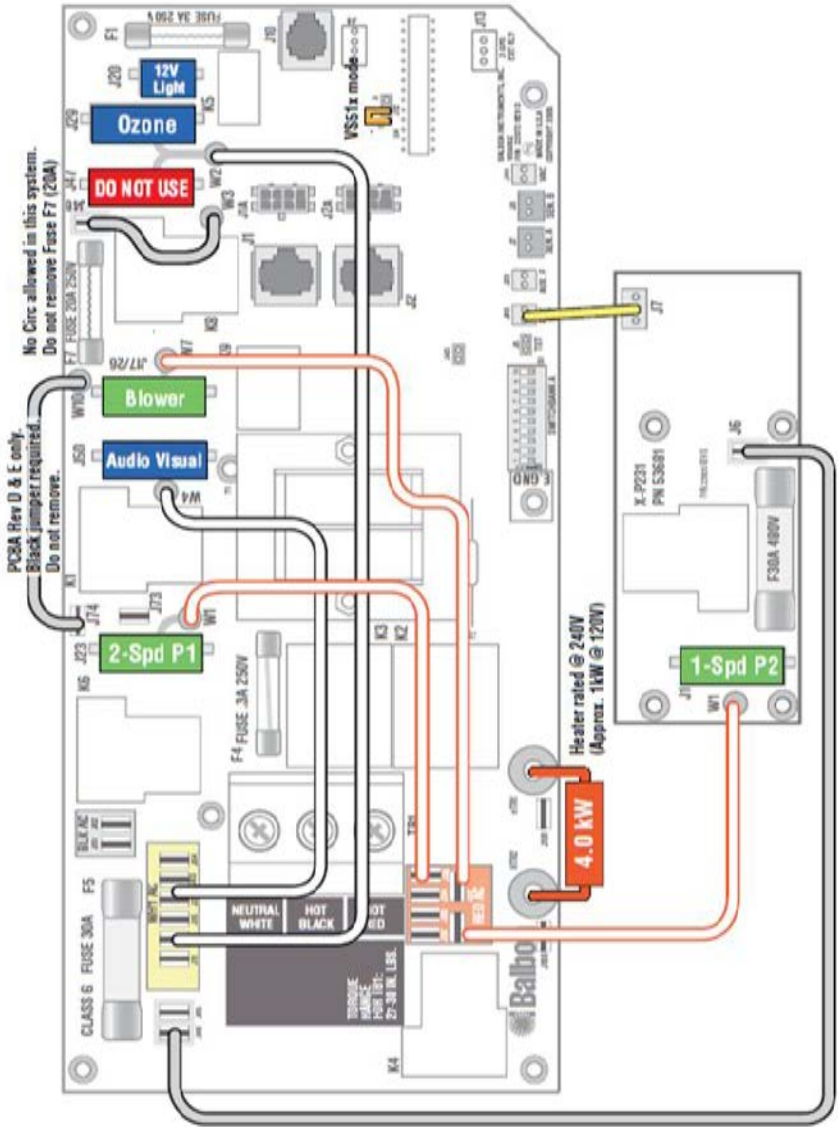

Figure 10A – Domestic Wiring Diagram for LX 4000 and LX/DX 5000 Models Single-phase 240V with VS515Z Control Pack.
(See wire size chart on Pg. 10.)

WARNING: Main Power to system should be turned OFF BEFORE adjusting DIP switches.
WARNING: Persistent Memory (J43) must be RESET to allow new DIP switch settings to take effect. (See Persistent Memory page)

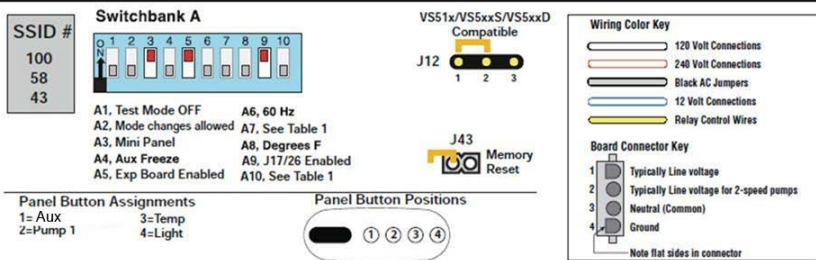

Figure 11 – Board Diagram for LX 4000 and LX/DX 5000 Models Single-phase 240V Domestic version

SSID 100 58 43

Base Model VS515Z

DIP Switch Key

- A1 Test Mode (normally OFF)
 A2 "ON" position: Standard mode only
 "OFF" position: Std/Ecn/Sleep mode changes allowed
 A3 "ON" position: use Mini Panel
 "OFF" position: use Digital Duplex or Light Duplex panel
 A4 Aux Freeze (must be OFF)
 A5 "ON" position: Expander Board Enabled for 1-speed Pump only.
 "OFF" position: Expander Board Disabled.
 A6 "ON" position: 50Hz operation
 "OFF" position: 60Hz operation
 A7+A10 Control amp draw requirements (See Table 1)
 A8 "ON" position: temperature is displayed in degrees Celsius
 "OFF" position: temperature is displayed in degrees Fahrenheit
 A9 "ON" position: J17/26 Enabled for Blower or 1-speed Pump.
 "OFF" position: J17/26 Disabled

Note: For Panel layout See Chart below.

Alert:
 Circ Pump is not allowed on this system.

AZ	A10	# of Hi-Speed Pumps/Blower Before Heat Disabled
OFF	OFF	0
ON	OFF	1
OFF	ON	2
ON	ON	3

Jumper Key

- J12 Factory set. DO NOT MOVE.**
 Jumper must be on Pins 1 and 2 for VS51xZ/VS52xZ/VS5xxSZ/VS5xxDZ software.
 Jumper must be on Pins 2 and 3 for VS50xZ software.
- J43** When jumper is placed on 2 pins during power-up, system will reset persistent memory.
 Leave on 1 pin only to enable persistent memory feature.

WARNING:

- Setting DIP switches incorrectly may cause abnormal system behavior and/or damage to system components.
- Refer to Switchbank illustration on Wiring Configuration page for correct settings for this system.
- Contact Balboa if you require additional configuration pages added to this tech sheet.

U.S. AND CANADA WIRING VS500Z

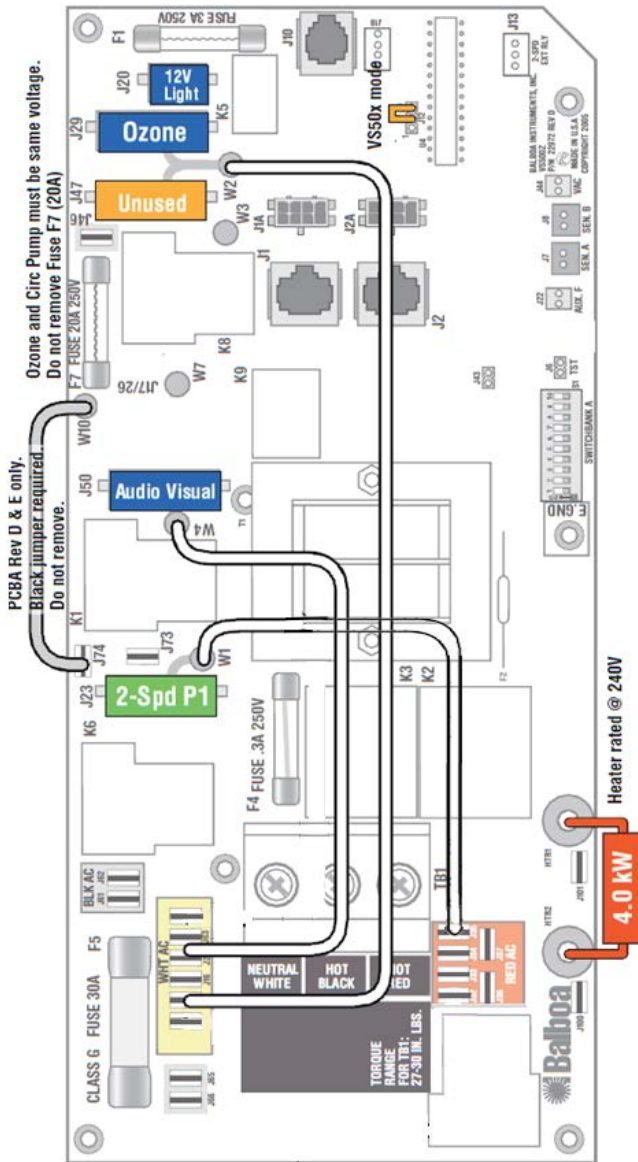

Figure 10B – Domestic Wiring Diagram for PN631 Model Single-phase 240V for VS500Z Control Pack.

WARNING: Main Power to system should be turned OFF BEFORE adjusting DIP switches.
WARNING: Persistent Memory (J43) must be RESET to allow new DIP switch settings to take effect.

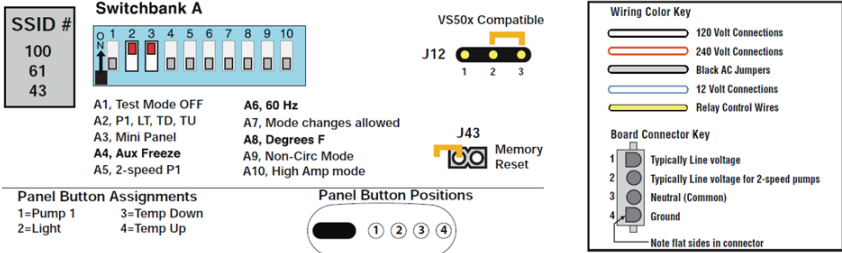



Figure 11 – Board Diagram for VS500z Single-phase 240V Domestic version

SSID 100 61 43

Base Model VS500Z

DIP Switch Key

- A1 Test Mode (normally OFF)
- A2 "ON" position: Button layout will be: Pump 1, Light, Temp Down, Temp Up *
"OFF" position: Button layout will be: Unused, Pump 1, Temp, Light
- A3 "ON" position: use Mini Panel 
"OFF" position: use Lite Duplex or Digital Duplex panel 
- A4 Aux Freeze (must be OFF)
- A5-A9 Pump 1 speeds and Circ Modes:

A5	A9	Circ Mode	Pump 1 Speed
OFF	OFF	Non-circ	2-speed
ON	OFF	Circ "acts like Pump 1 low" (filters/polls/ect)	1-speed
OFF	ON	24 hours with 3°F shut-off	1-speed
ON	ON	24 hours with 3°F shut-off	2-speed
- A6 "ON" position: 50Hz operation
"OFF" position: 60Hz operation
- A7 "ON" position: Standard mode only
"OFF" position: Std/Ecn/Sleep mode changes allowed
- A8 "ON" position: temperature is displayed in degrees Celsius
"OFF" position: temperature is displayed in degrees Fahrenheit
- A10 "ON" position: heater is disabled while any high-speed pump is running (low amperage mode)
"OFF" position: heater can run while any/all high-speed pumps are running (high amperage mode)

Jumper Key

- J12 **Factory set. DO NOT MOVE.**
Jumper must be on Pins 1 and 2 for VS51xZ/VS52xZ/VS5xxSZ/VS5xxDZ software.
Jumper must be on Pins 2 and 3 for VS50xZ software.
- J43 When jumper is placed on 2 pins during power-up, system will reset persistent memory.
Leave on 1 pin only to enable persistent memory feature.

EXPORT WIRING ALL MODELS

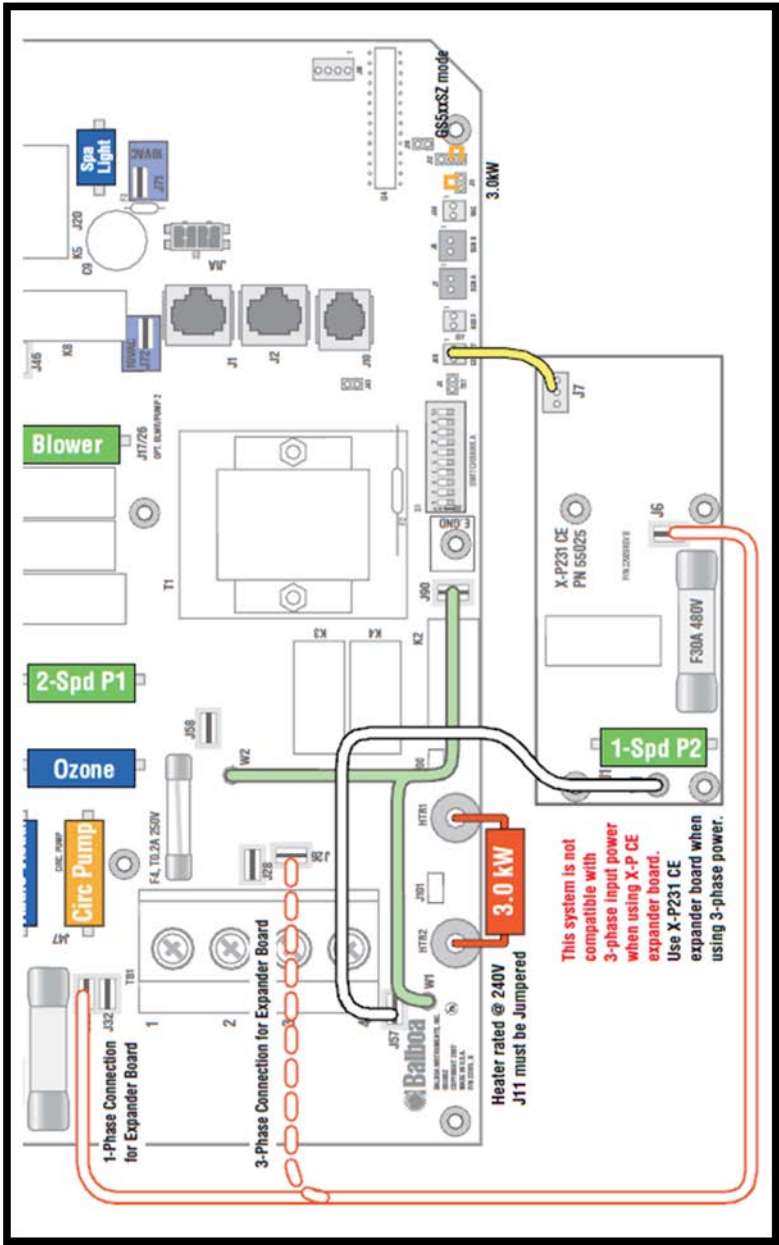
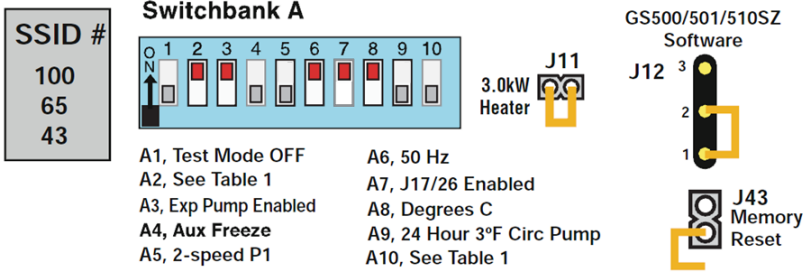

Figure 12 – Export Wiring Diagram for all models for GS510SZ Control Pack (See wire size chart on Pg. 10.)

WARNING: Main Power to system should be turned OFF BEFORE adjusting DIP switches.
WARNING: Persistent Memory (J43) must be RESET to allow new DIP switch settings to take effect.



**Figure 13 – Board Diagram for all models.
Export version for GS510SZ Control Pack.**

SSID 100 65 43 Base Model GS500SZ-GS501SZ-GS510SZ

DIP Switch Key

- A1 Test Mode (normally OFF)
- A2+A10 Control amp draw requirements (See Table 1)
- A3 "ON" position: Expander Board Enabled for 1-speed Pump only.*
"OFF" position: Expander Board Disabled.
- A4 Aux Freeze (must be OFF)
- A5+A9 Pump 1 speeds and Circ Modes:

A5	A9	Circ Mode	Pump 1 Speed
OFF	OFF	Non-circ	2-speed
ON	OFF	Circ "acts like Pump 1 low" (filters/polls/ect)	1-speed
OFF	ON	24 hours with 3°F shut-off	1-speed
ON	ON	24 hours with 3°F shut-off	2-speed

Table 1		# of Hi-Speed Pumps/Blower Before Heat Disabled
A2	A10	
OFF	OFF	0
ON	OFF	1
OFF	ON	2
ON	ON	3

- A6 "ON" position: 50Hz operation
"OFF" position: 60Hz operation
 - A7 "ON" position: J17/26 Enabled for Blower or 1-speed Pump.*
"OFF" position: J17/26 Disabled
 - A8 "ON" position: temperature is displayed in degrees Celsius
"OFF" position: temperature is displayed in degrees Fahrenheit
- * Panel with button layout (Ⓜ) is not compatible when both A3 and A7 are ON.

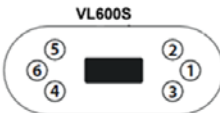

Panel Button Assignments (A2 must be OFF)

- 1=Mode
- 2=Temp Up
- 3=Temp Down
- 4=Light
- 5=Pump 1
- 6= Pump 2

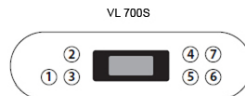

Figure 14

– Panel Button Positions for all models Export version.

Startup

Important – Read these step-by-step startup procedures before starting your hot tub. Failure to follow any of these steps listed may result in damage to the equipment and may void your warranty.

Note: If you are unsure of any of the above startup procedures, please call our customer care center, at 800.304.9684. For best results, read each step in its entirety before proceeding.

⚠ Caution: Running the hot tub pump dry (without water running through it) can cause IMMEDIATE damage and will void the warranty! Be sure that the hot tub is installed properly in accordance with the instructions in this manual.

Refer to the following picture for an explanation of your hot tub's controls, components, and technical terms. Note that not all models have all features and components.



Figure 15 – Callouts

Before Adding Water

Before adding water, go through these simple steps now to prevent common issues when setting up your hot tub for the first time. Verify that the following have all been rechecked.

1. Turn off all power to the hot tub at the main breaker panel.
2. Open the side panels to access the internal components.
3. Check that all slide valves are opened (T-handles pulled out) to the heater and all pumps.
4. Check that there are no obvious signs of loose wires or broken pipes.

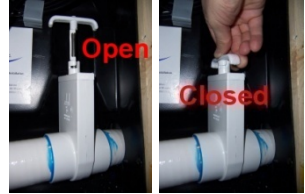

Figure 16 - Valve Open/Closed

5. Check that the two heater unions are hand tight.

⚠ Caution: Do not use a wrench. Over-tightening may cause damage to unions and gaskets, which will not be covered under warranty.



Figure 17 - Unions Tight

6. Check that the unions on all pumps are tight.
7. Clean out any foreign debris from within the service access area or inside of the hot tub itself.
8. With the drain open and filters removed, thoroughly rinse out the hot tub with warm water until the drained water runs clear. Run water through the filtration canister and jet lines to remove any incidental dust, dirt, and debris that may have accumulated during shipment or installation. Drain all water completely.
9. Make sure that the hot tub drain valve is closed and the cap is on tight (see page 50).
10. Install the filter(s) in the filtration canister.
11. Check that all of the hot tub jets are open (turned full counter-clockwise).
12. Now is the best time to clean and polish the surfaces of your hot tub (see pages 44).

Filling Your Hot Tub

Now it's time to fill your hot tub with water. Do not turn on the electricity yet until the hot tub is completely filled. To properly fill your hot tub:

1. Make sure that the filters (in the filtration canister) are gently screwed into place. Turn them clockwise until they stop being careful not to over-tighten them (this avoids cracking the filter).
2. Connect a standard garden hose to a faucet with regular cold tap water (not softened water or hot water).



Figure 18 – Filtration Canister

⚠ Caution: The water from your hot water tank should not be used to fill the hot tub.

3. Put the pre-filter (if equipped**) on the other end of the hose, point the pre-filter into a suitable drain, turn on the water, and allow any sediment to be flushed down the drain. Once the water stream runs clear, turn off the hose.
4. Put the pre-filter (if equipped) into the filtration canister and turn on the hose.
5. **Fill slowly.** If too much water pressure is used, foaming water can force air into the pipes and cause startup problems.

Important: To assure that the pump is properly primed, **fill the hot tub through the filter area only.**

6. Fill the hot tub until the water level is about 1" above all jets (or about ½" below the pillow). Do not over fill.

Note: Every person entering a hot tub displaces a given volume of water, so adjust water level to the number of people regularly using the hot tub.

Turn off the hose and check again for any small leaks.

** Pre-filters are available by calling 800.304.9684

Operational Checks for all Models with Balboa Control

 **Caution:** Do not turn on any pump until your hot tub is properly filled with water. Running any pump without water in your hot tub can cause IMMEDIATE damage, which is not covered under warranty!

By now you have rechecked your hot tub's mechanical connections and filled it with water to about 1" above all jets by adding cold tap water through the pre-filter (if equipped). Turn on power to the hot tub at the main breaker panel and test the operation of the electrical system. If you encounter a problem, please reference the troubleshooting guide on page 47.

1. Turn on the breaker and test the operation of the Ground-Fault Circuit Interrupter (GFCI) breaker by pushing the small button. This should automatically trip the hot tub's circuit breaker.

 **DANGER:** If this breaker does not trip, immediately call your electrician. Do not use your hot tub!

Only if pushing this button successfully trips this circuit breaker should you reset this breaker and proceed to the next step.

2. Go to the topside control panel. The hot tub first goes into a 5-minute Priming mode, indicated by "Pr" message. Water heating is disabled during priming. To exit Priming mode and begin normal hot tub operation, press "Up" or "Down" button.
3. Press the Jets (Jets 1) button. You should hear the pump turn on, see water circulating, and see the Jets light illuminate on the panel.
4. Press the Jets (Jets 1) button again. You should hear the pump turn on a higher speed.

 **Caution:** If water is not flowing from the jets after 2 minutes, turn the power off at the main panel and bleed air from the system (see page 46). Turn the power on again. Sometimes momentarily turning the pump off/on will help to prime. Only do this four times.

5. If the water is running smoothly through the lines, open the air control valve to the jets and you should see an increase in jet pressure. Check and adjust the water and airflow of every jet if necessary.
Each jet in your hot tub can be adjusted for massage intensity and directional flow. Turn the outer jet dial counterclockwise to increase the water volume and clockwise to turn it off. Pivot the angle of a jet to achieve an optimal massage.
An air mixture intensifies the level of your massage. Turn the air control valve counterclockwise to increase the air mixture and clockwise to turn it off.
To minimize heat loss, close the air control valve when your hot tub is not in use.
6. Press the Jets (Jets 1) button a third time to turn off the pump.

Note: The pump remains on if filtration or heat is needed.
7. Press the Light button to turn on the light. Verify that the light is on.
8. Press the Light button a second time to turn off the light.
9. If equipped, press the Jets 2 button. You should hear the pump turn on, see water circulating, and see the Jets2 light illuminate on the panel.
10. Press the Jets 2 button again to turn off the pump.
11. If equipped, press the Blower button. You should hear the blower turn on, see water bubbling, and see the blower light illuminate on the panel.
12. Press the Blower button again to turn off the blower.

Water Balancing

Note: Perform water balancing weekly and whenever your water is changed (or when your hot tub is first filled). Once your hot tub reaches 95°F, add the necessary chemicals to stabilize your water chemistry (pH, hardness, and total alkalinity, etc.). Then add the start-up chemicals to the water. Turn Pump 1 on high speed immediately to distribute it evenly.

Note: Test strips and water balancing chemicals are available by calling 800.749.8003 or visiting www.hottubparts.com

Test	Range
Total Alkalinity	80-180 ppm
pH	7.2-7.8
Calcium Hardness	150-400 ppm
Bromine	1.0-2.0 ppm

Table 4 - Recommended Ranges for Balanced Water

Topside Control

There are various styles of topside control panels used domestically and internationally in the Pinnacle Spas series of hot tubs. Basic operations common to all control panels are provided next.

Setting the Water Temperature

Use *Warm/Cool* [or *Temp* for the 4-button panel] to set the water temperature you desire. The temperature setting displays for five seconds to confirm your new selection. The set point icon indicates that the display shows the desired temperature (not the actual water temperature). The default temperature setting is 100°F.

Setting the Filtration Cycles

To set the filtration cycle start time, reset the controller by power cycling (power off). After the five minute priming, the filtration cycle starts 12 hours later. You can also skip the priming period by pressing *Warm/Cool* [or *Temp* for the 4-button panel].

Filter duration is programmable for 2, 4, 6, 8 hours or for continuous filtration (indicated by "FC"). The default filter time is 2 hours. To change the filter cycle duration, press *Warm/Cool* [or *Temp* for the 4-button panel], then *Mode* [Jets]. Press *Warm/Cool* [Temp] to adjust. Press *Mode* [Jets] to exit.

When *Jets 1* [or *Jets* for the 4-button panel] LED is ON and the *Heat* LED is OFF, the hot tub is in filtration mode.

Other operations are slightly different between each of the three control panels. Step-by-step programming and a quick reference summary are provided next.

LX 8000, LX 9000 AND LX 11000 – (VL700S)

The topside control panel operates and programs your hot tub. Basic button functions are described next.

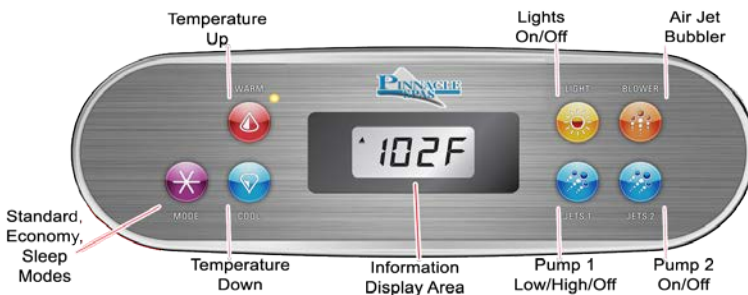

Figure 19 – Topside Callouts for VL700S Controls
LX 4000, LX/DX 5000, and pn631 Domestic – (MVP 260)



Figure 20 – Topside Callouts for MVP 260 Controls.
LX 4000 and LX 5000 (Export Only) – (VL600S)

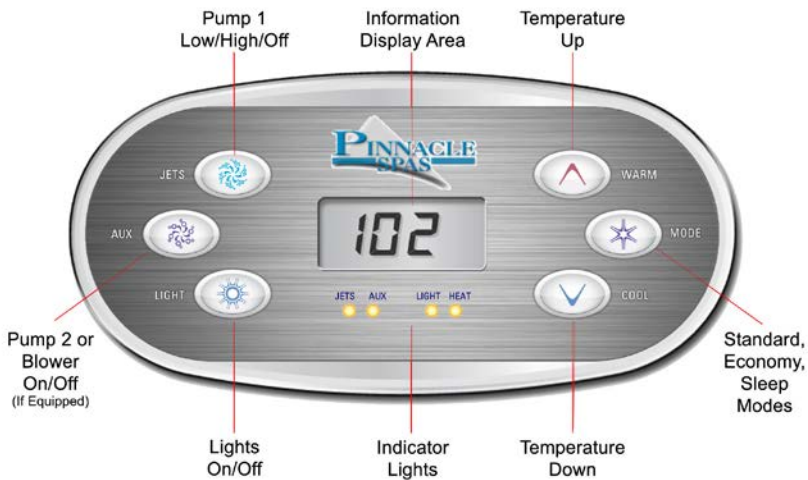

Figure 21 – Topside Callouts for VL600S Controls.
PN740, PN741, PN743, PN850, PN851, and pn855

Initial Start Up

When your hot tub is first actuated, it will go into Priming mode, indicated by “Pr.” The priming mode will last for less than five minutes. Press “WARM” or “COOL” to skip Priming Mode and then the hot tub will begin to heat and maintain the temperature in “Standard Mode.”

Warm/Cool Buttons (LX 8000, LX 9000 and LX 11000) (Set Temperatures between 80°F - 104°F / 26°C - 40°C)

The startup temperature is set at 100°F/37°C. The last measured temperature is constantly displayed on the LCD and is current only when the pump has been running for at least two minutes. To **display** the set temperature, press the "WARM" or "COOL" button once. To **change** the set temperature, press the "WARM" or "COOL" button a second time before the LCD stops flashing. Each press of the "WARM" or "COOL" button will continue to raise/lower the set temperature. After three seconds, the LCD will stop flashing and display the current hot tub temperature.

Temp Button (LX 4000 and LX/DX 5000) (Set Temperatures between 80°F - 104°F / 26°C - 40°C)

To display the set temperature, press the "TEMP" button once. To change the set temperature, press the "TEMP" button a second time. Before the LCD stops flashing, continue to press the "TEMP" button to raise/lower the set temperature. If the opposite direction is desired, release the "TEMP" button and let the screen revert to the current water temperature. Press the "TEMP" button to display the set temperature and again to make the temperature change in the desired direction.

Jets 1 and Jets 2 Buttons

Press the "JETS 1" button once to activate the low speed of Pump 1. Press it a second time to activate the high speed of Pump 1. Press it a third time to turn off Pump 1. If left running, the high speed of Pump 1 automatically will turn off after 15 minutes and the low speed of Pump 1 automatically will turn off after 4 hours.

The low speed of Pump 1 runs when the "JETS 2" Pump 2 is on. It may also active for at least two minutes every half hour to detect the hot tub temperature and then to heat to the set temperature if needed (depending on mode). When the low speed turns on automatically, it cannot be deactivated from the panel, however the high speed may be activated.

Press JETS 2 once to activate Pump 2. Press it again to turn off Pump 2.

Aux Button

Press the "AUX" button once to turn on the Air Jet Bubbler (blower). Press it a second time to turn off the Air Jet Bubbler. If left running, the Air Jet Bubbler automatically will turn off after 15 minutes.

Light

Press the "LIGHT" button once to turn on your hot tub lights. Press the LIGHT button multiple times to cycle through the many available color patterns. Press the LIGHT button again to turn off the LED light system. If left on, the lights automatically turn off after 4 hours.

Mode

Your hot tub operating mode is changed by first pressing the “WARM” or “COLD” button, then pressing the “MODE” button (in the LX 8000, LX 9000 and LX 11000 – and LX 4000 and LX 5000 export) or the “LIGHT” button (in the LX 4000 and LX/DX 5000).

- **Standard Mode** is programmed to constantly maintain the desired temperature. “*Std*” (or “*St*” in the LX 4000 and LX/DX 5000) will be displayed momentarily when you switch into standard mode.
- **Economy Mode** heats the spa to the set temperature *only* during filter cycles. “*Ecn*” (or “*Ec*”) will display solid when temperature is not current and will alternate with temperature when temperature is current.
- **Sleep Mode** heats the hot tub to within 20°F/10°C of the set temperature *only* during filter cycles. “*SLP*” (or “*SL*”) will display solid when temperature is not current and will alternate with temperature when temperature is current.

Preset Filter Cycles

The first filter cycle begins six minutes after the hot tub is energized. The second filter cycle begins 12 hours later. Filter duration is programmable for 2, 4, 6 or 8 hours – or for continuous filtration indicated by “*FILC*” (or “*FC*”). The default filter time is two hours.

To program filter cycles, press “WARM” or “COOL” and then “JETS.” Press “WARM” or “COOL” again to adjust to your desired setting. Press “JETS” again to exit filter cycle programming.

The low speed of the 2-speed pump runs during filtration and the ozonator will be enabled.

Smart Winter Mode



If the system (sensor located inside heater) detects ambient conditions below 44°F/6.7°C, it automatically enters the Smart Winter Mode for period of four minutes after it detects the hot tub temperature has risen to 45°F/7.2°C.

Startup Procedure for all PN Model with Gecko Control



Figure 22 (K450 Topside Control)

1. Go to the topside control panel and look at the display. The spa first goes through a startup sequence after which pump 1 high, pump 2 (if equipped) will run for a one minute purge cycle. Pump 1 (low) will then start in filtration cycle.
2. Press the Jets 1 button. You should hear the two-speed pump turn on at high speed, see water circulating, and see the Jets icon illuminated on the panel.

Caution: If water is not flowing from the hydrotherapy jets after 2 minutes, turn the power off at the main panel and bleed the air from the system (see page 43). Turn the power on again. Sometimes momentarily turning the pump off/on will help prime the pump. Do this no more than three times.

3. If the water is running smoothly through the lines, open the seat(s) manifold air control valves and you should see an increase in jet pressure. Check and adjust the water and airflow of every jet if necessary.

Each direction hydrotherapy jet in your spa can be adjusted for massage intensity and directional flow. Pivot the angle of a jet to achieve an optimal massage.

Adding air mixture intensifies the level of your massage. Turn the seat(s) manifold air control valves counterclockwise to increase the air mixture and clockwise to turn it off.

To minimize heat losses, close all seat(s) manifold air control valves when your spa is not in use.

4. Press the Jets1 button a third time to turn off the two speed pump.

Note: This pump remains on if filtration or heat is needed.

5. Press the Light button to turn on the LED light. Verify that this light is on.
6. Press the Light button a second time to turn off this light.
7. If equipped, press the Jets 2 button. You should hear the second pump turn on, see water circulating, and see the Jets 2 icon illuminated on the panel.

Note: If the water does not move through second pump jets repeat same procedure as for first pump.

8. Press the Jets 2 button again to turn off this pump.

Water Balancing for PN Models

Note: Your Pinnacle Plus (PN model) hot tub comes with a built-in SPA FROG sanitizing system. Depending on the area you live in and the local regulatory rules, your SPA FROG consists of some combination of a mineral cartridge and a bromine cartridge manufactured directly in the plumbing line of your hot tub. Here's how it works:

The SPA FROG In-Line System is made up of (A) a FROG cap that is easily distinguishable among the fittings on the top of the spa, (B) a cartridge holder that pulls out of the system, (C) a mineral cartridge that controls bacteria in the water and (D) a bromine cartridge that helps support the minerals while oxidizing contaminants like body oils. The cartridges are adjustable to meet your specific spa water care needs.

NOTE: See page 66 for a photo of what the Spa Frog In-Line Sanitation System looks like installed in a PN spa.

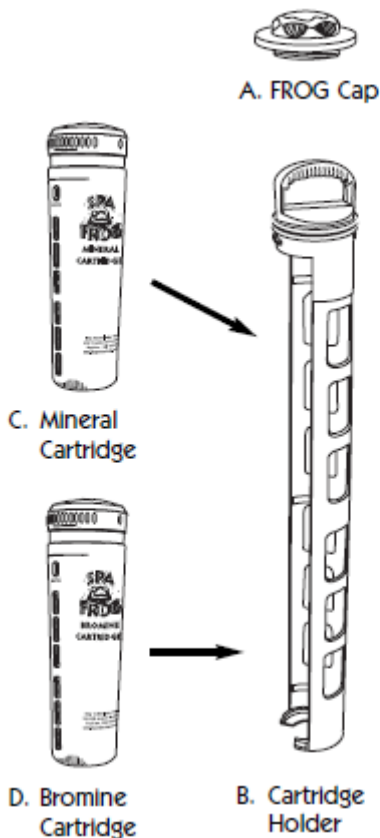

Cut-away view of cartridges snapped into holder and placed into the In-Line System

SPA FROG START UP: After you have filled and balanced the water in your hot tub according to the chart in Table 4, proceed with the SPA FROG as follows:

*NOTE: Bromine levels are lower only when used with FROG minerals. Use a metal out or sequestering agent if fill water is high in metals. Wait 24 hours before continuing start up. Shock hot tub to establish a 1.0-2.0 ppm bromine or chlorine residual. Add directly to hot tub water. Do NOT add through the SPA FROG In-Line System. When spa reaches 95 degrees, set the mineral and bromine cartridges according to the directions below and insert them into the System.

Note: Test strips and water balancing chemicals are available by calling 800.749.8003 or visiting www.hottubparts.com

Test	Range
Total Alkalinity	80-180 ppm
pH	7.2-7.8
Calcium Hardness	150-400 ppm
Bromine	1.0-2.0 ppm

Table 5 - Recommended Ranges for Balanced Water Using Spa Frog

ADJUSTING AND REPLACING SPA FROG BROMINE CARTRIDGE:

As every hot tub is different, finding the right setting for the bromine cartridge will require monitoring your usage for the first week or two. Begin with an initial setting of 3 (if you set your filtration cycle to 1 hour a day) or 2 (if you set your filtration cycle to 2 or more hours a day) and monitor bromine levels before each use. Adjust the cartridge by one setting per use until a 1.0-2.0ppm level has been achieved. To adjust cartridge, remove from system and turn to the next higher setting if the bromine level is low, or the next lower setting if the bromine level is high. The bromine cartridge needs to be replaced when empty. Drain water to ensure empty then discard in trash. On most hot tubs, it will last between 2 – 4 weeks. Always maintain at least 1.0 ppm bromine level.

ADJUSTING AND WHEN TO REPLACE SPA FROG MINERAL

CARTRIDGE: Set SPA FROG Mineral Cartridge wide open on #6 by holding the bottom and turning the top until the number 6 appears in the setting window. The SPA FROG Mineral Cartridge must be replaced every 4 months. After four months of use, or when draining and refilling the hot tub with fresh water, discard SPA FROG Mineral Cartridge in trash even if, upon shaking, it appears there is spent media left inside. Once wetted, the time-released minerals in the cartridge are effective up to four months. Do not attempt to reuse the product once removed from the hot tub. For ease in remembering, mark your calendar.



NOTE: The more you use your Leisure's Edge hot tub, for instance when you first get it, the greater the setting to achieve at least 1.0 ppm will need to be. If usage decreases or the bromine level is greater than 2.0 ppm, the setting should be lowered.

REPLACING SPA FROG CARTRIDGES: WITH JETS TURNED OFF, open cap of the SPA FROG and set aside. Remove holder by pushing down and turning counterclockwise before pulling out. Remove spent cartridges by pushing bottom out through openings in back of holder. Then grab cartridge and pull out.

- Snap the SPA FROG Mineral Cartridge into the area marked "Minerals" (top portion) and the SPA FROG Bromine Cartridge into the area marked "Bromine" (bottom portion) making sure to line up the indentation at the top of the cartridges with the raised area on the holder.



***Placement printed on back of holder**

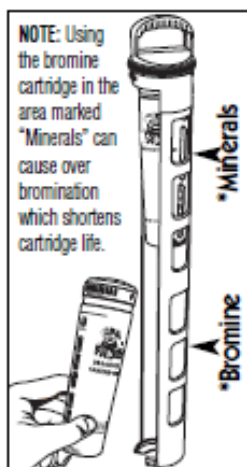

- Slowly insert holder into system. Line up holder arrow-① with system arrow-②. Push down until holder tabs-③ go past system tabs-④ and turn holder to the right (clockwise) until it stops. To ensure a locked position, attempt to pull holder up. If it stays in place, the lock is secure.

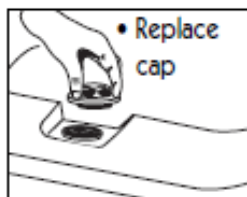
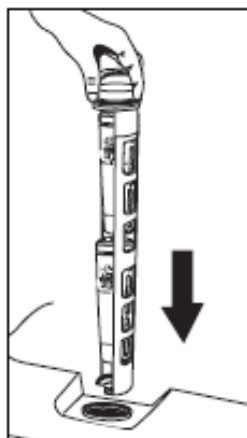
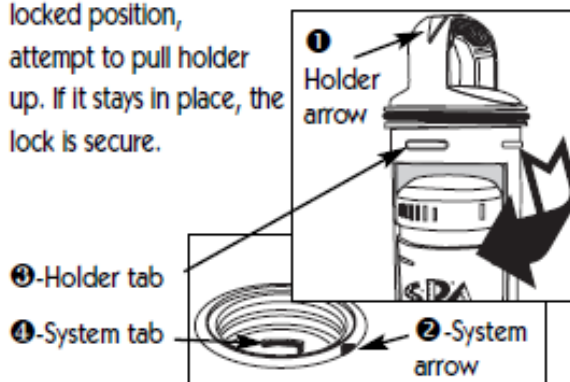

- Begin regular spa care procedures as soon as start-up is complete.

Electronic Controls for PN Models

Your spa is equipped with a full-function in.K450 keypad. Basic operation of this control is provided next.

Spa Functions for Models with Gecko Controls

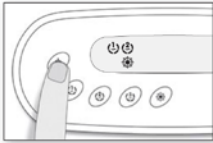

On/Off key

Depending on the spa manufacturer, this key may have different functions: On/Off, Standby mode or quick enable of the Economy mode.

On/Off Mode

By default, the system is always on. Press and hold On/Off key for 5 sec. (or Press and hold Pump 1 key for 5 sec.) to shut the system down for 30 minutes.

The display will toggle between the "OFF" message and water temperature. Press On/Off key to restart the system before the expiration of the 30 minutes delay.



Standby Mode

Quick press and release the On/Off key to shut the system down (i.e. to set it to Standby mode) for 30 minutes. The display will toggle between the "SBY" message and water temperature. All keys are then disabled, unless you press On/Off key again to reactivate the system before the expiration of the 30 minutes delay.

In order to warn the user, the spa light will flash for a few seconds before the exit of Standby mode.



Economy Mode

This mode allows you to lower the temperature set point of the spa by 20 °F (11 °C) during a certain period of the day.

To enable the economy mode: Press and hold On/Off key for 10 sec.

While the Economy mode is enabled the display will toggle between "Eco" and the water temperature. Once the system goes back to normal mode, the display will show "noE".

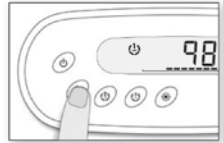

Pump 1 key

Press Pump 1 key to turn Pump 1 on at low speed. Press a second time to turn pump to high speed (with a dual-speed pump). A third time turns pump off.

A built-in timer automatically turns pump off after a predetermined period of time, unless pump has been manually deactivated first.

* If single speed pump: press Pump key to turn pump on. Press Pump key again to turn pump off.

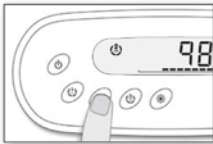

Pump 2 key

Press Pump 2 key to turn Pump 2 on. Press a second time to turn pump off.

A built-in timer automatically turns pump off after a predetermined period of time, unless pump has been manually deactivated first.

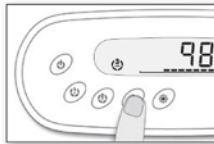

Blower key

Press Blower key to turn blower on. Press a second time to turn blower off.

A built-in timer automatically turns blower off after a predetermined period of time, unless blower has been manually deactivated first.



Light key

Press Light key to turn light on at high intensity. Subsequent presses change light intensity. A last press turns light off.

A built-in timer automatically turns light off after a predetermined period of time, unless it has been manually deactivated first.

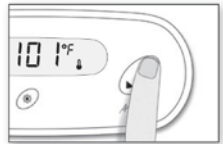

Up/Down keys

Use Up or Down key to set desired water temperature. The temperature setting will be displayed for 5 seconds to confirm your new selection.

The "Set Point" icon indicates that the display shows the desired temperature, NOT the current water temperature!

Programming Steps for Models with Gecko Controls



Program key

Use Program key to display time or enter Programming menu by pressing and holding key. In Programming mode, the following parameters can be set: time, filter cycle start time, filter cycle duration, filter cycle frequency, and temperature unit.

Note: Light key is used as Program key if this key is not present.



Setting the time

Enter Programming mode by holding Prog. key pressed down for 3 sec. The display will show the current time setting.

Setting the hour: Use Up or Down arrows to change hour setting (AM/PM).

Setting the minutes: Press Prog. key a second time.

Use Up or Down key to change hour setting.

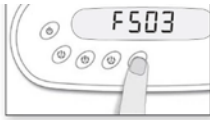

Setting filter cycle start time

To program the filter cycle, you must enter these parameters: the start time, duration and frequency. During a filter cycle, pumps run for one minute to purge the plumbing, then Pump 1 runs for the programmed number of hours.

Press Prog. key a third time. The display will show FSxx, with "xx" representing the starting hour.

Use Up or Down key to change setting.

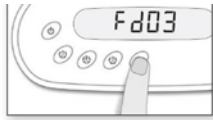

Setting filter cycle duration

Press Prog. key a fourth time.

The display will show Fdxx, with "xx" representing the duration in hours.

Use Up or Down key to change setting.



Filter cycle frequency

Press Prog. key a fifth time.

The display will show FFxx, with "xx" representing the number of filter cycles per day (up to 4).

Use Up or Down key to change setting.

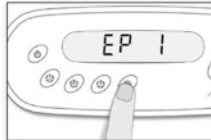

Setting economy mode

Press Prog. key a sixth time. Use Up key to enable the economy mode, the display will show EP 1 or use Down key to disable economy mode, the display will show EP 0.

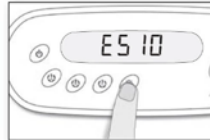

Setting economy start time

Press Prog. key a seventh time. The display will show ESxx, with "xx" representing the starting hour.

Use Up or Down key to change setting.



Setting economy duration

Press and hold Light key until the display shows Edxx, with "xx" representing the duration in hours. (Default: 2 hours).

Use Up or Down key to change setting.
0 = no filtration
24 = continuous filtration



Setting temperature unit

Water temperature can be displayed in either Fahrenheit (°F) or Celsius (°C). Press Prog. key a ninth time. The display will show either °F or °C.

Use Up or Down key to change setting.

Press Prog. key once more to go back to normal mode.

Note: "F" will be displayed in in.xe Spa Packs.

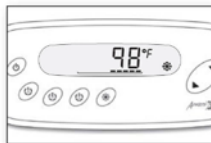

Smart Winter Mode

Our Smart Winter Mode protects your system from the cold by turning pumps on several times a day to prevent water from freezing in pipes.

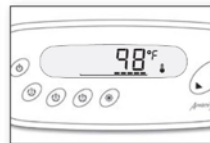

Water temperature regulation

In a regulation cycle, the system first generates water flow through the heater housing and the plumbing, in order to ensure accurate water temperature readings as well as avoiding heater activation in dry conditions.

After verifying pump activation and taking a water temperature reading if required, the system automatically turns the heater on to reach and maintain water temperature at Set Point.

Cooldown

After heating the spa water to the desired Set Point, the heater is turned off, but its associated pump (Pump 1 Low-speed or CP) remains on for a predetermined period of time to ensure adequate cooling of the heating element, this prolongs its useful life. The heater icon flashes during this time.

Low-Level Settings for Models with Gecko Controls

Your spa came from manufacture preprogrammed with the correct low level setting (07, 09).

Once configured and if needed, low level setting can be modified, at any moment by pressing and holding the Jets 1 key on the keypad for 30 seconds. Keypad display will show Lxx where xx is the setting number that was chosen previously.

Use Up/Down key to select a new setting number. Then press Light key to confirm new setting.

If the Light key is not pressed, the 25-second automatic timeout will exit Low level configuration mode without changing any setting.

See below reference table between spa model #, spa equipment and LL configurable options.

Low Level Setting by Model

Model #	LL Configuration	First filtration step (Purge + P1 low)	Cleaning step (Programmable Filter cycle setting default)
PN 740 (1012), PN 741 (1007), PN 743 (1009), PN 855 (1010), PN 850 (1008)	07	Purge for 60sec only	Duration-2hr, Frequency - twice per day
PN 631 (1011)	09	Purge for 60sec only	Duration-2hr, Frequency - twice per day

***Note:** Items with bold text represent settings that are pre-programmed at the factory.

Input Current, Phase Setting for Models with Gecko Controls

These options are accessible by keeping the Light key pressed for 20 seconds. At this point the Input current will displayed. Press Up or Down key to select 10 to 48A current set. (Default setting for US/Canada is 40A). Press Light key again to validate a setting.

***For European spas only.** After Light key pressed for 20 seconds Number phases parameter will displayed. Press Up or Down key to select 1 or 2 phase application. (Default setting is 1 phase). Press Light key again to validate a setting.

Press Light key again. At this point Input current will be displayed. Press Up or Down key to select 16-20 A for dual phases or 10-40A for single phase. (Default setting is 16A for dual phases and 32A for single phase). Press Light key again to validate setting.

Ozone generator (if equipped) will oxidize contaminants present in the water and run with P1 (low) in Filter cycle only. Ozone generator will turn off if there is any user demand for pumps, blower or light and remains off 40 minutes after last user demand.

Filtration, Sanitation for PN Models

The spa water filtration is provided by the low speed of the 2-speed pump. This pump moves the water through the filter cartridge allowing surface dirt to be skimmed. The low speed pump 1 Filter cycle default setting is 2 hours, twice per day. (See programming procedure for details).

Each filter cycle occurs in two steps:

1. Purging Step.
 - a. In Purge step (clean all plumbing lines) all pumps are turned on at high speed for short time (60 seconds).
2. Cleaning Step.
 - a. Pump 1, low speed runs by filter cycle setting.

Ozone generator runs with low speed pump 1.

Setting the Water Temp for PN Models

Use the up / down keys to set the water temperature you desire. The temperature setting displays for five seconds to confirm your new selection. The set point icon indicates that the display shows the desired temperature (not the actual water temperature). The default temperature setting is 95°F.

Error Codes for PN Models with Gecko Control



Should an error occur, the display will show a wrench icon (on the left of the screen) and one of the following error messages will toggle with the clock and the water temperature.

Codes for error in:xe

Description

Hr

Hr
An internal hardware error has been detected in i:xe.
Contact dealer or service supplier.

HL

HL
The system has shut the heater down because the temperature at the heater has reached 119°F (48°C).
Do not enter the water! Remove the spa cover and allow the water to cool down, then shut power off and power your spa up again to reset the system.

AOH

AOH
Temperature inside the spa skirt is too high, causing the internal temperature in the i:xe to increase above normal limits. Open skirt and wait until error clears.

FLO

FLO
The system does not detect any water flow while the primary pump is running.
Check and open water valves. Check for water level.
Clean filter. If the problem persists, call your dealer or service supplier.

Prr

Prr
A problem is detected with the temperature probe.
Call your dealer or service supplier.

OH

OH
The water temperature in the spa has reached 108°F (42°C).
Do not enter the water! Remove the spa cover and allow the water to cool down to a lower temperature. Call your dealer or service supplier if problem persists.

Cover

Place the insulated cover on your hot tub. Keeping the cover in place anytime the hot tub is not in use reduces the heating time and minimizes operating costs. The time required for initial heat-up varies depending on the starting water temperature, ambient temperature, and the capacity of your hot tub.

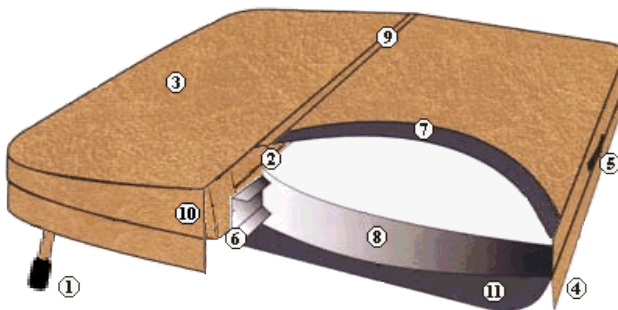

Figure 23 - Cover Callouts

1. Lock-down tab
2. Double-stitched seams
3. Marine-grade cover material
4. Edge overlap material
5. Grip handle
6. Aluminum channel
7. Heat-sealed insulation
8. Chemical-resistant vapor barrier
9. Polystyrene seam stoppers
10. Reinforced edges
11. Breathable underside material



**Figure 24 -
Lockdown Tabs**

Use the lock-down tabs to prevent access to the hot tub by children and to prevent the wind from lifting the cover off.

Sitting, standing, and snow buildup on the cover will break the cover. Dragging it over rough surfaces will scuff or tear the fabric. Always lift by the handles or use the optional cover lift device.

Water Management

Our chemical water purification system is a perfect match for your hot tub.

If your water quality seems improper, increasing the time your hot tub filters the water (see page 26, 29 or 36 depending on your controls) may clear up your problem.

Below are some answers to common water chemistry questions.

pH It is common to have pH fluctuations after adding chemicals to your hot tub or after a party. Let your jets run and give your water time to stabilize. 9 times out of 10, your pH will come back into the 7.4-8.2 range on its own.

Mildew on cover Mildew usually grows in the folds and seams of your cover and then drips into your hot tub water causing cloudiness and/or odor. Clean with our special non-foaming All Purpose Cleaner and then rinse the inside of your cover with clean warm water.

Foamy water	Foam typically results from soap residue on your skin and hair, or laundry detergent residue on clothing. Take a soapless shower and rinse all clothing in warm water prior to bathing.
CLEAR green or brown water	Your “source water” most likely has dissolved heavy metals. When this is the case, use a respected brand of demineralizer found at any local pool/ hot tub store. Using a pre-filter can remove these contaminants before they get into your hot tub (see page 26).
CLOUDY green water	Algae can be resolved by adding a respected brand of algacide.
CLOUDY white water	Although a normal condition immediately after filling that dissipates after time, with stabilized water this is a visual indication that the total alkalinity or pH or both are at improper levels. Test your water weekly and maintain proper water chemistry (see page 28).
Odor and/or cloudy water	If your water develops an odor and/or cloudiness, clean your cover and filters and try increasing the amount of time your hot tub filters per day by turning your filtration cycle time or duration up.
Heavy Use	After a period of heavy use, your hot tub may cloud. Shock your hot tub with 2 ounces of non chlorine shock and wait 36 hours.

Frequently Asked Questions

Who do I call for warranty information or service?

Call our customer care center, at 800.304.9684. Please note, you must register your hot tub within 30 days of purchasing or your warranty will be voided. Our representatives can assist with this process or you can get help online at www.PinnacleSpas.com.

Who are the service companies in my area?

Pinnacle Spas contracts with several service companies in your area to ensure the best possible response time. Our customers are guaranteed to receive service response priority. If you encounter a matter that can't be easily resolved over the phone, a local technician can be dispatched to your home. The service technician may assess reasonable travel charges during on-site repairs. Call our customer care center, at 800.304.9684.

What happens when my warranty expires?

Pinnacle Spas will continue to provide service for your hot tub after your warranty has expired via our customer care center at 800.304.9684.

Are the jets removable? Interchangeable? Replaceable?

Most jets are made removable and adjustable for customized hydrotherapy.

How often should I drain my hot tub?

You should drain and refill your hot tub every 1-3 months depending on usage. Every other time you drain and refill, you should also replace the filters and wipe down the hot tub (see page 44).

How do I adjust my jet?

Simply turn the jets counterclockwise to open and clockwise to close. Be careful not to overturn the jets, as damage can occur.

⚠ Caution: Do not turn off too many jets at the same time. This will create backflow and possible damage to your hot tub!

How do I bleed air from my system?

When draining and refilling your hot tub, the pump may become air locked. Air-locked pumps stop water from flowing in your hot tub and is easily resolved by bleeding off the trapped air. To do this:

- Turn off the GFCI breaker
- Open the access panel below the topside control panel
- Loosen a heater union until you hear the trapped air escape
- Once water drips out in a continuous stream, hand tighten the union until the water stops leaking
- Loosen the discharge union on Pump 2 (if equipped) as above
- Turn on all pumps to make sure that there are no leaks
- Put the access panels back on
- Turn on the GFCI breaker

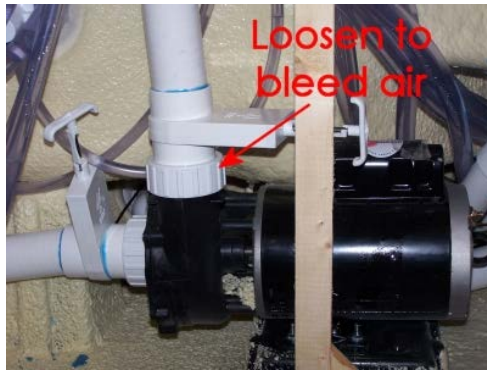

Figure 25 - Bleeding Air

How do I use aromatherapy (if equipped)?

- Remove scented bead cartridge from plastic cover.
- Twist off aromatherapy injector valve cap located on top of hot tub.
- With the scented bead cartridge in your hand, splash water into it from your other hand.
- Insert cartridge into the injector.
- Replace cap and tighten.



Turning on the pump activates the aromatherapy via the jets.

What is the insulation made of?

We use a Thermazone™ process to fully insulate all of our hot tubs. First, the bottom of each shell is blanketed with a thick layer of solid-cell, high-density insulating foam. Second, a blanket layer of insulation is added and wrapped around the entire interior of the cabinet.

Third, an air-tight base prevents heat loss. Fourth, a 5-inch thick insulating cover is included.



How should I clean my hot tub?

Use non-sudsing cleaners and non-oily polishes (see page 54). Our All Purpose Cleaner quickly removes scum lines and helps restore your shell's original beauty. Rinse all filters, covers, pillows, and surfaces thoroughly with warm tap water. Our Filter Cleanser is a safe, effective way to clean and re-use your filters and our Plumbing Cleanser cleans the inside of all plumbing in your hot tub. Call 800.304.9684 to order these easy-to-use cleaning products.

Where can I get more Chemicals or other accessories?

Visit www.hottubparts.com or call 800.304.9684.

Troubleshooting

If a problem arises, you can check this list for a quick solution. If this does not resolve your problem, please call our customer care center, at 800.304.9684. Additional information is also available at www.PinnacleSpas.com. You will need your serial number to access this site.

Important – Most problems can be quickly resolved by resetting the GFCI breaker. Try this first before proceeding.

PROBLEM	CAUSE	SOLUTION	
Breaker trips	Wiring error	Load Neutral wire not connected to GFCI (connected to Neutral bus)	
	Wrong GFCI	GFCI breaker is wrong size	
	Ozonator (or blower) wet	Remove tube from ozonator (or blower) and allow 2 days to dry out	
Foamy water	Soaps, skin oils, or undissolved sanitizer particles	Close the air control valves and allow filtration cycle to run Add defoamer Drain and clean your hot tub Clean or change filters Rinse all bathing suits before bathing	
	Leak	Loose connection	Check and hand-tighten unions at heater & pumps, or clamps on jets
		Drain open	Close drain valve or replace cap
	Light doesn't	LED burnt out	Replace bulb

PROBLEM	CAUSE	SOLUTION
work	Loose wire	Check wiring harness to LED
	Loose plug	Reseat J20 plug on hot tub pack
Low/no jet pressure	Air lock	Bleed air from the system (page Error! Bookmark not defined.)
	Dirty filter	Check and clean or replace filter
	Closed jets	Open all jets by turning CCW
	Closed valves	Open all T-handle shutoff valves on heater and pumps
	ACV open	Close air control valves
	Low water	Fill hot tub 1" above all jets
Moved my hot tub and now it doesn't work	Wiring error at GFCI	Check Neutral wiring of GFCI (see diagrams on pages 11-20)
	No power to hot tub	Reset circuit breakers on GFCI panel and main circuit breaker panel
Nothing works	Breaker has tripped	Check and reset breaker. If problem persists, check for loose electrical connections. Check for Neutral wiring error at GFCI.
	Fuse blown	Check for blown Fuse 4 (F4) inside of spa pack.
Pump not running	No power to hot tub	Reset circuit breakers on GFCI panel and main circuit breaker panel
Water does not flow	Air lock	Bleed air from the system (page Error! Bookmark not defined.)
	Closed jets	Open all jets by turning counterclockwise
Water too hot	ACV open	Close air control valves
	High set temperature	Turn down set temperature on topside control panel
	High ambient temperature	Remove the cover
Water will not heat	Thermostat is set too low	Check and reset to desired temperature
	Air open	Close air control valve
	Dirty filter	Check and clean filter
	Blown fuse	Check and replace fuse
	Slide valve closed	Check and open all valves
	Cover off	Put the cover back on
	Hot tub in Economy mode	Press the Standby button and take out of Economy (see <i>Economy Mode</i> on pages 28)

Error Codes for all Models with Balboa Control

MESSAGE	MEANING	ACTION REQUIRED
<i>(none)</i>	No message on display. Power has been cut off to hot tub.	The control panel will be disabled until power returns. Hot tub settings are preserved.
OHH HH	The hot tub has shut down from high heat detection. One of the sensors detected 118°F (48°C) at the heater.	Do not enter the water. Remove the cover and allow the water to cool. Once cool, push any button. If the hot tub does not reset, turn off the GFCI and call service.
OHS OH	The hot tub has overheated and shut down. One of the sensors detected that the hot tub water is 110°F (43°C).	Do not enter the water. Remove the cover and allow the water to cool. At 107°F (42°C), the hot tub resets automatically. If the hot tub does not reset, turn off the GFCI and call service.
ICE IC	Potential freeze condition detected (Ice)	No action required. The pump will automatically operate regardless of the hot tub status.
SnA SA	Sensor A is not working correctly. Hot tub is shut down.	Check the sensor "A" plug connection to circuit board. The problem may appear temporarily in an overheat situation and disappear when the heater cools. If the problem persists, contact service.
SnB SB	Sensor B is not working correctly. Hot tub is shut down.	Check the sensor "B" plug connection to circuit board. The problem may appear temporarily in an overheat situation and disappear when the heater cools. If the problem persists, contact service.
SnS Sn	Sensors are out of balance.	If this alternates with the temperature, it may be temporary. If the display shows only this message (periodically blinking), the hot tub is shut down. If the problem persists, contact service.

MESSAGE	MEANING	ACTION REQUIRED
HFL HL	A substantial difference between sensors was detected (possible flow problem).	Check water level in hot tub and add water if necessary. Be sure that slide-valves are open. Make sure the pump is primed and has power. If the problem persists, contact service.
LF	<i>Low Flow</i> – persistent problem. Displays after the fifth occurrence of the "HL" message within 24 hours. Heater shuts down but other hot tub functions run normally.	Heating ability of the hot tub will not reset automatically; press any button to reset.
dr	Inadequate water, poor flow, or air bubbles detected in the heater. Hot tub is shut down for 15 minutes.	Check the water level and add water if necessary. Be sure that slide-valves are open. Make sure the pump is primed and has power. Press any button to reset (automatically reset within 15 minutes). If the problem persists, contact service.
drY dy	Inadequate water detected in heater. Displays on third occurrence of "dr" message. Hot tub is shut down.	Check water level in hot tub. Add water if necessary. Be sure that slide-valves are open. Make sure the pump is primed and has power. Press any button to reset.
Pr	When your hot tub is first activated, it goes into Priming mode.	The Priming mode runs for up to four minutes and then the hot tub begins to heat and maintain the water temperature in Standard mode.
-- F	Temperature unknown	After the pump has been running for two minutes, the temperature will be displayed.
-- C	Temperature unknown	After the pump runs for two minutes, the temperature displays

NOTE: SEE ALSO PAGE 39 FOR PN MODELS ERROR CODES.

Maintenance and Care

Important – The warranty on your hot tub and equipment depends on proper sanitation (see page 25). In addition, the following maintenance procedures must be followed periodically.

Cabinets

Your cabinet is made from a polymer that combines the durability of plastic with the beauty of simulated wood. To clean the cabinet, a mild soap and water solution easily removes residue.

Cover

The 5-inch thick tapered cover on your hot tub is made from a weatherproof marine-grade vinyl. Your cover will last much longer if you heed the following suggestions:

- 1) Don't drag the cover on the ground; wearing of the vinyl could easily develop into a tear.
- 2) The insulating foam in your cover is not designed to hold the weight of a person or an animal.

Important – Cracked foam in the cover is not covered under warranty! Do not stand on it.

- 3) Occasionally clean the inside of your cover with our special All Purpose Cleaner rinsed with warm water. (Using soap or vinyl cleaners on the inside of your cover causes foamy water.) Call our order line at 800.304.9684 to order our All Purpose Cleaner.
- 4) Our special Vinyl Cover Cleaner applied to the outside of the cover and stitching once yearly will keep your cover looking better longer. Call our order line at 800.304.9684 to order our special Vinyl Cover Cleaner.
- 5) Do not lift the cover by the safety straps, they are made to secure the tub to the cabinet and may tear.

Draining and Refilling



Figure 26 - Drain Operation

- 1) Turn off the GFCI breaker.
- 2) Remove hot tub cover and allow water to cool down.
- 3) Select a safe, suitable drainage area capable of safely assimilating 300 plus gallons of water that may contain unsanitary contaminants and chemical residue that could cause harm to plants or grass.
- 4) Locate drain valve at front of the hot tub (see page 24). Hold the rear body to prevent it from turning, then loosen and remove the front cap.
- 5) Attach a garden hose to the exposed threads and route the hose downhill to your drainage area.
- 6) Twist the drain fitting 1/3 turn counterclockwise to unlock the drain valve and pull it outward to open completely. The water will drain by gravitational flow.
- 7) After the hot tub drains, perform steps 3-5 in reverse order to close the drain prior to refilling hot tub.
- 8) Attach the garden hose to a thoroughly-flushed pre-filter (not included, rinsed of all residual sediment) and refill your hot tub through the filtration canister.
- 9) After refilling, turn on the GFCI breaker to the hot tub.

If the pump runs but no water flows, see page 43 to see how to bleed air from the system.

Filters

The filters in your hot tub should be removed and cleaned every 2 weeks with our special Filter Cleanser and typically replaced every 4-6 months (depending upon use). You can clean your filters with the water pressure from the end of a garden hose then rinsed with warm water. This ensures that the water is being filtered properly.

DO NOT USE BLEACH. We recommend having replacement filters on hand that can be swapped between cleanings. Doing so enables you to quickly exchange the dirty filters with clean ones and immediately start your hot tub again. Call our order line at 800.304.9684 to order replacement filters and our special Filter Cleanser.

Jets

Remove and clean the jets as needed using our special Plumbing Cleanser, water, and a cloth or soft-bristled brush. Call our order line at 800.304.9684 to order our special Plumbing Cleanser.

Light

Drain the hot tub and clean the light lens as needed using an optical cloth and an eyewear cleaning product specifically designed not to scratch optical surfaces. If the back side of the lens is also dirty remove the rear panel, remove the light from the holder, and clean in this same manner.

Pillows

Remove and clean the headrest pillows as needed using our special All Purpose Cleaner and rinsed thoroughly with warm water. Call our order line at 800.304.9684 to order our special All Purpose Cleaner.

Sanitation

Sanitation level is influenced by two factors:

1. Filter Cycle (filtration) time (see page 26, 29 or 36 depending on your controls)
2. How much you use your hot tub each week

If your water chemistry and water clarity are all proper and your sanitation level is still too low/high, you can adjust the sanitation intensity up/down by adding more/less sanitizer a little at a time and testing the water again after two days.

Surface

The acrylic surface of your hot tub should be cleaned with recommended cleaners and thoroughly rinsed with warm (not cold) water before refilling. (See also page 44.) Call our order line at 800.304.9684 to order cleaners.

-  **Warning:** NEVER use paint solvents, acids, acetone, benzene, lacquer thinner, toluene, xylene, or similar chemicals to clean your hot tub shell.

Water

Depending on usage, the water in your hot tub should be changed every 1-3 months. Upon each change of water it is a good practice to wipe down the hot tub.

Shutdown / Winterizing



Your Pinnacle hot tub is designed to operate year round. If you plan to leave your hot tub unused for long periods of time in severely cold weather, you should winterize your hot tub to avoid accidental freezing due to a power or equipment failure.

We highly recommend that you have a hot tub professional winterize and restart your hot tub.

⚠ WARNING: Damage from improperly winterizing or restarting your hot tub is not covered under your warranty. You can call our customer care center, at 800.304.9684 for recommended service organizations to assist you in properly winterizing your hot tub.

Glossary

Blower	A heavy duty motor which aerates the water with millions of tiny bubbles throughout the hot tub providing soft tissue massage.
Drain Bib	A male garden-hose-style fitting to which a garden hose is connected for draining water.
GFCI	Ground Fault Circuit Interrupter. A special type of circuit breaker designed to shut power off if there is a leak of electricity detected in the hot tub equipment.
Ionizer	See <i>Ozonator</i> .
Jet	A plumbing device that directs pressurized air and/or water to desired areas of a hot tub.
Ozonator	An electronic unit designed to purify and destroy algae, bacteria, mold, and viruses while prolonging equipment life.
Ozone (O₃)	Produced by an Ozonator, Ozone is a form of oxygen (O ₂) and is a powerful oxidizing agent used to destroy organic waste and byproducts and help in the control of algae and bacteria. Ozone is not a stand-alone sanitizer.
pH	The scientific scale for measuring Hydrogen Ion concentration (0 to 14) that shows the acid/alkaline content in water.
Pump	The electrical component that keeps water moving throughout the entire circulation system.
RCD	Residual Current Device (European models). A special type of circuit breaker designed to shut power off if there is a leak of electricity detected in the hot tub equipment.
Spa Pack	The main control box that operates the electrical systems within the hot tub.
Topside Control	The user-interface panel that connects to the control box and controls various hot tub functions such as jet pumps and heater.

Specifications

LX 11000 (Model 1002)

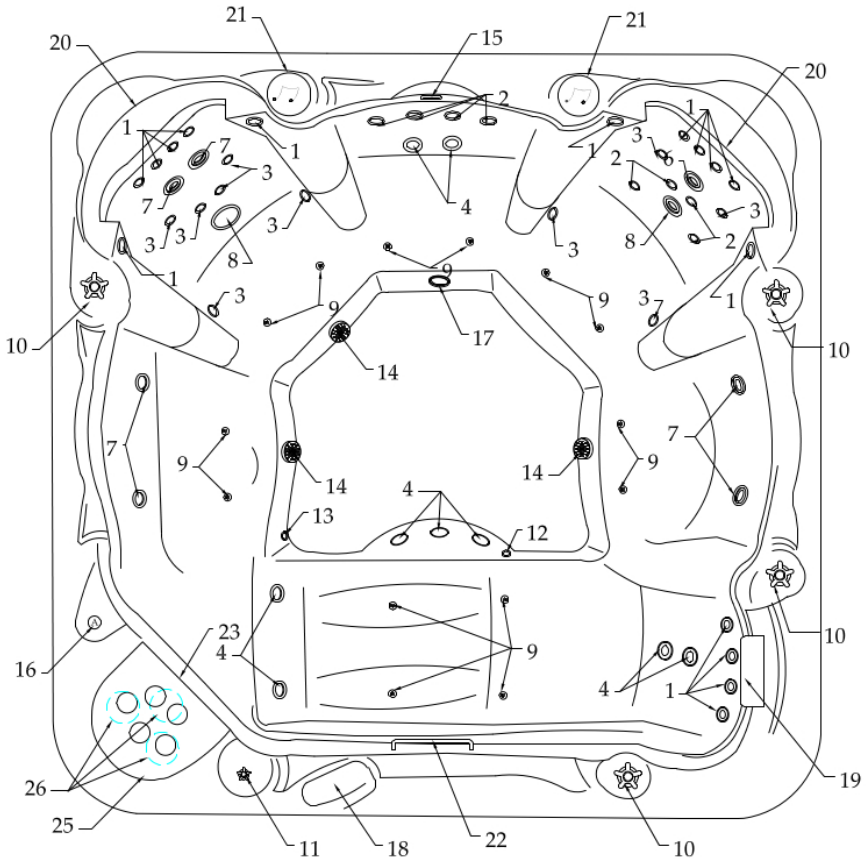

Specifications*

Spa Specs	
Spa Model	1002PN/LX11000
Spa Dimension	94"x94"x34"
Number Of Seats	6
Water Jets	53
Air Jets	14(OPTION)
Water Capacity (USG/L)	450/1703
Dry Weight (LBS/KG)	900/408
Filled Weight (LBS/KG)	4647/2108
Electrical Rating (VAC/AMP/HZ)	240/48/60
GFCI (AMP)	60

* Specifications are subject to change without notice.

Label	Part#	Description	Qty.	Notes
1A	820478, 606475, 608476	Assy. ozone cluster(s.s. face, body, 90 ell)	0	
1	209520-011-500, 1276, 29222-289-300	Jet PrLc, Jet Int. Directional, 2" (SS/Silv/GpGu/GpGy); Compensator Ring 2" 200s LED Tw Lk Body 3/4"sb x 3/8" sb)	16	
2	209520-021-500, 1276, 29222-289-300	Jet PrLc, Jet Int. Roto, 2" (SS/Silv/GpGu/GpGy); Compensator Ring 2" 200s LED Tw Lk Body 3/4"sb x 3/8" sb)	8	
3	209530-011-500, 1282, 29232-289-300	Jet PrLc, Jet Int. Directional, 3" (SS/Silv/GpGu/GpGy); Compensator Ring 3" 300s LED Tw Lk Body 3/4"sb x 3/8" sb)	10	
4	209540-011-500, 1287, 29242-289-300	Jet PrLc, Jet Int. Directional, 4" (SS/Silv/GpGu/GpGy); Compensator Ring 4" 400s LED Tw Lk Body 3/4"sb x 3/8" sb)	9	
5	209540-1011-500, 1287, 29242-289-300	Jet PrLc, Jet Int. 4-Roto, 4" (SS/Silv/GpGu/GpGy); Compensator Ring 4" 400s LED Tw Lk Body 3/4"sb x 3/8" sb)	0	
7	209550-011-500, 1292, 29252-289-300	Jet PrLc, Jet Int. Directional, 5" (SS/Silv/GpGu/GpGy); Compensator Ring 5" 500s LED Tw Lk Body 3/4"sb x 3/8" sb)	6	
8	209550-101-500, 1292, 29252-289-300	Jet PrLc, Jet Int. 4-Roto, 5" (SS/Silv/GpGu/GpGy); Compensator Ring 5" 500s LED Tw Lk Body 3/4"sb x 3/8" sb)	2	
9	23004-107-000 (7822)	Air Injector (Graphite)	14	OPTION
10	25059-101-000	1" Air control, Halo, GPlS/GP	4	
11	25056-111-000	1" on-off Valve, Halo GPlS/GP	1	
12	7818	Ozone wall fitting(Gr)	1	
13	7818, 7819	Floor Drain (Graphite), Drain Valve, Economy	1	
14	640-3789GADSGV	Suction VGB, (GR)	3	
15	620081	Waterfal Assy w. metal Blade, 6"	1	
16	23040-007-000	Aroma Therapy Injector (Gr), Cartridge	1	OPTON
17	1219, 218-6680, 7096	Light Kit 5", 5" comp. ring, LED light	1	
18	50015-05, 13309	Topside TP600CE, Overlay PN	1	
19	823090	Pillow small (Gr)	1	
20	823089	Pillow large (Gr)	2	
21				
22	611115	Hand rail ss large	1	
23	822817	Weir door	1	
24	822142	Filter Lid (Gr) (Large 5-cups)	1	
25	822070	50 sq. ft. Cartridge Filter	2	
N/A	1016205-NHP	2 speed Pump w. AMP 10' cord	1	
N/A	1016019-NHP	1 speed Pump w. AMP 10' cord	1	
N/A	700-3102-68X	Blower w. cord AMP 6' cord	1	OPTION
N/A	56713	Equipment Pack BP501X	1	
N/A	5071, 7399	Ozonator, Cord 4', injector 884-K	1	
N/A	xxxx	Spa Cover (94-1/2"x 94-1/2"xR12")	1	
N/A	7636, 7876A	Owner's Manual, insert	1	Pinnacle

LX 9000 (Model 1003)

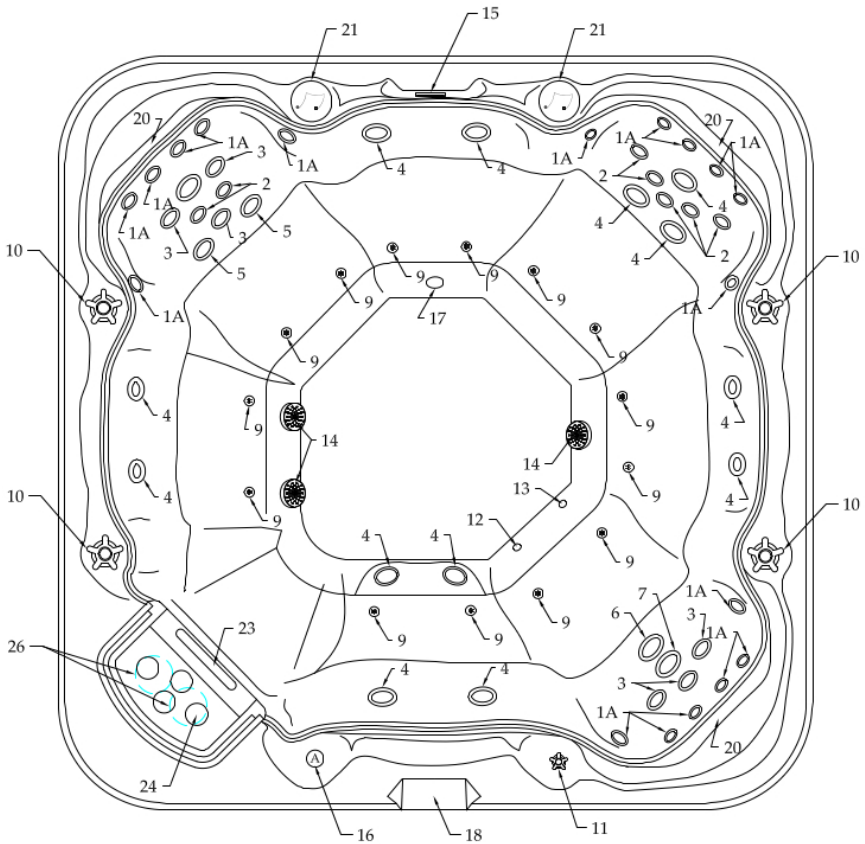

Specifications*

Spa Specs	
Spa Model	1003PN/LX9000
Spa Dimension	84"x84"x34"
Number Of Seats	7
Water Jets	50
Air Jets	14(OPTION)
Water Capacity (USG/L)	350/1325
Dry Weight (LBS/KG)	745/338
Filled Weight (LBS/KG)	3666/1663
Electrical Rating (VAC/AMP/HZ)	240/48/60
GFCI (AMP)	60

* Specifications are subject to change without notice.

Label	Part#	Description	Qty.	Notes
1A	820478, 606475, 608476	Assy. ozone cluster(s.s. face, body, 90 ell)	0	
1	209520-011-500, 1276, 29222-289-300	Jet Pt.Lc, Jet Int. Directional, 2" (SS/Silv/GpGu/GpGy); Compensator Ring 2" 200s LED Tw Lk Body 3/4"sb x 3/8" sb)	18	
2	209520-021-500, 1276, 29222-289-300	Jet Pt.Lc, Jet Int. Roto, 2" (SS/Silv/GpGu/GpGy); Compensator Ring 2" 200s LED Tw Lk Body 3/4"sb x 3/8" sb)	7	
3	209530-011-500, 1282, 29232-289-300	Jet Pt.Lc, Jet Int. Directional, 3" (SS/Silv/GpGu/GpGy); Compensator Ring 3" 300s LED Tw Lk Body 3/4"sb x 3/8" sb)	6	
4	209540-011-500, 1287, 29242-289-300	Jet Pt.Lc, Jet Int. Directional, 4" (SS/Silv/GpGu/GpGy); Compensator Ring 4" 400s LED Tw Lk Body 3/4"sb x 3/8" sb)	14	
5	209540-1011-500, 1287, 29242-289-300	Jet Pt.Lc, Jet Int. 4-Roto, 4" (SS/Silv/GpGu/GpGy); Compensator Ring 4" 400s LED Tw Lk Body 3/4"sb x 3/8" sb)	2	
7	209550-011-500, 1292, 29252-289-300	Jet Pt.Lc, Jet Int. Directional, 5" (SS/Silv/GpGu/GpGy); Compensator Ring 5" 500s LED Tw Lk Body 3/4"sb x 3/8" sb)	1	
8	209550-101-500, 1292, 29252-289-300	Jet Pt.Lc, Jet Int. 4-Roto, 5" (SS/Silv/GpGu/GpGy); Compensator Ring 5" 500s LED Tw Lk Body 3/4"sb x 3/8" sb)	0	
9	23004-107-000 (7822)	Air Injector (Graphite)	14	OPTION
10	25059-101-000	1" Air control, Halo, GP/Sil/GP	4	
11	25056-111-000	1" on-off Valve, Halo, GP/Sil/GP	1	
12	7818	Ozone w all fitting(Gr)	1	
13	7818, 7819	Floor Drain (Graphite), Drain Valve, Economy	1	
14	640-3789GADSGV	Suction VGB, (GR)	3	
15	620081	Waterfal Assy w. metal Blade, 6"	1	
16	23040-007-000	Aroma Therapy Injector (Gr), Cartridge	1	OPTION
17	1219, 218-6680, 7096	Light Kit 5", 5" comp. ring, LED light	1	
18	50015-05, 13309	Topside TP600CE, Overlay PN	1	
19	823090	Pillow small (Gr)	0	
20	823089	Pillow large (Gr)	3	
21				
22	611115	Hand rail ss large	0	
23	822817	Weir door	1	
24	822073	Filter Lid(Gr)	1	
25	822070	50 sq. ft. Cartridge Filter	2	
N/A	1016205-NHP	2 speed Pump w. AMP 10' cord	1	
N/A	1016019-NHP	1 speed Pump w. AMP 10' cord	1	
N/A	700-3102-68X	Blower w. cord AMP 6' cord	1	OPTION
N/A	56713	Equipment Pack BP501X	1	
N/A	5071, 7399	Ozonator, Cord 4', injector 884-K	1	
N/A	7988	Spa Cover (84-1/2"x84-1/2"xR12")	1	
N/A	7636, 7876A	Owner's Manual, insert	1	Pinnacle

LX 8000 (Model 1001)

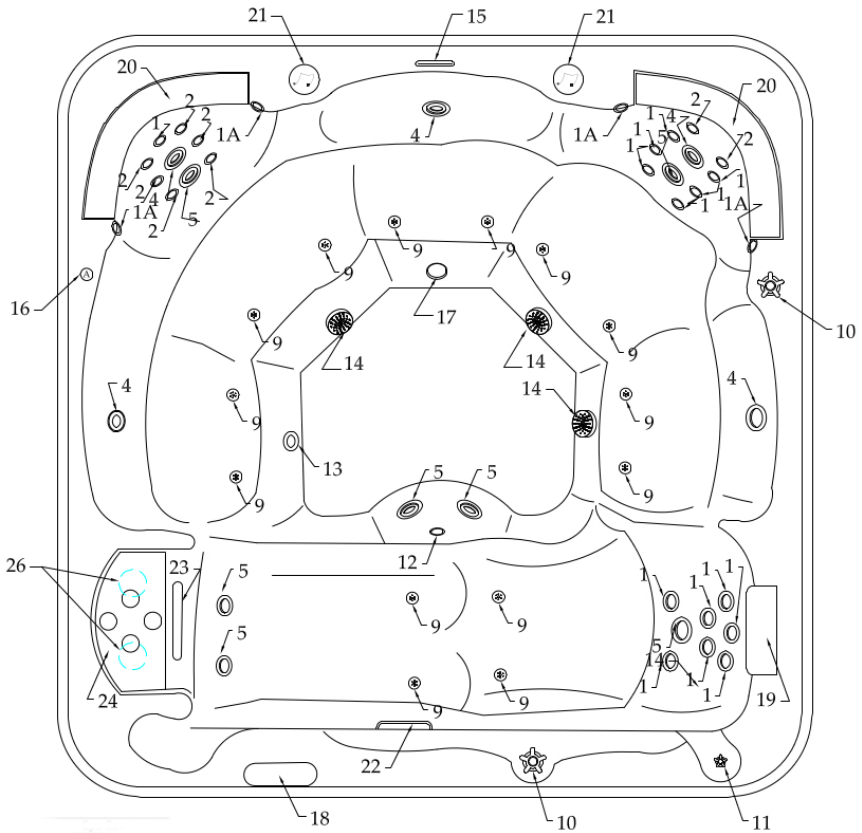

Specifications*

Spa Specs	
Spa Model	1001PN/LX8000
Spa Dimension	84"x84"x34"
Number Of Seats	6
Water Jets	39
Air Jets	14 (OPTION)
Water Capacity (USG/L)	350/1325
Dry Weight (LBS/KG)	680/308
Filled Weight (LBS/KG)	3595/1630
Electrical Rating (VAC/AMP/HZ)	240/48/60
GFCI (AMP)	60

* Specifications are subject to change without notice.

Call-Outs				
Label	Part#	Description	Qty.	Notes
1A	820478, 606475, 608476	Assy. ozone cluster(s.s. face, body, 90 ell)	4	
1	209520-011-500, 1276, 29222-289-300	Jet PrLc. Jet Int. Directional, 2" (SS/Silv/GpGu/GpGy); Compensator Ring 2" 200s LED Tw Lk Body 3/4"sb x 3/8" sb)	14	
2	209520-021-500, 1276, 29222-289-300	Jet PrLc. Jet Int. Roto, 2" (SS/Silv/GpGu/GpGy); Compensator Ring 2" 200s LED Tw Lk Body 3/4"sb x 3/8" sb)	8	
3	209530-011-500, 1282, 29232-289-300	Jet PrLc. Jet Int. Directional, 3" (SS/Silv/GpGu/GpGy); Compensator Ring 3" 300s LED Tw Lk Body 3/4"sb x 3/8" sb)	0	
4	209540-011-500, 1287, 29242-289-300	Jet PrLc. Jet Int. Directional, 4" (SS/Silv/GpGu/GpGy); Compensator Ring 4" 400s LED Tw Lk Body 3/4"sb x 3/8" sb)	5	
5	209540-1011-500, 1287, 29242-289-300	Jet PrLc. Jet Int. 4-Roto, 4" (SS/Silv/GpGu/GpGy); Compensator Ring 4" 400s LED Tw Lk Body 3/4"sb x 3/8" sb)	7	
7	209550-011-500, 1292, 29252-289-300	Jet PrLc. Jet Int. Directional, 5" (SS/Silv/GpGu/GpGy); Compensator Ring 5" 500s LED Tw Lk Body 3/4"sb x 3/8" sb)	0	
8	209550-101-500, 1292, 29252-289-300	Jet PrLc. Jet Int. 4-Roto, 5" (SS/Silv/GpGu/GpGy); Compensator Ring 5" 500s LED Tw Lk Body 3/4"sb x 3/8" sb)	0	
9	23004-107-000 (7822)	Air Injector (Graphite)	14	OPTION
10	25059-101-000	1" Air control, Halo, GP/SA/GP	2	
11	25056-111-000	1" on-off Valve, Halo GP/SA/GP	1	
12	7818	Ozone wall fitting(Gr)	1	
13	7818, 7819	Floor Drain (Graphite), Drain Valve, Economy	1	
14	640-3789GADSGV	Suction VGB, (GR)	3	
15	620081	Waterfal Assy w. metal Blade, 6"	1	
16	23040-007-000	Aroma Therapy Injector (Gr), Cartridge	1	OPTION
17	1219, 218-6680, 7096	Light Kit 5", 5" comp. ring, LED light	1	
18	50015-05, 13309	Topside TP600CE, Overlay PN	1	
19	823090	Pillow small (Gr)	1	
20	823089	Pillow large (Gr)	2	
21				
22	611115	Hand rail ss large	1	
23	822817	Weir door	1	
24	822073	Filter Lid(Gr)	1	
25	822070	50 sq. ft. Cartridge Filter	2	
26				
29				
N/A	1016205-NHP	2 speed Pump w. AMP 10' cord	1	
N/A	1016019-NHP	1 speed Pump w. AMP 10' cord	1	
N/A	700-3102-68X	Blow er w. cord AMP 6' cord	1	OPTION
N/A	56713	Equipment Pack BP501X	1	
N/A	5071, 7399	Ozonator, Cord 4', injector 884-K	1	
N/A	7988	Spa Cover (84-1/2"x84-1/2"xR12")	1	
N/A	7636, 7676A	Owner's Manual, insert	1	Pinnacle

LX 5000 (Model 1004)

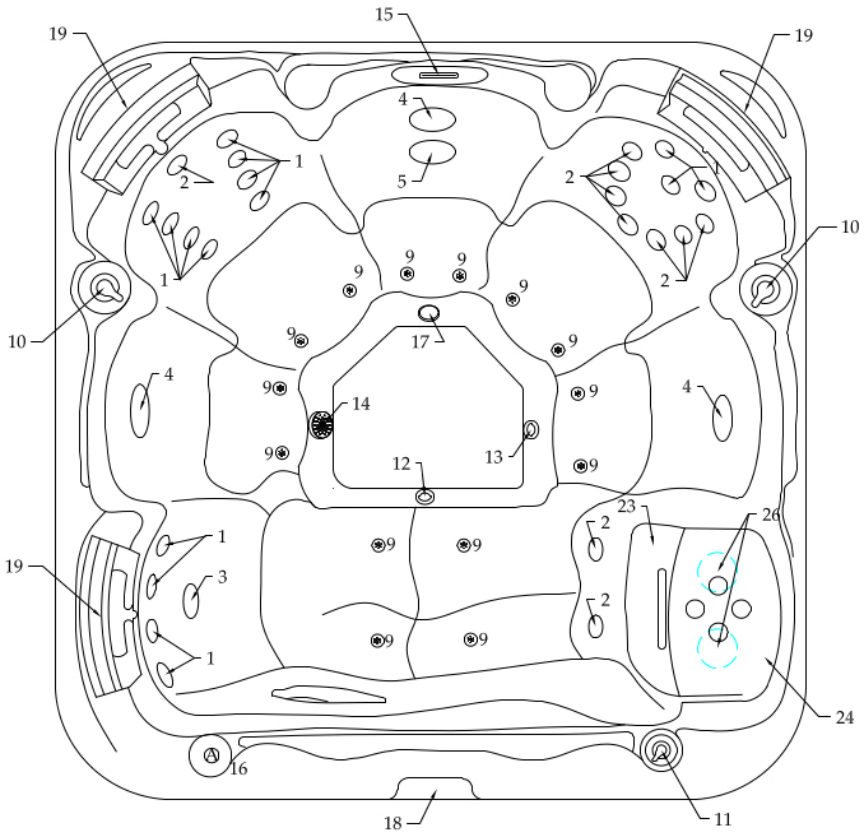

Specifications*

Spa Specs	
Spa Model	1004PN/LX5000
Spa Dimension	79"x79"x34"
Number Of Seats	6
Water Jets	31
Air Jets	14(OPTION)
Water Capacity (USG/L)	255/965
Dry Weight (LBS/KG)	555/252
Filled Weight (LBS/KG)	2682/1216
Electrical Rating (VAC/AMP/HZ)	240/40/60
GFCI(AMP)	50

* Specifications are subject to change without notice.

Label	Part#	Description	Qty.	Notes
1A	820478, 606475, 608476	Assy. ozone cluster(s.s. face, body, 90 ell)	0	
1	209520-011-500, 1276, 29222-289-300	Jet PrLc, Jet Int. Directional, 2" (SS/Silv/GpGu/GpGy); Compensator Ring 2" 200s LED Tw Lk Body 3/4"sb x 3/8" sb)	15	
2	209520-021-500, 1276, 29222-289-300	Jet PrLc, Jet Int. Roto, 2" (SS/Silv/GpGu/GpGy); Compensator Ring 2" 200s LED Tw Lk Body 3/4"sb x 3/8" sb)	8	
3	209530-011-500, 1282, 29232-289-300	Jet PrLc, Jet Int. Directional, 3" (SS/Silv/GpGu/GpGy); Compensator Ring 3" 300s LED Tw Lk Body 3/4"sb x 3/8" sb)	2	
4	209540-011-500, 1287, 29242-289-300	Jet PrLc, Jet Int. Directional, 4" (SS/Silv/GpGu/GpGy); Compensator Ring 4" 400s LED Tw Lk Body 3/4"sb x 3/8" sb)	4	
5	209540-1011-500, 1287, 29242-289-300	Jet PrLc, Jet Int. 4-Roto, 4" (SS/Silv/GpGu/GpGy); Compensator Ring 4" 400s LED Tw Lk Body 3/4"sb x 3/8" sb)	2	
7	209550-011-500, 1292, 29252-289-300	Jet PrLc, Jet Int. Directional, 5" (SS/Silv/GpGu/GpGy); Compensator Ring 5" 500s LED Tw Lk Body 3/4"sb x 3/8" sb)	0	
8	209550-101-500, 1292, 29252-289-300	Jet PrLc, Jet Int. 4-Roto, 5" (SS/Silv/GpGu/GpGy); Compensator Ring 5" 500s LED Tw Lk Body 3/4"sb x 3/8" sb)	0	
9	23004-107-000 (7822)	Air injector (Graphite)	14	OPTION
10	25059-101-000	1" Air control, Halo, GPSil/GP	2	
11	25056-111-000	1" on-off Valve, Halo GPSil/GP	1	
12	7818	Ozone wall fitting(Gr)	1	
13	7818, 7819	Floor Drain (Graphite), Drain Valve, Economy	1	
14	640-3789GADSGV/	Suction VGB, (GR)	1	
15	620081	Waterfal Assy w . metal Blade, 6"	1	
16	23040-007-000	Aroma Therapy injector (Gr), Cartridge	1	OPTION
17	1219, 218-6680, 7096	Light Kit 5", 5" comp. ring, LED light	1	
18	50015-05, 13309	Topside TP600CE, Overlay PN	1	
19	823090	Pillow small (Gr)	3	
20	823089	Pillow large (Gr)	0	
21				
22	611115	Hand rail ss large	1	
23	822817	Weir door	1	
24	822073	Filter Lid(Gr)	1	
25	822070	50 sq. ft. Cartridge Filter	2	
N/A	1016205-NHP	2 speed Pump w . AMP 10' cord	1	
N/A	1016019-NHP	1 speed Pump w . AMP 10' cord	0	
N/A	700-3102-68X	Blower w . cord AMP 6' cord	1	OPTION
N/A	56713	Equipment Pack BP501X	1	
N/A	5071, 7399	Ozonator, Cord 4', injector 884-K	1	
N/A	xxxx	Spa Cover (79-1/2"x 79-1/2"xR12")	1	
N/A	7636, 7876A	Owner's Manual, insert	1	Pinnacle

LX 4000 (Model 1006)

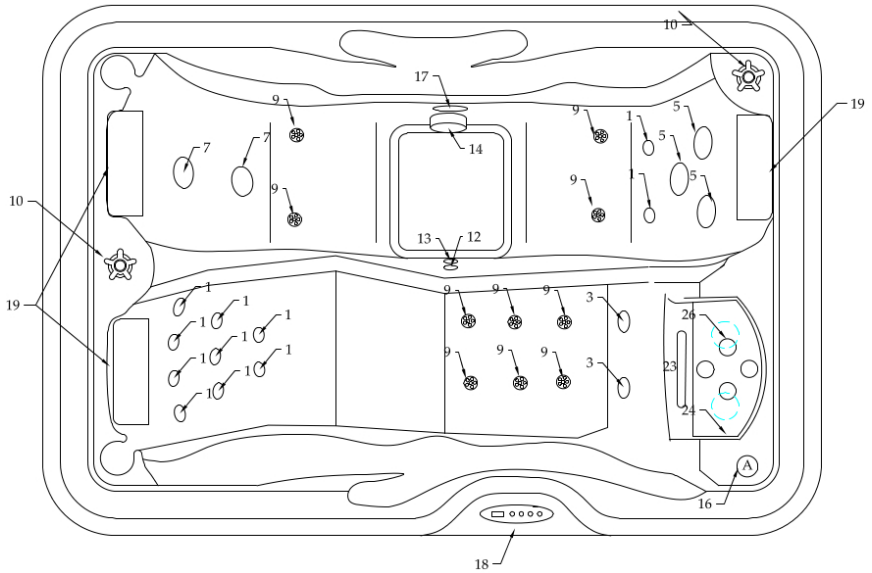

Specifications*

Spa Specs	
Spa Model	1006PN/LX4000
Spa Dimension	86"x58"x30"
Number Of Seats	3
Water Jets	19
Air Jets	10(OPTION)
Water Capacity (USG/L)	175/662
Dry Weight (LBS/KG)	480/218
Filled Weight (LBS/KG)	1940/880
Electrical Rating (VAC/AMP/HZ)	240/40A/60Hz
GFCI (AMP)	50

* Specifications are subject to change without notice.

Call-Outs				
Label	Part#	Description	Qty.	Notes
1A	820478, 606475, 606476	Assy. ozone cluster(s.s. face, body, 90 ell)	0	
1	209520-011-500, 1276, 29222-289-300	Jet P/Lc, Jet Int. Directional, 2" (SS/Silv/GpGu/GpGy); Compensator Ring 2" 200s LED Tw Lk Body 3/4"sb x 3/8" sb)	11	
2	209520-021-500, 1276, 29222-289-300	Jet P/Lc, Jet Int. Roto, 2" (SS/Silv/GpGu/GpGy); Compensator Ring 2" 200s LED Tw Lk Body 3/4"sb x 3/8" sb)	0	
3	209530-011-500, 1282, 29232-289-300	Jet P/Lc, Jet Int. Directional, 3" (SS/Silv/GpGu/GpGy); Compensator Ring 3" 300s LED Tw Lk Body 3/4"sb x 3/8" sb)	2	
4	209540-011-500, 1287, 29242-289-300	Jet P/Lc, Jet Int. Directional, 4" (SS/Silv/GpGu/GpGy); Compensator Ring 4" 400s LED Tw Lk Body 3/4"sb x 3/8" sb)	2	
5	209540-1011-500, 1287, 29242-289-300	Jet P/Lc, Jet Int. 4-Roto, 4" (SS/Silv/GpGu/GpGy); Compensator Ring 4" 400s LED Tw Lk Body 3/4"sb x 3/8" sb)	1	
7	209550-011-500, 1292, 29252-289-300	Jet P/Lc, Jet Int. Directional, 5" (SS/Silv/GpGu/GpGy); Compensator Ring 5" 500s LED Tw Lk Body 3/4"sb x 3/8" sb)	2	
8	209550-101-500, 1292, 29252-289-300	Jet P/Lc, Jet Int. 4-Roto, 5" (SS/Silv/GpGu/GpGy); Compensator Ring 5" 500s LED Tw Lk Body 3/4"sb x 3/8" sb)	0	
9	23004-107-000 (7822)	Air Injector (Graphite)	10	OPTION
10	25059-101-000	1" Air control, Halo, GFSil/GP	2	
11	25056-111-000	1" on-off Valve, Halo GFSil/GP	0	
12	7818	Ozone wall fitting(Gr)	1	
13	7818, 7819	Floor Drain (Graphite), Drain Valve, Economy	1	
14	640-3789GADSGV	Suction VGB, (GR)	1	
15	620081	Waterfal Assy w. metal Blade, 6"	0	
16	23040-007-000	Aroma Therapy Injector (Gr), Cartridge	1	OPTION
17	1219, 218-6680, 7096	Light Kit 5", 5" comp. ring, LED light	1	
18	50015-05, 13309	Topside TP600CE, Overlay FN	1	
19	823090	Pillow small (Gr)	3	
20	823089	Pillow large (Gr)	0	
21				
22	611115	Hand rail ss large	0	
23	822817	Weir door	1	
24	822073	Filter Lid(Gr)	1	
25	822070	50 sq. ft. Cartridge Filter	2	
N/A	1016205-NHP	2 speed Pump w. AMP 10' cord	1	
N/A	1016019-NHP	1 speed Pump w. AMP 10' cord	0	
N/A	700-3102-68X	Blower w. cord AMP 6' cord	1	OPTION
N/A	56713	Equipment Pack BP501X	1	
N/A	5071, 7399	Ozonator, Cord 4', injector 884-K	1	
N/A	xxxx	Spa Cover (85-3/4"x 58-3/4"xR12")	1	
N/A	7636, 7676A	Owner's Manual, insert	1	Pinnacle

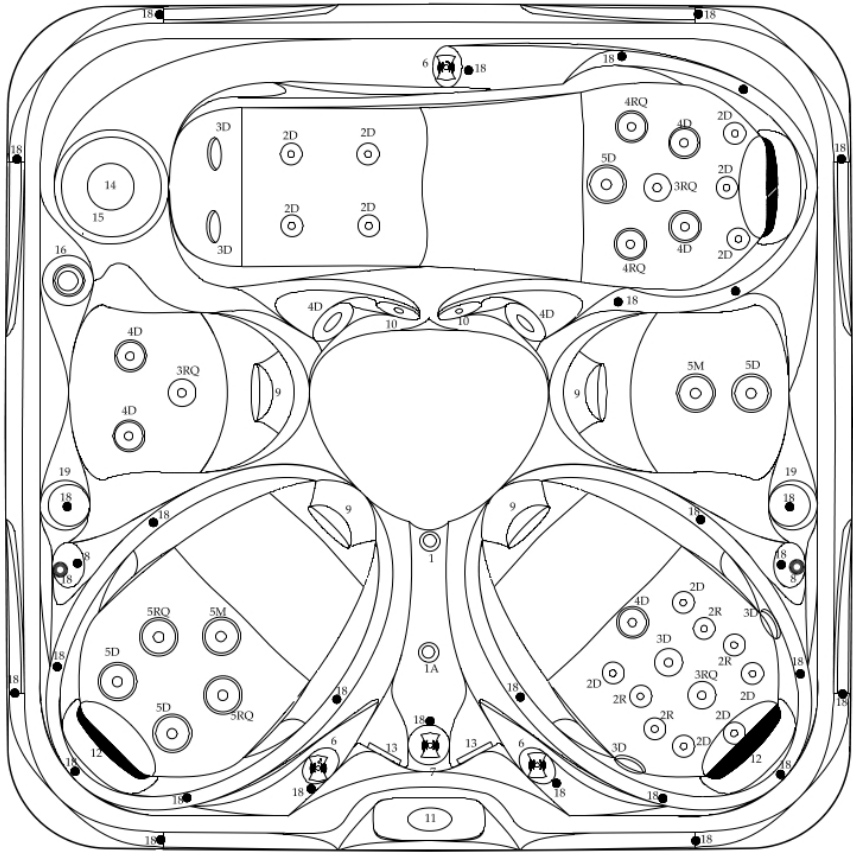

Specifications*

Spa Spec	
Spa Model	PN741(1007PN)
Spa Dimension	84"x84"x36"
Number Of Seats	5 (Lounge)
Water Jets	41
Air Jets	0
Water Capacity (USG/L)	343/1298
Dry Weight (LBS/KG)	840/380
Filled Weight (LBS/KG)	3699/1678
Electrical Rating (VAC/AMP/HZ)	240/50/60
GFCI (AMP)	60

* Specifications are subject to change without notice.

Call-Outs					
Label	Part#	Description	Qty.	Notes	
1,1A	073199W, 7818, 7379	Nozzle wall fitting, Floor Drain/Wall fitting (Gr), Drain Valve, Economy	1+1+1		
2D	29520-011-500, 1276, 29222-289-300	2" PrLc Jet Int(Hlo, Dir. (SS/Siv/GpGyGpGy); 200s Typhon Jet body Compensator Ring, 200s LED TwLk Body (3/4"sbx3/8"sb)	12		
2R	29520-021-500, 1276, 29222-289-300	2" PrLc Jet Int(Hlo, Roto (SS/Siv/GpGyGpGy); 200s Typhon Jet body Compensator Ring, 200s LED TwLk Body (3/4"sbx3/8"sb)	4		
3D	29530-111-500, 1282, 29232-289-200	3" PrLc Jet Int(Hlo, Dir. (SS/Siv/GpGyGpGy); 300s Typhon Jet body Compensator Ring, 300s LED TwLk Body (3/4"sbx3/8"sb)	5		
3RQ	29530-101-500, 1282, 29232-289-200	3" PrLc Jet Int(Hlo, 4-roto (SS/Siv/GpGyGpGy); 300s Typhon Jet body Compensator Ring, 300s LED TwLk Body (3/4"sbx3/8"sb)	3		
4D	29540-011-500, 1287, 29242-289-200	4-1/2" PrLc Jet Int(Hlo, Dir. (SS/Siv/GpGyGpGy); 400s Typhon Jet body Compensator Ring, 400s LED TwLk Body (3/4"sbx3/8"sb)	7		
4RQ	29540-101-500, 1287, 29242-289-200	4-1/2" PrLc Jet Int(Hlo, 4-Roto(SS/Siv/GpGyGpGy); 400s Typhon Jet body Compensator Ring, 400s LED TwLk Body (3/4"sbx3/8"sb)	2		
5D	29550-011-500, 1292, 29252-289-200	5" PrLc Jet Int(Hlo, Roto(SS/Siv/GpGyGpGy); 500s Typhon Jet body Compensator Ring, 500s LED TwLk Body (3/4"sbx3/8"sb)	4		
5RQ	29550-101-500, 1292, 29252-289-200	5" PrLc Jet Int(Hlo, 4-Roto(SS/Siv/GpGyGpGy); 500s Typhon Jet body Compensator Ring, 500s LED TwLk Body (3/4"sbx3/8"sb)	2		
5M	29550-041-500, 1292, 29252-289-200	5" PrLc Jet Int(Hlo, Mass. (SS/Siv/GpGyGpGy); 500s Typhon Jet body Compensator Ring, 500s LED TwLk Body (3/4"sbx3/8"sb)	2		
6	25059-101-000, 25090-089-200	1" Air Control, Halo, GP/Sil/GP with LED bezel	3		
7	25056-111-000, 25030-089-200	1" On-Off Control, Halo, GP/Sil/GP with LED bezel	1		
8	25269-602-700	Laminar spa fountain, Halo	2		
9	640-3789GADSGV	Suction VGB (Gr)	4		
10	3113	Light Kit 3"	2		
11	50015-05, 13309	TP600CE, overlay Pinnacle	1/1		
12	3133	Pillow	3		
13	3135	2.5" Speaker Round	2		
14	1298	Elite skim filter(Gr)	1		
15	1298-A	50 sq. ft. Cartridge Filter	1	Service part	
16	1251, 1252, 01-14-3879	Spa Frog in-line Assy, cap, cartridges	1		
17	1299	4" sconce waterfall w. LED	0		
18	1310A, 1315, 1312A, 1318A, 1317, 3126, 3129, 3130, 25243-600-000	LED controller, 9LED light, 6LED spyder, 2-LED spyder, Cable Assy. 48", 1" FRST lens, nut, o-ring, oval light	1/2/5/1/14 /2/3/4		
19	25241-507-800	Led Deco Cup Holder	2		
N/A	7136, 6022, 310-0140	2 Speed Motor; 6' cord ; Wet end 0140;	1		
N/A	7135, 6024, 310-0140	1 Speed Motor; 8' cord ; Wet end 0140;	1		
N/A	56713	Pack BP501X	1		
N/A	5071, 7399	Ozonator, Injector,	1		
N/A	7636, 7876A	Owner's Manual, insert	1	Pinnacle	
N/A	7988	Spa Cover (84-1/2"x84-1/2"x R10)	1		
N/A	5955, 5954, 5956	Subwoofer 150wt w. harness, power supply 100-240vac, i-pod docking station	1		

PN 850 (Model 1008)

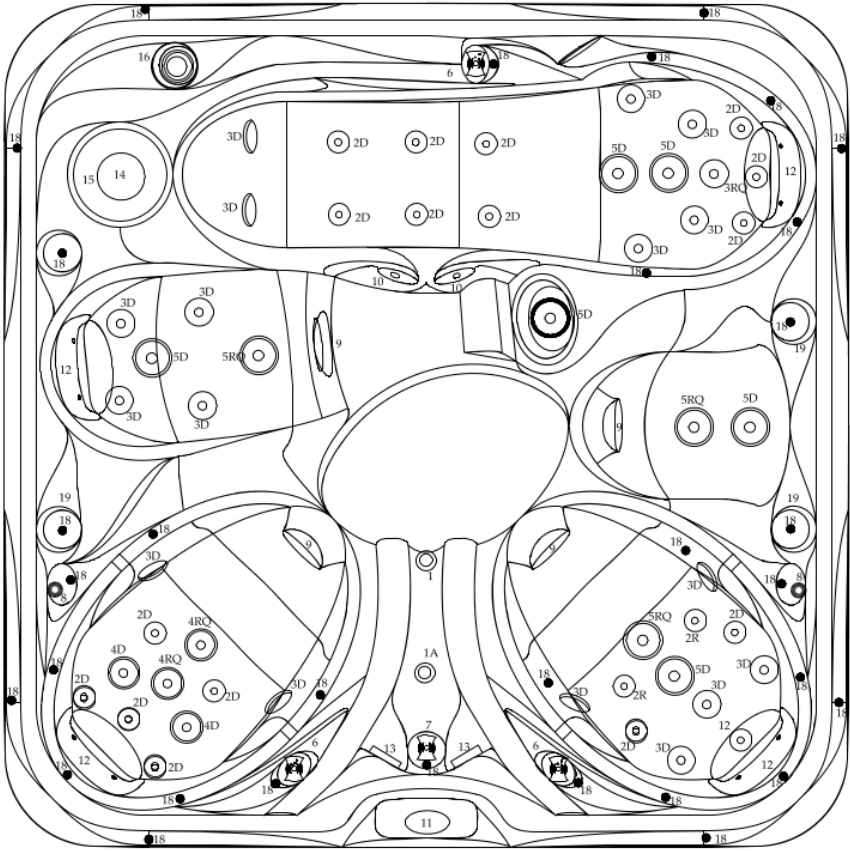

Specifications*

Spa Spec	
Spa Model	PN850(1008PN)
Spa Dimension	91"x91"x36"
Number Of Seats	5 (2 Lounges)
Water Jets	50
Air Jets	0
Water Capacity (USG/L)	403/1526
Dry Weight (LBS/KG)	900/408
Filled Weight (LBS/KG)	4264/1934
Electrical Rating (VAC/AMP/HZ)	240/50/60
GFCI (AMP)	60

* Specifications are subject to change without notice.

		Call-Outs		
Label	Part#	Description	Qty.	Notes
1,1A	073199W, 7818, 7379	Nozzle wall fitting, Floor Drain/Wall fitting (Gr), Drain Valve, Economy	2	
2D	29520-011-500, 1276, 29222-289-300	2" PrLc Jet Int(Hlo, Dir. (SS/Siv/GpGyGpGy); 200s Typhon Jet body Compensator Ring, 200s LED TwLk Body (3/4"sb3/8"sb)	17	
2R	29520-021-500, 1276, 29222-289-300	2" PrLc Jet Int(Hlo, Roto (SS/Siv/GpGyGpGy); 200s Typhon Jet body Compensator Ring, 200s LED TwLk Body (3/4"sb3/8"sb)	2	
3D	29530-111-500, 1282, 29232-289-200	3" PrLc Jet Int(Hlo, Dir. (SS/Siv/GpGyGpGy); 300s Typhon Jet body Compensator Ring, 300s LED TwLk Body (3/4"sb3/8"sb)	17	
3RQ	29530-101-500, 1282, 29232-289-200	3" PrLc Jet Int(Hlo, 4-roto (SS/Siv/GpGyGpGy); 300s Typhon Jet body Compensator Ring, 300s LED TwLk Body (3/4"sb3/8"sb)	1	
4D	29540-011-500, 1287, 29242-289-200	4-1/2" PrLc Jet Int(Hlo, Dir. (SS/Siv/GpGyGpGy); 400s Typhon Jet body Compensator Ring, 400s LED TwLk Body (3/4"sb3/8"sb)	2	
4RQ	29540-101-500, 1287, 29242-289-200	4-1/2" PrLc Jet Int(Hlo, 4-Roto(SS/Siv/GpGyGpGy); 400s Typhon Jet body Compensator Ring, 400s LED TwLk Body (3/4"sb3/8"sb)	2	
5D	29550-011-500, 1292, 29252-289-200	5" PrLc Jet Int(Hlo, Roto(SS/Siv/GpGyGpGy); 500s Typhon Jet body Compensator Ring, 500s LED TwLk Body (3/4"sb3/8"sb)	6	
5RQ	29550-101-500, 1292, 29252-289-200	5" PrLc Jet Int(Hlo, 4-Roto(SS/Siv/GpGyGpGy); 500s Typhon Jet body Compensator Ring, 500s LED TwLk Body (3/4"sb3/8"sb)	3	
5M	29550-041-500, 1292, 29252-289-200	5" PrLc Jet Int(Hlo, Mess (SS/Siv/GpGyGpGy); 500s Typhon Jet body Compensator Ring, 500s LED TwLk Body (3/4"sb3/8"sb)	0	
6	25059-101-000, 25090-089-200	1" Air Control, Halo, GP/Siv/GP with LED bezel	3	
7	25056-111-000, 25030-089-200	1" On-Off Control, Halo, GP/Siv/GP with LED bezel	1	
8	25269-602-700	Laminar spa fountain, Halo	2	
9	640-3789GADSGV	Suction VGB (Gr)	4	
10	3113	Light Kit 3"	2	
11	50015-05, 13309	TP600CE, overlay Pinnacle	1/1	
12	3133	Pillow	4	
13	3135	2.5" Speaker Round	2	
14	1298	Elite skim filter(Gr)	1	
15	1298-A	50 sq. ft. Cartridge Filter	1	
16	1251, 1252, 01-14-3879	Spa Frog in-line Assy, cap, cartridges	1	
17	1299	4" sconce waterfall w. LED	0	
18	1310A, 1315, 1312A, 1318A, 1317, 3126, 3129, 3130, 25243-600-000	LED controller, 9LED light, 6LED spyder, 2-LED spyder, Cable Assy, 48", 1" FRST lens, nut, o-ring, oval light	12/5/1/23 /334	
19	25241-507-800	Led Deco Cup Holder	4	
N/A	7136, 6022, 310-0140	2 Speed Motor; 6' cord ; Wet end 0140;	1	
N/A	7135, 6024, 310-0140	1 Speed Motor; 8' cord ; Wet end 0140;	1	
N/A	56713	Pack BP501X	1	
N/A	5071, 7399	Ozonator, injector,	1	
N/A	7636, 7876A	Owner's Manual, insert	1	Pinnacle
N/A	7986	Spa Cover (84-1/2"x84-1/2"xR10)	1	
N/A	5955, 5954, 5956	Subwoofer 150wt w. harness, power supply 100-240vac, i-pod docking station	1	

PN 743 (Model 1009)

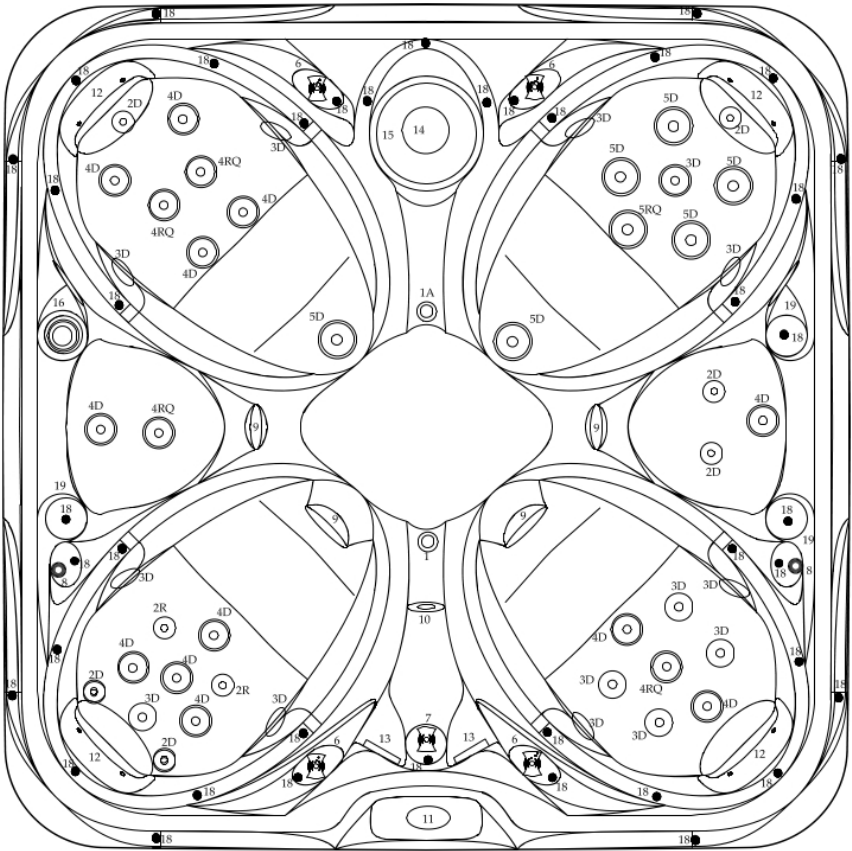

Specifications*

Spa Spec	
Spa Model	PN743(1009PN)
Spa Dimension	84"x 84"x 36"
Number Of Seats	6
Water Jets	43
Air Jets	0
Water Capacity (USG/L)	327/1238
Dry Weight (LBS/KG)	845/383
Filled Weight (LBS/KG)	3574/1621
Electrical Rating (VAC/AMP/HZ)	240/50/60
GFCI (AMP)	60

* Specifications are subject to change without notice.

Call-Outs				
Label	Part#	Description	Qty.	Notes
1,1A	073199W, 7818, 7379	Nozzle wall fitting, Floor Drain/Wall fitting (Gr), Drain Valve, Economy	2	
2D	29520-011-500, 1276, 29222-289-300	2" PrLc Jet Int(Hlo, Dir. (SS/Siv/GpGyGpGy); 200s Typhon Jet body Compensator Ring, 200s LED TwLk Body (3/4"sbx3/8"sb)	6	
2R	29520-021-500, 1276, 29222-289-300	2" PrLc Jet Int(Hlo, Roto (SS/Siv/GpGyGpGy); 200s Typhon Jet body Compensator Ring, 200s LED TwLk Body (3/4"sbx3/8"sb)	2	
3D	29530-111-500, 1282, 29232-289-200	3" PrLc Jet Int(Hlo, Dir. (SS/Siv/GpGyGpGy); 300s Typhon Jet body Compensator Ring, 300s LED TwLk Body (3/4"sbx3/8"sb)	14	
3RQ	29530-101-500, 1282, 29232-289-200	3" PrLc Jet Int(Hlo, 4-roto (SS/Siv/GpGyGpGy); 300s Typhon Jet body Compensator Ring, 300s LED TwLk Body (3/4"sbx3/8"sb)	0	
4D	29540-011-500, 1287, 29242-289-200	4-1/2" PrLc Jet Int(Hlo, Dir. (SS/Siv/GpGyGpGy); 400s Typhon Jet body Compensator Ring, 400s LED TwLk Body (3/4"sbx3/8"sb)	12	
4RQ	29540-101-500, 1287, 29242-289-200	4-1/2" PrLc Jet Int(Hlo, 4- Roto(SS/Siv/GpGyGpGy); 400s Typhon Jet body Compensator Ring, 400s LED TwLk Body (3/4"sbx3/8"sb)	4	
5D	29550-011-500, 1292, 29252-289-200	5" PrLc Jet Int(Hlo, Roto(SS/Siv/GpGyGpGy); 500s Typhon Jet body Compensator Ring, 500s LED TwLk Body (3/4"sbx3/8"sb)	6	
5RQ	29550-101-500, 1292, 29252-289-200	5" PrLc Jet Int(Hlo, 4- Roto(SS/Siv/GpGyGpGy); 500s Typhon Jet body Compensator Ring, 500s LED TwLk Body (3/4"sbx3/8"sb)	1	
5M	29550-041-500, 1292, 29252-289-200	5" PrLc Jet Int(Hlo, Mass.(SS/Siv/GpGyGpGy); 500s Typhon Jet body Compensator Ring, 500s LED TwLk Body (3/4"sbx3/8"sb)	0	
6	25059-101-000, 25090-089-200	1" Air Control, Halo, GP/Sil/GP with LED bezel	4	
7	25056-111-000, 25030-089-200	1" On-Off Control, Halo, GP/Sil/GP with LED bezel	1	
8	25269-602-700	Laminar spa fountain, Halo	2	
9	640-3789GADSGV	Suction VGB (Gr)	4	
10	3113	Light Kit 3"	1	
11	50015-05, 13309	TP600CE, overlay Pinnacle	1/1	
12	3133	Pillow	4	
13	3135	2.5" Speaker Round	2	
14	1298	Elite skim filter(Gr)	1	
15	1298-A	50 sq. ft. Cartridge Filter	1	
16	1251, 1252, 01-14-3879	Spa Frog in-line Assy, cap, cartridges	1	
17	1299	4" sconce waterfall w. LED	0	
18	1310A, 1315, 1312A, 1318A, 1317, 3126, 3129, 3130, 25243-600-000	LED controller, 9-LED light, 6LED spyder, 2- LED spyder, Cable Assy. 48", 1" FRST lens, nut, o-ring, oval light	1/17/2/31 /41/4	
19	25241-507-800	Led Deco Cup Holder	3	
N/A	7136, 6022, 310-1740	2 Speed Motor; 6' cord ; Wet end 1740;	1	
N/A	7135, 6024, 310-1740	1 Speed Motor; 8' cord ; Wet end 1740;	1	
N/A	56713	Pack BP501X	1	
N/A	5071, 7399	Ozonator, Injector,	1	
N/A	7636, 7876A	Owner's Manual, insert	1	Pinnacle
N/A	7988	Spa Cover (84-1/2"x84-1/2"xR10)	1	
N/A	5955, 5954, 5956	Subwoofer 150wt w. harness, power supply 100-240vac, i-pod docking station	1	

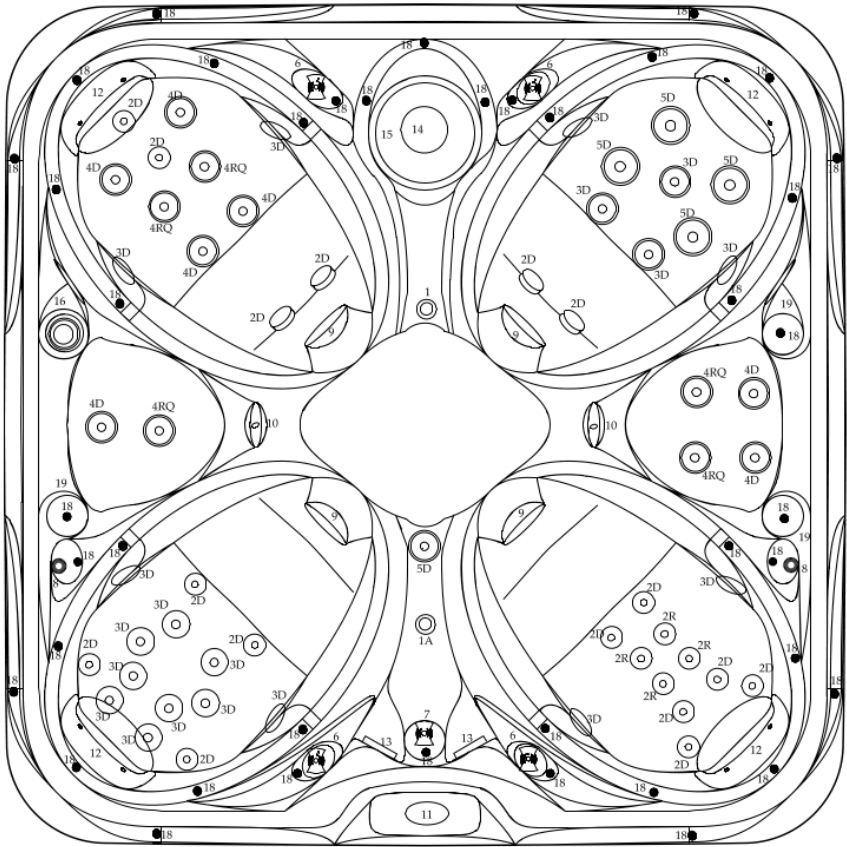

Specifications*

Spa Spec	
Spa Model	PN855(1010PN)
Spa Dimension	91"x 91"x 36"
Number Of Seats	6
Water Jets	55
Air Jets	0
Water Capacity (USG/L)	424/1605
Dry Weight (LBS/KG)	906/411
Filled Weight (LBS/KG)	4445/2016
Electrical Rating (VAC/AMP/HZ)	240/50/60
GFCI (AMP)	60

* Specifications are subject to change without notice.

		Call-Outs		
Label	Part#	Description	Qty.	Notes
1,1A	073199W, 7818, 7379	Nozzle wall fitting, Floor Drain/Wall fitting (Gr), Drain Valve, Economy	2	
2D	29520-011-500, 1276, 29222-289-300	2" PrLc Jet Int(Hlo, Dir. (SS/Siv/GpGyGpGy); 200s Typhon Jet body Compensator Ring, 200s LED TwLk Body (3/4"sbx3/8"sb)	16	
2R	29520-021-500, 1276, 29222-289-300	2" PrLc Jet Int(Hlo, Roto (SS/Siv/GpGyGpGy); 200s Typhon Jet body Compensator Ring, 200s LED TwLk Body (3/4"sbx3/8"sb)	4	
3D	29530-111-500, 1282, 29232-289-200	3" PrLc Jet Int(Hlo, Dir. (SS/Siv/GpGyGpGy); 300s Typhon Jet body Compensator Ring, 300s LED TwLk Body (3/4"sbx3/8"sb)	19	
3RQ	29530-101-500, 1282, 29232-289-200	3" PrLc Jet Int(Hlo, 4-roto (SS/Siv/GpGyGpGy); 300s Typhon Jet body Compensator Ring, 300s LED TwLk Body (3/4"sbx3/8"sb)	0	
4D	29540-011-500, 1287, 29242-289-200	4-1/2" PrLc Jet Int(Hlo, Dir. (SS/Siv/GpGyGpGy); 400s Typhon Jet body Compensator Ring, 400s LED TwLk Body (3/4"sbx3/8"sb)	7	
4RQ	29540-101-500, 1287, 29242-289-200	4-1/2" PrLc Jet Int(Hlo, 4-Roto(SS/Siv/GpGyGpGy); 400s Typhon Jet body Compensator Ring, 400s LED TwLk Body (3/4"sbx3/8"sb)	5	
5D	29550-011-500, 1292, 29252-289-200	5" PrLc Jet Int(Hlo, Roto(SS/Siv/GpGyGpGy); 500s Typhon Jet body Compensator Ring, 500s LED TwLk Body (3/4"sbx3/8"sb)	5	
5RQ	29550-101-500, 1292, 29252-289-200	5" PrLc Jet Int(Hlo, 4-Roto(SS/Siv/GpGyGpGy); 500s Typhon Jet body Compensator Ring, 500s LED TwLk Body (3/4"sbx3/8"sb)	0	
5M	29550-041-500, 1292, 29252-289-200	5" PrLc Jet Int(Hlo, Mass (SS/Siv/GpGyGpGy); 500s Typhon Jet body Compensator Ring, 500s LED TwLk Body (3/4"sbx3/8"sb)	0	
6	25059-101-000, 25090-089-200	1" Air Control, Halo, GP/Sil/GP with LED bezel	4	
7	25056-111-000, 25030-089-200	1" On-Off Control, Halo, GP/Sil/GP with LED bezel	1	
8	25269-602-700	Laminar spa fountain, Halo	2	
9	640-3789GADSGV	Suction VGB (Gr)	4	
10	3113	Light Kit 3"	2	
11	50015-05, 13309	TP600CE, overlay Pinnacle	1/1	
12	3133	Pillow	4	
13	3135	2.5" Speaker Round	2	
14	1298	Elite skim filter(Gr)	1	
15	1298-A	50 sq. ft. Cartridge Filter	1	
16	1251, 1252, 01-14-3879	Spa Frog in-line Assy, cap, cartridges	1	
17	1299	4" sconce waterfall w. LED	0	
18	1310A, 1315, 1312A, 1318A, 1317, 3126, 3129, 3130, 25243-600-000	LED controller, 9LED light, 6LED spyder, 2-LED spyder, Cable Assy. 48", 1" FRST lens, nut, o-ring, oval light	1/2/7/2/2/5/4/1/4	
19	25241-507-800	Led Deco Cup Holder	3	
N/A	7136, 6022, 310-0140	2 Speed Motor; 6' cord ; Wet end 0140;	1	
N/A	7135, 6024, 310-0140	1 Speed Motor; 8' cord ; Wet end 0140;	1	
N/A	56713	Pack BP501X	1	
N/A	5071, 7399	Ozonator, Injector,	1	
N/A	7636, 7876A	Owner's Manual, insert	1	Pinnacle
N/A	7986	Spa Cover (91-1/2"x91-1/2"xR10)	1	
N/A	5955, 5954, 5956	Subwoofer 150wt w. harness, power supply 100-240vac, i-pod docking station	1	

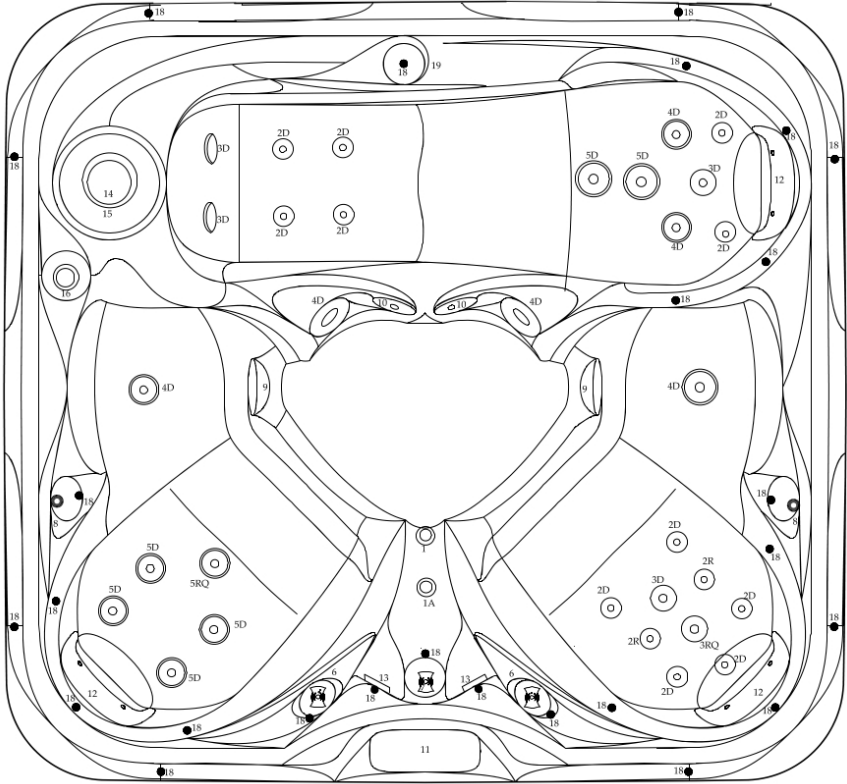

Specifications*

Spa Spec	
Spa Model	PN631(1011PN)
Spa Dimension	84"x78"x34"
Number Of Seats	5 (1 Lounges)
Water Jets	31
Air Jets	0
Water Capacity (USG/L)	316/1196
Dry Weight (LBS/KG)	715/324
Filled Weight (LBS/KG)	3351/1520
Electrical Rating (VAC/AMP/HZ)	240/40/60
GFCI (AMP)	50

* Specifications are subject to change without notice.

Call-Outs				
Label	Part#	Description	Qty.	Notes
1,1A	073199W, 7818, 7379	Nozzle wall fitting, Floor Drain/Wall fitting (Gr), Drain Valve, Economy	2	
2D	29520-011-500, 1276, 29222-289-300	2" PrLc Jet Int(Hlo, Dir. (SS/Siv/GpGyGpGy); 200s Typhon Jet body Compensator Ring, 200s LED TwLk Body (3/4"sbx3/8"sb)	11	
2R	29520-021-500, 1276, 29222-289-300	2" PrLc Jet Int(Hlo, Roto (SS/Siv/GpGyGpGy); 200s Typhon Jet body Compensator Ring, 200s LED TwLk Body (3/4"sbx3/8"sb)	2	
3D	29530-111-500, 1282, 29232-289-200	3" PrLc Jet Int(Hlo, Dir. (SS/Siv/GpGyGpGy); 300s Typhon Jet body Compensator Ring, 300s LED TwLk Body (3/4"sbx3/8"sb)	4	
3RQ	29530-101-500, 1282, 29232-289-200	3" PrLc Jet Int(Hlo, 4-roto (SS/Siv/GpGyGpGy); 300s Typhon Jet body Compensator Ring, 300s LED TwLk Body (3/4"sbx3/8"sb)	1	
4D	29540-011-500, 1287, 29242-289-200	4-1/2" PrLc Jet Int(Hlo, Dir. (SS/Siv/GpGyGpGy); 400s Typhon Jet body Compensator Ring, 400s LED TwLk Body (3/4"sbx3/8"sb)	6	
4RQ	29540-101-500, 1287, 29242-289-200	4-1/2" PrLc Jet Int(Hlo, 4-Roto(SS/Siv/GpGyGpGy); 400s Typhon Jet body Compensator Ring, 400s LED TwLk Body (3/4"sbx3/8"sb)	0	
5D	29550-011-500, 1292, 29252-289-200	5" PrLc Jet Int(Hlo, Roto(SS/Siv/GpGyGpGy); 500s Typhon Jet body Compensator Ring, 500s LED TwLk Body (3/4"sbx3/8"sb)	6	
5RQ	29550-101-500, 1292, 29252-289-200	5" PrLc Jet Int(Hlo, 4-Roto(SS/Siv/GpGyGpGy); 500s Typhon Jet body Compensator Ring, 500s LED TwLk Body (3/4"sbx3/8"sb)	1	
5M	29550-041-500, 1292, 29252-289-200	5" PrLc Jet Int(Hlo, Mass. (SS/Siv/GpGyGpGy); 500s Typhon Jet body Compensator Ring, 500s LED TwLk Body (3/4"sbx3/8"sb)	0	
6	25059-101-000, 25090-089-200	1" Air Control, Halo, GP/Sil/GP with LED bezel	2	
7	25056-111-000, 25030-089-200	1" On-Off Control, Halo, GP/Sil/GP with LED bezel	1	
8	25269-602-700	Laminar spa fountain, Halo	2	
9	640-3789GADSGV	Suction VGB (Gr)	2	
10	3113	Light Kit 3"	1	
11	50015-05, 13309	TP600CE, overlay Pinnacle	1/1	
12	3133	Pillow	3	
13	3135	2.5" Speaker Round	2	
14	1298	Elite skim filter(Gr)	1	
15	1298-A	50 sq. ft. Cartridge Filter	1	
16	1251, 1252, 01-14-3879	Spa Frog in-line Assy, cap, cartridges	1	
17	1299	4" sconce waterfall w. LED	0	
18	1310A, 1315, 1312A, 1318A, 1317, 3126, 3129, 3130, 25243-600-000	LED controller, 8LED light, 6LED spyder, 2-LED spyder, Cable Assy, 48", 1" FRST lens, nut, o-ring, oval light	1/2/3/2/1/19/24/4	
19	25241-507-800	Led Deco Cup Holder	1	
N/A	7136, 6022, 310-0140	2 Speed Motor; 6' cord ; Wet end 0140;	1	
N/A	7135, 6024, 310-0140	1 Speed Motor; 8' cord ; Wet end 0140;	0	
N/A	56713	Pack BP501X	1	
N/A	5071, 7399	Ozonator, injector,	1	
N/A	7636, 7876A	Owner's Manual, insert	1	Pinnacle
N/A	7924	Spa Cover (84-1/2"x78-1/2"xR10)	1	
N/A	5955, 5954, 5956	Subwoofer 150wt w. harness, power supply 100-240vac, i-pod docking station	1	

PN 740 (Model 1012)

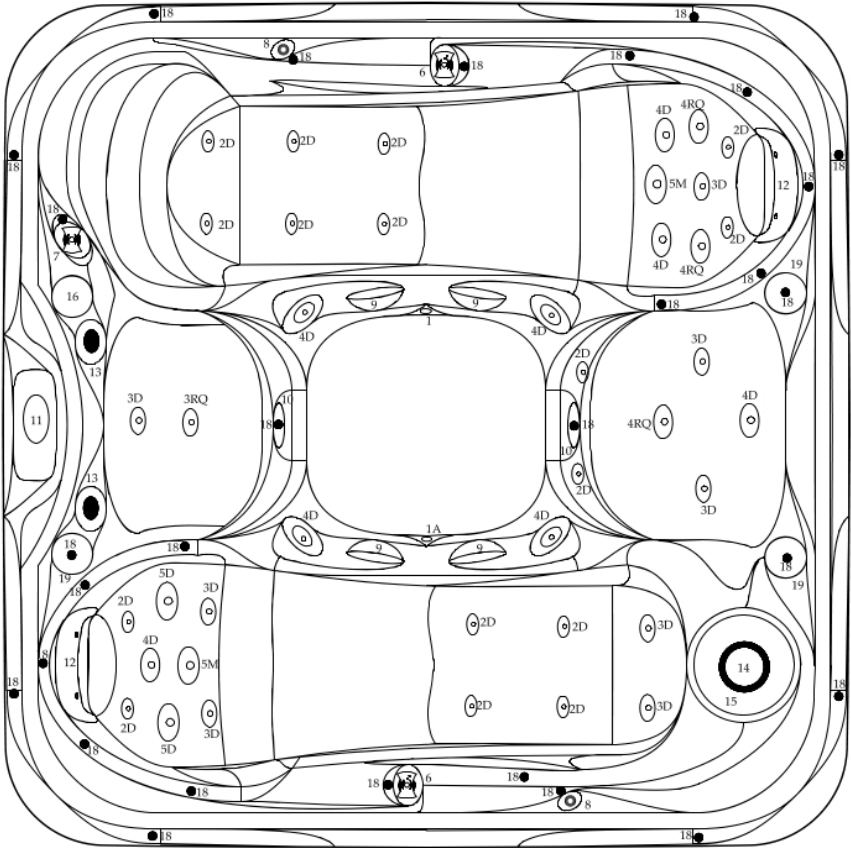

Specifications*

Spa Spec	
Spa Model	PN740(1012PN)
Spa Dimension	84"x84"x36"
Number Of Seats	4 (2 Lounge)
Water Jets	40
Air Jets	0
Water Capacity (USG/L)	343/1298
Dry Weight (LBS/KG)	840/380
Filled Weight (LBS/KG)	3699/1678
Electrical Rating (VAC/AMP/HZ)	240/50/60
GFCI (AMP)	60

* Specifications are subject to change without notice.

Call-Outs					
Label	Part#	Description	Qty.	Notes	
1,1A	073199W, 7818, 7379	Nozzle wall fitting, Floor Drain/Wall fitting (Gr). Drain Valve, Economy	1+1+1		
2D	29520-011-500, 1276, 29222-289-300	2" PrLc Jet Int(Hlo, Dir. (SS/Siv/GpGyGpGy); 200s Typhon Jet body Compensator Ring, 200s LED TwLk Body (3/4"sbx3/8"sb)	16		
2R	29520-021-500, 1276, 29222-289-300	2" PrLc Jet Int(Hlo, Roto (SS/Siv/GpGyGpGy); 200s Typhon Jet body Compensator Ring, 200s LED TwLk Body (3/4"sbx3/8"sb)	0		
3D	29530-111-500, 1282, 29232-289-200	3" PrLc Jet Int(Hlo, Dir. (SS/Siv/GpGyGpGy); 300s Typhon Jet body Compensator Ring, 300s LED TwLk Body (3/4"sbx3/8"sb)	8		
3RQ	29530-101-500, 1282, 29232-289-200	3" PrLc Jet Int(Hlo, 4-roto (SS/Siv/GpGyGpGy); 300s Typhon Jet body Compensator Ring, 300s LED TwLk Body (3/4"sbx3/8"sb)	1		
4D	29540-011-500, 1287, 29242-289-200	4-1/2" PrLc Jet Int(Hlo, Dir. (SS/Siv/GpGyGpGy); 400s Typhon Jet body Compensator Ring, 400s LED TwLk Body (3/4"sbx3/8"sb)	8		
4RQ	29540-101-500, 1287, 29242-289-200	4-1/2" PrLc Jet Int(Hlo, 4- Roto(SS/Siv/GpGyGpGy); 400s Typhon Jet body Compensator Ring, 400s LED TwLk Body (3/4"sbx3/8"sb)	3		
5D	29550-011-500, 1292, 29252-289-200	5" PrLc Jet Int(Hlo, Roto(SS/Siv/GpGyGpGy); 500s Typhon Jet body Compensator Ring, 500s LED TwLk Body (3/4"sbx3/8"sb)	2		
5RQ	29550-101-500, 1292, 29252-289-200	5" PrLc Jet Int(Hlo, 4- Roto(SS/Siv/GpGyGpGy); 500s Typhon Jet body Compensator Ring, 500s LED TwLk Body (3/4"sbx3/8"sb)	0		
5M	29550-041-500, 1292, 29252-289-200	5" PrLc Jet Int(Hlo, Mass (SS/Siv/GpGyGpGy); 500s Typhon Jet body Compensator Ring, 500s LED TwLk Body (3/4"sbx3/8"sb)	2		
6	25059-101-000, 25090-089-200	1" Air Control, Halo, GP/Sil/GP with LED bezel	2		
7	25056-111-000, 25030-089-200	1" On-Off Control, Halo, GP/Sil/GP with LED bezel	1		
8	25269-602-700	Laminar spa fountain, Halo	2		
9	640-3789GADSGV	Suction VGB (Gr)	4		
10	3113	Light Kit 3"	2		
11	50015-05, 13309	TP600CE, overlay Pinnacle	1/1		
12	3133	Pillow	3		
13	3135	2.5" Speaker Round	2		
14	1298	Elite skim filter(Gr)	1		
15	1298-A	50 sq. ft. Cartridge Filter	1	Service part	
16	1251, 1252, 01-14-3879	Spa Frog in-line Assy, cap, cartridges	1		
17	1299	4" sconce waterfall w. LED	0		
18	1310A, 1315, 1312A, 1318A, 1317, 3126, 3129, 3130, 25243-600-000	LED controller, 9LED light, 6LED spyder, 2-LED spyder, Cable Assy 48", 1" FRST lens, nut, o-ring, oval light	1/2/5/1/14 /23/4		
19	25241-507-800	Led Deco Cup Holder	3		
N/A	7136, 6022, 310-0140	2 Speed Motor; 6' cord ; Wet end 0140;	1		
N/A	7135, 6024, 310-0140	1 Speed Motor; 8' cord ; Wet end 0140;	1		
N/A	56713	Pack BP501X	1		
N/A	5071, 7399	Ozonator, Injector,	1		
N/A	7636, 7876A	Owner's Manual, insert	1	Pinnacle	
N/A	7988	Spa Cover (84-1/2"x84-1/2"xR10)	1		
N/A	5955, 5954, 5956	Subwoofer 150wt w. harness, power supply 100-240vac, i-pod docking station	1		

Conditions of Warranties

All limited warranties provided hereunder extend only to the original consumer/purchaser of the hot tub if purchased and installed within the boundaries of the United States or Canada and terminate upon transfer of ownership from original consumer/purchaser.

The warranties will not include any:

- Shipping cost and/or taxes incurred.
- Cost of repair or parts incurred by a non-factory-authorized agent.
- Damage due to improper pH Levels.
- Damage due to improper sanitation levels.
- Damage due to shorted heater elements.
- Corrosion at jets.
- Deterioration of pillows, filter lid, filters, any seals and gaskets.

Note: Pinnacle Spas must receive written notification within 10 days if the original consumer/purchaser plans to relocate the hot tub to a site other than the address on file.

Customer Expectations

Your hot tub comes with technical support and after sales care. For the life of your hot tub, trained and certified technical product support specialists are available even after your warranty has been exhausted. Most service inquiries can be answered by referring to your owner's manual, accessing the website or calling a customer care representative at 800.304.9684.

Call 800.304.9684 for specific warranty details.



PN 855 PN 850 PN 743 PN741 PN 631



Exploded View of PN Filter and Spa Frog System

NOTES

Warranty

Lifetime Spa Structural Warranty

Pinnacle Spas warrants the Pinnacle and Pinnacle Plus spa shell structure against the loss of water through the fiberglass laminate of the shell caused by defects in materials and workmanship for as long as the original purchaser owns the spa. Contact manufacturer if you have any questions concerning warranty issues.

Five (5) Year – Spa Surface Warranty

Pinnacle Spas Warrants the Pinnacle and Pinnacle Plus interior acrylic spa surface against blisters, cracks, or delaminating resulting from a defect in the acrylic surface material for a period of five (5) years from the date of purchase, based on the following formula: Suggested retail price divided by months covered (60), multiplied by months owned plus shipping = replacement cost.

Lifetime Manifold Plumbing Parts Warranty

Pinnacle Spas warrants the Pinnacle and Pinnacle Plus plumbing manifolds, fittings, and parts to be free of defects in materials or workmanship for *as long as the original purchaser owns the spa.*

Two (2) Year – Limited Spa Equipment Warranty

Pinnacle Spas warrants the Pinnacle and Pinnacle Plus electrical equipment and components to be free of defects in materials and workmanship for a period of two (2) years on major spa components (electrical system, spa controls, motors) and two (2) years authorized field service on these items. Ninety (90) day (Parts ONLY) Limited Warranty on all optional accessory items (optional cabinets, fixtures, trim kits, skirts, CD & MP3 players, all other music and video devices, ozone, waterfall assembly, LED lighting, etc). All perishable, cosmetic or owner serviceable items, light bulb, light lenses, fuses, headrests, cabinet, filters, cover-lift, spa drain, jet inserts, etc are warranted to be free of defects in materials and workmanship at the time of delivery. These items may be covered by a manufacturer's warranty. The spa cover is NOT covered under this Pinnacle Spas Limited Warranty, but may carry an original manufacturer's warranty. Pinnacle Spas may serve as an agent in presenting claims under the manufacturers' warranties, but disclaims any liability there under. In the event Pinnacle Spas provides parts to replace an alleged defective part under warranty owner will be billed for the cost thereof and credited, minus freight, upon both the defective part being returned to Pinnacle Spas and the manufacturer of said part accepting warranty claim.

Warranty Performance

In the event of a suspected defect, under the terms of this Limited Warranty, notify manufacturer. Use all reasonable means to protect the spa from further damage. A service representative will provide the technical labor only, to affect the repair subject to the terms and conditions contained in this Limited Warranty. The service representative may assess reasonable travel charges. Visits to simply diagnose, troubleshoot, or inspect problems are not covered under this Limited Warranty. If we determine that repairs are not feasible due to functional defect, we reserve the right to provide a replacement part or spa in lieu of repair. We will replace with a part of value equal to the original purchase. In such event, owner is responsible for expenses including removal, shipping, and re-installation of the existing or replacement hot tub. The replacement spa or part will carry the balance of the original spa's warranty, if any. Either party's waiver of any breach or failure to enforce any of the terms or conditions of the warranty shall not in any way affect, limit or waive such party's right at any time to enforce strict compliance with every term and condition thereof.

Limitations and Exclusions

This Limited Warranty applies to spas sold after January 1, 2008. This Limited Warranty takes effect from the date the unit was originally purchased or six months from the date of manufacture whichever comes first. This Limited Warranty applies only to the Original Purchaser and terminates with any transfer of ownership. This Limited Warranty does not apply to a spa used for any commercial, rental, club purposes or for any spa used outside of the United States. The purchaser must establish the date of purchase by dated sales invoice of delivery receipt.

This Limited Warranty does not cover damage resulting from abuse, misuse, or neglect including any installation, operation, maintenance or use of the spa other than in accordance with the Owner's Manual of the spa. Damage caused by operation of the spa at water temperatures outside the range of 32 degrees F. and 120 degrees F., damage caused by dirty, clogged, or calcified filter cartridges, damage to the spa surface caused by improper use of chemicals or cleaning agents, allowing un-dissolved spa sanitizing chemicals to lie on the surface, damage caused by improper pH balance or other improper water chemistry, damage caused by failure to provide even and sufficient support for the spa, are considered abuses and may invalidate this Limited Warranty. Damaged caused by repairs or alterations performed by anyone other than an authorized service representative is not covered. Failure caused by accidents, acts of God, nonstructural normal wear and tear, cosmetic blemishes and other causes beyond our control are excluded.

The warranty is in lieu of all other warranties, expressed or implied, including implied warranties of merchantability and fitness for a particular purpose. In no event shall manufacturer be liable for incidental or consequential damages.

DISCLAIMERS

The spa owner is required to provide unencumbered access to the spa for any warranty repair or inspection. Manufacturer shall not be liable for loss of use of spa or other incidental or consequential costs, expenses or damages, which may include, but are not limited to water damage, or the removal of a permanent deck or other customer fixture. Under no circumstances shall we, or any of our representatives be held liable for injury to any person or damage to any property, however arising. This warranty gives you specific legal rights and you may have other rights. No service company, or other party is authorized to change, modify, or extend the terms of this Limited Warranty in any manner whatsoever. The jurisdiction and venue for any litigation arising with respect to the transaction evidenced by this warranty shall be the Circuit Court in and for Pinellas County, Florida and Buyer hereby agrees to such jurisdiction and venue.



6101 45th St. N.
St. Petersburg, FL 33714
800.304.9684

www.PinnacleSpas.com