

HOW TO CONTROL PESTS SAFELY

Getting rid of roaches and mice

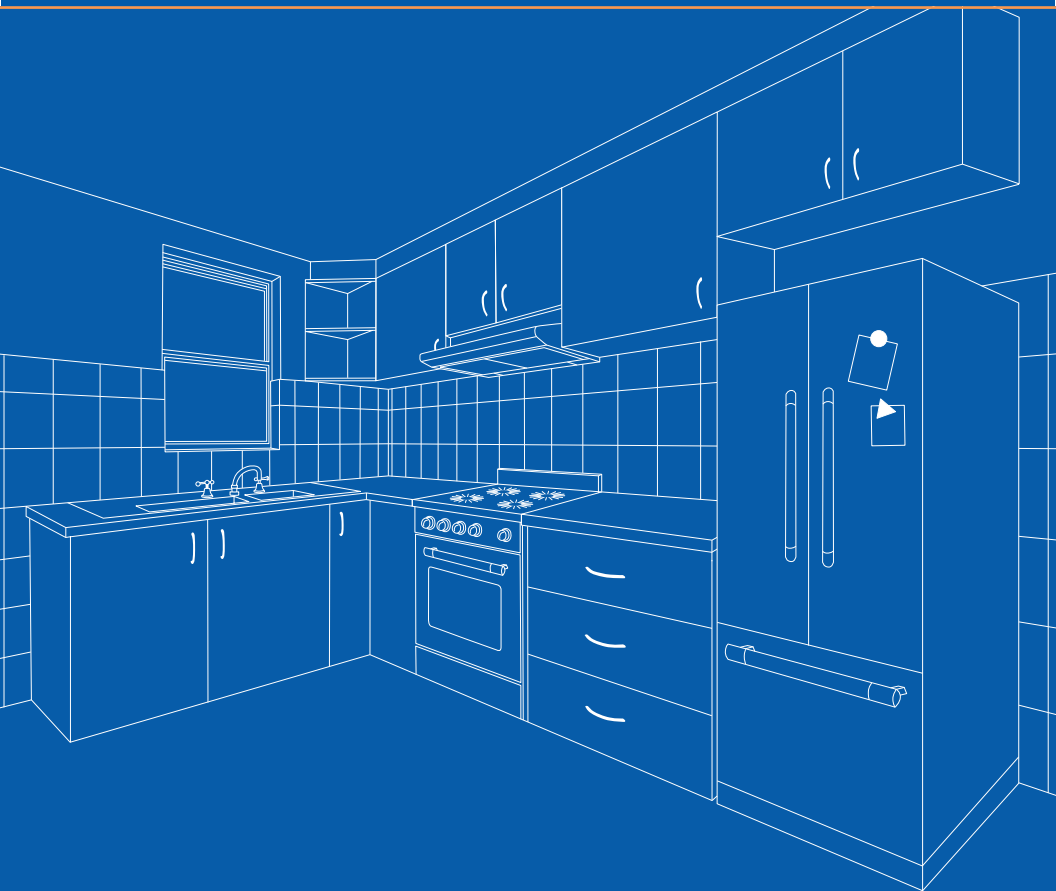
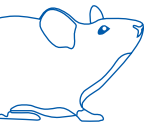

TABLE OF CONTENTS

	Take an Active Role Against Pests	1
	How to Find Pests	2-3
	Clean Up	4
	Starve Them and Parch Them	6
	Seal Pests Out	8
	When to Hire a Professional	11
	Targeted Treatment	12
	More Resources	15





Take an Active Role Against Pests

New York City law requires property owners to keep apartments free of pests, such as cockroaches and mice. This includes safely fixing the problems that can cause pests, such as water leaks, cracks and holes. Tenants also have a role to play in keeping homes pest-free.

NOBODY WANTS TO LIVE WITH PESTS

Cockroaches and mice can contaminate food, damage homes, and make allergies and asthma worse. Pesticides, which are chemicals used to get rid of pests, also cause problems. Pesticides can cling to carpets, furniture and other surfaces, and many are dangerous to people and pets. The Poison Control Center receives about 1,000 reports of accidental pesticide poisonings or exposures every year – half of them to children under 5 years old.

WHAT ARE PEOPLE DOING WRONG?

Many tenants, owners and pest control professionals make the same mistake: They turn to pesticides *first*. But pesticides kill only a *small number* of pests. Pests can become resistant, so the poison no longer kills them and their offspring. Pesticides are often unnecessary. When they are needed, only safer and more targeted products should be used.

WHY THIS GUIDE WORKS

Good pest control gets to the root of the problem. To get rid of pests and keep them from coming back, you have to deprive them of everything they need to survive: food, water, shelter and ways to get around.

This guide explains how to clean up, seal off trouble spots and pest-proof your home in easy-to-understand steps. *To get the most from this guide:*

- Don't try to do everything at once. It can take a few weeks to get rid of pests and keep them out. Just take it one step at a time and remember: *This guide works*. Most people who undertake this project only need to do it once every few years.
- Show this guide to your neighbors and friends. Encourage them to use it!

You probably already know if you have roaches, mice or rats. But it is important to know how big the problem is, where pests are entering from, and where they are getting their food and water.

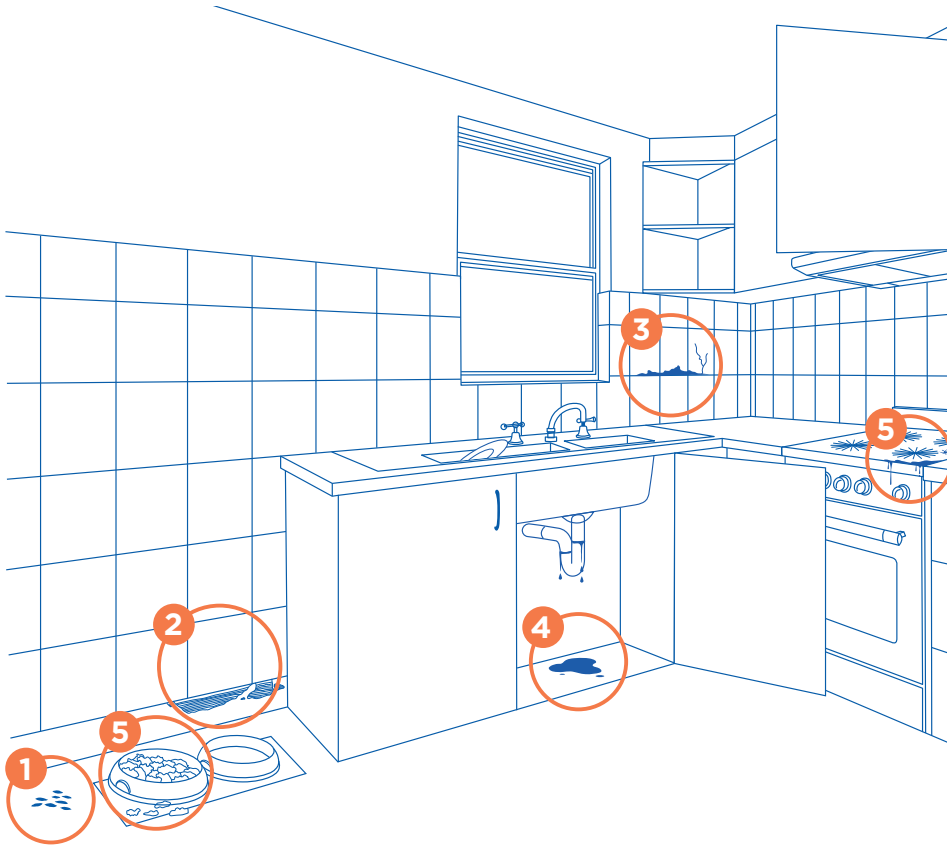

Start in Your Kitchen

Look for these problems:

1 Waste and droppings:

- Cockroach droppings look like dark smudges with dark dots. Their egg cases are yellowish and ribbed, about the size of a small fingernail.

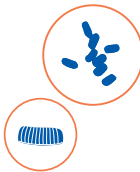

- Mouse droppings are brown, the size and shape of rice grains.



- ### 2 Chew marks in woodwork, walls, and food containers.



How to Find Pests

To find out, go through every room in your home, focusing on the kitchen and bathroom, where problems are usually worst. You may need a flashlight for the dark areas.

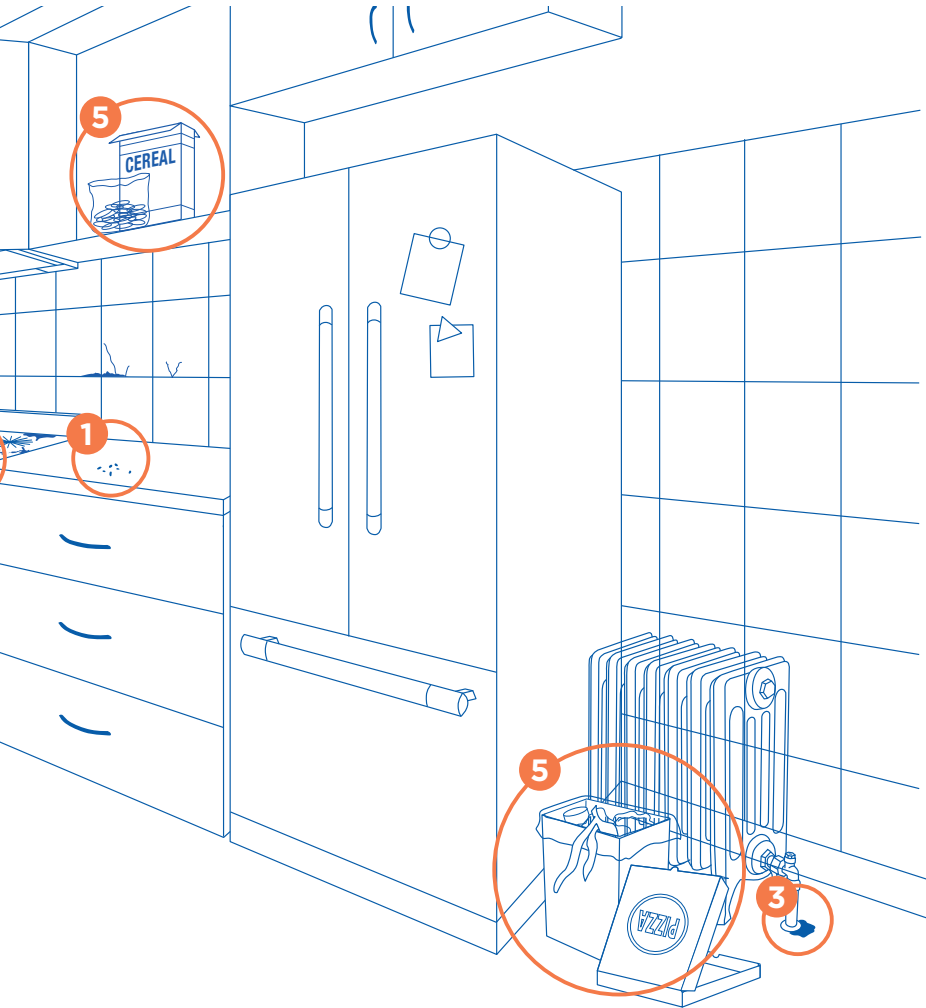

3 Gaps, cracks and holes in walls, along baseboards and windows, and around pipes, wires and drains.

- Cockroaches can squeeze through cracks as small as 1/8 inch.
- Mice can get through holes as small as 1/4 inch.

4 Leaky faucets and pipes or leaks in ceilings and walls.

5 Open food packages, sticky surfaces, pet food left out and garbage cans that don't close tightly.



Clean Up

Make it harder for roaches and mice to get in, move freely, and find food, water and shelter. Clean up.

To get rid of pests and keep them from coming back, these steps are key.

REDUCE CLUTTER

- Recycle piles of newspapers, paper bags, cardboard and bottles, especially around stoves and refrigerators and under sinks.
- Store clothing and linens you don't use in sealed plastic boxes or bags.

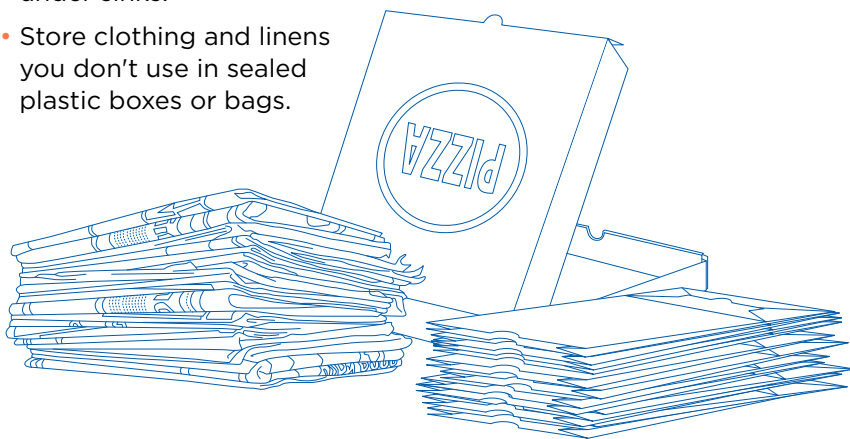

VACUUM THOROUGHLY

- Use a vacuum with a hose and crevice tool. Special filter vacuums, known as HEPA or allergen-reducing vacuums, work best.
- Vacuum behind and under refrigerators and stoves.
- Empty cabinets, throwing away old food and items with signs of pests.
- Vacuum inside gaps and holes in walls, and in and behind cabinets. Start high and work down.
- When you're done, seal the vacuum bag in plastic and throw it out.

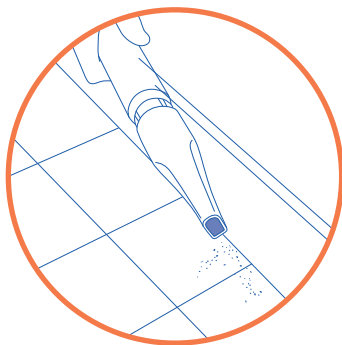

WASH HARD SURFACES

- Wear household gloves.
- Fill two buckets with warm water: one with a mild soap or detergent, and one with plain water for rinsing. Separate rinse water will help you avoid spreading insect eggs, food and other wastes. Change the water often.
- Use a sponge and plastic scouring pad or scrub brush to scrub and rinse:
 - Countertops, tables and surfaces where food is stored, prepared or eaten.
 - Under the stovetop, inside burners, around and inside the exhaust hood, and under and behind the stove, refrigerator and dishwasher.
 - Inside the rubber seal of the refrigerator door.
 - Inside drawers, cabinets, and shelves in the kitchen and bathroom.
 - Floors.
- For hard-to-remove stains and to disinfect, use a mild bleach solution (1/2 cup of bleach in 1 gallon of water) or a cleaning product with bleach.
- *Never mix bleach with ammonia or other cleaning products!*

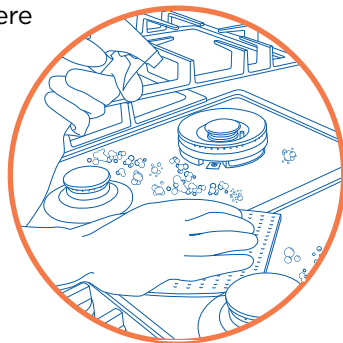

WASH SMALL AREA RUGS AND CURTAINS

This gets rid of egg cases and reduces allergens.

CLEAN SMALL APPLIANCES

Cockroaches like warm, dark places such as toasters, countertop grills, microwave ovens and clocks.

- Unplug the appliances and vacuum them out.
- For serious infestations, after vacuuming, seal the appliance in a plastic bag and put it in the freezer overnight.





Starve Them and Parch Them

Prevent roaches and mice from getting the food and water they need to live.

PEST-PROOF YOUR FOOD

- Store all boxed or loose food in containers that seal tight – plastic, glass or coffee cans with lids.
- Store as much food in your refrigerator as you can, especially foods you keep for a long time, such as flours, rice and nuts.
- To store large bags of pet food, use a metal garbage can with a lid.

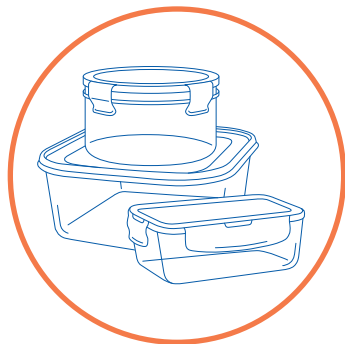

MANAGE YOUR GARBAGE

- Use garbage cans with tight-fitting lids (metal ones are best) for garbage and recycling.
- Clean them often, inside and out.
- Rinse recyclables before throwing out in designated bins.
- In apartment buildings, put tied up garbage bags down the chute or bring them to the building's trash bins every day.
- Bring garbage cans or bags to the curb as close to pickup as possible. Leaving them out overnight invites rats.



IN BUILDINGS WITH COMPACTORS

- Bag and securely tie garbage before sending it down the chute.
- Leave larger bags and items in designated storage areas.
- Do not overstuff chutes.
- Place recyclables in designated bins, not down the chute.
- Do not leave bagged garbage on the floor in compactor rooms.
- Do not throw liquids or sharp items down the chute.

PUT FOOD AWAY AT NIGHT

- Wash and dry the dishes. Don't leave dirty dishes in the sink overnight.
- Wipe down the stovetop, counters and tables.
- Sweep up or vacuum away food on the floor. Wipe up any spills.
- Don't leave pet food out.

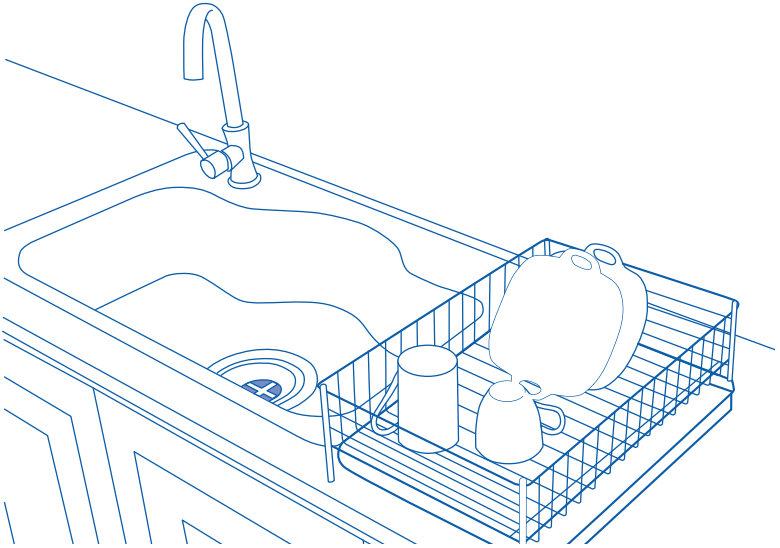

REMOVE WATER SOURCES

- Fix leaky faucets by replacing washers.
- Have a plumber fix leaks as quickly as possible.
- Use your bathroom window or fan to vent steam after showers and baths to prevent mildew and mold. Report or fix vents that aren't drawing out air.
- If possible, close off drains in showers, bathtubs and sinks when not in use. You can use inexpensive rubber drain covers or metal drain screens.

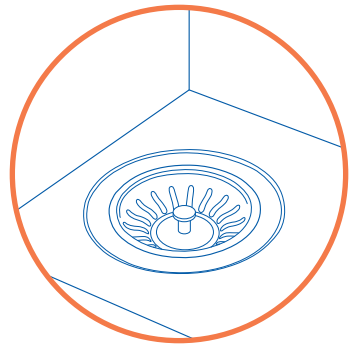



Seal Pests Out

Cockroaches and mice can squeeze into your home through very small cracks and holes. To keep pests out for good, fill holes and seal cracks in walls, floors and woodwork, and around the tub, shower, and sink.

These repairs are easy to do. The materials are inexpensive and can be found at most hardware stores. It's important to wear gloves and follow all package instructions. If you can't or don't want to do the repairs yourself, ask the owner or superintendent. New York City law requires owners to keep tenants' homes free of pests and mold.

INEXPENSIVE MATERIALS FOR FILLING HOLES AND SEALING CRACKS

- Rubber gloves
- 100% silicone caulk and caulking gun
- Stainless steel wool or copper mesh
- Weather stripping and door sweeps
- Spackle or joint compound and one-inch spackling knife
- Duct tape
- House paint and brushes
- Escutcheon plates

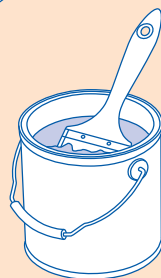
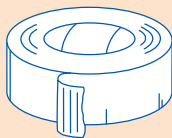
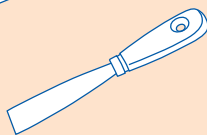
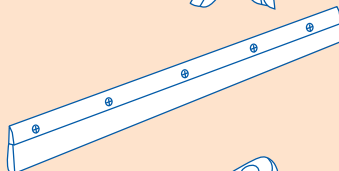
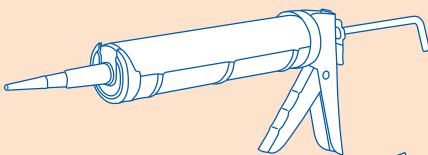

SEAL CRACKS AND SMALL HOLES

- Seal narrow gaps with 100% silicone caulk. Caulk around bathtubs, showers and sinks, where walls meet the floor, inside cabinets, and where cabinets meet the wall.
- Paint over small cracks in the walls, floor or woodwork with a water-based latex paint.

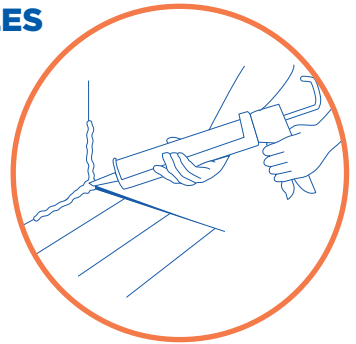

FILL LARGER HOLES AND GAPS (MORE THAN 1/2-INCH WIDE)

- Stuff stainless steel wool or copper mesh inside holes before sealing. This keeps mice from chewing through.
- Use spackle or joint compound to fill gaps and holes that are too large to caulk. Do a little at a time, letting it dry between applications.
- Seal gaps around plumbing and gas pipes that come through walls or floors. Install escutcheon plates around piping after sealing.

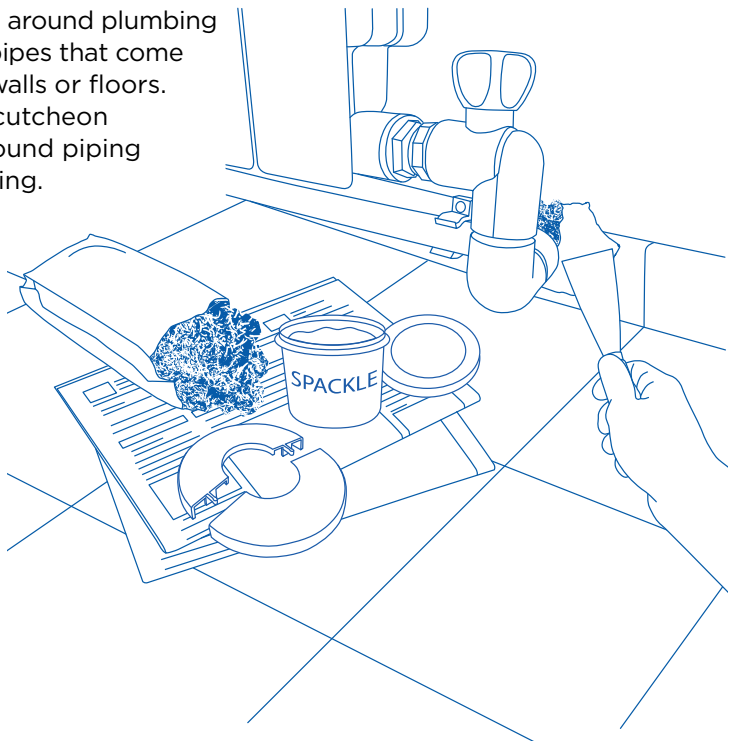

CLOSE GAPS UNDER DOORS AND AROUND WINDOWS

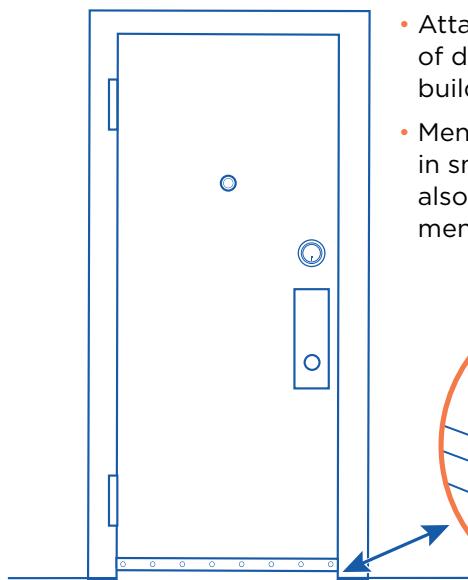

- Attach door sweeps to the bottom of doors leading outside or to a building common space.
- Mend holes in screens by weaving in small pieces of screen. You can also use staples or duct tape to mend small cuts or tears.

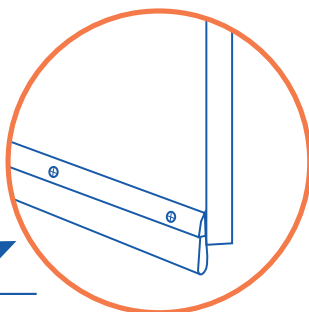

SCREEN BATHROOM AND KITCHEN VENTS

- Pests can enter through vents. Block their entry and keep air flowing through vents by using mesh screens, cut to size and placed under or over the vent cover. Secure the screen with caulk or a staple gun.

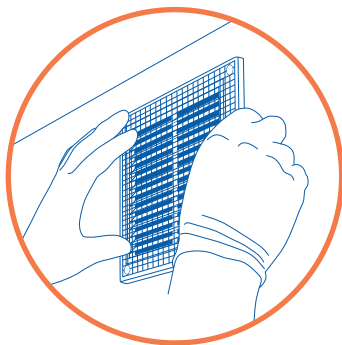



When to Hire a Professional

If you have rats in your home, or a severe mouse or cockroach problem, then you need a pest control professional. Be sure the professional is certified by the New York State Department of Environmental Conservation (NYS DEC). Ask to see a copy of the certification or check directly with NYS DEC by visiting dec.ny.gov. Search for **NYSPAD** and click through to the Bureau of Pesticides Management Information Portal to search for permitted businesses, agencies, applicators and technicians in your area.

A good professional will identify the conditions that are contributing to pests and will come up with a plan for getting rid of them. Some pest problems require several visits. It may take days or even weeks to get rid of a serious rodent problem. Tell the pest control professional to use the least hazardous pesticide that will be effective. Don't allow the use of insect bombs or foggers. If you have children or pets, make sure the professional knows.

If you rent, the owner is required to keep your home pest-free and must hire a professional if necessary. Tell the owner immediately if there are pests in your home.

If the owner or manager does not correct the problem, call **311**.

The Integrated Pest Management Toolkit for Building Owners, Managers and Staff is a great resource for pest management professionals, owners, superintendents and managing agents. Go to nyc.gov/health and search for **IPM**, or call **311** and ask for **Healthy Homes** to get a free copy of the toolkit.





Targeted Treatment

If other pest control measures are needed, use the least toxic chemicals, applied in the safest manner to protect people and pests. What makes pesticides hazardous to pests also makes them dangerous to people and pets. Work with your building management and pest management professionals to determine if pesticides are necessary. (See "When to Hire a Professional" on Page 11.)

USE PESTICIDES CAREFULLY

- Use products that have a manufacturer's label and are marked for consumer use. Read and closely follow the label instructions:
 - Do not use more than is recommended.
 - Always follow the manufacturer's label. Never use a product for a different insect or rodent than is named on the label.
- **Do not use foggers, bombs or loose rodent bait.** They spread everywhere and land on surfaces where people sit, prepare food, play or eat.
- Never buy pesticides from street vendors. Do not use illegal products, such as Chinese Chalk, Tres Pasitos or Tempo.
- Store chemicals safely and place traps where children or pets can't get to them.



FOR COCKROACHES

DUSTS

Dusts include boric acid, diatomaceous earth and silica gel, all available at hardware and home improvement stores. Keep children and pets away, and wear safety goggles when you're applying dusts.

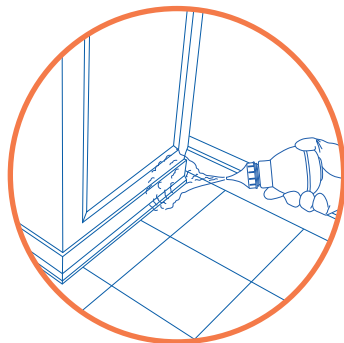

- Use a bulb duster or squeeze bottle with boric acid, diatomaceous earth or silica gel.
- Squeeze dust into cracks and holes, and underneath and behind large appliances and cabinets – wherever roaches are active.
- Apply a *thin* layer. Cockroaches avoid large clumps.
- Afterward, seal up crevices, cracks and holes with caulk or spackle. (See Page 9 for more details.)
- Don't worry if you see cockroaches after applying dusts. They can take several days or weeks to work.

GEL BAIT

- Gel baits do not kill pests right away, but are very effective over time. Pests eat them and die slowly, after they go back to their nests. Other cockroaches in the nest die when they eat the droppings and remains of cockroaches that ate the bait.
- Squeeze pea-sized dabs of gel every foot or so along crevices, cabinet shelves and baseboards. Reapply after it gets eaten.
- Insert gels into cracks and holes before sealing.

BAIT STATIONS AND STICKY TRAPS

- Peel off the sticky tape from the bottom of the bait station or trap before pressing it to a surface.
- Place the bait or sticky trap where cockroaches travel – along edges, in crevices and corners, inside and behind cabinets, behind appliances, and under sinks.
- Replace bait stations every two to three months. Change brands or types each year. Replace sticky traps every two weeks (more often if they fill up).

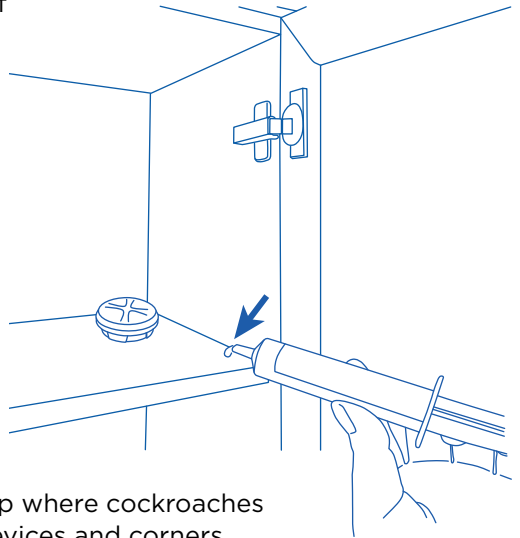

FOR MICE

RODENTICIDE BAIT

If you see mice only occasionally, you may be able to solve the problem yourself using rodenticide baits.

- Only use baits that come in tamper-proof containers. Never use loose bait.
- Wear gloves when handling the baits.
- Replace baits when empty.
- Remove them after mice have disappeared.

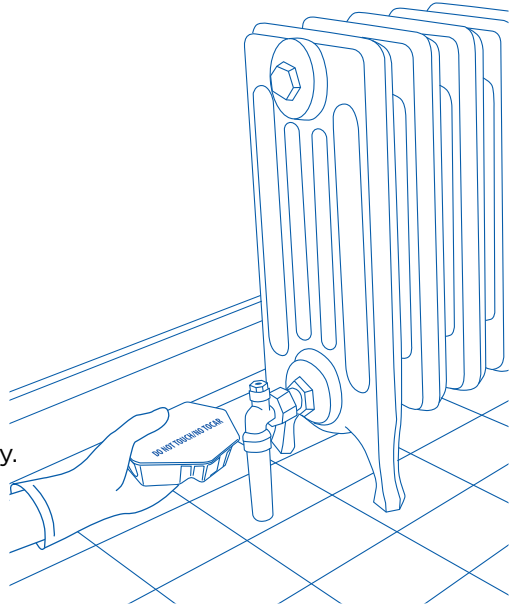

TRAPS

Snap traps or glue traps can also be used to control mice. Follow the directions on the package.

- Place traps out of the reach of children and pets.
- Check the traps daily and dispose of mice in sealed plastic bags.
- Keep replacing the traps until you do not catch anything for at least one week.



More Resources

- If you let the owner know that you have pests or conditions that encourage pests (such as water leaks, holes and cracks) but the owner has not fixed the problem, call **311**.
- If you or your child has asthma and there are pests or mold in your home, your health care provider or asthma case manager can request a free home environmental inspection. Visit nyc.gov/health and search for **Healthy Neighborhoods Program** to learn more.
- If you have other pests, such as rats or bedbugs, call **311** or visit nyc.gov/health for more information.

Visit nyc.gov/health and search for **pests** for more information.

