

hp 49g+/ hp 48gII graphing calculator

advanced user's reference manual



i n v e n t

Edition 1.1

HP part number F2228-90010

Printed Date: 2006/3/20

Notice

REGISTER YOUR PRODUCT AT: www.register.hp.com

THIS MANUAL AND ANY EXAMPLES CONTAINED HEREIN ARE PROVIDED "AS IS" AND ARE SUBJECT TO CHANGE WITHOUT NOTICE. HEWLETT-PACKARD COMPANY MAKES NO WARRANTY OF ANY KIND WITH REGARD TO THIS MANUAL, INCLUDING, BUT NOT LIMITED TO, THE IMPLIED WARRANTIES OF MERCHANTABILITY, NON-INFRINGEMENT AND FITNESS FOR A PARTICULAR PURPOSE.

HEWLETT-PACKARD CO. SHALL NOT BE LIABLE FOR ANY ERRORS OR FOR INCIDENTAL OR CONSEQUENTIAL DAMAGES IN CONNECTION WITH THE FURNISHING, PERFORMANCE, OR USE OF THIS MANUAL OR THE EXAMPLES CONTAINED HEREIN.

© Copyright 1993-1998, 2005, 2006 Hewlett-Packard Development Company, L.P.

Reproduction, adaptation, or translation of this manual is prohibited without prior written permission of Hewlett-Packard Company, except as allowed under the copyright laws.

Hewlett-Packard Company
4995 Murphy Canyon Rd,
Suite 301
San Diego, CA 92123

Acknowledgements

Hewlett-Packard would like to thank the following for their contribution:

Gene Wright, Tony Hutchins, Wlodek Mier-Jedrzejowicz, Jordi Hidalgo, Ted Kerber, Joe Horn, Richard Nelson, Bruce Horrocks and Jake Schwartz.

Printing History
Edition 1 September 2005
Edition 1.1 March 2006

Contents

| | |
|--|------|
| Contents..... | 1 |
| 1. RPL Programming..... | 1-1 |
| Understanding Programming..... | 1-1 |
| The Contents of a Program..... | 1-1 |
| Calculations in a Program..... | 1-2 |
| Entering and Executing Programs..... | 1-3 |
| Viewing and Editing Programs..... | 1-6 |
| Creating Programs on a Computer..... | 1-7 |
| Using Local Variables..... | 1-7 |
| Creating Local Variables..... | 1-7 |
| Evaluating Local Names..... | 1-8 |
| Defining the Scope of Local Variables..... | 1-9 |
| Compiled Local Variables..... | 1-10 |
| Creating User-Defined Functions as Programs..... | 1-10 |
| Using Tests and Conditional Structures..... | 1-11 |
| Testing Conditions..... | 1-11 |
| Using Conditional Structures and Commands..... | 1-13 |
| Using Loop Structures..... | 1-17 |
| Using Definite Loop Structures..... | 1-17 |
| Using Indefinite Loop Structures..... | 1-21 |
| Using Loop Counters..... | 1-24 |
| Using Summations Instead of Loops..... | 1-25 |
| Using Flags..... | 1-25 |
| Types of Flags..... | 1-26 |
| Setting, Clearing, and Testing Flags..... | 1-26 |
| Recalling and Storing the Flag States..... | 1-27 |
| Using Subroutines..... | 1-28 |
| Single-Stepping through a Program..... | 1-29 |
| Trapping Errors..... | 1-32 |
| Causing and Analyzing Errors..... | 1-32 |
| Making an Error Trap..... | 1-33 |
| Input..... | 1-35 |
| Data Input Commands..... | 1-35 |
| Using PROMPT ... CONT for Input..... | 1-35 |
| Using DISP FREEZE HALT ... CONT for Input..... | 1-37 |
| Using INPUT ... ENTER for Input..... | 1-38 |
| Using INFORM and CHOOSE for Input..... | 1-42 |
| Beeping to Get Attention..... | 1-45 |
| Stopping a Program for Keystroke Input..... | 1-46 |
| Using WAIT for Keystroke Input..... | 1-46 |
| Using KEY for Keystroke Input..... | 1-46 |
| Output..... | 1-46 |
| Data Output Commands..... | 1-47 |
| Labeling Output with Tags..... | 1-47 |
| Labeling and Displaying Output as Strings..... | 1-48 |
| Pausing to Display Output..... | 1-48 |
| Using MSGBOX to Display Output..... | 1-49 |
| Using Menus with Programs..... | 1-49 |
| Using Menus for Input..... | 1-50 |
| Using Menus to Run Programs..... | 1-50 |
| Turning Off the hp49g+/hp48gII from a Program..... | 1-52 |
| 2. RPL Programming Examples..... | 2-1 |
| Fibonacci Numbers..... | 2-1 |

| | |
|---|------|
| FIB1 (Fibonacci Numbers, Recursive Version)..... | 2-1 |
| FIB2 (Fibonacci Numbers, Loop Version)..... | 2-2 |
| FIBT (Comparing Program-Execution Time)..... | 2-3 |
| Displaying a Binary Integer..... | 2-5 |
| PAD (Pad with Leading Spaces)..... | 2-5 |
| PRESERVE (Save and Restore Previous Status)..... | 2-6 |
| BDISP (Binary Display)..... | 2-7 |
| Median of Statistics Data..... | 2-10 |
| %TILE (Percentile of a list)..... | 2-10 |
| MEDIAN (Median of Statistics Data)..... | 2-11 |
| Expanding and Collecting Completely..... | 2-14 |
| MULTI (Multiple Execution)..... | 2-14 |
| EXCO (Expand and Collect Completely)..... | 2-15 |
| Minimum and Maximum Array Elements..... | 2-16 |
| MNX (Minimum or Maximum Element—Version 1)..... | 2-16 |
| MNX2 (Minimum or Maximum Element- Version 2)..... | 2-18 |
| Applying a Program to an Array..... | 2-20 |
| Converting Between Number Bases..... | 2-22 |
| Verifying Program Arguments..... | 2-24 |
| NAMES (Check List for Exactly Two Names)..... | 2-24 |
| Converting Procedures from Algebraic to RPN..... | 2-27 |
| Bessel Functions..... | 2-29 |
| Animation of Successive Taylor's Polynomials..... | 2-30 |
| SINTP (Converting a Plot to a Graphics Object)..... | 2-31 |
| Techniques used in SINTP..... | 2-31 |
| SETTS (Superimposing Taylor's polynomials)..... | 2-32 |
| TSA (Animating Taylor's Polynomials)..... | 2-33 |
| Programmatic Use of Statistics and Plotting..... | 2-34 |
| Trace Mode..... | 2-37 |
| Inverse-Function Solver..... | 2-38 |
| Animating a Graphical Image..... | 2-39 |
| 3. Full Command and Function Reference..... | 3-1 |
| ABCUV..... | 3-4 |
| ABS..... | 3-4 |
| ACK..... | 3-4 |
| ACKALL..... | 3-4 |
| ACOS..... | 3-5 |
| ACOS2S..... | 3-6 |
| ACOSH..... | 3-6 |
| ADD..... | 3-7 |
| ADDTMOD..... | 3-8 |
| ADDTOREAL..... | 3-8 |
| ALGB..... | 3-8 |
| ALOG..... | 3-8 |
| AMORT..... | 3-8 |
| AND..... | 3-8 |
| ANIMATE..... | 3-9 |
| ANS..... | 3-10 |
| APPLY..... | 3-10 |
| ARC..... | 3-10 |
| ARCHIVE..... | 3-11 |
| ARG..... | 3-11 |
| ARIT..... | 3-12 |
| ARRAY→..... | 3-12 |
| →ARRAY..... | 3-12 |
| ASIN..... | 3-12 |
| ASIN2C..... | 3-14 |
| ASIN2T..... | 3-14 |

| | |
|----------------|------|
| ASINH..... | 3-14 |
| ASN | 3-14 |
| ASR | 3-15 |
| ASSUME..... | 3-16 |
| ATAN | 3-16 |
| ATAN2S | 3-17 |
| ATANH | 3-17 |
| ATICK..... | 3-18 |
| ATTACH..... | 3-18 |
| AUGMENT..... | 3-19 |
| AUTO..... | 3-19 |
| AXES | 3-20 |
| AXL | 3-20 |
| AXM | 3-20 |
| AXQ | 3-20 |
| BAR | 3-20 |
| BARPLOT | 3-21 |
| BASIS | 3-22 |
| BAUD..... | 3-22 |
| BEEP | 3-22 |
| BESTFIT | 3-22 |
| BIN | 3-22 |
| BINS | 3-23 |
| BLANK..... | 3-23 |
| BOX | 3-23 |
| BUFLN | 3-24 |
| BYTES..... | 3-24 |
| B→R..... | 3-24 |
| C2P..... | 3-24 |
| CASCFG | 3-25 |
| CASCMD | 3-25 |
| CASE..... | 3-25 |
| CEIL..... | 3-25 |
| CENTR..... | 3-26 |
| CF | 3-26 |
| %CH | 3-26 |
| CHINREM | 3-27 |
| CHOLESKY | 3-27 |
| CHOOSE | 3-27 |
| CHR | 3-27 |
| CIRC..... | 3-28 |
| CKSM | 3-28 |
| CLEAR | 3-28 |
| CLKADJ | 3-28 |
| CLLCD..... | 3-29 |
| CLOSEIO | 3-29 |
| CLΣ | 3-29 |
| CLVAR | 3-29 |
| CMPLX..... | 3-29 |
| CNRM..... | 3-30 |
| →COL..... | 3-30 |
| COL→..... | 3-30 |
| COL-..... | 3-30 |
| COL+ | 3-31 |
| COLCT | 3-31 |
| COLLECT | 3-31 |
| COLΣ | 3-31 |
| COMB..... | 3-32 |

| | |
|-----------------|------|
| CON..... | 3-32 |
| COND..... | 3-33 |
| CONIC..... | 3-33 |
| CONJ..... | 3-34 |
| CONLIB..... | 3-34 |
| CONST..... | 3-35 |
| CONSTANTS..... | 3-35 |
| CONT..... | 3-35 |
| CONVERT..... | 3-35 |
| CORR..... | 3-35 |
| COS..... | 3-36 |
| COSH..... | 3-36 |
| COV..... | 3-37 |
| CR..... | 3-37 |
| CRDIR..... | 3-37 |
| CROSS..... | 3-37 |
| CSWP..... | 3-38 |
| CURL..... | 3-38 |
| CYCLOTOMIC..... | 3-38 |
| CYLIN..... | 3-38 |
| C→PX..... | 3-38 |
| C→R..... | 3-39 |
| DARCY..... | 3-39 |
| DATE..... | 3-39 |
| →DATE..... | 3-39 |
| DATE+..... | 3-40 |
| DEBUG..... | 3-40 |
| DDAYS..... | 3-40 |
| DEC..... | 3-41 |
| DECR..... | 3-41 |
| DEDICACE..... | 3-41 |
| DEF..... | 3-41 |
| DEFINE..... | 3-41 |
| DEG..... | 3-42 |
| DEGREE..... | 3-42 |
| DELALARM..... | 3-42 |
| DELAY..... | 3-42 |
| DELKEYS..... | 3-42 |
| DEPND..... | 3-43 |
| DEPTH..... | 3-44 |
| DERIV..... | 3-44 |
| DERVX..... | 3-44 |
| DESOLVE..... | 3-44 |
| DET..... | 3-44 |
| DETACH..... | 3-44 |
| DIAG→..... | 3-45 |
| →DIAG..... | 3-45 |
| DIAGMAP..... | 3-45 |
| DIFF..... | 3-45 |
| DIFFEQ..... | 3-46 |
| DIR..... | 3-47 |
| DISP..... | 3-47 |
| DISPXY..... | 3-47 |
| DISTRIB..... | 3-48 |
| DIV..... | 3-48 |
| DIV2..... | 3-48 |
| DIV2MOD..... | 3-48 |
| DIVIS..... | 3-48 |

| | |
|-------------------|------|
| DIVMOD..... | 3-48 |
| DIVPC..... | 3-48 |
| dn..... | 3-48 |
| DO..... | 3-48 |
| DOERR..... | 3-49 |
| DOLIST..... | 3-49 |
| DOMAIN..... | 3-50 |
| DOSUBS..... | 3-50 |
| DOT..... | 3-50 |
| DRAW..... | 3-51 |
| DRAW3DMATRIX..... | 3-51 |
| DRAX..... | 3-51 |
| DROITE..... | 3-52 |
| DROP..... | 3-52 |
| DROP2..... | 3-52 |
| DROPN..... | 3-52 |
| DTAG..... | 3-52 |
| DUP..... | 3-53 |
| DUP2..... | 3-53 |
| DUPDUP..... | 3-53 |
| DUPN..... | 3-53 |
| D→R..... | 3-54 |
| e..... | 3-54 |
| EDIT..... | 3-54 |
| EDITB..... | 3-55 |
| EGCD..... | 3-55 |
| EGV..... | 3-55 |
| EGVL..... | 3-55 |
| ELSE..... | 3-55 |
| END..... | 3-56 |
| ENDSUB..... | 3-56 |
| ENG..... | 3-56 |
| EPSX0..... | 3-56 |
| EQNLIB..... | 3-56 |
| EQW..... | 3-57 |
| EQ→..... | 3-57 |
| ERASE..... | 3-57 |
| ERR0..... | 3-57 |
| ERRM..... | 3-57 |
| ERRN..... | 3-58 |
| EULER..... | 3-58 |
| EVAL..... | 3-58 |
| EXLR..... | 3-59 |
| EX&LN..... | 3-59 |
| EXP..... | 3-59 |
| EXP2HYP..... | 3-60 |
| EXP2POW..... | 3-60 |
| EXPAN..... | 3-60 |
| EXPAND..... | 3-60 |
| EXPANDMOD..... | 3-60 |
| EXPFIT..... | 3-60 |
| EXPLN..... | 3-60 |
| EXPM..... | 3-60 |
| EYEPT..... | 3-61 |
| F0λ..... | 3-61 |
| FACT..... | 3-61 |
| FACTOR..... | 3-62 |
| FACTORMOD..... | 3-62 |

| | |
|-------------------|------|
| FACTORS | 3-62 |
| FANNING | 3-62 |
| FAST3D | 3-62 |
| FCOEF | 3-63 |
| FC? | 3-63 |
| FC?C | 3-63 |
| FDISTRIB | 3-64 |
| FFT | 3-64 |
| FILER | 3-64 |
| FINDALARM | 3-64 |
| FINISH | 3-65 |
| FIX | 3-65 |
| FLASHEVAL | 3-65 |
| FLOOR | 3-66 |
| FONT6 | 3-66 |
| FONT7 | 3-66 |
| FONT8 | 3-66 |
| FONT→ | 3-67 |
| →FONT | 3-67 |
| FOR | 3-67 |
| FOURIER | 3-68 |
| FP | 3-68 |
| FREE | 3-68 |
| FREEZE | 3-68 |
| FROOTS | 3-69 |
| FS? | 3-69 |
| FS?C | 3-69 |
| FUNCTION | 3-70 |
| FXND | 3-71 |
| GAMMA | 3-71 |
| GAUSS | 3-71 |
| GBASIS | 3-71 |
| GCD | 3-71 |
| GCDMOD | 3-71 |
| GET | 3-71 |
| GETI | 3-72 |
| GOR | 3-73 |
| GRAD | 3-73 |
| GRAMSCHMIDT | 3-73 |
| GREDUCE | 3-73 |
| GRIDMAP | 3-73 |
| →GROB | 3-74 |
| GROB | 3-74 |
| GROBADD | 3-74 |
| GXOR | 3-75 |
| HADAMARD | 3-75 |
| HALFTAN | 3-75 |
| HALT | 3-75 |
| HEAD | 3-75 |
| HEADER→ | 3-76 |
| →HEADER | 3-76 |
| HELP | 3-76 |
| HERMITE | 3-76 |
| HESS | 3-76 |
| HEX | 3-76 |
| HILBERT | 3-77 |
| HISTOGRAM | 3-77 |
| HISTPLOT | 3-77 |

| | |
|------------|------|
| HMS- | 3-78 |
| HMS+ | 3-78 |
| HMS→ | 3-79 |
| →HMS | 3-79 |
| HOME | 3-79 |
| HORNER | 3-79 |
| i | 3-80 |
| IABCUV | 3-80 |
| IBASIS | 3-80 |
| IBERNOULLI | 3-80 |
| IBP | 3-80 |
| ICHINREM | 3-80 |
| IDN | 3-80 |
| IDIV2 | 3-81 |
| IEGCD | 3-81 |
| IF | 3-81 |
| IFERR | 3-81 |
| IFFT | 3-82 |
| IFT | 3-83 |
| IFTE | 3-83 |
| ILAP | 3-83 |
| IM | 3-83 |
| IMAGE | 3-84 |
| INCR | 3-84 |
| INDEP | 3-84 |
| INFORM | 3-85 |
| INPUT | 3-86 |
| INT | 3-86 |
| INTEGER | 3-87 |
| INTVX | 3-87 |
| INV | 3-87 |
| INVMOD | 3-87 |
| IP | 3-87 |
| IQUOT | 3-87 |
| IREMAINDER | 3-87 |
| ISOL | 3-87 |
| ISOM | 3-88 |
| ISPRIME? | 3-88 |
| I→R | 3-88 |
| JORDAN | 3-88 |
| KER | 3-88 |
| KERRM | 3-88 |
| KEY | 3-89 |
| KEYEVAL | 3-89 |
| →KEYTIME | 3-89 |
| KEYTIME→ | 3-89 |
| KGET | 3-90 |
| KILL | 3-90 |
| LABEL | 3-90 |
| LAGRANGE | 3-90 |
| LANGUAGE→ | 3-91 |
| →LANGUAGE | 3-91 |
| LAP | 3-91 |
| LAPL | 3-91 |
| LAST | 3-91 |
| LASTARG | 3-91 |
| LCD→ | 3-92 |
| →LCD | 3-92 |

| | |
|--------------------|-------|
| LCM..... | 3-92 |
| LCXM..... | 3-92 |
| LDEC..... | 3-92 |
| LEGENDRE..... | 3-92 |
| LGCD..... | 3-92 |
| LIBEVAL..... | 3-92 |
| LIBS..... | 3-93 |
| lim..... | 3-93 |
| LIMIT..... | 3-93 |
| LIN..... | 3-93 |
| LINE..... | 3-93 |
| Σ LINE..... | 3-93 |
| LINFIT..... | 3-94 |
| LININ..... | 3-94 |
| LINSOLVE..... | 3-94 |
| LIST→..... | 3-94 |
| →LIST..... | 3-94 |
| Δ LIST..... | 3-95 |
| Π LIST..... | 3-95 |
| Σ LIST..... | 3-95 |
| LN..... | 3-95 |
| LNAME..... | 3-96 |
| LNCOLLECT..... | 3-97 |
| LNP1..... | 3-97 |
| LOCAL..... | 3-97 |
| LOG..... | 3-97 |
| LOGFIT..... | 3-98 |
| LQ..... | 3-98 |
| LR..... | 3-98 |
| LSQ..... | 3-99 |
| LU..... | 3-99 |
| LVAR..... | 3-100 |
| MAD..... | 3-100 |
| MAIN..... | 3-100 |
| MANT..... | 3-100 |
| MAP..... | 3-100 |
| ↓MATCH..... | 3-100 |
| ↑MATCH..... | 3-101 |
| MATHS..... | 3-101 |
| MATR..... | 3-101 |
| MAX..... | 3-101 |
| MAXR..... | 3-102 |
| MAX Σ | 3-102 |
| MCALC..... | 3-102 |
| MEAN..... | 3-103 |
| MEM..... | 3-103 |
| MENU..... | 3-103 |
| MENUXY..... | 3-104 |
| MERGE..... | 3-104 |
| MIN..... | 3-104 |
| MINEHUNT..... | 3-104 |
| MINIFONT→..... | 3-105 |
| →MINIFONT..... | 3-105 |
| MINIT..... | 3-105 |
| MINR..... | 3-106 |
| MIN Σ | 3-106 |
| MITM..... | 3-106 |
| MKISOM..... | 3-106 |

| | |
|------------|-------|
| MOD | 3-106 |
| MODSTO | 3-107 |
| MODULAR | 3-107 |
| MROOT | 3-107 |
| MSGBOX | 3-107 |
| MSLV | 3-107 |
| MSOLVR | 3-107 |
| MULTMOD | 3-108 |
| MUSER | 3-108 |
| →NDISP | 3-108 |
| NDIST | 3-108 |
| NDUPN | 3-109 |
| NEG | 3-109 |
| NEWOB | 3-109 |
| NEXT | 3-110 |
| NEXTPRIME | 3-110 |
| NIP | 3-110 |
| NOT | 3-110 |
| NOVAL | 3-111 |
| NΣ | 3-111 |
| NSUB | 3-111 |
| →NUM | 3-111 |
| NUM | 3-112 |
| NUMX | 3-112 |
| NUMY | 3-112 |
| OBJ→ | 3-113 |
| OCT | 3-113 |
| OFF | 3-113 |
| OLDPRT | 3-114 |
| OPENIO | 3-114 |
| OR | 3-114 |
| ORDER | 3-115 |
| OVER | 3-115 |
| P2C | 3-115 |
| PA2B2 | 3-115 |
| PARAMETRIC | 3-116 |
| PARITY | 3-116 |
| PARSURFACE | 3-117 |
| PARTFRAC | 3-118 |
| PATH | 3-118 |
| PCAR | 3-118 |
| PCOEF | 3-118 |
| PCONTOUR | 3-118 |
| PCOV | 3-119 |
| PDIM | 3-119 |
| PERM | 3-120 |
| PEVAL | 3-120 |
| PGDIR | 3-120 |
| PICK | 3-121 |
| PICK3 | 3-121 |
| PICT | 3-121 |
| PICTURE | 3-121 |
| PINIT | 3-122 |
| PIX? | 3-122 |
| PIXOFF | 3-122 |
| PIXON | 3-122 |
| PKT | 3-122 |
| PLOT | 3-123 |

| | |
|------------|-------|
| PLOTADD | 3-123 |
| PMAX | 3-123 |
| PMIN | 3-123 |
| PMINI | 3-124 |
| POLAR | 3-124 |
| POLYNOMIAL | 3-125 |
| POP | 3-125 |
| POS | 3-125 |
| POTENTIAL | 3-125 |
| POWEXPAND | 3-125 |
| POWMOD | 3-125 |
| PR1 | 3-125 |
| PREDV | 3-126 |
| PREDX | 3-126 |
| PREDY | 3-127 |
| PREVAL | 3-127 |
| PREVPRIME | 3-127 |
| PRLCD | 3-128 |
| PROMPT | 3-128 |
| PROMPTSTO | 3-128 |
| PROOT | 3-128 |
| PROPFRAC | 3-129 |
| PRST | 3-129 |
| PRSTC | 3-129 |
| PRVAR | 3-129 |
| PSDEV | 3-130 |
| PSI | 3-130 |
| Psi | 3-130 |
| PTAYL | 3-130 |
| PURGE | 3-131 |
| PUSH | 3-131 |
| PUT | 3-131 |
| PUTI | 3-132 |
| PVAR | 3-133 |
| PVARS | 3-133 |
| PVIEW | 3-134 |
| PWRFIT | 3-134 |
| PX→C | 3-134 |
| →Q | 3-135 |
| →Qπ | 3-135 |
| qr | 3-135 |
| QR | 3-136 |
| QUAD | 3-136 |
| QUOT | 3-136 |
| QUOTE | 3-136 |
| QXA | 3-137 |
| RAD | 3-137 |
| RAND | 3-137 |
| RANK | 3-137 |
| RANM | 3-138 |
| RATIO | 3-138 |
| RCEQ | 3-139 |
| RCI | 3-139 |
| RCIJ | 3-139 |
| RCL | 3-139 |
| RCLALARM | 3-140 |
| RCLF | 3-140 |
| RCLKEYS | 3-141 |

| | |
|----------------|-------|
| RCLMENU | 3-141 |
| RCLVX | 3-141 |
| RCLΣ | 3-141 |
| RCWS | 3-142 |
| RDM..... | 3-142 |
| RDZ | 3-142 |
| RE | 3-143 |
| RECN | 3-143 |
| RECT..... | 3-143 |
| RECV..... | 3-144 |
| REF..... | 3-144 |
| REMAINDER..... | 3-144 |
| RENAME..... | 3-144 |
| REORDER..... | 3-144 |
| REPEAT..... | 3-144 |
| REPL | 3-144 |
| RES | 3-145 |
| RESTORE | 3-146 |
| RESULTANT..... | 3-146 |
| REVLIST | 3-146 |
| REWRITE | 3-147 |
| RISCH | 3-147 |
| RKF..... | 3-147 |
| RKFERR..... | 3-147 |
| RKFSTEP | 3-148 |
| RL..... | 3-148 |
| RLB..... | 3-148 |
| RND..... | 3-149 |
| RNRM..... | 3-149 |
| ROLL..... | 3-150 |
| ROLLD | 3-150 |
| ROMUPLOAD..... | 3-150 |
| ROOT | 3-150 |
| ROT | 3-151 |
| ROW- | 3-151 |
| ROW+ | 3-151 |
| ROW→ | 3-151 |
| →ROW | 3-152 |
| RPL>..... | 3-152 |
| RR..... | 3-152 |
| RRB..... | 3-153 |
| rref..... | 3-153 |
| RREF..... | 3-153 |
| RREFMOD..... | 3-153 |
| RRK..... | 3-153 |
| RRKSTEP..... | 3-154 |
| RSBERR..... | 3-155 |
| RSD | 3-155 |
| RSWP..... | 3-156 |
| RULES | 3-156 |
| R→B | 3-156 |
| R→C..... | 3-156 |
| R→D..... | 3-157 |
| R→I..... | 3-157 |
| SAME | 3-157 |
| SBRK..... | 3-157 |
| SCALE..... | 3-158 |
| SCALEH..... | 3-158 |

| | |
|-----------------|-------|
| SCALEW..... | 3-158 |
| SCATRLOT..... | 3-158 |
| SCATTER..... | 3-159 |
| SCHUR..... | 3-159 |
| SCI..... | 3-160 |
| SCLΣ..... | 3-160 |
| SCONJ..... | 3-160 |
| SCROLL..... | 3-160 |
| SDEV..... | 3-161 |
| SEND..... | 3-161 |
| SEQ..... | 3-161 |
| SERIES..... | 3-162 |
| SERVER..... | 3-162 |
| SEVAL..... | 3-162 |
| SF..... | 3-162 |
| SHOW..... | 3-162 |
| SIDENS..... | 3-163 |
| SIGMA..... | 3-163 |
| SIGMAVX..... | 3-163 |
| SIGN..... | 3-163 |
| SIGNTAB..... | 3-164 |
| SIMP2..... | 3-164 |
| SIMPLIFY..... | 3-164 |
| SIN..... | 3-164 |
| SINCOS..... | 3-164 |
| SINH..... | 3-164 |
| SINV..... | 3-165 |
| SIZE..... | 3-165 |
| SL..... | 3-165 |
| SLB..... | 3-166 |
| SLOPEFIELD..... | 3-166 |
| SNEG..... | 3-167 |
| SNRM..... | 3-167 |
| SOLVE..... | 3-167 |
| SOLVEQN..... | 3-167 |
| SOLVER..... | 3-168 |
| SOLVEVX..... | 3-168 |
| SORT..... | 3-168 |
| SPHERE..... | 3-168 |
| SQ..... | 3-168 |
| SR..... | 3-169 |
| SRAD..... | 3-169 |
| SRB..... | 3-169 |
| SRECV..... | 3-169 |
| SREPL..... | 3-170 |
| START..... | 3-170 |
| STD..... | 3-171 |
| STEP..... | 3-172 |
| STEQ..... | 3-172 |
| STIME..... | 3-172 |
| STO..... | 3-172 |
| STOALARM..... | 3-173 |
| STOF..... | 3-173 |
| STOKEYS..... | 3-174 |
| STORE..... | 3-174 |
| STOVX..... | 3-174 |
| STO+..... | 3-174 |
| STO-..... | 3-174 |
| STO*..... | 3-175 |

| | |
|-------------|-------|
| STO/ | 3-175 |
| STOΣ | 3-176 |
| STR→ | 3-176 |
| →STR | 3-176 |
| STREAM | 3-176 |
| STURM | 3-177 |
| STURMAB | 3-177 |
| STWS | 3-177 |
| SUB | 3-177 |
| SUBST | 3-178 |
| SUBTMOD | 3-178 |
| SVD | 3-178 |
| SVL | 3-178 |
| SWAP | 3-179 |
| SYSEVAL | 3-179 |
| SYLVESTER | 3-179 |
| SYST2MAT | 3-179 |
| %T | 3-179 |
| TABVAL | 3-180 |
| TABVAR | 3-180 |
| →TAG | 3-180 |
| TAIL | 3-180 |
| TAN | 3-180 |
| TAN2CS2 | 3-181 |
| TAN2SC | 3-181 |
| TAN2SC2 | 3-181 |
| TANH | 3-181 |
| TAYLOR0 | 3-181 |
| TAYLR | 3-181 |
| TCHEBYCHEFF | 3-182 |
| TCOLLECT | 3-182 |
| TDELTA | 3-182 |
| TESTS | 3-182 |
| TEVAL | 3-182 |
| TEXPAND | 3-183 |
| TEXT | 3-183 |
| THEN | 3-183 |
| TICKS | 3-183 |
| TIME | 3-183 |
| →TIME | 3-183 |
| TINC | 3-184 |
| TLIN | 3-184 |
| TLINE | 3-184 |
| TMENU | 3-184 |
| TOT | 3-185 |
| TRACE | 3-185 |
| TRAN | 3-185 |
| TRANSIO | 3-185 |
| TRIG | 3-186 |
| TRIGCOS | 3-186 |
| TRIGO | 3-186 |
| TRIGSIN | 3-186 |
| TRIGTAN | 3-186 |
| TRN | 3-186 |
| TRNC | 3-186 |
| TRUNC | 3-187 |
| TRUTH | 3-187 |
| TSIMP | 3-188 |

| | |
|------------------|-------|
| TSTR..... | 3-188 |
| TVARS..... | 3-188 |
| TVM..... | 3-188 |
| TVMBEG..... | 3-189 |
| TVMEND..... | 3-189 |
| TVMROOT..... | 3-189 |
| TYPE..... | 3-189 |
| UBASE..... | 3-190 |
| UFACT..... | 3-190 |
| UFL1→MINIF..... | 3-191 |
| UNASSIGN..... | 3-191 |
| UNASSUME..... | 3-191 |
| UNBIND..... | 3-191 |
| →UNIT..... | 3-191 |
| UNPICK..... | 3-191 |
| UNROT..... | 3-191 |
| UNTIL..... | 3-192 |
| UPDIR..... | 3-192 |
| UTPC..... | 3-192 |
| UTPF..... | 3-192 |
| UTPN..... | 3-193 |
| UTPT..... | 3-193 |
| UVAL..... | 3-194 |
| V→..... | 3-194 |
| →V2..... | 3-195 |
| →V3..... | 3-195 |
| VANDERMONDE..... | 3-195 |
| VAR..... | 3-196 |
| VARS..... | 3-196 |
| VER..... | 3-196 |
| VERSION..... | 3-196 |
| VISIT..... | 3-196 |
| VISITB..... | 3-197 |
| VPOTENTIAL..... | 3-197 |
| VTYPE..... | 3-197 |
| WAIT..... | 3-197 |
| WHILE..... | 3-198 |
| WIREFRAME..... | 3-198 |
| WSLOG..... | 3-199 |
| ΣX..... | 3-200 |
| ΣX2..... | 3-200 |
| XCOL..... | 3-201 |
| XGET..... | 3-201 |
| XMIT..... | 3-201 |
| XNUM..... | 3-202 |
| XOR..... | 3-202 |
| XPON..... | 3-202 |
| XPUT..... | 3-203 |
| XQ..... | 3-203 |
| XRECV..... | 3-203 |
| XRNG..... | 3-203 |
| XROOT..... | 3-204 |
| XSEND..... | 3-204 |
| XSERV..... | 3-205 |
| XVOL..... | 3-205 |
| XXRNG..... | 3-205 |
| ΣXY..... | 3-205 |
| ΣY..... | 3-206 |

| | |
|---|-------|
| $\Sigma Y2$ | 3-206 |
| YCOL | 3-206 |
| YRNG | 3-206 |
| YSLICE | 3-207 |
| YVOL | 3-207 |
| YYRNG | 3-208 |
| ZEROS | 3-208 |
| ZFACTOR | 3-208 |
| ZVOL | 3-208 |
| \wedge (Power) | 3-209 |
| (Where) | 3-209 |
| $\sqrt{\quad}$ (Square Root) | 3-210 |
| \int (Integrate) | 3-211 |
| ? (Undefined) | 3-212 |
| ∞ (Infinity) | 3-212 |
| Σ (Summation) | 3-212 |
| $\Sigma+$ (Sigma Plus) | 3-212 |
| $\Sigma-$ (Sigma Minus) | 3-213 |
| π (Pi) | 3-213 |
| ∂ (Derivative) | 3-213 |
| ! (Factorial) | 3-214 |
| % (Percent) | 3-214 |
| — (Unit attachment) | 3-215 |
| ⌘ ⌘ (Program delimiters) | 3-215 |
| < (Less than) | 3-215 |
| \leq (Less than or Equal) | 3-216 |
| > (Greater than) | 3-217 |
| \geq (Greater than or Equal) | 3-218 |
| \neq (Not equal) | 3-219 |
| * (Multiply) | 3-219 |
| + (Add) | 3-220 |
| - (Subtract) | 3-222 |
| / (Divide) | 3-223 |
| = (Equal) | 3-223 |
| == (Logical Equality) | 3-224 |
| ► (Store) | 3-225 |
| → (Create Local) | 3-225 |
| 4. Computer Algebra Commands | 4-1 |
| Introduction | 4-1 |
| CAS Operations | 4-1 |
| CAS Settings | 4-2 |
| Selecting CAS Settings | 4-2 |
| The CAS directory, CASDIR | 4-2 |
| Points to note when choosing settings | 4-3 |
| Using the CAS | 4-4 |
| Examples and Help | 4-4 |
| Compatibility with Other Calculators | 4-4 |
| Extending the CAS | 4-4 |
| Dealing with unexpected CAS results or messages | 4-4 |
| ABCUV | 4-12 |
| ACOS2S | 4-12 |
| ADDTMOD | 4-12 |
| ADDTOREAL | 4-13 |
| ALGB | 4-13 |
| ARIT | 4-13 |
| ASIN2C | 4-14 |
| ASIN2T | 4-14 |
| ASSUME | 4-14 |

| | |
|------------------|------|
| ATAN2S..... | 4-15 |
| AUGMENT..... | 4-15 |
| AXL..... | 4-15 |
| AXM..... | 4-16 |
| AXQ..... | 4-16 |
| BASIS..... | 4-16 |
| C2P..... | 4-17 |
| CASCFG..... | 4-17 |
| CASCMD..... | 4-17 |
| CHINREM..... | 4-17 |
| CHOLESKY..... | 4-18 |
| CIRC..... | 4-18 |
| COLLECT..... | 4-19 |
| CONSTANTS..... | 4-19 |
| CURL..... | 4-19 |
| CYCLOTOMIC..... | 4-20 |
| DEDICACE..... | 4-20 |
| DEF..... | 4-20 |
| DEGREE..... | 4-21 |
| DERIV..... | 4-21 |
| DERVX..... | 4-21 |
| DESOLVE..... | 4-22 |
| DIAGMAP..... | 4-22 |
| DIFF..... | 4-23 |
| DISTRIB..... | 4-23 |
| DIV..... | 4-23 |
| DIV2..... | 4-23 |
| DIV2MOD..... | 4-24 |
| DIVIS..... | 4-24 |
| DIVMOD..... | 4-25 |
| DIVPC..... | 4-25 |
| DOMAIN..... | 4-25 |
| DROITE..... | 4-26 |
| dn..... | 4-26 |
| EGCD..... | 4-27 |
| EPSX0..... | 4-27 |
| EULER..... | 4-28 |
| EXLR..... | 4-28 |
| EXP&LN..... | 4-28 |
| EXP2HYP..... | 4-28 |
| EXP2POW..... | 4-29 |
| EXPAND..... | 4-29 |
| EXPANDMOD..... | 4-30 |
| EXPLN..... | 4-30 |
| FACTOR..... | 4-30 |
| FACTORMOD..... | 4-31 |
| FACTORS..... | 4-31 |
| FCOEF..... | 4-31 |
| FDISTRIB..... | 4-32 |
| FOURIER..... | 4-32 |
| FROOTS..... | 4-33 |
| FXND..... | 4-33 |
| GAUSS..... | 4-33 |
| GBASIS..... | 4-34 |
| GCD..... | 4-34 |
| GCDMOD..... | 4-35 |
| GRAMSCHMIDT..... | 4-35 |
| GREDUCE..... | 4-35 |
| HADAMARD..... | 4-36 |

| | |
|-----------------|------|
| HALFTAN..... | 4-36 |
| HELP | 4-36 |
| HERMITE..... | 4-37 |
| HESS..... | 4-37 |
| HILBERT..... | 4-37 |
| HORNER..... | 4-38 |
| IABCUV..... | 4-38 |
| IBASIS..... | 4-38 |
| IBERNOULLI..... | 4-39 |
| IBP..... | 4-39 |
| ICHINREM..... | 4-40 |
| IDIV2..... | 4-40 |
| IEGCD..... | 4-40 |
| ILAP..... | 4-41 |
| IMAGE..... | 4-41 |
| INT..... | 4-41 |
| INTEGER..... | 4-42 |
| INTVX..... | 4-42 |
| INVMOD..... | 4-42 |
| IQUOT..... | 4-43 |
| IREMAINDER..... | 4-43 |
| ISOM..... | 4-43 |
| ISPRIME?..... | 4-44 |
| JORDAN..... | 4-44 |
| KER..... | 4-45 |
| LAGRANGE..... | 4-45 |
| LAP..... | 4-45 |
| LAPL..... | 4-46 |
| LCM..... | 4-46 |
| LCXM..... | 4-46 |
| LDEC..... | 4-47 |
| LEGENDRE..... | 4-47 |
| LGCD..... | 4-48 |
| LIMIT..... | 4-48 |
| lim..... | 4-48 |
| LIN..... | 4-48 |
| LINSOLVE..... | 4-49 |
| LNAME..... | 4-49 |
| LNCOLLECT..... | 4-49 |
| LOCAL..... | 4-50 |
| LVAR..... | 4-50 |
| MAD..... | 4-51 |
| MAIN..... | 4-51 |
| MATHS..... | 4-51 |
| MATR..... | 4-52 |
| MENUXY..... | 4-52 |
| MKISOM..... | 4-53 |
| MODSTO..... | 4-53 |
| MODULAR..... | 4-53 |
| MSLV..... | 4-54 |
| MULTMOD..... | 4-54 |
| NEXTPRIME..... | 4-55 |
| P2C..... | 4-55 |
| PA2B2..... | 4-55 |
| PARTFRAC..... | 4-56 |
| PCAR..... | 4-56 |
| PMINI..... | 4-56 |
| POLYNOMIAL..... | 4-57 |
| POTENTIAL..... | 4-57 |

| | |
|------------------|------|
| POWEXPAND..... | 4-57 |
| POWMOD..... | 4-58 |
| PREVAL..... | 4-58 |
| PREVPRIME..... | 4-58 |
| PROPFRAC..... | 4-59 |
| PTAYL..... | 4-59 |
| QUOT..... | 4-59 |
| QXA..... | 4-60 |
| RCLVX..... | 4-60 |
| REF..... | 4-60 |
| REMAINDER..... | 4-61 |
| REORDER..... | 4-61 |
| RESULTANT..... | 4-61 |
| REWRITE..... | 4-62 |
| RISCH..... | 4-62 |
| RREF..... | 4-62 |
| rref..... | 4-63 |
| RREFMOD..... | 4-63 |
| SERIES..... | 4-64 |
| SEVAL..... | 4-64 |
| SIGMA..... | 4-65 |
| SIGMAVX..... | 4-65 |
| SIGNTAB..... | 4-65 |
| SIMP2..... | 4-66 |
| SIMPLIFY..... | 4-66 |
| SINCOS..... | 4-67 |
| SOLVE..... | 4-67 |
| SOLVEVX..... | 4-68 |
| STORE..... | 4-68 |
| STOVX..... | 4-68 |
| STURM..... | 4-69 |
| STURMAB..... | 4-69 |
| SUBST..... | 4-69 |
| SUBTMOD..... | 4-70 |
| SYLVESTER..... | 4-70 |
| SYST2MAT..... | 4-71 |
| TABVAL..... | 4-71 |
| TABVAR..... | 4-71 |
| TAN2CS2..... | 4-72 |
| TAN2SC..... | 4-72 |
| TAN2SC2..... | 4-73 |
| TAYLOR0..... | 4-73 |
| TCHEBYCHEFF..... | 4-73 |
| TCOLLECT..... | 4-74 |
| TESTS..... | 4-74 |
| TEXPAND..... | 4-74 |
| TLIN..... | 4-74 |
| TRIG..... | 4-75 |
| TRIGCOS..... | 4-75 |
| TRIGO..... | 4-76 |
| TRIGSIN..... | 4-76 |
| TRIGTAN..... | 4-76 |
| TRUNC..... | 4-77 |
| TSIMP..... | 4-77 |
| UNASSIGN..... | 4-77 |
| UNASSUME..... | 4-78 |
| UNBIND..... | 4-78 |
| VANDERMONDE..... | 4-78 |
| VER..... | 4-79 |

| | |
|------------------------------------|------|
| VPOTENTIAL | 4-79 |
| XNUM | 4-79 |
| XQ | 4-80 |
| ZEROS | 4-80 |
| ? | 4-81 |
| ∞ | 4-81 |
| 5. Equation Reference | 5-1 |
| Columns and Beams (1) | 5-3 |
| Elastic Buckling (1, 1) | 5-4 |
| Eccentric Columns (1, 2)..... | 5-4 |
| Simple Deflection (1, 3)..... | 5-5 |
| Simple Slope (1, 4)..... | 5-5 |
| Simple Moment (1, 5)..... | 5-6 |
| Simple Shear (1, 6)..... | 5-6 |
| Cantilever Deflection (1, 7)..... | 5-7 |
| Cantilever Slope (1, 8) | 5-7 |
| Cantilever Moment (1, 9)..... | 5-8 |
| Cantilever Shear (1, 10) | 5-8 |
| Electricity (2) | 5-9 |
| Coulomb's Law (2, 1)..... | 5-10 |
| Ohm's Law and Power (2, 2)..... | 5-10 |
| Voltage Divider (2, 3) | 5-11 |
| Current Divider (2, 4)..... | 5-11 |
| Wire Resistance (2, 5)..... | 5-11 |
| Series and Parallel R (2, 6)..... | 5-12 |
| Series and Parallel C (2, 7)..... | 5-12 |
| Series and Parallel L (2, 8)..... | 5-13 |
| Capacitive Energy (2, 9) | 5-13 |
| Inductive Energy (2, 10) | 5-13 |
| RLC Current Delay (2, 11) | 5-14 |
| DC Capacitor Current (2, 12)..... | 5-14 |
| Capacitor Charge (2, 13)..... | 5-14 |
| DC Inductor Voltage (2, 14) | 5-14 |
| RC Transient (2, 15)..... | 5-15 |
| RL Transient (2, 16)..... | 5-15 |
| Resonant Frequency (2, 17) | 5-16 |
| Plate Capacitor (2, 18) | 5-16 |
| Cylindrical Capacitor (2,19)..... | 5-16 |
| Solenoid Inductance (2, 20) | 5-17 |
| Toroid Inductance (2, 21)..... | 5-17 |
| Sinusoidal Voltage (2, 22) | 5-18 |
| Sinusoidal Current (2, 23)..... | 5-18 |
| Fluids (3) | 5-18 |
| Pressure at Depth (3, 1)..... | 5-19 |
| Bernoulli Equation (3, 2) | 5-19 |
| Flow with Losses (3, 3)..... | 5-20 |
| Flow in Full Pipes (3, 4)..... | 5-21 |
| Forces and Energy (4) | 5-21 |
| Linear Mechanics (4, 1) | 5-22 |
| Angular Mechanics (4, 2)..... | 5-23 |
| Centripetal Force (4, 3) | 5-23 |
| Hooke's Law (4, 4)..... | 5-23 |
| 1D Elastic Collisions (4, 5) | 5-24 |
| Drag Force (4, 6)..... | 5-24 |
| Law of Gravitation (4, 7) | 5-24 |
| Mass-Energy Relation (4, 8) | 5-24 |
| Gases (5) | 5-25 |
| Ideal Gas Law (5, 1)..... | 5-25 |
| Ideal Gas State Change (5, 2)..... | 5-26 |

| | |
|--|------|
| Isothermal Expansion (5, 3)..... | 5-26 |
| Polytropic Processes (5, 4)..... | 5-26 |
| Isentropic Flow (5, 5)..... | 5-26 |
| Real Gas Law (5, 6)..... | 5-27 |
| Real Gas State Change (5, 7)..... | 5-27 |
| Kinetic Theory (5, 8)..... | 5-28 |
| Heat Transfer (6)..... | 5-28 |
| Heat Capacity (6, 1)..... | 5-29 |
| Thermal Expansion (6, 2)..... | 5-29 |
| Conduction (6, 3)..... | 5-29 |
| Convection (6, 4)..... | 5-30 |
| Conduction + Convection (6, 5)..... | 5-30 |
| Black Body Radiation (6, 6)..... | 5-31 |
| Magnetism (7)..... | 5-31 |
| Straight Wire (7, 1)..... | 5-32 |
| Force between Wires (7, 2)..... | 5-32 |
| Magnetic (B) Field in Solenoid (7, 3)..... | 5-33 |
| Magnetic (B) Field in Toroid (7, 4)..... | 5-33 |
| Motion (8)..... | 5-34 |
| Linear Motion (8, 1)..... | 5-35 |
| Object in Free Fall (8, 2)..... | 5-35 |
| Projectile Motion (8, 3)..... | 5-35 |
| Angular Motion (8, 4)..... | 5-36 |
| Circular Motion (8, 5)..... | 5-36 |
| Terminal Velocity (8, 6)..... | 5-36 |
| Escape Velocity (8, 7)..... | 5-36 |
| Optics (9)..... | 5-37 |
| Law of Refraction (9, 1)..... | 5-37 |
| Critical Angle (9, 2)..... | 5-38 |
| Brewster's Law (9, 3)..... | 5-38 |
| Spherical Reflection (9, 4)..... | 5-39 |
| Spherical Refraction (9, 5)..... | 5-39 |
| Thin Lens (9, 6)..... | 5-39 |
| Oscillations (10)..... | 5-40 |
| Mass-Spring System (10, 1)..... | 5-41 |
| Simple Pendulum (10, 2)..... | 5-41 |
| Conical Pendulum (10, 3)..... | 5-42 |
| Torsional Pendulum (10, 4)..... | 5-42 |
| Simple Harmonic (10, 5)..... | 5-42 |
| Plane Geometry (11)..... | 5-43 |
| Circle (11, 1)..... | 5-44 |
| Ellipse (11, 2)..... | 5-44 |
| Rectangle (11, 3)..... | 5-45 |
| Regular Polygon (11, 4)..... | 5-45 |
| Circular Ring (11, 5)..... | 5-46 |
| Triangle (11, 6)..... | 5-46 |
| Solid Geometry (12)..... | 5-47 |
| Cone (12, 1)..... | 5-47 |
| Cylinder (12, 2)..... | 5-48 |
| Parallelepiped (12, 3)..... | 5-48 |
| Sphere (12, 4)..... | 5-49 |
| Solid State Devices (13)..... | 5-49 |
| PN Step Junctions (13, 1)..... | 5-51 |
| NMOS Transistors (13, 2)..... | 5-52 |
| Bipolar Transistors (13, 3)..... | 5-53 |
| JFETs (13, 4)..... | 5-53 |
| Stress Analysis (14)..... | 5-54 |
| Normal Stress (14, 1)..... | 5-55 |
| Shear Stress (14, 2)..... | 5-56 |

| | |
|--|------|
| Stress on an Element (14, 3) | 5-56 |
| Mohr's Circle (14, 4) | 5-57 |
| Waves (15) | 5-57 |
| Transverse Waves (15,1)..... | 5-58 |
| Longitudinal Waves (15, 2) | 5-58 |
| Sound Waves (15, 3)..... | 5-58 |
| References | 5-59 |
| 6. The Development Library | 6-1 |
| Section 1 - Introduction..... | 6-1 |
| Section 2 – The tools of the development library | 6-1 |
| APEEK | 6-1 |
| PEEK | 6-1 |
| POKE | 6-1 |
| PEEKARM | 6-2 |
| POKEARM | 6-2 |
| A→ | 6-2 |
| →A | 6-2 |
| →RAM | 6-2 |
| A→H | 6-2 |
| H→A | 6-2 |
| CD→ | 6-3 |
| →CD | 6-3 |
| →H | 6-3 |
| H→ | 6-3 |
| S→H..... | 6-3 |
| H→S..... | 6-3 |
| SREV | 6-3 |
| MAKESTR..... | 6-4 |
| SERIAL..... | 6-4 |
| →S2..... | 6-4 |
| XLIB~ | 6-4 |
| CRC | 6-4 |
| S~N | 6-4 |
| R~SB | 6-5 |
| SB~B | 6-5 |
| LR~R | 6-5 |
| LC~C | 6-5 |
| COMP→ | 6-5 |
| →ALG | 6-5 |
| →PRG | 6-6 |
| →LST | 6-6 |
| Section 3 - CRLIB..... | 6-6 |
| Section 4 - ASM..... | 6-8 |
| Section 5 – Disassemblers..... | 6-34 |
| ASM→ | 6-34 |
| ARM→..... | 6-35 |
| Section 6 – The Entry Point Library: Extable | 6-35 |
| nop..... | 6-35 |
| GETNAME | 6-35 |
| GETADR..... | 6-36 |
| GETNAMES | 6-36 |
| A. Error and Status Messages..... | A-1 |
| B. Table of Units | B-1 |
| C. System Flags..... | C-1 |
| D. Reserved Variables | D-1 |
| Contents of the Reserved Variables | D-2 |
| αENTER..... | D-2 |
| ALRMDAT | D-2 |

| | |
|--|---------|
| βENTER..... | D-3 |
| CST..... | D-3 |
| ENVSTACK..... | D-4 |
| EQ..... | D-4 |
| EXITED..... | D-4 |
| EXPR..... | D-4 |
| IOPAR..... | D-4 |
| MASD.INI..... | D-6 |
| MHpar..... | D-6 |
| Mpar..... | D-6 |
| n1, n2, | D-6 |
| Nmines..... | D-6 |
| PPAR..... | D-6 |
| PRTPAR..... | D-8 |
| REALASSUME..... | D-8 |
| STARTED..... | D-8 |
| STARTEQW..... | D-9 |
| STARTERR..... | D-9 |
| STARTOFF..... | D-9 |
| STARTRECV..... | D-9 |
| STARTSEND..... | D-9 |
| STARTUP..... | D-9 |
| s1, s2, | D-9 |
| TOFF..... | D-9 |
| VPAR..... | D-9 |
| ZPAR..... | D-10 |
| ΣDAT..... | D-10 |
| ΣPAR..... | D-11 |
| E. Technical Reference..... | E-1 |
| Object Sizes..... | E-1 |
| Symbolic Integration Patterns..... | E-2 |
| Trigonometric Expansions..... | E-4 |
| Source References..... | E-5 |
| F. Parallel Processing with Lists..... | F-1 |
| G. Keyboard Shortcuts..... | G-1 |
| H. The Menu-Number Table..... | H-1 |
| I. The Command Menu-Path Table..... | I-1 |
| J. ASCII Character Codes and Translations..... | J-1 |
| Index..... | Index-1 |

RPL Programming

If you've used a calculator or computer before, you're probably familiar with the idea of *programs*. Generally speaking, a program is something that gets the calculator or computer to do certain tasks for you -- more than a built-in command might do. In the hp49g+/hp48gII, a program is an *object* that does the same thing.

Understanding Programming

An hp49g+/hp48gII program is an object with « » delimiters containing a sequence of numbers, commands, and other objects you want to execute automatically to perform a task.

For example, a program that takes a number from the stack, finds its factorial, and divides the result by 2 would look like this: « ! 2 / » or

```
«
!
2
/
»
```

The Contents of a Program

As mentioned above, a program contains a sequence of objects. As each object is processed in a program, the action depends on the type of object, as summarized below.

Actions for Certain Objects in Programs

| Object | Action |
|--------------------------|---|
| Command | <i>Executed.</i> |
| Number | Put on the stack. |
| Algebraic or `Algebraic` | Algebraic put on the stack. |
| String | Put on the stack. |
| List | Put on the stack. |
| Program | Put on the stack. |
| Global name (quoted) | Put on the stack. |
| Global name (unquoted) | <ul style="list-style-type: none"> ■ Program <i>executed</i>. ■ Name evaluated. ■ Directory becomes current. ■ Other object put on the stack. |
| Local name (quoted) | Put on the stack. |
| Local name (unquoted) | Contents put on the stack |

As you can see from this table, most types of objects are simply put on the stack — but built-in commands and programs called by name cause *execution*. The following examples show the results of executing programs containing different sequences of objects.

Examples of Program Actions

| Program | Results |
|--------------------|--------------------------|
| « 1 2 » | 2: 1 1: 2 |
| « "Hello" {A B} » | 2: "Hello" 1: { A B } |
| « '1+2' » | 1: '1+2' |
| « '1+2' →NUM » | 1: 3 |
| « « 1 2 + » » | 1: « 1 2 + » |
| « « 1 2 + » EVAL » | 1: 3 |

Programs can also contain *structures*. A structure is a program segment with a defined organization. Two basic kinds of structure are available:

- **Local variable structure.** The → command defines local variable names and a corresponding algebraic or program object that's evaluated using those variables.
- **Branching structures.** Structure words (like DO... UNTIL...END) define conditional or loop structures to control the order of execution within a program.

A *local variable structure* has one of the following organizations inside a program:

```
« → name1 ... namen 'algebraic' »
« → name1 ... namen « program » »
```

The → command removes *n* objects from the stack and stores them in the named local variables. The algebraic or program object in the structure is *automatically evaluated* because it's an element of the structure – even though algebraic and program objects are put on the stack in other situations. Each time a local variable name appears in the algebraic or program object, the variable's contents are substituted.

So the following program takes two numbers from the stack and returns a numeric result:

```
« → a b 'ABS(a-b)' »
```

Calculations in a Program

Many calculations in programs take data from the stack. Two typical ways to manipulate stack data are:

- **Stack commands.** Operate directly on the objects on the stack.
- **Local variable structures.** Store the stack objects in temporary local variables, then use the variable names to represent the data in the following algebraic or program object.

Numeric calculations provide convenient examples of these methods. The following programs use two numbers from the stack to calculate the hypotenuse of a right triangle using the formula $\sqrt{x^2 + y^2}$.

```
« SQ SWAP SQ + √ »
« → x y « x SQ y SQ + √ » »
« → x y '√(x^2+y^2)' »
```

The first program uses stack commands to manipulate the numbers on the stack – the calculation uses stack syntax. The second program uses a local variable structure to store and retrieve the numbers – the calculation uses stack syntax. The third program also uses a local variable structure — the calculation uses algebraic syntax. Note that the underlying formula is most apparent in the third program. This third method is often the easiest to write, read, and debug.

Entering and Executing Programs

A program is an object – it occupies one level on the stack, and you can store it in a variable.

To enter a program:

1. Press $\boxed{\rightarrow} \ll \gg$. The `PRG` annunciator appears, indicating program-entry mode is active.
2. Enter the commands and other objects (with appropriate delimiters) in order for the operations you want the program to execute.
 - Press $\boxed{\text{SPC}}$ to separate consecutive numbers.
 - Press $\boxed{\rightarrow}$ to move past closing delimiters.
3. Optional: Press $\boxed{\rightarrow} \boxed{\leftarrow}$ (newline) to start a new line in the command line at any time.
4. Press $\boxed{\text{ENTER}}$ to put the program on the stack.

In Program-entry mode (`PRG` annunciator on), command keys aren't executed -- they're entered in the command line instead. Only nonprogrammable operations such as $\boxed{\leftarrow}$ and $\boxed{\text{VAR}}$ are executed.

Line breaks are discarded when you press $\boxed{\text{ENTER}}$.

To enter commands and other objects in a program:

- Press the keyboard or menu key for the command or object. All commands can also be selected from the $\boxed{\rightarrow} \text{CAT}$ list.

This guide assumes that Flag -117 is clear, so that you see menus rather than choose boxes wherever possible. Also RPN mode should be set.

or

- Type the characters using the alpha keyboard.

Refer to the hp49g+/hp48gII User's Guide for how to use the alpha keyboard.

In this guide an abbreviated convention is used whereby invocations of the alpha keyboard are not always shown. In the next example we show:

$\boxed{\text{'}} \text{VOL} \boxed{\text{STO}}$ *where the alpha "VOL" can be entered as shown:*

$\boxed{\text{'}} \boxed{\text{ALPHA}} \boxed{\text{ALPHA}} \text{VOL} \boxed{\text{ALPHA}} \boxed{\text{STO}}$ *(assuming Flag -60 is clear).*

To store or name a program:

1. Enter the program on the stack.
2. Enter the variable name (with ' delimiters) and press $\boxed{\text{STO}}$.

You can choose descriptive names for programs. Here are some ideas of what the name can describe:

- The calculation or action. Examples: *SPH* (spherical-cap volume), *SORT* (sort a list).
- The input and output. Examples: *X→FX* (x to $f(x)$), *RH→V* (radius-and -height to volume).
- The technique. Example: *SPHLV* (spherical-cap volume using local variables).

To execute a program:

- Press $\boxed{\text{VAR}}$ then the menu key for the program name.
 - or**
 - Enter the program name (with *no* delimiters) and press $\boxed{\text{ENTER}}$.
 - or**
 - Put the program name in level 1 and press $\boxed{\text{EVAL}}$.
 - or**
 - Put the program object in level 1 and press $\boxed{\text{EVAL}}$.

To stop an executing program:

■ Press $\overline{\text{CANCEL}}$.

Example: Enter a program that takes a radius value from the stack and calculates the volume of a sphere of radius r using

$$V = \frac{4}{3} \pi r^3$$

If you were going to calculate the volume manually after entering the radius on the stack, you might press these keys:

3 $\overline{y^x}$ $\overline{\leftarrow}$ π \times 4 $\overline{\text{ENTER}}$ 3 \div \times $\overline{\rightarrow}$ \rightarrow NUM

Enter the same keystrokes in a program. ($\overline{\rightarrow}$ $\overline{\leftarrow}$ just starts a new line.)

$\overline{\rightarrow}$ $\ll \gg$

3 $\overline{y^x}$ $\overline{\leftarrow}$ π \times 4 SPC 3 \div \times

$\overline{\rightarrow}$ $\overline{\leftarrow}$ $\overline{\rightarrow}$ \rightarrow NUM

```

« 3 ^ π * 4 3 / *
→NUM
»
←SKIP SKIP →DEL DEL→ DEL L INS

```

Put the program on the stack.

$\overline{\text{ENTER}}$

```

1: « 3 ^ π * 4 3 / *
→NUM »
INFOR NOVAL CHOOS INPUT KEY WAIT

```

Store the program in variable *VOL*. Then put a radius of 4 on the stack and run the *VOL* program.

$\overline{\text{'}}$ VOL $\overline{\text{STO}}$

4 $\overline{\text{VAR}}$ $\overline{\text{NUM}}$

```

1: 268.08257306
STACK MEM BRCH TEST TYPE LIST

```

The program is

```
« 3 ^ π * 4 3 / * →NUM »
```

Example: Replace the program from the previous example with one that's easier to read. Enter a program that uses a local variable structure to calculate the volume of a sphere. The program is

```
« → r '4/3*π*r^3' →NUM »
```

(You need to include \rightarrow NUM because π causes a symbolic result, unless Flag -2 or Flag -3 is set)

Enter the program. ($\overline{\rightarrow}$ $\overline{\leftarrow}$ just starts a new line.)

$\overline{\rightarrow}$ $\ll \gg$

$\overline{\rightarrow}$ \rightarrow r SPC

$\overline{\text{'}}$ 4 \div 3 \times $\overline{\leftarrow}$ π \times

r $\overline{y^x}$ 3 $\overline{\rightarrow}$ $\overline{\leftarrow}$ $\overline{\rightarrow}$ \rightarrow NUM

```

« → r '4/3*π*r^3'
→NUM
»
←SF ←CF ←FS? ←FC? ←FS?C ←FC?C

```

Put the program on the stack, store it in *VOL*, and calculate the volume for a radius of 4.

$\overline{\text{'}}$ VOL $\overline{\text{STO}}$

4 $\overline{\text{NUM}}$

```

1: 268.082573106
VOL H R MM D SPH

```

Example: Enter a program *SPH* that calculates the volume of a spherical cap of height h within a sphere of radius R using values stored in variables H and R .

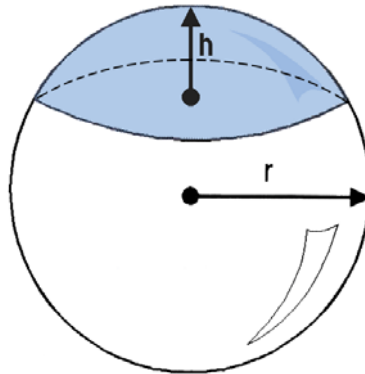

$$V = \frac{1}{3}\pi h^2(3r - h)$$

In this and following chapters on programming, “stack diagrams” show what arguments must be on the stack before a program is executed and what results the program leaves on the stack. Here's the stack diagram for *SPH*.

| | | |
|----------------|---|----------------|
| Level 1 | → | Level 1 |
| | → | <i>volume</i> |

The diagram indicates that *SPH* takes no arguments from the stack and returns the volume of the spherical cap to level 1. (*SPH* assumes that you've stored the numerical value for the radius in variable R and the numerical value for the height in variable H . These are *global* variables — they exist outside the program.)

Program listings are shown with program steps in the left column and associated comments in the right column. Remember, you can either press the command keys or type in the command names to key in the program. In this first listing, the keystrokes are also shown.

| Program: | Keys: | Comments: |
|-----------------|------------------|--|
| ⌘ | ⌘ | Begins the program. |
| '1/3 | 1 3 | Begins the algebraic expression to calculate the volume. |
| *π*H^2 | π H 2 | Multiplies by πh^2 . |
| *(3*R-H)' | () 3 R H | Multiplies by $3r - h$, completing the calculation and ending the expression. |
| →NUM | →NUM | Converts the expression with π to a number. |
| ⌘ | SPH | Ends the program. Puts the program on the stack. Stores the program in variable <i>SPH</i> . |

This is the program:

```
« '1/3*π*H^2*(3*R-H)' →NUM »
```

Now use *SPH* to calculate the volume of a spherical cap of radius $r = 10$ and height $h = 3$.

First, store the data in the appropriate variables. Then select the VAR menu and execute the program. The answer is returned to level 1 of the stack.

10 [] R [STO▶]
 3 [] H [STO▶]
 [VAR] [3 3 3]

```
1: 254.469004942
H R SPH VOL MM π
```

Viewing and Editing Programs

You view and edit programs the same way you view and edit other objects — using the command line.

To view or edit a program:

- View the program:
 - If the program is in level 1, press ∇ (or use the EDIT command).
 - If the program is stored in a variable, use the Filer (\leftarrow FILES) to select the variable and press [F1A] , or press [VAR], then \rightarrow and the variable's menu key (a shortcut to recall a variable's contents to level 1), followed by ∇ . Alternatively, with the variable *name* in level 1 press \leftarrow ∇ (or use the EDITB, VISIT or VISITB command).
- Optional: Make changes.
- Press [ENTER] to save any changes (or press $\overline{\text{CANCEL}}$ to discard changes) and return to the stack, or to Filer if you used Filer to select the program.

Filer lets you change a stored program without having to do a store operation. From the stack you can change a program and then store the new version in a different variable.

While you're editing a program, you may want to switch the command-line entry mode between Program-entry mode (for editing most objects) and Algebraic/Program-entry mode (for editing algebraic objects). The PRG and ALG annunciators indicate the current mode.

To switch between entry modes:

- Press \rightarrow ENTRY.

Example: Edit *SPH* from the previous example so that it stores the number from level 1 into variable *H* and the number from level 2 into variable *R*.

Select *SPH* from the soft keys.

[VAR] \rightarrow [3 3 3] ∇

```
◀ '1/3*π*H^2*(3*R-H)'
→NUM
▶
←SKIP SKIP→ +DEL DEL→ DEL L INS▶
```

Move the cursor past the first program delimiter and insert the new program steps.

\rightarrow [] H \rightarrow [STO▶]
 [] R \rightarrow [STO▶]

```
◀ 'H' STO 'R' STO '1/3...
→NUM
▶
←SKIP SKIP→ +DEL DEL→ DEL L INS▶
```

Save the edited version of *SPH* in the variable. Then, to verify that the changes were saved, view *SPH* in the command line.

[ENTER] [VAR] \leftarrow [3 3 3]



```

↓ 'H' STO 'R' STO '1/
3*π*H^2*(3*R-H)' →NUM
*
←SKIP←SKIP←+DEL DEL←DEL L INS

```

Press **CANCEL** to stop viewing.

Creating Programs on a Computer

It is convenient to create programs and other objects on a computer and then load them into the hp49g+/hp48gII. If you are creating programs on a computer, you can include “comments” in the computer version of the program.

To include a comment in a program:

- Enclose the comment text between two @ characters.
- OR**
- Enclose the comment text between one @ character and the end of the line.

Whenever the hp49g+/hp48gII processes text entered in the command line — either from keyboard entry or transferred from a computer — it strips away the @ characters and the text they surround. However, @ characters are not affected if they're inside a string.

Using Local Variables

The program *SPH* in the previous example uses global variables for data storage and recall. There are disadvantages to using global variables in programs:

- After program execution, global variables that you no longer need to use must be purged if you want to clear the VAR menu and free user memory.
- You must explicitly store data in global variables prior to program execution, or have the program execute STO.

Local variables address the disadvantages of global variables in programs. Local variables are temporary variables *created by a program*. They exist only while the program is being executed and cannot be used outside the program. They never appear in the VAR menu. In addition, local variables are accessed faster than global variables. (By convention, this manual uses lowercase names for local variables.) A compiled local variable is a form of local variable that can be used outside of the program that creates it. See "Compiled Local Variables" on page 1-10 for more information.

Creating Local Variables

In a program, a *local variable structure* creates local variables.

To enter a local variable structure in a program:

1. Enter the → command (press →).
2. Enter one or more variable names.
3. Enter a *defining procedure* (an algebraic or program object) that uses the names.

⌘ ÷ *name*₁ *name*₂ ... *name*_{*n*} 'algebraic' ⌘

OR

⌘ ÷ *name*₁ *name*₂ ... *name*_{*n*} ⌘ *program* ⌘

When the → command is executed in a program, *n* values are taken from the stack and assigned to variables *name*₁ *name*₂, ..., *name*_{*n*}.

For example, if the stack looks like this:

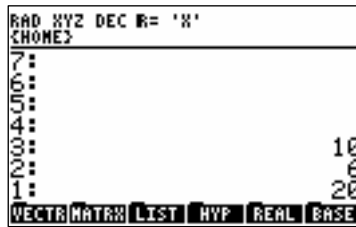

then

- a creates local variable $a = 20$.
- $a b$ creates local variables $a = 6$ and $b = 20$.
- $a b c$ creates local variables $a = 10$, $b = 6$, and $c = 20$.

The defining procedure then uses the local variables to do calculations.

Local variable structures have these advantages:

- The → command stores the values from the stack in the corresponding variables — you don't need to explicitly execute STO.
- Local variables automatically disappear when the defining procedure for which they are created has completed execution. Consequently, local variables don't appear in the VAR menu, and they occupy user memory only during program execution.
- Local variables exist only within their defining procedure — different local variable structures can use the same variable names without conflict.

Example: The following program *SPHLV* calculates the volume of a spherical cap using local variables. The defining procedure is an algebraic expression.

| | | | |
|----------------|----------------|---|----------------|
| Level 2 | Level 1 | → | Level 1 |
| <i>r</i> | <i>h</i> | → | <i>volume</i> |

| Program: | Comments: |
|-------------------------------------|--|
| ⌘ | |
| → <i>r h</i> | Creates local variables <i>r</i> and <i>h</i> for the radius of the sphere and height of the cap. |
| ' $1/3 * \pi * h^2 * (3 * r - h)$ ' | Expresses the defining procedure. In this program, the defining procedure for the local variable structure is an algebraic expression. |
| → NUM | Converts expression to a number. |
| ⌘ | |
| ⌘ SPHLV ⌘ | Stores the program in variable <i>SPHLV</i> . |

Now use *SPHLV* to calculate the volume of a spherical cap of radius $r = 10$ and height $h = 3$. Enter the data on the stack in the correct order, then execute the program.

10 3

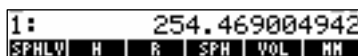

Evaluating Local Names

Local names are evaluated differently from global names. When a global name is evaluated, the object stored in the corresponding variable is itself evaluated. (You've seen how programs stored in global variables are automatically evaluated when the name is evaluated.)

When a local name is evaluated, the object stored in the corresponding variable is returned to the stack but is *not* evaluated. When a local variable contains a number, the effect is identical to evaluation of a global name, since putting a number on the stack is equivalent to evaluating it. However, if a local variable contains a program, algebraic expression, or global variable name — and if you want it evaluated — the program should execute EVAL after the object is put on the stack.

Defining the Scope of Local Variables

Local variables exist *only* inside the defining procedure.

Example: The following program excerpt illustrates the availability of local variables in *nested* defining procedures (procedures within procedures). Because local variables *a*, *b*, and *c* already exist when the defining procedure for local variables *d*, *e*, and *f* is executed, they're available for use in that procedure.

| Program: | Comments: |
|--|---|
| <pre> « . . . </pre> | <p>No local variables are available.</p> |
| <pre> + a b c </pre> | <p>Defines local variables <i>a</i>, <i>b</i>, <i>c</i>.</p> |
| <pre> « a b + c + + d e f 'a/(d*e+f)' </pre> | <p>Local variables <i>a</i>, <i>b</i>, <i>c</i> are available in this procedure. Defines local variables <i>d</i>, <i>e</i>, <i>f</i>. Local variables <i>a</i>, <i>b</i>, <i>c</i> and <i>d</i>, <i>e</i>, <i>f</i> are available in this procedure.</p> |
| <pre> a c / - » . . . » </pre> | <p>Only local variables <i>a</i>, <i>b</i>, <i>c</i> are available. No local variables are available.</p> |

Example: In the following program excerpt, the defining procedure for local variables d , e , and f calls a program that you previously created and stored in global variable $P1$.

| Program: | Comments: |
|---|--|
| ⌘ . | |
| → a b c | |
| ⌘ a b + c + → d e f 'P1+a/(d*e+f)' | Defines local variables d, e, f . Local variables a, b, c and d, e, f are available in this procedure. The defining procedure executes the program stored in variable $P1$. |
| a c / - ⌘ . ⌘ | |

The six local variables are *not* available in program $P1$ because they didn't exist when you created $P1$. The objects stored in the local variables are available to program $P1$ only if you put those objects on the stack for $P1$ to use or store those objects in global variables.

Conversely, program $P1$ can create its own local variable structure (with any names, such as a , c , and f , for example) without conflicting with the local variables of the same name in the procedure that calls $P1$. It is possible to create a special type of local variable that can be used in other programs or subroutines. This type of local variable is called a compiled local variable.

Compiled Local Variables

Global variables use up memory, and local variables can't be used outside of the program they were created in. Compiled local variables bridge the gap between these two variable types. To programs, compiled local variables look like global variables, but to the calculator they act like local variables. This means you can create a compiled local variable in a local variable structure, use it in any other program that is called within that structure, and when the program finishes, the variable is gone.

Compiled local variables have a special naming convention: they must begin with a ⌘. For example,

```
⌘
→ ⌘y
'IFTE(⌘y<0,BELOW,ABOVE)'
```

The variable ⌘y is a compiled local variable that can be used in the two programs BELOW and ABOVE.

Creating User-Defined Functions as Programs

The defining procedure for a local variable structure can be either an algebraic or program object.

A program that consists solely of a local variable structure whose defining procedure is an algebraic expression is a user-defined function.

If a program begins with a local variable structure and has a program as the defining procedure, the complete program acts like a user-defined function in two ways: it takes numeric or symbolic arguments, and takes those arguments either from the stack or in algebraic syntax. However, it does not have a derivative. (The defining program must, like algebraic defining procedures, return only one result to the stack.)

There's an advantage to using a program as the defining procedure for a local variable structure: The program can contain commands not allowed in algebraic expressions. For example, loop structures are not allowed in algebraic expressions.

Using Tests and Conditional Structures

You can use commands and branching structures that let programs ask questions and make decisions. *Comparison functions* and *logical functions* test whether or not specified conditions exist. *Conditional structures* and *conditional commands* use test results to make decisions.

Testing Conditions

A test is an algebraic or a command sequence that returns a *test result* to the stack. A test result is either *true* — indicated by a value of 1. — or it is *false* — indicated by a value of 0..

To include a test in a program:

- To use stack syntax, enter the two arguments, then enter the test command.
- To use algebraic syntax, enter the test expression (with ' delimiters).









You often use test results in conditional structures to determine which clause of the structure to execute. Conditional structures are described under Using Conditional Structures and Commands, p.1-13.

Example: Test whether or not X is less than Y . To use stack syntax, enter $\times \vee \lessdot$. To use algebraic syntax, enter $'\times\lessdot Y'$. (For both cases, if X contains 5 and Y contains 10, then the test is true and 1. is returned to the stack.)

Using Comparison Functions

Comparison functions compare two objects, using either stack syntax or algebraic syntax.

Comparison Functions

| Key | Programmable Command | Description |
|---|----------------------|---|
|  PRG  TEST (pages 1 and 2): | | |
|  | == | Tests equality of two objects. |
|  | ≠ | Not equal. |
|  | < | Less than. |
|  | > | Greater than. |
|  | ≤ | Less than or equal to. |
|  | ≥ | Greater than or equal to. |
|  | SAME | Identical. Like ==, but doesn't allow a comparison between the numerical value of an algebraic (or name) and a number. Also considers the wordsize of a binary integer. |

The comparison commands return 1. (true) or 0. (false) based on the comparison — or an expression that can evaluate to 1. or 0.. The order of the comparison is “level 2 *test* level 1,” where *test* is the comparison function.

All comparison commands except SAME return the following:

- If neither object is an algebraic or a name, returns 1. if the two objects are the same type and have the same value, or 0. otherwise. For example, if 6 is stored in X, `X 5 <` puts 6 and 5 on the stack, then removes them and returns 0.. (Lists and programs are considered to have same value if the objects they contain are identical. For strings, “less than” means “alphabetically previous.”)
- If one object is an algebraic (or name) and the other object is an algebraic (or name) or a number, returns an expression that must be evaluated to get a test result based on numeric values. For example, if 6 is stored in X, `'X' 5 <` returns `'X<5'`, then `→NUM` returns 0..

(Note that `==` is used for comparisons, while `=` separates two sides of an equation.)







SAME returns 1. (true) if two objects are identical. For example, `'X+3' 4 SAME` returns 0. regardless of the value of X because the algebraic `'X+3'` is not identical to the real number 4. Binary integers must have the same wordsize and the same value to be identical. For all object types other than algebraics, names, and binary integers, SAME works just like `==`.

You can use any comparison function (except SAME) in an algebraic by putting it *between* its two arguments. For example, if 6 is stored in X, `'X<5' →NUM` returns 0..

Using Logical Functions

Logical functions return a test result based on the outcomes of one or two previously executed tests. Note that these four functions interpret *any nonzero argument* as a true result.

Logical Functions

| Keys | Programmable Command | Description |
|---|----------------------|--|
|  PRG  NXT | | |
|  | AND | Returns 1. (true) only if both arguments are true (0. otherwise). |
|  | OR | Returns 1. (true) if either or both arguments are true (0. otherwise). |
|  | XOR | Returns 1. (true) if either argument, but not both, is true (0. otherwise). |
|  | NOT | Returns 1. (true) if the argument is 0 (false); otherwise, returns 0. (false). |



AND, OR, and XOR combine two test results. For example, if 4 is stored in Y, `Y 8 < 5 AND` returns 1.. First, `Y 8 <` returns 1. to the stack. AND removes 1. and 5 from the stack, interpreting both as true results, and returns 1. to the stack.

NOT returns the logical inverse of a test result. For example, if 1 is stored in X and 2 is stored in Y, `X Y < NOT` returns 0.



You can use AND, OR, and XOR in algebraics as *infix* functions. For example, `'3<5 XOR 4>7' →NUM` returns 1.

You can use NOT as a *prefix* function in algebraics. For example, 'NOT Z=4' →NUM returns 0. if Z=2.

Testing Object Types

The TYPE command ( ) takes any object as its argument and returns the number that identifies that object type. For example, "HELLO" TYPE returns 2, the value for a string object. See the table of object types in chapter 3, in the TYPE command, to find hp49g+/hp48gII objects and their corresponding type numbers.



Testing Linear Structure

The LININ command ( ) takes an algebraic equation on level 2 and a variable on level 1 as arguments and returns 1. if the equation is linear for that variable, or 0. if it is not. For example, 'H+Y^2' 'H' LININ returns 1. because the equation is structurally linear for H. See the LININ command in chapter 3 for more information.

Using Conditional Structures and Commands

Conditional structures let a program make a decision based on the results of tests.

Conditional commands let you execute a true-clause or a false-clause (each of which are a *single* command or object).

These conditional structures and commands are contained in the PRG BRCH menu ( 

- IF ... THEN ... END structure.
- IF ... THEN ... ELSE ... END structure.
- CASE ... END structure.
- IFT (if-then) command.
- IFTE (if-then-else) function.

The IF ... THEN ... END Structure

The syntax for this structure is

❖ ... IF *test-clause* THEN *true-clause* END ... ❖

IF ... THEN ... END executes the sequence of commands in the *true-clause* only if the test-clause evaluates to true. The *test-clause* can be a command sequence (for example, A E =) or an algebraic (for example, 'A=E'). If the test-clause is an algebraic, it's *automatically evaluated* to a number — you don't need → NUM or EVAL.

IF begins the test-clause, which leaves a test result on the stack.

THEN removes the test result from the stack. If the value is nonzero, the true-clause is executed — otherwise, program execution resumes following END. See "Conditional Examples" on page 1-15.

To enter IF ... THEN ... END in a program:

- Press   .

The IFT Command

The IFT command takes two arguments: a *test-result* in level 2 and a *true-clause* object in level 1. If the test-result is true, the true-clause object is executed — otherwise, the two arguments are removed from the stack. See "Conditional Examples" on page 1-15.

To enter IFT in a program:

- Press    .

The IF ... THEN ... ELSE ... END Structure

The syntax for this structure is

```
❖ ... IF test-clause
    THEN true-clause ELSE false-clause END ... ❖
```

IF ... THEN ... ELSE ... END executes either the *true-clause* sequence of commands if the *true-clause* is true, or the *false-clause* sequence of commands if the *true-clause* is false. If the test-clause is an algebraic, it's automatically evaluated to a number — you don't need →NUM or EVAL.

IF begins the test-clause, which leaves a test result on the stack. THEN removes the test result from the stack. If the value is nonzero, the true-clause is executed — otherwise, the false-clause is executed. After the appropriate clause is executed, execution resumes following END. See "Conditional Examples" on page 1-15.

To enter IF ... THEN ... ELSE ... END in a program:

■ Press  PRG   .

The IFTE Function

The algebraic syntax for this function is 'IFTE(*test*, *true-clause*, *false-clause*)'

If test evaluates true, the true-clause algebraic is evaluated — otherwise, the *false-clause* algebraic is evaluated.

You can also use the IFTE function with stack syntax. It takes three arguments: a *test-result* in level 3, a *true-clause* object in level 2, and a *false-clause* object in level 1. See "Conditional Examples" on page 1-15.

To enter IFTE in a program or in an algebraic:

■ Press  PRG  NXT  .

The CASE ... END Structure





The syntax for this structure is

```
❖ ... CASE
    test-clause1 THEN true-clause1 END
    test-clause2 THEN true-clause2 END
    ...
    test-clausen THEN true-clausen END
    default-clause (optional)
END ... ❖
```

The CASE ... END structure lets you execute a series of *test-clause* commands, then execute the appropriate *true-clause* sequence of commands. The first test that returns a true result causes execution of the corresponding true-clause, ending the CASE ... END structure. Optionally, you can include after the last test a *default-clause* that's executed if all the tests evaluate to false. If a test-clause is an algebraic, it's automatically evaluated to a number — you don't need →NUM or EVAL.

When CASE is executed, test-clause₁ is evaluated. If the test is true, true-clause₁ is executed, and execution skips to END. If test-clause₁ is false, execution proceeds to test-clause₂. Execution within the CASE structure continues until a true-clause is executed, or until all the test-clauses evaluate to false. If a default clause is included, it's executed if all the test-clauses evaluate to false. See "Conditional Examples" below.

To enter CASE ... END in a program:

1. Press  PRG   to enter CASE ... THEN ...END...END
2. For each additional test-clause, move the cursor after a test-clause END and press   to enter THEN ... END.

Conditional Examples

These examples illustrate conditional structures in programs.

Example: One Conditional Action. The programs below test the value in level 1 — if the value is positive, it's made negative. The first program uses a command sequence as the test-clause:

```
« DUP IF 0 > THEN NEG END »
```

The value on the stack must be duplicated because the > command removes two arguments from the stack (0. and the copy of the value made by DUP).

The following version uses an algebraic as the test clause:

```
« + x « x IF 'x>0' THEN NEG END » »
```

The following version uses the IFT command:

```
« DUP 0 > « NEG » IFT »
```

Example: One Conditional Action. This program multiplies two numbers if both are nonzero.

| Program: | Comments: |
|---|--|
| « | |
| → x y | Creates local variables x and y containing the two numbers from the stack. |
| « IF 'x≥0' 'y≥0' AND THEN x y * | Starts the test-clause. Tests one of the numbers and leaves a test result on the stack. Tests the other number, leaving another test result on the stack. Tests whether both tests were true. Ends the test-clause, starts the true-clause. Multiplies the two numbers together only if AND returns true. |
| END » » | Ends the true-clause. |

The following program accomplishes the same task as the previous program:

```
« → x y « IF 'x AND y' THEN x y * END » »
```

The test-clause 'x AND y' returns “true” if both numbers are nonzero.

The following version uses the IFT command:

```
« → x y « 'x AND y' 'x*y' IFT » »
```

Example: Two Conditional Actions. This program takes a value x from the stack and calculates $(\sin x) / x$. At $x=0$ the division would error, so the program returns the limit value 1 in this case.

```
« → x « IF 'x≠0' THEN x SIN x / ELSE 1 END » »
```

The following version uses IFTE algebraic syntax:

« + × 'IFTE(x≠0,SIN(x)/x,1)' »

Example: Two Conditional Actions. This program multiplies two numbers together if they're both nonzero — otherwise, it returns the string “ZERO”.

| Program: | Comments: |
|--|--|
| « | |
| → n1 n2 | Creates the local variables. |
| « IF 'n1≠0 AND n2≠0' THEN n1 n2 * ELSE "ZERO" END | Starts the defining procedure. Starts the test clause. Tests <i>n1</i> and <i>n2</i> . If both numbers are nonzero, multiplies the two values. Otherwise, returns the string ZERO. Ends the conditional. |
| » » | Ends the defining procedure. |

Example: Two Conditional Actions. This program tests if two numbers on the stack have the same value. If so, it drops one of the numbers and stores the other in variable *V1* — otherwise, it stores the number from level 1 in *V1* and the number from level 2 in *V2*.

| Program: | Comments: |
|---|--|
| « | |
| IF DUP2 SAME THEN DROP 'V1' STO ELSE 'V1' STO 'V2' STO END | For the test clause, copies the numbers in levels 1 and 2 and tests if they have the same value. For the true clause, drops one of the numbers and stores the other in <i>V1</i> . For the false clause, stores the level 1 number in <i>V1</i> and the level 2 number in <i>V2</i> . Ends the conditional structure. |
| » | |
| ENTER ' TST STO▶ | Puts the program on the stack. Stores it in <i>TST</i> . |

Enter the numbers 26 and 52, then execute *TST* to compare their values. Because the two numbers aren't equal, the VAR menu now contains two new variables *V1* and *V2*.

26 ENTER 52 VAR

V2 V1 TST TOR3W TOR3A SPHLU

Example: Multiple Conditional Actions. The following program stores the level 1 argument in a variable if the argument is a string, list, or program.

| Program: | Comments: |
|--|---|
| « | |
| → y « | Defines local variable <i>y</i> . Starts the defining procedure. |
| CASE y TYPE 2 SAME THEN y 'STR' STO END y TYPE 5 SAME THEN y 'LIST' STO END y TYPE 8 SAME THEN y 'PROG' STO END | Starts the case structure. Case 1: If the argument is a string, stores it in <i>STR</i> . Case 2: If the argument is a list, stores it in <i>LIST</i> . Case 3: If the argument is a program, stores it in <i>PROG</i> . |
| END » | Ends the case structure. Ends the defining procedure. |
| » | |

Using Loop Structures

You can use loop structures to execute a part of a program repeatedly. To specify in advance how many times to repeat the loop, use a *definite loop*. To use a test to determine whether or not to repeat the loop, use an *indefinite loop*.

Loop structures let a program execute a sequence of commands several times. Loop structures are built with commands — called structure words — that work only when used in proper combination with each other. These loop structure commands are contained in the PRG BRCH menu (◀ PRG ████):

- START... NEXT and START... STEP.
- FOR ... NEXT and FOR...STEP
- DO ... UNTIL ...END.
- WHILE... REPEAT... END.

In addition, the Σ function provides an alternative to definite loop structures for summations.

Using Definite Loop Structures

Each of the two definite loop structures has two variations:

- NEXT. The counter increases by 1 for each loop.
- STEP. The counter increases or decreases by a specified amount for each loop.

The START ... NEXT Structure

The syntax for this structure is

« ... *start finish* START *loop-clause* NEXT... »

START ... NEXT executes the loop-clause sequence of commands one time for each number in the range *start* to *finish*. The loop-clause is always executed at least once.

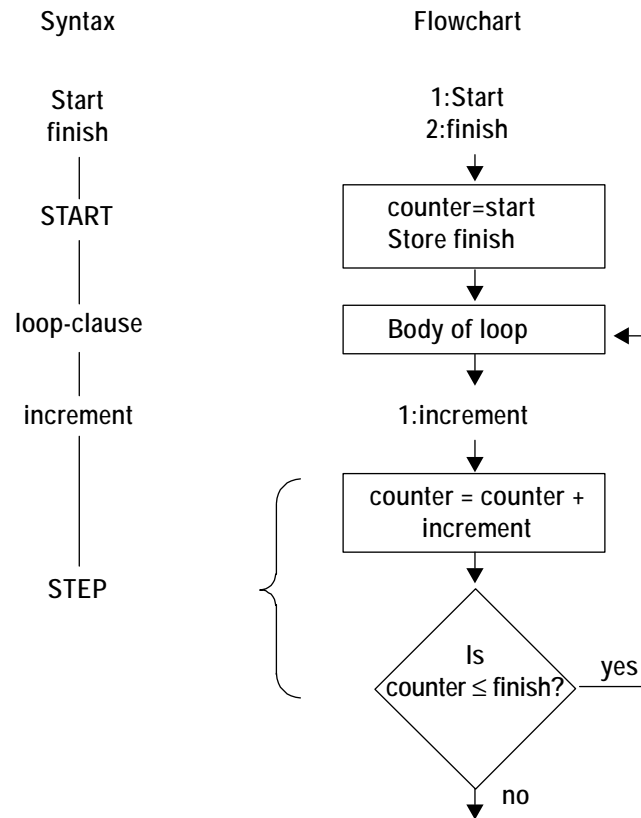

START ... STEP Structure

START takes two numbers (*start* and *finish*) from the stack and stores them as the starting and ending values of the loop counter. Then the loop-clause is executed. STEP takes the increment value from the stack and increments the counter by that value. If the argument of STEP is an algebraic or a name, it's automatically evaluated to a number.

The increment value can be positive or negative. If it's positive, the loop is executed again if the counter is less than or equal to *finish*. If the increment value is negative, the loop is executed if the counter is greater than or equal to *finish*. Otherwise, execution resumes following STEP. In the previous flowchart, the increment value is positive.

To enter START ... STEP in a program:

■ Press PRG .

Example: The following program takes a number x from the stack and calculates the square of that number several times ($x/3$ times):

```
⊛ DUP ÷ × ⊛ × 1 START × SQ -> STEP ⊛ ⊛
```

The FOR ... NEXT Structure

The syntax for this structure is

```
⊛ ... start finish FOR counter loop-clause increment NEXT ... ⊛
```

FOR ... NEXT executes the loop-clause program segment one time for each number in the range start to finish, using local variable counter as the loop counter. You can use this variable in the loop-clause. The loop-clause is always executed at least once.

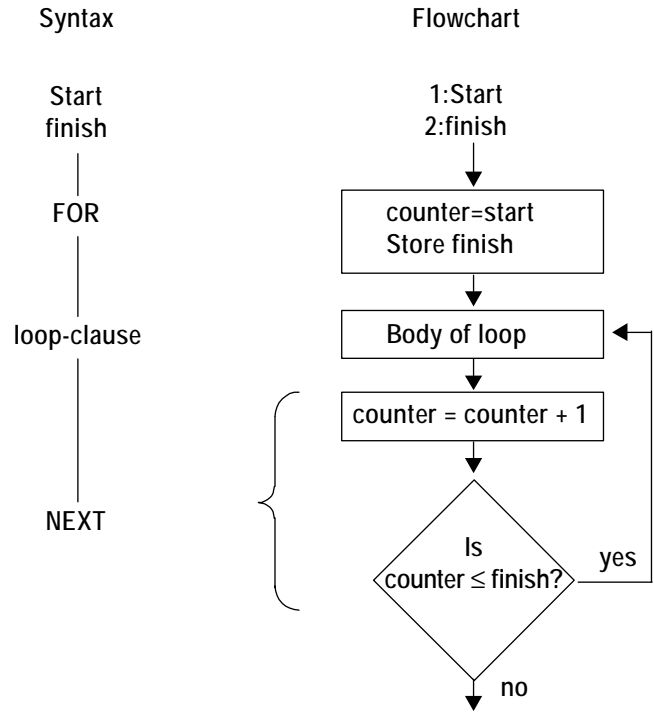

FOR ... NEXT Structure

FOR takes *start* and *finish* from the stack as the beginning and ending values for the loop counter, then creates the local variable *counter* as a loop counter. Then the loop-clause is executed — *counter* can appear within the loop-clause. NEXT increments *counter* by one, and then tests whether its value is less than or equal to *finish*. If so, the *loop-clause* is repeated (with the new value of *counter*) — otherwise, execution resumes following NEXT. When the loop is exited, *counter* is purged.

To enter FOR ... NEXT in a program:

■ Press PRG .

Example: The following program places the squares of the integers 1 through 5 on the stack:

```
« 1 5 FOR j j SQ NEXT »
```

Example: The following program takes the value *x* from the stack and computes the integer powers *i* of *x*. For example, when *x* =12 and *start* and *finish* are 3 and 5 respectively, the program returns 12³, 12⁴ and 12⁵. It requires as inputs *start* and *finish* in level 3 and 2, and *x* in level 1. (⇒ × removes *x* from the stack, leaving *start* and *finish* there as arguments for FOR.)

```
« ⇒ x « FOR n 'x^n' EVAL NEXT » »
```

The FOR ... STEP Structure

The syntax for this structure is

```
« ... start finish FOR counter loop-clause increment STEP ... »
```

FOR ... STEP executes the *loop-clause* sequence just like FOR ... NEXT does — except that the program specifies the increment value for *counter*, rather than incrementing by 1. The loop-clause is always executed at least once.

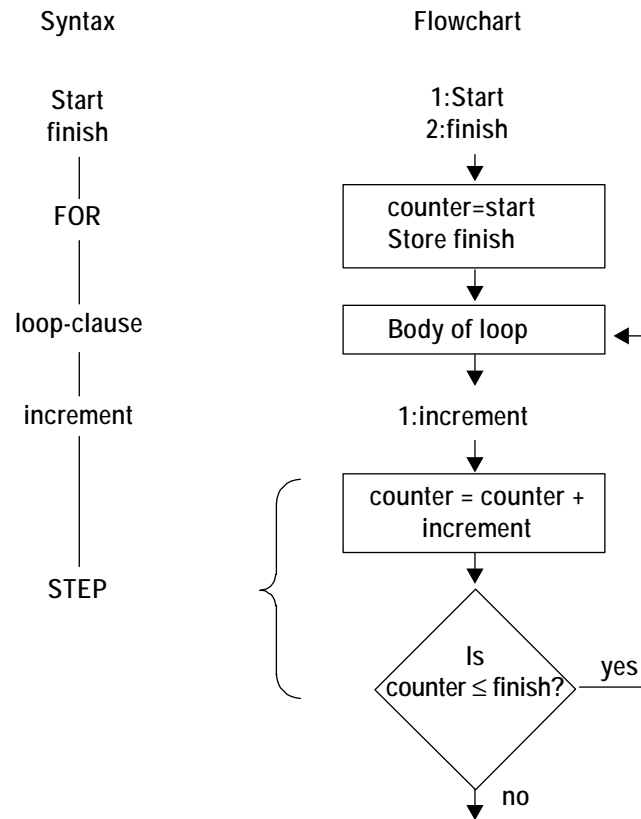

FOR ... STEP Structure

FOR takes *start* and *finish* from the stack as the beginning and ending values for the loop counter, then creates the local variable *counter* as a loop counter. Next, the loop-clause is executed — *counter* can appear within the loop-clause. STEP takes the increment value from the stack and increments *counter* by that value. If the argument of STEP is an algebraic or a name, it's automatically evaluated to a number.

The increment value can be positive or negative. If the increment is positive, the loop is executed again if *counter* is less than or equal to *finish*. If the increment is negative, the loop is executed if *counter* is greater than or equal to *finish*. Otherwise, *counter* is purged and execution resumes following STEP. In the previous flowchart, the increment value is positive.

To enter FOR ... STEP in a program:

■ Press PRG .

Example: The following program places the squares of the integers 1, 3, 5, 7, and 9 on the stack:

```
« 1 9 FOR × × SQ 2 STEP »
```

Example: The following program takes *n* from the stack, and returns the series of numbers 1, 2, 4, 8, 16, ..., *n*. If *n* isn't in the series, the program stops at the last value less than *n*.

```
« 1 SWAP FOR n n n STEP »
```

The first *n* is the local variable declaration for the FOR loop. The second *n* is put on the stack each iteration of the loop. The third *n* is used by STEP as the step increment.

Using Indefinite Loop Structures

The DO ... UNTIL ... END Structure

The syntax for this structure is

⌘ ... DO loop-clause UNTIL test-clause END ... ⌘

DO... UNTIL... END executes the *loop-clause* sequence repeatedly until *test-clause* returns a true (nonzero) result. Because the test-clause is executed *after* the loop-clause, the loop-clause is always executed at least once.

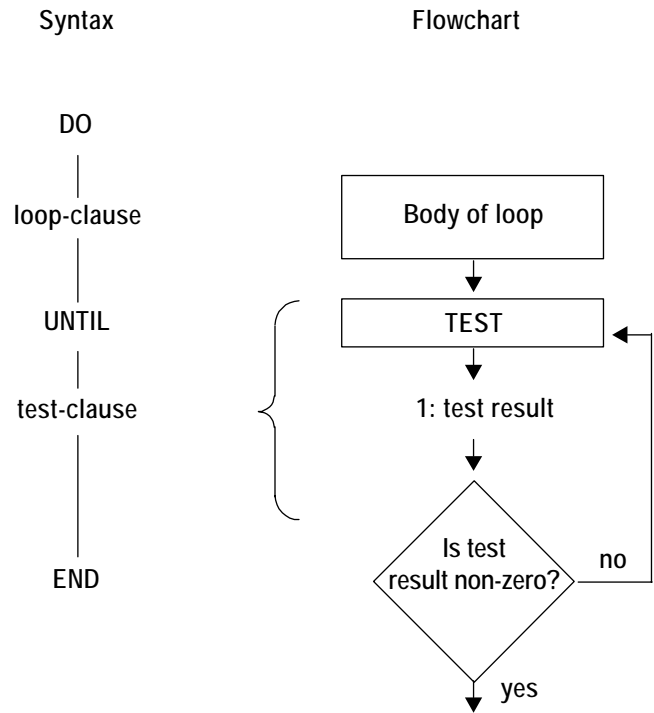

DO ... UNTIL ... END Structure

DO starts execution of the loop-clause. UNTIL marks the end of the loop-clause. The test-clause leaves a test result on the stack. END removes the test result from the stack. If its value is zero, the loop-clause is executed again — otherwise, execution resumes following END. If the argument of END is an algebraic or a name, it's automatically evaluated to a number.

To enter DO ... UNTIL ... END in a program:

■ Press PRG DO.

Example: The following program calculates $n + 2n + 3n + \dots$ for a value of n . The program stops when the sum exceeds 1000, and returns the sum and the coefficient of n .

| Program: | Comments: |
|------------------|--|
| ⌘ | |
| DUP 1 → n s c | Duplicates n , stores the value into n and s , and initializes c to 1. |

| Program: | Comments: |
|---|---|
| <pre> ⌘ DO 'c' INCR n * 's' STO+ UNTIL s 1000 > END s c ⌘ </pre> | <p>Starts the defining procedure. Starts the loop-clause. Increments the counter by 1. (See Using Loop Counters.) Calculates $c \times n$ and adds the product to s. Starts the test-clause. Repeats loop until $s > 1000$. Ends the test-clause. Puts s and c on the stack. Ends the defining procedure.</p> |
| ⌘ | |

The WHILE ... REPEAT ... END Structure

The syntax for this structure is

```
⌘ ... WHILE test-clause REPEAT loop-clause END ... ⌘
```

WHILE ... REPEAT ... END repeatedly evaluates *test-clause* and executes the *loop-clause* sequence if the test is true. Because the test-clause is executed *before* the loop-clause, the loop-clause is not executed if the test is initially false.

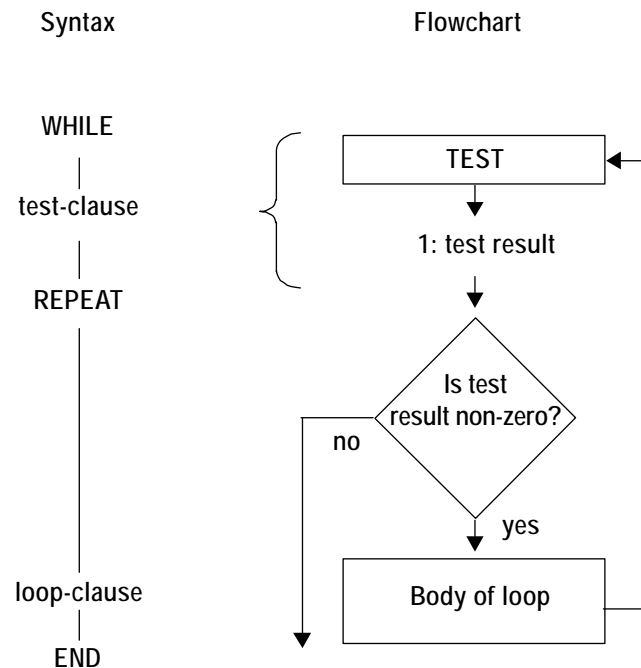

WHILE ... REPEAT ... END Structure

WHILE starts execution of the test-clause, which returns a test result to the stack. REPEAT takes the value from the stack. If the value is nonzero, execution continues with the loop-clause—otherwise, execution resumes following END. If the argument of REPEAT is an algebraic or a name, it's automatically evaluated to a number.

Using Summations Instead of Loops

For certain calculations that involve summations, you can use the Σ function instead of loops. You can use Σ with stack syntax or with algebraic syntax. Σ automatically repeats the addition for the specified range of the index variable — without using a loop structure.

Example: The following programs take an integer upper limit n from the stack, then find the summation. One program uses a FOR ... NEXT loop — the other uses Σ .

$$\sum_{j=1}^n j^2$$

| Program: | Comments: |
|--------------------------------------|--|
| ⌘ | |
| <pre>0 1 ROT FOR j j SQ + NEXT</pre> | Initializes the summation and puts the limits in place. Loops through the calculation. |
| ⌘ | |

| Program: | Comments: |
|-------------------------------|---|
| ⌘ | |
| <pre>→ n 'Σ(j=1,n,j^2)'</pre> | Uses Σ to calculate the summation. |
| ⌘ | |

Example: The following program uses Σ LIST to calculate the summation of all elements of a vector or matrix. The program takes from the stack an array or a name that evaluates to an array, and returns the summation.

| Program: | Comments: |
|--|---|
| ⌘ | |
| <pre>OBJ→ 1 + TLIST →LIST ΣLIST</pre> | <p>Finds the dimensions of the array and leaves it in a list on level 1.</p> <p>Adds 1 to the list. (If the array is a vector, the list on level 1 has only one element. TLIST will error if the list has fewer than two elements.)</p> <p>Multiplies all of the list elements together.</p> <p>Converts the array elements into a list, and sums them.</p> |
| ⌘ | |

Using Flags



You can use flags to control calculator behavior and program execution. You can think of a flag as a switch that is either on (*set*) or off (*clear*). You can test a flag's state within a conditional or loop structure to make a

decision. Because certain flags have unique meanings for the calculator, flag tests expand a program's decision-making capabilities beyond that available with comparison and logical functions.

Types of Flags

The hp49g+/hp48gII has two types of flags:

- **System flags.** Flags -1 through -128. These flags have predefined meanings for the calculator.
- **User flags.** Flags 1 through 128. User flags are, for the most part, not used by any built-in operations. What they mean depends entirely on how the *program* uses them.

Appendix C lists the 128 system flags and their definitions. For example, system flag -40 controls the clock display - when this flag is clear (the default state), the clock is not displayed - when this flag is set, the clock is displayed. (When you press  in the   menu, you are setting or clearing flag -40.)

Note that for the hp49g+/hp48gII, there are no display annunciators to indicate that user flags 1 through 5 are set, like the hp48S-series and hp48G-series calculators.









Setting, Clearing, and Testing Flags

Flag commands take a flag number from the stack – an integer 1 through 128 (for user flags) or -1 through -128 (for system flags).

To set, clear, or test a flag:

1. Enter the flag number (positive or negative).
2. Execute the flag command – see the table below.

Flag Commands

| Key | Programmable Command | Description |
|---|----------------------|---|
|  PRG  (NXT) (NXT) : | | |
|  | SF | Sets the flag. |
|  | CF | Clears the flag. |
|  | FS? | Returns 1. (true) if the flag is set, or 0. (false) if the flag is clear. |
|  | FC? | Returns 1. (true) if the flag is clear, or 0. (false) if the flag is set. |
|  | FS?C | Tests the flag (returns true if the flag is set), then clears the flag. |
|  | FC?C | Tests the flag (returns true if the flag is clear), then clears the flag. |

Example: System Flag. The following program sets an alarm for June 6, 2007 at 5:05 PM. It first tests the status of system flag -42 (Data Format flag) in a conditional structure and then supplies the alarm date in the current date format, based on the test result.

Example:

| Program: | Comments: |
|---|--|
| ⌘ | |
| <pre>IF -42 FC? THEN 6.152007 ELSE 15.062007 END 17.05 "TEST COMPLETE" 3 →LIST STOALARM</pre> | <p>Tests the status of flag -42, the Date Format flag.</p> <p>If flag -42 is clear, supplies the date in <i>month/day/year</i> format.</p> <p>If flag -42 is set, supplies the date in <i>day.month.year</i> format.</p> <p>Ends the conditional.</p> <p>Sets the alarm: 17.05 is the alarm time and "TEST COMPLETE" is the alarm message.</p> |
| ⌘ | |

Example: User Flag. The following program returns either the fractional or integer part of the number in level 1, depending on the state of user flag 10.

| Program: | Comments: |
|--|---|
| ⌘ | |
| <pre>IF 10 FS? THEN IP ELSE FP END</pre> | <p>Starts the conditional.</p> <p>Tests the status of user flag 10.</p> <p>If flag 10 is set, returns the integer part.</p> <p>If flag 10 is clear, returns the fractional part.</p> <p>Ends the conditional.</p> |
| ⌘ | |

To use this program, you enter a number, either set flag 10 (to get the integer part) or clear flag 10 (to get the fractional part), then run the program.

Recalling and Storing the Flag States

If you have a program that changes the state of a flag during execution, you may want it to save and restore original flag states.

The RCLF (recall flags) and STOF (store flags) commands let you recall and store the states of the hp49g+/hp48gII flags. For these commands, a 64-bit binary integer represents the states of 64 flags — each 0 bit corresponds to a flag that's clear, each 1 bit corresponds to a flag that's set. The rightmost (least significant) bit corresponds to system flag -1 or user flag 1 for the lower groups and system flag -65 or user flag 65 for the upper groups.

To recall the current flag states:

■ Execute RCLF ( PRG    ).

RCLF returns a list containing four 64-bit binary integers representing the current states of the lower and upper groups of system and user flags:

{ #*n*_{system-lower} #*n*_{user-lower} #*n*_{system-upper} #*n*_{user-upper} }

To change the current flag states:

1. Enter the flag-state argument- see below
2. Execute STOF (PRG).

STOF sets the current states of flags based on the flag-state argument:

- #n_s Changes the states of only the system flags.
- { #n_{s-lower} #n_{u-lower} #n_{s-upper} #n_{u-upper} } Changes the states of the system and user flags.

Example: The program *PRESERVE* on page 2-6 uses RCLF and STOF.

Using Subroutines

Because a program is itself an object, it can be used in another program as a subroutine. When program *B* is used by program *A*, program *A* calls program *B*, and program *B* is a *subroutine* in program *A*.

Example: The program *TORSA* calculates the surface area of a torus of inner radius *a* and outer radius *b*. *TORSA* is used as a subroutine in a second program *TORSV*, which calculates the volume of a torus.

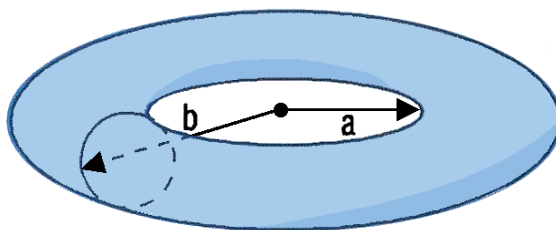

The surface area and volume are calculated by

$$A = \pi^2(b^2 - a^2) \quad V = \frac{1}{4}\pi^2(b^2 - a^2)(b - a)$$

(The quantity $\pi^2(b^2 - a^2)$ in the second equation is the surface area of a torus calculated by *TORSA*.)

Here are the stack diagram and program listing for *TORSA*.

| | | | |
|----------------|----------------|---|---------------------|
| Level 2 | Level 1 | → | Level 1 |
| <i>a</i> | <i>b</i> | → | <i>surface area</i> |

| Program: | Comments: |
|---|---|
| ⌘ | |
| <pre> → a b 'π^2*(b^2-a^2)' →NUM </pre> | Creates local variables a and b. Calculates the surface area. Converts algebraic to a number. |
| ⌘ | |
| TORSA | Puts the program on the stack. Stores the program in <i>TORSA</i> . |

Here is a stack diagram and program listing for *TORSV*.

| | | | |
|-----------------|-----------------|---|----------------------|
| Level 2 | Level 1 | → | Level 1 |
| <i>a</i> | <i>b</i> | → | <i>volume</i> |

| Program: | Comments: |
|--|--|
| ⌘ | |
| <pre> → a b ⌘ a b TORSV b a - * 4 / ⌘ </pre> | <p>Creates local variables <i>a</i> and <i>b</i>. Starts a program as the defining procedure. Puts the numbers stored in <i>a</i> and <i>b</i> on the stack, then calls <i>TORSV</i> with those arguments. Completes the volume calculation using the surface area. Ends the defining procedure.</p> |
| ⌘ | |
| <pre> [ENTER] [] TORSV [STO] </pre> | <p>Puts the program on the stack. Stores the program in <i>TORSV</i>.</p> |

Now use *TORSV* to calculate the volume of a torus of inner radius $a = 6$ and outer radius $b = 8$.

6 [ENTER] 8 [VAR] [TORSV]

```

1: 138.174461616
V2 V1 TST TORSVTORSVSPHLV

```

Single-Stepping through a Program

It's easier to understand how a program works if you execute it step by step, observing the effect of each step. Doing this can help you debug your own programs or understand programs written by others.

To single-step from the start of a program:

- Put the program or program name in level 1 (or the command line).
- Press [←] PRG [NXT] [NXT] [STOP] [STOP] to start and immediately suspend execution. **HLT** appears in the status area.
- Take any action:
 - To see the next program step displayed in the status area and then executed, press [STEP].
 - To display but not execute the next one or two program steps, press [STEP].
 - To continue with normal execution, press [←] CONT .
 - To abandon further execution, press [STOP].
- Repeat the previous step as desired.

To turn off the HALT annunciator at any time:

- Press [←] PRG [NXT] [NXT] [STOP] [STOP].

Example: Execute program *TORSV* step by step. Use $a = 6$ and $b = 8$.

Select the VAR menu and enter the data. Enter the program name and start the debugging. HLT indicates program execution is suspended.

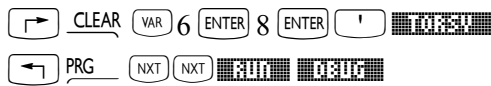

Display and execute the first program step. Notice that it takes the two arguments from the stack and stored them in local variables a and b .

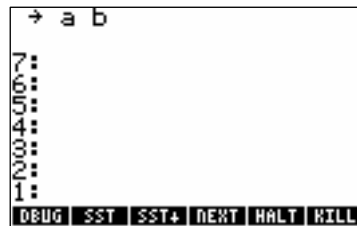

Continue single-stepping until the status area shows the current directory. Watch the stack and status area as you single-step through the program.



To single-step from the middle of a program:

1. Insert a HALT command in the program where you want to begin single-stepping.
2. Execute the program normally. The program stops when the HALT command is executed, and the HLT annunciator appears.
3. Take any action:
 - To see the next program step displayed in the status area and then executed, press .
 - To display but not execute the next one or two program steps, press .
 - To continue with normal execution, press .
 - To abandon further execution, press .
4. Repeat the previous step as desired.

When you want the program to run normally again, remove the HALT command from the program.

To single-step when the next step is a subroutine:

- To execute the subroutine in one step, press .
- To execute the subroutine step-by-step, press .

executes the next step in a program — if the next step is a subroutine, executes the subroutine in one step. works just like — except if the next program step is a subroutine, it single-steps to the first step in the subroutine.

Example: In the previous example, you used to execute subroutine *TORSA* in one step. Now execute program *TORSV* step by step to calculate the volume of a torus of radii $a = 10$ and $b = 12$. when you reach subroutine *TORSA*, execute it step by step.

Select the VAR menu and enter the data. Enter the program name and start the debugging. Execute the first four steps of the program, then check the next step.

[CLEAR] [VAR] 10 [ENTER] 12 ['] [TEST]

[←] [PRG] [NXT] [NXT] [TEST] [TEST]

[TEST] (4 times)

[TEST]



The next step is *TORSa*. Single-step into *TORSa*, then check that you're at the first step of *TORSa*.

[TEST] [TEST]



Press [←] [CONT] [←] [CONT] to complete subroutine and program execution. The following table summarizes the operations for single-stepping through a program.

Single-Step Operations

| Key | Programmable Command | Description |
|--------------------------------|----------------------|---|
| [←] [PRG] [NXT] [NXT] [TEST] : | | |
| [DEBUG] | | Starts program execution, then suspends it as if HALT were the first program command. Takes as its argument the program or program name in level 1. |
| [SST] | | Executes the next object or command in the suspended program. |
| [SST+] | | Same as [SST], except if the next program step is a subroutine, single-steps to the first step in that subroutine. |
| [NEXT] | | Displays the next one or two objects, but does not execute them. The display persists until the next keystroke. |
| [HALT] | HALT | Suspends program execution at the location of the HALT command in the program. |
| [KILL] | KILL | Cancels all suspended programs and turns off the HALT annunciator. |
| [←] [CONT] | CONT | Resumes execution of a halted program. |

Trapping Errors

If you attempt an invalid operation from the keyboard, the operation is not executed and an error message appears. For example, if you execute `+` with a vector and a real number on the stack, the hp49g+/hp48gII returns the message `Error: Bad Argument Type` and returns the arguments to the stack (if Last Arguments is enabled).

In a program, the same thing happens, but program execution is also aborted. If you anticipate error conditions, your program can process them without interrupting execution.

For simple programs, you can run the program again if it stops with an error. For other programs, you can design them to *trap* errors and continue executing. You can also create user-defined errors to trap certain conditions in programs. The error trapping commands are located in the PRG ERROR menu.

Causing and Analyzing Errors

Many conditions are automatically recognized by the hp49g+/hp48gII as error conditions— and they're automatically treated as errors in programs.

You can also define conditions that cause errors. You can cause a *user-defined error* (with a user-defined error message) — or you can cause a built-in error. Normally, you'll include a conditional or loop structure with a test for the error condition — and if it occurs, you'll cause the user-defined or built-in error to occur.

To cause a user-defined error to occur in a program:

1. Enter a string (with `" "` delimiters) containing the desired error message.
2. Enter the DOERR command (PRG ERROR menu).

To artificially cause a built-in error to occur in a program:

1. Enter the error number (as a binary integer or real number) for the error.
2. Enter the DOERR command (PRG ERROR menu).

If DOERR is trapped in an IFERR structure (described in the next topic), execution continues. If it's not trapped, execution is abandoned at the DOERR command and the error message appears.

To analyze an error in a program:

- To get the error number for the last error, execute ERRN (PRG ERROR menu).
- To get the error message for the last error, execute ERRM (PRG ERROR menu).
- To clear the last-error information, execute ERR0 (PRG ERROR menu).

The error number for a user-defined error is `#70000h`. See the list of built-in error numbers in appendix A, “Error and Status Messages”.

Example: The following program aborts execution if the list in level 1 contains three objects.

```
◀
  OBJ→
  IF 3 ==
  THEN "3 OBJECTS IN LIST" DOERR
  END
  ✖
```

The following table summarizes error trapping commands.

Error Trapping Commands

| Key | Programmable Command | Description |
|-----|----------------------|--|
| | | |
| | DOERR | Causes an error. For a string in level 1, causes a user-defined error: the calculator behaves just as if an ordinary error has occurred. For a binary integer or real number in level 1, causes the corresponding built-in error. If the error isn't trapped in an IFERR structure, DOERR displays the message and abandons program execution. (For 0 in level 1, abandons execution without updating the error number or message — like $\overline{\text{CANCEL}}$.) |
| | ERNN | Returns the error number, as a binary integer, of the most recent error. Returns #0 if the error number was cleared by ERR0. |
| | ERRM | Returns the error message (a string) for the most recent error. Returns an empty string if the error number was cleared by ERR0. |
| | ERR0 | Clears the last error number and message. |

Making an Error Trap

You can construct an error trap with one of the following conditional structures:

- IFERR ... THEN ... END.
- IFERR ... THEN ... ELSE ... END.

The IFERR ... THEN ... END Structure

The syntax for this structure is

```
⌘ ... IFERR trap-clause THEN error-clause END ... ⌘
```

The commands in the error-clause are executed only if an error is generated during execution of the trap-clause. If an error occurs in the trap-clause, the error is ignored, the remainder of the trap-clause is skipped, and program execution jumps to the error-clause. If *no* errors occur in the trap-clause, the error-clause is skipped and execution resumes after the END command.

To enter IFERR ... THEN ... END in a program:

- Press .

Example: The following program takes any number of vectors or arrays from the stack and adds them to the statistics matrix. However, the program stops with an error if a vector or array with a different number of columns is encountered. In addition, if only vectors or arrays with the same number of columns are on the stack, the program stops with an error after the last vector or array has been removed from the stack.

```
⌘ WHILE DUP TYPE 3 == REPEAT Σ+ END ⌘
```

In the following revised version, the program simply attempts to add the level 1 object to the statistics matrix until an error occurs. Then, it ends by displaying the message `DONE`.

| Program: | Comments: |
|--|---|
| ⌘ | |
| <pre> IFERR WHILE 1 REPEAT Σ+ END THEN "DONE" 1 DISP 1 FREEZE END </pre> | <p>Starts the trap-clause. The WHILE structure repeats indefinitely, adding the vectors and arrays to the statistics matrix until an error occurs.</p> <p>Starts the error clause. If an error occurs in the WHILE structure, displays the message DONE in the status area.</p> |
| ⌘ | Ends the error structure. |

The IFERR ... THEN ... ELSE ... END Structure

The syntax for this structure is

```

⌘ ... IFERR trap-clause
  THEN error-clause ELSE normal-clause END ... ⌘

```

The commands in the error-clause are executed only if an error is generated during execution of the trap-clause. If an error occurs in the trap-clause, the error is ignored, the remainder of the trap-clause is skipped, and program execution jumps to the error-clause. If no errors occur in the trap-clause, execution jumps to the normal-clause at the completion of the trap-clause.

To enter IFERR ... THEN ... ELSE ... END in a program:



■ Press PRG NXT IFERR

Example: The following program prompts for two numbers, then adds them. If only one number is supplied, the program displays an error message and prompts again.











| Program: | Comments: |
|--|---|
| ⌘ | |
| <pre> DO "KEY IN a AND b" " INPUT OBJ+ UNTIL IFERR + THEN ERRM 5 DISP 2 WAIT 0 ELSE 1 END END </pre> | <p>Begins the main loop. Prompts for two numbers.</p> <p>Starts the loop test clause. The error trap contains only the + command. If an error occurs, recalls and displays the Too Few Arguments message for 2 seconds, then puts 0 (false) on the stack for the main loop. If no error occurs, puts 1(true) on the stack for the main loop.</p> <p>Ends the error trap.</p> <p>Ends the main loop. If the error trap left 0 (false) on the stack, the main loop repeats — otherwise, the program ends.</p> |
| ⌘ | |

Input

A program can stop for user input, then resume execution, or can use choose boxes or input forms (dialog boxes) for input. You can use several commands to get input:

- PROMPT ( CONT to resume).
- DISP FREEZE HALT ( CONT to resume).
- INPUT ( to resume).
- INFORM
- CHOOSE

Data Input Commands

| Key | Command | Description |
|---|---------|---|
|  PRG   : | | |
|  | INFORM | Creates a user-defined input form. |
|  | NOVAL | Place holder for the INFORM command. Returned when a value is not present in an input form field. |
|  | CHOOSE | Creates a user-defined choose box. |
|  | KEY | Returns a test result to level 1 and, if a key is pressed, the location of that key (level 2). |
|  | WAIT | Suspends program execution for a specified duration (in seconds, level 1). |
|  | INPUT | Suspends program execution for data input. |
|  | PROMPT | Halts program execution for data input. |

Using PROMPT ... CONT for Input

PROMPT uses the status area for prompting, and allows the user to use normal keyboard operations during input.

To enter PROMPT in a program:

1. Enter a string (with " " delimiters) to be displayed as a prompt in the status area.
2. Enter the PROMPT command (PRG IN menu).

※ ... "prompt-string" PROMPT ... ※

PROMPT takes a string argument from level 1, displays the string (without the " " delimiters) in the status area, and halts program execution. Calculator control is returned to the keyboard.

When execution resumes, the input is left on the stack as entered.

To respond to PROMPT while running a program:

1. Enter your input — you can use keyboard operations to calculate the input.
2. Press  CONT .

The message remains until you press  or  or until you update the status area.

Example: If you execute this program segment

```
« "ABC?" PROMPT »
```

the display looks like this:



Example: The following program, *TPROMPT*, prompts you for the dimensions of a torus, then calls program *TORSA* (from page 1-28) to calculate its surface area. You don't have to enter data on the stack prior to program execution.

| Program: | Comments: |
|---|--|
| « | |
| "ENTER a, b IN ORDER:" | Puts the prompting string on the stack. |
| PROMPT | Displays the string in the status area, halts program execution, and returns calculator control to the keyboard. |
| TORSA | Executes <i>TORSA</i> using the just-entered stack arguments. |
| » | |
| <input type="button" value="ENTER"/> <input type="button" value="'"/> TPROMPT <input type="button" value="STO▶"/> | Stores the program in <i>TPROMPT</i> . |

Execute *TPROMPT* to calculate the volume of a torus with inner radius a =8 and outer radius b =10. Execute *TPROMPT*. The program prompts you for data.

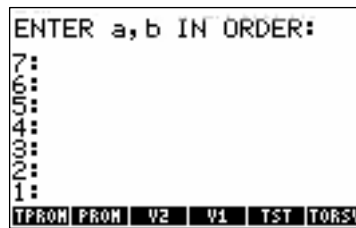

Enter the inner and outer radii. After you press , the prompt message is cleared from the status area.

8 10

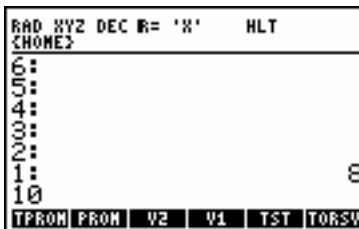

Continue the program.

CONT

```
1: 355.305758439
TPROM PROM V2 V1 TST TORSW
```

Note that when program execution is suspended by PROMPT, you can execute calculator operations just as you did before you started the program. If the outer radius *b* of the torus in the previous example is measured as 0.83 feet, you can convert that value to inches *while the program is suspended for data input* by pressing .83 12 , then CONT .

Using DISP FREEZE HALT ... CONT for Input

DISP FREEZE HALT lets you control the entire display during input, and allows the user to use normal keyboard operations during input.

To enter DISP FREEZE HALT in a program:

1. Enter a string or other object to be displayed as a prompt.
2. Enter a number specifying the line to display it on.
3. Enter the DISP command (PRG OUT menu).
4. Enter a number specifying the areas of the display to “freeze.”
5. Enter the FREEZE command (PRG OUT menu).
6. Enter the HALT command (PRG OUT menu).

```
※ ... prompt-object display-line DISP
freeze-area FREEZE HALT ... ※
```

DISP displays an object in a specified line of the display. DISP takes two arguments from the stack: an object from level 2, and a display-line number 1 through 7 from level 1. If the object is a string, it's displayed without the " " delimiters. The display created by DISP persists only as long as the program continues execution — if the program ends or is suspended by HALT, the calculator returns to the normal stack environment and updates the display. However, you can use FREEZE to retain the prompt display.

FREEZE “freezes” display areas so they aren't updated until a *key press*. Argument *n* in level 1 is the sum of the codes for the areas to be frozen: 1 for the status area, 2 for the stack/command line area, 4 for the menu area.

HALT suspends program execution at the location of the HALT command and turns on the HALT annunciator. Calculator control is returned to the keyboard for normal operations.

When execution resumes, the input remains on the stack as entered.

To respond to HALT while running a program:

1. Enter your input — you can use keyboard operations to calculate the input.
2. Press CONT .

Example: If you execute this program segment

```
※ "ABC<math>\leftarrow</math> DEF<math>\leftarrow</math> GHI" CLLCD 3 DISP 2 FREEZE HALT ※
```

The display looks like this:

```

RAD XYZ DEC R= 'X' HLT
{HOME}
ABC
DEF
GHI
DEBUG SST SST+ NEXT HALT KILL

```

(The \leftarrow in the previous program is the calculator's representation for the newline character after you enter a program on the stack.)

Using INPUT ... ENTER for Input

INPUT lets you use the stack area for prompting, lets you supply default input, and prevents the user from using normal stack operations or altering data on the stack.

To enter INPUT in a program:

1. Enter a string (with "" delimiters) to be displayed as a prompt at the top of the stack area.
2. Enter a string or list (with delimiters) that specifies the command-line content and behavior — see below.
3. Enter the INPUT command (PRG IN menu).
4. Enter OBJ→ (PRG TYPE menu) or other command that processes the input as a string object.

⌘ ... "prompt-string" "command-line" INPUT OBJ→ ... ⌘

or

⌘ ... "prompt-string" {command-line} INPUT OBJ→ ... ⌘

INPUT, in its simplest form, takes two strings as arguments — see the list of additional options following. INPUT blanks the stack area, displays the contents of the level-2 string at the top of the stack area, and displays the contents of the level-1 string in the command line. It then activates Program-entry mode, puts the insert cursor after the string in the command line, and suspends execution.

When execution resumes, the input is returned to level 1 as a string object, called the *result string*.

To respond to INPUT while running a program:

1. Enter your input. (You can't execute commands — they're simply echoed in the command line.)
2. Optional: To clear the command line and start over, press CANCEL .
3. Press .

If you execute this program segment

⌘ "Variable name?" ":VAR:" INPUT ⌘

the display looks like this:



The following program, *VSPH*, calculates the volume of a sphere. *VSPH* prompts for the radius of the sphere, then cubes it and multiplies by $\frac{4}{3} \pi$. *VSPH* executes INPUT to prompt for the radius. INPUT sets Program-entry mode when program execution pauses for data entry.

| Program: | Comments: |
|--|--|
| ⌘ | |
| "Key in radius" | Specifies the prompt string. |
| "" INPUT OBJ→ 3 ^ 4 * 3 / π * →NUM | Specifies the command-line string. In this case, the command line will be empty. Displays the prompt, puts the cursor at the start of the command line, and suspends the program for data input (the radius of the sphere). Converts the result string into its component object- a real number. Cubes the radius. Completes the calculation. |
| ⌘ | |
| ENTER ' VSPH STO▶ | Stores the program in VSPH. |

Example:

Execute VSPH to calculate the volume of a sphere of radius 2.5.



Key in the radius and continue program execution.

2.5 ENTER

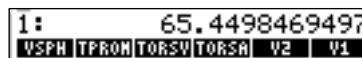

To include INPUT options:

- Use a list (with { } delimiters) as the command-line argument for INPUT. The list can contain one more of the following:
 - Command-line string (with "" delimiters).
 - Cursor position as a real number or as a list containing two real numbers.
 - Operating options ALG, ⌘, or V.

In its general form, the level 1 argument for INPUT is a list that specifies the content and interpretation of the command line. The list can contain one or more of the following parameters in any order:

{ "command-line" cursor-position operating-options }

| | |
|-------------------|--|
| "Command-line" | Specifies the content of the command line when the program pauses. Embedded newline characters produce multiple lines in the display. (If not included, the command line is blank.) |
| Cursor-position | <p>Specifies the position of the cursor in the command line and its type. (If not included, an insert cursor is at the end of the command line.)</p> <ul style="list-style-type: none"> ■ A real number n specifies the nth character in the first row (line) of the command line. Zero specifies the end of the command-line string. A positive number specifies the <i>insert</i> cursor — a negative number specifies the <i>replace</i> cursor. ■ A list { row character } specifies the row and character position. Row 1 is the first row (line) of the command line. Characters count from the left end of each row — character 0 specifies the end of the row. A positive row number specifies the <i>insert</i> cursor — a negative row number specifies the <i>replace</i> cursor. |
| operating-options | <p>Specify the input setup and processing using zero or more of these unquoted names:</p> <ul style="list-style-type: none"> ■ <code>ALG</code> activates Algebraic/Program-entry mode (for algebraic syntax). (If not included, Program-entry mode is active.) ■ <code>⊗</code> (ALPHA <code>⏪</code> A) specifies alpha lock. (If not included, alpha is inactive.) ■ <code>⋄</code> verifies whether the result string (without the " " delimiters) is a valid object or sequence of objects. If the result string isn't valid, INPUT displays the <code>Invalid Syntax</code> message and prompts again for data. (if not included, syntax isn't checked.) |

To design the command-line string for INPUT:

- For simple input, use a string that produces a valid object:
 - Use an empty string
 - Use a # label # tag.
 - Use a @ text @ comment.
- For special input, use a string that produces a recognizable pattern.

After the user enters input in the command line and presses `ENTER` to resume execution, the contents of the command line are returned to level 1 as the result string. The result string normally contains the original command-line string, too. If you design the command-line string carefully, you can ease the process of extracting the input data.

To process the result string from INPUT:

- For simple input, use `OBJ→` to convert the string into its corresponding objects.
- For sensitive input, use the `⋄` option for INPUT to check for valid objects, then use `OBJ→` to convert the string into those objects.
- For special input, process the input as a string object, possibly extracting data as substrings.









Example: The program *VSPH* on page 1-39 uses an empty command-line string.

Example: The program *SSEC* on page 1-42 uses a command-line string whose characters form a pattern. The program extracts substrings from the result string.

Example: The command-line string "@UPPER LIMITE" displays @UPPER LIMITE ◀ in the command line. If you press 200  the return string is "@UPPER LIMITE200". When OBJ→ extracts the text from the string, it strips away the @ characters and the enclosed characters, and it returns the number 200. (See "Creating Programs on a computer" on page 1-7 for more information about @ comments.)

Example: The following program, TINPUT, executes INPUT to prompt for the inner and outer radii of a torus, then calls TORSAL (page 1-28) to calculate its surface area. TINPUT prompts for a and b in a two-row command line. The level 1 argument for INPUT is a list that contains:

- The command-line string, which forms the tags and delimiters for two tagged objects.
- An embedded list specifying the initial cursor position.
- The V parameter to check for invalid syntax in the result string.

| Program: | Comments: |
|--|---|
| ⌘ | |
| "Key in a, b" | The level 2 string, displayed at the top of the stack area. |
| { "a: ◀ b: " { 1 0 } V } | The level 1 list contains a string, a list, and the verify option. (To key in the string, press  _ "  :: _ a    :: _ b. After you press  to put the finished program on the stack, the string is shown on one line, with ◀ indicating the newline character.) The embedded list puts the insert cursor at the end of row 1. |
| INPUT | Displays the stack and command-line strings, positions the cursor, sets Program-entry mode, and suspends execution for input. |
| OBJ→ | Converts the string into its component objects — two tagged objects. |
| TORSAL | Calls TORSAL to calculate the surface area. |
| ⌘ | |
|  ' TINPUT  | Stores the program in TINPUT. |

Execute TINPUT to calculate the surface area of a torus of inner radius $a = 10$ and outer radius $b = 20$.

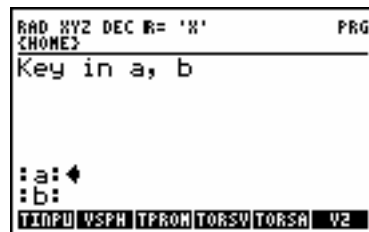

Key in the value for a, press  to move the cursor to the next prompt, then key in the value for b.

To set up an input form:

1. Enter a title string for the input for the input form (use `→` `"`).
2. Enter a list of field specifications.
3. Enter a list of format options.
4. Enter a list of reset values (values that appear when RESET is pressed).
5. Enter a list of default values.
6. Execute the INFORM command.

Example: Enter a title "FIRST ONE" `ENTER`.

Specify a field `< "Name:" >` `ENTER`.

Enter format options (one column, tabs stop width five) `< 1 5 >` `ENTER`.

Enter reset value for the field `< "THERESA" >` `ENTER`.

Enter default value for the field `< "WENDY" >` `ENTER`.

Execute INFORM (`←` `PRG` `NXT` `INFORM`).

The screen on the left appears. Press `NXT` `RESET` `OK` and the screen on the right appears.



You can specify a help message and the type of data that must be entered in field by entering field specifications as lists. For example, `<< "Name:" "Enter your name" 2 >>` defines the Name field, displays Enter your name across the bottom of the input form, and accepts only object type 2 (strings) as input.

To set up a choose box:

1. Enter a title string for the choose box.
2. Enter a list of items. If this is a list of two-element lists, the first element is displayed in the choose box, and the *second* element is returned to level 2 when OK is pressed.
3. Enter a position number for the default highlighted item. (0 makes a view-only choose box.)
4. Execute the CHOOSE command.

Example: Enter a title "FIRST ONE" `ENTER`.

Enter a list of items `< ONE TWO THREE >` `ENTER`.

Enter a position number for default highlighted value 3 `ENTER`.

Execute CHOOSE (`←` `PRG` `NXT` `CHOOSE`).

Example: The following choose box appears:



Example: The following program uses input forms, choose boxes, and message boxes to create a simple phone list database.

| Program: | Comments: |
|--|---|
| « | |
| 'NAMES' VTYPE IF -1 == THEN() 'NAMES' STO END | Checks if the name list (NAMES) exists, if not, creates an empty one. |
| WHILE "PHONELIST OPTIONS:" { { "ADD A NAME" 1} { "VIEW A NUMBER" 2 } } 1 CHOOSE | While cancel is not pressed, creates a choose box that lists the database options. When OK is pressed, the second item in the list pair is returned to the stack. |
| REPEAT → c « | Stores the returned value in c. |
| CASE c 1 == THEN WHILE | Case 1 (ADD name), while cancel is not pressed, do the following: |
| "ADD A NAME" { { "NAME:" "ENTER NAME" 2 } { "PHONE:" "ENTER A PHONE NUMBER" 2 } } { } { } { } INFORM REPEAT | Creates an input form that gets the name and phone number. The two fields accept only strings (object type 2). |
| DUP IF(NOVAL) HEAD POS THEN DROP "Complete both fields before pressing OK" MSGBOX | Checks if either field in the new entry is blank. If either one is, displays a message. |
| ELSE 1 →LIST NAMES + SORT 'NAMES' STO END END END | If neither are, adds the list to NAMES, sorts it, and stores it back in NAMES. Ends the IF structure, the WHILE loop, and the CASE statement. |
| c 2 == | Case 2 (View a Number). |
| THEN IF () NAMES SAME THEN "YOU MUST ADD A NAME FIRST" MSGBOX | Checks if NAMES is an empty list. If it is, displays a message. |

| Program: | Comments: |
|--|---|
| <pre>ELSE WHILE "VIEW A NUMBER" NAMES 1 CHOOSE</pre> | If NAMES isn't empty, creates a choose box using NAMES as choice items. |
| <pre>REPEAT →STR MSGBOX END END END END * END *</pre> | <p>When OK is pressed, the second item in the NAMES list pairs (the phone number) is returned. Makes it a string and displays it.</p> <p>Ends the WHILE loop, the IF structure, and the CASE statement.</p> <p>Ends the CASE structure, marks the end of the local variable defining procedure, ends the WHILE loop, and marks the end the program.</p> |
| <pre>ENTER ' PHONES STOP</pre> | Stores the program in PHONES. |

You can delete names and numbers by editing the NAMES variable. To improve upon this program, create a delete name routine.

Beeping to Get Attention

To enter BEEP in a program:

1. Enter a number that specifies the tone frequency in hertz.
2. Enter a number that specifies the tone duration in seconds.
3. Enter the BEEP command (← PRG [BEEP] NXT menu).

⌘ ... *frequency duration* BEEP ... ⌘

BEEP takes two arguments from the stack: the tone frequency from level 2 and the tone duration from level 1.

Example: The following edited version of *TPROMPT* sounds a 440-hertz, one-half-second tone at the prompt for data input.

| Program: | Comments: |
|---|--|
| ⌘ | |
| <pre>"ENTER a, b IN ORDER: " 440 .5 BEEP PROMPT TORSa</pre> | Sounds a tone just before the prompt for data input. |
| ⌘ | |

Stopping a Program for Keystroke Input

A program can stop for keystroke input — it can wait for the user to press a key. You can do this with the WAIT and KEY commands.

Using WAIT for Keystroke Input

The WAIT command normally suspends execution for a specified number of seconds. However, you can specify that it wait indefinitely until a key is pressed.

To enter WAIT in a program:



- To stop without changing the display, enter 0 and the WAIT command (PRG IN menu).
- To stop and display the current menu, enter -1 and the WAIT command (PRG IN menu).

WAIT takes the 0 or -1 from level 1, then suspends execution until a valid keystroke is executed.

For an argument of -1, WAIT displays the currently specified menu. This lets you build and display a menu of user choices while the program is paused. (A menu built with MENU or TMENU is not normally displayed until the program ends or is halted.)

When execution resumes, the three-digit key location number of the pressed key is left on the stack. This number indicates the row, column, and shift level of the key.

To respond to WAIT while running a program:



- Press any valid keystroke. (A prefix key such as  or  by itself is not a valid keystroke.)

Using KEY for Keystroke Input

You can use KEY inside an indefinite loop to “pause” execution until any key — or a certain key — is pressed.



To enter a KEY loop in a program:

1. Enter the loop structure.
2. In the test-clause sequence, enter the KEY command (PRG IN menu) plus any necessary test commands.
3. In the loop-clause, enter *no* commands to give the appearance of a “paused” condition.

KEY returns 0 to level 1 when the loop begins. It continues to return 0 until a key is pressed — then it returns 1 to level 1 and the two-digit row-column number of the pressed key to level 2. For example,  returns 105, and  returns 81.)

The test-clause should normally cause the loop to repeat until a key is pressed. If a key is pressed, you can use comparison tests to check the value of the key number. (See "Using Indefinite Loop Structures" on page 1-21 and "Using Comparison Functions" on page 1-11.)

To respond to a KEY loop while running a program:

- Press any key. (A prefix key such as  or  is a valid key.)

Example: The following program segment returns 1 to level 1 if  is pressed, or 0 to level 1 if any other key is pressed:

```
« ... DO UNTIL KEY END 95 SAME ... »
```

Output

You can determine how a program presents its output. You can make the output more recognizable using the techniques described in this section.

Data Output Commands

| Key | Command | Description |
|-----|---------|--|
| PRG | | |
| | PVIEW | Displays PICT starting at the given coordinates. |
| | TEXT | Displays the stack display. |
| | CLLCD | Blanks the stack display. |
| | DISP | Displays an object in the specified line. |
| | FREEZE | “Freezes” a specified area of the display until a key press. |
| | MSGBOX | Creates a user-defined message box. |
| | BEEP | Sounds a beep at a specified frequency (in hertz, level 2) and duration (in seconds, level 1). |
| — | — | — |

Labeling Output with Tags

To label a result with a tag:

1. Put the output object on the stack.
2. Enter a tag — a string, a quoted name, or a number.
3. Enter the →TAG command (PRG TYPE menu).

⌘ ... *object tag* →TAG ... ⌘

→TAG takes two arguments — an object and a tag — from the stack and return a tagged object.

Example: The following program *TTAG* is identical to *TINPUT*, except that it returns the result as `AREA` value.

| Program: | Comments: |
|--|--|
| ⌘ | |
| <pre>"Key in a, b" < "a:"←"b:" (1 0) V> INPUT OBJ→ TORSa "AREA" →TAG</pre> | Enters the tag (a string). Uses the program result and string to create the tagged object. |
| TTAG | Stores the program in <i>TTAG</i> . |

Execute *TTAG* to calculate the area of a torus of inner radius $a = 1.5$ and outer radius $b = 1.85$. The answer is returned as a tagged object.

1.5 1.85

1: AREA:11.5721111603
TTAG TINPUT USPHTPROMTORSUTORSA

Labeling and Displaying Output as Strings

To label and display a result as a string:

1. Put the output object on the stack.
2. Enter the \rightarrow STR command (PRG TYPE menu).
3. Enter a string to label the object (with " " delimiters).
4. Enter the SWAP + commands to swap and concatenate the strings.
5. Enter a number specifying the line to display the string on.
6. Enter the DISP command (PRG OUT menu).

⌘ ... object \rightarrow STR label SWAP + line DISP ... ⌘

DISP displays a string without its " " delimiters.

Example: The following program *TSTRING* is identical to *TINPUT*, except that it converts the program result to a string and appends a labeling string to it.

| Program: | Comments: |
|---|--|
| ⌘ | |
| <pre>"Key in a, b" < "a:←b:" (1 0) V) INPUT OBJ→ TORSA →STR "Area = " SWAP + CLLCD 1 DISP 3 FREEZE</pre> | <p>Converts the result to a string. Enters the labeling strings. Swaps and adds the two strings. Displays the resultant string, without its delimiters, in line 1 of the display.</p> |
| ⌘ | |
| | Stores the program in <i>TSTRING</i> . |

Execute *TSTRING* to calculate the area of the torus with $a = 1.5$ and $b = 1.85$. The labeled answer appears in the status area.

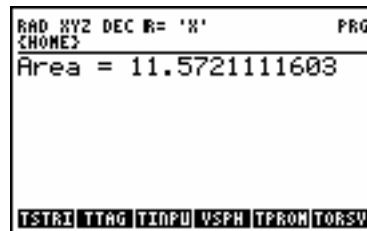

Pausing to Display Output

To pause to display a result:

1. Enter commands to set up the display.
2. Enter the number of seconds you want to pause.
3. Enter the WAIT command (PRG IN menu).

WAIT suspends execution for the number of seconds in level 1. You can use WAIT with DISP to display messages during program execution — for example, to display intermediate program results. (WAIT interprets arguments 0 and -1 differently — see "Using WAIT for Keystroke Input" on page 1-46.)

Using MSGBOX to Display Output

To set up a message box:



1. Enter a message string.
2. Execute the MSGBOX command.

Example: Enter the string "HELLO, WORLD" .

Execute MSGBOX ( PRG  .

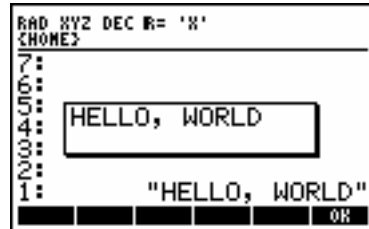
The following message appears:



You must acknowledge a message box by pressing  or .

Using Menus with Programs

You can use menus with programs for different purposes:

- **Menu-based input.** A program can set up a menu to get input during a halt in a program and then resume executing the same program.
- **Menu-based application.** A program can set up a menu and finish executing, leaving the menu to start executing other related programs.

To set up a built-in or library menu:

1. Enter the menu number.
2. Enter the MENU command (MODES MENU menu).

To set up a custom menu:

1. Enter a list (with $\{ \}$ delimiters) or the name of a list defining the menu actions. If a list of two element lists is given, the first element appears in the menu, but it is the *second* element that is returned to the stack when the menu key is pressed. This *second* element can itself be a list with up to 3 objects, one for the menu key, one for the left shift menu key and one for the right shift menu key.
2. Activate the menu:
 - To save the menu as the CST menu, enter the MENU command (MODES MENU menu).
 - To make the menu temporary, enter the TMENU command (MODES MENU menu).

The menu isn't displayed until program execution halts.

Menu numbers for built-in menus are listed in Appendix H. Library menus also have numbers — the library number serves as the menu number. So you can activate applications menus (such as the SOLVE and PLOT menus) and other menus (such as the VAR and CST menus) in programs. The menus behave just as they do during normal keyboard operations.

You create a custom menu to cause the behavior you need in your program — see the topics that follow. You can save the menu as the CST menu, so the user can get it again by pressing  CUSTOM. Or you can make it *temporary* — it remains active (even after execution stops), but only until a new menu is selected — and it doesn't affect the contents of variable *CST*.

To specify a particular *page* of a menu, enter the number as *m.pp*, where *m* is the menu number and *pp* is the page number (such as 94.02 for page 2 of the TIME menu). If page *pp* doesn't exist, page 1 is displayed (94 gives page 1 of the TIME menu).

Example: Enter `69 MENU` to get page 1 of the MODES MISC menu.
Enter `69.02 MENU` to get page 2 of the MODES MISC menu.

To restore the previous menu:

- Execute 0 MENU.

To recall the menu number for the current menu:

- Execute the RCLMENU command (MODES MENU menu).

Using Menus for Input

To display a menu for input in a program:

1. Set up the menu — see the previous section.
2. Enter a command sequence that halts execution (such as DISP, PROMPT, or HALT).

The program remains halted until it's resumed by a CONT command, such as by pressing `↵` `CONT`. If you create a custom menu for input, you can include a CONT command to automatically resume the program when you press the menu key.

Example: The following program activates page 1 of the MODES ANGL menu and prompts you to set the angle mode. After you press the menu key, you have to press `↵` `CONT` to resume execution.

```
◀ 65 MENU "Select Angle Mode" PROMPT *
```

Example: The *PIE* program on page 2-34 assigns the CONT command to one key in a temporary menu.

Example: The *MNX* program on page 2-17 sets up a temporary menu that includes a program containing CONT to resume execution automatically.

Using Menus to Run Programs

You can use a custom menu to run other programs. That menu can serve as the main interface for an application (a collection of programs).

To create a menu-based application:

1. Create a custom menu list for the application that specifies programs as menu objects.
2. Optional: Create a main program that sets up the application menu — either as the CST menu or as a temporary menu.

Example: The following program, *WGT*, calculates the mass of an object in either English or SI units given the weight. *WGT* displays a temporary custom menu, from which you run the appropriate program. Each program prompts you to enter the weight in the desired unit system, then calculates the mass. The menu remains active until you select a new menu, so you can do as many calculations as you want. Enter the following list and store it in LST:

```
{  
{ "ENGL" ◀ "ENTER Wt in POUNDS" PROMPT 32.2 / * }  
{ "SI" ◀ "ENTER Wt in NEWTONS" PROMPT 98.1 / * }  
}
```

`↵` LST `STO▶`

| Program: | Comments: |
|---------------|---|
| ※ LST TMENU ※ | Displays the custom menu stored in <i>LST</i> . |
| WGT | Stores the program in <i>WGT</i> . |

Use *WGT* to calculate the mass of an object of weight 12.5 N. The program sets up the menu, then completes execution.



Select the SI unit system, which starts the program in the menu list.

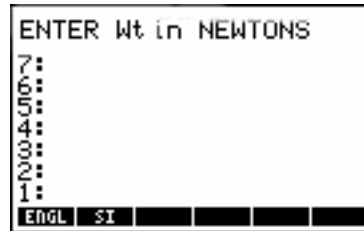

Key in the weight, then resume the program.

12.5

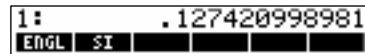

Example: The following program, *EIZ*, constructs a custom menu to emulate the HP Solve application for a capacitive electrical circuit. The program uses the equation $E = IZ$, where E is the voltage, I is the current, and Z is the impedance.

Because the voltage, current, and impedance are complex numbers, you can't use the HP Solve application to find solutions. The custom menu in *EIZ* assigns a *direct* solution to the left-shifted menu key for each variable, and assigns *store* and *recall* functions to the unshifted and right-shifted keys — the actions are analogous to the HP Solve application. The custom menu is automatically stored in *CST*, replacing the previous custom menu — you can press to restore the menu.

| Program: | Comments: |
|---|--|
| ※ | |
| DEG -15 SF -16 SF 2 FIX | Sets Degrees mode. Sets flags -15 and -16 to display complex numbers in polar form. Sets the display mode to 2 Fix. |
| { { "E" (« 'E' STO » « I Z ÷ DUP 'E' STO "E:" SWAP + CLLCD 1 DISP 3 FREEZE » « E ») } } | Starts the custom menu list. Builds menu key 1 for E. Unshifted action: stores the object in E . Left-shift action: calculates $I \times Z$, stores it in E , and displays it with a label. Right-shift action: recalls the object in E . |
| { "I" (« 'I' STO » « E Z / DUP 'I' STO "I:" SWAP + CLLCD 1 DISP 3 FREEZE » « I ») } } | Builds menu key 2. |

| Program: | Comments: |
|---|------------------------------------|
| ("Z"(* 'Z' STO* * E I / DUP 'Z' STO "Z:" SWAP + CLLCD 1 DISP 3 FREEZE * * Z *)) | Builds menu key 3. |
|) | Ends the list. |
| MENU | Displays the custom menu. |
| * | |
| ENTER ' EIZ STO▶ | Stores the program in <i>EIZ</i> . |

For a 10-volt power supply at phase angle 0°, you measure a current of 0.37-amp at phase angle 68°. Find the impedance of the circuit using *EIZ*.

→ CLEAR VAR

Key in the voltage value.

← () 10 ALPHA → 6 0

(10∠0°

Store the voltage value. Then key in and store the current value. Solve for the impedance.

← () .37 ALPHA → 6 68
←

DEG Rad DEC R= 'H'
CHOMEZ
Z: (27.03,∠-68.00)

Recall the current and double it. Then find the voltage.

→ 2 × ←

DEG Rad DEC R= 'H'
CHOMEZ
E: (20.00,∠-1.07E-10)

Press (←) (MODE) and (NXT) to restore Standard and Rectangular modes.

Turning Off the hp49g+/hp48gII from a Program

To turn off the calculator in a program:

- Execute the OFF command (PRG RUN menu).

The OFF command turns off the hp49g+/hp48gII. If a program executes OFF, the program resumes when the calculator is next turned on.

RPL Programming Examples

The programs in this chapter demonstrate basic programming concepts. These programs are intended to improve your programming skills, and to provide supplementary functions for your calculator.

At the end of each program, the program's *checksum* and size in bytes are listed to help make sure you typed the program in correctly. (The checksum is a binary integer that uniquely identifies the program based on its contents). To make sure you've keyed the program in correctly, store it in its name, put the name in level 1, then execute the BYTES command (◀ PRG ████ ████). This returns the program's checksum to level 2, and its size in bytes to level 1. (If you execute BYTES with the program *object* in level 1, you'll get a different byte count.)

The examples in this chapter assume the hp49g+/hp48gII is in its initial, default condition – they assume you haven't changed any of the hp49g+/hp48gII operating modes. (To reset the calculator to this condition, see “Memory Reset” in chapter 5 of the *hp49g+/hp48gII User's Guide*.)

Each program listing in this chapter gives the following information:

- A brief description of the program.
- A syntax diagram (where needed) showing the program's required inputs and resulting outputs.
- Discussion of special programming techniques in the program.
- Any other programs needed.
- The program listing.
- The program's checksum and byte size.

Fibonacci Numbers

This section includes three programs that calculate Fibonacci numbers:

- *FIB1* is a user-defined function that is defined *recursively* (that is, its defining procedure contains its own name). *FIB1* is short.
- *FIB2* is a user-defined function with a definite loop. It's longer and more complicated than *FIB1*, but faster.
- *FIBT* calls both *FIB1* and *FIB2* and calculates the execution time of each subprogram.

FIB1 and *FIB2* demonstrate an approach to calculating the n th Fibonacci number F_n , where:

$$F_0 = 0, F_1 = 1, F_n = F_{n-1} + F_{n-2}$$



FIB1 (Fibonacci Numbers, Recursive Version)

| | | |
|---------|---|---------|
| Level 1 | → | Level 1 |
| n | → | F_n |

Techniques used in FIB1

- **IFTE (if -then-else function).** The defining procedure for *FIB1* contains the conditional *function* IFTE, which can take its argument either from the stack or in algebraic syntax.
- **Recursion.** The defining procedure for *FIB1* is written in terms of *FIB1*, just as F_n is defined in terms of F_{n-1} and F_{n-2} .

FIB1 program listing

| Program: | Comments: |
|--|---|
| ⌘ | |
| <pre> → n ' IFTE(n≤1, n, FIB1(n-1)+FIB1(n-2)) ' </pre> | Defines local variable n . The defining procedure, an algebraic expression. If $n \leq 1$, $F_n = n$, else $F_n = F_{n-1} + F_{n-2}$. |
| ⌘ | |
|   FIB1  | Stores the program in <i>FIB1</i> . |

Checksum: # 14909d (press    PRG  )
 Bytes: 113.5

Example: Calculate F_6 . Calculate F_{10} using algebraic syntax.

First calculate F_6 .



Next, calculate F_{10} using algebraic syntax.

   () 10 



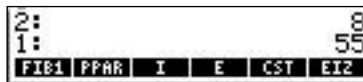

FIB2 (Fibonacci Numbers, Loop Version)

| | | |
|---------|---|---------|
| Level 1 | → | Level 1 |
| n | → | F_n |

Techniques used in FIB2

- **IF...THEN...ELSE...END.** *FIB2* uses the program-structure form of the conditional. (*FIB1* uses IFTE.)
- **START...NEXT (definite loop).** To calculate F_n , *FIB2* starts with F_0 and F_1 and repeats a loop to calculate successive values of F_i .

FIB2 program listing

| Program: | Comments: |
|--|---|
| ⌘ | |
| → n ⌘ | Creates a local variable structure. |
| <pre> IF n 1 ≤ THEN n ELSE 0 1 2 n START DUP ROT + NEXT SWAP DROP END ⌘ </pre> | <p>If $n \leq 1$,</p> <p>then $F_n = n$; otherwise ...</p> <p>Puts F_0 and F_1 on the stack.</p> <p>From 2 to n does the following loop: Copies the latest F (initially F_1) Gets the previous F (initially F_0) Calculates the next F (initially F_2)</p> <p>Repeats the loop. Drops F_{n-1}. Ends the ELSE clause. Ends the defining procedure.</p> |
| ⌘ | |
|   FIB2  | Stores the program in <i>FIB2</i> . |

Checksum: # 23902d (press    )

Bytes: 89

Example: Calculate F_6 and F_{10} .

Calculate F_6 .



6 



Calculate F_{10} .

10 



FIBT (Comparing Program-Execution Time)

FIB1 calculates intermediate values F_i more than once, while *FIB2* calculates each intermediate F_i only once. Consequently, *FIB2* is faster. The difference in speed increases with the size of n because the time required for *FIB1* grows exponentially with n , while the time required for *FIB2* grows only linearly with n .

FIBT executes the TICKS command to record the execution time of FIB1 and FIB2 for a given value of n .

| | | | | |
|----------------|---|----------------|----------------|----------------|
| Level 1 | → | Level 3 | Level 2 | Level 1 |
| n | → | F_n | FIB1 TIME: z | FIB2 TIME: z |

Techniques used in FIBT

- **Structured programming.** FIBT calls both FIB1 and FIB2.
- **Programmatic use of calculator clock.** FIBT executes the TICKS command to record the start and finish of each subprogram.
- **Labeling output.** FIBT tags each execution time with a descriptive message.

Required Programs

- FIB1 (page 2-2) calculates F_n using recursion.
- FIB2 (page 2-3) calculates F_n using looping.

FIBT program listing

| Program: | Comments: |
|--|--|
| ⌘ | |
| DUP TICKS SWAP FIB1 SWAP TICKS SWAP - B→R 8192 / | Copies n , then executes FIB1, recording the start and stop time. Calculates the elapsed time, converts it to a real number, and converts that number to seconds. Leaves the answer returned by FIB1 in level 2. |
| "FIB1 TIME" →TAG ROT TICKS SWAP FIB2 TICKS SWAP DROP SWAP - B→R 8192 / | Tags the execution time. Executes FIB2, recording the start and stop time. Drops the answer returned by FIB2 (FIB1 returned the same answer). Calculates the elapsed time for FIB2 and converts to seconds. |
| "FIB2 TIME" →TAG | Tags the execution time. |
| ⌘ | |
| ENTER ' FIBT STOP | Stores the program in FIBT. |

Checksum: # 23164d

Bytes: 129

Example: Calculate F_{13} and compare the execution time for the two methods.

Select the VAR menu and do the calculation.

VAR
13



F_{13} is 233. *FIB2* takes fewer seconds to execute than *FIB1* (far fewer if n is large). (The times required for the calculations depend on the contents of memory and other factors, so you may not get the exact times shown above.)

Displaying a Binary Integer

This section contains three programs:

- *PAD* is a utility program that converts an object to a string for right-justified display.
- *PRESERVE* is a utility program for use in programs that change the calculator's status (angle mode, binary base, and so on).
- *BDISP* displays a binary integer in HEX, DEC, OCT, and BIN bases. It calls *PAD* to show the displayed numbers right-justified, and it calls *PRESERVE* to preserve the binary base.

PAD (Pad with Leading Spaces)

PAD converts an object to a string, and if the string contains fewer than 22 characters, adds spaces to the beginning of the string till the string reaches 22 characters.



When a short string is displayed with *DISP*, it appears left-justified: its first character appears at the left end of the display. By adding spaces to the beginning of a short string, *PAD* moves the string to the right. When the string (including leading spaces) reaches 22 characters, it appears *right-justified*: its last character appears at the right end of the display. *PAD* has no effect on longer strings.

| | | |
|----------------|---|-----------------|
| Level 1 | → | Level 1 |
| <i>object</i> | → | <i>"object"</i> |

Techniques used in PAD

- **WHILE...REPEAT...END (indefinite loop).** The WHILE clause contains a test that executes the REPEAT clause and tests again (if true) or skips the REPEAT clause and exits (if false).
- **String operations.** *PAD* demonstrates how to convert an object to string form, count the number of characters, and combine two strings.

PAD program listing

| Program: | Comments: |
|---|---|
| « | |
| →STR | Makes sure the object is in string form. (Strings are unaffected by this command.) |
| WHILE DUP SIZE 22 < REPEAT " " SWAP + | Repeats if the string contains fewer than 22 characters. Loop-clause adds a leading space. |
| END | End loop. |
| » | |
|   PAD  | Stores the program in <i>PAD</i> . |

Checksum: # 6577d

Bytes: 57.5

PAD is demonstrated in the program *BDISP*.

PRESERVE (Save and Restore Previous Status)

PRESERVE stores the current calculator (flag) status, executes a program from the stack, and restores the previous status.

| Level 1 | → | Level 1 |
|-----------|---|-------------------|
| «program» | → | result of program |
| 'program' | → | result of program |

Techniques used in PRESERVE

- **Preserving calculator flag status.** *PRESERVE* uses *RCLF* (*recall flags*) to record the current status of the calculator in a binary integer, and *STOF* (*store flags*) to restore the status from that binary integer.
- **Local-variable structure.** *PRESERVE* creates a local variable structure to briefly remove the binary integer from the stack. Its defining procedure simply evaluates the program argument, then puts the binary integer back on the stack and executes *STOF*.
- **Error trapping.** *PRESERVE* uses *IFERR* to trap faulty program execution on the stack and to restore flags. *DOERR* shows the error if one occurs.

PRESERVE program listing

| Program: | Comments: |
|--|--|
| ⌘ | |
| RCLF | Recalls the list of four 64-bit binary integers representing the status of the 128 system flags and 128 user flags. |
| <pre> ⇨ f ⌘ IFERR EVAL THEN f STOF ERRN DOERR END f STOF </pre> | <p>Stores the list in local variable <i>f</i>. Begins the defining procedure. Starts the error trap. Executes the program placed on the stack as the level 1 argument. If the program caused an error, restores flags, shows the error, and aborts execution. Ends the error routine. Puts the list back on the stack, then restores the status of all flags.</p> |
| ⌘ | Ends the defining procedure. |
| ⌘ | |
| <input type="button" value="ENTER"/> <input type="button" value="'"/> PRESERVE <input type="button" value="STOP"/> | Stores the program in <i>PRESERVE</i> . |

Checksum: # 26834d

Bytes: 71

PRESERVE is demonstrated in the program *BDISP*.

BDISP (Binary Display)

BDISP displays a real or binary number in HEX, DEC, OCT, and BIN bases.

| | | |
|----------------|---|----------------|
| Level 1 | → | Level 1 |
| <i># n</i> | → | <i># n</i> |
| <i>n</i> | → | <i>n</i> |

Techniques used in BDISP

- **IFERR...THEN...END (error trap).** To accommodate real-number arguments, *BDISP* includes the command $R \rightarrow B$ (*real-to-binary*). However, this command causes an error if the argument is *already* a binary integer. To maintain execution if an error occurs, the $R \rightarrow B$ command is placed inside an IFERR clause. No action is required when an error occurs (since a binary number is an acceptable argument), so the THEN clause contains no commands.
- **Enabling LASTARG.** In case an error occurs, the LASTARG recovery feature must be enabled to return the argument (the binary number) to the stack. *BDISP* clears flag -55 to enable this.
- **FOR...NEXT loop (definite loop with counter).** *BDISP* executes a loop from 1 to 4, each time displaying n (the number) in a different base on a different line. The loop counter (named j in this program) is a local variable created by the FOR...NEXT program structure (rather than by a \rightarrow command), and automatically incremented by NEXT.
- **Unnamed programs as arguments.** A program defined only by its $\{$ and $\}$ delimiters (not stored in a variable) is not automatically evaluated, but is placed on the stack and can be used as an argument for a subroutine. *BDISP* demonstrates two uses for unnamed program arguments:
 - *BDISP* contains a main program argument and a call to *PRESERVE*. This program argument goes on the stack and is executed by *PRESERVE*.
 - *BDISP* also contains four program arguments that “customize” the action of the loop. Each of these contains a command to change the binary base, and each iteration of the loop evaluates one of these arguments.

When *BDISP* creates a local variable for n , the defining procedure is an unnamed program. However, since this program is a defining procedure for a local variable structure, it is automatically executed.

Required Programs

PAD

- *PAD* (Pad with Leading Spaces) expands a string to 22 characters so that *DISP* shows it right-justified.

PRESERVE

PRESERVE (S) stores the current status, executes the main nested program, and restores the status.

BDISP program listing

| Program: | Comments: |
|---|--|
| <pre> « « DUP -55 CF IFERR R→B THEN END → n « CLLCD « BIN » « OCT » « DEC » « HEX » 1 4 FOR j EVAL n →STR PAD j DISP NEXT » 3 FREEZE » PRESERVE </pre> | <p>Begins the main nested program. Makes a copy of <i>n</i>. Clears flag -55 to enable LASTARG. Begins error trap. Converts <i>n</i> to a binary integer. If an error occurs, do nothing (no commands in the THEN clause). Creates a local variable <i>n</i> and begins the defining program. Clears the display. Nested program for BIN. Nested program for OCT. Nested program for DEC. Nested program for HEX. Sets the counter limits. Starts the loop with counter <i>j</i>. Executes one of the nested base programs (initially for HEX). Makes a string showing <i>n</i> in the current base. Pads the string to 22 characters. Displays the string in the <i>j</i>th line. Increments <i>j</i> and repeats the loop. Ends the defining program. Freezes the status and stack areas. Ends the main nested program. Stores the current flag status, executes the main nested program, and restores the status.</p> |
| <pre> » </pre> | |
| <pre> [ENTER] ' BDISP [STO] </pre> | <p>Stores the program in <i>BDISP</i>.</p> |

Checksum: # 22884d

Bytes: 187

Example: Switch to DEC base, display #100 in all bases, and check that BDISP restored the base to DEC. Clear the stack and select the MTH BASE menu. Make sure the current base is DEC and enter # 100.

CLEAR
 BASE
 # 100

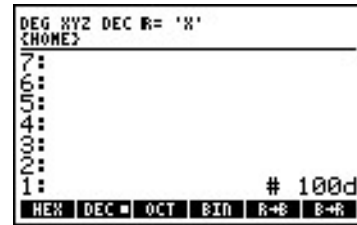

Execute *BDISP*.

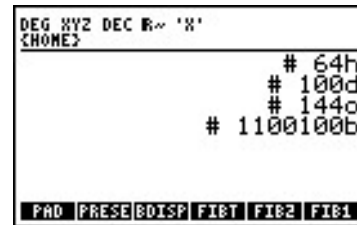

Return to the normal stack display and check the current base.

CANCEL
 BASE



Although the main nested program left the calculator in BIN base, *PRESERVE* restored DEC base. To check that *BDISP* also works for real numbers, try 144.

144

Press to return to the stack display.



Median of Statistics Data

This section contains two programs:

- *%TILE* returns the value of a specified percentile of a list.
- *MEDIAN* uses *%TILE* to calculate the median of the current statistics data.

%TILE (Percentile of a list)

%TILE sorts a list, then returns the value of a specified percentile of the list. For example, typing `{ list } 50` and pressing returns the median (50th percentile) of the list.

| Level 2 | Level 1 | → | Level 1 |
|----------|----------|---|--|
| { list } | <i>n</i> | → | <i>n</i> th percentile of sorted list |

Techniques used in %TILE

- **FLOOR and CEIL.** For an integer, FLOOR and CEIL both return that integer; for a noninteger, FLOOR and CEIL return successive integers that bracket the noninteger.
- **SORT.** The SORT command sorts the list elements into ascending order.

%TILE program listing (Note: Use Approximate mode for this program and example)

| Program: | Comments: |
|---|--|
| ⌘ | |
| <pre> SWAP SORT DUP SIZE 1 + ROT 100 / * → P ⌘ DUP P FLOOR GET SWAP P CEIL GET + 2 / ⌘ </pre> | <p>Brings the list to level 1 and sorts it. Copies the list, then finds its size. Calculates the position of the specified percentile. Stores the center position in local variable p. Begins the defining procedure. Makes a copy of the list. Gets the number at or below the center position. Moves the list to level 1. Gets the number at or above the center position. Calculates the average of the two numbers.</p> |
| ⌘ | Ends the defining procedure. |
| <pre> [ENTER] ['] %TILE [STOP] </pre> | Stores the program in %TILE. |

Checksum: # 50559d

Bytes: 99

Example: Calculate the median of the list {8 3 1 5 2}.

← {} 8 3 1 5 2 [ENTER]

[VAR] 50 [TILE]

1: 3.
%TILE PAD PRESE [DISP] FIBT FIB2

MEDIAN (Median of Statistics Data)

MEDIAN returns a vector containing the medians of the columns of the statistics data. Note that for a sorted list with an odd number of elements, the median is the value of the center element; for a list with an even number of elements, the median is the average value of the elements just above and below the center.

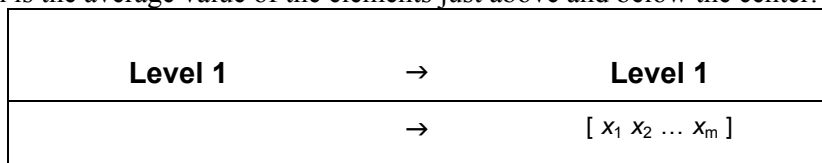

Techniques used in MEDIAN

- **Arrays, lists, and stack elements.** *MEDIAN* extracts a column of data from ΣDAT in vector form. To convert the vector to a list, *MEDIAN* puts the vector elements on the stack and combines them into a list. From this list the median is calculated using *%TILE*.

The median for the m th column is calculated first, and the median for the first column is calculated last. As each median is calculated, *ROLLD* is used to move it to the top of the stack.

After all medians are calculated and positioned on the stack, they're combined into a vector.

- **FOR...NEXT (definite loop with counter).** *MEDIAN* uses a loop to calculate the median of each column. Because the medians are calculated in reverse order (last column first), the counter is used to reverse the order of the medians.

Required Program

- *%TILE* (page 2-10) sorts a list and returns the value of a specified percentile.

MEDIAN program listing (Note: Use approximate mode for this program and example).

| Program: | Comments: |
|--------------------|--|
| ⌘ | |
| RCLΣ | Puts a copy of the current statistics matrix ΣDAT on the stack. |
| DUP SIZE | Puts the list $\{ n m \}$ on the stack, where n is the number of rows in ΣDAT and m is the number of columns. |
| OBJ→ DROP | Puts n and m on the stack, and drops the list size. |
| → Σ n m | Creates local variables for s , n , and m . |
| ⌘ 'ΣDAT' TRN | Begins the defining procedure. Recalls and transposes ΣDAT . Now n is the number of columns in ΣDAT and m is the number of rows. (To key in the Σ character, press $\left[\rightarrow \right] \Sigma$, then delete the parentheses.) |
| 1 m FOR j Σ- | Specifies the first and last rows. For each row, does the following: Extracts the last row in ΣDAT . Initially this is the m th row, which corresponds to the m th column in the original ΣDAT . (To key in the Σ- command, use $\left[\rightarrow \right] \text{CAT } \cdot$) |

| Program: | Comments: |
|--|---|
| <pre> OBJ→ DROP n →LIST 50 %TILE j ROLLD NEXT </pre> | <p>Puts the row elements on the stack. Drops the index list { n }. Makes an n-element list. Sorts the list and calculates its median. Moves the median to the proper stack level. Increments j and repeats the loop.</p> |
| <pre> m →ARRY Σ STOΣ ⌘ </pre> | <p>Combines all the medians into an m-element vector. Restores ΣDAT to its previous value. Ends the defining procedure.</p> |
| ⌘ | |
| <pre> [ENTER] ['] MEDIAN [STOP] </pre> | Stores the program in <i>MEDIAN</i> . |

Checksum: # 50773d
Bytes: 136

Example: Calculate the median of the following data.

$$\begin{bmatrix} 18 & 12 \\ 4 & 7 \\ 3 & 2 \\ 11 & 1 \\ 31 & 48 \\ 20 & 17 \end{bmatrix}$$

There are two columns of data, so *MEDIAN* will return a two-element vector.

Enter the matrix.

```

[→] STAT [MODE] [MODE]
18 [ENTER] 12 [ENTER] [↓] [←] [←]
4 [ENTER] 7 [ENTER]
3 [ENTER] 2 [ENTER]
11 [ENTER] 1 [ENTER]
31 [ENTER] 48 [ENTER]
20 [ENTER] 17 [ENTER]
[ENTER] [MODE]

```

```

RAD WYZ DEC R~ 'R'
[HOME]
2:
1: [[ 18. 12. ]
   [ 4. 7. ]
   [ 3. 2. ]
   [ 11. 1. ]
   [ 31. 48. ]
   [ 20. 17. ]]
VECTR|MATRX|LIST|WVZ|REAL|BASE

```

The matrix is now stored in ΣDAT .

Calculate the median.

```

[VAR] [MODE]

```

```

1: [14.5 9.5]
[EDIT] [MEDIA] [SPAR] [TILE] [FAC] [PRESE]

```

Clear approximate mode (set exact mode) before going on to the next example.

Expanding and Collecting Completely

This section contains two programs:

- *MULTI* repeats a program until the program has no effect on its argument.
- *EXCO* calls *MULTI* to completely expand and collect an algebraic.

MULTI (Multiple Execution)

Given an object and a program that acts on the object, *MULTI* applies the program to the object repeatedly until the program no longer changes the object.

| | | | |
|----------------|--------------------|---|---------------------------------|
| Level 2 | Level 1 | → | Level 1 |
| <i>object</i> | « <i>program</i> » | → | <i>object</i> _{result} |

Techniques used in MULTI

- **DO...UNTIL...END (indefinite loop).** The DO clause contains the steps to be repeated. The UNTIL clause contains the test that repeats both clauses again (if false) or exits (if true).
- **Programs as arguments.** Although programs are commonly named and then executed by calling their names, programs can also be put on the stack and used as arguments to other programs.
- **Evaluation of local variables.** The program argument to be executed repeatedly is stored in a local variable. It's convenient to store an object in a local variable when you don't know beforehand how many copies you'll need. An object stored in a local variable is simply put on the stack when the local variable is evaluated. *MULTI* uses the local variable name to put the program argument on the stack and then executes EVAL to execute the program.

MULTI program listing

| Program: | Comments: |
|---|---|
| ⌘ | |
| → P | Creates a local variable <i>p</i> that contains the program from level 1. |
| ⌘ DO DUP P EVAL DUP ROT UNTIL SAME END ⌘ | Begins the defining procedure. Begins the DO loop clause. Makes a copy of the object, now in level 1. Applies the program to the object, returning its new version. Makes a copy of the new object. Moves the old version to level 1. Begins the DO test clause. Tests whether the old version and the new version are the same. Ends the DO structure. Ends the defining procedure. |
| ⌘ | |
| ⌘ ENTER ' MULTI ⌘ | Stores the program in <i>MULTI</i> . |

Checksum: # 22693d

Bytes: 56

MULTI is demonstrated in the next programming example.

EXCO (Expand and Collect Completely)

EXCO repeatedly executes *EXPAN* on an algebraic until the algebraic doesn't change, then repeatedly executes *COLCT* until the algebraic doesn't change. In some cases the result will be a number.

Expressions with many products of sums or with powers can take many iterations of *EXPAN* to expand completely, resulting in a long execution time for *EXCO*.

| | | |
|----------------|---|----------------|
| Level 1 | → | Level 1 |
| 'algebraic' | → | 'algebraic' |
| 'algebraic' | → | z |

Techniques used in EXCO

- **Subroutines.** *EXCO* calls the program *MULTI* twice. It is more efficient to create program *MULTI* and simply call its name twice than write each step in *MULTI* two times.

Required Programs

- *MULTI* (Multiple Execution) repeatedly executes the programs that *EXCO* provides as arguments.

EXCO program listing

| Program: | Comments: |
|-------------------|---|
| ⌘ | |
| ⌘ EXPAN ⌘ | Puts a program on the stack as the level 1 argument for <i>MULTI</i> . The program executes the <i>EXPAN</i> command. |
| MULTI | Executes <i>EXPAN</i> until the algebraic object doesn't change. |
| ⌘ COLCT ⌘ | Puts another program on the stack for <i>MULTI</i> . The program executes the <i>COLCT</i> command. |
| MULTI | Executes <i>COLCT</i> until the algebraic object doesn't change. |
| ⌘ | |
| ENTER ' EXCO STOP | Stores the program in <i>EXCO</i> . |

Checksum: # 41162d

Bytes: 65.5

Example: Expand and collect completely the expression:

$$3x(4y+z) + (8x-5z)^2$$

Enter the expression.

Y Z
 X 5 Z
 2

1: 3X(4Y+Z)+(8X-5Z)²
 EXCO MULTI EDIT MEDIA EPAB RTILE

Select the VAR menu and start the program.

1: 64X²+(12Y-77Z)X+25t
 EXCO MULTI CASDI

Minimum and Maximum Array Elements

This section contains two programs that find the minimum or maximum element of an array:

- MNX uses a DO...UNTIL...END (indefinite) loop.
- MNX2 uses a FOR...NEXT (definite) loop.

MNX (Minimum or Maximum Element—Version 1)





MNX finds the minimum or maximum element of an array on the stack.

| | | | |
|-------------|---|-------------|--------------------------|
| Level 1 | → | Level2 | Level 1 |
| [[array]] | → | [[array]] | Z_{\min} or Z_{\max} |

Techniques used in MNX

- **DO...UNTIL...END (indefinite loop).** The DO clause contains the sort instructions. The UNTIL clause contains the system-flag test that determines whether to repeat the sort instructions.
- **User and system flags for logic control:**
 - User* flag 10 defines the sort: When flag 10 is set, MNX finds the maximum element; when flag 10 is clear, it finds the minimum element. *You* determine the state of flag 10 at the beginning of the program.
 - System* flag -64, the Index Wrap Indicator flag, determines when to end the sort. While flag -64 is clear, the sort loop continues. When the index invoked by GETI wraps back to the first array element, flag -64 is *automatically* set, and the sort loop ends.
- **Nested conditional.** An IF...THEN...END conditional is nested in the DO...UNTIL...END conditional, and determines the following:
 - Whether to maintain the current minimum or maximum element, or make the current element the new minimum or maximum.
 - The sense of the comparison of elements (either < or >) based on the status of flag 10.
- **Custom menu.** MNX builds a custom menu that lets you choose whether to sort for the minimum or maximum element. Key 1, labeled , sets flag 10. Key 2, labeled , clears flag 10.
- **Logical function.** MNX executes XOR (*exclusive OR*) to test the combined state of the relative value of the two elements and the status of flag 10.

MNX program listing

| Program: | Comments: |
|---|--|
| ⌘ | |
| <pre> (("MAX" ⌘ 10 SF CONT ⌘) ("MIN" ⌘ 10 CF CONT ⌘)) </pre> | Defines the option menu.  sets flag 10 and continues execution.  clears flag 10 and continues execution. |
| <pre> TMENU "Sort for MAX or MIN?" PROMPT </pre> | Displays the temporary menu and a prompt message. |
| <pre> 1 GETI DO ROT ROT GETI </pre> | Gets the first element of the array. Begins the DO loop. Puts the index and the array in levels 1 and 2, then gets the new array element. |
| <pre> 4 ROLL DUP2 </pre> | Moves the current minimum or maximum array element from level 4 below 1, then copies both. |
| <pre> IF > 10 FS? XOR </pre> | Tests the combined state of the relative value of the two elements and the status of flag 10. |
| <pre> THEN SWAP END </pre> | If the new element is either less than the current maximum or greater than the current minimum, swaps the new element into level 1. |
| <pre> DROP </pre> | Drops the other element off the stack. |
| <pre> UNTIL -64 FS? </pre> | Begins the DO test-clause. Tests if flag -64 is set — if the index reached the end of the array. |
| <pre> END SWAP DROP 0 MENU </pre> | Ends the DO loop. Swaps the index to level 1 and drops it. Restores the last menu. |
| ⌘ | |
|   MNX  | Stores the program in MNX. |

Checksum: # 20991d

Bytes: 194.5

Example: Find the maximum element of the following matrix:

$$\begin{bmatrix} 12 & 56 \\ 45 & 1 \\ 9 & 14 \end{bmatrix}$$

Enter the matrix.

← MTRW

12 ENTER 56 ENTER ↓ ← ←
45 ENTER 1 ENTER
9 ENTER 14 ENTER
ENTER

```
1: [[ 12. 56. ]
   [ 45. 1. ]
   [ 9. 14. ]]
VECTRMATRXLIST HVP REAL BASE
```

Select the VAR menu and execute MNX.

VAR 

```
Sort for MAX or MIN?
0:
1:
2:
3:
4:
1: [[ 12. 56. ]
   [ 45. 1. ]
   [ 9. 14. ]]
MAX MIN
```

Find the maximum element.





```
2: [[ 12. 56. ]
   [ 45. 1. ]
   [ 9. 14. ]]
1: 56.
VECTRMATRXLIST HVP REAL BASE
```

MNX2 (Minimum or Maximum Element- Version 2)





Given an array on the stack, MNX2 finds the minimum or maximum element in the array. MNX2 uses a different approach than MNX: it executes OBJ→ to break the array into individual elements on the stack for testing, rather than executing GETI to index through the array.

| Level 1 | → | Level2 | Level 1 |
|-------------|---|-------------|--------------------------------------|
| [[array]] | → | [[array]] | Z _{max} or Z _{min} |

Techniques used in MNX2

- **FOR...NEXT (definite loop).** The initial counter value is 1. The final counter value is $nm - 1$, where nm is the number of elements in the array. The loop-clause contains the sort instructions.
- **User flag for logic control.** User flag 10 defines the sort: When flag 10 is set, MNX2 finds the maximum element; when flag 10 is clear, it finds the minimum element. You determine the status of flag 10 at the beginning of the program.
- **Nested conditional.** An IF...THEN...END conditional is nested in the FOR...NEXT loop, and determines the following:
 - Whether to maintain the current minimum or maximum element, or make the current element the new minimum or maximum.
 - The sense of the comparison of elements (either < or >) based on the status of flag 10.
- **Logical function.** MNX2 executes XOR (*exclusive OR*) to test the combined state of the relative value of the two elements and the status of flag 10.
- **Custom menu.** MNX2 builds a custom menu that lets you choose whether to sort for the minimum or maximum element. Key 1, labeled , sets flag 10. Key 2, labeled , clears flag 10.

MNX2 program listing

| Program: | Comments: |
|--|--|
| ⌘ | |
| { { "MAX" ⌘ 10 SF CONT ⌘ } { "MIN" ⌘ 10 CF CONT ⌘ } } | Defines the temporary option menu.  sets flag 10 and continues execution.  clears flag 10 and continues execution. |
| TMENU "Sort for MAX or MIN?" PROMPT DUP OBJ→ | Displays the temporary menu and a prompting message. Copies the array. Returns the individual array elements to levels 2 through $nm+1$, and returns the list containing n and m to level 1. |
| 1 SWAP OBJ→ | Sets the initial counter value. Converts the list to individual elements on the stack. |
| DROP * 1 - | Drops the list size, then calculates the final counter value ($nm - 1$). |
| FOR n | Starts the FOR...NEXT loop. |
| DUP2 | Saves the array elements to be tested (initially the last two elements). Uses the last array element as the current minimum or maximum. |
| IF > 10 FS? XOR | Tests the combined state of the relative value of the two elements and the status of flag 10. |
| THEN SWAP END | If the new element is either less than the current maximum or greater than the current minimum, swaps the new element into level 1. |
| DROP NEXT ⌘ MENU | Drops the other element off the stack. Ends the FOR...NEXT loop. Restores the last menu. |
| ⌘ | |
|   MNX2  | Stores the program in <i>MNX2</i> . |

Checksum: # 6992d

Bytes: 188.5

Example: Use *MNX2* to find the minimum element of the matrix from the previous example:

$$\begin{bmatrix} 12 & 56 \\ 45 & 1 \\ 9 & 14 \end{bmatrix}$$

Enter the matrix (or retrieve it from the previous example).

← MTRW

12 [ENTER] 56 [ENTER] [DOWN] [LEFT] [LEFT]

45 [ENTER] 1 [ENTER]

9 [ENTER] 14 [ENTER]

[ENTER]

Select the VAR menu and execute MNX2.

[VAR] [MNX2]

```

1: [[ 12. 56. ]
   [ 45. 1. ]
   [ 9. 14. ]]
VECTRMATRX LIST HYP REAL BASE

```

```

Sort for MAX or MIN?
:
:
:
:
:
1: [[ 12. 56. ]
   [ 45. 1. ]
   [ 9. 14. ]]
MAX MIN

```

Find the minimum element.

[MNX2]

```

2: [[ 12. 56. ] [ 45...
1: 1.
VECTRMATRX LIST HYP REAL BASE

```

Applying a Program to an Array

APLY makes use of list processing to transform each element of an array according to a desired procedure. The input array must be numeric, but the output array may be symbolic.

The procedure applied to each element must be a program that takes exactly one argument (i.e. the element) and returns exactly one result (i.e. the transformed element).

| | | | |
|-----------|-------------|---|----------------------------|
| Level 2 | Level 1 | → | Level 1 |
| [array] | « program » | → | [[array]] or {{ array }} |

Techniques used in APLY

- **Manipulating Meta-Objects.** *Meta-objects* are composite objects like arrays and lists that have been disassembled on the stack. APLY illustrates several approaches to manipulating the elements and dimensions of such objects.
- **Application of List Processing.** APLY makes use of DOSUBS (although DOLIST might also have been used) to perform the actual transformation of array elements.
- **Using an IFERR...THEN...ELSE...END Structure.** The entire symbolic pseudo-array case is handled within a error structure — triggered when the →ARRAY command generates an error when symbolic elements are present.
- **Using Flags.** User flag 1 is used to track the case when the input array is a vector.

APLY program listing

| Program: | Comments: |
|------------|---|
| ⌘ | |
| → a p ⌘ | Store the array and program in local variables. Begin the main local variable structure. |

| Program: | Comments: |
|---|---|
| 1 CF a DUP SIZE DUP SIZE IF 1 == | Make sure the flag 1 is clear to begin the procedure. Retrieve the dimensions of the array. Determine if the array is a vector. |
| THEN 1 SF 1 + | If array is a vector, set flag 1 and add a second dimension by treating the vector as an $n \times 1$ matrix. |
| SWAP OBJ→ OBJ→ DROP | Disassemble the original vector, leaving the element count, n , in level 1. |
| 1 + ROLL | Roll the elements up the stack and bring the “matrix” dimensions of the vector to level 1. |
| ELSE DROP2 a OBJ→ | If array is a matrix, clean up the stack and decompose the matrix into its elements, leaving its dimension list on level 1. |
| END DUP OBJ→ DROP * | Duplicate the dimension list and compute the total number of elements. |
| SWAP OVER 2 + ROLLD →LIST | Roll up the element count and combine all elements into a list. Note that the elements in the list are in row-major order. |
| 1 p DOSUBS | Recalls the program and uses it as an argument for DOSUBS (DOLIST works in this case as well). Result is a list of transformed elements. |
| OBJ→ 1 + ROLL | Disassembles the result list and brings the array dimensions to level 1. |
| IFERR | Begins the error-trapping structure. Its purpose is to find and handle the cases when the result list contains symbolic elements. |
| IF 1 FS? THEN OBJ→ DROP →LIST | Was original array a vector? If the original array was a vector, then drop the second dimension (1) from the dimension list. |
| END →ARRAY | Convert the elements into an array with the given dimensions. If there are symbolic elements present, an error will be generated and the error clause which follows will be executed. |
| THEN OBJ→ | Begin the error clause. Put the array dimensions on levels 2 and 1. If the array is a vector, level 1 contains a 1. |
| IF 1 FC?C THEN DROP END → n m | Is original array a matrix? Clear flag 1 after performing the test. Drop the number of matrix elements. Store the array dimensions in local variables. |
| « 1 n FOR i | Begin local variable structure and initiate FOR...NEXT loop for each row. |
| m →LIST | Collect a group of elements into a row (a list). |

nBASE program listing

| Program: | Comments: |
|---|--|
| « | |
| 1 CF 0 RND SWAP 0 RND RCLF | Clear flag 1, round both arguments to integers and recall flag settings. |
| → b n f | Store the base, number and flag settings in local variables. |
| « | Begin the outer local variable structure. |
| STD n LOG b LOG / | Sets “standard” display mode and computes the ratio of the common logarithms of number and base. |
| 10 RND | Rounds result to remove imprecision in last decimal place. |
| IP n 0 | Find the integer part of log ratio, recall the original number, and initialize the counter variable k for use in the DO...UNTIL loop. |
| → i m k | Store the values in local variables. |
| « "" DO 'm' EVAL b i 'k' EVAL - ^ | Begin inner local variable structure, enter an empty string and begin the DO...UNTIL...END loop. Compute the decimal value of the $(i - k)$ th position in the string. |
| DUP2 MOD | Makes a copy of the arguments and computes the decimal value still remaining that must be accounted for by other positions. |
| IF DUP 0 == 'm' EVAL b ≥ AND THEN 1 SF | Is the remainder zero <i>and</i> $m \geq b$? If the test is true, then set flag 1. |
| END 'm' STO / IP | Store the remainder in m . Compute the number of times the current position-value goes into the remaining decimal value. This is the “digit” that belongs in the current position. |
| IF DUP 10 ≥ THEN 55 ELSE 48 END + CHR | Is the “digit” ≥ 10 ? Then convert the digit into an alphabetic digit (such as A, B, C, ...). |
| + 'k' 1 STO+ | Append the digit to the current result string and increment the counter variable k . |

| Program: | Comments: |
|--|--|
| <pre>UNTIL 'm' EVAL 0 == END IF 1 FS?C</pre> | <p>Repeat the DO...UNTIL loop until $m = 0$ (i.e. all decimal value have been accounted for).</p> <p>Is flag 1 set? Clear the flag after the test.</p> |
| <pre>THEN "0" +</pre> | <p>Then add a placeholding zero to the result string.</p> |
| <pre>WHILE i 'k' EVAL - 0 ≥</pre> | <p>Begin WHILE...REPEAT loop to determine if additional placeholding zeros are needed.</p> <p>Loop repeats as long as $i \neq k$.</p> |
| <pre>REPEAT "0" + i 'k' STO+ END END ⌘</pre> | <p>Add an additional placeholding zero and increment k before repeating the test-clause.</p> <p>End the WHILE...REPEAT...END loop, the IF...THEN...END structure, and the inner local variable structure.</p> |
| <pre>" base" b + n SWAP + →TAG f STOF</pre> | <p>End the outermost IF...THEN...ELSE...END structure and create the label string and tag the result string using the original arguments.</p> <p>Also restore original flag settings.</p> |
| <pre>⌘ ⌘</pre> | |
| <pre>ENTER ' nBASE STO▶</pre> | <p>Stores the program in $nBASE$.</p> |

Checksum: # 54850d

Bytes: 433

Example: Convert 1000_{10} to base 23.

1000 ENTER 23 VAR ████

```
1: 1000. base23.:
"1KB"
nBASE|APLY|MNx2|CASDI
```

Verifying Program Arguments

The two utility programs in this section verify that the argument to a program is the correct object type.

- *NAMES* verifies that a list argument contains exactly two names.
- *VFY* verifies that the argument is either a name or a list containing exactly two names. It calls *NAMES* if the argument is a list.

You can modify these utilities to verify other object types and object content.

NAMES (Check List for Exactly Two Names)

If the argument for a program is a list (as determined by *VFY*), *NAMES* verifies that the list contains exactly two names. If the list does not contain exactly two names, an error message appears in the status area and program execution is aborted.

| | | |
|------------------|---|--------------------------------|
| Level 1 | → | Level 1 |
| { valid list } | → | |
| { invalid list } | → | (error message in status area) |

Techniques used in NAMES

- **Nested conditionals.** The outer conditional verifies that there are two objects in the list. If so, the inner conditional verifies that both objects are names.
- **Logical functions.** NAMES uses the AND command in the inner conditional to determine if *both* objects are names, and the NOT command to display the error message if they are not both names.

NAMES program listing

| Program: | Comments: |
|---|--|
| ⌘ | |
| IF | Starts the outer conditional structure. |
| OBJ→ | Returns the n objects in the list to levels 2 through $(n + 1)$, and returns the list size n to level 1. |
| DUP 2. SAME | Copies the list size and tests if it's 2. |
| THEN DROP IF | If the size is 2, moves the objects to level 1 and 2, and starts the inner conditional structure. |
| TYPE 6. SAME | Tests if the object is a name: returns 1 if so, otherwise 0. |
| SWAP TYPE 6. SAME | Moves the second object to level 1, then tests if it is a name (returns 1 or 0). |
| AND | Combines test results: Returns 1 if both tests were true, otherwise returns 0. |
| NOT THEN "List needs two names" DOERR END | Reverses the final test result. If the objects are not both names, displays an error message and aborts execution. Ends the inner conditional structure. |
| ELSE DROPN "Illegal list size" DOERR END | If the list size is not 2, drops the list size, displays an error message, and aborts execution. Ends the outer conditional. |
| ⌘ | |
| ⏎ ' NAMES ⏏ | Stores the program in NAMES. |

Checksum: # 10752d

Bytes: 141.5

NAMES is demonstrated in the program *VFY*.

VFY (Verify Program Argument)

VFY verifies that an argument on the stack is either a name or a list that contains exactly two names.

| Level 1 | → | Level 1 |
|------------------|---|---|
| 'name' | → | 'name' |
| { valid list } | → | { valid list } |
| { invalid list } | → | { invalid list } (and error message in status area) |
| invalid object | → | invalid object (and error message in status area) |

Techniques used in VFY

- **Utility programs.** *VFY* by itself has little use. However, it can be used with minor modifications by other programs to verify that specific object types are valid arguments.
- **CASE...END (case structure).** *VFY* uses a case structure to determine if the argument is a list or a name.
- **Structured programming.** If the argument is a list, *VFY* calls *NAMES* to verify that the list contains exactly two names.
- **Local variable structure.** *VFY* stores its argument in a local variable so that it can be passed to *NAMES* if necessary.
- **Logical function.** *VFY* uses NOT to display an error message.



Required Programs

NAMES

- *NAMES* (Check List for Exactly Two Names) verifies that a list argument contains exactly two names.

VFY program listing

| Program: | Comments: |
|---|---|
| ⌘ | |
| DUP | Copies the original argument to leave on the stack. |
| DTAG | Removes any tags from the argument for subsequent testing. |
| → argm | Stores the argument in local variable <i>argm</i> . |
| ⌘ CASE argm TYPE 5. SAME THEN argm NAMES END | Begins the defining procedure. Begins the case structure. Tests if the argument is a list. If so, puts the argument back on the stack and calls <i>NAMES</i> to verify that the list is valid, then leaves the CASE structure. |

| Program: | Comments: |
|---|---|
| <pre> argm TYPE 6. SAME NOT THEN "Not name or list" DOERR END </pre> | Tests if the argument is not a name. If so, displays an error message and aborts execution. |
| <pre> END * </pre> | Ends the CASE structure. Ends the defining procedure. |
| <pre> * </pre> | |
|   VFY  | Enters the program, then stores it in VFY. |

Checksum: # 31403d
Bytes: 139.5

Example: Execute VFY to test the validity of the name argument *BEN*. (The argument is valid and is simply returned to the stack.)

 BEN 
 

1: 'BEN'
BASE APLY NAME CASDI

Example: Execute VFY to test the validity of the list argument *{BEN JEFF SARAH}*. Use the name from the previous example, then enter the names JEFF and SARAH and convert the three names to a list.

 JEFF 
 SARAH 

1: { BEN JEFF SARAH }
ELEM PROC OBJ+LIST SUB REPL

3  PRG 

Execute VFY. Since the list contains too many names, the error message is displayed and execution is aborted.

7: 
6:
5:
4:
3:
2:
1: { BEN JEFF SARAH }
VFY NAMESBASE APLY NAME CASDI

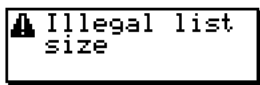
Converting Procedures from Algebraic to RPN

This section contains a program, $\rightarrow RPN$, that converts an algebraic expression into a series (list) of objects in equivalent RPN order.

| | | |
|---------|---|-------------|
| Level 1 | → | Level 1 |
| 'symb' | → | { objects } |

Techniques used in →RPN

- **Recursion.** The →RPN program calls itself as a subroutine. This powerful technique works just like calling another subroutine as long as the stack contains the proper arguments before the program calls itself. In this case the level 1 argument is tested first to be sure that it is an algebraic expression before →RPN is called again.
- **Object Type-Checking.** →RPN uses conditional branching that depends on the object type of the level 1 object.
- **Nested program Structures.** →RPN nests IF...THEN...END structures inside FOR...NEXT loops inside a IF...THEN... ELSE...END structure.
- **List Concatenation.** The result list of objects in RPN order is built by using the ability of the + command to sequentially append additional elements to a list. This is a handy technique for gathering results from a looping procedure.

→RPN program listing

| Program: | Comments: |
|-------------------------------|--|
| ⊛ | |
| OBJ→ IF OVER THEN → n f | Take the expression apart. If the argument count is nonzero, then store the count and the function. |
| ⊙ | Begins local variable defining procedure. |
| 1 n FOR i | Begins FOR...NEXT loop, which converts any algebraic arguments to lists. |
| IF DUP TYPE 9. SAME | Tests whether argument is an algebraic. |
| THEN →RPN | If argument is an algebraic, convert it to a list first. |
| END n ROLLD | Roll down the stack to prepare for the next argument. |
| NEXT | Repeat the loop for the next argument. |
| IF DUP TYPE 5. ≠ | Tests to see if level 1 object is a list. |
| THEN 1 →LIST | If not a list, then convert it to one. |
| END | Ends the IF...THEN...END structure. |
| IF n 1 > | Tests to see if there is more than one argument. |
| THEN 2 n START + NEXT | Combine all of the arguments into a list. |

| Program: | Comments: |
|------------------------|---|
| END f + | Append the function to the end of the list. |
| ⌘ | End the local variable defining procedure. |
| ELSE 1 →LIST SWAP DROP | For functions with no arguments, converts to a simple list. |
| END | End the IF...THEN...ELSE...END structure. |
| ⌘ | |
| ENTER ' →RPN STO▶ | Stores the program in →RPN. |

Checksum: # 1522d
Bytes: 181.0

Example: Convert the following algebraic expression to a series of objects in RPN syntax:

'A*cos(B+√(C/D))-X^3'

' A × cos B + √ X ()
C ÷ D) - X ^ 3 ENTER

1: C A B C D / √ + cos
* X 3 ^ -)
PURGE MEM BYTES|NEW0|DIR ARITH

Bessel Functions

This section contains a program, *BER*, that calculates the real part $Ber_n(x)$ of the Bessel function $J_n(xe^{3\pi i/4})$. When $n = 0$,

$$Ber(x) = 1 - \frac{(x/2)^4}{2!^2} + \frac{(x/2)^8}{4!^2} - \dots$$

| Level 1 | → | Level 1 |
|---------|---|----------------|
| z | → | <i>Ber</i> (z) |

Techniques used in BER

- Local variable structure.** At its outer level, *BER* consists solely of a local variable structure and so has two properties of a user-defined function: it can take numeric or symbolic arguments from the stack, or it can take arguments in algebraic syntax. However, because *BER* uses a DO...UNTIL...END loop, its defining procedure is a *program*. (Loop structures are not allowed in algebraic expressions.) Therefore, unlike user-defined functions, *BER* is not differentiable.
- DO...UNTIL...END loop (indefinite loop with counter).** *BER* calculates successive terms in the series using a counter variable. When the new term does not differ from the previous term to within the 12-digit precision of the calculator, the loop ends.
- Nested local variable structures.** The outer structure is consistent with the requirements of a user-defined function. The inner structure allows storing and recalling of key parameters.

BER program listing

| Program: | Comments: |
|--|--|
| ⌘ | |
| → x | Creates local variable x . |
| ⌘ | Begins outer defining procedure. |
| 'x/2' →NUM 2 1 → xover2 j sum | Enters $x/2$, the first counter value, and the first term of the series, then creates local variables. |
| ⌘ DO sum 'sum+(-1)^(j/2)* xover2^(2*j)/50(j!)' EVAL | Begins inner defining procedure. Begins the loop. Recalls the old sum and calculates the new sum. |
| 2 'j' STO+ DUP 'sum' STO UNTIL == END SUM | Increments the counter. Stores the new sum. Ends the loop clause. Tests the old and new sums. Ends the loop. Recalls the sum. |
| ⌘ ⌘ | Ends inner defining procedure. Ends outer defining procedure. |
| ⌘ | |
| ENTER ' BER STO | Stores the program in <i>BER</i> . |

Checksum: # 15837d

Bytes: 203

Example: Calculate BER(3).

VAR

3

Calculate BER(2) in algebraic syntax.

' () 2

EVAL

1: -.2213802496
BER | →RPN | VFY | NAMES | nBASE | RPLY

1: .751734182714
BER | →RPN | VFY | NAMES | nBASE | RPLY

Animation of Successive Taylor's Polynomials

This section contains three programs that manipulate graphics objects to display a sequence of Taylor's polynomials for the sine function.

- *SINTP* draws a sine curve, and saves the plot in a variable.

- *SETTS* superimposes plots of successive Taylor's polynomials on the sine curve plot from *SINTP*, and saves the resulting graphics objects in a list.
- *TSA* uses the ANIMATE command to display in succession each graphics object from the list built in *SETTS*.



SINTP (Converting a Plot to a Graphics Object)

SINTP draws a sine curve, returns the plot to the stack as a graphics object, and stores that graphics object in a variable. Make sure your calculator is in Radians mode.

Techniques used in SINTP

- **Programmatic use of PLOT commands.** *SINTP* uses PLOT commands to build and display a graphics object.

SINTP program listing

| Program: | Comments: |
|---|--|
| ❖ | |
| 'SIN(X)' STEQ | Stores the expression for $\sin x$ in <i>EQ</i> . |
| FUNCTION '-2*π' →NUM DUP NEG XRNG -2 2 YRNG | Sets the plot type and <i>x</i> - and <i>y</i> -axis display ranges. |
| ERASE DRAW | Erases <i>PICT</i> , then plots the expression. |
| PICT RCL 'SINT' STO | Recalls the resultant graphics object and stores it in <i>SINT</i> . |
| ❖ | |
|   SINTP  | Stores the program in <i>SINTP</i> . |

Checksum: # 41184d

Bytes: 94

SINTP is demonstrated in the program *TSA*.

SETTS (Superimposing Taylor's polynomials)

SETTS superimposes successive Taylor's polynomials on a sine curve and stores each graphics object in a list.

Techniques used in SETTS

- **Structured programming.** *SETTS* calls *SINTP* to build a sine curve and convert it to a graphics object.
- **FOR...STEP (definite loop).** *SETTS* calculates successive Taylor's polynomials for the sine function in a definite loop. The loop counter serves as the value of the order of each polynomial.
- **Programmatic use of PLOT commands.** *SETTS* draws a plot of each Taylor's polynomial.
- **Manipulation of graphics objects.** *SETTS* converts each Taylor's polynomial plot into a graphics object. Then it executes + to combine each graphics object with the sine curve stored in *SINT*, creating nine new graphics objects, each the superposition of a Taylor's polynomial on a sine curve. *SETTS* then puts the nine new graphics objects, and the sine curve graphics object itself, in a list.

SETTS program listing

| Program: | Comments: |
|---|---|
| ⌘ | |
| SINTP | Plots a sine curve and stores the graphics object in <i>SINT</i> . |
| 1 17 FOR n | Sets the range for the FOR loop using local variable <i>n</i> . |
| 'SIN(X)' 'X' n TAYLR STEQ ERASE DRAW | Plots the Taylor's polynomial of order <i>n</i> . |
| PICT RCL SINT + | Returns the plot to the stack as a graphics object and executes + to superimpose the sine plot from <i>SINT</i> . |
| 2 STEP | Increments the loop counter <i>n</i> by 2 and repeats the loop. |
| SINT 10 →LIST 'TSL' STO | Puts the sine curve graphics object on the stack, then builds a list containing it and the nine graphics objects created in the loop. Stores the list in <i>TSL</i> . |
| ⌘ | |
| ENTER ' SETTS STO | Stores the program in <i>SETTS</i> . |

Checksum: # 41304d

Bytes: 130.5

SETTS is demonstrated in the program *TSA*.

TSA (Animating Taylor's Polynomials)

TSA displays in succession each graphics object created in *SETTS*.

Techniques used in *TSA*

- **Passing a global variable.** Because *SETTS* takes several minutes to execute, *TSA* does not call *SETTS*. Instead, you must first execute *SETTS* to create the global variable *TSL* containing the list of graphics objects. *TSA* simply executes that global variable to put the list on the stack.
- **ANIMATE.** *TSA* uses the ANIMATE command to display in succession each graphics object from the list.

TSA program listing

| Program: | Comments: |
|----------------------|--|
| ❖ | |
| TSL OBJ→ | Puts the list <i>TSL</i> on the stack and converts it to 10 graphics objects and the list count. |
| ((#0 #0) .5 0) + | Set up the parameters for ANIMATE. |
| ANIMATE | Displays the graphics in succession. |
| 11 DROPN | Removes the graphics objects and list count from the stack. |
| ❖ | |
| ENTER ' TSA STO▶ | Stores the program in <i>TSA</i> . |

Checksum: # 24644d

Bytes: 92.5

Example: Execute *SETTS* and *TSA* to build and display in succession a series of Taylor's polynomial approximations of the sine function.

Set Radians mode and execute *SETTS* to build the list of graphics objects. (*SETTS* takes several minutes to execute.) Then execute *TSA* to display each plot in succession. The display shows *TSA* in progress.

← &MODE MODE MODE (if necessary)

VAR SETS

SET

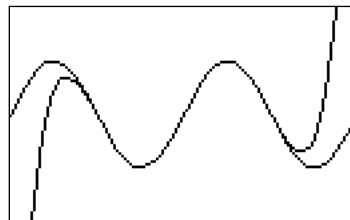

Press CANCEL to stop the animation. Press ← &MODE MODE MODE to restore Degrees mode.

Programmatic Use of Statistics and Plotting

This section describes a program *PIE* you can use to draw pie charts. *PIE* prompts for single variable data, stores that data in the statistics matrix ΣDAT , then draws a labeled pie chart that shows each data point as a percentage of the total.

Techniques used in PIE

- **Programmatic use of PLOT commands.** *PIE* executes XRNG and YRNG to define x - and y -axis display ranges in user units, and executes ARC and LINE to draw the circle and individual slices.
- **Programmatic use of matrices and statistics commands.**
- **Manipulating graphics objects.** *PIE* recalls *PICT* to the stack and executes GOR to merge the label for each slice with the plot.
- **FOR...NEXT (definite loop).** Each slice is calculated, drawn, and labeled in a definite loop.
- **CASE...END structure.** To avoid overwriting the circle, each label is offset from the midpoint of the arc of the slice. The offset for each label depends on the position of the slice in the circle. The CASE...END structure assigns an offset to the label based on the position of the slice.
- **Preserving calculator flag status.** Before specifying Radians mode, *PIE* saves the current flag status in a local variable, then restores that status at the end of the program.
- **Nested local variable structures.** At different parts of the process, intermediate results are saved in local variables for convenient recall as needed.
- **Temporary menu for data input.**

PIE program listing

| Program: | Comments: |
|---|---|
| ⌘ | |
| RCLF → flags | Recalls the current flag status and stores it in variable <i>flags</i> . |
| ⌘ RAD (("SLICE" $\Sigma+$) () ("CLEAR" CL Σ) () () ("DRAW" CONT)) | Sets Radians mode. Defines the input menu: key 1 executes $\Sigma+$ to store each data point in ΣDAT , key 3 clears ΣDAT , and key 6 continues program execution after data entry. |
| TMENU "Key values into SLICE ← DRAW restarts program." PROMPT | Displays the temporary menu. Prompts for inputs. ← represents the newline character (↵) after you enter the program on the stack. |
| ERASE 1 131 XRNG 1 64 YRNG CLLCD | Erases the current <i>PICT</i> and sets plot parameters. |

| Program: | Comments: |
|---|---|
| "Please wait... ← Drawing Pie Chart" 1 DISP | Displays "drawing" message. |
| (66,32) 20 0 6.28 ARC | Draws the circle. |
| PICT RCL →LCD RCLΣ TOT / | Displays the empty circle. Recalls the statistics data matrix, computes totals, and calculates the proportions. |
| DUP 100 * | Converts the proportions to percentages. |
| → prcnts | Stores the percentage matrix in <i>prcnts</i> . |
| ⊗ 2 π →NUM * * 0 | Multiplies the proportion matrix by 2π , and enters the initial angle (0). |
| → prop angle | Stores the angle matrix in <i>prop</i> and angle in <i>angle</i> . |
| ⊗ prop SIZE OBJ→ DROP SWAP FOR n | Sets up 1 to m as loop counter range. Begins loop-clause. |
| (66,32) prop n GET 'angle' STO+ | Puts the center of the circle on the stack, then gets the n th value from the proportion matrix and adds it to <i>angle</i> . |
| angle COS angle SIN R→C 20 * OVER + LINE | Computes the endpoint and draws the line for the n th slice. |
| PICT RCL angle prop n GET 2 / - DUP DUP COS SWAP SIN R→C 26 * (66,32) + | Recalls <i>PICT</i> to the stack. For labeling the slice, computes the midpoint of the arc of the slice. |
| SWAP CASE | Starts the CASE structure to test <i>angle</i> and determine the offset value for the label. |
| DUP 1.5 ≤ THEN DROP END | From 0 to 1.5 radians, doesn't offset the label. |
| DUP 4.4 ≤ THEN DROP 15 - END | From 1.5 to 4.4 radians, offsets the label 15 user units left. |

| Program: | Comments: |
|--|---|
| <pre> 5 < THEN (3,2) + END </pre> | From 4.4 to 5 radians, offsets the label 3 units right and 2 units up. |
| <pre> END </pre> | Ends the CASE structure. |
| <pre> prcnts n GET 1 RND →STR "%" + </pre> | Gets the <i>n</i> th value from the percentage matrix, rounds it to one decimal place, and converts it to a string with “%” appended. |
| <pre> 1 →GROB </pre> | Converts the string to a graphics object. |
| <pre> GOR DUP PICT STO </pre> | Adds the label to the plot and stores the new plot. |
| <pre> →LCD NEXT () PVIEW </pre> | Displays the updated plot. Ends the loop structure. Displays the finished plot. |
| <pre> * * </pre> | |
| <pre> flags STOF * 0 MENU </pre> | Restores the original flag status. Restores the previous menu. (You must first press CANCEL to clear the plot.) |
| <pre> * </pre> | |
| <pre> [ENTER] ['] PIE [STOP] </pre> | Stores the program in <i>PIE</i> . |

Checksum: # 16631d

Bytes: 737

Example: The inventory at Fruit of the Vroom, a drive-in fruit stand, includes 983 oranges, 416 apples, and 85 bananas. Draw a pie chart to show each fruit's percentage of total inventory.

[VAR] [STAT]

Clear the current statistics data. (The prompt is removed from the display.) Key in the new data and draw the pie chart.

CLEAR

983 [STAT]

416 [STAT]

85 [STAT]

[DRAW]

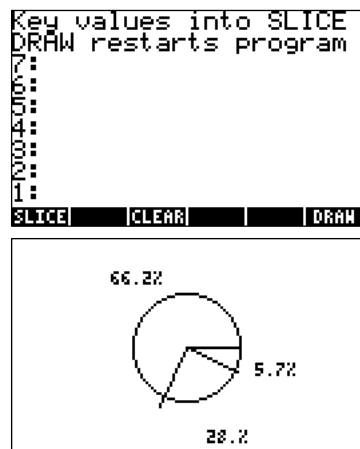

Press **CANCEL** to return to the stack display.

Trace Mode

This section contains two programs, α ENTER and β ENTER, which together provide “trace mode” for the hp49g+/hp48gII using an external printer. To turn on “trace mode,” set flag –63 and activate User mode. To turn off “trace mode,” clear flag –63 or turn off User mode.

Techniques used in α ENTER and β ENTER

- **Vectored ENTER.** Setting flag –63 and activating User mode turns on vectored ENTER. When vectored ENTER is turned on and variable α ENTER exists, the command-line text is put on the stack as a string and α ENTER is evaluated. Then, if variable β ENTER exists, the command that triggered the command-line processing is put on the stack as a string and β ENTER is evaluated.

α ENTER program listing

| Program: | Comments: |
|-----------------------------|--|
| ❖ | |
| PR1 OBJ→ | Prints the command line text, then converts the string to an object and evaluates it. |
| ❖ | |
| ENTER ' α ENTER STO▶ | Stores the program in α ENTER. (Press ALPHA \rightarrow A to type α . You <i>must</i> use this name.) |

Checksum: # 127d

Bytes: 25.5

β ENTER program listing

| Program: | Comments: |
|----------------------------|--|
| ❖ | |
| PR1 DROP PRSTC | Prints the command that caused the processing, then drops it and prints the stack in compact form. |
| ❖ | |
| ENTER ' β ENTER STO▶ | Stores the program in β ENTER. (Press ALPHA \rightarrow B to type β . You <i>must</i> use this name.) |

Checksum: # 31902d

Bytes: 28

Inverse-Function Solver

This section describes the program *ROOTR*, which finds the value of x at which $f(x) = y$. You supply the variable name for the program that calculates $f(x)$, the value of y , and a guess for x (in case there are multiple solutions).

| | | | | |
|------------------------|----------------|--------------------|---|----------------|
| Level 3 | Level 2 | Level 1 | → | Level 1 |
| <i>'function name'</i> | y | x_{guess} | → | x |

Techniques used in ROOTR

- **Programmatic use of root-finder.** *ROOTR* executes *ROOT* to find the desired x -value.
- **Programs as arguments.** Although programs are commonly named and then executed by calling their names, programs can also be put on the stack and used as arguments to other programs.

ROOTR program listing

| Program: | Comments: |
|---|--|
| ⌘ | |
| → fname yvalue xguess | Creates local variables. |
| ⌘ xguess 'XTEMP' STO | Begins the defining procedure. Creates variable <i>XTEMP</i> (to be solved for). |
| ⌘ XTEMP fname yvalue - ⌘ 'XTEMP' xguess ROOT ⌘ | Enters program that evaluates $f(x) - y$. Enters name of unknown variable. Enters guess for <i>XTEMP</i> . Solves program for <i>XTEMP</i> . Ends the defining procedure. |
| Program: | Comments: |
| 'XTEMP' PURGE | Purges the temporary variable. |
| ⌘ | |
| ENTER [] ROOTR STO | Stores the program in <i>ROOTR</i> . |

Checksum: # 4708d

Bytes: 163

Example: Assume you often work with the expression $3.7x^3 + 4.5x^2 + 3.9x + 5$ and have created the program $X \rightarrow FX$ to calculate the value:

```
⌘ + ⌘ '3.7*x^3+4.5*x^2+3.9*x+5' ⌘
```

You can use *ROOTR* to calculate the *inverse* function.

Example: Find the value of x for which $X \rightarrow FX$ equals 599.5. Use a guess in the vicinity of 1.

Start by keying in $X \rightarrow FX$:

\rightarrow \leftarrow \rightarrow \rightarrow x SPC ' 3.7
 \times x \wedge 3 $+$ 4.5 \times x \wedge 2
 $+$ 3.9 \times x $+$ 5 ENTER

```

RAD RYZ DEC C~ 'X'
CHOME3
5:
4:
3:
2:
1: < -> x '3.7*X^3.+4.5
      *X^2.+3.9*X+5.' *
ROOTR|BENTE|ENTE EDAT | PIE | TPAR
  
```

Store the program in $X \rightarrow FX$, then enter the program name, the y -value 599.5, and the guess 1, and execute **ROOTR**:

' $X \rightarrow FX$ STOP
 ' VAR ENTER
 599.5 ENTER 1

```

RAD RYZ DEC C~ 'X'
CHOME3
7:
6:
5:
4:
3:
2:
1: 5.
%+%|ROOTR|BENTE|ENTE EDAT | PIE
  
```

Animating a Graphical Image

Program **WALK** shows a small person walking across the display. It animates this custom graphical image by incrementing the image position in a loop structure.

Techniques used in WALK

- **Custom graphical image.** (Note that the programmer compiles the full information content of the graphical image before writing the program by building the image *interactively* in the Graphics environment and then returning it to the command line.)
- **FOR...STEP (definite loop).** **WALK** uses this loop to animate the graphical image. The ending value for the loop is **MAXR**. Since the counter value cannot exceed **MAXR**, the loop executes indefinitely.

WALK program listing

| Program: | Comments: |
|--|---|
| <pre> * GROB 9 15 E300 140015001C001400E300 8000C110AA0094009000 4100220014102800 </pre> | <p>Puts the graphical image of the walker in the command line. (Note that the hexadecimal portion of the graphics object is a continuous integer E300...2800. The linebreaks do <i>not</i> represent spaces.)</p> |
| <pre> → walk </pre> | <p>Creates local variable <i>walk</i> containing the graphics object.</p> |
| <pre> * ERASE (# 0d # 0d) PVIEW </pre> | <p>Clears <i>PICT</i>, then displays it.</p> |

| Program: | Comments: |
|---------------------------------------|---|
| (# 0d # 25d) PICT OVER walk GXOR | Puts the first position on the stack and turns on the first image. This readies the stack and <i>PICT</i> for the loop. |
| 5 MAXR FOR i | Starts the loop to generate horizontal coordinates indefinitely. |
| i 131 MOD R+B | Computes the horizontal coordinate for the next image. |
| # 25d 2 →LIST | Specifies a fixed vertical coordinate. Puts the two coordinates in a list. |
| PICT OVER walk GXOR | Displays the new image, leaving its coordinates on the stack. |
| PICT ROT walk GXOR | Turns off the old image, removing its coordinates from the stack. |
| 0.2 WAIT 5 STEP | Increments the horizontal coordinate by 5. |
| ⌘ ⌘ | |
| ENTER ' WALK STO▶ | Stores the program in <i>WALK</i> . |

Checksum: # 28684d

Bytes: 250.0

Example: Send the small person out for a walk.

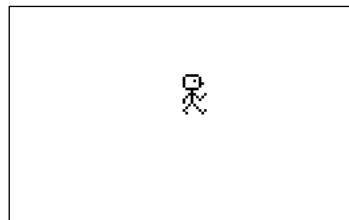

Press CANCEL when you think the walker's tired.

Full Command and Function Reference

Introduction

This chapter details the hp49g+/hp48gII commands and functions.

These listings include the following information:

- a brief definition of what the command or function does
- additional information about how it works and how to use it
- the key to press to gain access to it
- any flags that may affect how it works
- a stack diagram showing the arguments it requires (if any)
- related commands or functions

Computer Algebra System Commands and Functions

CAS-specific commands and functions are included in this chapter with a description of what the item does. For more detailed information on CAS-specific items, see the listing for each CAS item in the next chapter. For example, the CAS command “ABCUV” is included in this chapter, but the only description given is:

CAS: From polynomials a , b and constant c give polynomials u and v such that $au+bv=c$.

The CAS: indicates that this is a computer algebra system item and that the next chapter contains a listing giving more information on the entry.

How to Access Commands and Functions

Many of the commands and functions in this reference are not located on the hp49g+/hp48gII keyboard and are accessed by pressing $\boxed{\rightarrow}$ $\boxed{_}$ $\boxed{\text{CAT}}$. This is the right-shifted function of the $\boxed{\text{SYMB}}$ key, which is the fourth key from the left on the fourth row of keys from the top. Once accessed, the function or command’s name is found by pressing the $\boxed{\text{ALPHA}}$ key and then using the letter keys to spell out the function or command’s name. Usually, pressing the first letter of the command will move the catalog list close enough to the function to use the $\boxed{\downarrow}$ key to find the function. For functions or commands (or symbols) that are located on the hp49g+/hp48gII keyboard as shifted functions of other keys (such as $\boxed{\rightarrow}$ $\boxed{_}$ $\boxed{\text{CAT}}$ above), the proper shift key is shown followed by a font symbol indicating the function, command or symbol written above the key.

In some cases, access is shown with two keys with an ampersand (&) in between, such as $\boxed{\leftarrow}$ & $\boxed{\text{MODE}}$. This notation means that you must press the first key and hold it down while then pressing the second key at the same time.

The next few pages explain how to read the stack diagrams in the command reference, how commands are alphabetized, and the meaning of command classifications at the upper right corner of each stack diagram.

How to Read Stack Diagrams

Each entry in the command reference includes a *stack diagram*. This is a table showing the *arguments* that the command, function, or analytic function takes from the stack and the *results* that it returns to the stack. The “ \rightarrow ” character (pronounced “to” as in “to list” for \rightarrow List) in the table separates the arguments from the results. The stack diagram for a command may contain more than one “argument \rightarrow result” line, reflecting all possible combinations of arguments and results for that command.

Consider this example:

ACOS

Arc Cosine Analytic Function: Returns the value of the angle having the given cosine.

| Level 1 | → | Level 1 |
|-----------------|---|-----------------------|
| z | → | arc cos z |
| ' <i>symb</i> ' | → | 'ACOS(<i>symb</i>)' |

This diagram indicates that the *analytic function* ACOS (*Arc Cosine*) takes a single argument from level 1 and returns one result (to level 1). ACOS can take either a real or complex number or an algebraic object as its argument. In the first case, it returns the numeric arccosine; in the second, it returns the symbolic arccosine expression of the argument.

Some commands affect a calculator state — a mode, a reserved variable, a flag, or a display — without taking any arguments from the stack or returning any results to the stack. No stack diagrams are shown for these commands.

Parallel Processing with Lists

This feature is discussed in greater detail in Appendix G.

As a rule-of-thumb, a command can use parallel list processing if all the following are true:

- The command checks for valid argument types. Commands that apply to all object types, such as DUP, SWAP, ROT, and so forth, do not use parallel list processing.
- The command takes exactly one, two, three, four, or five arguments, none of which may itself be a list. Commands, such as →LIST, that have an indefinite number of arguments do not use parallel list processing.
- The command is not a programming branch command (IF, FOR, CASE, NEXT, and so forth).

There are also a few commands (PURGE, DELKEYS, SF and FS? are examples) that have list processing capability built into their definitions, and so do not also use the parallel list processing feature.

How Commands Are Alphabetized

Commands appear in alphabetical order. Command names that contain special (non-alphabetic) characters are organized as follows:

- For commands that contain *both* special and alphabetic characters:
 - A special character at the *start* of a command name is *ignored*. Therefore, the command %CH follows the command CF and precedes the command CHOOSE.
 - A special character *within* or at the *end* of a command name is considered to follow “Z” at the end of the alphabet. Therefore, the command R→B follows the command RSWP and precedes the command R→C. The only exception would be the “Σ” character which, when not the first character in the name, is alphabetized as if it were the string “SIGMA”. An example is “NΣ”, which falls between NOVAL and NSUB.
- Commands that contain *only* special characters appear at the end of the dictionary.

Classification of Operations

The command dictionary contains hp48gII/hp49g+ *commands*, *functions*, and *analytic functions*. Commands are calculator operations that can be executed from a program. Functions are commands that can be included in algebraic objects. Analytic functions are functions for which hp48gII/hp49g+ provides an inverse and a derivative.

The definitions of the abbreviations used for argument and result objects are contained in the following table, “Terms Used in Stack Diagrams.” Often, descriptive subscripts are added to convey more information.

Terms Used in Stack Diagrams

| Term | Description |
|---------------------------|---|
| <i>arg</i> | Argument. |
| [<i>array</i>] | Real or complex vector or matrix. |
| [<i>C-array</i>] | Complex vector or matrix. |
| date | Date in form MM.DDYyyy or DD.MMYyyy. |
| { <i>dim</i> } | List of one or two array dimensions (real numbers). |
| 'global' | Global name. |
| <i>grob</i> | Graphics object. |
| <i>HMS</i> | A real-number time or angle in hours-minutes-seconds format. |
| { <i>list</i> } | List of objects. |
| <i>local</i> | Local name. |
| [[<i>matrix</i>]] | Real or complex matrix. |
| <i>n</i> or <i>m</i> | Positive integer real number (rounded if noninteger) |
| :Nport: | Backup identifier. |
| :Nport: Nlibrary | Library identifier. |
| # <i>n</i> | Binary integer. |
| { # <i>n</i> # <i>m</i> } | Pixel coordinates. (Uses binary integers.) |
| 'name' | Global or local name. |
| <i>obj</i> | Any object. |
| <i>PICT</i> | Current graphics object. |
| « <i>program</i> » | Program. |
| [<i>R-array</i>] | Real vector or matrix. |
| "string" | Character string. |
| 'symb' | Expression, equation, or name treated as an algebraic. |
| <i>T/F</i> | Test result used as an argument: zero (false) or non-zero (true) real number. |
| <i>0/1</i> | Test result <i>returned</i> by a command: zero (false) or one (true). |
| <i>time</i> | Time in form HH.MMSSs. |
| [<i>vector</i>] | Real or complex vector. |
| <i>x</i> or <i>y</i> | Real number. |
| <i>x_unit</i> | Unit object, or a real number treated as a dimensionless object. |
| (<i>x,y</i>) | Complex number in rectangular form, or user-unit coordinate. |
| <i>z</i> | Real or complex number. |

ABCUV

CAS: From polynomials a , b and constant c give polynomials u and v such that $au + bv = c$.

ABS

Type: Function

Description: Absolute Value Function: Returns the absolute value of its argument.

ABS has a derivative (SIGN) but not an inverse.

In the case of an array, ABS returns the Frobenius (Euclidean) norm of the array, defined as the square root of the sum of the squares of the absolute values of all n elements. That is:

$$\sqrt{\sum_{i=1}^n |z_i|^2}$$

Access:  ABS (ABS is the left-shift of the  key).

Flags: Numerical Results (-3)

Input/Output:

| Level 1/Argument 1 | | Level 1/Item 1 |
|--------------------|---|--------------------|
| x | → | $ x $ |
| (x,y) | → | $\sqrt{x^2 + y^2}$ |
| x_unit | → | $ x _unit$ |
| $[array]$ | → | $ array $ |
| ' $symb$ ' | → | 'ABS($symb$)' |

See also: NEG, SIGN

ACK

Type: Command

Description: Acknowledge Alarm Command: Acknowledges the oldest past-due alarm.

ACK clears the alert annunciator if there are both no other past-due alarms and no other active alert sources (such as a low battery condition).

ACK has no effect on control alarms. Control alarms that come due are automatically acknowledged *and* saved in the system alarm list.

Access:  TIME TOOLS ALRM ACK (TIME is the right-shift of the  key).

Flags: Repeat Alarms Not Rescheduled (-43), Acknowledged Alarms Saved (-44)

Input/Output: None

See also: ACKALL

ACKALL

Type: Command

Description: Acknowledge All Alarms Command: Acknowledges all past-due alarms.

ACKALL clears the alert annunciator if there are no other active alert sources (such as a low battery condition).

ACKALL has no effect on control alarms. Control alarms that come due are automatically acknowledged *and* saved in the system alarm list.

Access:  TIME TOOLS ALRM ACKALL (TIME is the right-shift of the  key).

Flags: Repeat Alarms Not Rescheduled (-43), Acknowledged Alarms Saved (-44)

Input/Output: None

See also: ACK

ACOS

Type: Analytic Function

Description: Arc Cosine Analytic Function: Returns the value of the angle having the given cosine.

For a real argument x in the domain $-1 \leq x \leq 1$, the result ranges from 0 to 180 degrees (0 to π radians; 0 to 200 grads).

A real argument outside of this domain is converted to a complex argument, $z = x + 0i$, and the result is complex.

The inverse of COS is a *relation*, not a function, since COS sends more than one argument to the same result. The inverse relation for COS is expressed by ISOL as the *general solution*

$$s1*ACOS(Z)+2*\pi*n1$$

The function ACOS is the inverse of a *part* of COS, a part defined by restricting the domain of COS such that:

- each argument is sent to a distinct result, and
- each possible result is achieved.

The points in this restricted domain of COS are called the *principal values* of the inverse relation. ACOS in its entirety is called the *principal branch* of the inverse relation, and the points sent by ACOS to the boundary of the restricted domain of COS form the *branch cuts* of ACOS.

The principal branch used by the hp49g+/hp48gII for ACOS was chosen because it is analytic in the regions where the arguments of the *real-valued* inverse function are defined. The branch cut for the complex-valued arc cosine function occurs where the corresponding real-valued function is undefined. The principal branch also preserves most of the important symmetries.

The graphs below show the domain and range of ACOS. The graph of the domain shows where the branch cuts occur: the heavy solid line marks one side of a cut, while the feathered lines mark the other side of a cut. The graph of the range shows where each side of each cut is mapped under the function.

These graphs show the inverse relation $s1*ACOS(Z)+2*\pi*n1$ for the case $s1=1$ and $n1 = 0$. For other values of $s1$ and $n1$, the vertical band in the lower graph is translated to the right or to the left. Taken together, the bands cover the whole complex plane, which is the domain of COS.

View these graphs with domain and range reversed to see how the domain of COS is restricted to make an inverse *function* possible. Consider the vertical band in the lower graph as the restricted domain $Z = (x, y)$. COS sends this domain onto the whole complex plane in the range $W = (u, v) = \text{COS}(x, y)$ in the upper graph.

Access:  ACOS (ACOS is the left-shift of the  key).

Flags: Principal Solution (-1), Numerical Results (-3), Angle Mode (-17, -18)

Input/Output:

| Level 1/Argument 1 | | Level 1/Item 1 |
|--------------------|---|------------------|
| z | → | $\text{acos } z$ |
| 'symb' | → | 'ACOS(symb)' |

See also: ASIN, ATAN, COS, ISOL

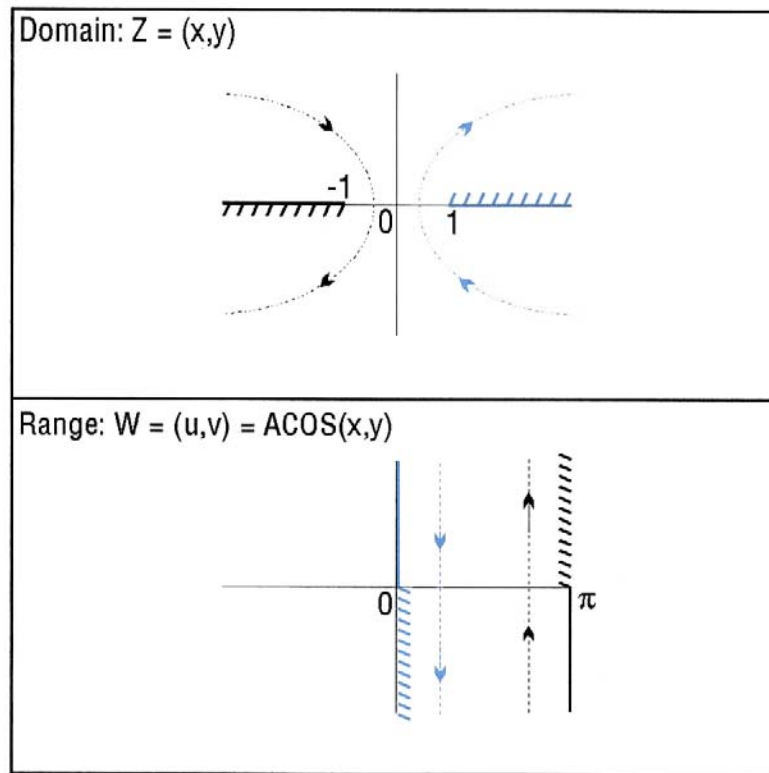

Branch Cuts for ACOS(Z)

ACOS2S

CAS: Transform expressions replacing $\text{acos}(x)$ with $\pi/2 - \text{asin}(x)$.

ACOSH

Type: Analytic Function

Description: Inverse Hyperbolic Cosine Analytic Function: Returns the inverse hyperbolic cosine of the argument.

For real arguments $x < 1$, ACOSH returns the complex result obtained for the argument $(x, 0)$. The inverse of ACOSH is a *relation*, not a function, since COSH sends more than one argument to the same result. The inverse relation for COSH is expressed by ISOL as the *general solution*:

$$s1 * \text{ACOSH}(Z) + 2 * \pi * i * n1$$

The function ACOSH is the inverse of a *part* of COSH, a part defined by restricting the domain of COSH such that:

- each argument is sent to a distinct result, and
- each possible result is achieved.

The points in this restricted domain of COSH are called the *principal values* of the inverse relation. ACOSH in its entirety is called the *principal branch* of the inverse relation, and the points sent by ACOSH to the boundary of the restricted domain of COSH form the *branch cuts* of ACOSH.

The principal branch used by the hp49g+/hp48gII for ACOSH was chosen because it is analytic in the regions where the arguments of the *real-valued* inverse function are defined. The branch cut for the complex-valued hyperbolic arc cosine function occurs where the corresponding real-valued function is undefined. The principal branch also preserves most of the important symmetries.

The graphs below show the domain and range of ACOSH. The graph of the domain shows where the branch cut occurs: the heavy solid line marks one side of the cut, while the feathered

lines mark the other side of the cut. The graph of the range shows where each side of the cut is mapped under the function.

These graphs show the inverse relation $s1 \cdot \text{ACOSH}(Z) + 2 \cdot \pi \cdot i \cdot n1$ for the case $s1 = 1$ and $n1 = 0$. For other values of $s1$ and $n1$, the horizontal half-band in the lower graph is rotated to the left and translated up and down. Taken together, the bands cover the whole complex plane, which is the domain of COSH.

View these graphs with domain and range reversed to see how the domain of COSH is restricted to make an inverse *function* possible. Consider the horizontal half-band in the lower graph as the restricted domain $Z = (x, y)$. COSH sends this domain onto the whole complex plane in the range $W = (u, v) = \text{COSH}(x, y)$ in the upper graph.

Access:  **TRIG** HYPERBOLIC ACOSH (**TRIG** is the right-shift of the **8** key).

Flags: Principal Solution (-1), Numerical Results (-3)

Input/Output:

| Level 1/Argument 1 | | Level 1/Item 1 |
|--------------------|---|--------------------------|
| z | → | $\text{acosh } z$ |
| ' <i>symb</i> ' | → | ' $\text{ACOSH}(symb)$ ' |

See also: ASINH, ATANH, COSH, ISOL

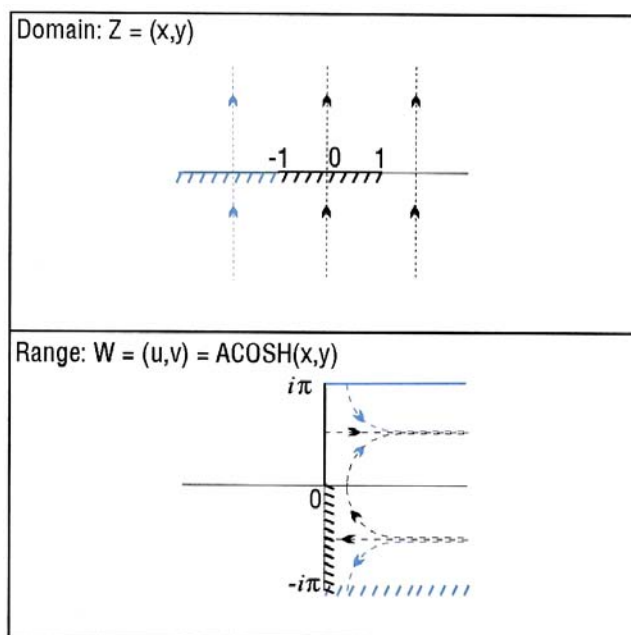

Branch Cut for ACOSH(Z)

ADD

Type: Command

Description: Add List Command: Adds corresponding elements of two lists or adds a number to each of the elements of a list.

ADD executes the + command once for each of the elements in the list. If two lists are the arguments, they must have the same number of elements as ADD will execute the + command once for each corresponding pair of elements. If one argument is a non-list object, ADD will attempt to execute the + command using the non-list object and each element of the list argument, returning the result to the corresponding position in the result. (See the + command entry to see the object combinations that are defined.) If an undefined addition is encountered, a Bad Argument Type error results.

Access: \leftarrow MTH LIST ADD (\leftarrow MTH is the left-shift of the SYMB key).

Flags: Binary Integer Wordsize (-5 through -10)

Input/Output:

| Level 2/Argument 1 | Level 1/Argument 2 | | Level 1/Item 1 |
|-------------------------|-------------------------|---|----------------------------|
| { list ₁ } | { list ₂ } | → | { list _{result} } |
| { list } | obj _{non-list} | → | { list _{result} } |
| obj _{non-list} | { list } | → | { list _{result} } |

See also: +, ΔLIST, ΠLIST, ΣLIST

ADDTMOD

CAS: Add two expressions or values, modulo the current modulus.

ADDTOREAL

CAS: Add names to list of variables treated as real when Complex mode is set.

ALGB

CAS: Display a menu or list of CAS algebraic operations.

ALOG

Type: Analytic Function

Description: Common Antilogarithm Analytic Function: Returns the common antilogarithm; that is, 10 raised to the given power.

For complex arguments: $10^{(x,y)} = e^{cx} \cos cy + i e^{cx} \sin cy$ where $c = \ln 10$.

Access: \leftarrow 10^x (\leftarrow 10^x is the left-shift of the EEX key).

Flags: Numerical Results (-3)

Input/Output:

| Level 1/Argument 1 | | Level 1/Item 1 |
|--------------------|---|-----------------|
| \tilde{x} | → | 10 ^x |
| 'symp' | → | 'ALOG(symp)' |

See also: EXP, LN, LOG

AMORT

Type: Command

Description: Amortize Command: Amortizes a loan or investment based upon the current amortization settings.

Values must be stored in the TVM variables (I%YR, PV, PMT, and PYR). The number of payments *n* is taken from the input together with flag -14.

Access: \leftarrow & S.SLV TVM AMORT (\leftarrow S.SLV is the left-shift of the 7 key).

Flags: Financial Payment Mode (-14)

Input/Output:

| Level 1/Argument 1 | | Level 3/Item 1 | Level 2/Item 2 | Level 1/Item 3 |
|--------------------|---|------------------|-----------------|----------------|
| <i>n</i> | → | <i>principal</i> | <i>interest</i> | <i>balance</i> |

See also: TVM, TVMBEG, TVMEND, TVMROOT

AND

Type: Function

Description: And Function: Returns the logical AND of two arguments.

When the arguments are binary integers or strings, AND does a bit-by-bit (base 2) logical comparison.

- An argument that is a binary integer is treated as a sequence of bits as long as the current wordsize. Each bit in the result is determined by comparing the corresponding bits (*bit₁* and *bit₂*) in the two arguments as shown in the following table.

| <i>bit₁</i> | <i>bit₂</i> | <i>bit₁ AND bit₂</i> |
|------------------------|------------------------|--|
| 0 | 0 | 0 |
| 0 | 1 | 0 |
| 1 | 0 | 0 |
| 1 | 1 | 1 |

- An argument that is a string is treated as a sequence of bits, using 8 bits per character (that is, using the binary version of the character code). The two string arguments must have the same number of characters.

When the arguments are real numbers or symbolics, AND simply does a true/false test. The result is 1 (true) if both arguments are non-zero; it is 0 (false) if either or both arguments are zero. This test is usually done to compare two test results.

If either or both of the arguments are algebraic expressions, then the result is an algebraic of the form *symp₁ AND symp₂*. Execute →NUM (or set flag -3 before executing AND) to produce a numeric result from the algebraic result.

Access: BASE LOGIC AND (is the right-shift of the key).

Flags: Numerical Results (-3), Binary Integer Wordsize (-5 through -10)

Input/Output:

| Level 2/Argument 1 | Level 1/Argument 2 | | Level 1/Item 1 |
|-------------------------------|-------------------------------|---|--|
| # <i>n₁</i> | # <i>n₂</i> | → | # <i>n₃</i> |
| " <i>string₁</i> " | " <i>string₂</i> " | → | " <i>string₃</i> " |
| <i>T/F₁</i> | <i>T/F₂</i> | → | 0/1 |
| <i>T/F</i> | ' <i>symp</i> ' | → | ' <i>T/F AND symp</i> ' |
| ' <i>symp</i> ' | <i>T/F</i> | → | ' <i>symp AND T/F</i> ' |
| ' <i>symp₁</i> ' | ' <i>symp₂</i> ' | → | ' <i>symp₁ AND symp₂</i> ' |

See also: NOT, OR, XOR

ANIMATE

Type: Command

Description: Animate Command: Displays graphic objects in sequence.

ANIMATE displays a series of graphics objects (or variables containing them) one after the other. You can use a list to specify the area of the screen you want to animate (pixel coordinates #X and #Y), the number of seconds before the next grob is displayed (*delay*), and the number of times the sequence is run (*rep*). If *rep* is set to 0, the sequence is played one million times, or until you press CANCEL (the key).

If you use a list on level 1, all parameters must be present.

The animation displays PICT while displaying the grobs. The grobs and the animate parameters are left on the stack.

Access: \leftarrow PRG \leftarrow GROB \leftarrow ANIMATE (\leftarrow PRG is the left-shift of the \leftarrow EVAL key).

Input/Output:

| Ln+1.../A1 | L1/An+1 | | L1/I1 |
|-----------------------|---|---------------|-------------------|
| $grob_n \dots grob_1$ | n_{grob} | \rightarrow | <i>same stack</i> |
| $grob_n \dots grob_1$ | $\{ n \{ \#X\#Y \} \text{ delay } \}$ $rep \}$ | \rightarrow | <i>same stack</i> |

L = Level, A = Argument, I = item

See also: BLANK, \rightarrow GROB

ANS

Type: Command

Description: Recalls the n th answer from history (algebraic mode only), where n is an integer. In RPN mode, it performs the LASTARG command.

Access: \leftarrow ANS (\leftarrow ANS is the left-shift of the \leftarrow ENTER key).

Input/Output:

| Level 1/Argument 1 | | Level 1/Item 1 |
|--------------------|---------------|----------------|
| n | \rightarrow | obj_n |

See also: LAST, LASTARG

APPLY

Type: Function

Description: Apply to Arguments Function: Creates an expression from the specified function name and arguments.

A user-defined function f that checks its arguments for special cases often can't determine whether a symbolic argument x represents one of the special cases. The function f can use APPLY to create a new expression $f(x)$. If the user now evaluates $f(x)$, x is evaluated before f , so the argument to f will be the result obtained by evaluating x .

When evaluated in an algebraic expression, APPLY evaluates the arguments (to resolve local names in user-defined functions) before creating the new object.

Access: \leftarrow CAT APPLY

Input/Output:

| Level 2/Argument 1 | Level 1/Argument 2 | | Level 1/Item 1 |
|-----------------------------|--------------------|---------------|--|
| $\{ symb_1 \dots symb_n \}$ | 'name' | \rightarrow | 'name(symb ₁ ... symb _n)' |

See also: QUOTE, |

ARC

Type: Command

Description: Draw Arc Command: Draws an arc in PICT counterclockwise from $x_{\theta 1}$ to $x_{\theta 2}$, with its center at the coordinate specified in argument 1 or level 4 and its radius specified in argument 2 or level 3.

ARC always draws an arc of constant radius in pixels, even when the radius and center are specified in user-units, regardless of the relative scales in user-units of the x - and y -axes. With user-unit arguments, the arc starts at the pixel specified by $(x, y) + (a, b)$, where (a, b) is the rectangular conversion of the polar coordinate $(x_{radius}, x_{\theta 1})$. The resultant distance in pixels from the starting point to the centre pixel is used as the actual radius, r' . The arc stops at the pixel specified by $(r', x_{\theta 2})$.

If $x_{\theta 1} = x_{\theta 2}$, ARC plots one point. If $|x_{\theta 1} - x_{\theta 2}| > 360$ degrees, 2π radians, or 400 grads, ARC draws a complete circle.

Access: \leftarrow PRG \rightarrow NXT PICT ARC (\leftarrow PRG is the left-shift of the \rightarrow EVAL key).

Flags: Angle Mode (-17 and -18). The setting of flags -17 and -18 determine the interpretation of $x_{\theta 1}$ and $x_{\theta 2}$ (degrees, radians, or grads).

Input/Output:

| Level 4/Argument 1 | Level 3/Argument 2 | Level 2/Argument 3 | Level 1/Argument 4 | Level 1/Item 1 |
|--------------------|-----------------------|--------------------|--------------------|----------------|
| (x, y) | x_{radius} | $x_{\theta 1}$ | $x_{\theta 2}$ | \rightarrow |
| $\{ \#n, \#m \}$ | $\#n_{\text{radius}}$ | $x_{\theta 1}$ | $x_{\theta 2}$ | \rightarrow |

See also: BOX, LINE, TLINE

ARCHIVE

Type: Command

Description: Archive HOME Command: Creates a backup copy of the HOME directory (that is, all variables), the user-key assignments, and the alarm catalog in the specified backup object ($:n_{\text{port}}:name$) in RAM or flash ROM.

The specified port number can be 0 through 3, where 3 is the SD card. (This only applies to the hp49g+.) An error will result if there is not enough memory in the specified port to copy the HOME directory.

If the backup object is “:IO:name”, then the copied directory is transmitted in binary via Kermit protocol through the current I/O port to the specified filename.

To save flag settings, execute RCLF and store the resulting list in a variable.

Access: \leftarrow PRG MEMORY \rightarrow NXT ARCHIVE (\leftarrow PRG is the left-shift of the \rightarrow EVAL key).

Flags: I/O Device (-33), I/O Messages (-39) if the argument is “:IO:name”.

Input/Output:

| Level 1/Argument 1 | Level 1/Item 1 |
|--------------------------|----------------|
| $:n_{\text{port}} :name$ | \rightarrow |
| $:IO :name$ | \rightarrow |

See also: RESTORE

ARG

Type: Function

Description: Argument Function: Returns the (real) polar angle θ of a complex number (x, y) .

The polar angle θ is equal to:

- $\text{atan } y/x$ for $x \geq 0$
- $\text{atan } y/x + \pi \text{ sign } y$ for $x < 0$, Radians mode
- $\text{atan } y/x + 180 \text{ sign } y$ for $x < 0$, Degrees mode
- $\text{atan } y/x + 200 \text{ sign } y$ for $x < 0$, Grads mode

A real argument x is treated as the complex argument $(x, 0)$.

Access: \rightarrow ARG (\rightarrow ARG is the right-shift of the \div key).

Flags: Angle mode (-17, -18)

Input/Output:

| Level 1/Argument 1 | | Level 1/Item 1 |
|--------------------|---|----------------------|
| (x, y) | → | θ |
| ' <i>symb</i> ' | → | ' <i>ARG(symb)</i> ' |

See also: ATAN

ARIT



CAS: Display a menu or list showing CAS submenus for arithmetical operations

ARRY→

Type: Command

Description: Array to Stack Command: Takes an array and returns its elements as separate real or complex numbers. Also returns a list of the dimensions of the array.

If the argument is an n -element vector, the first element is returned to level $n + 1$ (not level $nm + 1$), and the m th element to level 2.

Access:   ARRY→

Input/Output:

| Level 1/Argument 1 | | Lnm+1/A1 ... L2/Anm | Level1/Itemnm+1 |
|---------------------|---|---------------------------------------|-------------------------------------|
| [<i>vector</i>] | → | $\tilde{x}_1 \dots \tilde{x}_n$ | { n_{element} } |
| [[<i>matrix</i>]] | → | $\tilde{x}_{11} \dots \tilde{x}_{nm}$ | { $n_{\text{row}} m_{\text{col}}$ } |

L = Level; I = item

See also: →ARRY, DTAG, EQ→, LIST→, OBJ→, STR→

→ARRY

Type: Command

Description: Stack to Array Command: Returns a vector of n real or complex elements or a matrix of $n \times m$ real or complex elements.

The elements of the result array should be entered in row order. If one or more of the elements is a complex number, the result array will be complex.

Access:   TYPE →ARRY ( is the left-shift of the  key).

Input/Output:

| Levelnm+1/Argument1 ... Level2/Argumentnm | Level1/Argumentnm+1 | | Level1/Item1 |
|---|--------------------------------------|---|---------------------|
| $\tilde{x}_1 \dots \tilde{x}_n$ | n_{element} | → | [<i>vector</i>] |
| $\tilde{x}_{11} \dots \tilde{x}_{nm}$ | { $n_{\text{row}}, m_{\text{col}}$ } | → | [[<i>matrix</i>]] |

See also: ARRY→, LIST→, →LIST, OBJ→, STR→, →TAG, →UNIT

ASIN

Type: Analytic Function

Description: Arc Sine Analytic Function: Returns the value of the angle having the given sine.

For a real argument x in the domain $-1 \leq x \leq 1$, the result ranges from -90 to $+90$ degrees ($-\pi/2$ to $+\pi/2$ radians; -100 to $+100$ grads).

A real argument outside of this domain is converted to a complex argument $\tilde{x} = x + 0i$, and the result is complex.

The inverse of SIN is a *relation*, not a function, since SIN sends more than one argument to the same result. The inverse relation for SIN is expressed by ISOL as the *general solution*:

$$\text{ASIN}(Z) * (-1)^{n1} + \pi * n1$$

The function ASIN is the inverse of a *part* of SIN, a part defined by restricting the domain of SIN such that:

- each argument is sent to a distinct result, and
- each possible result is achieved.

The points in this restricted domain of SIN are called the *principal values* of the inverse relation. ASIN in its entirety is called the *principal branch* of the inverse relation, and the points sent by ASIN to the boundary of the restricted domain of SIN form the *branch cuts* of ASIN.

The principal branch used by the hp49g+/hp48gII for ASIN was chosen because it is analytic in the regions where the arguments of the *real-valued* inverse function are defined. The branch cut for the complex-valued arc sine function occurs where the corresponding real-valued function is undefined. The principal branch also preserves most of the important symmetries.

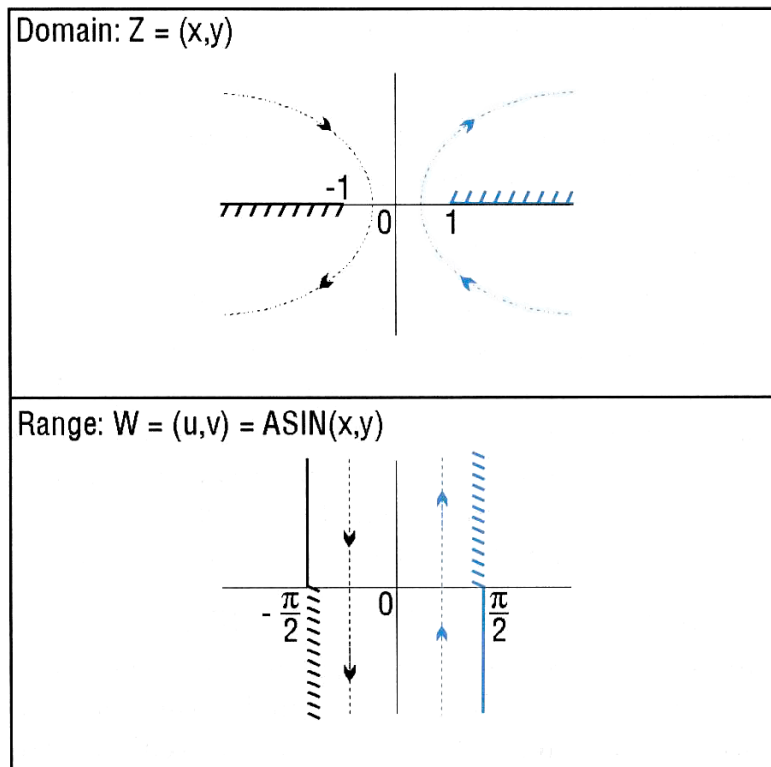

The graphs below show the domain and range of ASIN. The graph of the domain shows where the branch cuts occur: the heavy solid line marks one side of a cut, while the feathered lines mark the other side of a cut. The graph of the range shows where each side of each cut is mapped under the function. These graphs show the inverse relation $\text{ASIN}(Z) * (-1)^{n1} + \pi * n1$ for the case $n1=0$. For other values of $n1$, the vertical band in the lower graph is translated to the right (for $n1$ positive) or to the left (for $n1$ negative). Taken together, the bands cover the whole complex plane, which is the domain of SIN.

View these graphs with domain and range reversed to see how the domain of SIN is restricted to make an inverse *function* possible. Consider the vertical band in the lower graph as the restricted domain $Z = (x, y)$. SIN sends this domain onto the whole complex plane in the range $W = (u, v) = \text{SIN}(x, y)$ in the upper graph.



Branch Cuts for ASIN(Z)

Access:  ASIN

( is the left-shift of the  key).

Flags: Principal Solution (-1), Numerical Results (-3), Angle Mode (-17, -18)

Input/Output:

| Level 1/Argument 1 | | Level 1/Item 1 |
|--------------------|---|-------------------------|
| z | → | $\text{asin } z$ |
| ' <i>symb</i> ' | → | ' $\text{ASIN}(symb)$ ' |

See also: ACOS, ATAN, ISOL, SIN

ASIN2C

CAS: Transform expressions replacing $\text{asin}(x)$ with $\pi/2 - \text{acos}(x)$.

ASIN2T

CAS: Transform expressions replacing $\text{asin}(x)$ with $\text{atan}(x/\sqrt{1-x^2})$

ASINH

Type: Analytic Function

Description: Arc Hyperbolic Sine Analytic Function: Returns the inverse hyperbolic sine of the argument.

The inverse of SINH is a *relation*, not a function, since SINH sends more than one argument to the same result. The inverse relation for SINH is expressed by ISOL as the *general solution*:

$$\text{ASINH}(Z) * (-1)^{n1 + \pi * i * n1}$$

The function ASINH is the inverse of a *part* of SINH, a part defined by restricting the domain of SINH such that:

- each argument is sent to a distinct result, and
- each possible result is achieved.

The points in this restricted domain of SINH are called the *principal values* of the inverse relation. ASINH in its entirety is called the *principal branch* of the inverse relation, and the points sent by ASINH to the boundary of the restricted domain of SINH form the *branch cuts* of ASINH.

The principal branch used by the hp49g+/hp48gII for ASINH was chosen because it is analytic in the regions where the arguments of the *real-valued* function are defined. The branch cut for the complex-valued ASINH function occurs where the corresponding real-valued function is undefined. The principal branch also preserves most of the important symmetries.

The graph for ASINH can be found from the graph for ASIN (see ASIN) and the relationship $\text{asinh } z = -i \text{asin } iz$.

Access:  TRIG HYPERBOLIC ASINH (—TRIG is the right-shift of the  key).

Flags: Principal Solution (-1), Numerical Results (-3)

Input/Output:

| Level 1/Argument 1 | | Level 1/Item 1 |
|--------------------|---|--------------------------|
| z | → | $\text{asinh } z$ |
| ' <i>symb</i> ' | → | ' $\text{ASINH}(symb)$ ' |

See also: ACOSH, ATANH, ISOL, SINH

ASN

Type: Command

Description: Assign Command: Defines a single key on the user keyboard by assigning the given object to the key x_{key} , which is specified as *rc.pf*.

The argument x_{key} is a real number *rc.pf* specifying the key by its row number *r*, column number *c*, shift plane *p* and shift-and-hold flag *f*. A value of $f=0$ represents a normal shifted key assignment (where the shift is released prior to pressing the key); whereby $f=1$ corresponds to a shift-and-

hold key assignment indicated by “&” in the table below (where the shift is held while pressing the key). The legal values for *p* and *f* are as follows:

| Value of .pf | Shift | Value of .pf | Shift |
|--------------|--------------------------------|--------------|-------------|
| .00 or .10 | Unshifted [key] | | |
| .20 | ⇧ (left-shifted) [key] | .21 | ⇧ & [key] |
| .30 | ⇨ (right-shifted) [key] | .31 | ⇨ & [key] |
| .40 | ⌘ (alpha-shifted) [key] | .41 | ⌘ & [key] |
| .50 | ⌘ ⇧ (alpha left-shifted) [key] | .51 | ⌘ ⇧ & [key] |
| .60 | ⌘ ⇨ (alpha right-shifted) | .61 | ⌘ ⇨ & [key] |

Once ASN has been executed, pressing a given key in User or 1-User mode executes the user-assigned object. The user key assignment remains in effect until the assignment is altered by ASN, STOKEYS, or DELKEYS. Keys without user assignments maintain their standard definitions.

If the argument *obj* is the name SKEY, then the specified key is restored to its *standard key* assignment on the user keyboard. This is meaningful only when all standard key assignments had been suppressed (for the user keyboard) by the command S DELKEYS (see DELKEYS).

To make multiple key assignments simultaneously, use STOKEYS. To delete key assignments, use DELKEYS.

Be careful not to reassign or suppress the keys necessary to cancel User mode. If this happens, exit User mode by doing a system halt (“warm start”): press and hold **ON** and **F3** simultaneously, releasing **F3** first. This cancels User mode.

Access: ⇨ **_CAT** ASN OR ⇧ & **(MODE)** KEYS ASN

Flags: User-Mode Lock (-61) and User Mode (-62) affect the status of the user keyboard

Input/Output:

| Level 2/Argument 1 | Level 1/Argument 2 | Level 1/Item 1 |
|--------------------|------------------------|----------------|
| <i>obj</i> | <i>x_{key}</i> | → |
| 'SKEY' | <i>x_{key}</i> | → |

See also: DELKEYS, RCLKEYS, STOKEYS

ASR

Type: Command

Description: Arithmetic Shift Right Command: Shifts a binary integer one bit to the right, except for the most significant bit, which is maintained.

The most significant bit is preserved while the remaining (*wordsize* - 1) bits are shifted right one bit. The second-most significant bit is replaced with a zero. The least significant bit is shifted out and lost.

An arithmetic shift is useful for preserving the sign bit of a binary integer that will be shifted. Although the hp49g+/hp48gII makes no special provision for signed binary integers, you can still *interpret* a number as a signed quantity.

Access: $\boxed{\rightarrow}$ $\boxed{\text{BASE}}$ $\boxed{\text{NXT}}$ BIT ASR ($\boxed{\text{BASE}}$ is the right-shift of the $\boxed{3}$ key).

Flags: Binary Integer Wordsize (-5 through -10), Binary Integer Base (-11, -12)

Input/Output:

| Level 1/Argument 1 | Level 1/Item 1 |
|--------------------|-----------------------|
| $\#n_1$ | \rightarrow $\#n_2$ |

See also: SL, SLB, SR, SRB

ASSUME

CAS: Place assumptions on variables treated by CAS as real when Complex mode is set.

ATAN

Type: Analytic Function

Description: Arc Tangent Analytic Function: Returns the value of the angle having the given tangent.

For a real argument, the result ranges from -90 to $+90$ degrees ($-\pi/2$ to $+\pi/2$ radians; -100 to $+100$ grads).

The inverse of TAN is a *relation*, not a function, since TAN sends more than one argument to the same result. The inverse relation for TAN is expressed by ISOL as the *general solution*:

$$\text{ATAN}(Z) + \pi * n1$$

The function ATAN is the inverse of a *part* of TAN, a part defined by restricting the domain of TAN such that:

- each argument is sent to a distinct result, and
- each possible result is achieved.

The points in this restricted domain of TAN are called the *principal values* of the inverse relation. ATAN in its entirety is called the *principal branch* of the inverse relation, and the points sent by ATAN to the boundary of the restricted domain of TAN form the *branch cuts* of ATAN.

The principal branch used by the hp49g+/hp48gII for ATAN was chosen because it is analytic in the regions where the arguments of the *real-valued* inverse function are defined. The branch cuts for the complex-valued arc tangent function occur where the corresponding real-valued function is undefined. The principal branch also preserves most of the important symmetries.

The graphs below show the domain and range of ATAN. The graph of the domain shows where the branch cuts occur: the heavy solid line marks one side of a cut, while the feathered lines mark the other side of a cut. The graph of the range shows where each side of each cut is mapped under the function.

These graphs show the inverse relation $\text{ATAN}(Z) + \pi * n1$ for the case $n1 = 0$. For other values of $n1$, the vertical band in the lower graph is translated to the right (for $n1$ positive) or to the left (for $n1$ negative). Together, the bands cover the whole complex plane, the domain of TAN.

View these graphs with domain and range reversed to see how the domain of TAN is restricted to make an inverse *function* possible. Consider the vertical band in the lower graph as the restricted domain $Z = (x, y)$. TAN sends this domain onto the whole complex plane in the range $W = (u, v) = \text{TAN}(x, y)$ in the upper graph.

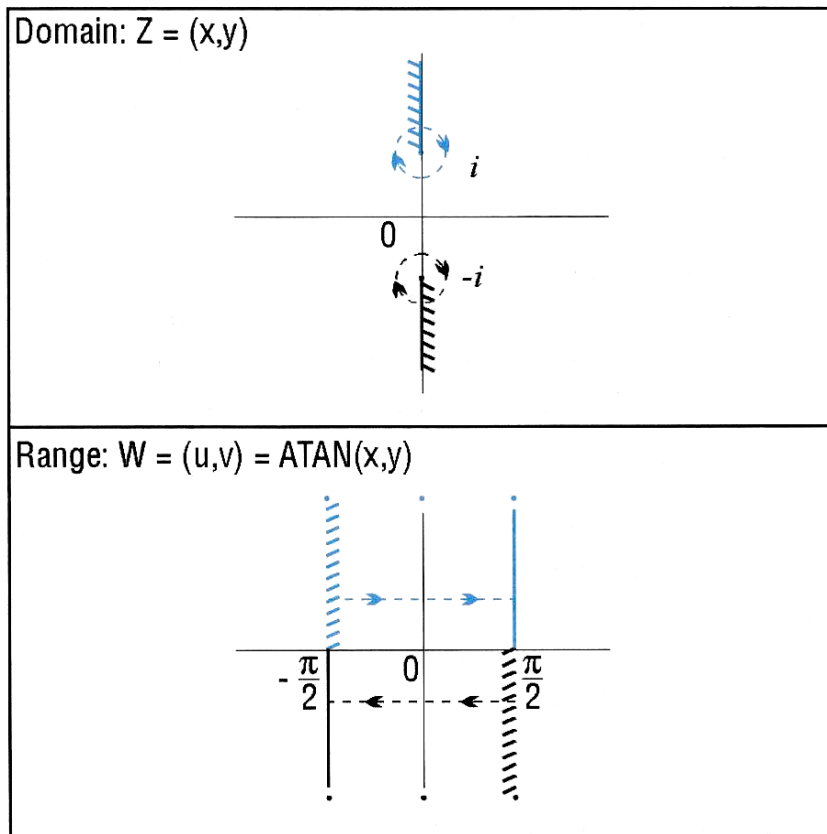

Branch Cuts for ATAN(Z)

Access: \leftarrow ATAN (ATAN is the left-shift of the TAN key).

Flags: Principal Solution (-1), Numerical Results (-3), Angle Mode (-17, -18)

Input/Output:

| Level 1/Argument 1 | | Level 1/Item 1 |
|--------------------|---------------|-----------------------|
| z | \rightarrow | $\text{atan } z$ |
| ' <i>sybm</i> ' | \rightarrow | 'ATAN(<i>sybm</i>)' |

See also: ACOS, ASIN, ISOL, TAN

ATAN2S

CAS: Transform expressions by replacing $\text{atan}(x)$ with $\text{asin}(x/\sqrt{x^2+1})$.

ATANH

Type: Analytic Function

Description: Arc Hyperbolic Tangent Analytic Function: Returns the inverse hyperbolic tangent of the argument.

For real arguments $|x| > 1$, ATANH returns the complex result obtained for the argument $(x, 0)$. For a real argument $x = \pm 1$, an Infinite Result exception occurs. If flag -22 is set (no error), the sign of the result (MAXR) matches that of the argument.

The inverse of TANH is a *relation*, not a function, since TANH sends more than one argument to the same result. The inverse relation for TANH is expressed by ISOL as the *general solution*;

$$\text{ATANH}(Z) + \pi * i * n1$$

The function ATANH is the inverse of a *part* of TANH, a part defined by restricting the domain of TANH such that:

- each argument is sent to a distinct result, and
- each possible result is achieved.

The points in this restricted domain of TANH are called the *principal values* of the inverse relation. ATANH in its entirety is called the *principal branch* of the inverse relation, and the points sent by ATANH to the boundary of the restricted domain of TANH form the *branch cuts* of ATANH.

The principal branch used by the hp49g+/hp48gII for ATANH was chosen because it is analytic in the regions where the arguments of the *real-valued* function are defined. The branch cut for the complex-valued ATANH function occurs where the corresponding real-valued function is undefined. The principal branch also preserves most of the important symmetries.

The graph for ATANH can be found from the graph for ATAN (see ATAN) and the relationship $\operatorname{atanh} z = -i \operatorname{atan} iz$.

Access:  TRIG HYPERBOLIC ATAN (TRIG is the right-shift of the  key).

Flags: Principal Solution (-1), Numerical Results (-3), Infinite Result Exception (-22)

Input/Output:

| Level 1/Argument 1 | | Level 1/Item 1 |
|--------------------|---|--------------------------|
| z | → | $\operatorname{atanh} z$ |
| ' <i>symb</i> ' | → | ' <i>ATANH(symb)</i> ' |

See also: ACOSH, ASINH, ISOL, TANH

ATICK

Type: Command

Description: Axes Tick-Mark Command: Sets the axes tick-mark annotation in the reserved variable *PPAR*.

Given x , ATICK sets the tick-mark annotation to x units on both the x - and the y -axis. For example, 2 would place tick-marks every 2 units on both axes.

Given $\#n$, ATICK sets the tick-mark annotation to $\#n$ pixels on both the x - and the y -axis. For example, $\#5$ would place tick-marks every 5 pixels on both axes.

Given $\{x\ y\}$, ATICK sets the tick-mark unit annotation for each axis individually. For example, $\{10\ 3\}$ would mark the x -axis at every multiple of 10 units, and the y -axis at every multiple of 3 units.

Given $\{\#n\ \#m\}$ ATICK sets the tick-mark pixel annotation for each axis individually. For example, $\{\#6\ \#2\}$ would mark the x -axis every 6 pixels, and the y -axis every 2 pixels.

Access:  CAT ATICK

Input/Output:

| Level 1/Argument 1 | | Level 1/Item 1 |
|--------------------|---|----------------|
| x | → | |
| $\#n$ | → | |
| $\{x\ y\}$ | → | |
| $\{\#n\ \#m\}$ | → | |

See also: AXES, DRAX

ATTACH

Type: Command

Description: Attach Library Command: Attaches the library with the specified number to the current directory. Each library has a unique number. If a port number is specified, it is ignored.

To use a library object, it must be in a port and it must be attached. A library object copied into RAM (such as through the PC Link) must be stored into a port using STO.

Some libraries require you to ATTACH them.

You can ascertain whether a library is attached to the current directory by executing LIBS.

The number of libraries that can be attached to the HOME directory is limited only by the available memory. However, only one library at a time can be attached to any other directory. If you attempt to attach a second library to a non-HOME directory, the new library will overwrite the old one.

Access:  CAT ATTACH

Input/Output:

| Level 1/Argument 1 | Level 1/Item 1 |
|--|----------------|
| n_{library} | → |
| $:N_{\text{port}} :n_{\text{library}}$ | → |

See also: DETACH, LIBS

AUGMENT

CAS: Concatenate lists, or vectors, with elements, or create matrices from row vectors.

AUTO

Type: Command

Description: Autoscale Command: Calculates a y -axis display range, or an x - and y -axis display range.

The action of AUTO depends on the plot type as follows:

| Plot Type | Scaling Action |
|------------|---|
| FUNCTION | Samples the equation in EQ at 40 values of the independent variable, equally spaced through the x -axis plotting range, discards points that return $\pm\infty$, then sets the y -axis display range to include the maximum, minimum, and origin. |
| CONIC | Sets the y -axis scale equal to the x -axis scale. |
| POLAR | Samples the equation in EQ at 40 values of the independent variable, equally spaced through the plotting range, discards points that return $\pm\infty$, then sets both the x - and y -axis display ranges in the same manner as for plot type FUNCTION. |
| PARAMETRIC | Same as POLAR. |
| TRUTH | No action. |
| BAR | Sets the x -axis display range from 0 to the number of elements in ΣDAT , plus 1. Sets the y -range to the minimum and maximum of the elements. The x -axis is always included. |
| HISTOGRAM | Sets the x -axis display range to the minimum and maximum of the elements in ΣDAT . Sets the y -axis display range from 0 to the number of rows in ΣDAT . |

| Plot Type | Scaling Action |
|-----------|---|
| SCATTER | Sets the x -axis display range to the minimum and maximum of the independent variable column (XCOLD) in ΣDAT . Sets the y -axis display range to the minimum and maximum of the dependent variable column (YCOL). |

AUTO does not affect 3D plots.

AUTO actually calculates a y -axis display range and then expands that range so that the menu labels do not obscure the resultant plot.

AUTO does not draw a plot – execute DRAW to do so.

Access:  CAT AUTO

Input/Output: None

See also: DRAW, SCALEH, SCALE, SCLΣ, SCALEW, XRNG, YRNG

AXES

Type: Command

Description: Axes Command: Specifies the intersection coordinates of the x - and y -axes, tick-mark annotation, and the labels for the x - and y -axes. This information is stored in the reserved variable $PPAR$.

The argument for AXES (a complex number or list) is stored as the fifth parameter in the reserved variable $PPAR$. How the argument is used depends on the type of object it is:

- If the argument is a complex number, it replaces the current entry in $PPAR$.
- If the argument is a list containing any or all of the above variables, only variables that are specified are affected.

atick has the same format as the argument for the ATICK command. This is the variable that is affected by the ATICK command.

The default value for AXES is (0,0).

Axes labels are not displayed in $PICT$ until subsequent execution of LABEL.

Access:  CAT AXES

Input/Output:

| Level 1/Argument 1 | Level 1/Item 1 |
|---|----------------|
| (x, y) | → |
| { (x, y) <i>atick</i> "x-axis label" "y-axis label" } | → |

See also: ATICK, DRAW, DRAX, LABEL

AXL

CAS: Convert a list to an array, or an array to a list.

AXM

CAS: Convert a numeric array to a symbolic matrix, or a symbolic matrix to a numeric array.

AXQ

CAS: Convert a square matrix into the associated quadratic form.

BAR

Type: Command

Description: Bar Plot Type Command: Sets the plot type to BAR.

When the plot type is BAR, the DRAW command plots a bar chart using data from one column of the current statistics matrix (reserved variable ΣDAT). The column to be plotted is specified by the XCOL command, and is stored in the first parameter of the reserved variable ΣPAR . The plotting parameters are specified in the reserved variable $PPAR$, which has the following form:

$$\{ (x_{\min}, y_{\min}) (x_{\max}, y_{\max}) indep res axes ptype depend \}$$

For plot type BAR, the elements of $PPAR$ are used as follows:

- (x_{\min}, y_{\min}) is a complex number specifying the lower left corner of $PICT$ (the lower left corner of the display range). The default value is $(-6.5, -3.1)$ for the hp48gII and $(-6.5, -3.9)$ for the hp49g+.
- (x_{\max}, y_{\max}) is a complex number specifying the upper right corner of $PICT$ (the upper right corner of the display range). The default value is $(6.5, 3.2)$ for the hp48gII and $(6.5, 4.0)$ for the hp49g+.
- *indep* is either a name specifying a label for the horizontal axis, or a list containing such a name and two numbers, with the smaller of the numbers specifying the horizontal location of the first bar. The default value of *indep* is *X*.
- *res* is a real number specifying the bar width in user-unit coordinates, or a binary integer specifying the bar width in pixels. The default value is 0, which specifies a bar width of 1 in user-unit coordinates.
- *axes* is a list containing one or more of the following, in the order listed: a complex number specifying the user-unit coordinates of the plot origin, a list specifying the tick-mark annotation, and two strings specifying labels for the horizontal and vertical axes. The default value is $(0, 0)$.
- *ptype* is a command name specifying the plot type. Executing the command BAR places the command name BAR in $PPAR$.
- *depend* is a name specifying a label for the vertical axis. The default value is *Y*.

A bar is drawn for each element of the column in ΣDAT . Its width is specified by *res* and its height is the value of the element. The location of the first bar can be specified by *indep*; otherwise, the value in (x_{\min}, y_{\min}) is used.

Access:  CAT BAR

Input/Output: None

See also: CONIC, DIFFEQ, FUNCTION, GRIDMAP, HISTOGRAM, PARAMETRIC, PARSURFACE, PCONTOUR, POLAR, SCATTER, SLOPEFIELD, TRUTH, WIREFRAME, YSLICE

BARPLOT

Type: Command

Description: Draw Bar Plot Command: Plots a bar chart of the specified column of the current statistics matrix (reserved variable ΣDAT).

The data column to be plotted is specified by XCOL and is stored as the first parameter in reserved variable ΣPAR . The default column is 1. Data can be positive or negative, resulting in bars above or below the axis. The *y*-axis is autoscaled, and the plot type is set to BAR.

When BARPLOT is executed from a program, the resulting plot does not persist unless PICTURE, PVIEW (with an empty list argument), or FREEZE is subsequently executed.

Access:  CAT BARPLOT

Input: None

Output: A bar chart based on ΣDAT .

See also: FREEZE, HISTPLOT, PICTURE, PVIEW, SCATRLOT, XCOL

BASIS

CAS: Determine the basis of a sub-space of the n-space R^n .

BAUD

Type: Command

Description: Baud Rate Command: Specifies bit-transfer rate.

Legal baud rates are 2400, 4800, 9600 (default), 14400, 19200, 38400, 57600 and 115200.

Access:  CAT BAUD

Input/Output:

| Level 1/Argument 1 | Level 1/Item 1 |
|-----------------------|----------------|
| n_{baudrate} | → |

See also: CKSM, PARITY, TRANSIO

BEEP

Type: Command

Description: Beep Command: Sounds a tone at n hertz for x seconds.

The frequency of the tone is subject to the resolution of the built-in tone generator. The minimum frequency is 1 Hz and the maximum frequency is 15000 Hz. An input that doesn't round to an integer within this range will cause the BEEP command to be skipped. Durations greater than 1200 seconds are automatically changed to 1200 seconds.

Access:  PRG  OUT  BEEP (PRG is the left-shift of the  key).

Flags: Error Beep (-56)

Input/Output:

| Level 2/Argument 1 | Level 1/Argument 2 | Level 1/Item 1 |
|------------------------|-----------------------|----------------|
| $n_{\text{frequency}}$ | x_{duration} | → |

See also: HALT, INPUT, PROMPT, WAIT

BESTFIT

Type: Command

Description: Best-Fitting Model Command: Executes LR with each of the four curve fitting models, and selects the model yielding the largest correlation coefficient.

The selected model is stored as the fifth parameter in the reserved variable ΣPAR , and the associated regression coefficients, intercept and slope, are stored as the third and fourth parameters, respectively.

Access:  CAT BESTFIT

Input/Output: None

See also: EXPFIT, LINFIT, LOGFIT, LR, PWRFIT

BIN

Type: Command

Description: Binary Mode Command: Selects binary base for binary integer operations. (The default base is decimal.)

Binary integers require the prefix #. Binary integers entered and returned in binary base automatically show the suffix b. If the current base is not binary, binary numbers can still be entered by using the suffix b (the numbers are displayed in the current base, however).

The current base does not affect the internal representation of binary integers as unsigned binary numbers.

Access: $\boxed{\rightarrow}$ BASE BIN (BASE is the right-shift of the $\boxed{3}$ key).
Flags: Binary Integer Wordsize (-5 through -10), Binary Integer Base (-11, -12)
Input/Output: None
See also: DEC, HEX, OCT, STWS, RCWS

BINS

Type: Command

Description: Sort into Frequency Bins Command: Sorts the elements of the independent column (XCOL) of the current statistics matrix (the reserved variable ΣDAT) into $(n_{bins} + 2)$ bins, where the left edge of bin 1 starts at value x_{min} and each bin has width x_{width} .

BINS returns a matrix containing the frequency of occurrences in each bin, and a 2-element array containing the frequency of occurrences falling below or above the defined range of x -values. The array can be stored into the reserved variable ΣDAT and used to plot a bar histogram of the bin data (for example, by executing BARPLOT).

For each element x in ΣDAT , the n th bin count $n_{freq\ bin\ n}$ is incremented, where:

$$n_{freq\ bin\ n} = IP \left[\frac{x - x_{min}}{x_{width}} \right]$$

for $x_{min} \leq x \leq x_{max}$, where $x_{max} = x_{min} + (n_{bins})(x_{width})$.

Access: $\boxed{\rightarrow}$ CAT BINS

Input/Output:

| L3/A1 | L2/A2 | L1/A3 | | L2/I1 | L1/I2 |
|-----------|-------------|------------|---------------|-------------------------------------|-------------------------------|
| x_{min} | x_{width} | n_{bins} | \rightarrow | $[[n_{bin\ 1} \dots n_{bin\ n}]]$ | $[n_{bin\ L} \ n_{bin\ R}]$ |

L = Level; A = Argument; I = item

See also: BARPLOT, XCOL

BLANK

Type: Command

Description: Blank Graphics Object Command: Creates a blank graphics object of the specified width and height.

Access: $\boxed{\leftarrow}$ PRG \boxed{NXT} GROB BLANK (PRG is the left-shift of the \boxed{EVAL} key).

Input/Output:

| Level 2/Argument 1 | Level 1/Argument 2 | | Level 1/Item 1 |
|--------------------|--------------------|---------------|----------------|
| $\#n_{width}$ | $\#m_{height}$ | \rightarrow | $grob_{blank}$ |

See also: \rightarrow GROB, LCD \rightarrow

BOX

Type: Command Operation

Description: Box Command: Draws in *PICT* a box whose opposite corners are defined by the specified pixel or user-unit coordinates.

Access: $\boxed{\leftarrow}$ PRG \boxed{NXT} PICT BOX (PRG is the left-shift of the \boxed{EVAL} key).

Input/Output:

| Level 2/Argument 1 | Level 1/Argument 2 | | Level 1/Item 1 |
|-----------------------|-----------------------|---------------|----------------|
| $\{ \#n_1 \ \#m_1 \}$ | $\{ \#n_2 \ \#m_2 \}$ | \rightarrow | |
| (x_1, y_1) | (x_2, y_2) | \rightarrow | |

See also: ARC, LINE, TLINE

BUFLEN

Type: Command

Description: Buffer Length Command: Returns the number of characters in the hp49g+/hp48gII 's serial input buffer and a single digit indicating whether an error occurred during data reception.

The digit returned is 1 if no framing, UART overrun, or input-buffer overflow errors occurred during reception, or 0 if one of these errors did occur. (The input buffer holds up to 255 bytes.) When a framing or overrun error occurs, data reception ceases until the error is cleared (which BUFLEN does); therefore, n represents the data received *before* the error.

Use ERRM to see which error has occurred when BUFLEN returns 0 to level 1.

Access:  CAT BUFLEN

Input/Output:

| Level 1/Argument 1 | Level 2/Item 1 | Level 1/Item 2 |
|--------------------|----------------|--------------------|
| | → | n_{chars} |
| | | 0/1 |

See also: CLOSEIO, OPENIO, SBRK, SRECV, STIME, XMIT

BYTES

Type: Command

Description: Byte Size Command: Returns the number of bytes and the checksum for the given object.

If the argument is a built-in object, then the size is 2.5 bytes and the checksum is #0.

If the argument is a global name, then the size represents the name *and* its contents, while the checksum represents the contents only. The size of the name alone is $(3.5 + n)$, where n is the number of characters in the name.

Access:  PRG MEMORY BYTES (PRG is the left-shift of the  key).

Input/Output:

| Level 1/Argument 1 | Level 2/Item 1 | Level 1/Item 2 |
|--------------------|----------------|-------------------------|
| obj | → | $\#n_{\text{checksum}}$ |
| | | \times_{size} |

See also: MEM

B→R

Type: Command

Description: Binary to Real Command: Converts a binary integer to its floating-point equivalent.

If $\# n \geq \# 1000000000000$ (base 10), only the 12 most significant decimal digits are preserved in the resulting mantissa.

Access:  BASE B→R (BASE is the right-shift of the  key).

Flags: Binary Integer Wordsize (-5 through -10), Binary Integer Base (-11, -12)

Input/Output:

| Level 1/Argument 1 | Level 1/Item 1 |
|--------------------|----------------|
| $\#n$ | → n |

See also: R→B

C2P

CAS: Take a list of cycles and return the equivalent permutation.

CASCFG

CAS: Restore the default CAS mode settings with the modulus value set to 13.

CASCMD

CAS: List CAS operations, provide descriptions and examples.

CASE

Type: Command

Description: CASE Conditional Structure Command: Starts CASE ... END conditional structure.

The CASE ... END structure executes a series of *cases* (tests). The first test that returns a true result causes execution of the corresponding true-clause, ending the CASE ... END structure. A default clause can also be included: this clause executes if all tests evaluate to false. The CASE command is available in RPN programming only. You cannot use it in algebraic programming.

The CASE ... END structure has this syntax:

```
CASE
  test-clause1 THEN true-clause1 END
  test-clause2 THEN true-clause2 END
  .
  test-clausen THEN true-clausen END
  default-clause (optional)
END
```

When CASE executes, *test-clause₁* is evaluated. If the test is true, *true-clause₁* executes, then execution skips to END. If *test-clause₁* is false, *test-clause₂* executes. Execution within the CASE structure continues until a true clause is executed, or until all the test clauses evaluate to false. If the default clause is included, it executes if all test clauses evaluate to false.

Access:  PRG BRCH CASE ( PRG is the left-shift of the  key).

Input/Output:

| Level 1/Argument 1 | Level 1/Item 1 |
|--------------------|----------------|
| CASE | → |
| THEN | T/F → |
| END | → |
| END | → |

See also: END, IF, IFERR, THEN

CEIL

Type: Function

Description: Ceiling Function: Returns the smallest integer greater than or equal to the argument.

Access:  MTH REAL   CEIL ( MTH is the left-shift of the  key).

Flags: Numerical Results (-3)

Input/Output:

| Level 1/Argument 1 | Level 1/Item 1 |
|--------------------|-------------------------|
| x | → n |
| x_unit | → n_unit |
| ' <i>symb</i> ' | → 'CEIL(<i>symb</i>)' |

See also: FLOOR, IP, RND, TRNC

CENTR

Type: Command

Description: Center Command: Adjusts the first two parameters in the reserved variable $PPAR$, (x_{\min}, y_{\min}) and (x_{\max}, y_{\max}) , so that the point represented by the argument (x, y) is the plot center. On the hp49g+, the center pixel is in row 40, column 65 when $PICT$ is its default size (131×80). On the hp48gII, the center pixel is in row 32, column 65 when $PICT$ is its default size (131×64). If the argument is a real number x , CENTR makes the point $(x,0)$ the plot center.

Access: $\boxed{\rightarrow}$ $\boxed{\text{CAT}}$ CENTR

Input/Output:

| Level 1/Argument 1 | Level 1/Item 1 |
|--------------------|----------------|
| (x, y) | \rightarrow |
| x | \rightarrow |

See also: SCALE

CF

Type: Command

Description: Clear Flag Command: Clears the specified user or system flag.

User flags are numbered 1 through 128. System flags are numbered -1 through -128 . See Appendix C for a listing of hp49g+/hp48gII system flags and their flag numbers.

Access: $\boxed{\leftarrow}$ $\boxed{\text{PRG}}$ TEST $\boxed{\text{NXT}}$ $\boxed{\text{NXT}}$ CF ($\boxed{\text{PRG}}$ is the left-shift of the $\boxed{\text{EVAL}}$ key).

Input/Output:

| Level 1/Argument 1 | Level 1/Item 1 |
|--------------------------|----------------|
| $n_{\text{flag number}}$ | \rightarrow |

See also: FC?, FC?C, FS?, FS?C, SF

%CH

Type: Function

Description: Percent Change Function: Returns the percent change from x to y as a percentage of x .

If both arguments are unit objects, the units must be consistent with each other. The dimensions of a unit object are dropped from the result, *but units are part of the calculation*.

For more information on using temperature units with arithmetic functions, refer to the keyword entry of +.

Access: $\boxed{\leftarrow}$ $\boxed{\text{MTH}}$ REAL %CH ($\boxed{\text{MTH}}$ is the left-shift of the $\boxed{\text{SYMB}}$ key).

Flags: Numerical Results (-3)

Input/Output:

| Level 2/Argument 1 | Level 1/Argument 2 | Level 1/Item 1 |
|---------------------|---------------------|--|
| x | y | \rightarrow $100(y - x)/x$ |
| x | ' symb ' | \rightarrow '%CH(x, symb)' |
| ' symb ' | x | \rightarrow '%CH(symb, x)' |
| ' symb_1 ' | ' symb_2 ' | \rightarrow '%CH($\text{symb}_1, \text{symb}_2$)' |
| x_{unit} | y_{unit} | \rightarrow $100(y_{\text{unit}} - x_{\text{unit}})/x_{\text{unit}}$ |
| x_{unit} | ' symb ' | \rightarrow '%CH($x_{\text{unit}}, \text{symb}$)' |
| ' symb ' | x_{unit} | \rightarrow '%CH($\text{symb}, x_{\text{unit}}$)' |

See also: %, %T

CHINREM

CAS: Solve a system of simultaneous polynomial congruences in the ring $Z[x]$.

CHOLESKY

CAS: Return the Cholesky factorization of a square matrix.

CHOOSE

Type: Command

Description: Create User-Defined Choose Box Command: Creates a user-defined choose box.

CHOOSE creates a standard single-choice choose box based on the following specifications:

| Variable | Function |
|---------------------|--|
| "prompt" | A message that appears at the top of choose box. If "prompt" is an empty string (""), no message is displayed. |
| { $c_1 \dots c_n$ } | Definitions that appear within the choose box. A choice definition (c_x) can have two formats. <ul style="list-style-type: none"> • <i>obj</i>, any object • { <i>obj_{display}</i> <i>obj_{result}</i> }, the object to be displayed followed by the result returned to the stack if that object is selected. |
| n_{pos} | The position number of an item definition. This item is highlighted when the choose box appears. If $n_{pos} = 0$, no item is highlighted, and the choose box can be used to view items only. |

If you choose an item from the choose box and press OK, CHOOSE returns the *result* (or the object itself if no result is specified) to level 2 and 1 to level 1. If you press **CANCEL**, CHOOSE returns 0. Also, if $n_{pos} = 0$, CHOOSE returns 0.

Access: **PRG** IN CHOOSE (**PRG** is the left-shift of the key).

Input/Output:

| L3/A1 | L2/A2 | L1/A3 | | L2/I1 | L1/I2 |
|----------|---------------------|-----------|---|----------------------|-------|
| "prompt" | { $c_1 \dots c_n$ } | n_{pos} | → | <i>obj or result</i> | "1" |
| "prompt" | { $c_1 \dots c_n$ } | n_{pos} | → | | "0" |

L = Level; A = Argument; I = item

See also: INFORM, NOVAL

CHR

Type: Command

Description: Character Command: Returns a string representing the character corresponding to the character code n .

The character codes are an extension of ISO 8859/1. Codes 128 through 160 are unique to the hp49g+/hp48gII.

The default character **■** is supplied for all character codes that are *not* part of the normal hp49g+/hp48gII display character set.

Character code 0 is used for the special purpose of marking the end of the command line. Attempting to edit a string containing this character causes the error Can't Edit Null Char.

You can use the CHARS application to find the character code for any character used by the hp49g+/hp48gII. See "Additional Character Set" in Appendix D of the *hp49g+/hp48gII User's Guide*.

Access: **PRG** TYPE CHR (**PRG** is the left-shift of the key).

Input/Output:

| Level 1/Argument 1 | Level 1/Item 1 |
|--------------------|----------------|
| n | "string" |

See also: NUM, POS, REPL, SIZE, SUB

CIRC

CAS: Compose two permutations.

CKSM

Type: Command

Description: Checksum Command: Specifies the error-detection scheme.

Legal values for $n_{checksum}$ are as follows:

- 1-digit arithmetic checksum.
- 2-digit arithmetic checksum.
- 3-digit cyclic redundancy check (default).

The CKSM specified is the error-detection scheme that will be requested by KGET, PKT, or SEND. If the sender and receiver disagree about the request, however, then a 1-digit arithmetic checksum will be used.

Access:  CAT CKSM

Input/Output:



| Level 1/Argument 1 | Level 1/Item 1 |
|--------------------|----------------|
| $n_{checksum}$ | |

See also: BAUD, PARITY, TRANSIO

CLEAR

Type: Command

Description: Clear Command: Removes all objects from the stack or history.

To recover a cleared stack or history, press  UNDO (the right-shift of the  key) before executing any other operation. There is no programmable command to recover the stack or history.

Access:  CLEAR (CLEAR is the right-shift of the  key).

Input/Output:



| Level _n /Argument 1 ... Level 1/Argument _n | Level _n /Item 1 ... Level 1/Item _n |
|--|--|
| $obj_n \dots obj_1$ | |

See also: CLVAR, PURGE

CLKADJ

Type: Command

Description: Adjust System Clock Command: Adjusts the system time by x clock ticks, where 8192 clock ticks equal 1 second. If x is positive, x clock ticks are added to the system time. If x is negative, x clock ticks are subtracted from the system time. If $X > 10^{12}$, it will be changed to 10^{12} ticks (which is approximately 3.87 years).

Access:  TIME TOOLS   CLKADJ (TIME is the right-shift of the  key).

Input/Output:

| Level 1/Argument 1 | Level 1/Item 1 |
|--------------------|----------------|
| x | |

See also: →TIME

CLLCD

Type: Command

Description: Clear LCD Command: Clears (blanks) the stack display.

The menu labels continue to be displayed after execution of CLLCD.

When executed from a program, the blank display persists only until the keyboard is ready for input. To cause the blank display to persist until a key is pressed, execute FREEZE after executing CLLCD. (When executed from the keyboard, CLLCD *automatically* freezes the display.)

Access:  PRG  OUT CLLCD ( is the left-shift of the  key).

Input/Output: None

See also: DISP, FREEZE

CLOSEIO



Type: Command

Description: Close I/O Port Command: Closes the serial port, and clears the input buffer and any error messages for KERRM.

When the hp49g+/hp48gII turns off, it automatically closes the serial port, but does not clear KERRM. Therefore, CLOSEIO is not needed to close the port, but can conserve power without turning off the calculator.

Executing hp49g+/hp48gII Kermit protocol commands automatically clears the input buffer; however, executing non-Kermit commands (such as SRECV and XMIT) does not.

CLOSEIO also clears error messages from KERRM. This can be useful when debugging.

Access:   CLOSEIO

Input/Output: None

See also: BUFLN, OPENIO

CLΣ

Type: Command

Description: Purges the current statistics matrix (reserved variable ΣDAT).

Access:   CLΣ

Input/Output: None

See also: RCLΣ, STOΣ, Σ+, Σ-

CLVAR

Type: Command

Description: Clear Variables Command: Purges all variables and empty subdirectories in the current directory.

Access:   CLVAR

Input/Output: None

See also: PGDIR, PURGE

CMPLX

Type: Command

Description: Displays a menu of commands pertaining to complex numbers.

Access:   CMPLX

Input/Output: None

See also: ARIT, DIFF, EXP&LN, SOLVER, TRIGO

CNRM

Type: Command

Description: Column Norm Command: Returns the column norm (one-norm) of the array argument.

The column norm of a matrix is the maximum (over all columns) of the sum of the absolute values of all elements in each column. For a vector, the column norm is the sum of the absolute values of the vector elements. For complex arrays, the absolute value of a given element (x, y) is $\sqrt{x^2 + y^2}$.

Access: $\left[\leftarrow \right]$ MATRICES OPERATIONS CNRM (MATRICES is the left-shift of the $\left[5 \right]$ key).

Input/Output:

| Level 1/Argument 1 | Level 1/Item 1 |
|--------------------|----------------------------|
| $[array]$ | $\mathcal{X}_{columnnorm}$ |

See also: CROSS, DET, DOT, RNRM

→COL

Type: Command

Description: Matrix to Columns Command: Transforms a matrix into a series of column vectors and returns the vectors and a column count, or transforms a vector into its elements and returns the elements and an element count.

→COL introduces no rounding error.

Access: $\left[\leftarrow \right]$ MTH MATRIX COL →COL (MTH is the left-shift of the $\left[\text{SYMB} \right]$ key).

$\left[\leftarrow \right]$ MATRICES CREATE COLUMN →COL (MATRICES is the left-shift of the $\left[5 \right]$ key).

Input/Output:

| Level 1/Argument 1 | Level n+1/Item 1 ... | Level 2/Item 2 | Level 1/Item 3 |
|--------------------|----------------------|---------------------|--------------------|
| $[[matrix]]$ | \rightarrow | $[vector]_{col1}$ | $n_{colcount}$ |
| $[vector]$ | \rightarrow | $element_1$ | $n_{elementcount}$ |

See also: COL→, →ROW, ROW→

COL→

Type: Command

Description: Columns to Matrix Command: Transforms a series of column vectors and a column count into a matrix containing those columns, or transforms a sequence of numbers and an element count into a vector with those numbers as elements.

All vectors must have the same length. The column or element count is rounded to the nearest integer.

Access: $\left[\leftarrow \right]$ MTH MATRIX COL COL→ (MTH is the left-shift of the $\left[\text{SYMB} \right]$ key).

$\left[\leftarrow \right]$ MATRICES CREATE COLUMN COL→ (MATRICES is the left-shift of the $\left[5 \right]$ key).

Input/Output:

| Ln+1/A1 ... | L2/A2 | L1/An+1 | Level 1/Item 1 |
|---------------------|---------------------|--------------------|----------------|
| $[vector]_{col1}$ | $[vector]_{coln}$ | $n_{colcount}$ | \rightarrow |
| $element_1$ | $element_n$ | $n_{elementcount}$ | \rightarrow |
| | | | $[[matrix]]$ |
| | | | $[vector]$ |

L = Level; A = Argument; I = item

See also: →COL, →ROW, ROW→

COL-

Type: Command

Description: Delete Column Command: Deletes column n of a matrix (or element n of a vector), and returns the modified matrix (or vector) and the deleted column (or element).
 n is rounded to the nearest integer.

Access: \leftarrow **MTH** MATRIX COL COL- (**MTH** is the left-shift of the **SYMB** key).
 \leftarrow **MATRICES** CREATE COLUMN COL- (**MATRICES** is the left-shift of the **5** key).

Input/Output:

| Level 2/Argument 1 | Level 1/Argument 2 | | Level 2/Item 1 | Level 1/Item 2 |
|--------------------|--------------------|---------------|----------------|---------------------|
| $[[matrix]]_1$ | n_{column} | \rightarrow | $[[matrix]]_2$ | $[vector]_{column}$ |
| $[vector]_1$ | $n_{element}$ | \rightarrow | $[vector]_2$ | $element_n$ |

See also: COL+, CSWP, ROW+, ROW-

COL+

Type: Command

Description: Insert Column Command: Inserts an array (vector or matrix) into a matrix (or one or more elements into a vector) at the position indicated by n_{index} , and returns the modified array. The inserted array must have the same number of rows as the target array. n_{index} is rounded to the nearest integer. The original array is redimensioned to include the new columns or elements, and the elements at and to the right of the insertion point are shifted to the right.

Access: \leftarrow **MTH** MATRIX COL COL+ (**MTH** is the left-shift of the **SYMB** key).
 \leftarrow **MATRICES** CREATE COLUMN COL+ (**MATRICES** is the left-shift of the **5** key).

Input/Output:

| Level 3/Argument 1 | Level 2/Argument 2 | Level 1/Argument 3 | | Level 1/Item 1 |
|--------------------|---------------------|--------------------|---------------|----------------|
| $[[matrix]]_1$ | $[[matrix]]_2$ | n_{index} | \rightarrow | $[[matrix]]_3$ |
| $[[matrix]]_1$ | $[vector]_{column}$ | n_{index} | \rightarrow | $[[matrix]]_2$ |
| $[vector]_1$ | $n_{element}$ | n_{index} | \rightarrow | $[vector]_2$ |

See also: COL-, CSWP, ROW+, ROW-

COLCT

Type: Command

Description: Factorizes a polynomial or an integer. Identical to COLLECT.

Access: \rightarrow **CAT** COLCT

Input/Output:

| Level 1/Argument 1 | | Level 1/Item 1 |
|--------------------|---------------|----------------|
| ' $symb_1$ ' | \rightarrow | ' $symb_2$ ' |
| x | \rightarrow | x |
| (x, y) | \rightarrow | (x, y) |

See also: EXPAN, FACTOR, ISOL, QUAD, SHOW

COLLECT

CAS: Factorize a polynomial or an integer. Identical to COLCT.

COLΣ

Type: Command

Description: Column Sigma Command: Specifies the independent-variable and dependent-variable columns of the current statistics matrix (the reserved variable ΣDAT).

COLΣ combines the functionality of XCOL and YCOL. The independent-variable column number x_{col} is stored as the first parameter in the reserved variable ΣPAR (the default is 1). The dependent-variable column number y_{col} is stored as the second parameter in the reserved variable ΣPAR (the default is 2).

COLΣ accepts and stores noninteger values, but subsequent commands that use these two parameters in ΣPAR will cause errors.

Access:  CAT COLΣ

Input/Output:

| Level 2/Argument 1 | Level 1/Argument 2 | Level 1/Item 1 |
|--------------------|--------------------|----------------|
| x_{col} | y_{col} | → |

See also: BARPLOT, BESTFIT, CORR, COV, EXPFIT, HISTPLOT, LINFIT, LOGFIT, LR, PREDX, PREDY, PWRFIT, SCATRPLOT, XCOL, YCOL

COMB

Type: Function

Description: Combinations Function: Returns the number of possible combinations of n items taken m at a time. The following formula is used:

$$C_{n,m} = \frac{n!}{m! \cdot (n-m)!}$$

The arguments n and m must each be less than 10^{12} . If $n < m$, zero is returned.

Access:  MTH NXT PROBABILITY COMB (MTH is the left-shift of the SYMB key).

Flags: Numerical Results (-3)

Input/Output:

| Level 2/Argument 1 | Level 1/Argument 2 | Level 1/Item 1 |
|--------------------|--------------------|------------------------------|
| n | m | → $C_{n,m}$ |
| ' $symb_n$ ' | m | → ' $COMB(symb_n, m)$ ' |
| n | ' $symb_m$ ' | → ' $COMB(n, symb_m)$ ' |
| ' $symb_n$ ' | ' $symb_m$ ' | → ' $COMB(symb_n, symb_m)$ ' |

See also: FACT, PERM, !

CON

Type: Command

Description: Constant Array Command: Returns a constant array, defined as an array whose elements all have the same value.

The constant value is a real or complex number taken from argument 2/level 1. The resulting array is either a new array, or an existing array with its elements replaced by the constant, depending on the object in argument 1/level 2.

- **Creating a new array:** If argument 1/level 2 contains a list of one or two integers, CON returns a new array. If the list contains a single integer n_{columns} , CON returns a constant vector with n elements. If the list contains two integers n_{rows} and m_{columns} , CON returns a constant matrix with n rows and m columns.
- **Replacing the elements of an existing array:** If argument 1/level 2 contains an array, CON returns an array of the same dimensions, with each element equal to the constant. If the constant is a complex number, the original array must also be complex.
- If argument 1/level 2 contains a name, the name must identify a variable that contains an array. In this case, the elements of the array are replaced by the constant. If the constant is a complex number, the original array must also be complex.

Access: \leftarrow **MTH** MATRIX MAKE CON (**MTH** is the left-shift of the **SYMB** key).
 \leftarrow **MATRICES** CREATE CON (**MATRICES** is the left-shift of the **5** key).

Input/Output:

| Level 2/Argument 1 | Level 1/Argument 2 | | Level 1/Item 1 |
|--|---------------------------------|---|---|
| { n_{columns} } | $\mathcal{X}_{\text{constant}}$ | → | [<i>vector</i> _{constant}] |
| { n_{rows} m_{columns} } | $\mathcal{X}_{\text{constant}}$ | → | [[<i>matrix</i> _{constant}]] |
| [<i>R-array</i>] | $\mathcal{X}_{\text{constant}}$ | → | [<i>R-array</i> _{constant}] |
| [<i>C-array</i>] | $\mathcal{X}_{\text{constant}}$ | → | [<i>C-array</i> _{constant}] |
| ' <i>name</i> ' | $\mathcal{X}_{\text{constant}}$ | → | |

See also: IDN

COND

Type: Command

Description: Condition Number Command: Returns the 1-norm (column norm) condition number of a square matrix.

The condition number of a matrix is the product of the norm of the matrix and the norm of the inverse of the matrix. COND uses the 1-norm and computes the condition number of the matrix without computing the inverse of the matrix.

The condition number expresses the sensitivity of the problem of solving a system of linear equations having coefficients represented by the elements of the matrix (this includes inverting the matrix). That is, it indicates how much an error in the inputs may be magnified in the outputs of calculations using the matrix.

In many linear algebra computations, the base 10 logarithm of the condition number of the matrix is an estimate of the number of digits of precision that might be lost in computations using that matrix. A reasonable rule of thumb is that the number of digits of accuracy in the result is approximately $\text{MIN}(12, 15 - \log_{10}(\text{COND}))$.

Access: \leftarrow **MTH** MATRIX NORMALIZE COND (**MTH** is the left-shift of the **SYMB** key).
 \leftarrow **MATRICES** OPERATIONS COND (**MATRICES** is the left-shift of the **5** key).

Input/Output:

| Level 1/Argument 1 | | Level 1/Item 1 |
|--|---|--|
| [[<i>matrix</i>]] _{$m \times n$} | → | $\mathcal{X}_{\text{conditionnumber}}$ |

See also: SNRM, SRAD, TRACE

CONIC

Type: Command

Description: Conic Plot Type Command: Sets the plot type to CONIC.

When the plot type is CONIC, the DRAW command plots the current equation as a second-order polynomial of two real variables. The current equation is specified in the reserved variable *EQ*. The plotting parameters are specified in the reserved variable *PPAR*, which has this form:

$$\{ (x_{\min}, y_{\min}) (x_{\max}, y_{\max}) \text{ indep res axes ptype depend} \}$$

For plot type CONIC, the elements of *PPAR* are used as follows:

- (x_{\min}, y_{\min}) is a complex number specifying the lower left corner of *PICT* (the lower left corner of the display range). The default value is $(-6.5, -3.1)$ for the hp48gII and $(-6.5, -3.9)$ for the hp49g+.

- (x_{\max}, y_{\max}) is a complex number specifying the upper right corner of *PICT* (the upper right corner of the display range). The default value is (6.5,3.2) for the hp48gII and (6.5,4.0) for the hp49g+.
- *indep* is a name specifying the independent variable, or a list containing such a name and two numbers specifying the minimum and maximum values for the independent variable (the plotting range). The default value is *X*.
- *res* is a real number specifying the interval (in user-unit coordinates) between plotted values of the independent variable, or a binary integer specifying the interval in pixels. The default value is 0, which specifies an interval of 1 pixel.
- *axes* is a complex number specifying the user-unit coordinates of the intersection of the horizontal and vertical axes, or a list containing such a number and two strings specifying labels for the horizontal and vertical axes. The default value is (0,0).
- *pType* is a command name specifying the plot type. Executing the command CONIC places the command name CONIC in *PPAR*.
- *depend* is a name specifying the dependent variable. The default value is *Y*.

The current equation is used to define a pair of functions of the independent variable. These functions are derived from the second-order Taylor's approximation to the current equation. The minimum and maximum values of the independent variable (the plotting range) can be specified in *indep*; otherwise, the values in (x_{\min}, y_{\min}) and (x_{\max}, y_{\max}) (the display range) are used. Lines are drawn between plotted points unless flag -31 is set.

Access:  CAT CONIC

Input/Output: None

See also: BAR, DIFFEQ, FUNCTION, GRIDMAP, HISTOGRAM, PARAMETRIC, PARSURFACE, PCONTOUR, POLAR, SCATTER, SLOPEFIELD, TRUTH, WIREFRAME, YSLICE

CONJ

Type: Function

Description: Conjugate Analytic Function: Conjugates a complex number or a complex array.

Conjugation is the negation (sign reversal) of the imaginary part of a complex number. For real numbers and real arrays, the conjugate is identical to the original argument.

Access:  CMPLX CONJ (CMPLX is the right-shift of the  key).

Flags: Numerical Results (-3)

Input/Output:

| Level 1/Argument 1 | | Level 1/Item 1 |
|--------------------------|---|--------------------------|
| x | → | x |
| (x, y) | → | $(x, -y)$ |
| [R-array] | → | [R-array] |
| [C-array] ₁ | → | [C-array] ₂ |
| 'symb' | → | 'CONJ(symb)' |

See also: ABS, IM, RE, SCONJ, SIGN

CONLIB

Type: Command

Description: Open Constants Library Command: Opens the Constants Library catalog.

Access:  CONSTANTS LIBRARY

Input/Output: None

See also: CONST

CONST

Type: Function

Description: Constant Value Command: Returns the value of a constant.

CONST returns the value of the specified constant. It chooses the unit type depending on flag -60: SI if clear, English if set, and uses the units depending on flag -61: units if clear, no units if set.

Access:  CAT CONST

Flags: Units Type (60), Units Usage (61)

Input/Output:

| Level 1/Argument 1 | | Level 1/Item 1 |
|--------------------|---|----------------|
| 'name' | → | x |

See also: CONLIB

CONSTANTS

CAS: Display menu or list of CAS symbolic constants.

CONT

Type: Command

Description: Continue Program Execution Command: Resumes execution of a halted program.

Since CONT is a command, it can be assigned to a key or to a custom menu.

Access:  CONT (CONT is the left-shift of the  key).

Input/Output: None

See also: HALT, KILL, PROMPT

CONVERT

Type: Command

Description: Convert Units Command: Converts a source unit object to the dimensions of a target unit.

The source and target units must be compatible. The number part x_2 of the target unit object is ignored.

Access:  CONVERT UNITS TOOLS CONVERT (CONVERT is the left-shift of the  key).

Input/Output:

| Level 2/Argument 1 | Level 1/Argument 2 | | Level 1/Item 1 |
|-----------------------|-----------------------|---|-----------------------|
| $x_1_units_{source}$ | $x_2_units_{target}$ | → | $x_3_units_{target}$ |

See also: UBASE, UFACT, →UNIT, UVAL

CORR

Type: Command

Description: Correlation Command: Returns the correlation coefficient of the independent and dependent data columns in the current statistics matrix (reserved variable ΣDAT).

The columns are specified by the first two elements in the reserved variable ΣPAR , set by XCOL and YCOL, respectively. If ΣPAR does not exist, CORR creates it and sets the elements to their default values (1 and 2).

The correlation is computed with the following formula:

$$\frac{\sum_{i=1}^n (x_{in_1} - \bar{x}_{n_1})(x_{in_2} - \bar{x}_{n_2})}{\sqrt{\sum_{i=1}^n (x_{in_1} - \bar{x}_{n_1})^2 \sum_{i=1}^n (x_{in_2} - \bar{x}_{n_2})^2}}$$

where x_{in_1} is the i th coordinate value in column n_1 , x_{in_2} is the i th coordinate value in the column n_2 , \bar{x}_{n_1} is the mean of the data in column n_1 , \bar{x}_{n_2} is the mean of the data in column n_2 , and n is the number of data points.

Access: $\boxed{\rightarrow}$ $\boxed{\text{CAT}}$ CORR

Input/Output:

| Level 1/Argument 1 | Level 1/Item 1 |
|--------------------|--------------------------|
| | \rightarrow |
| | $r_{\text{correlation}}$ |

See also: COLΣ, COV, PREDX, PREDY, XCOL, YCOL

COS

Type: Analytic Function

Description: Cosine Analytic Function: Returns the cosine of the argument.

For real arguments, the current angle mode determines the number's interpretation as an angle, unless the angular units are specified.

For complex arguments, $\cos(x + jy) = \cos x \cosh y - i \sin x \sinh y$.

If the argument for COS is a unit object, then the specified angular unit overrides the angle mode to determine the result. Integration and differentiation, on the other hand, always observe the angle mode. Therefore, to correctly integrate or differentiate expressions containing COS with a unit object, the angle mode must be set to Radians (since this is a “neutral” mode).

Access: $\boxed{\text{COS}}$

Flags: Numerical Results (-3), Angle Mode (-17, -18)

Input/Output:

| Level 1/Argument 1 | Level 1/Item 1 |
|------------------------------------|--|
| z | \rightarrow COS Z |
| ' <i>symb</i> ' | \rightarrow 'COS(<i>symb</i>)' |
| $x_{\text{unit}_{\text{angular}}}$ | \rightarrow $\cos(x_{\text{unit}_{\text{angular}}})$ |

See also: ACOS, SIN, TAN

COSH

Type: Analytic Function

Description: Hyperbolic Cosine Analytic Function: Returns the hyperbolic cosine of the argument.

For complex arguments, $\cosh(x + jy) = \cosh x \cos y + i \sinh x \sin y$.

Access: $\boxed{\rightarrow}$ $\boxed{\text{TRIG}}$ HYPERBOLIC COSH ($\boxed{\rightarrow}$ $\boxed{\text{TRIG}}$ is the right-shift of the $\boxed{8}$ key).

$\boxed{\leftarrow}$ $\boxed{\text{MTH}}$ HYPERBOLIC COSH ($\boxed{\leftarrow}$ $\boxed{\text{MTH}}$ is the left-shift of the $\boxed{\text{SYMB}}$ key).

Flags: Numerical Results (-3)

Input/Output:

| Level 1/Argument 1 | Level 1/Item 1 |
|--------------------|-------------------------------------|
| z | \rightarrow cosh z |
| ' <i>symb</i> ' | \rightarrow 'COSH(<i>symb</i>)' |

See also: ACOSH, SINH, TANH

COV

Type: Command

Description: Covariance Command: Returns the sample covariance of the independent and dependent data columns in the current statistics matrix (reserved variable ΣDAT).

The columns are specified by the first two elements in reserved variable ΣPAR , set by XCOL and YCOL respectively. If ΣPAR does not exist, COV creates it and sets the elements to their default values (1 and 2).

The covariance is calculated with the following formula:

$$\frac{1}{n-1} \sum_{i=1}^n (x_{in_1} - \bar{x}_{n_1})(x_{in_2} - \bar{x}_{n_2})$$

where x_{in_1} is the i th coordinate value in column n_1 , x_{in_2} is the i th coordinate value in the column n_2 , \bar{x}_{n_1} is the mean of the data in column n_1 , \bar{x}_{n_2} is the mean of the data in column n_2 , and n is the number of data points.

Access:  CAT COV

Input/Output:

| Level 1/Argument 1 | Level 1/Item 1 |
|--------------------|----------------|
| | → |
| | Xcovariance |

See also: COL Σ , CORR, PCOV, PREDX, PREDY, XCOL, YCOL

CR

Type: Command

Description: Carriage Right Command: Prints the contents, if any, of the printer buffer.

CR sends to the printer a string that encodes the line termination method. The default termination method is carriage-return/linefeed. The string is the fourth parameter in the reserved variable $PRTPAR$.

Access:  CAT CR

Flags: I/O Device (-33), Printing Device (-34), Double-Spaced Printing (-37)

Input/Output: None

See also: DELAY, OLDPRN, PRLCD, PRST, PRSTC, PRVAR, PR1

CRDIR

Type: Command

Description: Create Directory Command: Creates an empty subdirectory with the specified name in the current directory.

CRDIR does not change the current directory; evaluate the name of the new subdirectory to make it the current directory.

Access:  PRG MEMORY DIRECTORY CRDIR (PRG is the left-shift of the  key).

Input/Output:

| Level 1/Argument 1 | Level 1/Item 1 |
|--------------------|----------------|
| 'global' | → |

See also: HOME, PATH, PGDIR, UPDIR

CROSS

Type: Command

Description: Cross Product Command: CROSS returns the cross product $C = A \times B$ of vectors A and B.

The arguments must be vectors having two or three elements, and need not have the same number of elements. (The hp49g+/hp48gII automatically converts a two-element argument

[d_1 d_2] to a three-element argument [d_1 d_2 0].)

Access: \leftarrow MTH VECTOR CROSS (\leftarrow MTH is the left-shift of the \square SYMB key).

Input/Output:

| Level 2/Argument 1 | Level 1/Argument 2 | Level 1/Item 1 |
|--------------------|--------------------|---------------------------------------|
| $[vector]_A$ | $[vector]_B$ | $\rightarrow [vector]_{A \times B}$ |

See also: CNRM, DET, DOT, RNRM

CSWP

Type: Command

Description: Column Swap Command: Swaps columns i and j of the argument matrix and returns the modified matrix, or swaps elements i and j of the argument vector and returns the modified vector.

Column numbers are rounded to the nearest integer. Vector arguments are treated as row vectors.

Access: \leftarrow MATRICES CREATE COLUMN CSWP (\leftarrow MATRICES is the left-shift of the \square 5 key).

\leftarrow MTH MATRIX COL CSWP (\leftarrow MTH is the left-shift of the \square SYMB key).

Input/Output:

| Level 3/Argument 1 | Level 2/Argument 2 | Level 1/Argument 3 | Level 1/Item 1 |
|--------------------|--------------------|--------------------|-------------------------------|
| $[[matrix]]_1$ | $n_{columni}$ | $n_{columnj}$ | $\rightarrow [[matrix]]_2$ |
| $[vector]_1$ | $n_{elementi}$ | $n_{elementj}$ | $\rightarrow [vector]_2$ |

See also: COL+, COL-, RSWP

CURL

CAS: Return the curl of a three-dimensional vector function.

CYCLOTOMIC

CAS: Return the cyclotomic polynomial of order n .

CYLIN

Type: Command

Description: Cylindrical Mode Command: Sets Cylindrical coordinate mode.

CYLIN clears flag -15 and sets flag -16.

In Cylindrical mode, vectors are displayed as polar components.

Access: \leftarrow MTH VECTOR \square NXT CYLIN (\leftarrow MTH is the left-shift of the \square SYMB key).

Input/Output: None

See also: RECT, SPHERE

C→PX

Type: Command

Description: Complex to Pixel Command: Converts the specified user-unit coordinates to pixel coordinates.

The user-unit coordinates are derived from the (x_{\min}, y_{\min}) and (x_{\max}, y_{\max}) parameters in the reserved variable $PPAR$.

Access: \leftarrow PRG \square NXT PICT \square NXT C→PX (\leftarrow PRG is the left-shift of the \square EVAL key).

Input/Output:

| Level 1/Argument 1 | Level 1/Item 1 |
|--------------------|------------------------------|
| (x, y) | $\rightarrow \{ \#n, \#m \}$ |

See also: PX→C

C→R

Type: Command

Description: Complex to Real Command: Separates the real and imaginary parts of a complex number or complex array. The result in item 1/level 2 represents the real part of the complex argument. The result in item 2/ level 1 represents the imaginary part of the complex argument.

Access:  PRG TYPE  C→R ( is the left-shift of the  key).

Input/Output:

| Level 1/Argument 1 | | Level 2/Item 1 | Level 1/Item 2 |
|--------------------|---|----------------|----------------|
| (x, y) | → | x | y |
| $[C-array]$ | → | $[R-array]_1$ | $[R-array]_2$ |

See also: R→C, RE, IM

DARCY

Type: Function

Description: Darcy Friction Factor Function: Calculates the Darcy friction factor of certain fluid flows.

DARCY calculates the Fanning friction factor and multiplies it by 4. $x_{e/D}$ is the relative roughness – the ratio of the conduit roughness to its diameter. y_{Re} is the Reynolds number. The function uses different computation routines for laminar flow ($Re \leq 2100$) and turbulent flow ($Re > 2100$). $x_{e/D}$ and y_{Re} must be real numbers or unit objects that reduce to dimensionless numbers, and both numbers must be greater than 0.

Access:  CAT DARCY

Input/Output:

| Level 2/Argument 1 | Level 1/Argument 2 | | Level 1/Item 1 | | |
|--------------------|--------------------|-----|----------------|---|-------------|
| x_e | / | D | y_{Re} | → | x_{Darcy} |



See also: FANNING

DATE

Type: Command

Description: Date Command: Returns the system date.

Access:  TIME TOOLS DATE ( is the right-shift of the  key).

 &  DATE

Flags: Date Format (-42)

Input/Output:

| Level 1/Argument 1 | | Level 1/Item 1 |
|--------------------|---|----------------|
| | → | <i>date</i> |

See also: DATE+, DDAYS, TIME, TSTR

→DATE

Type: Command

Description: Set Date Command: Sets the system date to *date*.

date has the form *MM.DDYYYY* or *DD.MMYYYY*, depending on the state of flag -42. *MM* is month, *DD* is day, and *YYYY* is year. If *YYYY* is not supplied, the current specification for the year is used. The range of allowable dates is January 1, 2000 to December 31, 2090. Inputs between January 1, 1991 and December 31, 1999 are silently rejected by →DATE; no error is reported and the system date is left unchanged.

Access: $\boxed{\rightarrow}$ TIME TOOLS \rightarrow DATE ($\overline{\text{TIME}}$ is the right-shift of the $\boxed{9}$ key).

$\boxed{\rightarrow}$ & $\boxed{9}$ \rightarrow DATE

Flags: Date Format (-42)

Input/Output:

| Level 1/Argument 1 | Level 1/Item 1 |
|--------------------|----------------|
| <i>date</i> | \rightarrow |

See also: \rightarrow TIME

DATE+

Type: Command

Description: Date Addition Command: Returns a past or future date, given a date in argument 1/level 2 and a number of days in argument 2/level 1. If x_{days} is negative, DATE+ calculates a past date. The range of allowable dates is October 15, 1582, to December 31, 9999.

Access: $\boxed{\rightarrow}$ TIME TOOLS $\boxed{\text{NXT}}$ DATE+ ($\overline{\text{TIME}}$ is the right-shift of the $\boxed{9}$ key).

$\boxed{\rightarrow}$ & $\boxed{9}$ $\boxed{\text{NXT}}$ DATE+

Flags: Date Format (-42)

Input/Output:

| Level 2/Argument 1 | Level 1/Argument 2 | Level 1/Item 1 |
|-------------------------|--------------------|---|
| <i>date₁</i> | x_{days} | \rightarrow <i>date_{new}</i> |

See also: DATE, DDAYS

DEBUG

Type: Operation

Description: Debug Operation: Starts program execution, then suspends it as if HALT were the first program command.

DEBUG is programmable.

Access: $\boxed{\rightarrow}$ CAT DEBUG

Input/Output:

| Level 1/Argument 1 | Level 1/Item 1 |
|---|----------------|
| <i>« program »</i> or <i>'program name'</i> | \rightarrow |

See also: HALT, NEXT

DDAYS

Type: Command

Description: Delta Days Command: Returns the number of days between two dates.

If the argument 1/level 2 date is chronologically later than the argument 2/level 1 date, the result is negative. The range of allowable dates is October 15, 1582, to December 31, 9999.

Access: $\boxed{\rightarrow}$ TIME TOOLS $\boxed{\text{NXT}}$ DDAYS ($\overline{\text{TIME}}$ is the right-shift of the $\boxed{9}$ key).

$\boxed{\rightarrow}$ & $\boxed{9}$ $\boxed{\text{NXT}}$ DDAYS

Flags: Date Format (-42)

Input/Output:

| Level 2/Argument 1 | Level 1/Argument 2 | Level 1/Item 1 |
|-------------------------|-------------------------|---------------------------------|
| <i>date₁</i> | <i>date₂</i> | \rightarrow x_{days} |

See also: DATE, DATE+

DEC

Type: Command

Description: Decimal Mode Command: Selects decimal base for binary integer operations. (The default base is decimal.)

Binary integers require the prefix *#*. Binary integers entered and returned in decimal base automatically show the suffix *d*. If the current base is not decimal, then you can enter a decimal number by ending it with *d*. It will be displayed in the current base when it is entered.

The current base does not affect the internal representation of binary integers as unsigned binary numbers.

Access:  MTH BASE DEC (MTH is the left-shift of the  key).

 CONVERT BASE DEC (CONVERT is the left-shift of the  key).

Flags: Binary Integer Wordsize (-5 through -10), Binary Integer Base (-11, -12)

Input/Output: None

See also: BIN, HEX, OCT, RCWS, STWS

DECR

Type: Command

Description: Decrement Command: Takes a variable, subtracts 1, stores the new value back into the original variable, and returns the new value. The contents of *name* must be a real number or an integer.

Access:  PRG MEMORY ARITHMETIC DECR (PRG is the left-shift of the  key).

Input/Output:

| Level 1/Argument 1 | Level 1/Item 1 |
|--------------------|-------------------------|
| 'name' | \rightarrow X_{new} |

See also: INCR, STO+, STO-

DEDICACE

CAS: Display a greeting from the CAS team.

DEF

CAS: Define function or variable; store global variable or store expression as a function to evaluate later.

DEFINE

Type: Command

Description: Define Variable or Function Command: Stores the expression on the right side of the = in the variable specified on the left side, or creates a user-defined function.

If the left side of the equation is *name* only, DEFINE stores *exp* in the variable *name*.

If the left side of the equation is *name* followed by parenthetical arguments *name*₁ ... *name*_n, DEFINE creates a user-defined function and stores it in the variable *name*.

Access:  DEF (DEF is the left-shift of the  key).

Flags: Numerical Results (-3)

Input/Output:

| Level 1/Argument 1 | Level 1/Item 1 |
|--|----------------|
| 'name=exp' | \rightarrow |
| 'name(name ₁ ... name _n)=exp(name ₁ ... name _n)' | \rightarrow |

See also: DEF, STO, UNASSIGN

DEG

Type: Command

Description: Degrees Command: Sets Degrees angle mode.

DEG clears flags -17 and -18 , and displays the DEG annunciator.

In Degrees angle mode, real-number arguments that represent angles are interpreted as degrees, and real-number results that represent angles are expressed in degrees.

Access: \leftarrow & MODE ANGLE DEG

\leftarrow PRG \leftarrow NEXT MODES ANGLE DEG (\leftarrow PRG is the left-shift of the EVAL key).

Input/Output: None

See also: GRAD, RAD

DEGREE

CAS: Return the degree of a polynomial expression, or -1 if expression is zero.

DELALARM

Type: Command

Description: Delete Alarm Command: Deletes the specified alarm.

If n_{index} is 0, all alarms in the system alarm list are deleted.

Access: \leftarrow TIME TOOLS ALRM DELALARM (\leftarrow TIME is the right-shift of the 9 key).

\leftarrow & 9 ALRM DELALARM

Input/Output:

| Level 1/Argument 1 | Level 1/Item 1 |
|--------------------|----------------|
| n_{index} | \rightarrow |

See also: FINDALARM, RCLALARM, STOALARM

DELAY

Type: Command

Description: Delay Command: Specifies how many seconds the hp49g+/hp48gII waits between sending lines of information to the printer.

x_{delay} specifies the delay time in seconds. The default delay is 0 seconds. The maximum delay is 6.9 seconds. (The sign of x_{delay} is ignored, so -4 DELAY is equivalent to 4 DELAY.)

The delay setting is the first parameter in the reserved variable *PRTPAR*.

A shorter delay setting can be useful when the hp49g+/hp48gII sends multiple lines of information to your printer (for example, when printing a program). To optimize printing efficiency, set the delay just longer than the time the printhead requires to print one line of information. If you set the delay *shorter* than the time to print one line, you may lose information.

Access: \leftarrow CAT DELAY

Flags: I/O Device (-33), Printing Device (-34)

Input/Output:

| Level 1/Argument 1 | Level 1/Item 1 |
|--------------------|----------------|
| x_{delay} | \rightarrow |

See also: CR, OLDPRN, PRLCD, PRST, PRSTC, PRVAR, PR1

DELKEYS

Type: Command

Description: Delete Key Assignments Command: Clears user-defined key assignments.

The argument x_{key} is a real number $r.p$ specifying the key by its r ow number, its c olumn number, and its p lane (shift). For a definition of plane, see ASN.

Specifying 0 for X_{key} clears *all* user key assignments and restores the standard key assignments. Specifying S as the argument for DELKEYS suppresses all standard key assignments on the user keyboard. This makes keys without user key assignments inactive on the user keyboard. (You can make exceptions using ASN, or restore them all using STOKEYS.) If you are stuck in User mode – probably with a “locked” keyboard – because you have reassigned or suppressed the keys necessary to cancel User mode, do a system halt (“warm start”): press and hold **ON** and **F3** simultaneously, releasing **F3** first. This cancels User mode. Deleted user key assignments still take up from 2.5 to 62.5 bytes of memory each. You can free this memory by packing your user key assignments by executing RCLKEYS 0 DELKEYS STOKEYS.

Access: **←** & **MODE** KEYS DELKEYS

← **PRG** **NXT** MODES KEYS DELKEYS (**PRG** is the left-shift of the **EVAL** key).

Flags: User-Mode Lock (-61) and User Mode (-62) affect the status of the user keyboard.

Input/Output:

| Level 1/Argument 1 | Level 1/Item 1 |
|----------------------------------|----------------|
| X_{key} | → |
| { $X_{key1}, \dots, X_{key n}$ } | → |
| 0 | → |
| 'S' | → |

See also: ASN, RCLKEYS, STOKEYS

DEPND

Type: Command

Description: Dependent Variable Command: Specifies the dependent variable (and its plotting range for TRUTH plots).

The specification for the dependent variable name and its plotting range is stored in the reserved variable *PPAR* as follows:

- If the argument is a global variable name, that name replaces the dependent variable entry in *PPAR*.
- If the argument is a list containing a global name, that name replaces the dependent variable name but leaves unchanged any existing plotting range.
- If the argument is a list containing a global name and two real numbers, or a list containing a name, array, and real number, that list replaces the dependent variable entry.
- If the argument is a list containing two real numbers, or two real numbers from levels 1 and 2, those two numbers specify a new plotting range, leaving the dependent variable name unchanged. (LASTARG returns a list, even if the two numbers were entered separately.)

The default entry is Y.

The plotting range for the dependent variable is meaningful only for plot type TRUTH, where it restricts the region for which the equation is tested, and for plot type DIFFEQ, where it specifies the initial solution value and absolute error tolerance.

Access: **→** **CAT** DEPND

Input/Output:

| Level 2/Argument 1 | Level 1/Argument 2 | Level 1/Item 1 |
|--------------------|-------------------------------------|----------------|
| | 'global' | → |
| | { global } | → |
| | { global, y_{start} , y_{end} } | → |
| | { y_{start} , y_{end} } | → |
| y_{start} | y_{end} | → |

See also: INDEP

DEPTH

Type: RPL Command

Description: Depth Command: Returns a real number representing the number of objects present on the stack (before DEPTH was executed).

Access: \leftarrow PRG STACK \leftarrow DEPTH (PRG is the left-shift of the EVAL key).
 \leftarrow TOOL STACK \leftarrow DEPTH

Input/Output:

| Level n...Level 1 | Level 1 |
|-------------------|------------------|
| | \rightarrow // |

See also: CLEAR, DROPN

DERIV

CAS: Return the partial derivatives of a function, with respect to specified variables.

DERVX

CAS: Return the derivative of a function with respect to the current variable.

DESOLVE

CAS: Solve first-order ordinary differential equations with respect to the current variable.

DET

Type: Command

Description: Determinant Function: Returns the determinant of a square matrix.

The argument matrix must be square. DET computes the determinant of 1×1 and 2×2 matrices directly from the defining expression for the determinant. DET computes the determinant of a larger matrix by computing the Crout LU decomposition of the matrix and accumulating the product of the decomposition's diagonal elements.

Since floating-point division is used to do this, the computed determinant of an integer matrix is often not an integer, even though the actual determinant of an integer matrix must be an integer. DET corrects this by rounding the computed determinant to an integer value. This technique is also used for noninteger matrices with determinants having fewer than 15 nonzero digits: the computed determinant is rounded at the appropriate digit position to restore some or all of the accuracy lost to floating-point arithmetic.

This refining technique can cause the computed determinant to exhibit discontinuity. To avoid this, you can disable the refinement by setting flag -54.

Access: \leftarrow MATRICES OPERATIONS DET (MATRICES is the left-shift of the 5 key).
 \leftarrow MTH NORMALIZE DET (MTH is the left-shift of the SYMB key).

Flags: Tiny Element (-54)

Input/Output:

| Level 1/Argument 1 | Level 1/Item 1 |
|-----------------------|--|
| $[[\text{matrix}]]$ | \rightarrow $X_{\text{determinant}}$ |

See also: CNRM, CROSS, DOT, RNRM

DETACH

Type: Command

Description: Detach Library Command: Detaches the library with the specified number from the current directory. Each library has a unique number. If a port number is specified, it is ignored.

A library object attached to a non-*HOME* directory is *automatically* detached (without using DETACH) whenever a new library object is attached there.

Access: \leftarrow \leftarrow CAT DETACH

Input/Output:

| Level 1/Argument 1 | Level 1/Item 1 |
|--|----------------|
| $\mathcal{N}_{library}$ | \rightarrow |
| $\mathcal{N}_{port} \mathcal{N}_{library}$ | \rightarrow |

See also: ATTACH, LIBS, PURGE

DIAG \rightarrow

Type: Command

Description: Vector to Matrix Diagonal Command: Takes an array and a specified dimension and returns a matrix whose major diagonal elements are the elements of the array.

Real number dimensions are rounded to integers. If a single dimension is given, a square matrix is returned. If two dimensions are given, the proper order is { *number of rows, number of columns* }. No more than two dimensions can be specified.

If the main diagonal of the resulting matrix has more elements than the array, additional diagonal elements are set to zero. If the main diagonal of the resulting matrix has fewer elements than the array, extra array elements are dropped.

Access: \leftarrow MATRICES CREATE \leftarrow NXT DIAG \rightarrow (\leftarrow MATRICES is the left-shift of the \leftarrow 5 key).
 \leftarrow MTH MATRIX \leftarrow NXT DIAG \rightarrow (\leftarrow MTH is the left-shift of the \leftarrow SYMB key).
 \leftarrow MTH MATRIX MAKE \leftarrow NXT \leftarrow NXT DIAG \rightarrow (\leftarrow MTH is the left-shift of the \leftarrow SYMB key).

Input/Output:

| Level 2/Argument 1 | Level 1/Argument 2 | Level 1/Item 1 |
|-----------------------|--------------------|----------------------------|
| $[array]_{diagonals}$ | { <i>dim</i> } | \rightarrow $[[matrix]]$ |

See also: \rightarrow DIAG

\rightarrow DIAG

Type: Command

Description: Matrix Diagonal to Array Command: Returns a vector that contains the major diagonal elements of a matrix.

The input matrix does not have to be square.

Access: \leftarrow MATRICES CREATE \rightarrow DIAG (\leftarrow MATRICES is the left-shift of the \leftarrow 5 key).
 \leftarrow MTH MATRIX \leftarrow NXT \rightarrow DIAG (\leftarrow MTH is the left-shift of the \leftarrow SYMB key).
 \leftarrow MTH MATRIX MAKE \leftarrow NXT \leftarrow NXT \rightarrow DIAG (\leftarrow MTH is the left-shift of the \leftarrow SYMB key).

Input/Output:

| Level 1/Argument 1 | Level 1/Item 1 |
|--------------------|--------------------------------------|
| $[[matrix]]$ | \rightarrow $[vector]_{diagonals}$ |

See also: DIAG \rightarrow

DIAGMAP

CAS: Apply an holomorphic operator to a diagonalizable matrix.

DIFF

CAS: Display a menu or list of CAS commands for differential calculus, including series.

DIFFEQ

Type: Command

Description: Differential Equation Plot Type Command: Sets the plot type to DIFFEQ.

When the plot type is DIFFEQ and the reserved variable EQ does not contain a list, the initial value problem is solved and plotted over an interval using the Runge–Kutta–Fehlberg (4,5) method. The plotting parameters are specified in the reserved variable $PPAR$, which has the following form:

$$\{ (x_{\min}, y_{\min}) (x_{\max}, y_{\max}) \text{ indep res axes ptype depend} \}$$

For plot type DIFFEQ, the elements of $PPAR$ are used as follows:

- (x_{\min}, y_{\min}) is a complex number specifying the lower left corner of PICT (the lower left corner of the display range). The default value is $(-6.5, -3.1)$ for the hp48gII and $(-6.5, -3.9)$ for the hp49g+.
- (x_{\max}, y_{\max}) is a complex number specifying the upper right corner of PICT (the upper right corner of the display range). The default value is $(6.5, 3.2)$ for the hp48gII and $(6.5, 4.0)$ for the hp49g+.
- *indep* is a list, $\{ X \ x_0 \ x_f \}$, containing a name that specifies the independent variable, and two numbers that specify the initial and final values for the independent variable. The default values for these elements are $\{ X \ 0 \ x_{\max} \}$.
- *res* is a real number specifying the maximum interval, in user-unit coordinates, between values of the independent variable. The default value is 0. If *res* does not equal zero, then the maximum interval is *res*. If *res* equals zero, the maximum interval is unlimited.
- *axes* is a list containing one or more of the following, in the order listed: a complex number specifying the user-unit coordinates of the plot origin, a list specifying the tick-mark annotation, and two strings specifying labels for the horizontal and vertical axes. If the solution is real-valued, these strings can specify the dependent or the independent variable; if the solution is vector valued, the strings can specify a solution component:
 - 0 specifies the dependent variable (X)
 - 1 specifies the dependent variable (Y)
 - n specifies a solution component Y_n
 - If *axes* contains any strings other than 0, 1 or n , the DIFFEQ plotter uses the default strings 0 and 1, and plots the independent variable on the horizontal axis and the dependent variable on the vertical.
- *ptype* is a command name specifying the plot type. Executing the command DIFFEQ places the command name DIFFEQ in $PPAR$.
- *depend* is a list, $\{ Y \ y_0 \ x_{ErrTol} \}$, containing a name that specifies the dependent variable (the solution), and two numbers that specify the initial value of Y and the global absolute error tolerance in the solution Y . The default values for these elements are $\{ Y \ 0 \ .0001 \}$

EQ must define the right-hand side of the initial value problem $Y'(XF(X,Y))$. Y can return a real value or real vector when evaluated.

The DIFFEQ-plotter attempts to make the interval between values of the independent variable as large as possible, while keeping the computed solution within the specified error tolerance x_{ErrTol} . This tolerance may hold only at the computed points. Straight lines are drawn between computed step endpoints, and these lines may not accurately represent the actual shape of the solution. *res* limits the maximum interval size to provide higher plot resolution.

On exit from DIFFEQ plot, the first elements of *indep* and *depend* (identifiers) contain the final values of X and Y , respectively.

If EQ contains a list, the initial value problem is solved and plotted using a combination of Rosenbrock (3,4) and Runge-Kutta-Fehlberg (4,5) methods. In this case DIFFEQ uses RRKSTEP to calculate y_j , and EQ must contain two additional elements:

- The second element of EQ must evaluate to the partial derivative of Y' with respect to X , and can return a real value or real vector when evaluated.
- The third element of EQ must evaluate to the partial derivative of Y' with respect to Y , and can return a real value or a real matrix when evaluated.

Access:  $\underline{\text{CAT}}$ DIFFEQ

Input/Output: None

See also: AXES, CONIC, FUNCTION, PARAMETRIC, POLAR, RKFSTEP, RRKSTEP, TRUTH

DIR

Type: Function

Description: Creates an empty directory structure in run mode. Can be used as an alternative to CRDIR to create an empty directory by typing DIR 'NAME' STO, which will create an empty directory 'NAME' if it does not already exist in the current directory.

Access:  $\underline{\text{CAT}}$ DIR

Input/Output:

| Level 1/Argument 1 | Level 1/Item 1 |
|--------------------|----------------|
| | → DIR ...END |

See also: CRDIR

DISP

Type: Command

Description: Display Command: Displays obj in the n th display line.

$n \leq 1$ indicates the top line of the display.

To facilitate the display of messages, strings are displayed without the surrounding " " delimiters. All other objects are displayed in the same form as would be used if the object were in level 1 in the multiline display format. If the object display requires more than one display line, the display starts in line n , and continues down the display either to the end of the object or the bottom of the display. The object displayed by DISP persists in the display only until the keyboard is ready for input. The FREEZE command can be used to cause the object to persist in the display until a key is pressed.

Access:  $\underline{\text{PRG}}$  OUT DISP ($\underline{\text{PRG}}$ is the left-shift of the  key).

Input/Output:

| Level 2/Argument 1 | Level 1/Argument 2 | Level 1/Item 1 |
|--------------------|--------------------|----------------|
| obj | n | → |

See also: DISPXY, FREEZE, HALT, INPUT, PROMPT

DISPXY

Type: Command

Description: Display Command: Displays obj at the specified screen coordinates using a specified font size. The list argument expects exactly two binary integers to specify the X and Y coordinates. The level one integer argument n will display the obj using a small font if n is 1 and using the system font if n is 2.

To facilitate the display of messages, strings are displayed without the surrounding " " delimiters. All other objects are displayed in the same form as would be used if the object were in level 1 in

the multiline display format. If the object display requires more than one display line, the display starts at coordinate #x #y, and continues down the display either to the end of the object or the bottom of the display. NOTE: DISPXY is not useful for displaying GROBs.

The object displayed by DISPXY persists in the display only until the keyboard is ready for input. The FREEZE command can be used to cause the object to persist in the display until a key is pressed.

Access: \leftarrow PRG \leftarrow NXT OUT DISPXY (\leftarrow PRG is the left-shift of the \leftarrow EVAL key).

Input/Output:

| Level 3/Argument 1 | Level 2/Argument 2 | Level 1/Argument 3 | Level 1/Item 1 |
|--------------------|--------------------|--------------------|----------------|
| <i>obj</i> | { <i>list</i> } | <i>n</i> | → |

See also: DISP, FREEZE, HALT, INPUT, PROMPT

DISTRIB

CAS: Apply one step of the distributive property of multiplication and division.

DIV

CAS: Return the divergence of a vector function.

DIV2

CAS: Perform Euclidean division on two expressions.

DIV2MOD

CAS: Perform euclidean division on two expressions modulo the current modulus.

DIVIS

CAS: Return a list of divisors of a polynomial or an integer.

DIVMOD

CAS: Divide two expressions modulo the current modulus.

DIVPC

CAS: Return a Taylor polynomial for the quotient of two polynomial expressions.

dn

CAS: Differential of a function with respect to its argument *n*, an alternative to the ∂ function.

DO

Type: Command

Description: DO Indefinite Loop Structure Command: Starts DO...UNTIL...END indefinite loop structure.

DO ... UNTIL ... END executes a loop repeatedly until a test returns a true (nonzero) result. Since the test clause is executed after the loop clause, the loop is always executed at least once. The syntax is: DO *loop-clause* UNTIL *test-clause* END

DO starts execution of the loop clause. UNTIL ends the loop clause and begins the test clause.

The test clause must return a test result to the stack. END removes the test result from the stack.

If its value is zero, the loop clause is executed again; otherwise execution resumes following END.

Access: \leftarrow PRG \leftarrow BRANCH DO (\leftarrow PRG is the left-shift of the \leftarrow EVAL key).

Input/Output:

| Level 1/Argument 1 | Level 1/Item 1 |
|--------------------|----------------|
| DO | → |
| UNTIL | → |
| END | T/F → |

See also: END, UNTIL, WHILE

DOERR

Type: Command

Description: Do Error Command: Executes a “user-specified” error, causing a program to behave exactly as if a normal error had occurred during program execution.

DOERR causes a program to behave exactly as if a normal error has occurred during program execution. The error message depends on the argument provided to DOERR:

- n_{error} or $\#n_{\text{error}}$ display the corresponding built-in error message.
- "error" displays the contents of the string. (A subsequent execution of ERRM returns "error". ERRN returns # 70000h.)
- 0 abandons program execution with an ‘interrupted’ error message (ERRN = #13Fh).
- 0 DOERR is equivalent to pressing $\overline{\text{CANCEL}}$.

Access: \leftarrow PRG \leftarrow NXT \leftarrow NXT ERROR DOERR (\leftarrow PRG is the left-shift of the \leftarrow EVAL key).

Input/Output:

| Level 1/Argument 1 | Level 1/Item 1 |
|----------------------|----------------|
| n_{error} | → |
| $\#n_{\text{error}}$ | → |
| "error" | → |
| 0 | → |

See also: ERRM, ERRN, ERR0

DOLIST

Type: Command

Description: Do to List Command: Applies commands, programs, or user-defined functions to lists.

The number of lists, n , can be omitted when the first or level 1 argument is any of the following:

- A command.
- A program containing exactly one command (e.g. « DUP »)
- A program conforming to the structure of a user-defined function.

The final argument 1 (or level 1 object) can be a local or global name that refers to a program or command.

All lists must be the same length l . The program is executed l times: on the i th iteration, n objects each taken from the i th position in each list are entered on the stack in the same order as in their original lists, and the program is executed. The results from each execution are left on the stack. After the final iteration, any new results are combined into a single list.

Access: \leftarrow PRG \leftarrow LIST PROCEDURES DOLIST (\leftarrow PRG is the left-shift of the \leftarrow EVAL key).

Input/Output:

| $L_{n+2}/A_1 \dots L_3/A_{n-2}$ | L_2/A_{n+1} | L_1/A_{n+2} | Level 1/Item 1 |
|-----------------------------------|--------------------|---------------|----------------|
| $\{ list \}_1 \dots \{ list \}_n$ | n | « program » | → { results } |
| $\{ list \}_1 \dots \{ list \}_n$ | n | command | → { results } |
| $\{ list \}_1 \dots \{ list \}_n$ | n | name | → { results } |
| $\{ list \}_1 \dots$ | $\{ list \}_{n+1}$ | « program » | → { results } |
| $\{ list \}_1 \dots$ | $\{ list \}_{n+1}$ | command | → { results } |
| $\{ list \}_1 \dots$ | $\{ list \}_{n+1}$ | name | → { results } |

L = Level; A = Argument

See also: DOSUBS, ENDSUB, NSUB, STREAM

DOMAIN

CAS: List the domain of real numbers for which a function is defined.

DOSUBS

Type: Command

Description: Do to Sublist Command: Applies a program or command to groups of elements in a list.

The real number n can be omitted when the first argument is one of the following:

- A command.
- A user program containing a single command.
- A program with a user-defined function structure.
- A global or local name that refers to one of the above.

The first iteration uses elements 1 through n from the list; the second iteration uses elements 2 through $n + 1$; and so on. In general, the m^{th} iteration uses the elements from the list corresponding to positions m through $m + n - 1$.

During an iteration, the position of the first element used in that iteration is available to the user using the command NSUB, and the number of groups of elements is available using the command ENDSUB. Both of these commands return an Undefined Local Name error if executed when DOSUBS is not active.

DOSUBS returns the Invalid User Function error if the object at level 1/argument 3 is a user program that does not contain only one command and does not have a user-defined function structure. DOSUBS also returns the Wrong Argument Count error if the object at level 1/argument 3 is a command that does not accept 1 to 5 arguments of specific types (DUP, ROT, or →LIST, for example).

Access: \leftarrow PRG LIST PROCEDURES DOSUBS (\leftarrow PRG is the left-shift of the \leftarrow EVAL key).

Input/Output:

| Level 3/Argument 1 | Level 2/Argument 2 | Level 1/Argument 3 | | Level 1/Item 1 |
|-----------------------|-----------------------|--------------------|---|-----------------------|
| { list } ₁ | n | « program » | → | { list } ₂ |
| { list } ₁ | n | command | → | { list } ₂ |
| { list } ₁ | n | name | → | { list } ₂ |
| | { list } ₁ | « program » | → | { list } ₂ |
| | { list } ₁ | command | → | { list } ₂ |
| | { list } ₁ | name | → | { list } ₂ |

See also: DOLIST, ENDSUB, NSUB, STREAM

DOT

Type: Command

Description: Dot Product Command: Returns the dot product $A \bullet B$ of two arrays A and B, calculated as the sum of the products of the corresponding elements of the two arrays.

Both arrays must have the same dimensions.

Some authorities define the dot product of two complex arrays as the sum of the products of the conjugated elements of one array with their corresponding elements from the other array. The hp49g+/hp48gII uses the ordinary products without conjugation. If you prefer the alternative definition, apply CONJ to one array before using DOT.

Access: \leftarrow MATRICES \leftarrow NXT VECTOR DOT (\leftarrow MATRICES is the left-shift of the \leftarrow 5 key).

\leftarrow MTH VECTOR DOT (\leftarrow MTH is the left-shift of the \leftarrow SYMB key).

Input/Output:

| Level 2/Argument 1 | Level 1/Argument 2 | | Level 1/Item 1 |
|--------------------|--------------------|---|----------------|
| [array A] | [array B] | → | x |

See also: CNRM, CROSS, DET, RNRM

DRAW

Type: Command Operation

Description: Draw Plot Command: Plots the mathematical data in the reserved variable EQ or the statistical data in the reserved variable ΣDAT , using the specified x - and y -axis display ranges.

The plot type determines if the data in the reserved variable EQ or the data in the reserved variable ΣDAT is plotted.

DRAW does not erase $PICT$ before plotting; execute ERASE to do so. DRAW does not draw axes; execute DRAX to do so.

When DRAW is executed from a program, the graphics display, which shows the resultant plot, does not persist unless PICTURE, PVIEW (with an empty list argument), or FREEZE is subsequently executed.

Access:  CAT DRAW

Flags: Simultaneous or Sequential Plot (-28), Curve Filling (-31)

Input/Output: None

See also: AUTO, AXES, DRAX, ERASE, FREEZE, PICTURE, LABEL, PVIEW

DRAW3DMATRIX



Type: Command



Description: Draws a 3D plot from the values in a specified matrix.

The number of rows indicates the number of units along the x axis, the number of columns indicates the number of units along the y axis, and the values in the matrix give the magnitudes of the plotted points along the z axis. In other words, the coordinates of a plotted point are (r, c, v) where r is the row number, c the column number and v the value in the corresponding cell of the matrix.

You can limit the points that are plotted by specifying a minimum value (v_{\min}) and a maximum value (v_{\max}). Values in the matrix outside this range are not plotted. If all values are included, the total number of points plotted is $r \times c$.

Once the plot has been drawn, you can rotate it in various ways by pressing the following keys:

 and  rotate the plot around the x axis (in different directions)

 and  rotate the plot around the y axis (in different directions)

 and  rotate the plot around the z axis (in different directions)

Access:  CAT DRAW3DMATRIX

Input/Output:

| Level 3/Argument 1 | Level 2/Argument 2 | Level 1/Argument 3 | Level 1/Item 1 |
|--------------------|--------------------|--------------------|----------------|
| [[matrix]] | v_{\min} | v_{\max} | → |

See also: FAST3D

DRAX

Type: Command

Description: Draw Axes Command: Draws axes in $PICT$.

The coordinates of the axes intersection are specified by AXES. Axes tick-marks are specified in PPAR with the ATICK, or AXES command. DRAX does not draw axes labels; execute LABEL to do so.

Access: $\boxed{\rightarrow}$ $\boxed{_}$ $\boxed{\text{CAT}}$ DRAX

Input/Output: None

See also: AXES, DRAW, LABEL

DROITE

CAS: Return an equation for the line through two given points in a plane.

DROP

Type: RPL Command

Description: Drop Object Command: Removes the level 1 object from the stack.

Access: $\boxed{\leftarrow}$ $\boxed{\text{PRG}}$ STACK DROP ($\boxed{\text{PRG}}$ is the left-shift of the $\boxed{\text{EVAL}}$ key).

$\boxed{\text{TOOL}}$ STACK DROP

$\boxed{\leftarrow}$ in RPN mode executes DROP when no command line is present.

Input/Output:

| Level 1 | Level 1 |
|------------|---------------|
| <i>obj</i> | \rightarrow |

See also: CLEAR, DROPN, DROP2

DROP2

Type: RPL Command

Description: Drop 2 Objects Command: Removes the first two objects from the stack.

Access: $\boxed{\leftarrow}$ $\boxed{\text{PRG}}$ STACK $\boxed{\text{NXT}}$ $\boxed{\text{NXT}}$ DROP2 ($\boxed{\text{PRG}}$ is the left-shift of the $\boxed{\text{EVAL}}$ key).

$\boxed{\text{TOOL}}$ STACK $\boxed{\text{NXT}}$ $\boxed{\text{NXT}}$ DROP2

Input/Output:

| Level 2 | Level 1 | Level 1 |
|------------------------|------------------------|---------------|
| <i>obj₁</i> | <i>obj₂</i> | \rightarrow |

See also: CLEAR, DROP, DROPN

DROPN

Type: RPL Command

Description: Drop n Objects Command: Removes the first $n + 1$ objects from the stack (the first n objects excluding the integer n itself).

Access: $\boxed{\leftarrow}$ $\boxed{\text{PRG}}$ STACK $\boxed{\text{NXT}}$ $\boxed{\text{NXT}}$ DROPN ($\boxed{\text{PRG}}$ is the left-shift of the $\boxed{\text{EVAL}}$ key).

$\boxed{\text{TOOL}}$ STACK $\boxed{\text{NXT}}$ $\boxed{\text{NXT}}$ DROPN

Input/Output:

| Level _{n+1} ... Level 2 | Level 1 | Level 1 |
|--|----------|---------------|
| <i>obj₁ ... obj_n</i> | <i>n</i> | \rightarrow |

See also: CLEAR, DROP, DROP2

DTAG

Type: Command

Description: Delete Tag Command: DTAG removes all tags (labels) from an object.

The leading colon is not shown for readability when the tagged object is on the stack.

DTAG has no effect on an untagged object.

Access: \leftarrow PRG TYPE $\boxed{\text{NXT}}$ DTAG (\leftarrow PRG is the left-shift of the $\boxed{\text{EVAL}}$ key).

Input/Output:

| Level 1/Argument 1 | | Level 1/Item 1 |
|--------------------|---|----------------|
| <i>tag:obj</i> | → | <i>obj</i> |

See also: LIST→, →TAG

DUP

Type: RPL Command

Description: Duplicate Object Command: DUP returns a copy of the argument (or the object on level 1).

Access: \leftarrow PRG STACK DUP (\leftarrow PRG is the left-shift of the $\boxed{\text{EVAL}}$ key).

$\boxed{\text{TOOL}}$ STACK DUP

$\boxed{\text{ENTER}}$ in RPN mode executes DUP when no command line is present.

Input/Output:

| Level 1 | | Level 2 | Level 1 |
|------------|---|------------|------------|
| <i>obj</i> | → | <i>obj</i> | <i>obj</i> |

See also: DUPN, DUP2, PICK

DUP2

Type: RPL Command

Description: Duplicate 2 Objects Command: DUP2 returns copies of the two objects on levels 1 and 2 of the stack.

Access: \leftarrow PRG STACK $\boxed{\text{NXT}}$ $\boxed{\text{NXT}}$ DUP2 (\leftarrow PRG is the left-shift of the $\boxed{\text{EVAL}}$ key).

$\boxed{\text{TOOL}}$ STACK $\boxed{\text{NXT}}$ $\boxed{\text{NXT}}$ DUP2

Input/Output:

| L ₂ | L ₁ | | L ₄ | L ₃ | L ₂ | L ₁ |
|------------------------|------------------------|---|------------------------|------------------------|------------------------|------------------------|
| <i>obj₂</i> | <i>obj₁</i> | → | <i>obj₂</i> | <i>obj₁</i> | <i>obj₂</i> | <i>obj₁</i> |

L = Level

See also: DUP, DUPN, PICK

DUPDUP

Type: RPL Command

Description: Duplicates an object twice.

Access: \leftarrow PRG STACK $\boxed{\text{NXT}}$ $\boxed{\text{NXT}}$ DUPDUP (\leftarrow PRG is the left-shift of the $\boxed{\text{EVAL}}$ key).

$\boxed{\text{TOOL}}$ STACK $\boxed{\text{NXT}}$ $\boxed{\text{NXT}}$ DUPDUP

Input/Output:

| Level 1 | | Level 3 | Level 2 | Level 1 |
|------------|---|------------|------------|------------|
| <i>obj</i> | → | <i>obj</i> | <i>obj</i> | <i>obj</i> |

See also: DUP, NDUPN, DUPN, DUP2

DUPN

Type: RPL Command

Description: Duplicate n Objects Command: Takes an integer *n* from level 1 of the stack, and returns copies of the objects on stack levels 2 through *n* + 1.

Access: \leftarrow PRG $\overline{\text{STACK}}$ $\overline{\text{NXT}}$ $\overline{\text{NXT}}$ DUPN ($\overline{\text{PRG}}$ is the left-shift of the $\overline{\text{EVAL}}$ key).
 $\overline{\text{TOOL}}$ $\overline{\text{STACK}}$ $\overline{\text{NXT}}$ $\overline{\text{NXT}}$ DUPN

Input/Output:

| | | | | | | | |
|-----------|-------------------------|---------|-------|---------------|-----------|-------------------------|---------|
| L_{i+1} | $L_i \dots L_3$ | L_2 | L_1 | \rightarrow | L_{i+n} | $L_{i+n-1} \dots L_2$ | L_1 |
| obj_1 | $obj_2 \dots obj_{i-1}$ | obj_i | n | \rightarrow | obj_1 | $obj_2 \dots obj_{i-1}$ | obj_i |

L = Level

See also: DUP, DUP2, PICK

D→R

Type: Function

Description: Degrees to Radians Function: Converts a real number representing an angle in degrees to its equivalent in radians.

This function operates independently of the angle mode.

Access: \leftarrow MTH $\overline{\text{REAL}}$ $\overline{\text{NXT}}$ $\overline{\text{NXT}}$ D→R ($\overline{\text{MTH}}$ is the left-shift of the $\overline{\text{SYMB}}$ key).

Flags: Numerical Results (-3)

Input/Output:

| Level 1/Argument 1 | | Level 1/Item 1 |
|--------------------|---------------|----------------------|
| x | \rightarrow | $(\pi/180)x$ |
| ' <i>symb</i> ' | \rightarrow | 'D→R(<i>symb</i>)' |

See also: R→D

e

Type: Function

Description: e Function: Returns the symbolic constant e or its numerical representation, 2.71828182846.

The number returned for e is the closest approximation to 12-digit accuracy. For exponentiation, use the expression EXP(x) rather than e^x , since the function EXP uses a special algorithm to compute the exponential to greater accuracy. Even though the calculator often *displays* EXP(x) as e^x , it's still 'EXP(x)' internally.

Access: ALPHA \leftarrow E

\leftarrow MTH $\overline{\text{CONSTANTS}}$ e ($\overline{\text{MTH}}$ is the left-shift of the $\overline{\text{SYMB}}$ key).

\leftarrow MTH $\overline{\text{CONSTANTS}}$ 2.718281828... ($\overline{\text{MTH}}$ is the left-shift of the $\overline{\text{SYMB}}$ key).

Flags: Symbolic Constants (-2), Numerical Results (-3)

Input/Output:

| Level 1/Argument 1 | | Level 1/Item 1 |
|--------------------|---------------|----------------|
| | \rightarrow | ' e ' |
| | \rightarrow | 2.71828182846 |

See also: EXP, EXPM, i , LN, LNP1, MAXR, MINR, π

EDIT

Type: Command

Description: Edit Command: Moves specified object to the command line where it can be edited.

Access: \leftarrow ∇

$\overline{\text{TOOL}}$ \leftarrow EDIT

Input/Output: None

See also: EDITB, VISIT

EDITB

Type: Command

Description: Edit Best Command: Opens the specified object in the most suitable editor. For example, if you use a matrix as the specified object, the command opens it in Matrix Writer.

Access: 
 EDIT

Input/Output: None

See also: EDIT, VISIT

EGCD

CAS: From polynomials a and b , returns polynomials u , v , and c , where $au+bv=c$, c is the GCD of a & b .

EGV

Type: Command

Description: Eigenvalues and Eigenvectors Command: Computes the eigenvalues and right eigenvectors for a square matrix.

The resulting vector $EVAl$ contains the computed eigenvalues. The columns of matrix $EVec$ contain the right eigenvectors corresponding to the elements of vector $EVAl$.

The computed results should minimize (within computational precision):

$$\frac{|A \cdot EVec - EVec \cdot \text{diag}(EVAl)|}{n \cdot |A|}$$

where $\text{diag}(EVAl)$ denotes the $n \times n$ diagonal matrix containing the eigenvalues $EVAl$.

Access:    EIGENVECTOR EGV ( is the left-shift of the  key).
  MATRIX  EGV ( is the left-shift of the  key).

Input/Output:

| Level 1/Argument 1 | | Level 2/Item 1 | Level 1/Item 2 |
|--------------------|---|---------------------|-------------------|
| $[[matrix]]_A$ | → | $[[matrix]]_{EVec}$ | $[vector]_{EVAl}$ |









See also: EGVL

EGVL

Type: Command

Description: Eigenvalues Command: Computes the eigenvalues of a square matrix.

The resulting vector L contains the computed eigenvalues.

Access:    EIGENVECTOR EGVL ( is the left-shift of the  key).
  MATRIX  EGVL ( is the left-shift of the  key).

Input/Output:

| Level 1/Argument 1 | | Level 1/Item 1 |
|--------------------|---|-------------------|
| $[[matrix]]_A$ | → | $[vector]_{EVAl}$ |

See also: EGV

ELSE

Type: Command

Description: ELSE Command: Starts false clause in conditional or error-trapping structure.

See the IF and IFERR keyword entries for more information.

Access:   BRANCH IF ELSE ( is the left-shift of the  key).

Input/Output: None

See also: IF, CASE, DO, ELSE, IFERR, REPEAT, THEN, UNTIL, WHILE

END

Type: Command

Description: END Command: Ends conditional, error-trapping, and indefinite loop structures.

See the IF, CASE, IFERR, DO, and WHILE keyword entries for more information.

Access: PRG BRANCH IF/CASE/DO/WHILE END (PRG is the left-shift of the key).

Input/Output: None

See also: IF, CASE, DO, ELSE, IFERR, REPEAT, THEN, UNTIL, WHILE

ENDSUB

Type: Command

Description: Ending Sublist Command: Provides a way to access the total number of sublists contained in the list used by DOSUBS.

Returns an Undefined Local Name error if executed when DOSUBS is not active.

Access: PRG LIST PROCEDURES ENDSUB (PRG is the left-shift of the key).

Input/Output: None

See also: DOSUBS, NSUB

ENG

Type: Command

Description: Engineering Mode Command: Sets the number display format to engineering mode, which displays one to three digits to the left of the fraction mark (decimal point) and an exponent that is a multiple of three. The total number of significant digits displayed is $n + 1$.

Engineering mode uses $n + 1$ significant digits, where $0 \leq n \leq 11$. (Values for n outside this range are rounded up or down.) A number is displayed or printed as follows:

$$(sign) mantissa E (sign) exponent$$

where the mantissa is of the form $(mn)n.(n\dots)$ (with up to 12 digits total) and the exponent has one to three digits.

A number with an exponent of -499 is displayed automatically in scientific mode.

Access: & FMT ENG
 PRG MODES FMT ENG (PRG is the left-shift of the key).

Input/Output:

| Level 1/Argument 1 | Level 1/Item 1 |
|--------------------|----------------|
| n | \rightarrow |

See also: FIX, SCI, STD

EPSX0

CAS: Replace coefficients in a polynomial, that have an absolute value less than EPS, with 0.

EQNLIB

Type: Command

Description: Starts the Equation Library application.

Access: EQUATION LIBRARY OR

Input/Output: None

See also: MSOLVR, SOLVEQN

EQW

Type: Command

Description: Opens Equation Writer, where you can edit an expression.

Puts an object into the Equation Writer.

Access: $\boxed{\rightarrow}$ $\underline{\text{CAT}}$ EQW

(Non-programmable access is via \odot when there is an algebraic object on the stack. To start a new equation when not entering a program object, press $\boxed{\rightarrow}$ $\underline{\text{EQW}}$)

Input/Output:

| Level 1/Argument 1 | | Level 1/Item 1 |
|--------------------|---------------|----------------|
| exp_1 | \rightarrow | exp_2 |

See also: EDIT, EDITB, VISIT, VISITB

EQ→

Type: Command

Description: Equation to Stack Command: Separates an equation into its left and right sides.

If the argument is an expression, it is treated as an equation whose right side equals zero.

Access: $\boxed{\leftarrow}$ $\underline{\text{PRG}}$ TYPE $\boxed{\text{NXT}}$ EQ→ ($\underline{\text{PRG}}$ is the left-shift of the $\boxed{\text{EVAL}}$ key).

Input/Output:

| Level 1/Argument 1 | | Level 2/Item 1 | Level 1/Item 2 |
|---------------------|---------------|----------------|----------------|
| ' $symb_1=symb_2$ ' | \rightarrow | ' $symb_1$ ' | ' $symb_2$ ' |
| \tilde{z} | \rightarrow | \tilde{z} | 0 |
| ' $name$ ' | \rightarrow | ' $name$ ' | 0 |
| ' x_unit ' | \rightarrow | ' x_unit ' | 0 |
| ' $symb$ ' | \rightarrow | ' $symb$ ' | 0 |

See also: ARRAY→, DTAG, LIST→, OBJ→, STR→

ERASE

Type: Command

Description: Erase PICT Command: Erases *PICT*, leaving a blank *PICT* of the same dimensions.

Access: $\boxed{\rightarrow}$ $\underline{\text{CAT}}$ ERASE

Input/Output: None

See also: DRAW

ERR0

Type: Command

Description: Clear Last Error Number Command: Clears the last error number so that a subsequent execution of ERRN returns # 0h, and clears the last error message.

Access: $\boxed{\leftarrow}$ $\underline{\text{PRG}}$ $\boxed{\text{NXT}}$ $\boxed{\text{NXT}}$ ERROR ERR0 ($\underline{\text{PRG}}$ is the left-shift of the $\boxed{\text{EVAL}}$ key).

Input/Output: None

See also: DOERR, ERRM, ERRN

ERRM

Type: Command

Description: Error Message Command: Returns a string containing the error message of the most recent calculator error.

ERRM returns the string for an error generated by DOERR. If the argument to DOERR was 0, the string returned by ERRM is 'Interrupted'.

Access: $\boxed{\leftarrow}$ $\underline{\text{PRG}}$ $\boxed{\text{NXT}}$ $\boxed{\text{NXT}}$ ERROR ERRM ($\underline{\text{PRG}}$ is the left-shift of the $\boxed{\text{EVAL}}$ key).

Input/Output:

| Level 1/Argument 1 | Level 1/Item 1 |
|--------------------|-------------------|
| | → "error message" |

See also: DOERR, ERRN, ERR0

ERRN

Type: Command

Description: Error Number Command: Returns the error number of the most recent calculator error. If the most recent error was generated by DOERR with a string argument, ERRN returns #70000h. If the most recent error was generated by DOERR with a binary integer argument, ERRN returns that binary integer. (If the most recent error was generated by DOERR with a real number argument, ERRN returns the binary integer conversion of the real number.) The only exceptions to these rules are 0 DOERR and #0 DOERR, both of which set ERRN to #31Fh and ERRM to 'Interrupted'.

Access:  PRG   ERROR ERRN (PRG is the left-shift of the  key).

Input/Output:

| Level 1/Argument 1 | Level 1/Item 1 |
|--------------------|----------------|
| | → #nerror |

See also: DOERR, ERRM, ERR0

EULER

CAS: Return the number of integers less than an integer that are co-prime with it. (Euler's Φ function.)

EVAL

Type: Command

Description: Evaluate Object Command: Evaluates the object.

The following table describes the effect of the evaluation on different object types.

| Object Type | Effect of Evaluation |
|-------------|---|
| Local Name | Recalls the contents of the variable. |
| Global Name | <i>Calls</i> the contents of the variable: <ul style="list-style-type: none">• A name is evaluated.• A program is evaluated.• A directory becomes the current directory.• Other objects are put on the stack. If no variable exists for a given name, evaluating the name returns the name to the stack. |
| Program | <i>Enters</i> each object in the program: <ul style="list-style-type: none">• Names are evaluated (unless quoted).• Commands are evaluated.• Other objects are put on the stack. |
| List | <i>Enters</i> each object in the list: <ul style="list-style-type: none">• Names are evaluated.• Commands are evaluated• Programs are evaluated.• Other objects are put on the stack. |

| Object Type | Effect of Evaluation |
|------------------------------|--|
| Tagged | If the tag specifies a port, recalls and evaluates the specified object. Otherwise, puts the untagged object on the stack. |
| Algebraic | Enters each object in the algebraic expression: <ul style="list-style-type: none"> Names are evaluated. Commands are evaluated. Other objects are put on the stack. |
| Command, Function, XLIB Name | Evaluates the specified object. |
| Other Objects | Puts the object on the stack. |

To evaluate a symbolic argument to a numerical result, evaluate the argument in Numerical Results mode (flag -3 set) or execute \rightarrow NUM on that argument.

Access: EVAL

Flags: Numerical Results (-3)

Input/Output:

| Level 1/Argument 1 | Level 1/Item 1 |
|--------------------|---------------------------|
| <i>obj</i> | \rightarrow (see above) |

See also: \rightarrow NUM, SYSEVAL

EXLR

CAS: Return the left- and right-hand sides of an equation as separate expressions.

EX&LN

CAS: Display a menu or list of CAS exponential and logarithmic operations.

EXP

Type: Analytic Function

Description: Exponential Analytic Function: Returns the exponential, or natural antilogarithm, of the argument; that is, e raised to the given power.

EXP uses extended precision constants and a special algorithm to compute its result to full 12-digit precision for all arguments that do not trigger an underflow or overflow error.

EXP provides a more accurate result for the exponential than can be obtained by using e γ^x .

The difference in accuracy increases as z increases. For example:

| z | EXP(z) | e^z |
|------|-------------------|-------------------|
| 3 | 20.0855369232 | 20.0855369232 |
| 10 | 22026.4657948 | 22026.4657949 |
| 100 | 2.68811714182E43 | 2.68811714191E43 |
| 500 | 1.40359221785E217 | 1.40359221809E217 |
| 1000 | 1.9707111402E434 | 1.9707111469E434 |

For complex arguments: $e^{(x+iy)} = e^x \cos y + i e^x \sin y$

Access: \leftarrow e^x

(e^x is the left-shift of the γ^x key).

Flags: Numerical Results (-3)

Input/Output:

| Level 1/Argument 1 | | Level 1/Item 1 |
|--------------------|---|----------------------|
| z | → | e^z |
| ' <i>symb</i> ' | → | ' <i>EXP(symb)</i> ' |

See also: ALOG, EXPM, LN, LOG

EXP2HYP

CAS: Convert expressions with the exponential function into expressions with hyperbolic functions.

EXP2POW

CAS: Simplify expressions involving the composition of the exponential and logarithmic functions.

EXPAN

Type: Command

Description: Expand Products Command: Rewrites an algebraic expression or equation by expanding products and powers. This command is equivalent to the old HP 48G series command, with minor modifications (such as adding RISCH for integration).

Access:  CAT EXPAN

Flags: Numerical Results (-3), Exact Mode (-105)

Input/Output:

| Level 1/Argument 1 | | Level 1/Item 1 |
|------------------------------|---|------------------------------|
| x | → | x |
| ' <i>symb</i> ₁ ' | → | ' <i>symb</i> ₂ ' |
| (x, y) | → | (x, y) |

See also: COLCT, EXPAND, ISOL, QUAD, SHOW

EXPAND

CAS: Expand and simplify an algebraic expression. More in-depth than EXPAN and often provides better simplification.

EXPANDMOD

CAS: Expand and simplify algebraic expressions, modulo the current modulus.

EXPFIT

Type: Command

Description: Exponential Curve Fit Command: Stores EXPFIT as the fifth parameter in the reserved variable ΣPAR , indicating that subsequent executions of LR are to use the exponential curve fitting model.

LINFIT is the default specification in ΣPAR .

Access:  CAT EXPFIT

Input/Output: None

See also: BESTFIT, LR, LINFIT, LOGFIT, PWRFIT

EXPLN

CAS: Transform the trigonometric terms in an expression to exponential and logarithmic terms.

EXPM

Type: Analytic Function

Description: Exponential Minus 1 Analytic Function: Returns $e^x - 1$.

For values of x close to zero, $\text{EXPM}(x)$ returns a more accurate result than does $\text{EXP}(x)-1$. (Using EXPM allows both the argument and the result to be near zero, and avoids an intermediate result near 1. The calculator can express numbers within 10^{-449} of zero, but within only 10^{-11} of 1.)

Access: \leftarrow **MTH** HYPERBOLIC **NXT** **EXPM** (**MTH** is the left-shift of the **SYMB** key).
 \leftarrow **EXP&LN** **EXPM** (**EXP&LN** is the left-shift of the **8** key).

Flags: Numerical Results (-3)

Input/Output:

| Level 1/Argument 1 | | Level 1/Item 1 |
|--------------------|---------------|-------------------------|
| x | \rightarrow | $e^x - 1$ |
| ' <i>symb</i> ' | \rightarrow | ' $\text{EXPM}(symb)$ ' |

See also: EXP, LNPI

EYEPT

Type: Command

Description: Eye Point Command: Specifies the coordinates of the eye point in a perspective plot.

x_{point} , y_{point} , and z_{point} are real numbers that set the x-, y-, and z-coordinates as the eye-point from which to view a 3D plot's view volume. The y-coordinate must always be 1 unit less than the view volume's nearest point (y_{near} of YVOL). These coordinates are stored in the reserved variable $VPAR$.

Access: \leftarrow **CAT** **EYEPT**

Input/Output:

| Level 3/Argument 1 | Level 2/Argument 2 | Level 1/Argument 3 | Level 1/Item 1 |
|--------------------|--------------------|--------------------|----------------|
| x_{point} | y_{point} | z_{point} | \rightarrow |

See also: NUMX, NUMY, XVOL, XXRNG, YVOL, YYRNG, ZVOL

F0λ

Type: Function

Description: Black Body Emissive Power Function: Returns the fraction of total black-body emissive power at temperature x_T between wavelengths 0 and y_{lambda} . If units are not specified, y_{lambda} has implied units of meters and x_T has implied units of K.

$F0\lambda$ returns a dimensionless fraction.

Access: \leftarrow **CAT** **F0λ**

Flags: Numerical Results (-3)

Input/Output:

| Level 2/Argument 1 | Level 1/Argument 2 | | Level 1/Item 1 |
|--------------------|--------------------|---------------|-----------------------------------|
| y_{lambda} | x_T | \rightarrow | x_{power} |
| y_{lambda} | ' <i>symb</i> ' | \rightarrow | ' $F0\lambda(y_{lambda}, symb)$ ' |
| ' <i>symb</i> ' | x_T | \rightarrow | ' $F0\lambda(symb, x_T)$ ' |
| ' <i>symb</i> ' | ' <i>symb</i> ' | \rightarrow | ' $F0\lambda(symb_1, symb_2)$ ' |

FACT

Type: Command

Description: Factorial (Gamma) Function: FACT is the same as !.

Access:  CAT FACT

Flags: Numerical Results (-3), Underflow Exception (-20), Overflow Exception (-21)

Input/Output:

| Level 1/Argument 1 | | Level 1/Item 1 |
|--------------------|---|--------------------|
| n | → | $n!$ |
| x | → | $\Gamma(x + 1)$ |
| ' <i>symb</i> ' | → | '(<i>symb</i>)!' |

See also: COMB, PERM, !

FACTOR

CAS: Factorize a polynomial to irreducible polynomials, or an integer to primes.

FACTORMOD

CAS: Factorize a polynomial modulo the current modulus.

FACTORS

CAS: For a value or expression, return a list of prime factors and their multiplicities.

FANNING

Type: Function

Description: Fanning Friction Factor Function: Calculates the Fanning friction factor of certain fluid flows.

FANNING calculates the Fanning friction factor, a correction factor for the frictional effects of fluid flows having constant temperature, cross-section, velocity, and viscosity (a typical pipe flow, for example). $x_{s/D}$ is the relative roughness (the ratio of the conduit roughness to its diameter). y_{Re} is the Reynolds number. The function uses different computation routines for laminar flow ($Re \leq 2100$) and turbulent flow ($Re > 2100$). $x_{s/D}$ and y_{Re} must be real numbers or unit objects that reduce to dimensionless numbers, and both numbers must be greater than 0.

Access:  CAT FANNING

Flags: Numerical Results (-3)

Input/Output:

| Level 2/Argument 1 | Level 1/Argument 2 | | Level 1/Item 1 |
|--------------------|------------------------------|---|--|
| $x_{s/D}$ | y_{Re} | → | x_{fanning} |
| $x_{s/D}$ | ' <i>symb</i> ' | → | 'FANNING($x_{s/D}$, <i>symb</i>)' |
| ' <i>symb</i> ' | y_{Re} | → | 'FANNING(<i>symb</i> , y_{Re})' |
| ' <i>symb</i> ' | ' <i>symb</i> ₂ ' | → | 'FANNING(<i>symb</i> ₁ , <i>symb</i> ₂)' |

See also: DARCY

FAST3D

Type: Command

Description: Fast 3D Plot Type Command: Sets the plot type to FAST 3D.

When plot type is set to FAST3D, the DRAW command plots an image graph of a 3-vector-valued function of two variables. FAST3D requires values in the reserved variables *EQ*, *VPAR*, and *PPAR*.

VPAR is made up of the following elements:

{ x_{left} , x_{right} , y_{near} , y_{far} , z_{low} , z_{high} , x_{min} , x_{max} , y_{min} , y_{max} , x_{eye} , y_{eye} , z_{eye} , x_{step} , y_{step} }

For plot type FAST3D, the elements of *VPAR* are used as follows:

- x_{left} and x_{right} are real numbers that specify the width of the view space.
- y_{near} and y_{far} are real numbers that specify the depth of the view space.

- z_{low} and z_{high} are real numbers that specify the height of the view space.
- x_{min} and x_{max} are not used.
- y_{min} and y_{max} are not used.
- x_{eye} , y_{eye} , and z_{eye} are not used.
- x_{step} and y_{step} are real numbers that set the number of x-coordinates versus the number of y-coordinates plotted.

The plotting parameters are specified in the reserved variable *PPAR*, which has this form:

$$\{ (x_{min}, y_{min}), (x_{max}, y_{max}), indep, res, axes, ptype, depend \}$$

For plot type FAST3D, the elements of *PPAR* are used as follows:

- (x_{min}, y_{min}) is not used.
- (x_{max}, y_{max}) is not used.
- *indep* is a name specifying the independent variable. The default value of *indep* is *X*.
- *res* is not used.
- *axes* is not used.
- *ptype* is a command name specifying the plot type. Executing the command FAST3D places the name FAST3D in *ptype*.
- *depend* is a name specifying the dependent variable. The default value is *Y*.

Access: FAST3D

Input/Output: None

See also: BAR, CONIC, DIFFEQ, FUNCTION, GRIDMAP, HISTOGRAM, PARAMETRIC, PARSURFACE, PCONTOUR, POLAR, SCATTER, SLOPEFIELD, TRUTH, WIREFRAME, YSLICE

FCOEF

CAS: From an array of roots and multiplicities/poles, return a rational polynomial.

FC?

Type: Command

Description: Flag Clear? Command: Tests whether the system or user flag specified by $n_{flag\ number}$ is clear, and returns a corresponding test result: 1 (true) if the flag is clear or 0 (false) if the flag is set.

Access: TEST FC? (is the left-shift of the key).
 MODES FLAG FC? (is the left-shift of the key).
 & FLAG FC?

Input/Output:

| Level 1/Argument 1 | Level 1/Item 1 |
|--------------------|----------------|
| $n_{flag\ number}$ | 0/1 |

See also: CF, FC?C, FS? FS?C, SF

FC?C

Type: Command

Description: Flag Clear? Clear Command: Tests whether the system or user flag specified by $n_{flag\ number}$ is clear, and returns a corresponding test result: 1 (true) if the flag is clear or 0 (false) if the flag is set. After testing, clears the flag.

Access: TEST FC?C (is the left-shift of the key).
 MODES FLAG FC?C (is the left-shift of the key).
 & FLAG FC?C

Input/Output:

| Level 1/Argument 1 | Level 1/Item 1 |
|--------------------------|----------------|
| $N_{\text{flag number}}$ | $0/1$ |

See also: CF, FC?, FS? FS?C, SF

FDISTRIB

CAS: Perform a full distribution of multiplication and division in a single step.

FFT

Type: Command

Description: Discrete Fourier Transform Command: Computes the one- or two-dimensional discrete Fourier transform of an array.

If the argument is an N -vector or an $N \times 1$ or $1 \times N$ matrix, FFT computes the one-dimensional transform. If the argument is an $M \times N$ matrix, FFT computes the two-dimensional transform. M and N must be integral powers of 2.

The one-dimensional discrete Fourier transform of an N -vector X is the N -vector Y where:

$$Y_k = \sum_{n=0}^{N-1} X_n e^{-\frac{2\pi i k n}{N}}, i = \sqrt{-1}$$

for $k = 0, 1, \dots, N-1$.

The two dimensional discrete Fourier transform of an $M \times N$ matrix X is the $M \times N$ matrix Y where:

$$Y_{kl} = \sum_{m=0}^{M-1} \sum_{n=0}^{N-1} x_{mn} e^{-\frac{2\pi i k m}{M}} e^{-\frac{2\pi i l n}{N}}, i = \sqrt{-1}$$

for $k = 0, 1, \dots, M-1$ and $l = 0, 1, \dots, N-1$.

The discrete Fourier transform and its inverse are defined for any positive sequence length. However, the calculation can be performed very rapidly when the sequence length is a power of two, and the resulting algorithms are called the fast Fourier transform (FFT) and inverse fast Fourier transform (IFFT).

The FFT command uses truncated 15-digit arithmetic and intermediate storage, then rounds the result to 12-digit precision.

Access:  MTH  FFT FFT (MTH is the left-shift of the SYMB key).

Input/Output:

| Level 1/Argument 1 | Level 1/Item 1 |
|--------------------|----------------|
| $[array]_1$ | $[array]_2$ |

See also: IFFT

FILER

Type: Command

Description: Opens File Manager.

Access:  FILES (FILES is the left-shift of the APPS key).

 CAT FILER

Input/Output: None

FINDALARM

Type: Command

Description: Find Alarm Command: Returns the alarm index n_{index} of the first alarm due after the specified time.

If the input is a real number *date*, FINDALARM returns the index of the first alarm due after 12:00 AM on that date. If the input is a list { *date time* }, it returns the index of the first alarm due after that date and time. If the input is the real number 0, FINDALARM returns the first *past-due* alarm. For any of the three arguments, FINDALARM returns 0 if no alarm is found.

Access: $\boxed{\rightarrow}$ TIME TOOLS ALRM FINDALARM (TIME is the right-shift of the $\boxed{9}$ key).

$\boxed{\rightarrow}$ & $\boxed{9}$ ALRM FINDALARM

$\boxed{\leftarrow}$ PRG $\boxed{\text{NXT}}$ $\boxed{\text{NXT}}$ TIME ALRM FINDALARM (PRG is the left-shift of the $\boxed{\text{EVAL}}$ key).

Flags: Date Format (-42)

Input/Output:

| Level 1/Argument 1 | | Level 1/Item 1 |
|----------------------|---|----------------|
| <i>date</i> | → | n_{index} |
| { <i>date time</i> } | → | n_{index} |
| 0 | → | n_{index} |

See also: DELALARM, RCLALARM, STOALARM

FINISH

Type: Command

Description: Finish Server Mode Command: Terminates Kermit Server mode in a device connected to an hp49g+/hp48gII.

FINISH is used by a local Kermit device to tell a server Kermit (connected via the serial port) to exit Server mode.

Access: $\boxed{\rightarrow}$ CAT FINISH

Flags: I/O Device flag (-33), I/O Messages (-39)

Input/Output: None

See also: BAUD, CKSM, KGET, PARITY, PKT, RECN, RECV, SEND, SERVER

FIX

Type: Command

Description: Fix Mode Command: Sets the number display format to fix mode, which rounds the display to n decimal places.

Fix mode shows n digits to the right of the fraction mark (decimal point), where $0 \leq n \leq 11$. (Values for n outside this range are rounded to the nearest integer.) A number is displayed or printed as (*sign*) *mantissa*, where the mantissa can be of any form. However, the calculator automatically displays a number in scientific mode if either of the following is true:

- The number of digits to be displayed exceeds 12.
- A nonzero value rounded to n decimal places otherwise would be displayed as zero.

Access: $\boxed{\leftarrow}$ & $\boxed{\text{MODE}}$ FMT FIX

$\boxed{\leftarrow}$ PRG $\boxed{\text{NXT}}$ MODES FMT FIX (PRG is the left-shift of the $\boxed{\text{EVAL}}$ key).

Input/Output:

| Level 1/Argument 1 | | Level 1/Item 1 |
|--------------------|---|----------------|
| n | → | |

See also: SCI, STD

FLASHEVAL

Type: Command

Description: Evaluate Flash Function Command: Evaluates unnamed Flash functions.

WARNING: Use extreme care when executing this function. Using FLASHEVAL with random addresses will almost always cause a memory loss. Do not use this function unless you know what you are doing.

#n_{function} is of the form *ffffbbb*, where *bbb* is the bank ID, and *ffff* is the function number.

Access:  CAT FLASHEVAL

Input/Output:

| Level 1/Argument 1 | Level 1/Item 1 |
|------------------------|----------------|
| #n _{function} | → |

See also: EVAL, LIBEVAL, SYSEVAL

FLOOR

Type: Function

Description: Floor Function: Returns the greatest integer that is less than or equal to the argument.

Access:  MTH REAL  NXT FLOOR (MTH is the left-shift of the  key).

Flags: Numerical Results (-3)

Input/Output:

| Level 1/Argument 1 | Level 1/Item 1 |
|--------------------------|----------------------------|
| <i>x</i> | → <i>n</i> |
| <i>x</i> _{unit} | → <i>n</i> _{unit} |
| ' <i>symb</i> ' | → 'FLOOR(<i>symb</i>)' |

See also: CEIL, IP, RND, TRNC

FONT6

Type: Function

Description: Font Function: Returns the system FONT6 object. You use this in conjunction with the →FONT command to set the system font to type 6.

Access:  CAT FONT6

Input/Output:

| Level 1/Argument 1 | Level 1/Item 1 |
|--------------------|----------------------|
| | → <i>Font object</i> |

See also: FONT7, FONT8, →FONT, FONT→

FONT7

Type: Function

Description: Font Function: Returns the system FONT7 object. You use this in conjunction with the →FONT command to set the system font to type 7.

Access:  CAT FONT7

Input/Output:

| Level 1/Argument 1 | Level 1/Item 1 |
|--------------------|----------------------|
| | → <i>Font object</i> |

See also: FONT6, FONT8, →FONT, FONT→

FONT8

Type: Function

Description: Font Function: Returns the system FONT8 object. You use this in conjunction with the →FONT command to set the system font to type 8.

Access:  CAT FONT8

Input/Output:

| Level 1/Argument 1 | Level 1/Item 1 |
|--------------------|----------------------|
| | → <i>Font object</i> |

See also: FONT6, FONT7, →FONT, FONT→

FONT→

Type: Function

Description: Returns the current system font.

Access:  CAT FONT→

Input/Output:

| Level 1/Argument 1 | Level 1/Item 1 |
|--------------------|----------------------|
| | → <i>Font object</i> |

See also: FONT6, FONT7, FONT8, →FONT

→FONT

Type: Function

Description: Set font Function: Sets the system font. You use this in conjunction with one of the three font commands to set the system font. Valid input is any font object (TYPE 30) of size 6, 7, or 8.

Access:  CAT →FONT

Input/Output:

| Level 1/Argument 1 | Level 1/Item 1 |
|--------------------|----------------|
| <i>Font object</i> | → |

See also: FONT6, FONT7, FONT8, FONT→

FOR

Type: Command Operation

Description: FOR Definite Loop Structure Command: Starts FOR ... NEXT and FOR ... STEP definite loop structures.

Definite loop structures execute a command or sequence of commands a specified number of times.

- A FOR ... NEXT loop executes a program segment a specified number of times using a local variable as the loop counter. You can use this variable within the loop. The RPL syntax is this:

x_{start} x_{finish} FOR counter loop-clause NEXT

The algebraic syntax is this:

FOR (counter, x_{start} , x_{finish})loop-clause NEXT

FOR takes x_{start} and x_{finish} as the beginning and ending values for the loop counter, then creates the local variable counter as a loop counter. Then, the loop clause is executed; counter can be referenced or have its value changed within the loop clause. NEXT increments counter by one, and then tests whether counter is less than or equal to x_{finish} . If so, the loop clause is repeated (with the new value of counter).

When the loop is exited, counter is purged.

- FOR ... STEP works just like FOR ... NEXT, except that it lets you specify an increment value other than 1. The syntax RPL is:

x_{start} x_{finish} FOR counter loop-clause $x_{increment}$ STEP

The algebraic syntax is:

FOR(counter x_{start} x_{finish})loop-clause, STEP ($x_{increment}$)
 FOR takes x_{start} and x_{finish} as the beginning and ending values for the loop counter, then creates the local variable counter as a loop counter. Next, the loop clause is executed; counter can be referenced or have its value changed within the loop clause. STEP takes $x_{increment}$ and increments counter by that value. If the argument of STEP is an algebraic expression or a name, it is automatically evaluated to a number.
 The increment value can be positive or negative. If the increment is positive, the loop is executed again when counter is less than or equal to x_{finish} . If the increment is negative, the loop is executed when counter is greater than or equal to x_{finish} .
 When the loop is exited, counter is purged.

Access: \leftarrow PRG BRANCH FOR (\leftarrow PRG is the left-shift of the EVAL key).

Input/Output:

| Level 2/ | Level 1 | Level 1/Item 1 |
|-----------------|------------------------|----------------|
| FOR x_{start} | x_{finish} | → |
| NEXT | | → |
| FOR x_{start} | x_{finish} | → |
| STEP | $x_{increment}$ | → |
| STEP | ' $symb_{increment}$ ' | → |

Note: It should be noted that FOR inputs may also be integers (object type 28) and binary integers (type 10). FOR actually runs fastest on binary integers, runs “normally” on reals and slightly slower on integers.

See also: NEXT, START, STEP

FOURIER

CAS: Return the n^{th} coefficient of a complex Fourier series expansion.

FP

Type: Function

Description: Fractional Part Function: Returns the fractional part of the argument.

The result has the same sign as the argument.

Access: \leftarrow MTH REAL \leftarrow NXT FP (\leftarrow MTH is the left-shift of the SYMB key).

Flags: Numerical Results (-3)

Input/Output:

| Level 1/Argument 1 | Level 1/Item 1 |
|--------------------|----------------|
| x | y |
| x_{unit} | y_{unit} |
| ' $symb$ ' | 'FP($symb$)' |

See also: IP

FREE

Type: Command

Description: This command, a carry-over from the HP 48GX for handling plug-in RAM cards, should not be used.

FREEZE

Type: Command

Description: Freeze Display Command: Freezes the part of the display specified by $n_{display\ area}$, so that it is not updated until a key is pressed.

Normally, the stack display is updated as soon as the calculator is ready for data input. For example, when HALT stops a running program, or when a program ends, any displayed messages are cleared. The FREEZE command “freezes” a part or all of the display so that it is not updated until a key is pressed. This allows, for example, a prompting message to persist after a program halts to await data input.

$n_{\text{display area}}$ is the sum of the value codes for the areas to be frozen:

| Display Area | Value Code |
|---------------------------------|------------|
| Status area | 1 |
| History/Stack/Command-line area | 2 |
| Menu area | 4 |

So, for example, 2 FREEZE freezes the history/stack/command-line area, 3 FREEZE freezes the status area and the history/stack/command-line area, and 7 FREEZE freezes all three areas. Values of $n_{\text{display area}} \geq 7$ or ≤ 0 freeze the entire display (are equivalent to value 7). To freeze the graphics display, you must freeze the status and stack/command-line areas (by entering 3), or the entire display (by entering 7).

Access: \leftarrow PRG \leftarrow NXT OUT FREEZE (\leftarrow PRG is the left-shift of the \leftarrow EVAL key).

Input/Output:

| Level 1/Argument 1 | Level 1/Item 1 |
|---------------------------|----------------|
| $n_{\text{display area}}$ | \rightarrow |

See also: CLLCD, DISP, HALT

FROOTS

CAS: For a rational polynomial, return its roots and poles, with their corresponding multiplicities.

FS?

Type: Command

Description: Flag Set? Command: Tests whether the system or user flag specified by $n_{\text{flag number}}$ is set, and returns a corresponding test result: 1 (true) if the flag is set or 0 (false) if the flag is clear.

Access: \leftarrow PRG TEST \leftarrow NXT \leftarrow NXT FS? (\leftarrow PRG is the left-shift of the \leftarrow EVAL key).
 \leftarrow PRG \leftarrow NXT MODES FLAG FS? (\leftarrow PRG is the left-shift of the \leftarrow EVAL key).
 \leftarrow & \leftarrow MODE FLAG FS?

Input/Output:

| Level 1/Argument 1 | Level 1/Item 1 |
|--------------------------|-------------------|
| $n_{\text{flag number}}$ | \rightarrow 0/1 |

See also: CF, FC?, FC?C, FS?C, SF

FS?C

Type: Command

Description: Flag Set? Clear Command: Tests whether the system or user flag specified by $n_{\text{flag number}}$ is set, and returns a corresponding test result: 1 (true) if the flag is set or 0 (false) if the flag is clear. After testing, clears the flag.

Access: \leftarrow PRG TEST \leftarrow NXT \leftarrow NXT FS?C (\leftarrow PRG is the left-shift of the \leftarrow EVAL key).
 \leftarrow PRG \leftarrow NXT MODES FLAG FS?C (\leftarrow PRG is the left-shift of the \leftarrow EVAL key).
 \leftarrow & \leftarrow MODE FLAG FS?C

Input/Output:

| Level 1/Argument 1 | Level 1/Item 1 |
|--------------------------|-------------------|
| $n_{\text{flag number}}$ | \rightarrow 0/1 |

See also: CF, FC?, FC?C, FS?, SF

FUNCTION

Type: Command

Description: Function Plot Type Command: Sets the plot type to FUNCTION.

When the plot type is FUNCTION, the DRAW command plots the current equation as a real-valued function of one real variable. The current equation is specified in the reserved variable *EQ*. The plotting parameters are specified in the reserved variable *PPAR*, which has the form:

$$\{ (x_{\min}, y_{\min}) (x_{\max}, y_{\max}) \text{ indep res axes ptype depend } \}$$

For plot type FUNCTION, the elements of *PPAR* are used as follows:

- (x_{\min}, y_{\min}) is a complex number specifying the lower left corner of *PICT* (the lower left corner of the display range). The default value is $(-6.5, -3.1)$ for the hp48gII and $(-6.5, -3.9)$ for the hp49g+.
- (x_{\max}, y_{\max}) is a complex number specifying the upper right corner of *PICT* (the upper right corner of the display range). The default value is $(6.5, 3.2)$ for the hp48gII and $(6.5, 4.0)$ for the hp49g+.
- *indep* is a name specifying the independent variable, or a list containing such a name and two numbers specifying the minimum and maximum values for the independent variable (the plotting range). The default value of *indep* is *X*.
- *res* is a real number specifying the interval (in user-unit coordinates) between plotted values of the independent variable, or a binary integer specifying the interval in pixels. The default value is 0, which specifies an interval of 1 pixel.
- *axes* is a list containing one or more of the following, in the order listed: a complex number specifying the user-unit coordinates of the plot origin, a list specifying the tick-mark annotation, and two strings specifying labels for the horizontal and vertical axes. The default value is $(0, 0)$.
- *ptype* is a command name specifying the plot type. Executing the command FUNCTION places the name FUNCTION in *PPAR*.
- *depend* is a name specifying a label for the vertical axis. The default value is *Y*.

The current equation is plotted as a function of the variable specified in *indep*. The minimum and maximum values of the independent variable (the plotting range) can be specified in *indep*; otherwise, the values in (x_{\min}, y_{\min}) and (x_{\max}, y_{\max}) (the display range) are used. Lines are drawn between plotted points unless flag -31 is set.

If *EQ* contains an expression or program, the expression or program is evaluated in Numerical Results mode for each value of the independent variable to give the values of the dependent variable. If *EQ* contains an equation, the plotting action depends on the form of the equation, as shown in the following table.

| Form of Current Equation | Plotting Action |
|--------------------------|--|
| $expr = expr$ | Each expression is plotted separately. The intersection of the two graphs shows where the expressions are equal. |
| $name = expr$ | Only the expression is plotted. |
| $indep = constant$ | A vertical line is plotted. |

If flag -28 is set, all equations are plotted simultaneously.

If the independent variable in the current equation represents a unit object, you must specify the units by storing a unit object in the corresponding variable in the current directory. For example, if the current equation is $X+3_m$, and you want *X* to represent some number of inches, you would store 1_in (the number part of the unit object is ignored) in *X*. For each plotted point, the numerical value of the independent variable is combined with the specified unit (inches in this

example) before the current equation is evaluated. If the result is a unit object, only the number part is plotted.

Access:  CAT FUNCTION

Flags: Simultaneous Plotting (-28), Curve Filling (-31)

Input/Output: None

See also: BAR, CONIC, DIFFEQ, FAST3D, GRIDMAP, HISTOGRAM, PARAMETRIC, PARSURFACE, PCONTOUR, POLAR, SCATTER, SLOPEFIELD, TRUTH, WIREFRAME, YSLICE

FXND

CAS: Split a fractional object into its numerator and denominator.

GAMMA

Type: Function

Description: Evaluate the Γ function at the given point. For a positive integer x , $\Gamma(x)$ is equal to $(x+1)!$ GAMMA differs from the FACT and ! functions because it allows complex arguments. The Γ function is defined by

$$\Gamma(x) = \int_0^{+\infty} e^{-t} \cdot t^{x-1} dt$$

Access:  MTH  SPECIAL

Input: A real or complex number, x .

Output: $\Gamma(x)$. If the input x is an integer greater than 100, returns the symbolic expression GAMMA(x).

Flags: If the Underflow Exception (-20) or Overflow Exception (-21) flags are set then underflow or overflow conditions give errors, otherwise they give zero or the maximum real number the calculator can express.

Complex mode must be set (flag -103 set) if x is complex.

See also: FACT, PSI, Psi, !

GAUSS

CAS: Return the diagonal representation of a quadratic form.

GBASIS

CAS: Return a set of polynomials that are a Gröbner basis G of the ideal I of an input set of polynomials.

GCD

CAS: Return the greatest common divisor of two objects.

GCDMOD

CAS: Find the greatest common divisor of two polynomials modulo the current modulus.

GET

Type: Command

Description: Get Element Command: Returns from the argument 1/level 2 array or list (or named array or list) the real or complex number x_{get} or object obj_{get} whose position is specified in argument 2/level 1. For matrices, n_{position} is incremented in row order.

Access:  PRG LIST ELEMENTS GET (PRG is the left-shift of the EVAL key).

Input/Output:

| Level 2/Argument 1 | Level 1/Argument 2 | | Level 1/Item 1 |
|---------------------------|---|---|--------------------------|
| $[[\text{matrix}]]$ | n_{position} | → | \tilde{x}_{get} |
| $[[\text{matrix}]]$ | $\{ n_{\text{row}}, m_{\text{column}} \}$ | → | \tilde{x}_{get} |
| 'name _{matrix} ' | n_{position} | → | \tilde{x}_{get} |
| 'name _{matrix} ' | $\{ n_{\text{row}}, m_{\text{column}} \}$ | → | \tilde{x}_{get} |
| [vector] | n_{position} | → | \tilde{x}_{get} |
| [vector] | $\{ n_{\text{position}} \}$ | → | \tilde{x}_{get} |
| 'name _{vector} ' | n_{position} | → | \tilde{x}_{get} |
| 'name _{vector} ' | $\{ n_{\text{position}} \}$ | → | \tilde{x}_{get} |
| { list } | n_{position} | → | obj _{get} |
| { list } | $\{ n_{\text{position}} \}$ | → | obj _{get} |
| 'name _{list} ' | n_{position} | → | obj _{get} |
| 'name _{list} ' | $\{ n_{\text{position}} \}$ | → | obj _{get} |

See also: GETI, PUT, PUTI

GETI

Type: Command

Description: Get and Increment Index Command: Returns from the argument 1/level 2 array or list (or named array or list) the real or complex number \tilde{x}_{get} or object *obj_{get}* whose position is specified in argument 2/level 1, along with the first (level 2) argument and the next position in that argument. For matrices, the position is incremented in *row* order.

Access: \leftarrow PRG LIST ELEMENTS GETI (\leftarrow PRG is the left-shift of the EVAL key).

Flags: Index Wrap Indicator (-64)

Input/Output:

| L ₂ /A ₁ | L ₁ /A ₂ | | L ₃ /I ₁ | L ₂ /I ₂ | L ₁ /I ₃ |
|--------------------------------|---|---|--------------------------------|---|--------------------------------|
| $[[\text{matrix}]]$ | $n_{\text{position1}}$ | → | $[[\text{matrix}]]$ | $n_{\text{position2}}$ | \tilde{x}_{get} |
| $[[\text{matrix}]]$ | $\{ n_{\text{row}}, m_{\text{column}} \}_1$ | → | $[[\text{matrix}]]$ | $\{ n_{\text{row}}, m_{\text{column}} \}_2$ | \tilde{x}_{get} |
| 'name _{matrix} ' | $n_{\text{position1}}$ | → | 'name _{matrix} ' | $n_{\text{position2}}$ | \tilde{x}_{get} |
| 'name _{matrix} ' | $\{ n_{\text{row}}, m_{\text{column}} \}_1$ | → | 'name _{matrix} ' | $\{ n_{\text{row}}, m_{\text{column}} \}_2$ | \tilde{x}_{get} |
| [vector] | n_{position} | → | [vector] | $n_{\text{position2}}$ | \tilde{x}_{get} |
| [vector] | $\{ n_{\text{position1}} \}$ | → | [vector] | $\{ n_{\text{position2}} \}$ | \tilde{x}_{get} |
| 'name _{vector} ' | $n_{\text{position1}}$ | → | 'name _{vector} ' | $n_{\text{position2}}$ | \tilde{x}_{get} |
| 'name _{vector} ' | $\{ n_{\text{position1}} \}$ | → | 'name _{vector} ' | $\{ n_{\text{position2}} \}$ | \tilde{x}_{get} |
| { list } | $n_{\text{position1}}$ | → | { list } | $n_{\text{position2}}$ | obj _{get} |
| { list } | $\{ n_{\text{position1}} \}$ | → | { list } | $\{ n_{\text{position2}} \}$ | obj _{get} |
| 'name _{list} ' | $n_{\text{position1}}$ | → | 'name _{list} ' | $n_{\text{position2}}$ | obj _{get} |
| 'name _{list} ' | $\{ n_{\text{position1}} \}$ | → | 'name _{list} ' | $\{ n_{\text{position2}} \}$ | obj _{get} |

L = Level; A = Argument; I = Item

See also: GET, PUT, PUTI

GOR

Type: Command

Description: Graphics OR Command: Superimposes $grob_1$ onto $grob_{target}$ or $PICT$, with the upper left corner pixel of $grob_1$ positioned at the specified coordinate in $grob_{target}$ or $PICT$.

GOR uses a logical OR to determine the state (on or off) of each pixel in the overlapping portion of the argument graphics object.

If the first argument (stack level 3) is any graphics object other than $PICT$, then $grob_{result}$ is returned to the stack. If the first argument (level 3) is $PICT$, no result is returned to the stack.

Any portion of $grob_1$ that extends past $grob_{target}$ or $PICT$ is truncated.

Access: \leftarrow PRG \rightarrow NXT GROB GOR (\leftarrow PRG is the left-shift of the \rightarrow EVAL key).

Input/Output:

| Level 3/Argument 1 | Level 2/Argument 2 | Level 1/Argument 3 | | Level 1/Item 1 |
|--------------------|--------------------|--------------------|---------------|-----------------|
| $grob_{target}$ | { #n #m } | $grob_1$ | \rightarrow | $grob_{result}$ |
| $grob_{target}$ | (x, y) | $grob_1$ | \rightarrow | $grob_{result}$ |
| $PICT$ | { #n #m } | $grob_1$ | \rightarrow | |
| $PICT$ | (x, y) | $grob_1$ | \rightarrow | |

See also: GXOR, REPL, SUB

GRAD

Type: Command

Description: Grads Mode Command: Sets Grads angle mode.

GRAD clears flag -17 and sets flag -18, and displays the GRD annunciator.

In Grads angle mode, real-number arguments that represent angles are interpreted as grads, and real-number results that represent angles are expressed in grads.

Access: \leftarrow &MODE ANGLE GRAD

\rightarrow CAT GRAD

Input/Output: None

See also: DEG, RAD

GRAMSCHMIDT

CAS: Find an orthonormal base of a vector space with respect to a given scalar product.

GREDUCE

CAS: Reduce a polynomial with respect to a Gröbner basis.

GRIDMAP

Type: Command

Description: GRIDMAP Plot Type Command: Sets the plot type to GRIDMAP.

When plot type is set GRIDMAP, the DRAW command plots a mapping grid representation of a 2-vector-valued function of two variables. GRIDMAP requires values in the reserved variables EQ , $VPAR$, and $PPAR$.

$VPAR$ has the following form:

$$\{x_{left}, x_{right}, y_{near}, y_{far}, z_{low}, z_{high}, x_{min}, x_{max}, y_{min}, y_{max}, x_{eye}, y_{eye}, z_{eye}, x_{step}, y_{step}\}$$

For plot type GRIDMAP, the elements of $VPAR$ are used as follows:

- x_{left} and x_{right} are real numbers that specify the width of the view space.
- y_{near} and y_{far} are real numbers that specify the depth of the view space.
- z_{low} and z_{high} are real numbers that specify the height of the view space.

- x_{\min} and x_{\max} are real numbers that specify the input region's width. The default value is $(-1,1)$.
- y_{\min} and y_{\max} are real numbers that specify the input region's depth. The default value is $(-1,1)$.
- $x_{\text{eye}}, y_{\text{eye}},$ and z_{eye} are real numbers that specify the point in space from which you view the graph.
- x_{step} and y_{step} are real numbers that set the number of x-coordinates versus the number of y-coordinates plotted. These can be used instead of (or in combination with) RES.

The plotting parameters are specified in the reserved variable *PPAR*, which has the following form:

$$\{ (x_{\min}, y_{\min}), (x_{\max}, y_{\max}), \text{indep}, \text{res}, \text{axes}, \text{ptype}, \text{depend} \}$$

For plot type GRIDMAP, the elements of *PPAR* are used as follows:

- (x_{\min}, y_{\min}) is not used.
- (x_{\max}, y_{\max}) is not used.
- *indep* is a name specifying the independent variable. The default value of *indep* is *X*.
- *res* is a real number specifying the interval (in user-unit coordinates) between plotted values of the independent variable, or a binary integer specifying the interval in pixels. The default value is 0, which specifies an interval of 1 pixel.
- *axes* is not used.
- *ptype* is a command name specifying the plot type. Executing the command GRIDMAP places the command name GRIDMAP in *PPAR*.
- *depend* is a name specifying the dependent variable. The default value is *Y*.

Access: CAT GRIDMAP

Input/Output: None

See also: BAR, CONIC, DIFFEQ, FUNCTION, HISTOGRAM, PARAMETRIC, PARSURFACE, PCONTOUR, POLAR, SCATTER, SLOPEFIELD, TRUTH, WIREFRAME, YSLICE

→GROB

Type: Command

Description: Stack to Graphics Object Command: Creates a graphics object from a specified object, where the argument *nchar size* specifies the character size of the object.

nchar size can be 0, 1 (small), 2 (medium), or 3 (large). *nchar size* = 0 is the same as *nchar size* = 3, except for unit objects and algebraic objects, where 0 specifies the Equation Writer application picture.

Access: CAT →GROB

PRG GROB →GROB (PRG is the left-shift of the key).

Input/Output:

| Level 2/Argument 1 | Level 1/Argument 2 | Level 1/Item 1 |
|--------------------|--------------------|----------------|
| <i>obj</i> | <i>ncharsize</i> → | <i>grob</i> |

See also: →LCD, LCD→

GROB

Type: Command

Description: Enters GROB on the command line to help with the manual entry of a graphic object.

Access: CAT GROB

GROBADD

Type: Command

Description: Combines two graphic objects by appending the second argument onto the bottom of the first.

Access: GRAPH GROBADD

CALC GRAPH GROBADD (CALC is the left-shift of the key).

Input/Output:

| Level 2/Argument 1 | Level 1/Argument 2 | | Level 1/Item 1 |
|--------------------|--------------------|---|----------------|
| $GROB_1$ | $GROB_2$ | → | $GROB_3$ |

GXOR

Type: Command

Description: Graphics Exclusive OR Command: Superimposes $grob_1$ onto $grob_{target}$ or $PICT$, with the upper left corner pixel of $grob_1$ positioned at the specified coordinate in $grob_{target}$ or $PICT$.

GXOR is used for creating cursors, for example, to make the cursor image appear dark on a light background and light on a dark background. Executing GXOR again with the same image restores the original picture.

GXOR uses a logical exclusive OR to determine the state of the pixels (on or off) in the overlapping portion of the argument graphics objects.

Any portion of $grob_1$ that extends past $grob_{target}$ or $PICT$ is truncated.

If the first (level 3) argument (the target graphics object) is any graphics object other than $PICT$, then $grob_{result}$ is returned to the stack. If the first (level 3) argument is $PICT$, no result is returned to the stack.

Access: \leftarrow PRG \boxed{NXT} GROB GXOR (\leftarrow PRG is the left-shift of the \boxed{EVAL} key).

Input/Output:

| Level 3/Argument 1 | Level 2/Argument 2 | Level 1/Argument 3 | | Level 1/Item 1 |
|--------------------|--------------------|--------------------|---|-----------------|
| $grob_{target}$ | { #n, #m } | $grob_1$ | → | $grob_{result}$ |
| $grob_{target}$ | (x, y) | $grob_1$ | → | $grob_{result}$ |
| $PICT$ | { #n, #m } | $grob_1$ | → | |
| $PICT$ | (x, y) | $grob_1$ | → | |

See also: GOR, REPL, SUB

HADAMARD

CAS: Perform an element by element multiplication of two matrices (Hadamard product).

HALFTAN

CAS: Transform an expression by replacing $\sin(x)$, $\cos(x)$ and $\tan(x)$ subexpressions with $\tan(x/2)$.

HALT

Type: Command

Description: Halt Program Command: Halts program execution.

Program execution is halted at the location of the HALT command in the program. The HLT annunciator is turned on. Program execution is resumed by executing CONT (that is, by pressing \leftarrow CONT). Executing KILL cancels all halted programs.

Access: \leftarrow PRG \boxed{NXT} \boxed{NXT} RUN & DEBUG HALT (\leftarrow PRG is the left-shift of the \boxed{EVAL} key).

Input/Output: None

See also: CONT, KILL

HEAD

Type: Command

Description: First Listed Element Command: Returns the first element of a list or string.

Access: \leftarrow PRG \leftarrow CHARS \leftarrow HEAD (\leftarrow PRG is the left-shift of the \leftarrow EVAL key).
 \leftarrow PRG LIST ELEMEN \leftarrow HEAD (\leftarrow PRG is the left-shift of the \leftarrow EVAL key).
 \rightarrow CHARS \rightarrow HEAD (\rightarrow CHARS is the right-shift of the \leftarrow EVAL key).

Input/Output:

| Level 1/Argument 1 | | Level 1/Item 1 |
|-----------------------------|---------------|----------------|
| $\{ obj_i, \dots, obj_n \}$ | \rightarrow | obj_i |
| "string" | \rightarrow | "element," |

See also: TAIL

HEADER \rightarrow

Type: Command

Description: Header size: Returns the current size of the header in lines.

Access: \rightarrow CAT HEADER \rightarrow

Input/Output:

| Level 1/Argument 1 | | Level 1/Item 1 |
|--------------------|---------------|----------------|
| | \rightarrow | Header size |

See also: \rightarrow HEADER

\rightarrow **HEADER**

Type: Command

Description: Header size: Sets the current size of the header in lines: to 0, 1, or 2 lines.

Access: \rightarrow CAT \rightarrow HEADER

Input/Output:

| Level 1/Argument 1 | | Level 1/Item 1 |
|--------------------|---------------|----------------|
| Header size | \rightarrow | |

See also: HEADER \rightarrow

HELP

CAS: Display CAS operations and help information for them.

HERMITE

CAS: Return the *n*th Hermite polynomial.

HESS

CAS: Return the Hessian matrix and the gradient of an expression with respect to specified variables.

HEX

Type: Command

Description: Hexadecimal Mode Command: Selects hexadecimal base for binary integer operations. (The default base is decimal.)

Binary integers require the prefix #. Binary integers entered and returned in hexadecimal base automatically show the suffix h. If the current base is not hexadecimal, then you can enter a hexadecimal number by ending it with h. It will be displayed in the current base when it is entered.

The current base does not affect the internal representation of binary integers as unsigned binary numbers.

Access: \leftarrow MTH BASE HEX (\leftarrow MTH is the left-shift of the \square SYMB key).
 \leftarrow CONVERT BASE HEX (\leftarrow CONVERT is the left-shift of the \square 6 key).

Flags: Binary Integer Wordsize (-5 through -10), Binary Integer Base (-11, -12)

Input/Output: None

See also: BIN, DEC, OCT, RCWS, STWS

HILBERT

CAS: Return a square Hilbert matrix of specified order.

HISTOGRAM

Type: Command

Description: Histogram Plot Type Command: Sets the plot type to HISTOGRAM.

When the plot type is HISTOGRAM, the DRAW command creates a histogram using data from one column of the current statistics matrix (reserved variable ΣDAT). The column is specified by the first parameter in the reserved variable ΣPAR (using the XCOL command). The plotting parameters are specified in the reserved variable $PPAR$, which has the form:

$$\{ (x_{\min}, y_{\min}) (x_{\max}, y_{\max}) indep res axes ptype depend \}$$

For plot type HISTOGRAM, the elements of $PPAR$ are used as follows:

- (x_{\min}, y_{\min}) is a complex number specifying the lower left corner of $PICT$ (the lower left corner of the display range). The default value is $(-6.5, -3.1)$ for the hp48gII and $(-6.5, -3.9)$ for the hp49g+.
- (x_{\max}, y_{\max}) is a complex number specifying the upper right corner of $PICT$ (the upper right corner of the display range). The default value is $(6.5, 3.2)$ for the hp48gII and $(6.5, 4.0)$ for the hp49g+.
- *indep* is either a name specifying a label for the horizontal axis, or a list containing such a name and two numbers that specify the minimum and maximum values of the data to be plotted. The default value of *indep* is X .
- *res* is a real number specifying the bin size, in user-unit coordinates, or a binary integer specifying the bin size in pixels. The default value is 0, which specifies the bin size to be $1/13$ of the difference between the specified minimum and maximum values of the data.
- *axes* is a list containing one or more of the following, in the order listed: a complex number specifying the user-unit coordinates of the plot origin, a list specifying the tick-mark annotation, and two strings specifying labels for the horizontal and vertical axes. The default value is $(0, 0)$.
- *ptype* is a command name specifying the plot type. Executing the command HISTOGRAM places the command name HISTOGRAM in $PPAR$.
- *depend* is a name specifying a label for the vertical axis. The default value is Y .

The frequency of the data is plotted as bars, where each bar represents a collection of data points. The base of each bar spans the values of the data points, and the height indicates the number of data points. The width of each bar is specified by *res*. The overall maximum and minimum values for the data can be specified by *indep*; otherwise, the values in (x_{\min}, y_{\min}) and (x_{\max}, y_{\max}) are used.

Access: \rightarrow CAT HISTOGRAM

Input/Output: None

See also: BAR, CONIC, DIFFEQ, FUNCTION, GRIDMAP, PARAMETRIC, PARSURFACE, PCONTOUR, POLAR, SCATTER, SLOPEFIELD, TRUTH, WIREFRAME, YSLICE

HISTPLOT

Type: Command

Description: Draw Histogram Plot Command: Plots a frequency histogram of the specified column in the current statistics matrix (reserved variable ΣDAT).

The data column to be plotted is specified by XCOL and is stored as the first parameter in the reserved variable ΣPAR . If no data column is specified, column 1 is selected by default. The y -axis is autoscaled and the plot type is set to HISTOGRAM.

HISTPLOT plots *relative* frequencies, using 13 bins as the default number of partitions. The RES command lets you specify a different number of bins by specifying the bin width. To plot a frequency histogram with *numerical* frequencies, store the frequencies in ΣDAT and execute BINS and then BARPLOT.

When HISTPLOT is executed from a program, the graphics display, which shows the resultant plot, does not persist unless PICTURE, PVIEW (with an empty list argument), or FREEZE is subsequently executed.

Access: $\left[\rightarrow \right]$ $\left[\text{CAT} \right]$ HISTPLOT

Input/Output: None

See also: BARPLOT, BINS, FREEZE, PICTURE, PVIEW, RES, SCATRPLOT, XCOL

HMS-

Type: Command

Description: Hours-Minutes-Seconds Minus Command: Returns the difference of two real numbers, where the arguments and the result are interpreted in hours-minutes-seconds format.

The format for HMS (a time or an angle) is $H.MMSS_s$, where:

- H is zero or more digits representing the integer part of the number (hours or degrees).
- MM are two digits representing the number of minutes.
- SS are two digits representing the number of seconds.
- s is zero or more digits (as many as allowed by the current display mode) representing the decimal fractional part of seconds.

Access: $\left[\rightarrow \right]$ $\left[\text{TIME} \right]$ Tools $\left[\text{NXT} \right]$ HMS- ($\left[\text{TIME} \right]$ is the right-shift of the $\left[9 \right]$ key).

$\left[\rightarrow \right]$ & $\left[9 \right]$ $\left[\text{NXT} \right]$ HMS-

Input/Output:

| Level 2/Argument 1 | Level 1/Argument 2 | Level 1/Item 1 |
|--------------------|--------------------|-----------------|
| HMS_1 | HMS_2 → | $HMS_1 - HMS_2$ |

See also: HMS→, →HMS, HMS+

HMS+

Type: Command

Description: Hours-Minutes-Seconds Plus Command: Returns the sum of two real numbers, where the arguments and the result are interpreted in hours-minutes-seconds format.

The format for HMS (a time or an angle) is $H.MMSS_s$, where:

- H is zero or more digits representing the integer part of the number (hours or degrees).
- MM are two digits representing the number of minutes.
- SS are two digits representing the number of seconds.
- s is zero or more digits (as many as allowed by the current display mode) representing the decimal fractional part of seconds.

Access: $\left[\rightarrow \right]$ $\left[\text{TIME} \right]$ Tools $\left[\text{NXT} \right]$ HMS+ ($\left[\text{TIME} \right]$ is the right-shift of the $\left[9 \right]$ key).

$\left[\rightarrow \right]$ & $\left[9 \right]$ $\left[\text{NXT} \right]$ HMS+

Input/Output:

| Level 2/Argument 1 | Level 1/Argument 2 | Level 1/Item 1 |
|--------------------|--------------------|-----------------|
| HMS_1 | HMS_2 → | $HMS_1 + HMS_2$ |

See also: HMS→, →HMS, HMS–

HMS→

Type: Command

Description: Hours-Minutes-Seconds to Decimal Command: Converts a real number in hours-minutes-seconds format to its decimal form (hours or degrees with a decimal fraction).

The format for HMS (a time or an angle) is $H.MMSS_s$, where:

- H is zero or more digits representing the integer part of the number (hours or degrees).
- MM are two digits representing the number of minutes.
- SS are two digits representing the number of seconds.
- s is zero or more digits (as many as allowed by the current display mode) representing the decimal fractional part of seconds.

Access:   Tools  HMS→ ( is the right-shift of the  key).

 &   HMS→

Input/Output:

| Level 1/Argument 1 | | Level 1/Item 1 |
|--------------------|---|----------------|
| HMS | → | x |

See also: →HMS, HMS+, HMS–

→HMS

Type: Command

Description: Decimal to Hours-Minutes-Seconds Command: Converts a real number representing hours or degrees with a decimal fraction to hours-minutes-seconds format.

The format for HMS (a time or an angle) is $H.MMSS_s$, where:

- H is zero or more digits representing the integer part of the number.
- MM are two digits representing the number of minutes.
- SS are two digits representing the number of seconds.
- s is zero or more digits (as many as allowed by the current display mode) representing the decimal fractional part of seconds.

Access:   Tools  →HMS ( is the right-shift of the  key).

 &   →HMS

Input/Output:

| Level 1/Argument 1 | | Level 1/Item 1 |
|--------------------|---|----------------|
| x | → | HMS |

See also: HMS→, HMS+, HMS–

HOME

Type: Command

Description: HOME Directory Command: Makes the *HOME* directory the current directory.

Access:   HOME

 & 

Input/Output: None

See also: CRDIR, PATH, PGDIR, UPDIR

HORNER

CAS: Execute a Horner scheme;. for polynomial P , and number r , return $P/(x-r)$, r and $P(r)$.

i

Type: Function

Description: *i* Function: Returns the symbolic constant *i* or its numerical representation, (0, 1).

Access: \leftarrow i (i is the left-shift of the \leftarrow key).

Flags: Symbolic Constants (-2), Numerical Results (-3)

Input/Output:

| Level 1/Argument 1 | | Level 1/Item 1 |
|--------------------|---|----------------|
| | → | <i>i</i> |
| | → | (0,1) |

See also: *e*, MAXR, MINR, π

IABCUV

CAS: Return a solution in integers *u* and *v* of $au + bv = c$, where *a*, *b*, and *c* are integers.

IBASIS

CAS: Determine the basis of the intersection between two vector spaces.

IBERNOULLI

CAS: Return the *n*th Bernoulli number for a given integer *n*.

IBP

CAS: Integration by parts of a product of two functions, given the antiderivative of one function.

ICHINREM

CAS: Solve a system of two congruences in integers using the Chinese Remainder theorem.

IDN

Type: Command

Description: Identity Matrix Command: Returns an identity matrix; that is, a square matrix with its diagonal elements equal to 1 and its off-diagonal elements equal to 0.

The result is either a new square matrix, or an existing square matrix with its elements replaced by the elements of the identity matrix, according to the argument.

- Creating a new matrix: If the argument is a real number *n*, a new real identity matrix is returned, with its number of rows and number of columns equal to *n*.
- Replacing the elements of an existing matrix: If the argument is a square matrix, an identity matrix of the same dimensions is returned. If the original matrix is complex, the resulting identity matrix will also be complex, with diagonal values (1,0).
- If the argument is a name, the name must identify a variable containing a square matrix. In this case, the elements of the matrix are replaced by those of the identity matrix (complex if the original matrix is complex).

Access: \leftarrow MATRICES CREATE IDN (MATRICES is the left-shift of the \leftarrow key).

\leftarrow MTH MATRIX MAKE IDN (MTH is the left-shift of the \leftarrow key).

Input/Output:

| Level 1/Argument 1 | | Level 1/Item 1 |
|--------------------|---|------------------------------------|
| <i>n</i> | → | [[R-matrix _{identity}]] |
| [[matrix]] | → | [[matrix _{identity}]] |
| 'name' | → | [[matrix _{identity}]] |

See also: CON

IDIV2

CAS: For two integers, a and b , return the integer part of a/b , and the remainder, r .

IEGCD

CAS: Given integers x and y , return integers, a , b , and c , where $ax+by=c$ and, c is the GCD of x and y .

IF

Type: Command Operation

Description: IF Conditional Structure Command: Starts IF ... THEN ... END and IF ... THEN ... ELSE ... END conditional structures.

Conditional structures, used in combination with program tests, enable a program to make decisions.

- IF ... THEN ... END executes a sequence of commands only if a test returns a nonzero (true) result. The syntax is:

IF *test-clause* THEN *true-clause* END

IF begins the test clause, which must return a test result to the stack. THEN removes the test result from the stack. If the value is nonzero, the true clause is executed. Otherwise, program execution resumes following END.

- IF ... THEN ... ELSE ... END executes one sequence of commands if a test returns a true (nonzero) result, or another sequence of commands if that test returns a false (zero) result. The syntax is:

IF *test-clause* THEN *true-clause* ELSE *false-clause* END

IF begins the test clause, which must return a test result to the stack. THEN removes the test result from the stack. If the value is nonzero, the true clause is executed. Otherwise, the false clause is executed. After the appropriate clause is executed, execution resumes following END.

In RPL mode, the test clause can be a command sequence (for example, $A \leq B$) or an algebraic (for example, 'A ≤ B'). If the test clause is an algebraic, it is *automatically evaluated* to a number (→NUM or EVAL isn't necessary).

Access:   BRANCH IF ( is the left-shift of the  key).

Input/Output:

| Level 1/Argument 1 | Level 1/Item 1 |
|--------------------|----------------|
| IF | → |
| THEN | T/F → |
| END | |
| IF | |
| THEN | T/F → |
| ELSE | → |
| END | → |

See also: CASE, ELSE, END, IFERR, THEN

IFERR

Type: Command

Description: If Error Conditional Structure Command: Starts IFERR ... THEN ... END and IFERR ... THEN ... ELSE ... END error trapping structures.

Error trapping structures enable program execution to continue after a “trapped” error occurs.

- IFERR ... THEN ... END executes a sequence of commands if an error occurs. The syntax of IFERR ... THEN ... END is:

IFERR *trap-clause* THEN *error-clause* END

If an error occurs during execution of the trap clause:

- 1 The error is ignored.
- 2 The remainder of the trap clause is discarded.
- 3 The key buffer is cleared.
- 4 If any or all of the display is “frozen” (by FREEZE), that state is cancelled.
- 5 If Last Arguments is enabled, the arguments to the command that caused the error are returned to the stack.
- 6 Program execution jumps to the error clause.

The commands in the error clause are executed only if an error is generated during execution of the trap clause.

- IFERR ... THEN ... ELSE ... END executes one sequence of commands if an error occurs or another sequence of commands if an error does not occur. The syntax of IFERR ... THEN ... ELSE ... END is:

IFERR *trap-clause* THEN *error-clause* ELSE *normal-clause* END

If an error occurs during execution of the trap clause, the same six events listed above occur.

If no error occurs, execution jumps to the normal clause at the completion of the trap clause.

Access:  PRG   ERROR [IFERR] IFERR ( is the left-shift of the  key).

Flags: Last Arguments (-55)

Input/Output: None

See also: CASE, ELSE, END, IF, THEN

IFFT

Type: Command

Description: Inverse Discrete Fourier Transform Command: Computes the one- or two-dimensional inverse discrete Fourier transform of an array.

If the argument is an N -vector or an $N \times 1$ or $1 \times N$ matrix, IFFT computes the one-dimensional inverse transform. If the argument is an $M \times N$ matrix, IFFT computes the two-dimensional inverse transform. M and N must be integral powers of 2.

The one-dimensional inverse discrete Fourier transform of an N -vector Y is the N -vector X where:

$$X_n = \frac{1}{N} \sum_{k=0}^{N-1} Y_k e^{\frac{2\pi i k n}{N}}, i = \sqrt{-1}$$

for $n = 0, 1, \dots, N-1$.

The two-dimensional inverse discrete Fourier transform of an $M \times N$ matrix Y is the $M \times N$ matrix X where:

$$X_{mn} = \frac{1}{MN} \sum_{k=0}^{M-1} \sum_{l=0}^{N-1} Y_{kl} e^{\frac{2\pi i k m}{M}} e^{\frac{2\pi i l n}{N}}, i = \sqrt{-1}$$

for $m = 0, 1, \dots, M-1$ and $n = 0, 1, \dots, N-1$.

The discrete Fourier transform and its inverse are defined for any positive sequence length.

However, the calculation can be performed very rapidly when the sequence length is a power of

two, and the resulting algorithms are called the fast Fourier transform (FFT) and inverse fast Fourier transform (IFFT).

The IFFT command uses truncated 15-digit arithmetic and intermediate storage, then rounds the result to 12-digit precision.

Access: \leftarrow MTH \leftarrow NXT FFT IFFT (\leftarrow MTH is the left-shift of the \leftarrow SYMB key).

Input/Output:

| Level 1/Argument 1 | Level 1/Item 1 |
|--------------------|-------------------------|
| $[array]_1$ | $\rightarrow [array]_2$ |

See also: FFT

IFT

Type: Command

Description: IF-THEN Command: Executes *obj* if *T/F* is nonzero. Discards *obj* if *T/F* is zero.

IFT lets you execute in stack syntax the decision-making process of the IF ... THEN ... END conditional structure. The “true clause” is *obj* in argument 2 (level 1).

Access: \leftarrow PRG BRANCH IFT (\leftarrow PRG is the left-shift of the \leftarrow EVAL key).

Input/Output:

| Level 2/Argument 1 | Level 1/Argument 2 | Level 1/Item 1 |
|--------------------|--------------------|--------------------|
| <i>T/F</i> | <i>obj</i> | <i>It depends!</i> |

See also: IFTE

IFTE

Type: Function

Description: IF-THEN-ELSE Function: Executes the *obj* in argument 2 or level 2 if *T/F* is nonzero. Executes the *obj* in argument 3 or level 1 if *T/F* is zero.

IFTE lets you execute in stack syntax the decision-making process of the IF ... THEN ... ELSE ... END conditional structure. The “true clause” is *obj_{true}* in argument 2 or level 2. The “false clause” is *obj_{false}* in argument 3 or level 1.

IFTE is also allowed in algebraic expressions, with the following syntax:

$$\text{IFTE}(test, true-clause, false-clause)$$

When an algebraic containing IFTE is evaluated, its first argument *test* is evaluated to a test result. If it returns a nonzero real number, *true-clause* is evaluated. If it returns zero, *false-clause* is evaluated.

Access: \leftarrow PRG BRANCH \leftarrow NXT IFTE (\leftarrow PRG is the left-shift of the \leftarrow EVAL key).

Input/Output:

| Level 3/Argument 1 | Level 2/Argument 2 | Level 1/Argument 3 | Level 1/Item 1 |
|--------------------|---------------------------|----------------------------|----------------------------------|
| <i>T/F</i> | <i>obj_{true}</i> | <i>obj_{false}</i> | \rightarrow <i>It depends!</i> |

See also: IFT

ILAP

CAS: Return the inverse Laplace transform of an expression that evaluates to a rational fraction.

IM

Type: Function

Description: Imaginary Part Function: Returns the imaginary part of its complex argument.

If the argument is an array, IM returns a real array, the elements of which are equal to the imaginary parts of the corresponding elements of the argument array. If the argument array is real, all of the elements of the result array are zero.

Access: $\boxed{\rightarrow}$ CMPLX IM (CMPLX is the right-shift of the \boxed{I} key).

Flags: Numerical Results (-3)

Input/Output:

| Level 1/Argument 1 | | Level 1/Item 1 |
|--------------------|---------------|---------------------|
| x | \rightarrow | 0 |
| (x, y) | \rightarrow | y |
| [R-array] | \rightarrow | [R-array] |
| [C-array] | \rightarrow | [R-array] |
| ' <i>symb</i> ' | \rightarrow | 'IM(<i>symb</i>)' |

See also: C→R, RE, R→C

IMAGE

CAS: Compute the basis of the image (also called the range) of a linear application.

INCR

Type: Command

Description: Increment Command: Takes a variable, adds 1, stores the new value back into the original variable, and returns the new value.

The value in *name* must be a real number or an integer.

Access: $\boxed{\leftarrow}$ PRG MEMORY ARITHMETIC INCR (PRG is the left-shift of the $\boxed{\text{EVAL}}$ key).

Input/Output:

| Level 1/Argument 1 | | Level 1/Item 1 |
|--------------------|---------------|------------------------|
| ' <i>name</i> ' | \rightarrow | $X_{\text{increment}}$ |

See also: DECR

INDEP

Type: Command

Description: Independent Variable Command: Specifies the independent variable and its plotting range.

The specification for the independent variable name and its plotting range is stored as the third parameter in the reserved variable *PPAR*. If the argument to INDEP is a:

- Global variable name, that name replaces the independent variable entry in *PPAR*.
- List containing a global name, that name replaces the independent variable name but leaves unchanged any existing plotting range.
- List containing a global name and two real numbers, that list replaces the independent variable entry.
- List containing two real numbers, or two real numbers from levels 1 and 2, those two numbers specify a new plotting range, leaving the independent variable name unchanged. (LASTARG returns a list, even if the two numbers were entered separately.)

The default entry is *X*.

Access: $\boxed{\rightarrow}$ CAT INDEP

Input/Output:

| Level 2/Argument 1 | Level 1/Argument 2 | Level 1/Item 1 |
|--------------------|--------------------------|----------------|
| | 'global' | → |
| | { global } | → |
| | { global x_start x_end } | → |
| | { x_start x_end } | → |
| x_start | x_end | → |

See also: DEPND

INFORM

Type: Command

Description: User-Defined Dialog Box Command: Creates a user-defined input form (dialog box).

INFORM creates a standard dialog box based upon the following specifications:

| Variable | Function |
|--|---|
| "title" | Title. This appears at the top of the dialog box. |
| { j ₁ j ₂ ... j _n } | Field definitions. A field definition (j _x) can have two formats: "label", a field label, or { "label" "helpInfo" type ₁ type ₂ ... type _n }, a field label with optional help text that appears near the bottom of the screen, and an optional list of valid object types for that field. If object types aren't specified, all object types are valid. For information about object types, see the TYPE command. When creating a multi-column dialog box, you can span columns by using an empty list as a field definition. A field that appears to the left of an empty field automatically expands to fill the empty space. |
| format | Field format information. This is the number col or a list of the form { col tabs }: col is the number of columns the dialog box has, and tabs optionally specifies the number of tab stops between the labels and the highlighted fields. This list can be empty. col defaults to 1 and tabs defaults to 3. |
| { resets } | Default values displayed when RESET is selected. Specify reset values in the list in the same order as the fields were specified. To specify no value, use the NOVAL command as a place holder. This list can be empty. |
| { init } | Initial values displayed when the dialog box appears. Specify initial values in the list in the same order as the fields were specified. To specify no value, use the NOVAL command as a place holder. This list can be empty. |

If you exit the dialog box by selecting OK or , INFORM returns the field values { vals } in item 1 or level 2, and puts a 1 in item 2 or level 1. (If a field is empty, NOVAL is returned as a place holder.) If you exit the dialog box by selecting CANCEL or , INFORM returns 0.

Access: PRG IN INFORM (is the left-shift of the key).

Input/Output:

| L ₅ /A ₁ | L ₄ /A ₂ | L ₃ /A ₃ | L ₂ /A ₄ | L ₁ /A ₅ | L ₂ /I ₁ | L ₁ /I ₂ |
|--------------------------------|--|--------------------------------|--------------------------------|--------------------------------|--------------------------------|--------------------------------|
| "title" | { j ₁ j ₂ ... j _n } | format | { resets } | { init } | → | { vals } 1 |
| "title" | { j ₁ j ₂ ... j _n } | format | { resets } | { init } | → | 0 |

L = Level; A = Argument; I = item

See also: CHOOSE, INPUT, NOVAL, TYPE

INPUT

Type: Command

Description: Input Command: Prompts for data input to the command line and prevents the user access to stack operations.

When INPUT is executed, the stack or history area is blanked and program execution is suspended for data input to the command line. The contents of “*stack prompt*” are displayed at the top of the screen. Depending on the second argument (level 1), the command line may also contain the contents of a string, or it may be empty. Pressing **ENTER** resumes program execution and returns the contents of the command line in string form.

In its general form, the second argument (level 1) for INPUT is a list that specifies the content and interpretation of the command line. The list can contain *one or more* of the following parameters, *in any order*:

- “*command-line prompt*”, whose contents are placed on the command line for prompting when the program pauses.
- Either a *real number*, or a *list containing two real numbers*, that specifies the initial cursor position on the command line:
 - A real number *n* at the *n*th character from the left end of the first row (line) of the command line. A *positive n* specifies the insert cursor; a *negative n* specifies the replace cursor. 0 specifies the end of the command-line string.
 - A list that specifies the initial row and column position of the cursor: the first number in the list specifies a row in the command line (1 specifies the first row of the command line); the second number counts by characters from the left end of the specified line. 0 specifies the end of the command-line string in the specified row. A positive row number specifies the insert cursor; a negative row number specifies the replace cursor.
- One or more of the parameters ALG, α , or V, entered as unquoted names:
 - ALG activates Algebraic/Program-entry mode.
 - α specifies alpha lock.
 - V verifies if the characters in the result string “result”, without the “” delimiters, compose a valid object or objects. If the result-string characters do not compose a valid object or objects, INPUT displays the Invalid Syntax warning and prompts again for data.

You can choose to specify as few as one of the argument 2 (level 1) list parameters. The default states for these parameters are:

- Blank command line.
- Insert cursor placed at the end of the command-line prompt string.
- Program-entry mode.
- Result string not checked for invalid syntax.

If you specify *only* a command-line prompt string for the second argument (level 1), you don't need to put it in a list.

Access: **←** **PRG** **NXT** IN INPUT (**PRG** is the left-shift of the **EVAL** key).

Input/Output:

| Level 2/Argument 1 | Level 1/Argument 2 | | Level 1/Item 1 |
|-------------------------|---|---|-------------------|
| “ <i>stack prompt</i> ” | “ <i>command-line prompt</i> ” | → | “ <i>result</i> ” |
| “ <i>stack prompt</i> ” | { <i>list</i> _{command-line} } | → | “ <i>result</i> ” |

See also: PROMPT, STR→

INT

CAS: Calculate the antiderivative of a function for a given variable at a given point.

INTEGER

CAS: Display a menu or list of CAS integer operations.

INTVX

CAS: Find the antiderivative of a function symbolically, with respect to the current default variable.

INV

Type: Analytic function

Description: Inverse (1/x) Analytic Function: Returns the reciprocal or the matrix inverse.

For a *complex* argument (x, y) , the inverse is the complex number:

$$\left(\frac{x}{x^2 + y^2}, \frac{-y}{x^2 + y^2} \right)$$

Matrix arguments must be square (real or complex). The computed inverse matrix A^{-1} satisfies $A \times A^{-1} = I_n$, where I_n is the $n \times n$ identity matrix.

Access: $\boxed{1/X}$

Flags: Numerical Results (-3)

Input/Output:

| Level 1/Argument 1 | | Level 1/Item 1 |
|-----------------------|---------------|-------------------------------------|
| z | \rightarrow | $1/z$ |
| $[[\text{matrix}]]$ | \rightarrow | $[[\text{matrix}]]$ ⁻¹ |
| ' <i>symb</i> ' | \rightarrow | 'INV(<i>symb</i>)' |
| <i>x_unit</i> | \rightarrow | 1/ <i>x_1</i> / <i>unit</i> |

See also: SINV, /

INVMOD

CAS: Perform modular inversion on an object, modulo the current modulus.

IP

Type: Function

Description: Integer Part Function: Returns the integer part of its argument.

The result has the same sign as the argument.

Access: $\boxed{\leftarrow}$ MTH REAL $\boxed{\text{NXT}}$ IP (MTH is the left-shift of the $\boxed{\text{SYMB}}$ key).

Flags: Numerical Results (-3)

Input/Output:

| Level 1/Argument 1 | | Level 1/Item 1 |
|--------------------|---------------|---------------------|
| x | \rightarrow | n |
| <i>x_unit</i> | \rightarrow | <i>n_unit</i> |
| ' <i>symb</i> ' | \rightarrow | 'IP(<i>symb</i>)' |

See also: FP

IQUOT

CAS: Return the integer (or Euclidean) quotient of integers a, b ; the integer part of a/b .

IREMAINDER

CAS: Return the remainder of the division of one integer by another.

ISOL

Type: Command

Description: Isolate Variable Command: Returns an algebraic $symb_2$ that rearranges $symb_1$ to “isolate” the first occurrence of variable $global$.

The result $symb_2$ is an equation of the form $global = expression$. If $global$ appears more than once, then $symb_2$ is effectively the right side of an equation obtained by rearranging and solving $symb_1$ to isolate the first occurrence of $global$ on the left side of the equation.

If $symb_1$ is an expression, it is treated as the left side of an equation $symb_1 = 0$.

If $global$ appears in the argument of a function within $symb_1$, that function must be an *analytic* function, that is, a function for which the hp49g+/hp48gII provides an inverse. Thus ISOL cannot solve $IP(x)=0$ for x , since IP has no inverse.

ISOL is identical to SOLVE.

Access: \leftarrow S.SLV ISOL (S.SLV is the left-shift of the $\boxed{7}$ key).

Flags: Principal Solution (-1), Numerical Results (-3)

Input/Output:

| Level 2/Argument 1 | Level 1/Argument 2 | Level 1/Item 1 |
|--------------------|----------------------------|----------------|
| ' $symb_1$ ' | ' $global$ ' \rightarrow | ' $symb_2$ ' |

See also: COLCT, EXPAN, QUAD, SHOW, SOLVE

ISOM

CAS: Determine the characteristics of a 2-d or 3-d linear isometry.

ISPRIME?

CAS: Test if a number is prime. For large numbers test if the number is pseudoprime.

I→R

Type: Function

Description: Converts an integer into a real number.

Access: \leftarrow CONVERT REWRITE

Flags: Exact mode must be set (flag -105 clear). Numeric mode must not be set (flag -3 clear). The flags affect the output only if the input is not an integer.

Input: Level 1/Argument 1: An integer.

Output: Level 1/Item 1: The integer converted to a real number.

See also: →NUM, R→I, XNUM

JORDAN

CAS: Diagonalization, or Jordan cycle decomposition, of a matrix.

KER

CAS: Compute the basis of the kernel of a linear application.

KERRM

Type: Command

Description: Kermit Error Message Command: Returns the text of the most recent Kermit error packet.

If a Kermit transfer fails due to an error packet sent from the connected Kermit device to the hp49g+/hp48gII, then executing KERRM retrieves and displays the error message. (Kermit errors not in packets are retrieved by ERRM rather than KERRM.)

Access: \leftarrow CAT KERRM

Input/Output:



| Level 1/Argument 1 | Level 1/Item 1 |
|--------------------|-------------------------------|
| | \rightarrow "error message" |

See also: FINISH, KGET, PKT, RECN, RECV, SEND, SERVER

KEY

Type: Command

Description: Key Command: Returns a test result and, if a key is pressed, returns the row-column location $x_{n,m}$ of that key.

KEY returns a false result (0) to item 2 (stack level 1) until a key is pressed. When a key is pressed, it returns a true result (1) to item 2 (stack level 1) and $x_{n,m}$ to item 1 (stack level 2). The result $x_{n,m}$ is a two- or three-digit number that identifies the row and column location of the key just pressed. Unlike WAIT, which returns a three-digit number that identifies alpha and shifted keyboard planes, KEY returns the row-column location of *any* key pressed, including , , and .

Access:    IN KEY ( is the left-shift of the  key).

Input/Output:

| Level 1/Argument 1 | Level 2/Item 1 | Level 1/Item 2 |
|--------------------|----------------|----------------|
| | → | $x_{n,m}$ |
| | → | 1 |
| | → | 0 |

See also: WAIT, KEYEVAL

KEYEVAL

Type: Command

Description: Actions the specified key press.

You input a number, in the format *ab.c*, that represents the key. In the number *ab.c*:

- *a* is the row coordinate number, where row 1 is the top-most row.
- *b* is the column number, where column 1 is the left-most column.
- *c* is the shift state of the key, i.e., whether it is normal, alpha-shifted, left shifted, etc.

The shift state representations are as follows:

- | | |
|--------------------------------|--|
| 1: Normal function. | 21: Left shift-and-hold function. |
| 2: Left-shift function. | 31: Right shift-and-hold function. |
| 3: Right-shift function. | 41: Alpha shift-and-hold function. |
| 4: Alpha-function. | 51: Alpha-left-shift-and-hold function. |
| 5: Alpha-left-shift function. | 61: Alpha-right-shift-and-hold function. |
| 6: Alpha-right-shift function. | |

The sign of the input controls whether USER mode key assignments are used. Positive inputs specify the USER mode key definition. Negative inputs specify the default system keyboard.

Access:   KEYEVAL

Input/Output:

| Level 1/Argument 1 | Level 1/Item 1 |
|--------------------|----------------|
| <i>m.n</i> | → |

Example: Turn the calculator off using a command.

Command: KEYEVAL (101.3)

Result: The calculator is turned off.

→KEYTIME

Type: Command

Description: This command is provided for compatibility with earlier calculators, but does nothing on the hp49g+/hp48gII.

KEYTIME→

Type: Command

Description: This command is provided for compatibility with earlier calculators, but does nothing on the hp49g+/hp48gII.

KGET

Type: Command

Description: Kermit Get Command: Used by a local Kermit to get a Kermit server to transmit the named object(s).

To rename an object when the local device gets it, include the old and new names in an embedded list. For example, {{ AAA BBB }} KGET gets the variable named *AAA* but changes its name to *BBB*. {{ AAA BBB } CCC } KGET gets *AAA* as *BBB* and gets *CCC* under its own name. (If the original name is not legal on the hp49g+/hp48gII, enter it as a string.)

Access:   KGET

Flags: I/O Device (-33), RECV Overwrite (-36), I/O Messages (-39)

Input/Output:

| Level 1/Argument 1 | Level 1/Item 1 |
|---|----------------|
| 'name' | → |
| "name" | → |
| { name _{old} name _{new} } | → |
| { name ₁ ... name _n } | → |
| {{ name _{old} name _{new} } name ... } | → |

See also: BAUD, CKSM, FINISH, PARITY, RECN, RECV, SEND, SERVER, TRANSIO

KILL

Type: Command

Description: Cancel Halted Programs Command: Cancels all currently halted programs. If KILL is executed within a program, that program is also canceled.

Canceled programs cannot be resumed.

KILL cancels *only* halted programs and the program from which KILL was executed, if any.

Commands that halt programs are HALT and PROMPT.

Suspended programs cannot be canceled. Commands that suspend programs are INPUT and WAIT.

Access:     RUN & DEBUG KILL ( is the left-shift of the  key).

Input/Output: None

See also: CONT, DOERR, HALT, PROMPT

LABEL

Type: Command

Description: Label Axes Command: Labels axes in *PICT* with *x*- and *y*-axis variable names and with the minimum and maximum values of the display ranges.

The horizontal axis name is chosen in the following priority order:



1. If the *axes* parameter in the reserved variable *PPAR* is a list, then the *x*-axis element from that list is used.

2. If *axes* parameter is not a list, then the independent variable name in *PPAR* is used.

The vertical axis name is chosen in the following priority order:

1. If the *axes* parameter in *PPAR* is a list, then the *y*-axis element from that list is used.

2. If *axes* is not a list, then the dependent variable name from *PPAR* is used.

Access:   LABEL

Input/Output: None

See also: AXES, DRAW, DRAX

LAGRANGE

CAS: Return the interpolating polynomial of minimum degree for a set of pairs of values.

LANGUAGE→

Type: Command

Description: Language: Returns the language that is currently set. 0 for English, 1 for French, and 2 for Spanish.

Access: $\boxed{\rightarrow}$ CAT LANGUAGE→

Input/Output:

| Level 1/Argument 1 | Level 1/Item 1 |
|--------------------|----------------|
| | <i>value</i> |

See also: →LANGUAGE

→LANGUAGE

Type: Command

Description: Language: Sets the language for things such as error messages: 0 for English, 1 for French, and 2 for Spanish.

Access: $\boxed{\rightarrow}$ CAT →LANGUAGE

Input/Output:

| Level 1/Argument 1 | Level 1/Item 1 |
|--------------------|----------------|
| <i>value</i> | |

See also: LANGUAGE→

LAP

CAS: Perform a Laplace transform on an expression with respect to the current default variable.

LAPL

CAS: Return the Laplacian of a function with respect to a list of variables.

LAST

Type: Command

Description: Returns copies of the arguments of the most recently executed command.

LAST is provided for compatibility with the HP28S. LAST is the same as LASTARG.

Access: None. Must be typed in.

Flags: Last Arguments (-55)

Input/Output:

| Level 1 | Level n | ... | Level 1 |
|---------|------------------------|-----|------------------------|
| | <i>obj_n</i> | ... | <i>obj_i</i> |

See also: ANS, LASTARG

LASTARG

Type: Command

Description: Returns copies of the arguments of the most recently executed command.

The objects return to the same stack levels that they originally occupied. Commands that take no arguments leave the current saved arguments unchanged. When LASTARG follows a command that evaluates an algebraic expression or program, the last arguments saved are from the evaluated algebraic expression or program, not from the original command.

Access: $\boxed{\rightarrow}$ CAT LASTARG

$\boxed{\leftarrow}$ PRG NXT NXT ERROR LASTA

(PRG is the left-shift of the EQV key).

$\boxed{\leftarrow}$ ANS in RPN mode.

(ANS is the left-shift of the ENTER key).

Flags: Last Arguments (-55)

Input/Output:

| | | | |
|---------|---------|---------|---------|
| Level 1 | Level n | ... | Level 1 |
| | → | obj_n | obj_i |

See also: ANS, LAST

LCD→

Description: LCD to Graphics Object Command: Returns the current stack and menu display as a 131×80 (on the hp49g+) or 131×64 (on the hp48gII) graphics object.

Access: \leftarrow PRG \leftarrow NXT GROB \leftarrow NXT LCD→ (PRG is the left-shift of the EVAL key).

Input/Output:

| | |
|--------------------|----------------|
| Level 1/Argument 1 | Level 1/Item 1 |
| | → $grob$ |

See also: →GROB, →LCD

→LCD

Type: Command

Description: Graphics Object to LCD Command: Displays the specified graphics object with its upper left pixel in the upper left corner of the display. If the graphics object is larger than 131×72 (on the hp49g+) or 131×56 (on the hp48gII), it is truncated.

Access: \leftarrow PRG \leftarrow NXT GROB \leftarrow NXT →LCD (PRG is the left-shift of the EVAL key).

Input/Output:

| | |
|--------------------|----------------|
| Level 1/Argument 1 | Level 1/Item 1 |
| $grob$ | → |

See also: BLANK, →GROB, LCD→

LCM

CAS: Return the least common multiple of two objects.

LCXM

CAS: From a program with arguments i, j , build a matrix of specified size, with elements a_{ij} .

LDEC

CAS: Solve linear differential equation (LDE), or system of first order LDEs, with constant coefficients.

LEGENDRE

CAS: Return the n th degree Legendre polynomial.

LGCD

CAS: Return the greatest common divisor of a list of expressions or values.

LIBEVAL

Type: Command

Description: Evaluate Library Function Command: Evaluates unnamed library functions.

WARNING: Use extreme care when executing this function. Using LIBEVAL with random addresses will almost always cause a memory loss. Do not use this function unless you know what you are doing.

$\#n_{\text{function}}$ is of the form $lllfffh$, where lll is the library number, and fff the function number.

Access: \leftarrow CAT LIBEVAL

Input/Output:

| | |
|---------------------------|-----------------------|
| Level 1/Argument 1 | Level 1/Item 1 |
| $\#n_{\text{function}}$ | → |

See also: EVAL, FLASHEVAL, SYSEVAL

LIBS

Type: Command

Description: Libraries Command: Lists the title, number, and port of each library attached to the current directory. The title of a library often takes the form *LIBRARY-NAME : Description*. A library without a title is displayed as " ".

Access:  CAT LIBS

Input/Output:

| | |
|---------------------------|---|
| Level 1/Argument 1 | Level 1/Item 1 |
| → | $\{ \text{"title"}, n_{\text{lib}}, n_{\text{port}}, \dots, \text{"title"}, n_{\text{lib}}, n_{\text{port}} \}$ |

See also: ATTACH, DETACH

lim

CAS: Return the limit of a function as its argument approaches a specified value.

LIMIT

CAS: Return the limit of a function as its argument approaches a specified value. Identical to lim.

LIN

CAS: Linearize expressions involving combinations of exponential terms.

LINE

Type: Command Operation

Description: Draw Line Command: Draws a line in *PICT* between the input coordinates.

Access:  PRG  PICT LINE (PRG is the left-shift of the  key).

Input/Output:

| | | |
|---------------------------|---------------------------|-----------------------|
| Level 2/Argument 1 | Level 1/Argument 2 | Level 1/Item 1 |
| (x_1, y_1) | (x_2, y_2) | → |
| $\{ \#n_1, \#m_1 \}$ | $\{ \#n_2, \#m_2 \}$ | → |

See also: ARC, BOX, TLINE

ΣLINE

Type: Command

Description: Regression Model Formula Command: Returns an expression representing the best fit line according to the current statistical model, using *X* as the independent variable name, and explicit values of the slope and intercept taken from the reserved variable *ΣPAR*. For each curve fitting model, the following table indicates the form of the expression returned by ΣLINE, where *m* is the slope, *x* is the independent variable, and *b* is the intercept.

| Model | Form of Expression |
|--------|--------------------|
| LINFIT | $mx + b$ |
| LOGFIT | $m \ln(x) + b$ |
| EXPFIT | be^{mx} |
| PWRFIT | bx^m |

Access:  CAT ΣLINE

Input/Output:

| Level 1/Argument 1 | Level 1/Item 1 |
|--------------------|------------------------------------|
| | ' <i>symb</i> ' _{formula} |

See also: BESTFIT, COLΣ, CORR, COV, EXPFIT, LINFIT, LOGFIT, LR, PREDX, PREDY, PWRFIT, XCOL, YCOL

LINFIT

Type: Command

Description: Linear Curve Fit Command: Stores LINFIT as the fifth parameter in the reserved variable ΣPAR, indicating that subsequent executions of LR are to use the linear curve fitting model. LINFIT is the default specification in ΣPAR.

Access: $\boxed{\rightarrow}$ $\boxed{\underline{\text{CAT}}}$ LINFIT

Input/Output: None

See also: BESTFIT, EXPFIT, LOGFIT, LR, PWRFIT

LININ

Type: Function

Description: Linear Test Function: Tests whether an algebraic is structurally linear for a given variable. If any two subexpressions containing a variable (*name*) are combined only with addition and subtraction, and any subexpression containing the variable is at most multiplied or divided by another factor not containing the variable, the algebraic (*symb*) is determined to be linear for that variable. LININ returns a 1 if the algebraic is linear for the variable, and a 0 if not.

Access: $\boxed{\leftarrow}$ $\boxed{\text{PRG}}$ TEST $\boxed{\leftarrow}$ $\boxed{\text{PREV}}$ LININ ($\boxed{\text{PRG}}$ is the left-shift of the $\boxed{\text{EVAL}}$ key).

Input/Output:

| Level 2/Argument 1 | Level 1/Argument 2 | Level 1/Item 1 |
|--------------------|--------------------|----------------|
| ' <i>symb</i> ' | ' <i>name</i> ' | 0/1 |

LINSOLVE

CAS: Solve a system of linear equations.

LIST→

Type: Command

Description: List to Stack Command: Takes a list of *n* objects and returns each object to a separate level, and returns the total number of objects to item *n*+1 (stack level 1). The command OBJ→ also provides this function.

Access: $\boxed{\rightarrow}$ $\boxed{\underline{\text{CAT}}}$ LIST→

Input/Output:

| Level 1/Argument 1 | Level _{<i>n</i>+1} /Item ₁ ... | Level ₂ /Item _{<i>n</i>} | Level ₁ /Item _{<i>n</i>+1} |
|---|--|--|--|
| { <i>obj</i> ₁ , ..., <i>obj</i> _{<i>n</i>} } | → <i>obj</i> ₁ ... | <i>obj</i> _{<i>n</i>} | <i>n</i> |

See also: ARRAY→, DTAG, EQ→, →LIST, OBJ→, STR→

→LIST

Type: Command

Description: Stack to List Command: Takes *n* specified objects and returns a list of those objects.

Access: $\boxed{\leftarrow}$ $\boxed{\text{PRG}}$ TYPE →LIST ($\boxed{\text{PRG}}$ is the left-shift of the $\boxed{\text{EVAL}}$ key).

$\boxed{\leftarrow}$ $\boxed{\text{PRG}}$ LIST →LIST ($\boxed{\text{PRG}}$ is the left-shift of the $\boxed{\text{EVAL}}$ key).

Input/Output:

| Level _{n+1} /Argument ₁ ... Level ₂ /Argument _n | Level ₁ /Argument _{n+1} | Level 1/Item 1 |
|---|---|---|
| $obj_1 \dots obj_n$ | n | $\rightarrow \{ obj_1, \dots, obj_n \}$ |

See also: \rightarrow ARRY, LIST \rightarrow , \rightarrow STR, \rightarrow TAG, \rightarrow UNIT

Δ LIST

Type: Command

Description: List Differences Command: Returns the first differences of the elements in a list. Adjacent elements in the list must be suitable for mutual subtraction.

Access: \leftarrow MTH LIST Δ LIST (\leftarrow MTH is the left-shift of the $\left[$ SYMB key).

Input/Output:

| Level 1/Argument 1 | Level 1/Item 1 |
|--------------------|---------------------------------|
| $\{ list \}$ | $\rightarrow \{ differences \}$ |

See also: Σ LIST, Π LIST, STREAM

Π LIST

Type: Command

Description: List Product Command: Returns the product of the elements in a list. The elements in the list must be suitable for mutual multiplication.

Access: \leftarrow MTH LIST Π LIST (\leftarrow MTH is the left-shift of the $\left[$ SYMB key).

Input/Output:

| Level 1/Argument 1 | Level 1/Item 1 |
|--------------------|-----------------------|
| $\{ list \}$ | $\rightarrow product$ |

See also: Σ LIST, Δ LIST, STREAM

Σ LIST

Type: Command

Description: List Sum Command: Returns the sum of the elements in a list. The elements in the list must be suitable for mutual addition.

Access: \leftarrow MTH LIST Σ LIST (\leftarrow MTH is the left-shift of the $\left[$ SYMB key).

Input/Output:

| Level 1/Argument 1 | Level 1/Item 1 |
|--------------------|-------------------|
| $\{ list \}$ | $\rightarrow sum$ |

See also: Π LIST, STREAM

LN

Type: Analytic function

Description: Natural Logarithm Analytic Function: Returns the natural (base e) logarithm of the argument. For $x = 0$ or $(0, 0)$, an Infinite Result exception occurs, or, if flag -22 is set, -MAXR is returned. The inverse of EXP is a *relation*, not a function, since EXP sends more than one argument to the same result. The inverse relation for EXP is the *general solution*:

$$\text{LN}(Z) + 2\pi \cdot i \cdot n1$$

The function LN is the inverse of a *part* of EXP, a part defined by restricting the domain of EXP such that: each argument is sent to a distinct result, and each possible result is achieved. The points in this restricted domain of EXP are called the *principal values* of the inverse relation. LN in its entirety is called the *principal branch* of the inverse relation, and the points sent by LN to the boundary of the restricted domain of EXP form the *branch cuts* of LN. The principal branch used by the hp49g+/hp48gII for LN was chosen because it is analytic in the regions where the arguments of the *real-valued* inverse function are defined. The branch cut

for the complex-valued natural log function occurs where the corresponding real-valued function is undefined. The principal branch also preserves most of the important symmetries. The graphs below show the domain and range of LN. The graph of the domain shows where the branch cut occurs: the heavy solid line marks one side of the cut, while the feathered lines mark the other side of the cut. The graph of the range shows where each side of the cut is mapped under the function.

These graphs show the inverse relation $\text{LN}(Z) + 2\pi i n$ for the case $n=0$. For other values of n , the horizontal band in the lower graph is translated up (for n positive) or down (for n negative). Taken together, the bands cover the whole complex plane, which is the domain of EXP.

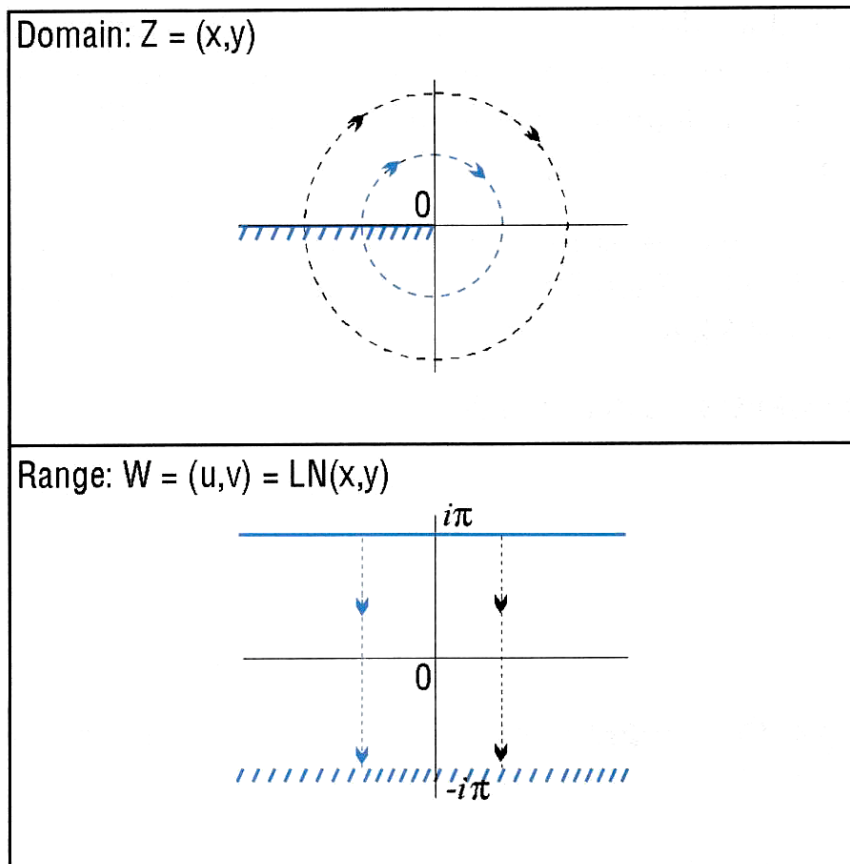

You can view these graphs with domain and range reversed to see how the domain of EXP is restricted to make an inverse *function* possible. Consider the vertical band in the lower graph as the restricted domain $Z = (x,y)$. EXP sends this domain onto the whole complex plane in the range $W = (u,v) = \text{EXP}(x,y)$ in the upper graph.

Access: $\boxed{\rightarrow}$ LN (LN is the right-shift of the $\boxed{\gamma^x}$ key).

Flags: Principal Solution (-1), Numerical Results (-3), Infinite Result Exception (-22)

Input/Output:

| Level 1/Argument 1 | | Level 1/Item 1 |
|--------------------|---------------|---------------------|
| z | \rightarrow | $\ln z$ |
| ' <i>syml</i> ' | \rightarrow | 'LN(<i>syml</i>)' |

See also: ALOG, EXP, ISOL, LNP1, LOG

LNAME

CAS: Return a list of variable names contained in a symbolic expression.

LNCOLLECT

CAS: Simplify an expression by collecting logarithmic terms.

LNP1

Type: Analytic function

Description: Natural Log of x Plus 1 Analytic Function: Returns $\ln(x + 1)$.

For values of x close to zero, LNP1(x) returns a more accurate result than does LN($x+1$). Using LNP1 allows both the argument and the result to be near zero, and it avoids an intermediate result near 1. The calculator can express numbers within 10^{-449} of zero, but within only 10^{-11} of 1.

For values of $x < -1$, an Undefined Result error results. For $x=-1$, an Infinite Result exception occurs, or, if flag -22 is set, LNP1 returns -MAXR.

Access: \leftarrow MTH HYPERBOLIC LNP1 (\leftarrow MTH is the left-shift of the \square SYMB key).

Flags: Numerical Results (-3), Infinite Result Exception (-22)

Input/Output:

| Level 1/Argument 1 | | Level 1/Item 1 |
|--------------------|---------------|-----------------------|
| x | \rightarrow | $\ln(x + 1)$ |
| ' <i>symb</i> ' | \rightarrow | 'LNP1(<i>symb</i>)' |

See also: EXPM, LN

LOCAL

CAS: Create local variables.

LOG

Type: Analytic function

Description: Common Logarithm Analytic Function: Returns the common logarithm (base 10) of the argument.

For $x=0$ or $(0, 0)$, an Infinite Result exception occurs, or, if flag -22 is set (no error), LOG returns -MAXR.

The inverse of ALOG is a *relation*, not a function, since ALOG sends more than one argument to the same result. The inverse relation for ALOG is the *general solution*:

$$\text{LOG}(Z)+2*\pi*i*n1/2.30258509299$$

The function LOG is the inverse of a *part* of ALOG, a part defined by restricting the domain of ALOG such that 1) each argument is sent to a distinct result, and 2) each possible result is achieved. The points in this restricted domain of ALOG are called the *principal values* of the inverse relation. LOG in its entirety is called the *principal branch* of the inverse relation, and the points sent by LOG to the boundary of the restricted domain of ALOG form the *branch cuts* of LOG.

The principal branch used by the hp49g+/hp48gII for LOG(z) was chosen because it is analytic in the regions where the arguments of the real-valued function are defined. The branch cut for the complex-valued LOG function occurs where the corresponding real-valued function is undefined. The principal branch also preserves most of the important symmetries.

You can determine the graph for LOG(z) from the graph for LN (see LN) and the relationship $\log z = \ln z / \ln 10$.

Access: \rightarrow LOG (\rightarrow LOG is the right-shift of the \square EX key).

Flags: Principal Solution (-1), Numerical Results (-3), Infinite Result Exception (-22)

Input/Output:

| Level 1/Argument 1 | | Level 1/Item 1 |
|--------------------|---|----------------------|
| z | → | $\log z$ |
| ' <i>symp</i> ' | → | 'LOG(<i>symp</i>)' |

See also: ALOG, EXP, ISOL, LN

LOGFIT

Type: Command

Description: Logarithmic Curve Fit Command: Stores LOGFIT as the fifth parameter in the reserved variable ΣPAR , indicating that subsequent executions of LR are to use the logarithmic curve-fitting model.

LINFIT is the default specification in ΣPAR .

Access: $\left[\rightarrow \right]$ \underline{CAT} LOGFIT

Input/Output: None

See also: BESTFIT, EXPFIT, LINFIT, LR, PWRFIT

LQ

Type: Command

Description: LQ Factorization of a Matrix Command: Returns the LQ factorization of an $m \times n$ matrix.

LQ factors an $m \times n$ matrix A into three matrices:

- L is a lower $m \times n$ trapezoidal matrix.
- Q is an $n \times n$ orthogonal matrix.
- P is a $m \times m$ permutation matrix.

Where $P \times A = L \times Q$.

Access: $\left[\leftarrow \right]$ $\underline{MATRICES}$ FACTORIZATION LQ ($\underline{MATRICES}$ is the left-shift of the $\left[5 \right]$ key).

$\left[\leftarrow \right]$ \underline{MTH} MATRIX FACTORS LQ (\underline{MTH} is the left-shift of the $\left[\underline{SYMB} \right]$ key).

Input/Output:

| Level 1/Argument 1 | | Level 3/Item 1 | Level 2/Item 2 | Level 1/Item 3 |
|------------------------------------|---|------------------------------------|------------------------------------|------------------------------------|
| $[[\text{matrix}]]$ _A | → | $[[\text{matrix}]]$ _L | $[[\text{matrix}]]$ _Q | $[[\text{matrix}]]$ _P |

See also: LSQ, QR

LR

Type: Command

Description: Linear Regression Command: Uses the currently selected statistical model to calculate the linear regression coefficients (intercept and slope) for the selected dependent and independent variables in the current statistics matrix (reserved variable ΣDAT).

The columns of independent and dependent data are specified by the first two elements in the reserved variable ΣPAR , set by XCOL and YCOL, respectively. (The default independent and dependent columns are 1 and 2.) The selected statistical model is the fifth element in ΣPAR . LR stores the intercept and slope (untagged) as the third and fourth elements, respectively, in ΣPAR .

The coefficients of the exponential (EXPFIT), logarithmic (LOGFIT), and power (PWRFIT) models are calculated using transformations that allow the data to be fitted by standard linear regression. The equations for these transformations appear in the table below, where b is the intercept and m is the slope. The logarithmic model requires positive x -values (XCOL), the exponential model requires positive y -values (YCOL), and the power model requires positive x - and y -values.

| Model | Transformation |
|-------------|------------------------------|
| Logarithmic | $y = b + m \ln(x)$ |
| Exponential | $\ln(y) = \ln(b) + mx$ |
| Power | $\ln(y) = \ln(b) + m \ln(x)$ |

Access: CAT LR

Input/Output:

| Level 1/Argument 1 | Level 2/Item 1 | Level 1/Item 2 |
|--------------------|----------------|---|
| | → | <i>Intercept: x_1</i> <i>Slope: x_2</i> |

See also: BESTFIT, COLΣ, CORR, COV, EXPFIT, ΣLINE, LINFIT, LOGFIT, PREDX, PREDY, PWRFIT, XCOL, YCOL

LSQ

Type: Command

Description: Least Squares Solution Command: Returns the minimum norm least squares solution to any system of linear equations where $A \times X = B$.

If B is a vector, the resulting vector has a minimum Euclidean norm $||X||$ over all vector solutions that minimize the residual Euclidean norm $||A \times X - B||$. If B is a matrix, each column of the resulting matrix, X_i , has a minimum Euclidean norm $||X_i||$ over all vector solutions that minimize the residual Euclidean norm $||A \times X_i - B_i||$.

If A has less than full row rank (the system of equations is underdetermined), an infinite number of solutions exist. LSQ returns the solution with the minimum Euclidean length.

If A has less than full column rank (the system of equations is overdetermined), a solution that satisfies all the equations may not exist. LSQ returns the solution with the minimum residuals of $A \times X - B$.

Access: MATRICES OPERATIONS LSQ (MATRICES is the left-shift of the key).

MTH MATRIX LSQ (MTH is the left-shift of the key).

Flags: Singular Values (-54)

Input/Output:

| Level 2/Argument 1 | Level 1/Argument 2 | Level 1/Item 1 |
|--------------------|--------------------|------------------|
| $[array]_B$ | $[[matrix]]_A$ | → $[array]_x$ |
| $[[matrix]]_B$ | $[[matrix]]_A$ | → $[[matrix]]_x$ |

See also: LQ, RANK, QR, /

LU

Type: Command

Description: LU Decomposition of a Square Matrix Command: Returns the LU decomposition of a square matrix.

When solving an exactly determined system of equations, inverting a square matrix, or computing the determinant of a matrix, the hp49g+/hp48gII factors a square matrix into its Crout LU decomposition using partial pivoting.

The Crout LU decomposition of A is a lower-triangular matrix L , an upper-triangular matrix U with ones on its diagonal, and a permutation matrix P , such that $P \times A = L \times U$. The results satisfy $P \times A \cong L \times U$.

Access: \leftarrow MATRICES FACTORIZATION LU (MATRICES is the left-shift of the 5 key).
 \leftarrow MTH MATRIX FACTOR LU (MTH is the left-shift of the SYMB key).

Input/Output:

| Level 1/Argument 1 | | Level 3/Item 1 | Level 2/Item 2 | Level 1/Item 3 |
|--------------------|---|----------------|----------------|----------------|
| $[[matrix]]_A$ | → | $[[matrix]]_L$ | $[[matrix]]_U$ | $[[matrix]]_V$ |

See also: DET, INV, LSQ, /

LVAR

CAS: Return a list of variable and function names in an algebraic object.

MAD

CAS: Return details of a square matrix, including the information needed to obtain the adjoint matrix.

MAIN

CAS: Display the names of the main menus of CAS operations, as a menu or a list.

MANT

Type: Function

Description: Mantissa Function: Returns the mantissa of the argument.

Access: \leftarrow MTH REAL \leftarrow NXT MANT (MTH is the left-shift of the SYMB key).

Flags: Numerical Results (-3)

Input/Output:

| Level 1/Argument 1 | | Level 1/Item 1 |
|--------------------|---|-----------------------|
| x | → | y_{mant} |
| ' <i>symb</i> ' | → | 'MANT(<i>symb</i>)' |

See also: SIGN, XPON

MAP

Type: Command

Description: Applies a specified program to a list of objects or values.

- Level 1/Argument 2 contains the list of objects or values
- Level 2/Argument 1 contains the program to apply to the objects or values.

Access: \rightarrow CAT MAP

Input/Output:

| Level 2/Argument 1 | Level 1/Argument 2 | | Level 1/Item 1 |
|--------------------|---------------------------|---|----------------|
| $\{list\}_1$ | $\langle program \rangle$ | → | $\{list\}_2$ |

↓MATCH

Type: Command

Description: Match Pattern Down Command: Rewrites an expression that matches a specified pattern.

↓MATCH rewrites expressions or subexpressions that match a specified pattern '*symb_{pat}*'. An optional condition, '*symb_{cond}*', can further restrict whether a rewrite occurs. A test result is also returned to indicate if command execution produced a rewrite; 1 if it did, 0 if it did not.

The pattern '*symb_{pat}*' and replacement '*symb_{repl}*' can be normal expressions; for example, you can replace .5 with 'SIN($\pi/6$)'. You can also use a “wildcard” in the pattern (to match any subexpression) and in the replacement (to represent that expression). A wildcard is a name that begins with &, such as the name '&A', used in replacing 'SIN(&A+&B)' with

'SIN(&A)*COS(&B)+COS(&A)*SIN(&B)'. Multiple occurrences of a particular wildcard in a pattern must match identical subexpressions.

↓MATCH works from top down; that is, it checks the entire expression first. This approach works well for expansion. An expression expanded during one execution of ↓MATCH will contain additional subexpressions, and those subexpressions can be expanded by another execution of ↓MATCH. Several expressions can be expanded by one execution of ↓MATCH provided none is a subexpression of any other.

Access:  CAT ↓MATCH

Input/Output:

| Level 2/Argument 1 | Level 1/Argument 2 | | Level 2/Item 1 | Level 1/Item 2 |
|------------------------------|--|---|------------------------------|----------------|
| ' <i>symb</i> ₁ ' | { ' <i>symb</i> _{pat} ' ' <i>symb</i> _{repl} ' } | → | ' <i>symb</i> ₂ ' | 0/1 |
| ' <i>symb</i> ₁ ' | { ' <i>symb</i> _{pat} ' ' <i>symb</i> _{repl} ' ' <i>symb</i> _{cond} ' } | → | ' <i>symb</i> ₂ ' | 0/1 |

See also: ↑MATCH

↑MATCH

Type: Command

Description: Bottom-Up Match and Replace Command: Rewrites an expression.

↑MATCH rewrites expressions or subexpressions that match a specified pattern '*symb*_{pat}'. An optional condition, '*symb*_{cond}', can further restrict whether a rewrite occurs. A test result is also returned to indicate if command execution produced a rewrite; 1 if it did, 0 if it did not.

The pattern '*symb*_{pat}' and replacement '*symb*_{repl}' can be normal expressions; for example, you can replace 'SIN($\pi/6$)' with '1/2'. You can also use a “wildcard” in the pattern (to match any subexpression) and in the replacement (to represent that expression). A wildcard is a name that begins with &, such as the name '&A', used in replacing 'SIN(&A+ π)' with '-SIN(&A)'. Multiple occurrences of a particular wildcard in a pattern must match identical subexpressions.

↑MATCH works from bottom up; that is, it checks the lowest level (most deeply nested) subexpressions first. This approach works well for simplification. A subexpression simplified during one execution of ↑MATCH will be a simpler argument of its parent expression, so the parent expression can be simplified by another execution of ↑MATCH.

Several subexpressions can be simplified by one execution of ↑MATCH provided none is a subexpression of any other.

Access:  CAT ↑MATCH

Input/Output:

| Level 2/Argument 1 | Level 1/Argument 2 | | Level 2/Item 1 | Level 1/Item 2 |
|------------------------------|--|---|------------------------------|----------------|
| ' <i>symb</i> ₁ ' | { ' <i>symb</i> _{pat} ' ' <i>symb</i> _{repl} ' } | → | ' <i>symb</i> ₂ ' | 0/1 |
| ' <i>symb</i> ₁ ' | { ' <i>symb</i> _{pat} ' ' <i>symb</i> _{repl} ' ' <i>symb</i> _{cond} ' } | → | ' <i>symb</i> ₂ ' | 0/1 |

See also: ↓MATCH

MATHS

CAS: Display a menu or list of CAS mathematics submenus.

MATR

CAS: Display a menu or list of CAS commands for matrix operations.

MAX

Type: Function

Description: Maximum Function: Returns the greater of two inputs.

Access: \leftarrow MTH REAL MAX (\leftarrow MTH is the left-shift of the \square SYMB key).

Flags: Numerical Results (-3)

Input/Output:

| Level 2/Argument 1 | Level 1/Argument 2 | | Level 1/Item 1 |
|--------------------|--------------------|---------------|------------------------------|
| x | y | \rightarrow | $\max(x,y)$ |
| x | ' ymb ' | \rightarrow | 'MAX(x, ymb)' |
| ' ymb ' | x | \rightarrow | 'MAX(ymb, x)' |
| ' ymb_1 ' | ' ymb_2 ' | \rightarrow | 'MAX(ymb_1, ymb_2)' |
| x_unit_1 | y_unit_2 | \rightarrow | $\max(x_unit_1, y_unit_2)$ |

See also: MIN

MAXR

Type: Function

Description: Maximum Real Function: Returns the symbolic constant MAXR or its numerical representation 9.999999999999999E499.

MAXR is the largest real number that can be represented by the hp49g+/hp48gII.

Access: \leftarrow MTH \square NXT CONSTANTS \square NXT MAXR (\leftarrow MTH is the left-shift of the \square SYMB key).

Flags: Symbolic Constants (-2), Numerical Results (-3)

Input/Output:

| Level 1/Argument 1 | | Level 1/Item 1 |
|--------------------|---------------|-----------------------|
| | \rightarrow | 'MAXR' |
| | \rightarrow | 9.999999999999999E499 |

See also: e, i, MINR, π

MAX Σ

Type: Command

Description: Maximum Sigma Command: Finds the maximum coordinate value in each of the m columns of the current statistical matrix (reserved value ΣDAT).

The maxima are returned as a vector of m real numbers, or as a single real number if $m = 1$.

Access: \rightarrow CAT MAX Σ

Input/Output:

| Level 1/Argument 1 | | Level 1/Item 1 |
|--------------------|---------------|--|
| | \rightarrow | x_{\max} |
| | \rightarrow | $[x_{\max 1} \ x_{\max 2} \ \dots \ x_{\max m}]$ |

See also: BINS, MEAN, MIN Σ , SDEV, TOT, VAR

MCALC

Type: Command

Description: Make Calculated Value Command: Designates a variable as a calculated variable for the multiple-equation solver.

MCALC designates a single variable, a list of variables, or all variables as calculated values.

Access: \rightarrow CAT MCALC

Input/Output:

| Level 1/Argument 1 | Level 1/Item 1 |
|--------------------|----------------|
| 'name' | → |
| { list } | → |
| "ALL" | → |

See also: MUSER

MEAN

Type: Command

Description: Mean Command: Returns the mean of each of the m columns of coordinate values in the current statistics matrix (reserved variable ΣDAT).

The mean is returned as a vector of m real numbers, or as a single real number if $m = 1$. The mean is computed from the formula:

$$\frac{1}{n} \sum_{i=1}^n x_i$$

where x_i is the i th coordinate value in a column, and n is the number of data points.

Access: $\left[\rightarrow \right]$ $\left[_ \text{CAT} \right]$ MEAN OR $\left[\rightarrow \right]$ $\left[_ \text{STAT} \right]$ Single-variable statistics, Mean
 ($\left[_ \text{STAT} \right]$ is the right-shift of the $\left[5 \right]$ key and always invokes a choose box).

Input/Output:

| Level 1/Argument 1 | Level 1/Item 1 |
|--------------------|---|
| | → x_{mean} |
| | → $[x_{\text{mean}1}, x_{\text{mean}2}, \dots, x_{\text{mean}m}]$ |

See also: BINS, MAX Σ , MIN Σ , SDEV, TOT, VAR

MEM

Type: Command

Description: Memory Available Command: Returns the number of bytes of available RAM.

The number returned is only a rough indicator of usable available memory, since recovery features (LASTARG= $\left[\leftarrow \right]$ $\left[\text{ANS} \right]$, $\left[\rightarrow \right]$ $\left[\text{UNDO} \right]$, and $\left[\leftarrow \right]$ $\left[\text{CMD} \right]$) consume or release varying amounts of memory with each operation.

Before it can assess the amount of memory available, MEM must remove objects in temporary memory that are no longer being used. This clean-up process (also called “garbage collection”) also occurs automatically at other times when memory is full. Since this process can slow down calculator operation at undesired times, you can force it to occur at a desired time by executing MEM. In a program, execute MEM DROP.

Access: $\left[\leftarrow \right]$ $\left[\text{PRG} \right]$ MEMORY MEM ($\left[\text{PRG} \right]$ is the left-shift of the $\left[\text{EVAL} \right]$ key).

Input/Output:

| Level 1/Argument 1 | Level 1/Item 1 |
|--------------------|----------------|
| | → x |

See also: BYTES

MENU

Type: Command Operation

Description: Display Menu Command: Displays a built-in menu or a library menu, or defines and displays a custom menu.

A built-in menu is specified by a real number x_{menu} . The format of x_{menu} is $mm.pp$, where mm is the menu number and pp is the page of the menu. If pp doesn't correspond to a page of the specified menu, the first page is displayed.

Library menus are specified in the same way as built-in menus, with the library number serving as the menu number.

Custom menus are specified by a list of the form { "label-object" action-object } or a name containing a list ($name_{\text{definition}}$). Either argument is stored in reserved variable CST , and the custom menu is subsequently displayed.

MENU takes *any* object as a valid argument and stores it in CST . However, the calculator can build a custom menu *only* if CST contains a list or a name containing a list. Thus, if an object other than a list or name containing a list is supplied to MENU, a Bad Argument Type error will occur when the calculator attempts to display the custom menu.

Access: \leftarrow &MODE [MENU] MENU
 \leftarrow PRG \leftarrow NXT MODES [MENU] MENU (PRG is the left-shift of the EVAL key).

Input/Output:

| Level 1/Argument 1 | Level 1/Item 1 |
|--------------------------------|----------------|
| x_{menu} | \rightarrow |
| { $list_{\text{definition}}$ } | \rightarrow |
| ' $name_{\text{definition}}$ ' | \rightarrow |
| obj | \rightarrow |

See also: RCLMENU, TMENU

MENUXY

CAS: Display a function key menu of computer algebra commands in a specified range.

MERGE

Type: Command

Description: Do not use this command, a carry-over from the HP 48GX for handling plug-in RAM cards.

MIN

Type: Function

Description: Minimum Function: Returns the lesser of two inputs.

Access: \leftarrow MTH REAL MIN (MTH is the left-shift of the SYMB key).

Flags: Numerical Results (-3)

Input/Output:

| Level 2/Argument 1 | Level 1/Argument 2 | Level 1/Item 1 |
|--------------------|--------------------|--|
| x | y | \rightarrow $min(x,y)$ |
| x | ' $symb$ ' | \rightarrow 'MIN(x , $symb$)' |
| ' $symb$ ' | x | \rightarrow 'MIN($symb$, x)' |
| ' $symb_1$ ' | ' $symb_2$ ' | \rightarrow 'MIN($symb_1$, $symb_2$)' |
| x_unit_1 | y_unit_2 | \rightarrow $min(x_unit_1, y_unit_2)$ |

See also: MAX

MINEHUNT

Type: Command

Description: Starts the MINEHUNT game.

In this game, you are standing in the upper-left corner of an 8x16 battlefield grid. Your mission is to travel safely to the lower-right corner, avoiding invisible mines along the way. The game tells you how many mines are under the eight squares adjacent to your position.



Use the number or arrow keys to cross the battlefield one square at a time (use **7**, **9**, **1**, and **3** to move diagonally.) You can exit the game at any time by pressing **CANCEL** (the **ON** key).

To interrupt and save a game, press **.** This creates a variable *MHpar* in the current directory and ends the game. If *MHpar* exists when you start MINEHUNT, the interrupted game resumes and *MHpar* is purged.

You can change the number of mines in the battlefield by creating a variable named *Nmines* containing the desired number. *Nmines* must contain a real number (1 to 64). If *Nmines* is negative, the mines are visible during the game (allowing you to cheat).

Access: **[APPS]** EQUATION LIBRARY UTILS MINEHUNT

Input/Output: None.

MINIFONT→

Type: Command

Description: Minifont: Returns the font that is set as the minifont.

Access: **[→]** **_CAT** MINIFONT→

Input/Output:

| Level 1/Argument 1 | Level 1/Item 1 |
|--------------------|--------------------|
| | <i>Font object</i> |

See also: MINIFONT→

→MINIFONT

Type: Command

Description: Minifont: Sets the font that is used as the minifont.

Access: **[→]** **_CAT** →MINIFONT

Input/Output:

| Level 1/Argument 1 | Level 1/Item 1 |
|--------------------|----------------|
| <i>Font object</i> | |

See also: →MINIFONT

MINIT

Type: Command

Description: Multiple-equation Menu Initialization Command. Creates the reserved variable *Mpar*, which includes the equations in *EQ* and the variables in these equations.

Access: **[→]** **_CAT** MINIT

See also: MITM, MROOT, MSOLVER

MINR

Type: Function

Description: Minimum Real Function: Returns the symbolic constant MINR or its numerical representation, 1.000000000000E-499.

MINR is the smallest positive real number that can be represented by the hp49g+/hp48gII.

Access: \leftarrow MTH NXT CONSTANTS NXT MINR (\leftarrow MTH is the left-shift of the SYMB key).

Flags: Symbolic Constants (-2), Numerical Results (-3)

Input/Output:

| Level 1/Argument 1 | Level 1/Item 1 |
|--------------------|-----------------------|
| | → 'MINR' |
| | → 1.000000000000E-499 |

See also: e , i , MAXR, π

MIN Σ

Type: Command

Description: Minimum Sigma Command: Finds the minimum coordinate value in each of the m columns of the current statistics matrix (reserved variable ΣDAT).

The minima are returned as a vector of m real numbers, or as a single real number if $m = 1$.

Access: \rightarrow CAT MIN Σ

Input/Output:

| Level 1/Argument 1 | Level 1/Item 1 |
|--------------------|--|
| | → x_{\min} |
| | → $\{ x_{\min 1} x_{\min 2} \dots x_{\min m} \}$ |

See also: BINS, MAX Σ , MEAN, SDEV, TOT, VAR

MITM

Type: Command

Description: Multiple-equation Menu Item Order Command. Changes multiple equation menu titles and order. The argument list contains the variable names in the order you want. Use "" to indicate a blank label. You must include all variables in the original menu and no others.

Access: \rightarrow CAT MITM

Input/Output:

| Level 2/Argument 1 | Level 1/Argument 2 | Level 1/Item 1 |
|--------------------|--------------------|----------------|
| "title" | { list } | → |

See also: MINTT

MKISOM

CAS: Return the matrix representation for a given isometry.

MOD

Type: Function

Description: Modulo Function: Returns a remainder defined by: $x \bmod y = x - y \text{ floor}(x/y)$

Mod (x, y) is periodic in x with period y . Mod (x, y) lies in the interval $[0, y)$ for $y > 0$ and in $(y, 0]$ for $y < 0$.

Algebraic syntax: *argument 1* MOD *argument 2*

Access: \leftarrow MTH REAL MOD (\leftarrow MTH is the left-shift of the SYMB key).

\leftarrow ARITH MODUL NXT MOD (\leftarrow ARITH is the left-shift of the I key).

Flags: Numerical Results (-3)

Input/Output:

| Level 2/Argument 1 | Level 1/Argument 2 | | Level 1/Item 1 |
|------------------------------|------------------------------|---|--|
| x | y | → | $x \bmod y$ |
| x | ' <i>symb</i> ' | → | 'MOD(x , <i>symb</i>)' |
| ' <i>symb</i> ' | x | → | 'MOD(<i>symb</i> , x)' |
| ' <i>symb</i> ₁ ' | ' <i>symb</i> ₂ ' | → | 'MOD(<i>symb</i> ₁ , <i>symb</i> ₂)' |

See also: FLOOR, /

MODSTO

CAS: Change the modulo setting to the specified number.

MODULAR

CAS: Display a menu or list of CAS modulo operations.

MROOT

Type: Command

Description: Multiple Roots Command: Uses the multiple-equation solver to solve for one or more variables using the equations in *EQ*. Given a variable name, MROOT returns the found value; with "ALL" MROOT stores a found value for each variable but returns nothing.

Access:  CAT MROOT

Input/Output:



| Level 1/Argument 1 | | Level 1/Item 1 |
|--------------------|---|----------------|
| ' <i>name</i> ' | → | x |
| "ALL" | → | |

See also: MCALC, MUSER

MSGBOX

Type: Command

Description: Message Box Command: Creates a user-defined message box.

MSGBOX displays "*message*" in the form of a standard message box. Message text too long to appear on the screen is truncated. You can use spaces and new-line characters ( ) to control word-wrapping and line breaks within the message.

Program execution resumes when the message box is exited by selecting OK or CANCL.

Access:  PRG  OUT MSGBOX (PRG is the left-shift of the  key).

Input/Output:

| Level 1/Argument 1 | | Level 1/Item 1 |
|--------------------|---|----------------|
| " <i>message</i> " | → | |

See also: CHOOSE, INFORM, PROMPT

MSLV

CAS: Multiple equation solver; numerically approximate a solution to a system of equations.

MSOLVR

Type: Command

Description: Multiple Equation Solver Command: Gets the multiple-equation solver variable menu for the set of equations stored in *EQ*.

The multiple-equation solver application can solve a set of two or more equations for unknown variables by finding the roots of each equation. The solver uses the list of equations stored in *EQ*.

Access: CAT MSOLVR

Input/Output: None

See also: EQNLIB, MCALC, MINIT, MITM, MROOT, MSLV, MUSER

MULTMOD

CAS: Perform modular multiplication of two objects, modulo the current modulus.

MUSER

Type: Command

Description: Make User-Defined Variable Command: Designates a variable as user-defined for the multiple-equation solver.

MUSER designates a single variable, a list of variables, or all variables as user-defined.

Access: CAT MUSER

Input/Output:

| Level 1/Argument 1 | Level 1/Item 1 |
|--------------------|----------------|
| 'name' | → |
| { list } | → |
| "ALL" | → |

See also: MCALC

→NDISP

Type: Command

Description: Sets the number of program lines displayed on the screen.

The default value on the hp49g+/hp48gII is 9. On the hp49g+ a value of 12 should be set for →NDISP, which will allow more of the hp49g+'s taller screen to be used when the font is FONT7, FONT6, or the MINIFONT. Also, note that the →NDISP setting is reset to 9 at every warmstart. Including << 12 →NDISP >> in 'STARTUP' will automatically reset the value to 12.

Access: CAT →NDISP

Input/Output:

| Level 1/Argument 1 | Level 1/Item 1 |
|--------------------|----------------|
| <i>n</i> | → |

NDIST

Type: Command

Description: Normal Distribution Command: Returns the normal probability distribution (bell curve) at *x* based on the mean *m* and variance *v* of the normal distribution.

NDIST is calculated using this formula:

$$\text{ndist}(m, v, x) = \frac{e^{-\frac{(x-m)^2}{2v}}}{\sqrt{2\pi v}}$$

Access: MTH PROBABILITY NDIST (MTH is the left-shift of the key).

Input/Output:

| Level 3/Argument 1 | Level 2/Argument 2 | Level 1/Argument 3 | Level 1/Item 1 |
|--------------------|--------------------|--------------------|--------------------------------|
| m | v | x | \rightarrow $ndist(m, v, x)$ |

See also: UTPN

NDUPN

Type: RPL command

Description: Duplicates an object n times, and returns n .

Access: \leftarrow PRG STACK \leftarrow PREV NDUPN (PRG is the left-shift of the EVAL key).
 \leftarrow TOOL STACK \leftarrow PREV NDUPN

Input/Output:

| Level 2 | Level 1 | Level _{n+1} ... Level ₂ | Level ₁ |
|---------|---------|---|--------------------|
| obj | n | \rightarrow $obj \dots obj$ | n |

See also: DUP, DUPDUP, DUPN, DUP2

NEG

Type: Analytic function

Description: Negate Analytic Function: Changes the sign or negates an object.

Negating an array creates a new array containing the negative of each of the original elements.

Negating a binary number takes its two's complement (complements each bit and adds 1).

Negating a graphics object “inverts” it (toggles each pixel from on to off, or vice-versa). If the argument is *PICT*, the graphics object stored in *PICT* is inverted.

Access: \rightarrow CMPLX NEG (CMPLX is the right-shift of the I key).
 \leftarrow MTH NXT COMPLEX NXT NEG (MTH is the left-shift of the SYMB key).
 $+/-$

Flags: Numerical Results (-3), Binary Integer Wordsize (-5 through -10)

Input/Output:

| Level 1/Argument 1 | Level 1/Item 1 |
|--------------------|----------------------------|
| \tilde{x} | \rightarrow $-\tilde{x}$ |
| $\#n_1$ | \rightarrow $\#n_2$ |
| $[array]$ | \rightarrow $[-array]$ |
| ' <i>symb</i> ' | \rightarrow $'-(symb)'$ |
| x_unit | \rightarrow $-x_unit$ |
| $grob_1$ | \rightarrow $grob_2$ |
| $PICT_1$ | \rightarrow $PICT_2$ |

See also: ABS, CONJ, NOT, SIGN

NEWOB

Type: Command

Description: New Object Command: Creates a new copy of the specified object.

NEWOB has two main uses:

- NEWOB enables the purging of a library or backup object that has been recalled from a port. NEWOB creates a new, separate copy of the object in memory, thereby allowing the original copy to be purged.

- Creating a new copy of an object that originated in a larger composite object (such as a list) allows you to recover the memory associated with the larger object when that larger object is no longer needed.

Access: \leftarrow PRG MEMORY NEWOB (PRG is the left-shift of the EVAL key).

Flags: Last Arguments (-55). In order for NEWOB to immediately release the memory occupied by the original copy, flag -55 must be set so that the copy is not saved as a last argument.

Input/Output:

| Level 1/Argument 1 | Level 1/Item 1 |
|--------------------|----------------|
| <i>obj</i> | <i>obj</i> |

See also: MEM, PURGE

NEXT

Type: Command

Description: NEXT Command: Ends definite loop structures.

See the FOR and START keyword entries for more information.

Access: \leftarrow PRG BRANCH START/FOR NEXT (PRG is the left-shift of the EVAL key).

Input/Output: None

See also: FOR, START, STEP

NEXTPRIME

CAS: Return the next prime number larger than a given integer.

NIP

Type: RPL command

Description: Drops the $(n-1)^{\text{th}}$ argument, where n is the number of arguments or items on the stack. (that is, the object on level 2 of the stack). This is equivalent to executing SWAP followed by DROP in RPN mode.

Access: \leftarrow PRG STACK \leftarrow NXT \leftarrow NXT NIP (PRG is the left-shift of the EVAL key).

\leftarrow TOOL STACK \leftarrow NXT \leftarrow NXT NIP

Input/Output:

| Level 2 | Level 1 | Level 1 |
|------------------------|------------------------|------------------------|
| <i>obj₁</i> | <i>obj₂</i> | <i>obj₂</i> |

See also: DUP, DUPDUP, DUPN, DUP2

NOT

Type: Function

Description: NOT Command: Returns the one's complement or logical inverse of the argument.

When the argument is a binary integer or string, NOT complements each bit in the argument to produce the result.

- A binary integer is treated as a sequence of bits as long as the current wordsize.
- A string is treated as a sequence of bits, using 8 bits per character (that is, using the binary version of the character code).

When the argument is a real number or symbolic, NOT does a true/false test. The result is 1 (true) if the argument is zero; it is 0 (false) if the argument is nonzero. This test is usually done on a test result (T/F).

If the argument is an algebraic object, then the result is an algebraic of the form NOT *symb*. Execute \rightarrow NUM (or set flag -3 before executing NOT) to produce a numeric result from the algebraic result.

Access: \leftarrow PRG TEST $\text{\textcircled{NXT}}$ NOT ($\overline{\text{PRG}}$ is the left-shift of the $\text{\textcircled{EVAL}}$ key).
 $\overline{\text{BASE}}$ $\text{\textcircled{NXT}}$ LOGIC NOT ($\overline{\text{BASE}}$ is the right-shift of the $\text{\textcircled{3}}$ key).

Flags: Numerical Results (-3), Binary Integer Wordsize (-5 through -10)

Input/Output:

| Level 1/Argument 1 | | Level 1/Item 1 |
|--------------------|---|----------------|
| $\#n_1$ | → | $\#n_2$ |
| T/F | → | 0/1 |
| "string" | → | "string" |
| 'symb' | → | 'NOT symb' |

See also: AND, OR, XOR

NOVAL

Type: Command

Description: INFORM Place Holder/Result Command: Place holder for reset and initial values in user-defined dialog boxes. NOVAL is returned when a field is empty.

NOVAL is used to mark an empty field in a user-defined dialog box created with the INFORM command. INFORM defines fields sequentially. If default values are used for those fields, the defaults must be defined in the same order as the fields were defined. To skip over (not provide defaults for) some of the fields, use the NOVAL command.

After INFORM terminates, NOVAL is returned if a field is empty and OK or $\text{\textcircled{ENTER}}$ is selected.

Access: \leftarrow PRG $\text{\textcircled{NXT}}$ IN NOVAL ($\overline{\text{PRG}}$ is the left-shift of the $\text{\textcircled{EVAL}}$ key).

Input/Output: None

See also: INFORM

NΣ

Type: Command

Description: Number of Rows Command: Returns the number of rows in the current statistical matrix (reserved variable ΣDAT).

Access: $\overline{\text{CAT}}$ NΣ

Input/Output:

| Level 1/Argument 1 | | Level 1/Item 1 |
|--------------------|---|-------------------|
| | → | n_{rows} |

See also: ΣX, ΣXY, ΣX2, ΣY, ΣY2

NSUB

Type: Command

Description: Number of Sublist Command: Provides a way to access the current sublist position during an iteration of a program or command applied using DOSUBS.

Returns an Undefined Local Name error if executed when DOSUBS is not active.

Access: \leftarrow PRG LIST PROCEDURES NSUB ($\overline{\text{PRG}}$ is the left-shift of the $\text{\textcircled{EVAL}}$ key).

Input/Output:

| Level 1/Argument 1 | | Level 1/Item 1 |
|--------------------|---|-----------------------|
| | → | n_{position} |

See also: DOSUBS, ENDSUB

→NUM

Type: Command

Description: Evaluate to Number Command. Evaluates a symbolic argument object (other than a list) and returns the numerical result.

→NUM repeatedly evaluates a symbolic argument until a numerical result is achieved. The effect is the same as evaluating a symbolic argument in Numerical Result Mode (flag -3 set).

Access: →NUM (→NUM is the right-shift of the key).

Input/Output:

| Level 1/Argument 1 | Level 1/Item 1 |
|--------------------|----------------|
| obj_{symb} | \approx |

See also: EVAL

NUM

Type: Command

Description: Character Number Command: Returns the character code n for the first character in the string.

The character codes are an extension of ISO 8859/1.

The number of a character can be found by accessing the Characters tool (CHARS) and highlighting that character. The number appears near the bottom of the screen.

Access: PRG TYPE NUM (is the left-shift of the key).

PRG CHARS NUM (is the left-shift of the key).

& NUM

Input/Output:

| Level 1/Argument 1 | Level 1/Item 1 |
|--------------------|----------------|
| "string" | n |

See also: CHR, POS, REPL, SIZE, SUB

NUMX

Type: Command

Description: Number of X-Steps Command: Sets the number of x -steps for each y -step in 3D perspective plots.

The number of x -steps is the number of independent variable points plotted for each dependent variable point plotted. This number must be 2 or more. This value is stored in the reserved variable VPAR. YSLICE is the only 3D plot type that does not use this value.

Access: NUMX

Input/Output:

| Level 1/Argument 1 | Level 1/Item 1 |
|--------------------|----------------|
| n_x | \rightarrow |

See also: NUMY

NUMY

Type: Command

Description: Number of Y-Steps Command: Sets the number of y -steps across the view volume in 3D perspective plots.

The number of y -steps is the number of dependent variable points plotted across the view volume. This number must be 2 or more. This value is stored in the reserved variable VPAR.

Access: NUMY

Input/Output:

| Level 1/Argument 1 | Level 1/Item 1 |
|--------------------|----------------|
| n_y | \rightarrow |

See also: NUMX

OBJ→

Type: Command

Description: Object to Stack Command: Separates an object into its components. For some object types, the *number* of components is returned as item $n+1$ (stack level 1).

If the argument is a complex number, list, array, or string, OBJ→ provides the same functions as C→R, LIST→, ARRY→, and STR→, respectively. For lists, OBJ→ also returns the number of list elements. If the argument is an array, OBJ→ also returns the dimensions $\{ m \ n \}$ of the array, where m is the number of rows and n is the number of columns.

For algebraic objects, OBJ→ returns the arguments of the top-level (least-nested) function ($arg_1 \dots arg_n$), the number of arguments of the top-level function (n), and the name of the top-level function (*function*).

If the argument is a string, the object sequence defined by the string is executed.

Access: \leftarrow PRG TYPE OBJ→ (PRG is the left-shift of the EVAL key).
 \leftarrow PRG LIST OBJ→ (PRG is the left-shift of the EVAL key).
 \rightarrow & EVAL NXT OBJ→
 \leftarrow PRG NXT CHARS NXT OBJ→ (PRG is the left-shift of the EVAL key).

Input/Output:

| Level 1/Argument 1 | | Level _{n+1} /Item _n | | Level _n /Item _n | | Level/Item _{n+1} |
|---------------------------------|---|---|---|---------------------------------------|--|---------------------------|
| (x, y) | → | | → | x | | y |
| $\{ obj_i, \dots, obj_n \}$ | → | obj_i | → | obj_n | | n |
| $[x_1, \dots, x_n]$ | → | x_1 | → | x_n | | $\{ n \}$ |
| $[[x_{11}, \dots, x_{m\ n}]]$ | → | x_{11} | → | $x_{m\ n}$ | | $\{ m, n \}$ |
| "obj" | → | | → | | | evaluated object |
| 'symb' | → | $arg_1 \dots arg_n$ | → | n | | 'function' |
| x_unit | → | | → | x | | 1_unit |
| :tag:obj | → | | → | obj | | "tag" |

See also: ARRY→, C→R, DTAG, EQ→, LIST→, R→C, STR→, →TAG

OCT

Type: Command

Description: Octal Mode Command: Selects octal base for binary integer operations.

(The default base is decimal.) Binary integers require the prefix #. Binary integers entered and returned in octal base automatically show the suffix o. If the current base is not octal, enter an octal number by ending it with o. It will be displayed in the current base when entered. The current base does not affect the internal representation of binary integers as unsigned binary numbers.

Access: \rightarrow BASE OCT (BASE is the right-shift of the 3 key).

Flags: Binary Integer Wordsize (-5 through -10), Binary Integer Base (-11, -12)

Input/Output: None

See also: BIN, DEC, HEX, RCWS, STWS

OFF

Type: Command

Description: Off Command: Turns off the calculator.

When executed from a program, that program will resume execution when the calculator is turned on. This provides a programmable "autostart." (i.e., a programmable \rightarrow OFF).

Access: \leftarrow PRG NXT NXT RUN NXT OFF (PRG is the left-shift of the EVAL key).

Input/Output: None

See also: CONT, HALT, KILL

OLDPRT

Type: Command

Description: Modifies the remapping string in the reserved variable PRTPAR so that the extended character set of the calculator matches that of the HP82240A infrared printer. To cancel OLDPRT character mapping, purge the PRTPAR variable. To print a string containing graphics data, disable OLDPRT.

Access:  CAT OLDPRT

See also: CR, DELAY, PRLCD, PRST, PRSTC, PRVAR, PR1

OPENIO

Type: Command

Description: Open I/O Port Command: Opens a serial port using the I/O parameters in the reserved variable IOPAR.

Since all hp49g+/hp48gII Kermit-protocol commands automatically effect an OPENIO first, OPENIO is not normally needed, but can be used if an I/O transmission does not work. OPENIO is necessary for interaction with devices that interpret a closed port as a break.

OPENIO is also necessary for the automatic reception of data into the input buffer using non-Kermit commands. If the port is closed, incoming characters are ignored. If the port is open, incoming characters are automatically placed in the input buffer. These characters can be detected with BUFLN, and can be read out of the input buffer using SRECV.

If the port is already open, OPENIO does not affect the data in the input buffer. However, if the port is closed, executing OPENIO clears the data in the input buffer.

Access:  CAT OPENIO

Flags: I/O Device (-33)

Input/Output: None

See also: BUFLN, CLOSEIO, SBRK, SRECV, STIME, XMIT

OR

Type: Function

Description: OR Function: Returns the logical OR of two arguments.

When the arguments are binary integers or strings, OR does a bit-by-bit (base 2) logical comparison.

- An argument that is a binary integer is treated as a sequence of bits as long as the current wordsize. Each bit in the result is determined by comparing the corresponding bits (*bit₁* and *bit₂*) in the two arguments as shown in the following table:

| <i>bit₁</i> | <i>bit₂</i> | <i>bit₁ OR bit₂</i> |
|------------------------|------------------------|---|
| 0 | 0 | 0 |
| 0 | 1 | 1 |
| 1 | 0 | 1 |
| 1 | 1 | 1 |

- An argument that is a string is treated as a sequence of bits, using 8 bits per character (that is, using the binary version of the character code). The two string arguments must be the same length.

When the arguments are real numbers or symbolics, OR simply does a true/false test. The result is 1 (true) if either or both arguments are nonzero; it is 0 (false) if both arguments are zero. This test is usually done to compare two test results.

If either or both of the arguments are algebraic objects, then the result is an algebraic of the form $symb_1$ OR $symb_2$. Execute \rightarrow NUM (or set flag -3 before executing OR) to produce a numeric result from the algebraic result.

Access: \leftarrow BASE \leftarrow NXT LOGIC OR (\leftarrow BASE is the right-shift of the $\boxed{3}$ key).
 \leftarrow PRG TEST \leftarrow NXT OR (\leftarrow PRG is the left-shift of the \boxed{EVAL} key).

Flags: Numerical Results (-3), Binary Integer Wordsize (-5 through -10)

Input/Output:

| Level 2/Argument 1 | Level 1/Argument 2 | | Level 1/Item 1 |
|------------------------|------------------------|---------------|---|
| $\#n_1$ | $\#n_2$ | \rightarrow | $\#n_3$ |
| "string ₁ " | "string ₂ " | \rightarrow | "strings" |
| T/F_1 | T/F_2 | \rightarrow | 0/1 |
| T/F | 'symb' | \rightarrow | 'T/F OR symb' |
| 'symb' | T/F | \rightarrow | 'symb OR T/F' |
| 'symb ₁ ' | 'symb ₂ ' | \rightarrow | 'symb ₁ OR symb ₂ ' |

See also: AND, NOT, XOR

ORDER

Type: Command

Description: Order Variables Command: Reorders the variables in the current directory (shown in the VAR menu) to the order specified.

The names that appear first in the list will be the first to appear in the VAR menu. Variables not specified in the list are placed after the reordered variables.

If the list includes the name of a large subdirectory, there may be insufficient memory to execute ORDER.

Access: \leftarrow PRG MEMORY DIRECTORY \leftarrow NXT ORDER (\leftarrow PRG is the left-shift of the \boxed{EVAL} key).

Input/Output:

| Level 1/Argument 1 | | Level 1/Item 1 |
|---|---------------|----------------|
| { global ₁ ... global _n } | \rightarrow | |

See also: VARS

OVER

Type: RPL command

Description: Over Command: Returns a copy to stack level 1 of the object in level 2.

Access: \leftarrow PRG STACK OVER (\leftarrow PRG is the left-shift of the \boxed{EVAL} key).

Input/Output:

| Level 2 | Level 1 | | Level 3 | Level 2 | Level 1 |
|---------|---------|---------------|---------|---------|---------|
| obj_1 | obj_2 | \rightarrow | obj_1 | obj_2 | obj_1 |

See also: PICK, ROLL, ROLLD, ROT, SWAP

P2C

CAS: Decompose a permutation into lists that represent cycles.

PA2B2

CAS: Given prime p , with $p=2$ or $p \equiv 1$ modulo 4, return Gaussian integer $a + ib$ such that $p = a^2 + b^2$.

PARAMETRIC

Type: Command

Description: Parametric Plot Type Command: Sets the plot type to PARAMETRIC.

When the plot type is PARAMETRIC, the DRAW command plots the current equation as a complex-valued function of one real variable. The current equation is specified in the reserved variable EQ . The plotting parameters are specified in the reserved variable $PPAR$, which has the following form:

$$\{ (x_{\min}, y_{\min}), (x_{\max}, y_{\max}), indep, res, axes, ptype, depend \}$$

For plot type PARAMETRIC, the elements of $PPAR$ are used as follows:

- (x_{\min}, y_{\min}) is a complex number specifying the lower left corner of $PICT$ (the lower left corner of the display range). The default value is $(-6.5, -3.1)$ for the hp48gII and $(-6.5, -3.9)$ for the hp49g+.
- (x_{\max}, y_{\max}) is a complex number specifying the upper right corner of $PICT$ (the upper right corner of the display range). The default value is $(6.5, 3.2)$ for the hp48gII and $(6.5, 4.0)$ for the hp49g+.
- $indep$ is a list containing a name that specifies the independent variable, and two numbers specifying the minimum and maximum values for the independent variable (the plotting range). Note that the default value is X . If X is not modified and included in a list with a plotting range, the values in (x_{\min}, y_{\min}) and (x_{\max}, y_{\max}) are used as the plotting range, which generally leads to meaningless results.
- res is a real number specifying the interval, in user-unit coordinates, between values of the independent variable. The default value is 0, which specifies an interval equal to $1/130$ of the difference between the maximum and minimum values in $indep$ (the plotting range).
- $axes$ is a list containing one or more of the following, in the order listed: a complex number specifying the user-unit coordinates of the plot origin, a list specifying the tick-mark annotation, and two strings specifying labels for the horizontal and vertical axes. The default value is $(0,0)$.
- $ptype$ is a command name specifying the plot type. Executing the command PARAMETRIC places the name PARAMETRIC in $PPAR$.
- $depend$ is a name specifying a label for the vertical axis. The default value is Y .

The contents of EQ must be an expression or program; it cannot be an equation. It is evaluated for each value of the independent variable. The results, which must be complex numbers, give the coordinates of the points to be plotted. Lines are drawn between plotted points unless flag -31 is set.

Access:  CAT PARAMETRIC

Flags: Simultaneous Plotting (-28), Curve Filling (-31)

Input/Output: None

See also: BAR, CONIC, DIFFEQ, FUNCTION, GRIDMAP, HISTOGRAM, PARSURFACE, PCONTOUR, POLAR, SCATTER, SLOPEFIELD, TRUTH, WIREFRAME, YSLICE

PARITY

Type: Command

Description: Parity Command: Sets the parity value in the reserved variable $IOPAR$.

Legal values are shown below. A negative value means the hp49g+/hp48gII does not check parity on bytes received during Kermit transfers or with SRECV. Parity is still used during data transmission, however.

| <i>n</i> -Value | Meaning |
|-----------------|-------------------------------|
| 0 | no parity (the default value) |
| 1 | odd parity |
| 2 | even parity |
| 3 | mark |
| 4 | space |

Access:  CAT PARITY

Input/Output:

| Level 1/Argument 1 | Level 1/Item 1 |
|---------------------|----------------|
| n_{parity} | → |

See also: BAUD, CKSM, TRANSIO

PARSURFACE

Type: Command

Description: PARSURFACE Plot Type Command: Sets plot type to PARSURFACE.

When plot type is set to PARSURFACE, the DRAW command plots an image graph of a 3-vector-valued function of two variables. PARSURFACE requires values in the reserved variables *EQ*, *VPAR*, and *PPAR*.

VPAR is made up of the following elements:

$\{ x_{\text{left}}, x_{\text{right}}, y_{\text{near}}, y_{\text{far}}, z_{\text{low}}, z_{\text{high}}, x_{\text{min}}, x_{\text{max}}, y_{\text{min}}, y_{\text{max}}, x_{\text{eye}}, y_{\text{eye}}, z_{\text{eye}}, x_{\text{step}}, y_{\text{step}} \}$

For plot type PARSURFACE, the elements of *VPAR* are used as follows:

- x_{left} and x_{right} are real numbers that specify the width of the view space.
- y_{near} and y_{far} are real numbers that specify the depth of the view space.
- z_{low} and z_{high} are real numbers that specify the height of the view space.
- x_{min} and x_{max} are real numbers that specify the input region's width. The default value is $(-1,1)$.
- y_{min} and y_{max} are real numbers that specify the input region's depth. The default value is $(-1,1)$.
- $x_{\text{eye}}, y_{\text{eye}},$ and z_{eye} are real numbers that specify the point in space from which the graph is viewed.
- x_{step} and y_{step} are real numbers that set the number of x-coordinates versus the number of y-coordinates plotted.

The plotting parameters are specified in the reserved variable *PPAR*, which has this form:

$\{ (x_{\text{min}}, y_{\text{min}}), (x_{\text{max}}, y_{\text{max}}), \textit{indep}, \textit{res}, \textit{axes}, \textit{ptype}, \textit{depend} \}$

For plot type PARSURFACE, the elements of *PPAR* are used as follows:

- $(x_{\text{min}}, y_{\text{min}})$ is not used.
- $(x_{\text{max}}, y_{\text{max}})$ is not used.
- *indep* is a name specifying the independent variable. The default value of *indep* is *X*.
- *res* is not used.
- *axes* is not used.
- *ptype* is a command name specifying the plot type. Executing the command PARSURFACE places the name PARSURFACE in *ptype*.
- *depend* is a name specifying the dependent variable. The default value is *Y*.

Access:  CAT PARSURFACE

Input/Output: None

See also: BAR, CONIC, DIFFEQ, FAST3D, FUNCTION, GRIDMAP, HISTOGRAM, PARAMETRIC, PCONTOUR, POLAR, SCATTER, SLOPEFIELD, TRUTH, WIREFRAME, YSLICE

PARTFRAC

CAS: Perform partial fraction decomposition on a partial fraction.

PATH

Type: Command

Description: Current Path Command: Returns a list specifying the path to the current directory.

The first directory is always *HOME*, and the last directory is always the current directory.

If a program needs to switch to a specific directory, it can do so by evaluating a directory list, such as one created earlier by *PATH*.

Access: \leftarrow PRG MEMORY DIRECTORY PATH (PRG is the left-shift of the EVAL key).

Input/Output:

| Level 1/Argument 1 | Level 1/Item 1 |
|--------------------|--|
| | \rightarrow { HOME directory-name ₁ ... directory-name _n } |

See also: CRDIR, HOME, PGDIR, UPDIR

PCAR

CAS: Return the characteristic polynomial of a square matrix.

PCOEF

Type: Command

Description: Monic Polynomial Coefficients Command: Returns the coefficients of a monic polynomial (a polynomial with a leading coefficient of 1) having specific roots.

The argument must be a real or complex array of length *n* containing the polynomial's roots. The result is a real or complex vector of length *n*+1 containing the coefficients listed from highest order to lowest, with a leading coefficient of 1.

Access: \leftarrow ARITH POLYNOMIAL $\boxed{\text{NXT}}$ $\boxed{\text{NXT}}$ PCOEF (ARITH is the left-shift of the I key).

Input/Output:

| Level 1/Argument 1 | Level 1/Item 1 |
|--------------------------|---|
| $[array]_{\text{roots}}$ | \rightarrow $[array]_{\text{coefficients}}$ |

See also: PEVAL, PROOT

PCONTOUR

Type: Command

Description: PCONTOUR Plot Type Command: Sets the plot type to PCONTOUR.

When plot type is set PCONTOUR, the DRAW command plots a contour-map view of a scalar function of two variables. PCONTOUR requires values in the reserved variables *EQ*, *VPAR*, and *PPAR*.

VPAR is made up of the following elements:

$$\{ x_{\text{left}} x_{\text{right}} y_{\text{near}} y_{\text{far}} z_{\text{low}} z_{\text{high}} x_{\text{min}} x_{\text{max}} y_{\text{min}} y_{\text{max}} x_{\text{eye}} y_{\text{eye}} z_{\text{eye}} x_{\text{step}} y_{\text{step}} \}$$

For plot type PCONTOUR, the elements of *VPAR* are used as follows:

- x_{left} and x_{right} are real numbers that specify the width of the view space.
- y_{near} and y_{far} are real numbers that specify the depth of the view space.
- z_{low} and z_{high} are real numbers that specify the height of the view space.
- x_{min} and x_{max} are not used.
- y_{min} and y_{max} are not used.

- x_{eye} , y_{eye} , and z_{eye} are real numbers that specify the point in space from which the graph is viewed.
- x_{step} and y_{step} are real numbers that set the number of x-coordinates versus the number of y-coordinates plotted.

The plotting parameters are specified in the reserved variable $PPAR$, which has this form:

$$\{ (x_{min}, y_{min}) (x_{max}, y_{max}) indep res axes ptype depend \}$$

For plot type PCONTOUR, the elements of $PPAR$ are used as follows:

- (x_{min}, y_{min}) and (x_{max}, y_{max}) are not used.
- *indep* is a name specifying the independent variable. The default value of *indep* is X .
- *res* is not used.
- *axes* is not used.
- *ptype* is a command name specifying the plot type. Executing the command PCONTOUR places the name PCONTOUR in *ptype*.
- *depend* is a name specifying the dependent variable. The default value is Y .

Access:  CAT PCONTOUR

Input/Output: None

See also: BAR, CONIC, DIFFEQ, FUNCTION, GRIDMAP, HISTOGRAM, PARAMETRIC, PARSURFACE, POLAR, SCATTER, SLOPEFIELD, TRUTH, WIREFRAME, YSLICE

PCOV

Type: Command

Description: Population Covariance Command: Returns the population covariance of the independent and dependent data columns in the current statistics matrix (reserved variable ΣDAT).

The columns are specified by the first two elements in reserved variable ΣPAR , set by XCOL and YCOL respectively. If ΣPAR does not exist, PCOV creates it and sets the elements to their default values (1 and 2).

The population covariance is calculated with the following formula:

$$\frac{1}{n} \sum_{k=1}^n (x_{kn_1} - \bar{x}_{n_1})(x_{kn_2} - \bar{x}_{n_2})$$

where x_{kn_1} is the k th coordinate value in column n_1 , x_{kn_2} is the k th coordinate value in the column n_2 , \bar{x}_{n_1} is the mean of the data in column n_1 , \bar{x}_{n_2} is the mean of the data in column n_2 , and n is the number of data points.

Access:  CAT PCOV

Input/Output:

| Level 1/Argument 1 | Level 1/Item 1 |
|--------------------|---------------------|
| | → $x_{pcovariance}$ |

See also: COLΣ, CORR, COV, PREDX, PREDY, XCOL, YCOL

PDIM

Type: Command

Description: PICT Dimension Command: Replaces $PICT$ with a blank $PICT$ of the specified dimensions.

If the arguments are complex numbers, PDIM changes the size of $PICT$ and makes the arguments the new values of (x_{min}, y_{min}) and (x_{max}, y_{max}) in the reserved variable $PPAR$. Thus, the scale of a subsequent plot is not changed. If the arguments are binary integers, $PPAR$ remains unchanged, so the scale of a subsequent plot *is* changed.

PICT cannot be smaller than 131 pixels wide × 80 pixels high on the hp49g+ (64 pixels on the hp48gII) nor wider than 2048 pixels (height is unlimited).

Access: \leftarrow PRG PICT PDIM (\leftarrow PRG is the left-shift of the $\boxed{\text{EVAL}}$ key).

Input/Output:

| Level 2/Argument 1 | Level 1/Argument 2 | Level 1/Item 1 |
|------------------------|------------------------|----------------|
| (x_{\min}, y_{\min}) | (x_{\max}, y_{\max}) | \rightarrow |
| $\#n_{\text{width}}$ | $\#m_{\text{height}}$ | \rightarrow |

See also: PMAX, PMIN

PERM

Type: Function

Description: Permutations Function: Returns the number of possible permutations of n items taken m at a time.

The formula used to calculate $P_{n,m}$ is:

$$P_{n,m} = \frac{n!}{(n-m)!}$$

The arguments n and m must each be less than 10^{12} . If $n < m$, zero is returned.

Access: \leftarrow MTH $\boxed{\text{NXT}}$ PROBABILITY PERM (\leftarrow MTH is the left-shift of the $\boxed{\text{SYMB}}$ key).

Flags: Numerical Results (-3)

Input/Output:

| Level 2/Argument 1 | Level 1/Argument 2 | Level 1/Item 1 |
|--------------------|--------------------|--|
| n | m | $\rightarrow P_{n,m}$ |
| ' $sybm_n$ ' | m | \rightarrow 'PERM($sybm_n$)' |
| n | ' $sybm_m$ ' | \rightarrow 'PERM($n, sybm_m$)' |
| ' $sybm_n$ ' | ' $sybm_m$ ' | \rightarrow 'PERM($sybm_n, sybm_m$)' |

See also: COMB, FACT, !

PEVAL

Type: Command

Description: Polynomial Evaluation Command: Evaluates an n -degree polynomial at x .

The arguments must be an array of length $n + 1$ containing the polynomial's coefficients listed from highest order to lowest, and the value x at which the polynomial is to be evaluated.

Access: \rightarrow $\boxed{\text{CAT}}$ PEVAL

Input/Output:

| Level 2/Argument 1 | Level 1/Argument 2 | Level 1/Item 1 |
|---------------------------------|--------------------|--------------------|
| $[array]_{\text{coefficients}}$ | x | $\rightarrow p(x)$ |

See also: PCOEF, PROOT

PGDIR

Type: Command

Description: Purge Directory Command: Purges the named directory (whether empty or not).

Access: \leftarrow PRG MEMORY DIRECTORY PGDIR (\leftarrow PRG is the left-shift of the $\boxed{\text{EVAL}}$ key).

Input/Output:

| Level 1/Argument 1 | Level 1/Item 1 |
|--------------------|----------------|
| ' $global$ ' | \rightarrow |

See also: CLVAR, CRDIR, HOME, PATH, PURGE, UPDIR

PICK

Type: RPL Command

Description: Pick Object Command: Copies the contents of a specified stack level to level 1.

Access: \leftarrow PRG STACK PICK (\leftarrow PRG is the left-shift of the $\boxed{\text{EVAL}}$ key).

Input/Output:

| | | | | | | |
|-----------------|---------|-------|---------------|---------------|---------|---------|
| $L_{n+1} \dots$ | L_2 | L_1 | | L_{n+1} | L_2 | L_1 |
| $obj_n \dots$ | obj_1 | n | \rightarrow | $obj_n \dots$ | obj_1 | obj_j |

L = Level

See also: DUP, DUPN, DUP2, OVER, ROLL, ROLL2, ROT, SWAP

PICK3

Type: RPL Command

Description: Duplicates the object on level 3 of the stack.

Access: \leftarrow PRG STACK $\boxed{\text{NXT}}$ PICK3 (\leftarrow PRG is the left-shift of the $\boxed{\text{EVAL}}$ key).

Input/Output:

| | | | | | | | |
|---------|---------|---------|---------------|---------|---------|---------|---------|
| L_3 | L_2 | L_1 | | L_4 | L_3 | L_2 | L_1 |
| obj_i | obj_j | obj_s | \rightarrow | obj_i | obj_j | obj_s | obj_i |

L = Level; A = Argument; I = Item

See also: PICK, OVER, DUP

PICT

Type: Command

Description: PICT Command: Puts the name PICT on the stack.

PICT is the name of a storage location in calculator memory containing the current graphics object. The command PICT enables access to the contents of that memory location as if it were a variable. Note, however, that *PICT* is *not* a variable as defined in the hp49g+/hp48gII: its name cannot be quoted, and only graphics objects may be stored in it.

If a graphics object smaller than 131 wide \times 80 pixels high is stored in *PICT*, it is enlarged to 131 \times 80. (These values are 131 \times 64 on the hp48gII). A graphics object of unlimited pixel height and up to 2048 pixels wide can be stored in *PICT*.

Access: \leftarrow PRG $\boxed{\text{NXT}}$ [PICT] PICT (\leftarrow PRG is the left-shift of the $\boxed{\text{EVAL}}$ key).

Input/Output:

| | | |
|---------------------------|---------------|-----------------------|
| Level 1/Argument 1 | | Level 1/Item 1 |
| | \rightarrow | <i>PICT</i> |

See also: GOR, GXOR, NEG, PICTURE, PVIEW, RCL, REPL, SIZE, STO, SUB

PICTURE

Type: Command

Description: Picture Environment Command: Selects the Picture environment (that is, selects the graphics display and activates the graphics cursor and Picture menu).

When executed from a program, PICTURE suspends program execution until $\overline{\text{CANCEL}}$ is pressed.

Access: $\boxed{\rightarrow}$ CAT PICTURE



Input/Output: None

See also: PICTURE, PVIEW, TEXT

PINIT

Type: Command

Description: Port Initialize Command: Initializes all currently active ports. It may affect data already stored in a port.

Access:   PINIT

Input/Output: None

PIX?

Type: Command

Description: Pixel On? Command: Tests whether the specified pixel in *PICT* is on; returns 1 (true) if the pixel is on, and 0 (false) if the pixel is off.

Access:    *PICT*  *PIX?* ( is the left-shift of the  key).

Input/Output:

| Level 1/Argument 1 | | Level 1/Item 1 |
|--------------------|---|----------------|
| (x,y) | → | 0/1 |
| { #n #m } | → | 0/1 |

See also: PIXON, PIXOFF

PIXOFF

Type: Command

Description: Pixel Off Command: Turns off the pixel at the specified coordinate in *PICT*.

Access:    *PICT*  *PIXOFF* ( is the left-shift of the  key).

Input/Output:

| Level 1/Argument 1 | | Level 1/Item 1 |
|--------------------|---|----------------|
| (x,y) | → | |
| { #n #m } | → | |

See also: PIXON, PIX?

PIXON

Type: Command

Description: Pixel On Command: Turns on the pixel at the specified coordinate in *PICT*.

Access:    *PICT*  *PIXON* ( is the left-shift of the  key).

Input/Output:

| Level 1/Argument 1 | | Level 1/Item 1 |
|--------------------|---|----------------|
| (x,y) | → | |
| { #n #m } | → | |

See also: PIXOFF, PIX?

PKT

Type: Command

Description: Packet Command: Used to send command “packets” (and receive requested data) to a Kermit server.

To send hp49g+/hp48gII objects, use SEND.

PKT allows additional commands to be sent to a Kermit server.

The packet data, packet type, and the response to the packet transmission are all in string form. PKT first does an I (*initialization*) packet exchange with the Kermit server, then sends the server a packet constructed from the data and packet-type arguments supplied to PKT. The response to PKT will be either an acknowledging string (possibly blank) or an error packet (see KERRM).

For the *type* argument, only the first letter is significant.

Access:  CAT PKT

Flags: I/O Device (-33), I/O Messages (-39). The I/O Data Format flag (-35) can be significant if the server sends back more than one packet.

Input/Output:

| Level 2/Argument 1 | Level 1/Argument 2 | Level 1/Item 1 |
|--------------------|--------------------|----------------|
| "data" | "type" → | "response" |

See also: CLOSEIO, KERRM, SERVER

PLOT

Type: Command

Description: Stores its argument in *EQ* and opens the PLOT SETUP screen.

Access:  GRAPH PLOT

Input: An expression.

Output: The input expression.

Example: Store SIN(X) in EQ and open the PLOT SETUP screen:

Command: PLOT (SIN (X))

Result: PLOT SETUP screen is open with SIN(X) in *EQ*. SIN(X) is copied to history (LASTARG in RPN mode).

See also: PLOTADD

PLOTADD

Type: Function

Description: Adds a function to the existing plot function list, and opens the Plot Setup screen.

Access:  GRAPH PLOTA

Input/Output:

| Level 1/Argument 1 | Level 1/Item 1 |
|--------------------|----------------|
| (<i>sybm</i>) → | |

PMAX

Type: Command

Description: PICT Maximum Command: Specifies (*x,y*) as the coordinates at the upper right corner of the display.

The complex number (*x,y*) is stored as the second element in the reserved variable *PPAR*.

Access:  CAT PMAX

Input/Output:

| Level 1/Argument 1 | Level 1/Item 1 |
|--------------------|----------------|
| (<i>x,y</i>) → | |

See also: PDIM, PMIN, XRNG, YRNG

PMIN

Type: Command

Description: PICT Minimum Command: Specifies (x, y) as the coordinates at the lower left corner of the display. The complex number (x, y) is stored as the first element in the reserved variable *PPAR*.

Access:   *CAT* PMIN

Input/Output:

| Level 1/Argument 1 | Level 1/Item 1 |
|--------------------|----------------|
| (x, y) | → |

See also: PDIM, PMAX, XRNG, YRNG

PMINI

CAS: Find the minimal polynomial of a matrix.

POLAR

Type: Command

Description: Polar Plot Type Command: Sets the plot type to POLAR.

When the plot type is POLAR, the DRAW command plots the current equation in polar coordinates, where the independent variable is the polar angle and the dependent variable is the radius. The current equation is specified in the reserved variable *EQ*.

The plotting parameters are specified in the reserved variable *PPAR*, which has this form:

$$\{ (x_{\min}, y_{\min}) (x_{\max}, y_{\max}) \textit{ indep res axes ptype depend } \}$$

For plot type POLAR, the elements of *PPAR* are used as follows:

- (x_{\min}, y_{\min}) is a complex number specifying the lower left corner of *PICT* (the lower left corner of the display range). The default value is $(-6.5, -3.1)$ for the hp48gII and $(-6.5, -3.9)$ for the hp49g+.
- (x_{\max}, y_{\max}) is a complex number specifying the upper right corner of *PICT* (the upper right corner of the display range). The default value is $(6.5, 3.2)$ for the hp48gII and $(6.5, 4.0)$ for the hp49g+.
- *indep* is a name specifying the independent variable, or a list containing such a name and two numbers specifying the minimum and maximum values for the independent variable (the plotting range). The default value of *indep* is *X*.
- *res* is a real number specifying the interval, in user-unit coordinates, between values of the independent variable. The default value is 0, which specifies an interval of 2 degrees, 2 grads, or $\pi/90$ radians.
- *axes* is a list containing one or more of the following, in the order listed: a complex number specifying the user-unit coordinates of the plot origin, a list specifying the tick-mark annotation, and two strings specifying labels for the horizontal and vertical axes. The default value is $(0, 0)$.
- *ptype* is a command name specifying the plot type. Executing the command POLAR places the name POLAR in *ptype*.
- *depend* is a name specifying a label for the vertical axis. The default value is *Y*.

The current equation is plotted as a function of the variable specified in *indep*. The minimum and maximum values of the independent variable (the plotting range) can be specified in *indep*; otherwise, the default minimum value is 0 and the default maximum value corresponds to one full circle in the current angle mode (360 degrees, 400 grads, or 2π radians). Lines are drawn between plotted points unless flag -31 is set.

If flag -28 is set, all equations are plotted simultaneously.

If *EQ* contains an expression or program, the expression or program is evaluated in Numerical Results mode for each value of the independent variable to give the values of the dependent variable. If *EQ* contains an equation, the plotting action depends on the form of the equation.

| Form of Current Equation | Plotting Action |
|-----------------------------|---|
| $\text{expr} = \text{expr}$ | Each expression is plotted separately. The intersection of the two graphs shows where the expressions are equal |
| $\text{name} = \text{expr}$ | Only the expression is plotted |

Access: POLAR

Flags: Simultaneous Plotting (-28), Curve Filling (-31)

Input/Output: None

See also: BAR, CONIC, DIFFEQ, FUNCTION, GRIDMAP, HISTOGRAM, PARAMETRIC, PARSURFACE, PCONTOUR, SCATTER, SLOPEFIELD, TRUTH, WIREFRAME, YSLICE

POLYNOMIAL

CAS: Display a menu or list of CAS operations with polynomials.

POP

Type: Command

Description: Restores the flags and current directory saved by the most recent execution of PUSH. If no PUSH saves are left, the command has no effect.

Access: POP

Input: None

Output: In Algebraic mode the command returns NOVAL to level 1 of the stack.

See also: PUSH

POS

Type: Command

Description: Position Command: Returns the position of a substring within a string or the position of an object within a list.

If there is no match for *obj* or *substring*, POS returns zero.

Access: CHARS POS (is the left-shift of the key).

LIST ELEM POS (is the left-shift of the key).

& POS

Input/Output:

| Level 2/Argument 1 | Level 1/Argument 2 | | Level 1/Item 1 |
|--------------------|--------------------|---|----------------|
| <i>"string"</i> | <i>"substring"</i> | → | <i>n</i> |
| { <i>list</i> } | <i>obj</i> | → | <i>n</i> |

See also: CHR, NUM, REPL, SIZE, SUB

POTENTIAL

CAS: Find the potential field function describing a field whose vector gradient is input.

POWEXPAND

CAS: Rewrite an expression raised to a power as a product.

POWMOD

CAS: Raise number or expression to given power, express the result modulo the current modulus.

PR1

Type: Command

Description: Print Level 1 Command: Prints an object in multiline printer format.

All objects except strings are printed with their identifying delimiters. Strings are printed without the leading and trailing " delimiters.

Multiline printer format is similar to multiline display format, with the following exceptions:

- Strings and names that are more than 24 characters long are continued on the next printer line.
- The real and imaginary parts of complex numbers are printed on separate lines if they don't fit on the same line.
- Grobs are printed graphically.
- Arrays are printed with a numbered heading for each row and with a column number before each element.

For example, the 2×3 array

$$\begin{bmatrix} 1 & 2 & 3 \\ 4 & 5 & 6 \end{bmatrix}$$

would be printed as follows:

Array (2 3)

Row 1

1] 1

2] 2

3] 3

Row 2

1] 4

2] 5

3] 6

Access:  CAT PR1

Flags: I/O Device (-33), Printing Device (-34), Double-spaced Printing (-37), Linefeed (-38). If flag -34 is set, flag -33 must be clear.

Input/Output:

| Level 1/Argument 1 | Level 1/Item 1 |
|--------------------|----------------|
| <i>object</i> | <i>object</i> |

See also: CR, DELAY, OLDPR1, PRLCD, PRST, PRSTC, PRVAR

PREDV

Type: Command

Description: Predicted y-Value Command: Returns the predicted dependent-variable value $y_{\text{dependent}}$, based on the independent-variable value $x_{\text{independent}}$, the currently selected statistical model, and the current regression coefficients in the reserved variable ΣPAR .

PREDV is the same as PREDY. See PREDY.

Access:  CAT PREDV

Input/Output:

| Level 1/Argument 1 | Level 1/Item 1 |
|--------------------------|------------------------|
| $x_{\text{independent}}$ | $y_{\text{dependent}}$ |

See also: PREDY

PREDX

Type: Command

Description: Predicted x-Value Command: Returns the predicted independent-variable value $x_{\text{independent}}$, based on the dependent-variable value $y_{\text{dependent}}$, the currently selected statistical model, and the current regression coefficients in the reserved variable ΣPAR .

The value is predicted using the regression coefficients most recently computed with LR and stored in the reserved variable ΣPAR . For the linear statistical model, the equation used is this:

$$y_{\text{dependent}} = (mx_{\text{independent}}) + b$$

where m is the slope (the third element in ΣPAR) and b is the intercept (the fourth element in ΣPAR).

For the other statistical models, the equations used by PREDX are listed in the LR entry.

If PREDX is executed without having previously generated regression coefficients in ΣPAR , a default value of zero is used for both regression coefficients, and an error results.

Access:  CAT PREDX

Input/Output:

| Level 1/Argument 1 | Level 1/Item 1 |
|------------------------|--------------------------|
| $y_{\text{dependent}}$ | $x_{\text{independent}}$ |

See also: COLΣ, CORR, COV, EXPFIT, ΣLINE, LINFIT, LOGFIT, LR, PREDY, PWRFIT, XCOL, YCOL

PREDY

Type: Command

Description: Predicted y-Value Command: Returns the predicted dependent-variable value $y_{\text{dependent}}$, based on the independent-variable value $x_{\text{independent}}$, the currently selected statistical model, and the current regression coefficients in the reserved variable ΣPAR .

The value is predicted using the regression coefficients most recently computed with LR and stored in the reserved variable ΣPAR . For the linear statistical model, the equation used is this:

$$y_{\text{dependent}} = (mx_{\text{independent}}) + b$$

where m is the slope (the third element in ΣPAR) and b is the intercept (the fourth element in ΣPAR).

For the other statistical models, the equations used by PREDY are listed in the LR entry.

If PREDY is executed without having previously generated regression coefficients in ΣPAR , a default value of zero is used for both regression coefficients—in this case PREDY will return 0 for statistical models LINFIT and LOGFIT, and error for statistical models EXPFIT and PWRFIT.

Access:  CAT PREDY

Input/Output:

| Level 1/Argument 1 | Level 1/Item 1 |
|--------------------------|------------------------|
| $x_{\text{independent}}$ | $y_{\text{dependent}}$ |

See also: COLΣ, CORR, COV, EXPFIT, ΣLINE, LINFIT, LOGFIT, LR, PREDX, PWRFIT, XCOL, YCOL

PREVAL

CAS: Return difference between values of a function at two specified values of the current variable.

PREVPRIME

CAS: Given an integer, find the closest prime number smaller than the integer.

PRLCD

Type: Command

Description: Print LCD Command: Prints a pixel-by-pixel image of the current display (excluding the annunciators).

The width of the printed image of characters in the display is narrower using PRLCD than using a print command such as PR1. The difference results from the spacing between characters. On the display there is a single blank column between characters, and PRLCD prints this spacing. Print commands such as PR1 print two blank columns between adjacent characters.

Access:  CAT PRLCD

Flags: I/O Device (-33), Printing Device (-34), Double-spaced Printing (-37), Linefeed (-38). Flag -38 must be clear. If flag -34 is set, flag -33 must be clear.

Input/Output: None

See also: CR, DELAY, OLDPRT, PRST, PRSTC, PRVAR, PR1

PROMPT

Type: Command

Description: Prompt Command: Displays the contents of “*prompt*” in the status area, and halts program execution.

Access:  PRG  IN  PROMPT (PRG is the left-shift of the  key).

Input/Output:

| Level 1/Argument 1 | Level 1/Item 1 |
|--------------------|----------------|
| <i>“prompt”</i> | → |

See also: CONT, DISP, FREEZE, HALT, INFORM, INPUT, MSGBOX

PROMPTSTO

Type: Command

Description: Prompt Command: Creates a variable with the name supplied as an argument, prompts for a value, and stores the value you enter in the variable.

Access:  CAT PROMPTSTO

Input/Output:

| Level 1/Argument 1 | Level 1/Item 1 |
|--------------------|----------------|
| <i>“global”</i> | → |

See also: PROMPT, STO

PROOT

Type: Command

Description: Polynomial Roots Command: Returns all roots of an n -degree polynomial having real or complex coefficients.

For an n^{th} -order polynomial, the argument must be a real or complex array of length $n + 1$ containing the coefficients listed from highest order to lowest. The result is a real or complex vector of length n containing the computed roots.

PROOT interprets leading coefficients of zero in a limiting sense. As a leading coefficient approaches zero, a root of the polynomial approaches infinity: therefore, if flag -22 is clear (the default), PROOT reports an Infinite Result error if a leading coefficient is zero. If flag -22 is set, PROOT returns a root of (MAXREAL,0) for each leading zero in an array containing real coefficients, and a root of (MAXREAL,MAXREAL) for each leading zero in an array containing complex coefficients.

Access:  ARITH POLYNOMIAL   PROOT (ARITH is the left-shift of the  key).

Flags: Infinite Result Exception (-22)

Input/Output:

| Level 1/Argument 1 | Level 1/Item 1 |
|--------------------------|-------------------|
| $[array]_{coefficients}$ | $[array]_{roots}$ |

See also: PCOEF, PEVAL

PROPFRAC

CAS: Split an improper fraction, a ratio of integers or expressions, into an integer part and a fraction part.

PRST

Type: Command

Description: Print Stack Command: Prints all objects in the stack, starting with the object on the highest level. Objects are printed in multiline printer format. See the PR1 entry for a description of multiline printer format.

Access:  CAT PRST

Flags: I/O Device (-33), Printing Device (-34), Double-spaced Printing (-37), Linefeed (-38). If flag -34 is set, flag -33 must be clear. Generally, flag -38 should be clear.

Input/Output: None

See also: CR, DELAY, OLDPR1, PRLCD, PRSTC, PRVAR, PR1

PRSTC

Type: Command

Description: Print Stack (Compact) Command: Prints in compact form all objects in the stack, starting with the object on the highest level.

Compact printer format is the same as compact display format. Multiline objects are truncated and appear on one line only.

Access:  CAT PRSTC

Flags: I/O Device (-33), Printing Device (-34), Double-spaced Printing (-37), Linefeed (-38)

Input/Output: None

See also: CR, DELAY, OLDPR1, PRLCD, PRST, PRVAR, PR1

PRVAR

Type: Command

Description: Print Variable Command: Searches the current directory path or port for the specified variables and prints the name and contents of each variable.

Objects are printed in multiline printer format. See the PR1 entry for a description of multiline printer format.

Access:  CAT PRVAR

Flags: I/O Device (-33), Printing Device (-34), Double-spaced Printing (-37), Linefeed (-38). If flag -34 is set, flag -33 must be clear. Generally, flag -38 should be clear.

Input/Output:

| Level 1/Argument 1 | Level 1/Item 1 |
|---|----------------|
| 'name' | → |
| { name ₁ name ₂ ... } | → |
| :n _{port} : 'global' | → |

See also: CR, DELAY, OLDPR1, PR1, PRLCD, PRST, PRSTC

PSDEV

Type: Command

Description: Population Standard Deviation Command: Calculates the population standard deviation of each of the m columns of coordinate values in the current statistics matrix (reserved variable ΣDAT). PSDEV returns a vector of m real numbers, or a single real number if $m = 1$. The population standard deviation is computed using this formula:

$$\sqrt{\frac{1}{n} \sum_{k=1}^n (x_k - \bar{x})^2}$$

where x_k is the k th coordinate value in a column, \bar{x} is the mean of the data in this column, and n is the number of data points.

Access:  CAT PSDEV

Input/Output:

| Level 1/Argument 1 | Level 1/Item 1 |
|--------------------|--|
| | x_{psdev} |
| | $\{ x_{psdev1} \ x_{psdev2} \ \dots \ x_{psdevm} \}$ |

See also: MEAN, PCOV, PVAR, SDEV, TOT, VAR

PSI

Type: Function

Description: Calculates the polygamma function, the n th derivative of the digamma function, at a point a . $\text{PSI}(a, 0)$ is equivalent to $\text{Psi}(a)$.

Access:  MTH  SPECIAL

Input: Level 2/Argument 1: A real or complex expression specifying the point a .
Level 1/Argument 2: A non-negative integer, n .

Output: The value of the polygamma function $\text{PSI}(a, n)$.

Flags: Exact mode must be set (flag -105 clear), and numeric mode must not be set (flag -3 clear), if symbolic results are wanted. Complex mode must be set (flag -103 set) if a complex value is used for point a .

See also: Psi

Psi

Type: Function

Description: Calculates the digamma function at a point a . The digamma function is the derivative of the natural logarithm (\ln) of the gamma function. The function can be represented as follows:

$$\Psi(z) = \frac{d}{dz}(\ln \Gamma(z)) = \frac{\Gamma'(z)}{\Gamma(z)}$$

Access:  MTH  SPECIAL

Input: A real or complex expression specifying the point a .

Output: The digamma function at the specified point.

Flags: Exact mode must be set (flag -105 clear), and numeric mode must not be set (flag -3 clear), if symbolic results are wanted. For example, with these settings, $\text{Psi}(3)$ evaluates to the symbolic value $\text{Psi}(3)$. Complex mode must be set (flag -103 set) if a complex value is used for point a .

See also: PSI

PTAYL

CAS: Return the Taylor polynomial at $x = a$ for given a and a specified polynomial.

PURGE

Type: Command

Description: Purge Command: Purges the named variables or empty subdirectories from the current directory. PURGE executed in a program does not save its argument for recovery by LASTARG.

To empty a named directory before purging it, use PGDIR.

To help prepare a list of variables for purging, use VARS.

Purging *PICT* replaces the current graphics object with a 0×0 graphics object.

If a list of objects (with global names, backup objects, library objects, or *PICT*) for purging contains an invalid object, then the objects preceding the invalid object are purged, and the error Bad Argument Type occurs.

To purge a library or backup object, tag the library number or backup name with the appropriate port number ($:n_{\text{port}}$), which must be in the range from 0 to 3. For a backup object, the port number can be replaced with the wildcard character &, in which case the hp49g+/hp48gII will search ports 0 through 2, and then main memory for the named backup object.

A library object must be detached before it can be purged from the *HOME* directory.

Neither a library object nor a backup object can be purged if it is currently “referenced” internally by stack pointers (such as an object on the stack, in a local variable, on the LAST stack, or on an internal return stack). This produces the error Object in Use. To avoid these restrictions, use NEWOB before purging. (See NEWOB.)

Access:  PRG MEMORY PURGE (PRG is the left-shift of the  key).
 PURGE

Input/Output:

| Level 1/Argument 1 | Level 1/Item 1 |
|--|----------------|
| <i>'global'</i> | → |
| { <i>global₁ ... global_n</i> } | → |
| <i>PICT</i> | → |
| $:n_{\text{port}} :name_{\text{backup}}$ | → |
| $:n_{\text{port}} :library$ | → |

See also: CLEAR, CLVAR, NEWOB, PGDIR

PUSH

Type: Command

Description: Saves the current status of the flags, and the current directory path. This allows the user to change the flags or the directory path, then restore them all with the command POP. PUSH is equivalent to saving the results of the commands RCLF and PATH, but it saves them in a stack from which the most recently saved values are recovered by POP, with no need to use named variables. The flags and the path are stored in the CASDIR directory, as a list of lists, in the variable ENVSTACK.

Access:  CAT PUSH

Input: None.

Output: Item 1: In Algebraic mode the command returns NOVAL.

See also: POP

PUT

Type: Command

Description: Put Element Command: Replaces the object at a specified position (second input) in a specified array or list (first input) with a specified object (third input). If the array or list is unnamed, returns the new array or list.

For matrices, n_{position} counts in row order.

Access: \leftarrow PRG LIST ELEMENTS PUT (\leftarrow PRG is the left-shift of the EVAL key).

Input/Output:

| Level 3/Argument 1 | Level 2/Argument 2 | Level 1/Argument 3 | Level 1/Item 1 |
|---------------------------|---|--------------------------|--|
| $[[\text{matrix}]]_1$ | n_{position} | \tilde{x}_{put} | \rightarrow $[[\text{matrix}]]_2$ |
| $[[\text{matrix}]]_1$ | $\{ n_{\text{row}} \ m_{\text{col}} \}$ | \tilde{x}_{put} | \rightarrow $[[\text{matrix}]]_2$ |
| 'name _{matrix} ' | n_{position} | \tilde{x}_{put} | \rightarrow |
| 'name _{matrix} ' | $\{ n_{\text{row}} \ m_{\text{col}} \}$ | \tilde{x}_{put} | \rightarrow |
| $[\text{vector}]_1$ | n_{position} | \tilde{x}_{put} | \rightarrow $[\text{vector}]_2$ |
| $[\text{vector}]_1$ | $\{ n_{\text{position}} \}$ | \tilde{x}_{put} | \rightarrow $[\text{vector}]_2$ |
| 'name _{vector} ' | n_{position} | \tilde{x}_{put} | \rightarrow |
| 'name _{vector} ' | $\{ n_{\text{position}} \}$ | \tilde{x}_{put} | \rightarrow |
| $\{ \text{list} \}_1$ | n_{position} | obj_{put} | \rightarrow $\{ \text{list} \}_2$ |
| $\{ \text{list} \}_1$ | $\{ n_{\text{position}} \}$ | obj_{put} | \rightarrow $\{ \text{list} \}_2$ |
| 'name _{list} ' | n_{position} | obj_{put} | \rightarrow |
| 'name _{list} ' | $\{ n_{\text{position}} \}$ | obj_{put} | \rightarrow |

See also: GET, GETI, PUTI

PUTI

Type: Command

Description: Put and Increment Index Command: Replaces the object at a specified position (second input) in a specified array or list (first input) with a specified object (third input), returning a new array or list together with the next position in the array or list.

For matrices, the position is incremented in row order.

Unlike PUT, PUTI returns a named array or list. This enables a subsequent execution of PUTI at the next position of a named array or list.

Access: \leftarrow PRG LIST ELEMENTS PUTI (\leftarrow PRG is the left-shift of the EVAL key).

Flags: Index Wrap Indicator (-64)

Input/Output:

| L_3/A_1 | L_2/A_2 | L_1/A_3 | | L_2/I_1 | L_1/I_2 |
|---------------------------|-------------------------|---------------------|---|---------------------------|-------------------------|
| $[[matrix]]_1$ | $n_{position1}$ | \mathcal{X}_{put} | → | $[[matrix]]_2$ | $n_{position2}$ |
| $[[matrix]]_1$ | $\{n_{row} m_{col}\}_1$ | \mathcal{X}_{put} | → | $[[matrix]]_2$ | $\{n_{row} m_{col}\}_2$ |
| 'name _{matrix} ' | $n_{position1}$ | \mathcal{X}_{put} | → | 'name _{matrix} ' | $n_{position2}$ |
| 'name _{matrix} ' | $\{n_{row} m_{col}\}_1$ | \mathcal{X}_{put} | → | 'name _{matrix} ' | $\{n_{row} m_{col}\}_2$ |
| [vector] ₁ | $n_{position1}$ | \mathcal{X}_{put} | → | [vector] ₂ | $n_{position2}$ |
| [vector] ₁ | $\{n_{position1}\}$ | \mathcal{X}_{put} | → | [vector] ₂ | $\{n_{position2}\}$ |
| 'name _{vector} ' | $n_{position1}$ | \mathcal{X}_{put} | → | 'name _{vector} ' | $n_{position2}$ |
| 'name _{vector} ' | $\{n_{position1}\}$ | \mathcal{X}_{put} | → | 'name _{vector} ' | $\{n_{position2}\}$ |
| {list} ₁ | $n_{position1}$ | obj _{put} | → | {list} ₂ | $n_{position2}$ |
| {list} ₁ | $\{n_{position1}\}$ | obj _{put} | → | {list} ₂ | $\{n_{position2}\}$ |
| 'name _{list} ' | $n_{position1}$ | obj _{put} | → | 'name _{list} ' | $n_{position2}$ |
| 'name _{list} ' | $\{n_{position1}\}$ | obj _{put} | → | 'name _{list} ' | $\{n_{position2}\}$ |

L = Level; A = Argument; I = item

See also: GET, GETI, PUT

PVAR

Type: Command

Description: Population Variance Command: Calculates the population variance of the coordinate values in each of the m columns in the current statistics matrix (ΣDAT).

The population variance (equal to the square of the population standard deviation) is returned as a vector of m real numbers, or as a single real number if $m = 1$. The population variances are computed using this formula:

$$\frac{1}{n} \sum_{k=1}^n (x_k - \bar{x})^2$$

where x_k is the k th coordinate value in a column, \bar{x} is the mean of the data in this column, and n is the number of data points.

Access:  _CAT PVAR

Input/Output:

| Level 1/Argument 1 | | Level 1/Item 1 |
|--------------------|---|---|
| | → | $\mathcal{X}_{pvariance}$ |
| | → | $[\mathcal{X}_{pvariance1}, \dots, \mathcal{X}_{pvariancem}]$ |

See also: MEAN, PCOV, PSDEV, SDEV, VAR

PVARS

Type: Command

Description: Port-Variables Command: Returns a list of the backup objects ($:n_{port}:name$) and the library objects ($:n_{port}:n_{library}$) in the specified port. Also returns the available memory size (RAM).

The port number, n_{port} , must be in the range from 0 to 2.

If $n_{port} = 0$, then *memory* is bytes of available main RAM; otherwise *memory* is bytes of available RAM in the specified port.

Access:  _CAT PVARS

Input/Output:

| Level 1/Argument 1 | | Level 2/Item 1 | Level 1/Item 2 |
|--------------------|---|--------------------------------------|----------------|
| n_{port} | → | { : n_{port} : nam backup ... } | <i>memory</i> |
| n_{port} | → | { : n_{port} : $n_{library}$... } | <i>memory</i> |

See also: PVAR, VARS

PVIEW

Type: Command

Description: PICT View Command: Displays *PICT* with the specified coordinate at the upper left corner of the graphics display.

PICT must fill the entire display on execution of PVIEW. Thus, if a position other than the upper left corner of *PICT* is specified, *PICT* must be large enough to fill a rectangle that extends 131 pixels to the right and 80 pixels down on the hp49g+ (64 pixels down on the hp48gII).

If PVIEW is executed from a program with a coordinate argument (versus an empty list), the graphics display persists only until the keyboard is ready for input (for example, until the end of program execution). However, the FREEZE command freezes the display until a key is pressed.

If PVIEW is executed with an *empty* list argument, *PICT* is centred in the graphics display with scrolling mode activated. In this case, the graphics display persists until **CANCEL** is pressed.

PVIEW does *not* activate the graphics cursor or the Picture menu. To activate the graphics cursor and Picture menu, execute PICTURE.

Access: \leftarrow PRG \leftarrow PICT \leftarrow PVIEW (\leftarrow PRG is the left-shift of the \leftarrow EVAL key).
 \leftarrow PRG \leftarrow OUT PVIEW (\leftarrow PRG is the left-shift of the \leftarrow EVAL key).

Input/Output:

| Level 1/Argument 1 | | Level 1/Item 1 |
|--------------------|---|----------------|
| (x,y) | → | |
| { # n , # m } | → | |
| { } | → | |

See also: FREEZE, PICTURE, TEXT

PWRFIT

Type: Command

Description: Power Curve Fit Command: Stores PWRFIT as the fifth parameter in the reserved variable ΣPAR , indicating that subsequent executions of LR are to use the power curve fitting model. LINFIT is the default specification in ΣPAR .

Access: \leftarrow CAT PWRFIT

Input/Output: None

See also: BESTFIT, EXPFIT, LINFIT, LOGFIT, LR

PX→C

Type: Command

Description: Pixel to Complex Command: Converts the specified pixel coordinates to user-unit coordinates.

The user-unit coordinates are derived from the (x_{min}, y_{min}) and (x_{max}, y_{max}) parameters in the reserved variable *PPAR*. The coordinates correspond to the geometrical center of the pixel.

Access: \leftarrow PRG \leftarrow PICT \leftarrow PX→C (\leftarrow PRG is the left-shift of the \leftarrow EVAL key).

Input/Output:

| Level 1/Argument 1 | | Level 1/Item 1 |
|--------------------|---|----------------|
| { #n #m } | → | (x,y) |

See also: C→PX**→Q****Type:** Command**Description:** To Quotient Command: Returns a rational form of the argument.

The rational result is a “best guess”, since there might be more than one rational expression consistent with the argument. →Q finds a quotient of integers that agrees with the argument to within the number of decimal places specified by the display format mode.

→Q also acts on numbers that are part of algebraic expressions or equations.

Access: \leftarrow CONVERT REWRITE \leftarrow NXT →Q (CONVERT is the left-shift of the $\boxed{6}$ key).**Flags:** Number Display Format (-45 to -50)**Input/Output:**

| Level 1/Argument 1 | | Level 1/Item 1 |
|----------------------|---|----------------------|
| x | → | 'a/b' |
| (x,y) | → | 'a/b + c/d*i' |
| 'symb ₁ ' | → | 'symb ₂ ' |

See also: →Qπ, /**→Qπ****Type:** Command**Description:** To Quotient Times π Command: Returns a rational form of the argument, *or* a rational form of the argument with π, square roots, natural logs, and exponentials factored out, whichever yields the smaller denominator.

The rational result is a “best guess”, since there might be more than one rational expression consistent with the argument. →Qπ finds a quotient of integers that agrees with the argument to the number of decimal places specified by the display format mode.

→Qπ also acts on numbers that are part of algebraic expressions or equations.

For a complex argument, the real or imaginary part (or both) can have π as a factor.

Access: \leftarrow CONVERT REWRITE \leftarrow NXT →Qπ (CONVERT is the left-shift of the $\boxed{6}$ key).**Flags:** Number Display Format (-45 to -50)**Input/Output:**

| Level 1/Argument 1 | | Level 1/Item 1 |
|----------------------|---|----------------------|
| x | → | 'a/b*π' |
| x | → | 'a/b' |
| 'symb ₁ ' | → | 'symb ₂ ' |
| (x,y) | → | 'a/b*π + c/d*π*i' |
| (x,y) | → | 'a/b + c/d*i' |

See also: →Q, /, π**qr****Type:** Command**Description:** qr Factorization of a square Matrix Command: Returns the qr factorization of an $n \times n$ matrix.

qr factors an $n \times n$ matrix A into two matrices:

- Q is an $n \times m$ orthogonal matrix.
- R is an $n \times n$ triangular matrix.

Where $A = Q \times R$.

Access: \leftarrow MATRICES FACTORIZATION qr ($\overline{\text{MATRICES}}$ is the left-shift of the $\boxed{5}$ key).

Input/Output:

| Level 1/Argument 1 | Level 2/Item 1 | Level 1/Item 2 |
|--------------------------|----------------|--------------------------|
| $[[\text{matrix}]]_A$ | \rightarrow | $[[\text{matrix}]]_R$ |

See also: LQ, LSQ

QR

Type: Command

Description: QR Factorization of a Matrix Command: Returns the QR factorization of an $m \times n$ matrix.

QR factors an $m \times n$ matrix A into three matrices:

- Q is an $m \times m$ orthogonal matrix.
- R is an $m \times n$ upper trapezoidal matrix.
- P is a $n \times n$ permutation matrix.

Where $A \times P = Q \times R$.

Access: \leftarrow MATRICES FACTORIZATION QR ($\overline{\text{MATRICES}}$ is the left-shift of the $\boxed{5}$ key).

\leftarrow MTH MATRIX FACTORS QR ($\overline{\text{MTH}}$ is the left-shift of the $\boxed{\text{SYMB}}$ key).

Input/Output:

| Level 1/Argument 1 | Level 3/Item 1 | Level 2/Item 2 | Level 1/Item 3 |
|--------------------------|----------------|--------------------------|--------------------------|
| $[[\text{matrix}]]_A$ | \rightarrow | $[[\text{matrix}]]_R$ | $[[\text{matrix}]]_P$ |

See also: LQ, LSQ

QUAD

Type: Command

Description: Solve Quadratic Equation Command: This command is identical to the computer algebra command SOLVE, and is included for backward compatibility with the HP 48G.

Access: \rightarrow CAT QUAD

Flags: Principal Solution (-1)

Input/Output:

| Level 2/Argument 1 | Level 1/Argument 2 | Level 1/Item 1 |
|----------------------|--------------------|------------------------------------|
| 'symb ₁ ' | 'global' | \rightarrow 'symb ₂ ' |

See also: COLCT, EXPAN, ISOL, SHOW, SOLVE

QUOT

CAS: Return the quotient part of the Euclidean division of two polynomials.

QUOTE

Type: Function

Description: Quote Argument Function: Returns its argument unevaluated.

When an algebraic expression is evaluated, the arguments to a function in the expression are evaluated before the function. For example, when SIN(X) is evaluated, the name X is evaluated first, and the result is placed on the stack as the argument for SIN.

This process creates a problem for functions that require symbolic arguments. For example, the integration function requires as one of its arguments a name specifying the variable of

integration. If evaluating an integral expression caused the name to be evaluated, the result of evaluation would be left on the stack for the integral, rather than the name itself. To avoid this problem, the hp49g+/48gII automatically (and invisibly) quotes such arguments. When the quoted argument is evaluated, the unquoted argument is returned.

If a user-defined function takes symbolic arguments, quote the arguments using QUOTE.

Access: $\boxed{\rightarrow}$ $\boxed{\text{CAT}}$ QUOTE

Input/Output:

| Level 1/Argument 1 | Level 1/Item 1 |
|--------------------|----------------|
| obj | obj |

See also: APPLY, | (Where)

QXA

CAS: Express a quadratic form in matrix form.

RAD

Type: Command

Description: Radians Mode Command: Sets Radians angle mode.

RAD sets flag -17 and clears flag -18, and displays the RAD annunciator.

In Radians angle mode, real-number arguments that represent angles are interpreted as radians, and real-number results that represent angles are expressed in radians.

Access: $\boxed{\leftarrow}$ & $\boxed{\text{MODE}}$ ANGLE RAD

$\boxed{\leftarrow}$ $\boxed{\text{PRG}}$ $\boxed{\text{NXT}}$ MODES ANGLE RAD ($\boxed{\text{PRG}}$ is the left-shift of the $\boxed{\text{EVAL}}$ key).

Input/Output: None

See also: DEG, GRAD

RAND

Type: Command

Description: Random Number Command: Returns a pseudo-random number generated using a seed value, and updates the seed value.

The hp49g+/hp48gII uses a linear congruential method and a seed value to generate a random number x_{random} in the range $0 \leq x < 1$. Each succeeding execution of RAND returns a value computed from a seed value based upon the previous RAND value. (Use RDZ to change the seed.)

Access: $\boxed{\leftarrow}$ $\boxed{\text{MTH}}$ $\boxed{\text{NXT}}$ PROBABILITY RAND ($\boxed{\text{MTH}}$ is the left-shift of the $\boxed{\text{SYMB}}$ key).

Input/Output:

| Level 1/Argument 1 | Level 1/Item 1 |
|--------------------|---------------------|
| | x_{random} |

See also: COMB, PERM RDZ, !

RANK

Type: Command

Description: Matrix Rank Command: Returns the rank of a rectangular matrix.

Rank is computed by calculating the singular values of the matrix and counting the number of non-negligible values. If all computed singular values are zero, RANK returns zero. Otherwise RANK consults flag -54 as follows:

- If flag -54 is clear (the default), RANK counts all computed singular values that are less than or equal to $1.E-14$ times the largest computed singular value.
- If flag -54 is set, RANK counts all nonzero computed singular values.

Access: \leftarrow MATRICES OPERATIONS \leftarrow NXT RANK (MATRICES is the left-shift of the 5 key).
 \leftarrow MTH MATRIX NORMALIZE \leftarrow NXT RANK (MTH is the left-shift of the SYMB key).

Flags: Singular Value (-54)

Input/Output:

| Level 1/Argument 1 | | Level 1/Item 1 |
|-----------------------|---------------|----------------|
| $[[\text{matrix}]]$ | \rightarrow | N_{rank} |

See also: LQ, LSQ, QR

RANM

Type: Command

Description: Random Matrix Command: Returns a matrix of specified dimensions that contains random integers in the range -9 through 9.

The probability of a particular nonzero digit occurring is 0.05; the probability of 0 occurring is 0.1.

Access: \leftarrow MATRICES CREATE \leftarrow NXT \leftarrow NXT RANM (MATRICES is the left-shift of the 5 key).
 \leftarrow MTH MATRIX MAKE RANM (MTH is the left-shift of the SYMB key).

Input/Output:

| Level 1/Argument 1 | | Level 1/Item 1 |
|------------------------------------|---------------|---|
| { m n } | \rightarrow | $[[\text{random matrix}]]_{m \times n}$ |
| $[[\text{matrix}]]_{m \times n}$ | \rightarrow | $[[\text{random matrix}]]_{m \times n}$ |

See also: RAND, RDZ

RATIO

Type: Function

Description: Prefix Divide Function: Prefix form of / (divide).

RATIO is identical to / (divide), except that, in algebraic syntax, RATIO is a *prefix* function, while / is an *infix* function. For example, RATIO(A,2) is equivalent to A/2.

Access: \leftarrow CAT RATIO

Input/Output:

| Level 2/Argument 1 | Level 1/Argument 2 | | Level 1/Item 1 |
|----------------------|----------------------|---------------|--|
| z_1 | z_2 | \rightarrow | z_1/z_2 |
| [array] | { [matrix] } | \rightarrow | $[[\text{array} \times \text{matrix}^{-1}]]$ |
| [array] | z | \rightarrow | [array/z] |
| z | 'symb' | \rightarrow | 'z/symb' |
| 'symb' | z | \rightarrow | 'symb/z' |
| 'symb ₁ ' | 'symb ₂ ' | \rightarrow | 'symb ₁ /symb ₂ ' |
| #n ₁ | n ₂ | \rightarrow | #n ₃ |
| n ₁ | #n ₂ | \rightarrow | #n ₃ |
| #n ₁ | #n ₂ | \rightarrow | #n ₃ |
| x_unit ₁ | y_unit ₂ | \rightarrow | (x/y)_unit ₁ /unit ₂ |
| x | y_unit | \rightarrow | (x/y)_1/unit |
| x_unit | y | \rightarrow | (x/y)_unit |
| 'symb' | x_unit | \rightarrow | 'symb/x_unit' |
| x_unit | 'symb' | \rightarrow | 'x_unit/symb' |

See also: /

RCEQ

Type: Command

Description: Recall from EQ Command: Returns the unevaluated contents of the reserved variable EQ from the current directory.

To recall the contents of EQ from a parent directory (when EQ doesn't exist in the current directory) evaluate the name EQ .

Access: $\boxed{\rightarrow}$ $\underline{\text{CAT}}$ RCEQ (or $\boxed{\rightarrow}$ EQ after pressing $\boxed{\text{VAR}}$)

Input/Output:

| Level 1/Argument 1 | Level 1/Item 1 |
|--------------------|---------------------------------|
| | \rightarrow obj_{EQ} |

See also: STEQ

RCI

Type: Command

Description: Multiply Row by Constant Command: Multiplies row n of a matrix (or element n of a vector) by a constant x_{factor} , and returns the modified matrix.

RCI rounds the row number to the nearest integer, and treats vector arguments as column vectors.

Access: $\boxed{\leftarrow}$ $\underline{\text{MATRICES}}$ CREATE ROW RCI ($\underline{\text{MATRICES}}$ is the left-shift of the $\boxed{5}$ key).

$\boxed{\leftarrow}$ $\underline{\text{MTH}}$ MATRIX ROW RCI ($\underline{\text{MTH}}$ is the left-shift of the $\boxed{\text{SYMB}}$ key).

Input/Output:

| Level 3/Argument 1 | Level 2/Argument 2 | Level 1/Argument 3 | Level 1/Item 1 |
|--------------------------|--------------------|-----------------------|--|
| $[[\text{matrix}]]_i$ | x_{factor} | $n_{row\ number}$ | \rightarrow $[[\text{matrix}]]_3$ |
| $[\text{vector}]_i$ | x_{factor} | $n_{element\ number}$ | \rightarrow $[\text{vector}]_2$ |

See also: RCIJ

RCIJ

Type: Command

Description: Add Multiplied Row Command: Multiplies row i of a matrix by a constant x_{factor} , adds this product to row j of the matrix, and returns the modified matrix; or multiplies element i of a vector by a constant x_{factor} , adds this product to element j of the vector, and returns the modified vector. RCIJ rounds the row numbers to the nearest integer, and treats vector arguments as column vectors.

Access: $\boxed{\leftarrow}$ $\underline{\text{MATRICES}}$ CREATE ROW RCIJ ($\underline{\text{MATRICES}}$ is the left-shift of the $\boxed{5}$ key).

$\boxed{\leftarrow}$ $\underline{\text{MTH}}$ MATRIX ROW RCIJ ($\underline{\text{MTH}}$ is the left-shift of the $\boxed{\text{SYMB}}$ key).

Input/Output:

| Level 4/Argument 1 | Level 3/Argument 2 | Level 2/Argument 3 | Level 1/Argument 4 | Level 1/Item 1 |
|--------------------------|--------------------|--------------------|--------------------|--|
| $[[\text{matrix}]]_i$ | x_{factor} | $n_{row\ i}$ | $n_{row\ j}$ | \rightarrow $[[\text{matrix}]]_2$ |
| $[\text{vector}]_i$ | x_{factor} | $n_{element\ i}$ | $n_{element\ j}$ | \rightarrow $[\text{vector}]_2$ |

See also: RCI

RCL

Type: Command Operation

Description: Recall Command: Returns the unevaluated contents of a specified variable.

RCL searches the entire current path, starting with the current directory. To search a different path, specify $\{ \text{path name} \}$, where path is the new path to the variable name . The path subdirectory does not become the current subdirectory (unlike EVAL).

To recall a library or backup object, tag the library number or backup name with the appropriate port number (n_{port}), which must be an integer in the range 0 to 3. Recalling a backup object brings a copy of its *contents* to the stack, not the entire backup object.

To search for a backup object, replace the port number with the wildcard character &, in which case the hp49g+/hp48gII will search (in order) ports 0 through 3, and the main memory for the named backup object.

You can specify a port (that is, n_{port}) in one of two ways:

- H, 0, 1, 2, or 3
- H, R, E, F, or SD

In each case, the ports are home, RAM, extended RAM, flash memory, and the plug-in SD card slot, respectively.

Access: \leftarrow RCL (RCL is the left-shift of the \leftarrow key).

Input/Output:

| Level 1/Argument 1 | | Level 1/Item 1 |
|--------------------------------------|---|----------------|
| 'obj' | → | obj |
| PICT | → | grob |
| . n_{port} . $n_{library}$ | → | obj |
| . n_{port} .name _{backup} | → | obj |
| . n_{port} .{ path } | → | obj |

See also: STO

RCLALARM

Type: Command

Description: Recall Alarm Command: Recalls a specified alarm.

obj_{action} is the alarm execution action. If an execution action was not specified, obj_{action} defaults to an empty string.

x_{repeat} is the repeat interval in clock ticks, where 1 clock tick equals 1/8192 second. If a repeat interval was not specified, the default is 0.

Access: \rightarrow TIME Tools ALRM RCLALARM (\rightarrow TIME is the right-shift of the \leftarrow key).

\rightarrow & 9 ALRM RCLALARM

\leftarrow PRG \leftarrow NXT \leftarrow NXT TIME ALRM RCLALARM (\leftarrow PRG is the left-shift of the \leftarrow key).

Input/Output:

| Level 1/Argument 1 | | Level 1/Item 1 |
|--------------------|---|---|
| n_{index} | → | { date time obj_{action} x_{repeat} } |

See also: DELALARM, FINDALARM, STOALARM

RCLF

Type: Command

Description: Recall Flags Command: Returns a list of integers representing the states of the system and user flags, respectively.

A bit with value 1 indicates that the corresponding flag is set; a bit with value 0 indicates that the corresponding flag is clear. The rightmost (least significant) bit of $\#n_{system}$ and $\#n_{user}$ indicate the states of system flag -1 and user flag +1, respectively.

Used with STOF, RCLF lets a program that alters the state of a flag or flags during program execution preserve the pre-program-execution flag status.

Access: \leftarrow &MODE FLAG \leftarrow NXT RCLF
 \leftarrow PRG \leftarrow NXT MODES FLAG \leftarrow NXT RCLF (\leftarrow PRG is the left-shift of the \leftarrow EVAL key).

Flags: Binary Integer Wordsize (-5 through -10)

Input/Output:

| Level 1/Argument 1 | Level 1/Item 1 |
|--------------------|---|
| | → { #n _{system} #n _{user} #n _{system2} #n _{user2} } |

See also: STOF

RCLKEYS

Type: Command

Description: Recall Key Assignments Command: Returns the current user key assignments. This includes an S if the standard definitions are active (not suppressed) for those keys without user key assignments.

The argument x_{key} is a real number of the form $n.p$ specifying the key by its row number r , its column number c , and its plane (shift) p . (For a definition of plane, see the entry for ASN.)

Access: \leftarrow &MODE KEYS RCLKEYS
 \leftarrow PRG \leftarrow NXT MODES KEYS RCLKEYS (\leftarrow PRG is the left-shift of the \leftarrow EVAL key).

Flags: User-Mode Lock (-61) and User Mode (-62) affect the status of the user keyboard

Input/Output:

| Level 1/Argument 1 | Level 1/Item 1 |
|--------------------|---|
| | → { obj _{r, x_{key} 1} , ... ,obj _{r, x_{key} n} } |
| | → { S, obj _{r, x_{key} 1} , ... obj _{r, x_{key} n} } |

See also: ASN, DELKEYS, STOKEYS

RCLMENU

Type: Command

Description: Recall Menu Number Command: Returns the menu number of the currently displayed menu.

x_{menu} has the form $mm.pp$, where mm is the menu number and pp is the page of the menu.

Executing RCLMENU when the current menu is a user-defined menu (build by TMENU) returns 0.01 (in 2 Fix mode), indicating “Last menu”.

Access: \leftarrow &MODE MENU RCLMENU
 \leftarrow PRG \leftarrow NXT MODES MENU RCLMENU (\leftarrow PRG is the left-shift of the \leftarrow EVAL key).

Input/Output:

| Level 1/Argument 1 | Level 1/Item 1 |
|--------------------|----------------|
| | → x_{menu} |

See also: MENU, TMENU

RCLVX

CAS: Return the name stored in the current CAS variable.

RCLΣ

Type: Command

Description: Recall Sigma Command: Returns the current statistical matrix (the contents of reserved variable ΣDAT) from the current directory.

To recall ΣDAT from the parent directory (when ΣDAT doesn't exist in the current directory), evaluate the name ΣDAT.

Access: $\boxed{\rightarrow}$ CAT RCL Σ (or $\boxed{\rightarrow}$ Σ DAT after pressing $\boxed{\text{VAR}}$)

Input/Output:

| Level 1/Argument 1 | Level 1/Item 1 |
|--------------------|----------------|
| | obj |

See also: CL Σ , STO Σ , $\Sigma+$, $\Sigma-$

RCWS

Type: Command

Description: Recall Wordsize Command: Returns the current wordsize in bits (1 through 64).

Access: $\boxed{\rightarrow}$ BASE $\boxed{\text{NXT}}$ RCWS (BASE is the right-shift of the $\boxed{3}$ key).

Flags: Binary Integer Wordsize (-5 through -10), Binary Integer Base (-11, -12)

Input/Output:

| Level 1/Argument 1 | Level 1/Item 1 |
|--------------------|----------------|
| | n |

See also: BIN, DEC, HEX, OCT, STWS

RDM

Type: Command

Description: Redimension Array Command: Rearranges the elements of the argument according to specified dimensions.

If the list contains a single number n_{elements} , the result is an n -element vector. If the list contains two numbers n_{rows} and m_{cols} , the result is an $n \times m$ matrix.

Elements taken from the argument vector or matrix preserve the same row order in the resulting vector or matrix. If the result is dimensioned to contain fewer elements than the argument vector or matrix, excess elements from the argument vector or matrix at the end of the row order are discarded. If the result is dimensioned to contain more elements than the argument vector or matrix, the additional elements in the result at the end of the row order are filled with zeros.

If the argument vector or matrix is specified by *global*, the result replaces the argument as the contents of the variable.

Access: $\boxed{\leftarrow}$ MATRICES CREATE $\boxed{\text{NXT}}$ $\boxed{\text{NXT}}$ RDM (MATRICES is the left-shift of the $\boxed{5}$ key).

$\boxed{\leftarrow}$ MTH MATRIX MAKE RDM (MTH is the left-shift of the $\boxed{\text{SYMB}}$ key).

Input/Output:

| Level 2/Argument 1 | Level 1/Argument 2 | Level 1/Item 1 |
|--------------------------|--|--------------------------|
| $[\text{vector}]_1$ | $\{ n_{\text{elements}} \}$ | $[\text{vector}]_2$ |
| $[\text{vector}]$ | $\{ n_{\text{rows}}, m_{\text{cols}} \}$ | $[[\text{matrix}]]$ |
| $[[\text{matrix}]]$ | $\{ n_{\text{elements}} \}$ | $[\text{vector}]$ |
| $[[\text{matrix}]]_1$ | $\{ n_{\text{rows}}, m_{\text{cols}} \}$ | $[[\text{matrix}]]_2$ |
| 'global' | $\{ n_{\text{elements}} \}$ | |
| 'global' | $\{ n_{\text{rows}}, m_{\text{cols}} \}$ | |

See also: TRN

RDZ

Type: Command

Description: Randomize Command: Uses a real number x_{seed} as a seed for the RAND command.

If the argument is 0, a random value based on the system clock is used as the seed.

Access: \leftarrow MTH \rightarrow PROBABILITY RDZ (\leftarrow MTH is the left-shift of the \rightarrow key).

Input/Output:

| Level 1/Argument 1 | Level 1/Item 1 |
|--------------------|----------------|
| x_{real} | \rightarrow |

See also: COMB, PERM, RAND, !

RE

Type: Function

Description: Real Part Function: Returns the real part of the argument.

If the argument is a vector or matrix, RE returns a real array, the elements of which are equal to the real parts of the corresponding elements of the argument array.

Access: \rightarrow CmplX \rightarrow RE (\rightarrow CmplX is the right-shift of the \rightarrow key).

Flags: Numerical Results (-3)

Input/Output:

| Level 1/Argument 1 | Level 1/Item 1 |
|--------------------|---------------------------|
| x | \rightarrow x |
| x_unit | \rightarrow x |
| (x,y) | \rightarrow x |
| [R-array] | \rightarrow [R-array] |
| [C-array] | \rightarrow [R-array] |
| 'symb' | \rightarrow 'RE(symb)' |

See also: C \rightarrow R, IM, R \rightarrow C

RECN

Type: Command

Description: Receive Renamed Object Command: Prepares the hp49g+/hp48gII to receive a file from another Kermit server device, and to store the file in a specified variable.

RECN is identical to RECV except that the name under which the received data is stored is specified.

Access: \rightarrow CAT RECN

Flags: I/O Device flag (-33), I/O Data Format (-35), RECV Overwrite (-36), I/O Messages (-39)

Input/Output:

| Level 1/Argument 1 | Level 1/Item 1 |
|--------------------|----------------|
| 'name' | \rightarrow |
| "name" | \rightarrow |

See also: BAUD, CKSM, CLOSEIO, FINISH, KERRM, KGET, PARITY, RECV, SEND, SERVER, TRANSIO

RECT

Type: Command

Description: Rectangular Mode Command: Sets Rectangular coordinate mode.

RECT clears flags -15 and -16.

In Rectangular mode, vectors are displayed as rectangular components. Therefore, a 3D vector would appear as [X Y Z].

Access: $\boxed{\leftarrow}$ &MODE ANGLE RECT
 $\boxed{\leftarrow}$ MTH VECTOR $\boxed{\text{NXT}}$ RECT (MTH is the left-shift of the $\boxed{\text{SYMB}}$ key).
 $\boxed{\leftarrow}$ PRG $\boxed{\text{NXT}}$ MODES ANGLE RECT (PRG is the left-shift of the $\boxed{\text{EVAL}}$ key).

Input/Output: None

See also: CYLIN, SPHERE

RECV

Type: Command

Description: Receive Object Command: Instructs the hp49g+/hp48gII to look for a named file from another Kermit server device. The received file is stored in a variable named by the sender.

Since the hp49g+/hp48gII does not normally look for incoming Kermit files, you must use RECV to tell it to do so.

Access: $\boxed{\rightarrow}$ CAT RECV

Flags: I/O Device flag (-33), I/O Data Format (-35), RECV Overwrite (-36), I/O Messages (-39)

Input/Output: None

See also: BAUD, CKSM, FINISH, KGET, PARITY, RECIN, SEND, SERVER, TRANSIO

REF

CAS: Reduce a matrix to echelon form. This is a subdiagonal reduction (Gauss, not Gauss-Jordan).

REMAINDER

CAS: Return the remainder of the Euclidean division of two polynomials.

RENAME

Type: Command

Description: Rename Object Command: Renames an object to the name that you specify.

Access: $\boxed{\rightarrow}$ CAT RENAME

Input/Output:

| Level 2/Argument 1 | Level 1/Argument 2 | Level 1/Item 1 |
|--------------------|--------------------|----------------|
| <i>new 'name'</i> | <i>old 'name'</i> | → |

See also: COPY

REORDER

CAS: Rewrite a polynomial expression in increasing or decreasing order of powers.

REPEAT

Type: Command

Description: REPEAT Command: Starts loop clause in WHILE ... REPEAT ... END indefinite loop structure.

See the WHILE entry for more information.

Access: $\boxed{\leftarrow}$ PRG BRANCH WHILE REPEAT (PRG is the left-shift of the $\boxed{\text{EVAL}}$ key).

Input/Output: None

See also: END, WHILE

REPL

Type: Command

Description: Replace Command: Replaces a portion of the target object (first input) with a specified object (third input), beginning at a specified position (second input).

For arrays, n_{position} counts in row order. For matrices, n_{position} specifies the new location of the upper left-hand element of the replacement matrix.

For graphics objects, the upper left corner of $grob_1$ is positioned at the user-unit or pixel coordinates (x,y) or $\{ \#n \#m \}$. From there, it overwrites a rectangular portion of $grob_{\text{target}}$ or *PICT*. If $grob_1$ extends past $grob_{\text{target}}$ or *PICT* in either direction, it is truncated in that direction. If the specified coordinate is not on the target graphics object, the target graphics object does not change.

Access:  **PRG** LIST REPL (**PRG** is the left-shift of the  key).

Input/Output:

| Level 3/Argument 1 | Level 2/Argument 2 | Level 1/Argument 3 | | Level 1/Item 1 |
|-------------------------------------|---|--------------------------|---|-------------------------------------|
| $[[\text{matrix}]]_1$ | n_{position} | $[[\text{matrix}]]_2$ | → | $[[\text{matrix}]]_3$ |
| $[[\text{matrix}]]_1$ | $\{ n_{\text{row}}, n_{\text{column}} \}$ | $[[\text{matrix}]]_2$ | → | $[[\text{matrix}]]_3$ |
| $[\text{vector}]_1$ | n_{position} | $[\text{vector}]_2$ | → | $[\text{vector}]_3$ |
| $\{ \text{list}_{\text{target}} \}$ | n_{position} | $\{ \text{list}_1 \}$ | → | $\{ \text{list}_{\text{result}} \}$ |
| "string _{target} " | n_{position} | "string ₁ " | → | "string _{result} " |
| $grob_{\text{target}}$ | $(\#n, \#m)$ | $grob_1$ | → | $grob_{\text{result}}$ |
| $grob_{\text{target}}$ | (x,y) | $grob_1$ | → | $grob_{\text{result}}$ |
| PICT | $(\#n, \#m)$ | $grob_1$ | → | |
| PICT | (x,y) | $grob_1$ | → | |

See also: CHR, GOR, GXOR, NUM, POS, SIZE, SUB

RES

Type: Command

Description: Resolution Command: Specifies the resolution of mathematical and statistical plots, where the resolution is the interval between values of the independent variable used to generate the plot. A real number n_{interval} specifies the interval in user units. A binary integer $\#n_{\text{interval}}$ specifies the interval in pixels.

The resolution is stored as the fourth item in *PPAR*, with default value 0. The interpretation of the default value is summarized in the following table.

| Plot Type | Default Interval |
|------------|--|
| BAR | 10 pixels (bar width = 10 pixel columns) |
| DIFFEQ | unlimited: step size is not constrained |
| FUNCTION | 2 pixels (plots a point in every other column of pixels) |
| CONIC | 2 pixels (plots a point in every other column of pixels) |
| TRUTH | 2 pixels (plots a point in every other column of pixels) |
| GRIDMAP | RES does not apply |
| HISTOGRAM | 10 pixels (bin width = 10 pixel columns) |
| PARAMETRIC | [independent variable range in user units]/130 |
| PARSURFACE | RES does not apply |

| Plot Type | Default Interval |
|------------|--|
| PCONTOUR | RES does not apply |
| POLAR | 2°, 2 grads, or $\pi/90$ radians |
| SCATTER | RES does not apply |
| SLOPEFIELD | RES does not apply |
| WIREFRAME | RES does not apply |
| YSLICE | 2 pixels (plots a point in every other column of pixels) |

Access: \leftarrow CAT RES

Input/Output:

| Level 1/Argument 1 | Level 1/Item 1 |
|--------------------|----------------|
| $n_{interval}$ | → |
| $\#n_{interval}$ | → |

See also: BAR, CONIC, DIFFEQ, FUNCTION, GRIDMAP, HISTOGRAM, PARAMETRIC, PARSURFACE, PCONTOUR, POLAR, SCATTER, SLOPEFIELD, TRUTH, WIREFRAME, YSLICE

RESTORE

Type: Command

Description: Restore HOME Command: Replaces the current *HOME* directory with the specified backup copy ($:n_{port}:name_{backup}$) previously created by ARCHIVE.

The specified port number must be in the range 0 to 3.

To restore a *HOME* directory that was saved on a remote system using $:IO:name$ ARCHIVE, put the backup object itself on the stack, execute RESTORE and then execute a warm start.

Access: \leftarrow PRG MEM (NXT) RESTORE (PRG is the left-shift of the (EVAL) key).

Input/Output:

| Level 1/Argument 1 | Level 1/Item 1 |
|----------------------------|----------------|
| $.n_{port} .name_{backup}$ | → |
| backup | → |

See also: ARCHIVE

RESULTANT

CAS: Return the resultant of two polynomials, that is, the determinant of their Sylvester matrix.

REVLIST

Type: Command

Description: Reverse List Command: Reverses the order of the elements in a list.

Access: \leftarrow PRG LIST PROCEDURES REVLIST (PRG is the left-shift of the (EVAL) key).

Input/Output:

| Level 1/Argument 1 | Level 1/Item 1 |
|-------------------------|---------------------------|
| { $obj_n \dots obj_1$ } | → { $obj_1 \dots obj_n$ } |

See also: SORT

REWRITE

CAS: Display a menu or list of CAS operations that rewrite expressions.

RISCH

CAS: Perform symbolic integration on a function using the Risch algorithm.

RKF

Type: Command

Description: Solve for Initial Values (Runge–Kutta–Fehlberg) Command: Computes the solution to an initial value problem for a differential equation, using the Runge-Kutta-Fehlberg (4,5) method.

RKF solves $y'(t) = f(t,y)$, where $y(t_0) = y_0$. The arguments and results are as follows:

- $\{ list \}$ contains three items in this order: the independent (t) and solution (y) variables, and the right-hand side of the differential equation (or a variable where the expression is stored).
- x_{tol} sets the absolute error tolerance. If a list is used, the first value is the absolute error tolerance and the second value is the initial candidate step size.
- x_{Tfinal} specifies the final value of the independent variable.

RKF repeatedly calls RKFSTEP as it steps from the initial value to x_{Tfinal} .

Access:  CAT RKF

Input/Output:

| L_3/A_1 | L_2/A_2 | L_1/A_3 | | L_2/I_1 | L_1/I_2 |
|-----------|--------------------------|--------------|---|-----------|-----------|
| { list } | x_{tol} | x_{Tfinal} | → | { list } | x_{tol} |
| { list } | { x_{tol} x_{step} } | x_{Tfinal} | → | { list } | x_{tol} |

L = Level; A = Argument; I = item

See also: RKFERR, RKFSTEP, RRK, RRKSTEP, RSBERR

RKFERR

Type: Command

Description: Error Estimate for Runge–Kutta–Fehlberg Method Command: Returns the absolute error estimate for a given step h when solving an initial value problem for a differential equation.

The arguments and results are as follows:

- $\{ list \}$ contains three items in this order: the independent (t) and solution (y) variables, and the right-hand side of the differential equation (or a variable where the expression is stored).
- h is a real number that specifies the step.
- y_{delta} displays the change in solution for the specified step.
- *error* displays the absolute error for that step. A zero error indicates that the Runge–Kutta–Fehlberg method failed and that Euler's method was used instead.

The absolute error is the absolute value of the estimated error for a scalar problem, and the row (infinity) norm of the estimated error vector for a vector problem. (The latter is a bound on the maximum error of any component of the solution.)

Access:  CAT RKFERR

Input/Output:

| L_2/A_1 | L_1/A_2 | | L_1/I_1 | L_3/I_2 | L_2/I_3 | L_1/I_4 |
|-----------|-----------|---|-----------|-----------|-------------|--------------|
| { list } | h | → | { list } | h | y_{delta} | <i>error</i> |

L = Level; A = Argument; I = item

See also: RKF, RKFSTEP, RRK, RRKSTEP, RSBERR

RKFSTEP

Type: Command

Description: Next Solution Step for RKF Command: Computes the next solution step (h_{next}) to an initial value problem for a differential equation.

The arguments and results are as follows:

- $\{ list \}$ contains three items in this order: the independent (t) and solution (y) variables, and the right-hand side of the differential equation (or a variable where the expression is stored).
- x_{tol} sets the tolerance value.
- h specifies the initial candidate step.
- h_{next} is the next candidate step.

The independent and solution variables must have values stored in them. RKFSTEP steps these variables to the next point upon completion.

Note that the actual step used by RKFSTEP will be less than the input value h if the global error tolerance is not satisfied by that value. If a stringent global error tolerance forces RKFSTEP to reduce its stepsize to the point that the Runge–Kutta–Fehlberg methods fails, then RKFSTEP will use the Euler method to compute the next solution step and will consider the error tolerance satisfied. The Runge-Kutta-Fehlberg method will fail if the current independent variable is zero and the stepsize $\leq 1.3 \times 10^{-498}$ or if the variable is nonzero and the stepsize is 1.3×10^{-10} times its magnitude.

Access:  CAT RKFS

Input/Output:

| | | | | | | |
|--------------|-----------|---------------|---------------|--------------|-----------|------------|
| L_3/A_1 | L_2/A_n | L_1/A_{n+1} | | L_3/I_1 | L_2/I_2 | L_1/I_3 |
| $\{ list \}$ | x_{tol} | h | \rightarrow | $\{ list \}$ | x_{tol} | h_{next} |

L = Level; A = Argument; I = item

See also: RKF, RKFERR, RRK, RRKSTEP, RSBERR

RL

Type: Command

Description: Rotate Left Command: Rotates a binary integer one bit to the left.

The leftmost bit of $\#n_1$ becomes the rightmost bit of $\#n_2$.

Access:  BASE BIT RL (BASE is the right-shift of the  key).

Flags: Binary Integer Wordsize (-5 through -10), Binary Integer Base (-11, -12)

Input/Output:

| | | |
|---------------------------|---------------|-----------------------|
| Level 1/Argument 1 | | Level 1/Item 1 |
| $\#n_1$ | \rightarrow | $\#n_2$ |

See also: RLB, RR, RRB

RLB

Type: Command

Description: Rotate Left Byte Command: Rotates a binary integer one byte to the left.

The leftmost byte of $\#n_1$ becomes the rightmost byte of $\#n_2$. RLB is equivalent to executing RL eight times.

Access:  BASE  BYTE RLB (BASE is the right-shift of the  key).

Flags: Binary Integer Wordsize (-5 through -10), Binary Integer Base (-11, -12)

Input/Output:

| | |
|---------------------------|-----------------------|
| Level 1/Argument 1 | Level 1/Item 1 |
| $\#n_1$ | \rightarrow $\#n_2$ |

See also: RL, RR, RRB

RND

Type: Function

Description: Round Function: Rounds an object to a specified number of decimal places or significant digits, or to fit the current display format.

n_{round} (or $symb_{round}$ if flag -3 is set) controls how the level 2 argument is rounded, as follows:

| n_{round} or $symb_{round}$ | Effect on Level 2 Argument |
|-------------------------------|--|
| 0 through 11 | Rounded to n decimal places. |
| -1 through -11 | Rounded to n significant digits. |
| 12 | Rounded to the current display format. |

For complex numbers and arrays, each real number element is rounded. For unit objects, the numerical part of the object is rounded.

Access: \leftarrow MTH REAL \leftarrow NXT \leftarrow RND (\leftarrow MTH is the left-shift of the \leftarrow SYMB key).

Flags: Numerical Results (-3)

Input/Output:

| Level 2/Argument 1 | Level 1/Argument 2 | Level 1/Item 1 |
|------------------------|--------------------------|--|
| z_1 | n_{round} | \rightarrow z_2 |
| z | 'symb _{round} ' | \rightarrow 'RND(symb _{round})' |
| 'symb' | n_{round} | \rightarrow 'RND(symb, n_{round})' |
| 'symb _i ' | 'symb _{round} ' | \rightarrow 'RND('symb _i , symb _{round})' |
| [array ₁] | n_{round} | \rightarrow [array ₂] |
| x_unit | n_{round} | \rightarrow y_unit |
| x_unit | 'symb _{round} ' | \rightarrow 'RND(x_unit, symb _{round})' |

See also: TRNC

RNRM

Type: Command

Description: Row Norm Command: Returns the row norm (infinity norm) of its argument array.

The row norm is the maximum (over all rows) of the sums of the absolute values of all elements in each row. For a vector, the row norm is the largest absolute value of any of its elements.

Access: \leftarrow MATRICES OPERATIONS \leftarrow NXT RNRM (\leftarrow MATRICES is the left-shift of the \leftarrow 5 key).

\leftarrow MTH MATRIX NORMALIZE RNRM (\leftarrow MTH is the left-shift of the \leftarrow SYMB key).

Input/Output:

| | |
|---------------------------|-------------------------------|
| Level 1/Argument 1 | Level 1/Item 1 |
| [array] | \rightarrow $x_{row\ norm}$ |

See also: CNRM, CROSS, DET, DOT

ROLL

Type: RPL command

Description: Roll Objects Command: Moves the contents of a specified level to level 1, and rolls upwards the portion of the stack beneath the specified level.

In RPN mode, 3 ROLL is equivalent to ROT.

Access: \leftarrow PRG STACK NXT ROLL (\leftarrow PRG is the left-shift of the EVAL key).

Input/Output:

| | | | | | |
|-----------------------------------|-------|---------------|--------------------------|----------------|----------------|
| $L_{n+1} \dots L_2$ | L_1 | | $L_n \dots$ | L_2 | L_1 |
| $\text{obj}_n \dots \text{obj}_1$ | n | \rightarrow | $\text{obj}_{n-1} \dots$ | obj_1 | obj_n |

L = Level

See also: OVER, PICK, ROLLD, ROT, SWAP

ROLLD

Type: RPL command

Description: Roll Down Command: Moves the contents of level 2 to a specified level, n , and rolls downward the portion of the stack beneath the specified level.

Access: \leftarrow PRG STACK NXT ROLLD (\leftarrow PRG is the left-shift of the EVAL key).

Input/Output:

| | | | | | |
|-----------------------------------|------------------------|---------------|----------------|----------------------|----------------|
| $L_{n+1} \dots L_2$ | L_1 | | L_n | $L_{n-1} \dots$ | L_1 |
| $\text{obj}_n \dots \text{obj}_2$ | n (obj_1) | \rightarrow | obj_1 | $\text{obj}_n \dots$ | obj_2 |

L = Level

See also: OVER, PICK, ROLL, ROT, SWAP

ROMUPLOAD

Description: This command remains from earlier HP graphing calculators and should not be used.

ROOT

Type: Command

Description: Root-Finder Command: Returns a real number x_{root} that is a value of the specified variable *global* for which the specified program or algebraic object most nearly evaluates to zero or a local extremum.

guess is an initial estimate of the solution. ROOT produces an error if it cannot find a solution, returning the message Bad Guess(es) if one or more of the guesses lie outside the domain of the equation, or returns the message Constant? if the equation returns the same value at every sample point. ROOT does *not* return interpretive messages when a root is found.

Access: \rightarrow CAT ROOT

Input/Output:

| Level 3/Argument 1 | Level 2/Argument 2 | Level 1/Argument 3 | | Level 1/Item 1 |
|--------------------|--------------------|--------------------|---------------|-------------------|
| «program» | 'global' | guess | \rightarrow | X_{root} |
| «program» | 'global' | { guesses } | \rightarrow | X_{root} |
| 'symb' | 'global' | guess | \rightarrow | X_{root} |
| 'symb' | 'global' | { guesses } | \rightarrow | X_{root} |

ROT

Type: RPL Command

Description: Rotate Objects Command: Rotates the first three objects on the stack, moving the object on level 3 to level 1.

In RPN mode, ROT is equivalent to 3 ROLL.

Access: \leftarrow PRG STACK ROT (PRG is the left-shift of the EVAL key).

Input/Output:

| | | | | | | |
|------------------|------------------|------------------|---|------------------|------------------|------------------|
| L ₃ | L ₂ | L ₁ | | L ₃ | L ₂ | L ₁ |
| obj ₃ | obj ₂ | obj ₁ | → | obj ₂ | obj ₁ | obj ₃ |

L = Level

See also: OVER, PICK, ROLL, ROLLD, SWAP, UNROT

ROW-

Type: Command

Description: Delete Row Command: Deletes row n of a matrix (or element n of a vector), and returns the modified matrix (or vector) and the deleted row (or element).

n_{row} or $n_{element}$ is rounded to the nearest integer.

Access: \leftarrow MATRICES CCREATE ROW ROW- (MATRICES is left-shift of the 5 key).

\leftarrow MTH MATRIX ROW ROW- (MTH is left-shift of the SYMB key).

Input/Output:

| Level 2/Argument 1 | Level 1/Argument 2 | | Level 2/Item 1 | Level 1/Item 2 |
|--------------------------|--------------------|---|--------------------------|-----------------------------------|
| $[[\text{matrix}]]_1$ | n_{row} | → | $[[\text{matrix}]]_2$ | $[\text{vector}]_{row}$ |
| $[\text{vector}]_1$ | $n_{element}$ | → | $[\text{vector}]_2$ | element _{n} |

See also: COL-, COL+, ROW+, RSWP

ROW+

Type: Command

Description: Insert Row Command: Inserts an array into a matrix (or one or more numbers into a vector) at the position indicated by n_{index} , and returns the modified matrix (or vector).

The inserted array must have the same number of columns as the target array.

n_{index} is rounded to the nearest integer. The original array is redimensioned to include the new columns or elements, and the elements at and below the insertion point are shifted down.

Access: \leftarrow MATRICES CCREATE ROW ROW+ (MATRICES is left-shift of the 5 key).

\leftarrow MTH MATRIX ROW ROW+ (MTH is left-shift of the SYMB key).

Input/Output:

| Level 3/Argument 1 | Level 2/Argument 2 | Level 1/Argument 3 | | Level 1/Item 1 |
|--------------------------|---------------------------|--------------------|---|--------------------------|
| $[[\text{matrix}]]_1$ | $[[\text{matrix}]]_2$ | n_{index} | → | $[[\text{matrix}]]_3$ |
| $[[\text{matrix}]]_1$ | $[\text{vector}]_{row}$ | n_{index} | → | $[[\text{matrix}]]_2$ |
| $[\text{vector}]_1$ | element | n_{index} | → | $[\text{vector}]_2$ |

See also: COL-, COL+, ROW-, RSWP

ROW→

Type: Command

Description: Rows to Matrix Command: Transforms a series of row vectors and a row count into a matrix containing those rows, or transforms a sequence of numbers and an element count into a vector with those numbers as elements.

Access: \leftarrow MATRICES CREATE ROW ROW \rightarrow (\leftarrow MATRICES is the left-shift of the **5** key).
 \leftarrow MTH MATRIX ROW ROW \rightarrow (\leftarrow MTH is the left-shift of the **SYMB** key).

Input/Output:

| $L_{n+1}/A_1 \dots$ | L_2/A_n | L_1/A_{n+1} | | Level 1/Item 1 |
|----------------------------------|----------------------------|----------------------|---------------|----------------------------|
| $[\text{vector}]_{row\ 1} \dots$ | $[\text{vector}]_{row\ n}$ | $n_{row\ count}$ | \rightarrow | $[[\text{matrix}]]$ |
| $element_1 \dots$ | $element_n$ | $n_{element\ count}$ | \rightarrow | $[\text{vector}]_{column}$ |

L = Level; A = Argument; I = item

See also: \rightarrow COL, COL \rightarrow , \rightarrow ROW

\rightarrow ROW

Type: Command

Description: Matrix to Rows Command: Transforms a matrix into a series of row vectors, returning the vectors and row count, or transforms a vector into its elements, returning the elements and element count.

Access: \leftarrow MATRICES CREATE ROW \rightarrow ROW (\leftarrow MATRICES is the left-shift of the **5** key).
 \leftarrow MTH MATRIX ROW \rightarrow ROW (\leftarrow MTH is the left-shift of the **SYMB** key).

Input/Output:

| $L_1/\text{Argument}_1$ | | $L_{n+1}/I_1 \dots L_2/I_n$ | | L_1/I_{n+1} |
|-------------------------|---------------|---|--|----------------------|
| $[[\text{matrix}]]$ | \rightarrow | $[\text{vector}]_{row\ n} \dots [\text{vector}]_{row\ 1}$ | | $n_{row\ count}$ |
| $[\text{vector}]$ | \rightarrow | $element_1 \dots element_n$ | | $n_{element\ count}$ |

L = Level; A = Argument; I = Item

See also: \rightarrow COL, COL \rightarrow , ROW \rightarrow

RPL>

Type: Command

Description: User RPL program function. This function allows for the entry and execution of User RPL programs while in algebraic mode. While RPL programs can be written in algebraic mode without the use of this function, some RPL constructs, such as FOR...NEXT loops, will produce an error message if not preceded by the RPL> function. As an algebraic function, it will be placed on the command line with a pair of parentheses attached, which must be removed before its use.

For example, to enter the user RPL program of $\ll 1\ 5\ + \gg$ in algebraic mode, choose the RPL> function from the catalog and press **ENTER**. Remove the parentheses by pressing **▶** **◀** **◀**. Then enter the program by pressing **▶** **◀◀** **1** **SPC** **5** **SPC** **+** **ENTER**. The program object will now be on the first command line. It can be evaluated by pressing **EVAL** **◀** **ANS** **ENTER**.

Access: \leftarrow CAT RPL>

Input/Output:

| Level 1/Argument 1 | | Level 1/Item 1 |
|--------------------|---------------|----------------|
| | \rightarrow | obj |

RR

Type: Command

Description: Rotate Right Command: Rotates a binary integer one bit to the right.

The rightmost bit of $\#n_1$ becomes the leftmost bit of $\#n_2$.

Access: \leftarrow BASE \leftarrow NXT BIT RR (\leftarrow BASE is the right-shift of the $\boxed{3}$ key).
 \leftarrow MTH \leftarrow BASE \leftarrow NXT BIT RR (\leftarrow MTH is the left-shift of the $\boxed{\text{SYMB}}$ key).
 \leftarrow CONVERT \leftarrow BASE \leftarrow NXT BIT RR (\leftarrow CONVERT is the left-shift of the $\boxed{6}$ key).

Flags: Binary Integer Wordsize (-5 through -10), Binary Integer Base (-11, -12)

Input/Output:

| Level 1/Argument 1 | | Level 1/Item 1 |
|--------------------|---------------|----------------|
| $\#n_1$ | \rightarrow | $\#n_2$ |

See also: RL, RLB, RRB

RRB

Type: Command

Description: Rotate Right Byte Command: Rotates a binary integer one byte to the right.

The rightmost byte of $\#n_1$ becomes the leftmost byte of $\#n_2$. RRB is equivalent to doing RR eight times.

Access: \leftarrow BASE \leftarrow NXT BYTE RRB (\leftarrow BASE is the right-shift of the $\boxed{3}$ key).
 \leftarrow MTH \leftarrow BASE \leftarrow NXT BYTE RRB (\leftarrow MTH is the left-shift of the $\boxed{\text{SYMB}}$ key).
 \leftarrow CONVERT \leftarrow BASE \leftarrow NXT BYTE RRB (\leftarrow CONVERT is the left-shift of the $\boxed{6}$ key).

Flags: Binary Integer Wordsize (-5 through -10), Binary Integer Base (-11, -12)

Input/Output:

| Level 1/Argument 1 | | Level 1/Item 1 |
|--------------------|---------------|----------------|
| $\#n_1$ | \rightarrow | $\#n_2$ |

See also: RL, RLB, RR

rref

CAS: Reduce a matrix to row-reduced echelon form, and provide a list of pivot points.

RREF

CAS: Reduce a matrix to row-reduced echelon form – the reduction is carried out completely, so a square matrix is reduced to an identity matrix. Step-by-step mode can be used to show how the reduction proceeds.

RREFMOD

CAS: Perform modular row-reduction to echelon form on a matrix, modulo the current modulus.

RRK

Type: Command

Description: Solve for Initial Values (Rosenbrock, Runge–Kutta) Command: Computes the solution to an initial value problem for a differential equation with known partial derivatives.

RRK solves $y'(t) = f(t,y)$, where $y(t_0) = y_0$. The arguments and results are as follows:

- $\{ list \}$ contains five items in this order:
 - The independent variable (t).
 - The solution variable (y).
 - The right-hand side of the differential equation (or a variable where the expression is stored).
 - The partial derivative of $y'(t)$ with respect to the solution variable (or a variable where the expression is stored).

- The partial derivative of $y'(t)$ with respect to the independent variable (or a variable where the expression is stored).
 - x_{tol} sets the tolerance value. If a list is used, the first value is the tolerance and the second value is the initial candidate step size.
 - x_{Tfinal} specifies the final value of the independent variable.
- RRK repeatedly calls RKFSTEP as its steps from the initial value to x_{Tfinal} .

Access:  CAT RRK

Input/Output:

| L_3/A_1 | L_2/A_2 | L_1/A_3 | | L_2/I_1 | L_1/I_2 |
|-----------|---------------------------|--------------|---|-----------|-----------|
| { list } | x_{tol} | x_{Tfinal} | → | { list } | x_{tol} |
| { list } | { x_{tol} x_{hstep} } | x_{Tfinal} | | { list } | x_{tol} |

L = Level; A = Argument; I = item

See also: RKF, RKFERR, RKFSTEP, RRKSTEP, RSBERR

RRKSTEP

Type: Command

Description: Next Solution Step and Method (RKF or RRK) Command: Computes the next solution step (h_{next}) to an initial value problem for a differential equation, and displays the method used to arrive at that result.

The arguments and results are as follows:

- { *list* } contains five items in this order:
 - The independent variable (t).
 - The solution variable (y).
 - The right-hand side of the differential equation (or a variable where the expression is stored).
 - The partial derivative of $y'(t)$ with respect to the solution variable (or a variable where the expression is stored).
 - The partial derivative of $y'(t)$ with respect to the independent variable (or a variable where the expression is stored).
- x_{tol} is the tolerance value.
- h specifies the initial candidate step.
- *last* specifies the last method used (RKF = 1, RRK = 2). If this is the first time you are using RRKSTEP, enter 0.
- *current* displays the current method used to arrive at the next step.
- h_{next} is the next candidate step.

The independent and solution variables must have values stored in them. RRKSTEP steps these variables to the next point upon completion.

Note that the actual step used by RRKSTEP will be less than the input value h if the global error tolerance is not satisfied by that value. If a stringent global error tolerance forces RRKSTEP to reduce its stepsize to the point that the Runge–Kutta–Fehlberg or Rosenbrock methods fails, then RRKSTEP will use the Euler method to compute the next solution step and will consider the error tolerance satisfied. The Rosenbrock method will fail if the current independent variable is zero and the stepsize $\leq 2.5 \times 10^{-499}$ or if the variable is nonzero and the stepsize is 2.5×10^{-11} times its magnitude. The Runge–Kutta–Fehlberg method will fail if the current independent variable is zero and the stepsize $\leq 1.3 \times 10^{-498}$ or if the variable is nonzero and the stepsize is 1.3×10^{-10} times its magnitude.

Access:  CAT RRKS

Input/Output:

| | | | | | | | |
|--------------------------------|--------------------------------|--------------------------------|--------------------------------|--------------------------------|--------------------------------|--------------------------------|--------------------------------|
| L ₄ /A ₁ | L ₃ /A ₂ | L ₂ /A ₃ | L ₁ /A ₄ | L ₄ /I ₁ | L ₃ /I ₂ | L ₂ /I ₃ | L ₁ /I ₄ |
| { list } | x _{int} | h | last | → | { list } | x _{int} | h _{next} current |

L = Level; A = Argument; I = item

See also: RKF, RKFERR, RKFSTEP, RRK, RSBERR

RSBERR

Type: Command

Description: Error Estimate for Rosenbrock Method Command: Returns an error estimate for a given step h when solving an initial values problem for a differential equation.

The arguments and results are as follows:

- { list } contains five items in this order:
 - The independent variable (t).
 - The solution variable (y).
 - The right-hand side of the differential equation (or a variable where the expression is stored).
 - The partial derivative of $y'(t)$ with respect to the solution variable (or a variable where the expression is stored).
 - The partial derivative of $y'(t)$ with respect to the independent variable (or a variable where the expression is stored).
- h is a real number that specifies the initial step.
- y_{delta} displays the change in solution.
- *error* displays the absolute error for that step. The *absolute* error is the absolute value of the estimated error for a scalar problem, and the row (infinity) norm of the estimated error vector for a vector problem. (The latter is a bound on the maximum error of any component of the solution.) A zero error indicates that the Rosenbrock method failed and Euler's method was used instead.

Access:  CAT RSBERR

Input/Output:

| | | | | | |
|--------------------------------|--------------------------------|--------------------------------|--------------------------------|--------------------------------|--------------------------------|
| L ₂ /A ₁ | L ₁ /A ₂ | L ₄ /I ₁ | L ₃ /I ₂ | L ₂ /I ₃ | L ₁ /I ₄ |
| { list } | h | → | { list } | h | y _{delta} error |

L = Level; A = Argument; I = item

See also: RKF, RKFERR, RKFSTEP, RRK, RRKSTEP

RSD

Type: Command

Description: Residual Command: Computes the residual $B - AZ$ of the arrays B , A , and Z .

A , B , and Z are restricted as follows:

- A must be a matrix.
- The number of columns of A must equal the number of elements of Z if Z is a vector, or the number of rows of Z if Z is a matrix.
- The number of rows of A must equal the number of elements of B if B is a vector, or the number of rows of B if B is a matrix.
- B and Z must both be vectors or both be matrices.
- B and Z must have the same number of columns if they are matrices.

RSD is typically used for computing a correction to Z , where Z has been obtained as an approximation to the solution X to the system of equations $AX = B$.

Access:  MATRICES OPERATIONS  RSD (MATRICES is the left-shift of the  key).

 MTH MATRIX  RSD (MTH is the left-shift of the  key).

Input/Output:

| Level 3/Argument 1 | Level 2/Argument 2 | Level 1/Argument 3 | Level 1/Item 1 |
|-----------------------|-----------------------|-----------------------|--|
| $[\text{vector}]_B$ | $[[\text{matrix}]]_A$ | $[\text{vector}]_Z$ | $\rightarrow [\text{vector}]_{B-AZ}$ |
| $[[\text{matrix}]]_B$ | $[[\text{matrix}]]_A$ | $[[\text{matrix}]]_Z$ | $\rightarrow [[\text{matrix}]]_{B-AZ}$ |

See also: DET, IDN

RSWP

Type: Command

Description: Row Swap Command: Swaps rows i and j of a matrix and returns the modified matrix, or swaps elements i and j of a vector and returns the modified vector.

Row numbers are rounded to the nearest integer. Vector arguments are treated as column vectors.

Access: \leftarrow MATRICES CREATE ROW \rightarrow NXT RSWP (\leftarrow MATRICES is the left-shift of the $\boxed{5}$ key).
 \leftarrow MTH MATRIX ROW \rightarrow NXT RSWP (\leftarrow MTH is the left-shift of the $\boxed{\text{SYMB}}$ key).

Input/Output:

| Level 3/Argument 1 | Level 2/Argument 2 | Level 1/Argument 3 | Level 1/Item 1 |
|-----------------------|--------------------|--------------------|-----------------------------------|
| $[[\text{matrix}]]_i$ | $n_{row\ i}$ | $n_{row\ j}$ | $\rightarrow [[\text{matrix}]]_2$ |
| $[\text{vector}]_i$ | $n_{element\ i}$ | $n_{element\ j}$ | $\rightarrow [\text{vector}]_2$ |

See also: CSWP, ROW+, ROW-

RULES

Type: Command

Description: Displays a list of names of individuals involved with the hp 49g calculator project.

Access: \rightarrow CAT RULES

Input/Output: None

R→B

Type: Command

Description: Real to Binary Command: Converts a positive real to its binary integer equivalent.

For any value of $n \leq 0$, the result is # 0. For any value of $n \geq 1.84467440738E19$ (base 10), the result is # FFFFFFFFFFFFFFFF (base 16).

Access: \rightarrow BASE R→B (\rightarrow BASE is the right-shift of the $\boxed{3}$ key).

Flags: Binary Integer Wordsize (-5 through -10), Binary Integer Base (-11, -12)

Input/Output:

| Level 1/Argument 1 | Level 1/Item 1 |
|--------------------|------------------|
| n | \rightarrow #n |

See also: B→R

R→C

Type: Command

Description: Real to Complex Command: Combines two real numbers or real arrays into a single complex number or complex array.

The first input represents the real element(s) of the complex result. The second input represents the imaginary element(s) of the complex result.

Array arguments must have the same dimensions.

Access: \leftarrow PRG TYPE \leftarrow R \rightarrow C (PRG is the left-shift of the EVAL key).

Input/Output:

| Level 2/Argument 1 | Level 1/Argument 2 | Level 1/Item 1 |
|-------------------------|---------------------------------------|----------------|
| x | y \rightarrow | (x,y) |
| [R-array ₁] | [R-array ₂] \rightarrow | [C-array] |

See also: C \rightarrow R, IM, RE

R \rightarrow D

Type: Function

Description: Radians to Degrees Function: Converts a real number expressed in radians to its equivalent in degrees.

This function operates independently of the angle mode.

Access: \leftarrow MTH REAL \leftarrow R \rightarrow D (MTH is the left-shift of the SYMB key).

Flags: Numerical Results (-3)

Input/Output:

| Level 1/Argument 1 | Level 1/Item 1 |
|----------------------|---------------------------|
| x \rightarrow | (180/ π)x |
| 'symb' \rightarrow | 'R \rightarrow D(symb)' |

See also: D \rightarrow R

R \rightarrow I

Type: Function

Description: Converts a real number to an integer.

Access: \leftarrow CONVERT REWRITE \leftarrow

Flags: Numeric mode must not be set (flag -3 clear).

Input: Level 1/Argument 1: An integral real number or an expression that evaluates to an integral real.

Output: Level 1/Item 1: The real value converted to an integer.

See also: I \rightarrow R

SAME

Type: Command

Description: Same Object Command: Compares two objects, and returns a true result (1) if they are identical, and a false result (0) if they are not.

SAME is identical in effect to == for all object types except algebraics, names, and some units. (For algebraics and names, == returns an expression that can be evaluated to produce a test result based on numerical values.

Access: \leftarrow PRG TEST \leftarrow SAME (PRG is the left-shift of the EVAL key).

Input/Output:

| Level 2/Argument 1 | Level 1/Argument 2 | Level 1/Item 1 |
|--------------------|--------------------------------|----------------|
| obj ₁ | obj ₂ \rightarrow | 0/1 |

See also: TYPE, ==

SBRK

Type: Command

Description: Serial Break Command: Interrupts serial transmission or reception.

SBRK is typically used when a problem occurs in a serial data transmission.

Access: \rightarrow CAT SBRK

Flags: I/O Device (-33)
Input/Output: None
See also: BUFLen, SRECV, STIME, XMIT

SCALE

Type: Command

Description: Scale Plot Command: Adjusts the first two parameters in *PPAR*, (x_{\min}, y_{\min}) and (x_{\max}, y_{\max}) , so that x_{scale} and y_{scale} are the new plot horizontal and vertical scales, and the center point doesn't change.

The scale in either direction is the number of user units per tick mark. The default scale in both directions is 1 user-unit per tick mark.

Access:  CAT SCALE

Input/Output:

| Level 2/Argument 1 | Level 1/Argument 2 | Level 1/Item 1 |
|--------------------|--------------------|----------------|
| x_{scale} | y_{scale} | → |

See also: AUTO, CENTR, SCALEH, SCALEW

SCALEH

Type: Command

Description: Multiply Height Command: Multiplies the vertical plot scale by x_{factor} .

Executing SCALEH changes the y -axis display range—the y_{\min} and y_{\max} components of the first two complex numbers in the reserved variable *PPAR*. The plot origin (the user-unit coordinate of the center pixel) is not changed.

Access:  CAT SCALEH

Input/Output:

| Level 1/Argument 1 | Level 1/Item 1 |
|---------------------|----------------|
| x_{factor} | → |

See also: AUTO, SCALEW, YRNG

SCALEW

Type: Command

Description: Multiply Width Command: Multiplies the horizontal plot scale by x_{factor} .

Executing SCALEW changes the x -axis display range—the x_{\min} and x_{\max} components of the first two complex numbers in the reserved variable *PPAR*. The plot origin (the user-unit coordinate of the center pixel) is not changed.

Access:  CAT SCALEW

Input/Output:

| Level 1/Argument 1 | Level 1/Item 1 |
|---------------------|----------------|
| x_{factor} | → |

See also: AUTO, SCALEH, XRNG

SCATRPLOT

Type: Command

Description: Draw Scatter Plot Command: Draws a scatterplot of (x, y) data points from the specified columns of the current statistics matrix (reserved variable *ΣDAT*).

The data columns plotted are specified by XCOL and YCOL, and are stored as the first two parameters in the reserved variable *ΣPAR*. If no data columns are specified, columns 1

(independent) and 2 (dependent) are selected by default. The y -axis is autoscaled and the plot type is set to SCATTER.

When SCATRPLOT is executed from a program, the resulting display does not persist unless PICTURE or PVIEW is subsequently executed.

Access:  CAT SCATRPLOT

Input/Output: None

See also: BARPLOT, PICTURE, HISTPLOT, PVIEW, SCLΣ, XCOL, YCOL

SCATTER

Type: Command

Description: Scatter Plot Type Command: Sets the plot type to SCATTER.

When the plot type is SCATTER, the DRAW command plots points by obtaining x and y coordinates from two columns of the current statistics matrix (reserved variable ΣDAT). The columns are specified by the first and second parameters in the reserved variable ΣPAR (using the XCOL and YCOL commands). The plotting parameters are specified in the reserved variable $PPAR$, which has this form:

$$\{ (x_{\min}, y_{\min}), (x_{\max}, y_{\max}), indep, res, axes, ptype, depend \}$$

For plot type SCATTER, the elements of $PPAR$ are used as follows:

- (x_{\min}, y_{\min}) is a complex number specifying the lower left corner of $PICT$ (the lower left corner of the display range). The default value is $(-6.5, -3.1)$ for the hp48gII and $(-6.5, -3.9)$ for the hp49g+.
- (x_{\max}, y_{\max}) is a complex number specifying the upper right corner of $PICT$ (the upper right corner of the display range). The default value is $(6.5, 3.2)$ for the hp48gII and $(6.5, 4.0)$ for the hp49g+.
- *indep* is a name specifying the independent variable. The default value of *indep* is X .
- *res* is not used.
- *axes* is a list containing one or more of the following, in the order listed: a complex number specifying the user-unit coordinates of the plot origin, a list specifying the tick-mark annotation, and two strings specifying labels for the horizontal and vertical axes. The default value is $(0, 0)$.
- *ptype* is a command name specifying the plot type. Executing the command SCATTER places the name SCATTER in *ptype*.
- *depend* is a name specifying the dependent variable. The default value is Y .

Access:  CAT SCATTER

Input/Output: None

See also: BAR, CONIC, DIFFEQ, FUNCTION, GRIDMAP, HISTOGRAM, PARAMETRIC, PARSURFACE, PCONTOUR, POLAR, SLOPEFIELD, TRUTH, WIREFRAME, YSLICE

SCHUR

Type: Command

Description: Schur Decomposition of a Square Matrix Command: Returns the Schur decomposition of a square matrix. SCHUR decomposes A into two matrices Q and T :

- If A is a complex matrix, Q is a unitary matrix, and T is an upper-triangular matrix.
- If A is a real matrix, Q is an orthogonal matrix, and T is an upper quasi-triangular matrix (T is upper block triangular with 1×1 or 2×2 diagonal blocks where the 2×2 blocks have complex conjugate eigenvalues).

In either case, $A \cong Q \times T \times \text{TRN}(Q)$

Access:  MATRICES FACTORIZATION SCHUR

(MATRICES is the left-shift of the  key).

 MTH MATRIX FACTORS SCHUR

(MTH is the left-shift of the  key).

Input/Output:

| Level 1/Argument 1 | | Level 2/Item 1 | | Level 1/Item 2 |
|--------------------------|---|--------------------------|--|--------------------------|
| $[[\text{matrix}]]_A$ | → | $[[\text{matrix}]]_E$ | | $[[\text{matrix}]]_T$ |

See also: LQ, LU, QR, SVD, SVL, TRN

SCI

Type: Command

Description: Scientific Mode Command: Sets the number display format to scientific mode, which displays one digit to the left of the fraction mark and n significant digits to the right. Scientific mode is equivalent to scientific notation using $n + 1$ significant digits, where $0 \leq n \leq 11$. (Values for n outside this range are rounded to the nearest integer.) In scientific mode, numbers are displayed and printed like this:

$$(\text{sign}) \text{ mantissa } E (\text{sign}) \text{ exponent}$$

where the mantissa has the form $n.(n \dots)$ and has zero to 11 decimal places, and the exponent has one to three digits.

Access: \leftarrow & MODE FMT SCI
 \leftarrow PRG NXT MODES FMT SCI (PRG is the left-shift of the EVAL key).

Input/Output:

| Level 1/Argument 1 | | Level 1/Item 1 |
|--------------------|---|----------------|
| n | → | |

See also: ENG, FIX, STD

SCLΣ

Type: Command

Description: Scale Sigma Command: Adjusts (x_{\min}, y_{\min}) and (x_{\max}, y_{\max}) in *PPAR* so that a subsequent scatter plot exactly fills *PICT*.

When the plot type is SCATTER, the command AUTO incorporates the functions of SCLΣ. In addition, the command SCATRPLT automatically executes AUTO to achieve the same result.

Access: \rightarrow CAT SCLΣ

Input/Output: None

See also: AUTO, SCATRPLT

SCONJ

Type: Command

Description: Store Conjugate Command: Conjugates the contents of a named object.

The named object must be a number, an array, or an algebraic object. For information on conjugation, see CONJ.

Access: \leftarrow PRG MEMORY ARITHMETIC NXT SCONJ (PRG is the left-shift of the EVAL key).

Input/Output:

| Level 1/Argument 1 | | Level 1/Item 1 |
|--------------------|---|----------------|
| 'name' | → | |

See also: CONJ, SINV, SNEG

SCROLL

Type: Command

Description: Displays any object. This is the programmable equivalent of pressing TOOL VIEW and is the best way to view any object larger than the screen, such as complicated algebraic expressions.

Access: \rightarrow CAT SCROLL

Input/Output:

| Level 1/Argument 1 | Level 1/Item 1 |
|--------------------|----------------|
| Grob | → |

SDEV

Type: Command

Description: Standard Deviation Command: Calculates the sample standard deviation of each of the m columns of coordinate values in the current statistics matrix (reserved variable ΣDAT). SDEV returns a vector of m real numbers, or a single real number if $m = 1$. The standard deviation (the square root of the variances) is computed using this formula:

$$\sqrt{\frac{1}{n-1} \sum_{i=1}^n (x_i - \bar{x})^2}$$

where x_i is the i th coordinate value in a column, \bar{x} is the mean of the data in this column, and n is the number of data points.

Access:  CAT SDEV

Input/Output:

| Level 1/Argument 1 | Level 1/Item 1 |
|--------------------|---|
| | → X_{sdev} |
| | → $[X_{sdev\ 1} X_{sdev\ 2} \dots X_{sdev\ m}]$ |

See also: MAX Σ , MEAN, MIN Σ , PSDEV, PVAR, TOT, VAR

SEND

Type: Command

Description: Send Object Command: Sends a copy of the named objects to a Kermit device. Data is always sent from a local Kermit, but can be sent either to another local Kermit (which must execute RECV or RECN) or to a server Kermit. To rename an object when sending it, include the old and new names in an embedded list.

Access:  CAT SEND

Flags: I/O Device flag (-33), I/O Data Format (-35), I/O Messages (-39)

Input/Output:

| Level 1/Argument 1 | Level 1/Item 1 |
|---|----------------|
| 'name' | → |
| { name ₁ ... name _n } | → |
| {{ name _{old} name _{new} } name ... } | → |

See also: BAUD, CLOSEIO, CKSM, FINISH, KERRM, KGET, PARITY, RECN, RECV, SERVER, TRANSIO

SEQ

Type: Command

Description: Sequential Calculation Command: Returns a list of results generated by repeatedly executing obj_{exec} using $index$ over the range x_{start} to x_{end} , in increments of x_{incr} . obj_{exec} is nominally a program or algebraic object that is a function of $index$, but can actually be an object. $index$ must be a global or local name. The remaining objects can be anything that will evaluate to real numbers.

The action of SEQ for arbitrary inputs can be predicted exactly from this equivalent program.

$$x_{start} \ x_{end} \text{ FOR } index \ obj_{exec} \ \text{ EVAL } x_{incr} \ \text{ STEP } n \rightarrow \text{ LIST}$$

where n is the number of new objects left on the stack by the FOR ... STEP loop. Notice that *index* becomes a local variable regardless of its original type.

Access: \leftarrow PRG LIST PROCEDURES \leftarrow SEQ (\leftarrow PRG is the left-shift of the \leftarrow EVAL key).

Input/Output:

| | | | | | |
|--------------|-----------|-------------|-----------|------------|------------------------|
| L_5/A_1 | L_4/A_2 | L_3/A_3 | L_2/A_4 | L_1/A_5 | L_1/I_1 |
| obj_{exec} | index | x_{start} | x_{end} | x_{incr} | \rightarrow { list } |

L = Level; A = Argument; I = item

See also: DOSUBS, STREAM

SERIES

CAS: Compute Taylor series, asymptotic development and limits of a given function.

SERVER

Type: Command

Description: Server Mode Command: Selects Kermit Server mode.

A Kermit server (a Kermit device in Server mode) passively processes requests sent to it by the local Kermit. The server receives data in response to SEND, transmits data in response to KGET, terminates Server mode in response to FINISH or LOGOUT, and transmits a directory listing in response to a generic directory request.

Access: \leftarrow CAT SERVER

Flags: I/O Device flag (-33), I/O Data Format (-35), RECV Overwrite (-36), I/O Messages (-39)

Input/Output: None

See also: BAUD, CKSM, FINISH, KERRM, KGET, PARITY, PKT, REC, RECV, SEND, TRANSIO

SEVAL

CAS: Simplify a given expression, except at the highest level, and replace variables with their values.

SF

Type: Command

Description: Set Flag Command: Sets a specified user or system flag.

User flags are numbered 1 through 128. System flags are numbered -1 through -128. See Appendix C for a listing of system flags and their flag numbers.

Access: \leftarrow PRG TEST \leftarrow SF (\leftarrow PRG is the left-shift of the \leftarrow EVAL key).

Input/Output:

| | |
|---------------------------|-----------------------|
| Level 1/Argument 1 | Level 1/Item 1 |
| $n_{flagnumber}$ | \rightarrow |

See also: CF, FC?, FC?C, FS?, FS?C

SHOW

Type: Command

Description: Show Variable Command: Returns ymb_2 , which is equivalent to ymb_1 except that all implicit references to a variable *name* are made explicit. If the level 1 argument is a list, SHOW evaluates all global variables in ymb_1 not contained in the list.

Access: \leftarrow CAT SHOW

Flags: Numerical Results (-3)

Input/Output:

| Level 2/Argument 1 | Level 1/Argument 2 | Level 1/Item 1 |
|----------------------|-----------------------------------|----------------------|
| 'symb ₁ ' | 'name' → | 'symb ₂ ' |
| 'symb ₁ ' | { name, name ₂ ... } → | 'symb ₂ ' |

See also: COLCT, EXPAN, ISOL, QUAD

SIDENS

Type: Function

Description: Silicon Intrinsic Density Command: Calculates the intrinsic density of silicon as a function of temperature, x_T .

If x_T is a unit object, it must reduce to a pure temperature, and the density is returned as a unit object with units of $1/\text{cm}^3$.

If x_T is a real number, its units are assumed to be K, and the density is returned as a real number with implied units of $1/\text{cm}^3$.

x_T must be between 0 and 1685 K.

Access: $\left[\rightarrow \right]$ $\left[\text{CAT} \right]$ SIDENS

Flags: Numerical Results (-3)

Input/Output:

| Level 1/Argument 1 | Level 1/Item 1 |
|--------------------|----------------------|
| x_T → | x_{density} |
| x_{unit} | $x_{\text{1/cm}^3}$ |
| 'symb' | 'SIDENS(symb)' |

SIGMA

CAS: For given variable y , calculate discrete antiderivative G of given function f : $G(y + 1) - G(y) = f(y)$.

SIGMAVX

CAS: For current variable x , calculate discrete antiderivative G of function f : $G(x + 1) - G(x) = f(x)$.

SIGN

Type: Function

Description: Sign Function: Returns the sign of a real number argument, the sign of the numerical part of a unit object argument, or the unit vector in the direction of a complex number argument.

For real number and unit object arguments, the sign is defined as +1 for positive arguments, -1 for negative arguments. In exact mode, the sign for argument 0 is undefined (?). In approximate mode, the sign for argument 0 is 0. SIGN in the $\left[\leftarrow \right]$ $\left[\text{MTH} \right]$ menu returns the sign of a number, while SIGN in the $\left[\rightarrow \right]$ $\left[\text{CMPLX} \right]$ menu returns returns the unit vector of a complex number.

For a complex argument:

$$\text{SIGN}(x + iy) = \frac{x}{\sqrt{x^2 + y^2}} + \frac{iy}{\sqrt{x^2 + y^2}}$$

Access: $\left[\leftarrow \right]$ $\left[\text{MTH} \right]$ REAL $\left[\text{NXT} \right]$ SIGN ($\left[\text{MTH} \right]$ is the left-shift of the $\left[\text{SYMB} \right]$ key).
 $\left[\rightarrow \right]$ $\left[\text{CMPLX} \right]$ $\left[\text{NXT} \right]$ SIGN ($\left[\text{CMPLX} \right]$ is the right-shift of the $\left[\text{I} \right]$ key).

Flags: Numerical Results (-3)

Input/Output:

| Level 1/Argument 1 | | Level 1/Item 1 |
|--------------------|---|----------------|
| z_1 | → | z_2 |
| x_unit | | x_{sign} |
| 'symb' | | 'SIGN(symb)' |

See also: ABS, MANT, XPON

SIGNTAB

CAS: Tabulate the sign of a rational function of the current CAS variable.

SIMP2

CAS: Simplify two objects by dividing them by their greatest common divisor.

SIMPLIFY

CAS: Simplify an expression.

SIN

Type: Analytic function

Description: Sine Analytic Function: Returns the sine of the argument.

For real arguments, the current angle mode determines the number's units, unless angular units are specified.

For complex arguments, $\sin(x + iy) = \sin x \cosh y + i \cos x \sinh y$.

If the argument for SIN is a unit object, then the specified angular unit overrides the angle mode to determine the result. Integration and differentiation, on the other hand, always observe the angle mode. Therefore, to correctly integrate or differentiate expressions containing SIN with a unit object, the angle mode must be set to radians (since this is a “neutral” mode).

Access: SIN

Flags: Numerical Results (-3), Angle Mode (-17, -18)

Input/Output:

| Level 1/Argument 1 | | Level 1/Item 1 |
|---------------------|---|---------------------------|
| z | → | $\sin z$ |
| $x_unit_{angular}$ | | $\sin(x_unit_{angular})$ |
| 'symb' | | 'SIN(symb)' |

See also: ASIN, COS, TAN

SINCOS

CAS: Convert logarithmic and exponential expressions to expressions with trigonometric terms.

SINH

Type: Analytic function

Description: Hyperbolic Sine Analytic Function: Returns the hyperbolic sine of the argument.

For complex arguments, $\sinh(x + iy) = \sinh x \cos y + i \cosh x \sin y$.

Access: → TRIG HYPERBOLIC SINH (→TRIG is the right-shift of the 8 key).

← MTH HYPERBOLIC SINH (←MTH is the left-shift of the SYMB key).

Flags: Numerical Results (-3)

Input/Output:

| Level 1/Argument 1 | | Level 1/Item 1 |
|--------------------|---|----------------|
| z | → | sinh z |
| 'symb' | | 'SINH(symb)' |

See also: ASINH, COSH, TANH

SINV

Type: Command

Description: Store Inverse Command: Replaces the contents of the named variable with its inverse. The named object must be a number, a matrix, an algebraic object, or a unit object. For information on reciprocals, see INV.

Access: PRG MEMORY ARITHMETIC SINV (is the left-shift of the key).

Input/Output:

| Level 1/Argument 1 | | Level 1/Item 1 |
|--------------------|---|----------------|
| 'name' | → | |

See also: INV, SCONJ, SNEG

SIZE

Type: Command Operation

Description: Size Command: Returns the number of characters in a string, the number of elements in a list, the dimensions of an array, the number of objects in a unit object or algebraic object, or the dimensions of a graphics object.

The size of a unit is computed as follows: the scalar (+1), the underscore (+1), each unit name (+1), operator or exponent (+1), and each prefix (+2).

Any object type not listed above returns a value of 1.

Access: PRG CHARS SIZE (is the left-shift of the key).

Input/Output:

| Level 1/Argument 1 | | Level 2/Item 1 | Level 1/Item 2 |
|--------------------|---|---------------------|----------------------|
| "string" | → | | n |
| { list } | → | | n |
| [vector] | → | | { n } |
| [[matrix]] | → | | { n m } |
| 'symb' | → | | n |
| grob | → | #n _{width} | #m _{height} |
| PICT | → | #n _{width} | #m _{height} |
| x_unit | → | | n |

See also: CHR, NUM, POS, REPL, SUB

SL

Type: Command

Description: Shift Left Command: Shift a binary integer one bit to the left.

The most significant bit is shifted out to the left and lost, while the least significant bit is regenerated as a zero. SL is equivalent to binary multiplication by 2, truncated to the current wordsize.

Access: MTH BASE BIT SL (is the left-shift of the key).

BASE BIT SL (is the right-shift of the key).

Flags: Binary Integer Wordsize (-5 through -10), Binary Integer Base (-11, -12)

Input/Output:

| Level 1/Argument 1 | Level 1/Item 1 |
|--------------------|-------------------|
| #n ₁ | → #n ₂ |

See also: ASR, SLB, SR, SRB

SLB

Type: Command

Description: Shift Left Byte Command: Shifts a binary integer one byte to the left.

The most significant byte is shifted out to the left and lost, while the least significant byte is regenerated as zero. SLB is equivalent to binary multiplication by 2⁸ (256) (or executing SL eight times), truncated to the current wordsize.

Access:  MTH BASE  BYTE SLB (MTH is the left-shift of the  key).

 BASE  BYTE SLB (BASE is the right-shift of the  key).

Flags: Binary Integer Wordsize (-5 through -10), Binary Integer Base (-11, -12)

Input/Output:

| Level 1/Argument 1 | Level 1/Item 1 |
|--------------------|-------------------|
| #n ₁ | → #n ₂ |

See also: ASR, SL, SR, SRB

SLOPEFIELD

Type: Command

Description: SLOPEFIELD Plot Type Command: Sets the plot type to SLOPEFIELD.

When plot type is set to SLOPEFIELD, the DRAW command plots a slope representation of a scalar function with two variables. SLOPEFIELD requires values in the reserved variables *EQ*, *VPAR*, and *PPAR*.

VPAR has the following form:

{ *x*_{left} *x*_{right} *y*_{near} *y*_{far} *z*_{low} *z*_{high} *x*_{min} *x*_{max} *y*_{min} *y*_{max} *x*_{eye} *y*_{eye} *z*_{eye} *x*_{step} *y*_{step} }

For plot type SLOPEFIELD, the elements of *VPAR* are used as follows:

- *x*_{left} and *x*_{right} are real numbers that specify the width of the view space.
- *y*_{near} and *y*_{far} are real numbers that specify the depth of the view space.
- *z*_{low} and *z*_{high} are real numbers that specify the height of the view space.
- *x*_{min} and *x*_{max} are not used.
- *y*_{min} and *y*_{max} are not used.
- *x*_{eye}, *y*_{eye}, and *z*_{eye} are real numbers that specify the point in space from which the graph is viewed.
- *x*_{step} and *y*_{step} are real numbers that set the number of x-coordinates versus the number of y-coordinates plotted.

The plotting parameters are specified in the reserved variable *PPAR*, which has this form:

{ (*x*_{min}, *y*_{min}) (*x*_{max}, *y*_{max}) *indep res axes ptype depend* }

For plot type SLOPEFIELD, the elements of *PPAR* are used as follows:

- (*x*_{min}, *y*_{min}) is not used.
- (*x*_{max}, *y*_{max}) is not used.
- *indep* is a name specifying the independent variable. The default value of *indep* is *X*.
- *res* is not used.
- *axes* is not used.
- *ptype* is a command name specifying the plot type. Executing the command SLOPEFIELD places the command name SLOPEFIELD in *ptype*.
- *depend* is a name specifying the dependent variable. The default value is *Y*.

Access: $\boxed{\rightarrow}$ CAT SLOPEFIELD

Input/Output: None

See also: BAR, CONIC, DIFFEQ, FUNCTION, GRIDMAP, HISTOGRAM, PARAMETRIC, PARSURFACE, PCONTOUR, POLAR, SCATTER, TRUTH, WIREFRAME, YSLICE

SNEG

Type: Command

Description: Store Negate Command: Replaces the contents of a variable with its negative. The named object must be a number, an array, an algebraic object, a unit object, or a graphics object. For information on negation, see NEG.

Access: $\boxed{\leftarrow}$ PRG MEMORY ARITHMETIC $\boxed{\text{NXT}}$ SNEG (PRG is the left-shift of the $\boxed{\text{EVAL}}$ key).

Input/Output:

| Level 1/Argument 1 | Level 1/Item 1 |
|--------------------|----------------|
| 'name' | → |

See also: NEG, SCONJ, SINV

SNRM

Type: Command

Description: Spectral Norm Command: Returns the spectral norm of an array. The spectral norm of a vector is its Euclidean length, and is equal to the largest singular value of a matrix.

Access: $\boxed{\leftarrow}$ MATRICES OPERATIONS $\boxed{\text{NXT}}$ $\boxed{\text{NXT}}$ SNRM (MATRICES is the left-shift of the $\boxed{5}$ key).

$\boxed{\leftarrow}$ MTH MATRIX NORMALIZE SNRM (MTH is the left-shift of the $\boxed{\text{SYMB}}$ key).

Input/Output:

| Level 1/Argument 1 | Level 1/Item 1 |
|--------------------|-----------------------------|
| [array] | → $X_{\text{spectralnorm}}$ |

See also: ABS, CNRM, COND, RNRM, SRAD, TRACE

SOLVE

CAS: Find zeros of an expression, or solve an equation with respect to a specified variable.

SOLVEQN

Type: Command

Description: Starts the appropriate solver for a specified set of equations. SOLVEQN sets up and starts the appropriate solver for the specified set of equations, bypassing the Equation Library catalogs. It sets *EQ* (and *Mpar* if more than one equation is being solved), sets the unit options according to flags -60 and -61, and starts the appropriate solver. SOLVEQN uses subject and title numbers (levels 3 and 2) and a "PICT" option (level 1) and returns nothing. Subject and title numbers are listed in chapter 5. For example, a 2 in level 3 and a 9 in level 2 would specify the Electricity category and Capacitive Energy set of equations. If the "PICT" option is 0, *PICT* is not affected; otherwise, the equation picture (if any) is copied into *PICT*.

Access: $\boxed{\rightarrow}$ CAT SOLVEQN

Flags: Unit Type (-60), Units Usage (-61)

Input/Output:

| Level 3/Argument 1 | Level 2/Argument 2 | Level 1/Argument 3 | Level 1/Item 1 |
|--------------------|--------------------|--------------------|----------------|
| n | m | 0/1 | → |

See also: EQNLIB, MSOLVER

SOLVER

Type: Command

Description: Displays a menu of commands used in solving equations.

Access: \leftarrow $\overline{\text{CAT}}$ SOLVER

Input/Output: None

SOLVEVX

CAS: Find zeros of an expression, or solves an equation with respect to the current variable.

SORT

Type: Command

Description: Ascending Order Sort Command: Sorts the elements in a list in ascending order.

The elements in the list can be real numbers, strings, lists, names, binary integers, or unit objects. However, all elements in the list must all be of the same type. Strings and names are sorted by character code number. Lists of lists are sorted by the first element in each list.

To sort in reverse order, use SORT REVLIST.

Access: \leftarrow $\overline{\text{MTH}}$ LIST SORT ($\overline{\text{MTH}}$ is the left-shift of the $\overline{\text{SYMB}}$ key).

\leftarrow $\overline{\text{PRG}}$ LIST PROCEDURES $\overline{\text{NXT}}$ SORT ($\overline{\text{PRG}}$ is the left-shift of the $\overline{\text{EVAL}}$ key).

Input/Output:

| Level 1/Argument 1 | Level 1/Item 1 |
|-----------------------|-------------------------|
| { list } ₁ | → { list } ₂ |

See also: REVLIST

SPHERE

Type: Command

Description: Spherical Mode Command: Sets spherical coordinate mode.

SPHERE sets flags -15 and -16.

In spherical mode, vectors are displayed as polar components.

Access: \leftarrow $\&\overline{\text{MODE}}$ ANGLE SPHERE

Input/Output: None

See also: CYLIN, RECT

SQ

Type: Analytic function

Description: Square Analytic Function: Returns the square of the argument.

The square of a complex argument (x, y) is the complex number $(x^2 - y^2, 2xy)$.

Matrix arguments must be square.

Access: \leftarrow $\overline{x^2}$ ($\overline{x^2}$ is the left-shift of the $\overline{\sqrt{x}}$ key).

Flags: Numerical Results (-3)

Input/Output:

| Level 1/Argument 1 | Level 1/Item 1 |
|--------------------|-------------------------------------|
| z | → z ² |
| x_unit | → x ² _unit ² |
| [[matrix]] | → [[matrix × matrix]] |
| 'symb' | → 'SQ(symb)' |

See also: $\sqrt{\quad}$, \wedge

SR

Type: Command

Description: Shift Right Command: Shifts a binary integer one bit to the right.

The least significant bit is shifted out to the right and lost, while the most significant bit is regenerated as a zero. SR is equivalent to binary division by 2.

Access: \leftarrow MTH BASE \leftarrow NXT BIT SR (MTH is the left-shift of the SYMB key).
 \rightarrow BASE \leftarrow NXT BIT SR (BASE is the right-shift of the 3 key).

Flags: Binary Integer Wordsize (-5 through -10), Binary Integer Base (-11, -12)

Input/Output:

| Level 1/Argument 1 | Level 1/Item 1 |
|--------------------|-------------------|
| #n ₁ | → #n ₂ |

See also: ASR, SL, SLB, SRB

SRAD

Type: Command

Description: Spectral Radius Command: Returns the spectral radius of a square matrix.

The spectral radius of a matrix is a measure of the size of the matrix, and is equal to the absolute value of the largest eigenvalue of the matrix.

Access: \leftarrow MATRICES OPERATIONS \leftarrow NXT \leftarrow NXT SRAD (MATRICES is the left-shift of the 5 key).
 \leftarrow MTH MATRIX NORMALIZE SRAD (MTH is the left-shift of the SYMB key).

Input/Output:

| Level 1/Argument 1 | Level 1/Item 1 |
|-----------------------------|-------------------------------|
| [[matrix]] _{n×n} | → X _{spectralradius} |

See also: COND, SNRM, TRACE

SRB

Type: Command

Description: Shift Right Byte Command: Shifts a binary integer one byte to the right.

The least significant byte is shifted out to the right and lost, while the most significant byte is regenerated as zero. SRB is equivalent to binary division by 2⁸ (or executing SR eight times).

Access: \leftarrow MTH BASE \leftarrow NXT BYTE SRB (MTH is the left-shift of the SYMB key).
 \rightarrow BASE \leftarrow NXT BYTE SRB (BASE is the right-shift of the 3 key).

Flags: Binary Integer Wordsize (-5 through -10), Binary Integer Base (-11, -12)

Input/Output:

| Level 1/Argument 1 | Level 1/Item 1 |
|--------------------|-------------------|
| #n ₁ | → #n ₂ |

See also: ASR, SL, SLB, SR

SRECV

Type: Command

Description: Serial Receive Command: Reads up to *n* characters from the serial input buffer and returns them as a string, along with a digit indicating whether errors occurred.

SRECV does not use Kermit protocol.

If *n* characters are not received within the time specified by STIME (default is 10 seconds), SRECV “times out”, returning a 0 to level 1 and as many characters as were received to level 2.

If the level 2 output from BUFLLEN is used as the input for SRECV, SRECV will not have to wait for more characters to be received. Instead, it returns the characters already in the input buffer.

If you want to accumulate bytes in the input buffer before executing SRECV, you must first open the port using OPENIO (if the port isn't already open).

SRECV can detect three types of error when reading the input buffer:

- Framing errors and UART overruns (both causing "Receive Error" in ERRM).
- Input-buffer overflows (causing "Receive Buffer Overflow" in ERRM).
- Parity errors (causing "Parity Error" in ERRM).

SRECV returns 0 if an error is detected when reading the input buffer, or 1 if no error is detected.

Parity errors do not stop data flow into the input buffer. However, if a parity error occurs, SRECV stops reading data after encountering a character with an error.

Framing, overrun, and overflow errors cause all subsequently received characters to be ignored until the error is cleared. SRECV does not detect and clear any of these types of errors until it tries to read the byte where the error occurred. Since these three errors cause the byte where the error occurred and all subsequent bytes to be ignored, the input buffer will be empty after all previously received good bytes have been read. Therefore, SRECV detects and clears these errors when it tries to read a byte from an empty input buffer.

Note that BUFLLEN also clears the above-mentioned framing, overrun, and overflow errors. Therefore, SRECV cannot detect an input-buffer overflow after BUFLLEN is executed, unless more characters were received after BUFLLEN was executed (causing the input buffer to overflow again). SRECV also cannot detect framing and UART overrun errors cleared by BUFLLEN. To find where the data error occurred, save the number of characters returned by BUFLLEN (which gives the number of "good" characters received), because as soon as the error is cleared, new characters can enter the input buffer.

Access: SRECV

Flags: I/O Device (-33)

Input/Output:

| Level 1/Argument 1 | Level 2/Item 1 | Level 1/Item 2 |
|--------------------|----------------|----------------|
| n | → | 'string' |
| | | 0/1 |

See also: BUFLLEN, CLOSEIO, OPENIO, SBRK, STIME, XMIT

SREPL

Type: Command

Description: Find and replace: Finds and replaces a string in a given text object. You supply the following inputs:

Level 3/argument 1: the string to search.

Level 2/argument 2: the string to find.

Level 1/argument 3: the string to replace it with.

Access: & SREPL

CHARS SREPL (is the left-shift of the key).

Input/Output:

| Level 3/Argument 1 | Level 2/Argument 2 | Level 1/Argument 3 | Level 1/Item 1 |
|--------------------|--------------------|--------------------|----------------|
| 'string' | 'string' | 'string' | → 'string' |

See also: REPL

START

Type: Command Operation

Description: START Definite Loop Structure Command: Begins START ... NEXT and START ... STEP definite loop structures.

Definite loop structures execute a command or sequence of commands a specified number of times.

- START ... NEXT executes a portion of a program a specified number of times.
The RPL syntax is this: x_{start} x_{finish} START *loop-clause* NEXT
The algebraic syntax is this: START(x_{start} x_{finish}) *loop-clause* NEXT
START takes two numbers (x_{start} and x_{finish}) from the stack and stores them as the starting and ending values for a loop counter. Then the loop clause is executed. NEXT increments the counter by 1 and tests to see if its value is less than or equal to x_{finish} . If so, the loop clause is executed again. Notice that the loop clause is always executed at least once.
- START ... STEP works just like START ... NEXT, except that it can use an increment value other than 1. The RPL syntax is this: x_{start} x_{finish} START *loop-clause* $x_{increment}$ STEP
The algebraic syntax is this: START (x_{start} x_{finish}) *loop-clause* STEP($x_{increment}$)
START takes two numbers (x_{start} and x_{finish}) from the stack and stores them as the starting and ending values for the loop counter. Then the loop clause is executed. STEP takes $x_{increment}$ from the stack and increments the counter by that value. If the argument of STEP is an algebraic or a name, it is automatically evaluated to a number.
The increment value can be positive or negative:
 - If positive, the loop is executed again when the counter is less than or equal to x_{finish} .
 - If negative, the loop is executed when the counter is greater than or equal to x_{finish} .

Access:  PRG BRANCH START (PRG is the left-shift of the  key).

Input/Output:

| Level 2/Argument 1 | Level 1/Argument 2 | Level 1/Item 1 |
|--------------------|------------------------------|----------------|
| START x_{start} | x_{finish} | → |
| NEXT | | → |
| STEP | $x_{increment}$ | → |
| STEP | 'symb _{increment} ' | → |

See also: FOR, NEXT, STEP

STD

Type: Command

Description: Standard Mode Command: Sets the number display format to standard mode.

Executing STD has the same effect as clearing flags -49 and -50.

Standard format produces the following results when displaying or printing a number.

- Numbers that can be represented exactly as integers with 12 or fewer digits are displayed without a fraction mark or exponent. Zero is displayed as 0.
- Numbers that can be represented exactly with 12 or fewer digits, but not as integers, are displayed with a fraction mark but no exponent. Leading zeros to the left of the fraction mark and trailing zeros to the right of the fraction mark are omitted.
- All other numbers are displayed in scientific notation (see SCI) with both a fraction mark (with one number to the left) and an exponent (of one or three digits). There are no leading or trailing zeros.

In algebraic objects, integers less than 10^3 are always displayed in standard mode.

Access:  CAT STD

Input/Output: None

See also: ENG, FIX, SCI

STEP

Type: Command Operation

Description: STEP Command: Defines the increment (step) value, and ends definite loop structure.

See the FOR and START keyword entries for more information.

Access:  PRG BRANCH START/FOR STEP (PRG is the left-shift of the  key).

Input/Output: None

See also: FOR, NEXT, START

STEQ

Type: Command

Description: Store in EQ Command: Stores an object into the reserved variable *EQ* in the current directory.

Access:  CAT STEQ

Input/Output:

| Level 1/Argument 1 | Level 1/Item 1 |
|--------------------|----------------|
| obj | → |

See also: RCEQ

STIME

Type: Command

Description: Serial Time-Out Command: Specifies the period that SRECV (serial reception) and XMIT (serial transmission) wait before timing out.

The value for *x* is interpreted as a positive value from 0 to 25.4 seconds. If no value is given, the default is 10 seconds. If *x* is 0, there is no time-out; that is, the device waits indefinitely, which can drain the batteries.

STIME is not used for Kermit time-out.

Access:  CAT STIME

Input/Output:

| Level 1/Argument 1 | Level 1/Item 1 |
|--------------------|----------------|
| <i>x</i> seconds | → |
| 0 | → |

See also: BUFLN, CLOSEIO, SBRK, SRECV, XMIT

STO

Type: Command



Description: Store Command: Stores an object into a specified variable or object.

Storing a graphics object into *PICT* makes it the current graphics object.

To create a backup object, store the *obj* into the desired backup location (identified as *:n_{port}:name_{backup}*). STO will not overwrite an existing backup object.

To store backup objects and library objects, specify a port number (0 through 3).

After storing a library object in a port, it must then be attached to its directory before it can be used.

The easiest way to do this is to execute a warm start (by pressing  & ). This also causes the calculator to perform a *system halt*, which clears the stack, the LAST stack, and all local variables.

STO can also replace a single element of an array or list stored in a variable. Specify the variable in level 1 as *name(index)*, which is a user function with *index* as the argument. The *index* can be *n* or *n,m*, where *n* specifies the row position in a vector or list, and *n,m* specifies the row-and-column position in a matrix.

Access: 

Input/Output:

| Level 2/Argument 1 | Level 1/Argument 2 | Level 1/Item 1 |
|--------------------|--|----------------|
| obj | 'name' | → |
| grob | PICT | → |
| obj | :n _{port} :name _{backup} | → |
| obj | 'name(index)' | → |
| backup | n _{port} | → |
| library | n _{port} | → |
| library | :n _{port} :n _{library} | → |

See also: DEFINE, RCL, →, ▶

STOALARM

Type: Command

Description: Store Alarm Command: Stores an alarm in the system alarm list and returns its alarm index number.

If the argument is a real number x_{time} , the alarm date will be the current system date by default.

If obj_{action} is a string, the alarm is an appointment alarm, and the string is the alarm message. If obj_{action} is any other object type, the alarm is a control alarm, and the object is executed when the alarm comes due.

x_{repeat} is the repeat interval for the alarm in clock ticks, where 8192 ticks equals 1 second.

n_{index} is a real integer identifying the alarm based on its chronological position in the system alarm list.

Access:  TIME TOOLS ALRM STOALARM (TIME is the right-shift of the  key).

Flags: Date Format (-42), Repeat Alarms Not Rescheduled (-43), Acknowledged Alarms Saved (-44)

Input/Output:

| Level 1/Argument 1 | Level 1/Item 1 |
|---|----------------------|
| x_{time} | → n _{index} |
| { date time } | → n _{index} |
| { date time obj _{action} } | → n _{index} |
| { date time obj _{action} x _{repeat} } | → n _{index} |

See also: DELALARM, FINDALARM, RCLALARM

STOF

Type: Command

Description: Store Flags Command: Sets the states of the system flags or the system and user flags.

With argument $\#n_{system}$, STOF sets the states of the system flags (-1 through -128) only. With argument { $\#n_{system}$, $\#n_{user}$, $\#n_{system2}$ $\#n_{user2}$ }, STOF sets the states of both the system and user flags.

A bit with value 1 sets the corresponding flag; a bit with value 0 clears the corresponding flag. The rightmost (least significant) bit of $\#n_{system}$ and $\#n_{user}$ correspond to the states of system flag -1 and user flag +1, respectively.

STOF can preserve the states of flags before a program executes and changes the states. RCLF can then recall the flag's states after the program is executed.

Access:  CAT STOF

Flags: Binary Integer Wordsize (-5 through -10)

Input/Output:

| Level 1/Argument 1 | Level 1/Item 1 |
|---|----------------|
| #n _{system} | → |
| { #n _{system} #n _{user} #n _{system2} #n _{user2} } | → |

See also: RCLF, STWS, RCWS

STOKEYS

Type: Command

Description: Store Key Assignments Command: Defines multiple keys on the user keyboard by assigning objects to specified keys.

x_{key} is a real number of the form $r:c:p$ specifying the key by its row number r , its column number c , and its plane (shift) p . (For a definition of plane, see the entry for ASN).

The optional initial list parameter or argument S restores all keys without user assignments to their *standard* key assignments on the user keyboard. This is meaningful only when all standard key assignments had been suppressed (for the user keyboard) by the command S DELKEYS.

If the argument *obj* is the name SKEY, the specified key is restored to its *standard key* assignment.

Access:   STOKEYS

Flags: User-Mode Lock (-61) and User Mode (-62) affect the status of the user keyboard

Input/Output:

| Level 1/Argument 1 | Level 1/Item 1 |
|--|----------------|
| { obj ₁ , x _{key 1} , ... obj _n , x _{key n} } | → |
| { S, obj ₁ , x _{key 1} , ... obj _n , x _{key n} } | → |
| 'S' | → |

See also: ASN, DELKEYS, RCLKEYS

STORE

CAS: Store a number in a global variable; given an expression evaluate it and store the numerical value.

STOVX

CAS: Store a name in the current CAS variable.

STO+

Type: Command

Description: Store Plus Command: Adds a number or other object to the contents of a specified variable.

The object on the stack and the object in the variable must be suitable for addition to each other. STO+ can add any combination of objects suitable for addition.

Using STO+ to add two arrays (where *obj* is an array and *name* is the global name of an array) requires less memory than using the stack to add them.

Access:   MEMORY ARITHMETIC STO+ ( is the left-shift of the  key).

Input/Output:

| Level 2/Argument 1 | Level 1/Argument 2 | Level 1/Item 1 |
|--------------------|--------------------|----------------|
| obj | 'name' | → |
| 'name' | obj | → |

See also: STO-, STO*, STO/, +

STO-

Type: Command

Description: Store Minus Command: Calculates the difference between a number (or other object) and the contents of a specified variable, and stores the new value in the specified variable.
 The object on the stack and the object in the variable must be suitable for subtraction with each other. STO- can subtract any combination of objects suitable for stack subtraction.
 Using STO- to subtract two arrays (where *obj* is an array and *name* is the global name of an array) requires less memory than using the stack to subtract them.

Access:  PRG MEMORY ARITHMETIC STO- (PRG is the left-shift of the  key).

Input/Output:

| Level 2/Argument 1 | Level 1/Argument 2 | Level 1/Item 1 |
|--------------------|--------------------|----------------|
| obj | 'name' | → |
| 'name' | obj | → |

See also: STO+, STO*, STO/, -

STO*

Type: Command

Description: Store Times Command: Multiplies the contents of a specified variable by a number or other object.
 The object on the stack and the object in the variable must be suitable for multiplication with each other. When multiplying two arrays, the result depends on the order of the arguments. The new object of the named variable is the level 2 array times the level 1 array. The arrays must be conformable for multiplication.
 Using STO* to multiply two arrays or to multiply a number and an array (where *obj* is an array or a number and *name* is the global name of an array) requires less memory than using the stack to multiply them.

Access:  PRG MEMORY ARITHMETIC STO* (PRG is the left-shift of the  key).

Input/Output:

| Level 2/Argument 1 | Level 1/Argument 2 | Level 1/Item 1 |
|--------------------|--------------------|----------------|
| obj | 'name' | → |
| 'name' | obj | → |

See also: STO+, STO-, STO/, *

STO/

Type: Command

Description: Store Divide Command: Calculates the quotient of a number (or other object) and the contents of a specified variable, and stores the new value in the specified variable.
 The new object of the specified variable is the level 2 object divided by the level 1 object.
 The object on the stack and the object in the variable must be suitable for division with each other. If both objects are arrays, the divisor (level 1) must be a square matrix, and the dividend (level 2) must have the same number of columns as the divisor.
 Using STO/ to divide one array by another array or to divide an array by a number (where *obj* is an array or a number and *name* is the global name of an array) requires less memory than using the stack to divide them.

Access:  PRG MEMORY ARITHMETIC STO/ (PRG is the left-shift of the  key).

Input/Output:

| Level 2/Argument 1 | Level 1/Argument 2 | Level 1/Item 1 |
|--------------------|--------------------|----------------|
| obj | 'name' | → |
| 'name' | obj | → |

See also: STO+, STO-, STO*, /

STOΣ

Type: Command

Description: Store Sigma Command: Stores *obj* in the reserved variable ΣDAT .

STOΣ accepts any object and stores it in ΣDAT . However, if the object is not a matrix or the name of a variable containing a matrix, an Invalid $\Sigma DATA$ error occurs upon subsequent execution of a statistics command.

Access:  CAT STOΣ

Input/Output:

| Level 1/Argument 1 | Level 1/Item 1 |
|--------------------|----------------|
| obj | → |

See also: CLΣ, RCLΣ, Σ+, Σ-

STR→

Type: Command

Description: Evaluate String Command: Evaluates the text of a string as if the text were entered from the command line.

OBJ→ also includes this function.

Access:  CAT STR→

Input/Output:

| Level 1/Argument 1 | Level 1/Item 1 |
|--------------------|--------------------|
| "obj" | → evaluated-object |

See also: ARRAY→, DTAG, EQ→, LIST→, OBJ→, →STR

→STR

Type: Command

Description: Object to String Command: Converts any object to string form.

The full-precision internal form of a number is not necessarily represented in the result string. To ensure that →STR preserves the full precision of a number, select Standard number display format or a wordsize of 64 bits (or both) before executing →STR.

The result string includes the entire object, even if the displayed form of the object is too large to fit in the display.

If the argument object is normally displayed in two or more lines, the result string will contain newline characters (character 10) at the end of each line. The newlines are displayed as the character ↵.

If the argument object is already a string, →STR returns the string.

Access:  CAT →STR

Flags: Binary Integer Wordsize (-5 through -10), Binary Integer Base (-11, -12), Number Display Format (-49, -50)

Input/Output:

| Level 1/Argument 1 | Level 1/Item 1 |
|--------------------|----------------|
| obj | → "obj" |

See also: →ARRAY, →LIST, STR→, →TAG, →UNIT

STREAM

Type: Command

Description: Stream Execution Command: Moves the first two elements from the list onto the stack, and executes *obj*. Then moves the next element (if any) onto the stack, and executes *obj* again using

the previous result and the new element. Repeats this until the list is exhausted, and returns the final result.

STREAM is nominally designed for *obj* to be a program or command that requires two arguments and returns one result.

Access: \leftarrow PRG LIST PROCEDURES STREAM (\leftarrow PRG is the left-shift of the $\boxed{\text{EVAL}}$ key).

Input/Output:

| Level 2/Argument 1 | Level 1/Argument 2 | Level 1/Item 1 |
|--------------------|--------------------|----------------|
| { list } | obj | → result |

See also: DOSUBS

STURM

CAS: For a polynomial P , return a list containing Sturm's sequences of P and their multiplicities.

STURMAB

CAS: For polynomial P and closed interval $[a, b]$, determine the number of zeros P has in $[a, b]$.

STWS

Type: Command

Description: Set Wordsize Command: Sets the current binary integer wordsize to n bits, where n is a value from 1 through 64 (the default is 64).

Values of n less than 1 or greater than 64 are interpreted as 1 or 64, respectively.

If the wordsize is smaller than an integer entered on the command line, then the *most* significant bits are not displayed upon entry. The truncated bits are still present internally (unless they exceed 64), but they are not used for calculations and they are lost when a command uses this binary integer as an argument.

Results that exceed the given wordsize are also truncated to the wordsize.

Access: \leftarrow MTH BASE $\boxed{\text{NXT}}$ STWS (\leftarrow MTH is the left-shift of the $\boxed{\text{SYMB}}$ key).

\rightarrow BASE STWS (\rightarrow BASE is the right-shift of the $\boxed{3}$ key).

Flags: Binary Integer Wordsize (-5 through -10), Binary Integer Base (-11, -12)

Input/Output:

| Level 1/Argument 1 | Level 1/Item 1 |
|--------------------|----------------|
| n | → |
| #n | → |

See also: BIN, DEC, HEX, OCT, RCWS

SUB

Type: Command Operation

Description: Subset Command: Returns the portion of a string or list defined by specified positions, or returns the rectangular portion of a graphics object or *PICT* defined by two corner pixel coordinates.

If $n_{\text{end position}}$ is less than $n_{\text{start position}}$, SUB returns an empty string or list. Values of n less than 1 are treated as 1; values of n exceeding the length of the string or list are treated as that length.

For graphics objects, a user-unit coordinate less than the minimum user-unit coordinate of the graphics object is treated as that minimum. A pixel or user-unit coordinate greater than the maximum pixel or user-unit coordinate of the graphics object is treated as that maximum.

Access: \leftarrow PRG LIST SUB (\leftarrow PRG is the left-shift of the $\boxed{\text{EVAL}}$ key).

Input/Output:

| Level 3/Argument 1 | Level 2/Argument 2 | Level 1/Argument 3 | | Level 1/Item 1 |
|-----------------------------|---------------------------------------|-------------------------------------|---|-----------------------------|
| $[[\text{matrix}]]_t$ | $n_{startposition}$ | $n_{endposition}$ | → | $[[\text{matrix}]]_2$ |
| $[[\text{matrix}]]_t$ | $\{ n_{row}, n_{column} \}$ | $n_{endposition}$ | → | $[[\text{matrix}]]_2$ |
| $[[\text{matrix}]]_t$ | $n_{startposition}$ | $\{ n_{row}, n_{column} \}$ | → | $[[\text{matrix}]]_2$ |
| $[[\text{matrix}]]_t$ | $\{ n_{row}, n_{column} \}$ | $\{ n_{row}, n_{column} \}$ | → | $[[\text{matrix}]]_2$ |
| "string _{target} " | $n_{startposition}$ | $n_{endposition}$ | → | "string _{result} " |
| { list _{target} } | $n_{startposition}$ | $n_{endposition}$ | → | { list _{result} } |
| grob _{target} | { #n ₁ , #m ₁ } | { #n ₂ #m ₂ } | → | grob _{result} |
| grob _{target} | (x ₁ , y ₁) | (x ₂ , y ₂) | → | grob _{result} |
| PICT | { #n ₁ , #m ₁ } | { #n ₂ #m ₂ } | → | grob _{result} |
| PICT | (x ₁ , y ₁) | (x ₂ , y ₂) | → | grob _{result} |

See also: CHR, GOR, GXOR, NUM, POS, REPL, SIZE

SUBST

CAS: Substitute a value for a variable in an expression; the value can be numeric or an expression.

SUBTMOD

CAS: Perform a subtraction, modulo the current modulus.

SVD

Type: Command

Description: Singular Value Decomposition Command: Returns the singular value decomposition of an $m \times n$ matrix.

SVD decomposes A into 2 matrices and a vector. U is an $m \times m$ orthogonal matrix, V is an $n \times n$ orthogonal matrix, and S is a real vector, such that $A = U \times \text{diag}(S) \times V$. S has length $\text{MIN}(m,n)$ and contains the singular values of A in nonincreasing order. The matrix $\text{diag}(S)$ is an $m \times n$ diagonal matrix containing the singular values S .

The computed results should minimize (within computational precision):

$$\frac{|A - U \cdot \text{diag}(S) \cdot V|}{\min(m, n) \cdot |A|}$$

where $\text{diag}(S)$ denotes the $m \times n$ diagonal matrix containing the singular values S .

Access: $\left[\leftarrow \right]$ MATRICES FACTORIZATION SVD ($\left[\leftarrow \right]$ MATRICES is the left-shift of the $\left[5 \right]$ key).

$\left[\leftarrow \right]$ MTH MATRIX FACTORS SVD ($\left[\leftarrow \right]$ MTH is the left-shift of the $\left[\text{SYMB} \right]$ key).

Input/Output:

| Level 1/Argument 1 | | Level 3/Item 1 | Level 2/Item 2 | Level 1/Item 3 |
|--------------------------|---|--------------------------|--------------------------|-----------------------|
| $[[\text{matrix}]]_A$ | → | $[[\text{matrix}]]_U$ | $[[\text{matrix}]]_V$ | $[\text{vector}]_S$ |

See also: DIAG→, MIN, SVL

SVL

Type: Command

Description: Singular Values Command: Returns the singular values of an $m \times n$ matrix.

SVL returns a real vector that contains the singular values of an $m \times n$ matrix in non-increasing order. The vector has length $\text{MIN}(m,n)$.

Access: $\left[\leftarrow \right]$ MATRICES FACTORIZATION $\left[\text{NXT} \right]$ SVL ($\left[\leftarrow \right]$ MATRICES is the left-shift of the $\left[5 \right]$ key).

$\left[\leftarrow \right]$ MTH MATRIX FACTORS $\left[\text{NXT} \right]$ SVL ($\left[\leftarrow \right]$ MTH is the left-shift of the $\left[\text{SYMB} \right]$ key).

Input/Output:

| Level 1/Argument 1 | Level 1/Item 1 |
|-----------------------|---------------------|
| $[[\text{matrix}]]$ | $[\text{vector}]$ |

See also: MIN, SVD

SWAP

Type: RPL Command

Description: Swap Objects Command: Swaps the position of the two inputs.

Access: \leftarrow PRG STACK SWAP (\leftarrow PRG is the left-shift of the $\boxed{\text{EVAL}}$ key).
 \odot in RPN mode executes SWAP when no command line is present.

Input/Output:

| Level 2 | Level 1 | Level 2 | Level 1 |
|----------------|----------------|----------------|----------------|
| obj_1 | obj_2 | obj_2 | obj_1 |

See also: DUP, DUPN, DUP2, OVER, PICK, ROLL, ROLLD, ROT

SYSEVAL

Type: Command

Description: Evaluate System Object Command: Evaluates unnamed operating system objects specified by their memory addresses.

WARNING: Use extreme care when executing this function. Using SYSEVAL with random addresses will almost always cause a memory loss. Do not use this function unless you know what you are doing.

Access: \rightarrow CAT SYSEVAL

Input/Output:

| Level 1/Argument 1 | Level 1/Item 1 |
|------------------------|----------------|
| $\#n_{\text{address}}$ | |

See also: EVAL, LIBEVAL, FLASHEVAL

SYLVESTER

CAS: For symmetric matrix A, return D and P where D is diagonal and $A = P^TDP$.

SYST2MAT

CAS: Convert a system of linear equations in algebraic form to matrix form.

%T

Type: Function

Description: Percent of Total Function: Returns the percent of the first argument that is represented by the second argument.

If both arguments are unit objects, the units must be consistent with each other.

The dimensions of a unit object are dropped from the result, *but units are part of the calculation.*

For more information on using temperature units with arithmetic functions, refer to the entry for +.

Access: \leftarrow MTH REAL %T (\leftarrow MTH is the left-shift of the $\boxed{\text{SYMB}}$ key).

Flags: Numerical Results (-3)

Input/Output:

| Level 2/Argument 1 | Level 1/Argument 2 | | Level 1/Item 1 |
|----------------------|----------------------|---|--|
| x | y | → | 100y/x |
| x | 'symb' | → | '%T(x,symb)' |
| 'symb' | x | → | '%T(symb,x)' |
| 'symb ₁ ' | 'symb ₂ ' | → | '%T(symb ₁ , symb ₂)' |
| x_unit ₁ | y_unit ₂ | → | 100y_unit ₂ /x_unit ₁ |
| x_unit | 'symb' | → | '%T(x_unit,symb)' |
| 'symb' | x_unit | → | '%T(symb,x_unit)' |

See also: +, %, %CH

TABVAL

CAS: Store given expression, and return results of substituting given values in the expression.

TABVAR

CAS: Compute variation table for a function, of the current variable, with a rational derivative.

→TAG

Type: Command

Description: Stack to Tag Command: Combines objects in levels 1 and 2 to create tagged (labeled) object. The “tag” argument is a string of fewer than 256 characters.

Access:  PRG TYPE →TAG (PRG is the left-shift of the  key).

Input/Output:

| Level 2/Argument 1 | Level 1/Argument 2 | | Level 1/Item 1 |
|--------------------|--------------------|---|----------------|
| obj | “tag” | → | .tag:obj |
| obj | 'name' | → | .name:obj |
| obj | x | → | .x:obj |

See also: →ARRAY, DTAG, →LIST, OBJ→, →STR, →UNIT

TAIL

Type: Command

Description: Last Listed Elements Command: Returns all but the first element of a list or string.

Access:  PRG  CHARS  TAIL (PRG is the left-shift of the  key).

Input/Output:

| Level 1/Argument 1 | | Level 1/Item 1 |
|---|---|---|
| { obj ₁ ... obj _n } | → | { obj ₂ ... obj _n } |
| “string ₁ ” | → | “string ₂ ” |

See also: HEAD

TAN

Type: Analytic function

Description: Tangent Analytic Function: Returns the tangent of the argument.

For real arguments, the current angle mode determines the number's interpretation as an angle, unless the angular units are specified.

For a real argument that is an odd-integer multiple of 90 in Degrees mode, an Infinite Result exception occurs. If flag -22 is set (no error), the sign of the result (MAXR) matches that of the argument.

For complex arguments:

$$\tan(x + iy) = \frac{(\sin x)(\cos x) + i(\sinh y)(\cosh y)}{\sinh^2 y + \cos^2 x}$$

If the argument for TAN is a unit object, then the specified angular unit overrides the angle mode to determine the result. Integration and differentiation, on the other hand, always observe the angle mode. Therefore, to correctly integrate or differentiate expressions containing TAN with a unit object, the angle mode must be set to Radians (since this is a “neutral” mode).

Access: TAN

Flags: Numerical Results (-3), Angle Mode (-17, -18), Infinite Result Exception (-22)

Input/Output:

| Level 1/Argument 1 | → | Level 1/Item 1 |
|---------------------------------|---|---------------------------------------|
| <i>z</i> | → | <i>tan z</i> |
| 'symb' | → | 'TAN(symb)' |
| <i>x_unit_{angular}</i> | | <i>tan (x_unit_{angular})</i> |

See also: ATAN, COS, SIN

TAN2CS2

CAS: Replace tan(*x*) terms in expressions with (1-cos(2*x*))/sin(2*x*) terms.

TAN2SC

CAS: Replace tan(*x*) terms in expressions with sin(*x*)/cos(*x*).

TAN2SC2

CAS: Replace tan(*x*) terms in expressions with sin(2*x*)/1+cos(2*x*) terms.

TANH

Type: Analytic function

Description: Hyperbolic Tangent Analytic Function: Returns the hyperbolic tangent of the argument.
For complex arguments,

$$\tanh(x + iy) = \frac{\sinh 2x + i \sin 2y}{\cosh 2x + \cos 2y}$$

Access: ↵ TRIG HYPERBOLIC TANH (TRIG is the right-shift of the 8 key).

← MTH HYPERBOLIC TANH (MTH is the left-shift of the SYMB key).

Flags: Numerical Results (-3)

Input/Output:

| Level 1/Argument 1 | → | Level 1/Item 1 |
|--------------------|---|----------------|
| <i>z</i> | → | <i>tanh z</i> |
| 'symb' | → | 'TANH(symb)' |

See also: ATANH, COSH, SINH

TAYLOR0

CAS: Perform a fourth-order Taylor expansion of an expression at *x* = 0.

TAYLR

Type: Command

Description: Taylor Polynomial Command: Calculates the *n*th order Taylor polynomial of *symb* in the variable *global*.

The polynomial is calculated at the point $global = 0$. The expression $symb$ may have a removable singularity at 0. The order, n , is the *relative* order of the Taylor polynomial—the difference in order between the largest and smallest power of $global$ in the polynomial.

TAYLR always returns a symbolic result, regardless of the state of the Numeric Results flag (-3).

Access: \leftarrow CALC LIMITS & SERIES TAYLR (CALC is the left-shift of the $\boxed{4}$ key).

Input/Output:

| Level 3/Argument 1 | Level 2/Argument 2 | Level 1/Argument 3 | Level 1/Item 1 |
|--------------------|--------------------|--------------------|---|
| 'symb' | 'global' | n_{order} | \rightarrow 'symb _{Taylor} ' |

See also: ∂, \int, Σ

TCHEBYCHEFF

CAS: Return the nth Tchebycheff polynomial.

TCOLLECT

CAS: Linearize products in trig expression by collecting and combining sine and cosine terms.

TDELTA

Type: Function

Description: Temperature Delta Function: Calculates a temperature change.

TDELTA subtracts two points on a temperature scale, yielding a temperature *increment* (not an actual temperature). x or x_unit1 is the final temperature, and y or y_unit2 is the initial temperature. If unit objects are given, the increment is returned as a unit object with the same units as x_unit1 . If real numbers are given, the increment is returned as a real number.

Access: \leftarrow CAT TDELTA

Flags: Numerical Results (-3)

Input/Output:

| Level 2/Argument 1 | Level 1/Argument 2 | Level 1/Item 1 |
|----------------------|----------------------|--|
| x | y | \rightarrow x_{delta} |
| x_unit1 | x_unit2 | \rightarrow x_unit1_{delta} |
| x_unit | 'symb' | \rightarrow 'TDELTA(x_unit , symb)' |
| 'symb' | y_unit | \rightarrow 'TDELTA(symb, y_unit)' |
| 'symb ₁ ' | 'symb ₂ ' | \rightarrow 'TDELTA(symb ₁ , symb ₂)' |

See also: TINC

TESTS

CAS: Display menu or list with tests that work in algebraic expressions, and ASSUME and UNASSUME.

TEVAL

Type: Function

Description: For the specified operation, performs the same function as EVAL, and returns the time taken to perform the evaluation as well as the result.

Access: \leftarrow CAT TEVAL

Input/Output:

| Level 1/Argument 1 | Level 2/Item 2 | Level 1/Item 1 |
|--------------------|----------------------|----------------|
| Object | \rightarrow result | time taken |

See also: EVAL

TEXPAND

CAS: Expand transcendental functions in an expression.

TEXT

Type: Command

Description: Show Stack Display Command: Displays the stack display.

TEXT switches from the graphics display to the stack display. TEXT does not update the stack display.

Access:  PRG  OUT TEXT (PRG is the left-shift of the  key).

Input/Output: None

See also: PICTURE, PVIEW

THEN

Type: Command

Description: THEN Command: Starts the true-clause in conditional or error-trapping structure.

See the IF and IFFER entries for more information.

Access:  PRG BRANCH IF/CASE THEN (PRG is the left-shift of the  key).

Input/Output: None

See also: CASE, ELSE, END, IF IFERR

TICKS

Type: Command

Description: Ticks Command: Returns the system time as a binary integer, in units of 1/8192 second.

Access:  TIME TOOLS TICKS ( TIME is the right-shift of the  key).

Input/Output:

| Level 1/Argument 1 | Level 1/Item 1 |
|--------------------|----------------|
| | → #ntime |

Example: If the result from a previous invocation from TICKS is on level 1 of the stack, then the command: TICKS SWAP - B→R 8192 / returns a real number whose value is the elapsed time in seconds between the two invocations.

See also: TIME

TIME

Type: Command

Description: Time Command: Returns the system time in the form HH.MMSSs.

time has the form *HH.MMSSs*, where *HH* is hours, *MM* is minutes, *SS* is seconds, and *s* is zero or more digits (as many as allowed by the current display mode) representing fractional seconds.

time is always returned in 24-hour format, regardless of the state of the Clock Format flag (-41).

Access:  TIME TOOLS TIME ( TIME is the right-shift of the  key).

Input/Output:

| Level 1/Argument 1 | Level 1/Item 1 |
|--------------------|----------------|
| | → time |

See also: DATE, TICKS, TSTR

→TIME

Type: Command

Description: Set System Time Command: Sets the system time.

time must have the form *HH.MMSSs*, where *HH* is hours, *MM* is minutes, *SS* is seconds, and *s* is zero or more digits (as many as allowed by the current display mode) representing fractional seconds. *time* must use 24-hour format.

Access: $\boxed{\rightarrow}$ TIME TOOLS \rightarrow TIME (TIME is the right-shift of the $\boxed{9}$ key).

Input/Output:

| Level 1/Argument 1 | Level 1/Item 1 |
|--------------------|----------------|
| time | \rightarrow |

See also: CLKADJ, \rightarrow DATE

TINC

Type: Function

Description: Temperature Increment Command: Calculates a temperature increment.

TINC adds a temperature *increment* (not an actual temperature) to a point on a temperature scale. Use a negative increment to subtract the increment from the temperature. $x_{initial}$ or x_{unit1} is the initial temperature, and y_{delta} or $y_{unit2_{delta}}$ is the temperature increment. The returned temperature is the resulting final temperature. If unit objects are given, the final temperature is returned as a unit object with the same units as x_{unit1} . If real numbers are given, the final temperature is returned as a real number.

Access: $\boxed{\rightarrow}$ CAT TINC

Flags: Numerical Results (-3)

Input/Output:

| Level 2/Argument 1 | Level 1/Argument 2 | Level 1/Item 1 |
|----------------------|----------------------|--|
| $x_{initial}$ | y_{delta} | \rightarrow x_{final} |
| x_unit1 | $y_{unit2_{delta}}$ | \rightarrow $x_{unit1_{final}}$ |
| x_unit | 'symb' | \rightarrow 'TINC(x_unit, symb)' |
| 'symb' | $y_{unit_{delta}}$ | \rightarrow 'TINC(symb, $y_{unit_{delta}}$)' |
| 'symb ₁ ' | 'symb ₂ ' | \rightarrow 'TINC(symb ₁ , symb ₂)' |

See also: TDELTA

TLIN

CAS: Linearize and simplify trig expression but do not collect sine and cosine terms of the same angle.

TLINE

Type: Command

Description: Toggle Line Command: For each pixel along the line in *PICT* defined by the specified coordinates, TLINE turns off every pixel that is on, and turns on every pixel that is off.

Access: $\boxed{\leftarrow}$ PRG $\boxed{\text{NXT}}$ PICT TLINE (PRG is the left-shift of the $\boxed{\text{EVAL}}$ key).

Input/Output:

| Level 2/Argument 1 | Level 1/Argument 2 | Level 1/Item 1 |
|-------------------------------------|-------------------------------------|----------------|
| (x_1, y_1) | (x_2, y_2) | \rightarrow |
| { #n ₁ #m ₁ } | { #n ₂ #m ₂ } | \rightarrow |

See also: ARC, BOX, LINE

TMENU

Type: Command

Description: Temporary Menu Command: Displays a built-in menu, library menu, or user-defined menu. TMENU works just like MENU, except for user-defined menus (specified by a list or by the name of a variable that contains a list). Such menus are displayed like a custom menu and work like a custom menu, but are not stored in reserved variable *CST*. Thus, a menu defined and displayed by TMENU cannot be redisplayed by evaluating *CST*.

See Appendix H for a list of the hp49g+ /hp48gII built-in menus and the corresponding menu numbers (x_{menu}).

Access: \leftarrow & (MODE) MENU TMENU

Input/Output:

| Level 1/Argument 1 | | Level 1/Item 1 |
|--------------------------------|---|----------------|
| x_{menu} | → | |
| { list _{definition} } | → | |
| 'name _{definition} ' | → | |

See also: MENU, RCLMENU

TOT

Type: Command

Description: Total Command: Computes the sum of each of the m columns of coordinate values in the current statistics matrix (reserved variable ΣDAT).

The sums are returned as a vector of m real numbers, or as a single real number if $m = 1$.

Access: \leftarrow CAT TOT

Input/Output:

| Level 1/Argument 1 | | Level 1/Item 1 |
|--------------------|---|--|
| | → | x_{sum} |
| | → | $[x_{\text{sum } 1}, x_{\text{sum } 2}, \dots, x_{\text{sum } m}]$ |

See also: MAX Σ , MIN Σ , MEAN, PSDEV, PVAR, SDEV, VAR

TRACE

Type: Command

Description: Matrix Trace Command: Returns the trace of a square matrix.

The trace of a square matrix is the sum of its diagonal elements.

Access: \leftarrow MATRICES OPERATIONS (NXT) (NXT) TRACE (MATRICES is the left-shift of the (5) key).

\leftarrow MTH MATRIX NORMALIZE (NXT) TRACE (MTH is the left-shift of the (SYMB) key).

Input/Output:

| Level 1/Argument 1 | | Level 1/Item 1 |
|------------------------------------|---|--------------------|
| $[[\text{matrix}]]_{n \times n}$ | → | x_{trace} |

See also: CONJ, DET, IDN

TRAN

Type: Command

Description: Transpose Matrix Command: Returns the transpose of a matrix.

Same as TRN, but without conjugation of complex numbers.

Access: \leftarrow MATRICES OPERATIONS (NXT) (NXT) TRAN (MATRICES is the left-shift of the (5) key).

Input/Output:

| Level 1/Argument 1 | | Level 1/Item 1 |
|-----------------------|---|--|
| $[[\text{matrix}]]$ | → | $[[\text{matrix}]]_{\text{transpose}}$ |
| 'name' | → | |

See also: CONJ, TRN



TRANSIO

Type: Command

Description: I/O Translation Command: Specifies the character translation option. These translations affect only ASCII Kermit transfers and files printed to the serial port.

Legal values for n are as follows:

| n | Effect |
|----------|---|
| 0 | No translation |
| 1 | Translate character 10 (line feed only) to /from characters 10 and 13 (line feed with carriage return, the Kermit protocol) (the default value) |
| 2 | Translate characters 128 through 159 (80 through 9F hexadecimal) |
| 3 | Translate all characters (128 through 255) |

Access:   TRANSIO

Input/Output:

| Level 1/Argument 1 | Level 1/Item 1 |
|--------------------|----------------|
| n option | → |

See also: BAUD, CKSM, PARITY

TRIG

CAS: Convert complex log and exponential terms into equivalent trig terms, also simplify trig terms.

TRIGCOS

CAS: Simplify trig terms by applying $(\sin x)^2 + (\cos x)^2 = 1$, return only cosine terms if possible.

TRIGO

CAS: Display menu or list containing the CAS commands for transforming trigonometric expressions.

TRIGSIN

CAS: Simplify trig terms by applying $(\sin x)^2 + (\cos x)^2 = 1$, return only sine terms if possible.

TRIGTAN

CAS: Replace sine and cosine terms in a trigonometric expression with tan terms.

TRN

Type: Command

Description: Transpose Matrix Command: Returns the (conjugate) transpose of a matrix.

TRN replaces an $n \times m$ matrix A with an $m \times n$ matrix A^T , where:

$A_{ij}^T = A_{ji}$ for real matrices and $A_{ij}^T = \text{CONJ}(A_{ji})$ for complex matrices

If the matrix is specified by *name*, A^T replaces A in *name*.

Access:   MATRIX MAKE TRN ( is the left-shift of the  key).

Input/Output:

| Level 1/Argument 1 | Level 1/Item 1 |
|-----------------------|--|
| $[[\text{matrix}]]$ | → $[[\text{matrix}]]$ _{transpose} |
| 'name' | → |

See also: CONJ, TRAN

TRNC

Type: Function

Description: Truncate Function: Truncates an object to a specified number of decimal places or significant digits, or to fit the current display format.

n_{truncate} (or $\text{symb}_{\text{truncate}}$ if flag -3 is set) controls how the level 2 argument is truncated, as follows:

| n_{truncate} | Effect on Level 2 Argument |
|-----------------------|---|
| 0 through 11 | truncated to n decimal places |
| -1 through -11 | truncated to n significant digits |
| 12 | truncated to the current display format |

For complex numbers and arrays, each real number element is truncated. For unit objects, the number part of the object is truncated.

Access: \leftarrow MTH REAL \leftarrow TRNC (\leftarrow is the left-shift of the SYMB key).

Flags: Numerical Results (-3)

Input/Output:

| Level 2/Argument 1 | Level 1/Argument 2 | | Level 1/Item 1 |
|----------------------|----------------------------|---------------|--|
| z_1 | n_{truncate} | \rightarrow | z_2 |
| z_1 | 'symb' _{truncate} | \rightarrow | 'TRNC(z_1 ,symb' _{truncate})' |
| 'symb' ₁ | n_{truncate} | \rightarrow | 'TRNC(symb' ₁ , n_{truncate})' |
| 'symb' ₁ | 'symb' _{truncate} | \rightarrow | 'TRNC(symb' ₁ ,symb' _{truncate})' |
| [array] ₁ | n_{truncate} | \rightarrow | [array] ₂ |
| x_unit | n_{truncate} | \rightarrow | y_unit |
| x_unit | 'symb' _{truncate} | \rightarrow | 'TRNC(x_unit,symb' _{truncate})' |

See also: RND

TRUNC

CAS: Truncate a series expansion, performing the expansion, or using a given polynomial.

TRUTH

Type: Command

Description: Truth Plot Type Command: Sets the plot type to TRUTH.

When the plot type is TRUTH, the DRAW command plots the current equation as a truth-valued function of two real variables. The current equation is specified in the reserved variable EQ . The plotting parameters are specified in the reserved variable $PPAR$, which has this form:

$$\{ (x_{\min}, y_{\min}) (x_{\max}, y_{\max}) \text{ indep res axes ptype depend} \}$$

For plot type TRUTH, the elements of $PPAR$ are used as follows:

- (x_{\min}, y_{\min}) is a complex number specifying the lower left corner of $PICT$ (the lower left corner of the display range). The default value is $(-6.5, -3.1)$ for the hp48gII and $(-6.5, -3.9)$ for the hp49g+.
- (x_{\max}, y_{\max}) is a complex number specifying the upper right corner of $PICT$ (the upper right corner of the display range). The default value is $(6.5, 3.2)$ for the hp48gII and $(6.5, 4.0)$ for the hp49g+.
- *indep* is a name specifying the independent variable on the horizontal axis, or a list containing such a name and two numbers specifying the minimum and maximum values for the independent variable (the horizontal plotting range). The default value is X .
- *res* is a real number specifying the interval (in user-unit coordinates) between plotted values of the independent variable on the *horizontal* axis, or a binary integer specifying that interval in pixels. The default value is 0, which specifies an interval of 1 pixel.
- *axes* is a list containing one or more of the following, in the order listed: a complex number specifying the user-unit coordinates of the plot origin, a list specifying the tick-mark annotation, and two strings specifying labels for the horizontal and vertical axes. The default value is $(0, 0)$.

- *p_{type}* is a command name specifying the plot type. Executing the command TRUTH places the name TRUTH in *p_{type}*.
- *depend* is a name specifying the independent variable on the vertical axis, or a list containing such a name and two numbers specifying the minimum and maximum values for the independent variable on the vertical axis (the vertical plotting range). The default value is *Y*. The contents of *EQ* must be an expression or program, and cannot be an equation. It is evaluated for each pixel in the plot region. The minimum and maximum values of the independent variables (the plotting ranges) can be specified in *indep* and *depend*; otherwise, the values in (*x_{min}*, *y_{min}*) and (*x_{max}*, *y_{max}*) (the display range) are used. The result of each evaluation must be a real number. If the result is zero, the state of the pixel is unchanged. If the result is nonzero, the pixel is turned on (made dark).

Access: CAT TRUTH

Input/Output: None

See also: BAR, CONIC, DIFFEQ, FUNCTION, GRIDMAP, HISTOGRAM, PARAMETRIC, PARSURFACE, PCONTOUR, POLAR, SCATTER, SLOPEFIELD, WIREFRAME, YSLICE

TSIMP

CAS: Simplify expressions involving exponentials and logs, convert base 10 logs to natural logs.

TSTR

Type: Command

Description: Date and Time String Command: Returns a string derived from the date and time. The string has the form "DOW DATE TIME", where DOW is a three-letter abbreviation of the day of the week corresponding to the argument *date* and *time*, DATE is the argument *date* in the current date format, and TIME is the argument *time* in the current time format.

Access: TIME TOOLS TSTR (TIME is the right-shift of the key).

Flags: Time Format (-41), Date Format (-42)

Input/Output:

| Level 2/Argument 1 | Level 1/Argument 2 | Level 1/Item 1 |
|--------------------|--------------------|-------------------|
| date | time | → "DOW DATE TIME" |

See also: DATE, TICKS, TIME

TVARS

Type: Command

Description: Typed Variables Command: Lists all global variables in the current directory that contain objects of the specified types.

If the current directory contains no variables of the specified types, TVARS returns an empty list. For a table of the object-type numbers, see the entry for TYPE.

Access: PRG MEMORY DIRECTORY TVARS (PRG is the left-shift of the key).

Input/Output:

| Level 1/Argument 1 | Level 1/Item 1 |
|---------------------------------|------------------|
| <i>n_{type}</i> | → { global ... } |
| { <i>n_{type}</i> ... } | → { global ... } |

See also: PVAR, TYPE, VARS

TVM

Type: Command

Description: TVM Menu Command: Displays the TVM Solver menu.

Access: CAT TVM

Input/Output: None

See also: AMORT, TVMBEG, TVMEND, TVMROOT

TVMBEG

Type: Command

Description: Payment at Start of Period Command: Specifies that TVM calculations treat payments as being made at the beginning of the compounding periods.

Access:  CAT TVMBEG

Input/Output: None

See also: AMORT, TVM, TVMEND, TVMROOT

TVMEND

Type: Command

Description: Payment at End of Period Command: Specifies that TVM calculations treat payments as being made at the end of the compounding periods.

Access:  CAT TVMEND

Input/Output: None

See also: AMORT, TVM, TVMBEG, TVMROOT

TVMROOT

Type: Command

Description: TVM Root Command: Solves for the specified TVM variable using values from the remaining TVM variables.

Access:  CAT TVMROOT

Input/Output:

| Level 1/Argument 1 | | Level 1/Item 1 |
|--------------------|---|-----------------------|
| 'TVM variable' | → | <i>X</i> TVM variable |

See also: AMORT, TVM, TVMBEG, TVMEND

TYPE

Type: Command

Description: Type Command: Returns the type number of an object, as shown in the following table:

| Object Type: | Number: |
|----------------------|---------|
| User objects: | |
| Real number | 0 |
| Complex number | 1 |
| Character string | 2 |
| Real array | 3 |
| Complex array | 4 |
| List | 5 |
| Global name | 6 |
| Local name | 7 |
| Program | 8 |
| Algebraic object | 9 |
| Binary integer | 10 |
| Graphics object | 11 |
| Tagged object | 12 |
| XLIB name | 14 |
| Library | 16 |
| Backup object | 17 |

| Object Type: | Number: |
|---------------------------|---------|
| Real integer | 28 |
| Font | 30 |
| Built-in Commands: | |
| Built-in function | 18 |
| Built-in command | 19 |
| System Objects: | |
| System binary | 20 |
| Extended real | 21 |
| Extended complex | 22 |
| Linked array | 23 |
| Character | 24 |
| Code object | 25 |
| Library data | 26 |
| Mini font | 27 |
| Symbolic vector/matrix | 29 |
| Extended object | 31 |

Access: \leftarrow PRG TEST \rightarrow TYPE (\leftarrow PRG is the left-shift of the \rightarrow key).

Input/Output:

| Level 1/Argument 1 | Level 1/Item 1 |
|--------------------|-------------------------------|
| obj | \rightarrow Ω_{type} |

See also: SAME, TVARS, VTYPE, ==

UBASE

Type: Function

Description: Convert to SI Base Units Function: Converts a unit object to SI base units.

Access: \leftarrow CONVERT UNITS TOOLS UBASE (\leftarrow CONVERT is the left-shift of the \rightarrow key).

Flags: Numerical Results (-3)

Input/Output:

| Level 1/Argument 1 | Level 1/Item 1 |
|--------------------|-----------------------------|
| x_unit | \rightarrow y_base-units |
| 'symb' | \rightarrow 'UBASE(symb)' |

See also: CONVERT, UFACT, \rightarrow UNIT, UVAL

UFACT

Type: Command

Description: Factor Unit Command: Factors the level 1 unit from the unit expression of the level 2 unit object.

Access: \leftarrow CONVERT UNITS TOOLS UFACT (\leftarrow CONVERT is the left-shift of the \rightarrow key).

Input/Output:

| Level 2/Argument 1 | Level 1/Argument 2 | Level 1/Item 1 |
|--------------------|--------------------|--------------------------------------|
| $x_1_unit_1$ | $x_2_unit_2$ | \rightarrow $x_3_unit_2 * unit_3$ |

See also: CONVERT, UBASE, →UNIT, UVAL

UFL1→MINIF

Type: Command

Description: Converts a UFL1 (universal font library) fontset to an hp49g+/hp48gII minifont. You specify the fontset and give it an ID (0–255). The font must be a 6-by-4 font.

Access: $\boxed{\rightarrow}$ $\underline{\text{CAT}}$ UFL1→MINIF

Input/Output:

| Level 2/Argument 1 | Level 1/Argument 2 | Level 1/Item 1 |
|------------------------|--------------------|-----------------------------------|
| obj_{fontset} | n_{ID} | → The font converted to minifont. |

See also: →MINIFONT, MINIFONT→

UNASSIGN

CAS: Remove global variables and return their values; an algebraic version of PURGE.

UNASSUME

CAS: Cancel assumptions on global variables, removing variable names from REALASSUME list.

UNBIND

CAS: Remove all local variables created by the LOCAL command, and return their values.

→UNIT

Type: Command

Description: Stack to Unit Object Command: Creates a unit object from a real number and the unit part of a unit object. →UNIT adds units to a real number, combining the number and the unit part of a unit object (the numerical part of the unit object is ignored). →UNIT is the reverse of OBJ→ applied to a unit object.

Access: $\boxed{\rightarrow}$ $\underline{\text{CAT}}$ →UNIT

Input/Output:

| Level 2/Argument 1 | Level 1/Argument 2 | Level 1/Item 1 |
|--------------------|--------------------|---------------------|
| x | y_{unit} | → x_{unit} |

See also: →ARRAY, →LIST, →STR, →TAG

UNPICK

Type: RPL Command

Description: Replaces the object at level $n+2$ with the object at level 2 and deletes the objects at levels 1 and 2.

Access: $\boxed{\leftarrow}$ $\underline{\text{PRG}}$ STACK $\boxed{\text{NXT}}$ UNPICK ($\underline{\text{PRG}}$ is the left-shift of the $\boxed{\text{EVAL}}$ key).

Input/Output:

| | | | | | | | | |
|-----------|-------------|---------|-------|-------|---|-------|-------------|---------|
| L_{n+2} | L_{n+1} | L_3 | L_2 | L_1 | | L_n | L_{n-1} | L_1 |
| obj_n | obj_{n-1} | obj_l | obj | n | → | obj | obj_{n-1} | obj_l |

See also: OVER, PICK, ROLL, ROLLD, SWAP, ROT

UNROT

Type: RPL Command

Description: Changes the order of the first three objects on the stack. The order of the change is the opposite to that of the ROT command.

Access: $\boxed{\leftarrow}$ $\underline{\text{PRG}}$ STACK UNROT ($\underline{\text{PRG}}$ is the left-shift of the $\boxed{\text{EVAL}}$ key).

Input/Output:

| | | | | | | |
|------------------|------------------|------------------|---|------------------|------------------|------------------|
| L ₃ | L ₂ | L ₁ | | L ₃ | L ₂ | L ₁ |
| obj ₃ | obj ₂ | obj ₁ | → | obj ₁ | obj ₃ | obj ₂ |

See also: OVER, PICK, ROLL, ROLLD, SWAP, ROT

UNTIL

Type: Command

Description: UNTIL Command: Starts the test clause in a DO ... UNTIL ... END indefinite loop structure. See the DO entry for more information.

Access: \leftarrow PRG BRANCH DO UNTIL (PRG is the left-shift of the EVAL key).

Input/Output: None

See also: DO, END

UPDIR

Type: Command

Description: Up Directory Command: Makes the parent of the current directory the new current directory. UPDIR has no effect if the current directory is HOME.

Access: \leftarrow UPDIR (UPDIR is the left-shift of the VAR key).

Input/Output: None

See also: CRDIR, HOME, PATH, PGDIR

UTPC

Type: Command

Description: Upper Chi-Square Distribution Command: Returns the probability utpc(n, x) that a chi-square random variable is greater than x, where n is the number of degrees of freedom of the distribution.

The defining equations are these:

- For x ≥ 0:

$$utpc(n, x) = \left[\frac{1}{2^{\frac{n}{2}} \Gamma(\frac{n}{2})} \int_x^{\infty} t^{\frac{n}{2}-1} \cdot e^{-\frac{t}{2}} dt \right]$$

- For x < 0:

$$utpc(n, x) = 1$$

For any value z, $\Gamma(\frac{z}{2}) = (\frac{z}{2} - 1)!$, where ! is the factorial command.

The value n is rounded to the nearest integer and, when rounded, must be positive.

Access: \leftarrow MTH $\left[\text{NXT} \right]$ PROBABILITY $\left[\text{NXT} \right]$ UTPC (MTH is the left-shift of the SYMB key).

Input/Output:

| Level 2/Argument 1 | Level 1/Argument 2 | | Level 1/Item 1 |
|--------------------|--------------------|---|----------------|
| n | x | → | utpc(n,x) |

See also: UTPF, UTPN, UTPT

UTPF

Type: Command

Description: Upper Snedecor's F Distribution Command: Returns the probability $utpf(n_1, n_2, x)$ that a Snedecor's F random variable is greater than x , where n_1 and n_2 are the numerator and denominator degrees of freedom of the F distribution.

The defining equations for $utpf(n_1, n_2, x)$ are these:

- For $x \geq 0$:

$$\left(\frac{n_1}{n_2}\right)^{\frac{n_1}{2}} \frac{\Gamma\left(\frac{n_1+n_2}{2}\right)}{\Gamma\left(\frac{n_1}{2}\right)\Gamma\left(\frac{n_2}{2}\right)} \int_x^{\infty} t^{\frac{n_1-2}{2}} \left[1 + \left(\frac{n_1}{n_2}\right)t\right]^{-\frac{(n_1+n_2)}{2}} dt$$

- For $x < 0$:

$$utpf(n_1, n_2, x) = 1$$

For any value z , $\Gamma\left(\frac{z}{2}\right) = \left(\frac{z}{2} - 1\right)!$, where ! is the hp49g+/hp48gII factorial command.

The values n_1 and n_2 are rounded to the nearest integers and, when rounded, must be positive.

Access: $\left[\leftarrow\right]$ $\left[\text{MTH}\right]$ $\left[\text{NXT}\right]$ PROBABILITY $\left[\text{NXT}\right]$ UTPF ($\left[\leftarrow\right]$ is the left-shift of the $\left[\text{SYMB}\right]$ key).

Input/Output:

| Level 3/Argument 1 | Level 2/Argument 2 | Level 1/Argument 3 | Level 1/Item 1 |
|--------------------|--------------------|--------------------|-----------------------------------|
| n_1 | n_2 | x | \rightarrow $utpf(n_1, n_2, x)$ |

See also: UTPC, UTPN, UTPT

UTPN

Type: Command

Description: Upper Normal Distribution Command: Returns the probability $utpn(m, v, x)$ that a normal random variable is greater than x , where m and v are the mean and variance, respectively, of the normal distribution.

For all x and m , and for $v > 0$, the defining equation is this:

$$utpn(m, v, x) = \left[\frac{1}{\sqrt{2\pi v}}\right] \int_x^{\infty} e^{-\frac{(t-m)^2}{2v}} dt$$

For $v = 0$, UTPN returns 0 for $x \geq m$, and 1 for $x < m$.

Access: $\left[\leftarrow\right]$ $\left[\text{MTH}\right]$ $\left[\text{NXT}\right]$ PROBABILITY $\left[\text{NXT}\right]$ UTPN ($\left[\leftarrow\right]$ is the left-shift of the $\left[\text{SYMB}\right]$ key).

Input/Output:

| Level 3/Argument 1 | Level 2/Argument 2 | Level 1/Argument 3 | Level 1/Item 1 |
|--------------------|--------------------|--------------------|-------------------------------|
| m | v | x | \rightarrow $utpn(m, v, x)$ |

See also: UTPC, UTPF, UTPT

UTPT

Type: Command

Description: Upper Student's t Distribution Command: Returns the probability $utpt(n, x)$ that a Student's t random variable is greater than x , where n is the number of degrees of freedom of the distribution.

The following is the defining equation for all x :

$$utpt(n, x) = \frac{\Gamma\left(\frac{n+1}{2}\right)}{\Gamma\left(\frac{n}{2}\right)\sqrt{n\pi}} \int_x^{\infty} \left(1 + \frac{t^2}{n}\right)^{-\frac{n+1}{2}} dt$$

For any value z , $\Gamma\left(\frac{z}{2}\right) = \left(\frac{z}{2} - 1\right)!$, where ! is the factorial command.

The value n is rounded to the nearest integer and, when rounded, must be positive.

Access: $\left[\leftarrow\right]$ MTH $\left[\text{NXT}\right]$ PROBABILITY $\left[\text{NXT}\right]$ UTPT ($\left[\leftarrow\right]$ MTH is the left-shift of the $\left[\text{SYMB}\right]$ key).

Input/Output:

| Level 2/Argument 1 | Level 1/Argument 2 | Level 1/Item 1 |
|--------------------|--------------------|----------------|
| n | x | → utpt(n,x) |

See also: UTPC, UTPF, UTPN

UVAL

Type: Function

Description: Unit Value Function: Returns the numerical part of a unit object.

Access: $\left[\rightarrow\right]$ UNITS TOOLS UVAL ($\left[\leftarrow\right]$ UNITS is the right-shift of the $\left[6\right]$ key).

Flags: Numerical Results (-3)

Input/Output:

| Level 1/Argument 1 | Level 1/Item 1 |
|--------------------|----------------|
| x_unit | → x |
| 'symb' | → 'UVAL(symb)' |

See also: CONVERT, UBASE, UFACT, →UNIT

V→

Type: Command

Description: Vector/Complex Number to Stack Command: Separates a vector or complex number into its component elements.

For vectors with four or more elements, V→ executes *independently* of the coordinate system mode, and always returns the elements of the vector to the stack as they are stored internally (in rectangular form). Thus, V→ is equivalent to OBJ→ for vectors with four or more elements.

Access: $\left[\leftarrow\right]$ MTH VECTOR V→ ($\left[\leftarrow\right]$ MTH is the left-shift of the $\left[\text{SYMB}\right]$ key).

Flags: Coordinate System (-15 and -16)

Input/Output:

| L ₁ /A ₁ | | L _n /I ₁ ... L ₃ /I _{n-2} | L ₂ /I _{n-1} | L ₁ /I _n |
|---|---|---|----------------------------------|--------------------------------|
| $[x\ y]$ | → | | x | y |
| $[x_r, \angle y_{theta}]$ | → | | x _r | y _{theta} |
| $[x_1, x_2, x_3]$ | → | x ₁ | x ₂ | x ₃ |
| $[x_1, \angle x_{theta}, x_{\zeta}]$ | → | x ₁ | x _{theta} | x _ζ |
| $[x_1, \angle x_{theta}, \angle x_{phi}]$ | → | x ₁ | x _{theta} | x _{phi} |
| $[x_1, x_2, \dots, x_n]$ | → | x ₁ ... x _{n-2} | x _{n-1} | x _n |
| (x, y) | → | | x | y |
| $(x_r, \angle y_{theta})$ | → | | x _r | y _{theta} |

L = Level; A = Argument; I = item

See also: →V2, →V3

→V2

Type: Command

Description: Stack to Vector/Complex Number Command: Converts two specified numbers into a 2-element vector or a complex number.

The result returned depends on the setting of flags -16 and -19, as shown in the following table:

| | Flag -19 clear | Flag -19 set |
|-----------------------------------|----------------|-----------------|
| Flag -16 clear (Rectangular mode) | $[x\ y]$ | (x, y) |
| Flag -16 set (Polar mode) | $[x \angle y]$ | $(x, \angle y)$ |

Access: \leftarrow $\overline{\text{MTH}}$ VECTOR →V2 ($\overline{\text{MTH}}$ is the left-shift of the $\overline{\text{SYMB}}$ key).

Flags: Coordinate System (-16), Complex Mode (-19)

Input/Output:

| Level 2/Argument 1 | Level 1/Argument 2 | | Level 1/Item 1 |
|--------------------|--------------------|---|-----------------|
| x | y | → | $[x\ y]$ |
| x | y | → | $[x \angle y]$ |
| x | y | → | (x, y) |
| x | y | → | $(x, \angle y)$ |

See also: $V \rightarrow, \rightarrow V3$

→V3

Type: Command

Description: Stack to 3-Element Vector Command: Converts three numbers into a 3-element vector.

The result returned depends on the coordinate mode used, as shown in the following table:

| Mode | Result |
|--|---|
| Rectangular (flag -16 clear) | $[X_1\ X_2\ X_3]$ |
| Polar/Cylindrical (flag -15 clear and -16 set) | $[X_1\ X_2 \angle_{\text{theta}}\ X_3]$ |
| Polar/Spherical (flag -15 and -16 set) | $[X_1\ X_2 \angle_{\text{theta}}\ X_3 \angle_{\text{phi}}]$ |

Access: \leftarrow $\overline{\text{MTH}}$ VECTOR →V3 ($\overline{\text{MTH}}$ is the left-shift of the $\overline{\text{SYMB}}$ key).

Flags: Coordinate System (-15 and -16)

Input/Output:

| Level 3/Argument 1 | Level 2/Argument 2 | Level 1/Argument 3 | | Level 1/Item 1 |
|--------------------|--------------------|--------------------|---|---|
| X_1 | X_2 | X_3 | → | $[X_1\ X_2\ X_3]$ |
| X_1 | X_{theta} | X_z | → | $[X_1 \angle_{\text{theta}}\ X_z]$ |
| X_1 | X_{theta} | X_{phi} | → | $[X_1 \angle_{\text{theta}}\ X_{\text{theta}}\ X_{\text{phi}}]$ |

See also: $V \rightarrow, \rightarrow V2$

VANDERMONDE

CAS: Build Vandermonde matrix, or alternant matrix, from a list of objects.

VAR

Type: Command

Description: Variance Command: Calculates the sample variance of the coordinate values in each of the m columns in the current statistics matrix (ΣDAT).

The variance (equal to the square of the standard deviation) is returned as a vector of m real numbers, or as a single real number if $m = 1$. The variances are computed using this formula:

$$\frac{1}{n-1} \cdot \sum_{i=1}^n (x_i - \bar{x})^2$$

where x_i is the i th coordinate value in a column, \bar{x} is the mean of the data in this column, and n is the number of data points.

Access:  CAT VAR

Input/Output:

| Level 1/Argument 1 | Level 1/Item 1 |
|--------------------|---|
| | $X_{variance}$ |
| | $[X_{variance1}, \dots, X_{variancem}]$ |

See also: MAX Σ , MEAN, MIN Σ , PSDEV, PVAR, SDEV, TOT

VARS

Type: Command

Description: Variables Command: Returns a list of the names of all variables in the VAR menu for the current directory.

Access:  PRG MEMORY DIRECTORY  VARS (PRG is the left-shift of the  key).

Input/Output:

| Level 1/Argument 1 | Level 1/Item 1 |
|--------------------|-------------------------|
| | { global, ... global, } |

See also: ORDER, PVARs, TVARS

VER

CAS: Return the Computer Algebra System version number and date of release.

VERSION

Type: Command

Description: Software Version Command: Displays the software version and copyright message.

Access:  CAT VERSION



Input/Output:

| Level 1/Argument 1 | Level 2/Item 1 | Level 1/Item 2 |
|--------------------|------------------|---------------------|
| | “version number” | “copyright message” |

VISIT

Type: Command

Description: For a specified variable, opens the contents in the command-line editor.

Access:  CAT VISIT or  

Input/Output:

| Level 1/Argument 1 | Level 1/Item 1 |
|------------------------|--|
| <i>A variable name</i> | → <i>The contents opened in the command line editor.</i> |

See also: VISITB, EDIT, EDITB

VISITB

Type: Command

Description: For a specified variable, opens the contents in the most suitable editor for the object type. For example, if the specified variable holds an equation, the equation is opened in Equation Writer.

Access:  CAT VISITB

Input/Output:

| Level 1/Argument 1 | Level 1/Item 1 |
|------------------------|---|
| <i>A variable name</i> | → <i>The contents opened in the most suitable editor.</i> |

See also: VISIT, EDIT, EDITB

VPOTENTIAL

CAS: Find a vector potential function describing a field whose curl (or “rot”) is the input.

VTYPE

Type: Command

Description: Variable Type Command: Returns the type number of the object contained in the named variable.

If the named variable does not exist, VTYPE returns -1.

For a table of the objects' type numbers, see the entry for TYPE.

Access:  PRG TYPE   VTYPE (PRG is the left-shift of the  key).

Input/Output:

| Level 1/Argument 1 | Level 1/Item 1 |
|-----------------------------|----------------|
| 'name' | → n_{type} |
| $:n_{port} : name_{backup}$ | → n_{type} |
| $:n_{port} : n_{library}$ | → n_{type} |

See also: TYPE

WAIT

Type: Command

Description: Wait Command: Suspends program execution for specified time, or until a key is pressed.

The function of WAIT depends on the argument, as follows:

- Argument x interrupts program execution for x seconds.
- Argument 0 suspends program execution until a valid key is pressed (see below). WAIT then returns x_{key} , which defines where the pressed key is on the keyboard, and resumes program execution.

x_{key} is a three-digit number that identifies a key's location on the keyboard. See the entry for ASN for a description of the format of x_{key} .

- Argument -1 works as with argument 0, except that the currently specified menu is also displayed.

⬅, ➡, ALPHA ⬅, and ALPHA ➡ are not by themselves valid keys.

Arguments 0 and -1 do not affect the display, so that messages persist even though the keyboard is ready for input (FREEZE is not required).

Normally, the MENU command does not update the menu keys until a program halts or ends. WAIT with argument -1 enables a previous execution of MENU to display that menu while the program is suspended for a key press.

Access: ⬅ PRG NXT IN WAIT (PRG is the left-shift of the EVAL key).

Input/Output:

| Level 1/Argument 1 | | Level 1/Item 1 |
|--------------------|---|------------------|
| x | → | |
| 0 | → | X _{key} |
| -1 | → | X _{key} |

See also: KEY

WHILE

Type: Command Operation

Description: WHILE Indefinite Loop Structure Command: Starts the WHILE ... REPEAT ... END indefinite loop structure.

WHILE ... REPEAT ... END repeatedly evaluates a test and executes a loop clause if the test is true. Since the test clause occurs before the loop-clause, the loop clause is never executed if the test is initially false. The syntax is this:

WHILE *test-clause* **REPEAT** *loop-clause* **END**

The test clause is executed and must return a test result to the stack. REPEAT takes the value from the stack. If the value is not zero, execution continues with the loop clause; otherwise, execution resumes following END.

Access: ⬅ PRG BRANCH WHILE (PRG is the left-shift of the EVAL key).

Input/Output:

| Level 1/Argument 1 | | Level 1/Item 1 |
|--------------------|-------|----------------|
| WHILE | → | |
| REPEAT | T/F → | |
| END | → | |

See also: DO, END, REPEAT

WIREFRAME

Type: Command

Description: WIREFRAME Plot Type Command: Sets the plot type to WIREFRAME.

When the plot type is set to WIREFRAME, the DRAW command plots a perspective view of the graph of a scalar function of two variables. WIREFRAME requires values in the reserved variables EQ, VPAR, and PPAR.

VPAR has the following form:

{ X_{left}, X_{right}, Y_{near}, Y_{far}, Z_{low}, Z_{high}, X_{min}, X_{max}, Y_{min}, Y_{max}, X_{eye}, Y_{eye}, Z_{eye}, X_{step}, Y_{step} }

For plot type WIREFRAME, the elements of VPAR are used as follows:

- x_{left} and x_{right} are real numbers that specify the width of the view space.
- y_{near} and y_{far} are real numbers that specify the depth of the view space.
- z_{low} and z_{high} are real numbers that specify the height of the view space.
- x_{min} and x_{max} are not used.
- y_{min} and y_{max} are not used.
- $x_{\text{eye}}, y_{\text{eye}},$ and z_{eye} are real numbers that specify the point in space from which the graph is viewed.
- x_{step} and y_{step} are real numbers that set the number of x-coordinates versus the number of y-coordinates plotted.

The plotting parameters are specified in the reserved variable *PPAR*, which has this form:

$$\{ (x_{\text{min}}, y_{\text{min}}) (x_{\text{max}}, y_{\text{max}}) \text{ indep res axes ptype depend} \}$$

For plot type WIREFRAME, the elements of *PPAR* are used as follows:

- $(x_{\text{min}}, y_{\text{min}})$ is not used.
- $(x_{\text{max}}, y_{\text{max}})$ is not used.
- *indep* is a name specifying the independent variable. The default value of *indep* is *X*.
- *res* is not used.
- *axes* is not used.
- *ptype* is a name specifying the plot type. Executing the command WIREFRAME places the command name WIREFRAME in *ptype*.
- *depend* is a name specifying the dependent variable. The default value is *Y*.

Access:  CAT WIREFRAME

Input/Output: None





See also: BAR, CONIC DIFFEQ, FUNCTION, GRIDMAP, HISTOGRAM, PARAMETRIC, PARSURFACE, PCONTOUR, POLAR, SCATTER, SLOPEFIELD, TRUTH, YSLICE

WSLOG

Type: Command

Description: Warmstart Log Command: Returns four strings recording the date, time, and cause of the four most recent warmstart events.

Each string "*log_n*" has the form "*code–date time*". The following table summarizes the legal values of *code* and their meanings.

| Code | Description |
|------|--|
| 0 | The warmstart log was cleared by pressing   . |
| 1 | The interrupt system detected a very low battery condition at the battery contacts (not the same as a low system voltage), and put the calculator in “Deep Sleep mode” (<i>with the system clock running</i>). When  is pressed after the battery voltage is restored, the system warmstarts and puts a 1 in the log. |
| 2 | Hardware failed during transmission (timeout). |
| 3 | Run through address 0. |
| 4 | System time is corrupt |
| 5 | A Deep Sleep wakeup (for example,  , Alarm). |
| 6 | Not used |

| Code | Description |
|------|---|
| 7 | A 5-nibble word (CMOS test word) in RAM was corrupt. (This word is checked on every interrupt, but it is used only as an indicator of potentially corrupt RAM.) |
| 8 | Not used |
| 9 | The alarm list is corrupt. |
| A | System RPL jump to #0. |
| B | The card module was removed (or card bounce). |
| C | Hardware reset occurred (for example, an electrostatic discharge or user reset) |
| D | An expected System (RPL) error handler was not found in runstream |

The date and time stamp (*date time*) part of the log may be displayed as 00...0000 for one of three reasons:

- The system time was corrupt when the stamp was recorded.
- The date and time stamp itself is corrupt (bad checksum).
- Fewer than four warmstarts have occurred since the log was last cleared.

Access:  CAT WSLOG

Flags: Date Format (-42)

Input/Output:

| Level 1/Argument 1 | Level 4/Item 1 ... Level 1/Item 4 |
|--------------------|---|
| | → "log ₄ " ... "log ₁ " |

ΣX

Type: Command

Description: Sum of *x*-Values Command: Sums the values in the independent-variable column of the current statistical matrix (reserved variable ΣDAT).

The independent-variable column is specified by *XCOL* and is stored as the first parameter in the reserved variable ΣPAR . The default independent-variable column number is 1.

Access:  CAT ΣX

Input/Output:

| Level 1/Argument 1 | Level 1/Item 1 |
|--------------------|----------------|
| | → X_{sum} |

See also: NΣ, XCOL, ΣXY, ΣX2, ΣY, ΣY2

ΣX2

Type: Command

Description: Sum of Squares of *x*-Values Command: Sums the squares of the values in the independent-variable column of the current statistical matrix (reserved variable ΣDAT).

The independent-variable column is specified by *XCOL* and is stored as the first parameter in the reserved variable ΣPAR . The default independent-variable column number is 1.

Access:  CAT ΣX2

Input/Output:

| Level 1/Argument 1 | Level 1/Item 1 |
|--------------------|-------------------------|
| | → Sum of X ² |

See also: NΣ, ΣX, XCOL, ΣXY, ΣY, ΣY2

XCOL

Type: Command

Description: Independent Column Command: Specifies the independent-variable column of the current statistics matrix (reserved variable ΣDAT).

The independent-variable column number is stored as the first parameter in the reserved variable ΣPAR. The default independent-variable column number is 1.

XCOL will accept a noninteger real number and store it in ΣPAR, but subsequent commands that utilize the XCOL specification in ΣPAR will cause an error.

Access:  CAT XCOL

Input/Output:

| Level 1/Argument 1 | Level 1/Item 1 |
|--------------------|----------------|
| n _{col} | → |

See also: BARPLOT, BESTFIT, COLΣ, CORR, COV, EXPFIT, HISTPLOT, LINFIT, LOGFIT, LR, PREDX, PREDY, PWRFIT, SCATRPLOT, YCOL

XGET

Type: Command

Description: XModem Get Command: Retrieves a specified filename via XMODEM from another calculator. The other calculator needs to be in server mode for the operation to work ( I/O FUNCTIONS START SERVER).

Access:  CAT XGET

Input/Output:

| Level 1/Argument 1 | Level 1/Item 1 |
|--------------------|----------------|
| 'name' | → |

See also: BAUD, RECN, RECV, SEND XRECV, XSERV, XPUT

XMIT

Type: Command

Description: Serial Transmit Command: Sends a string serially without using Kermit protocol, and returns a single digit that indicates whether the transmission was successful.

XMIT is useful for communicating with non-Kermit devices such as RS-232 printers.

If the transmission is successful, XMIT returns a 1. If the transmission is not successful, XMIT returns the unsent portion of the string and a 0. Use ERRM to get the error message.

After receiving an XOFF command (with *transmit pacing* in the reserved variable IOPAR set), XMIT stops transmitting and waits for an XON command. XMIT resumes transmitting if an XON is received before the time-out set by STIME elapses; otherwise, XMIT terminates, returns a 0, and stores "Timeout" in ERRM.

Access:  CAT XMIT

Flags: I/O Device (-33)

Input/Output:

| Level 1/Argument 1 | | Level 2/Item 1 | Level 1/Item 2 |
|--------------------|---|----------------------------------|----------------|
| "string" | → | | 1 |
| "string" | → | "substring _{argument} " | 0 |

See also: BUFLN, SBRK, SRECV, STIME

XNUM

CAS: Convert objects to 12-digit decimal numeric values.

XOR

Type: Function

Description: Exclusive OR Function: Returns the logical exclusive OR of two arguments.

When the arguments are binary integers or strings, XOR does a bit-by-bit (base 2) logical comparison:

- Binary integer arguments are treated as sequences of bits with length equal to the current wordsize. Each bit in the result is determined by comparing the corresponding bits (*bit₁* and *bit₂*) in the two arguments, as shown in the following table:



| <i>bit₁</i> | <i>bit₂</i> | <i>bit₁ XOR bit₂</i> |
|------------------------|------------------------|--|
| 0 | 0 | 0 |
| 0 | 1 | 1 |
| 1 | 0 | 1 |
| 1 | 1 | 0 |

- String arguments are treated as sequences of bits, using 8 bits per character (that is, using the binary version of the character code). The two string arguments must be the same length.

When the arguments are real numbers or symbolics, XOR simply does a true/false test. The result is 1 (true) if either, but not both, arguments are nonzero; it is 0 (false) if both arguments are nonzero or zero. This test is usually done to compare two test results.

If either or both of the arguments are algebraic objects, then the result is an algebraic of the form *symb₁ XOR symb₂*. Execute →NUM (or set flag -3 before executing XOR) to produce a numeric result from the algebraic result.

Access:  BASE  LOGIC XOR ( is the right-shift of the  key).

 MTH BASE  LOGIC XOR ( is the left-shift of the  key).

Flags: Binary Integer Wordsize (-5 through -10), Binary Integer Base (-11, -12)

Input/Output:

| Level 2/Argument 1 | Level 1/Argument 2 | | Level 1/Item 1 |
|------------------------|------------------------|---|--|
| #n ₁ | #n ₂ | → | #n ₃ |
| "string ₁ " | "string ₂ " | → | "string ₃ " |
| T/F ₁ | T/F ₂ | → | 0/1 |
| T/F | 'symb' | → | 'T/F XOR symb' |
| 'symb' | T/F | → | 'symb XOR T/F' |
| 'symb ₁ ' | 'symb ₂ ' | → | 'symb ₁ XOR symb ₂ ' |

See also: AND, NOT, OR

XPON

Type: Function

Description: Exponent Function: Returns the exponent of the argument.

Access: $\left[\leftarrow \right]$ MTH REAL $\left[\text{NXT} \right]$ XPON ($\left[\leftarrow \right]$ is the left-shift of the $\left[\text{SYMB} \right]$ key).

Flags: Numerical Results (-3)

Input/Output:

| Level 1/Argument 1 | | Level 1/Item 1 |
|--------------------|---|------------------|
| x | → | n_{exp} |
| 'symb' | → | 'XPON(symb)' |

See also: MANT, SIGN

XPUT

Type: Command

Description: XModem Send Command: Sends a specified filename via XMODEM to a calculator. The receiving calculator needs to be in Server mode ($\left[\text{APPS} \right]$ I/O FUNCTIONS START SERVER).

Access: $\left[\rightarrow \right]$ _CAT XPUT

Input/Output:

| Level 1/Argument 1 | | Level 1/Item 1 |
|--------------------|---|----------------|
| 'name' | → | |

See also: BAUD, RECN, RECV, SEND XRECV, XSERV, XGET

XQ

CAS: Convert a number, or a list of numbers, in decimal format, to quotient (rational) format.

XRECV

Type: Command

Description: XModem Receive Command: Prepares the hp49g+/hp48gII to receive an object via XModem. The received object is stored in the given variable name. The transfer will start more quickly if you start the XModem sender *before* executing XRECV. Invalid object names cause an error. If flag -36 is clear, object names that are already in use also cause an error.

If you are transferring data between two hp49g+/hp48gII calculators, executing {AAA BBB CCC} XRECV receives AAA, BBB, and CCC. You also need to use a list on the sending end ({AAA BBB CCC} XSEND, for example).

Access: $\left[\rightarrow \right]$ _CAT XRECV

Flags: I/O Device (-33), RECV Overwrite (-36)

Input/Output:

| Level 1/Argument 1 | | Level 1/Item 1 |
|--------------------|---|----------------|
| 'name' | → | |

See also: BAUD, RECV, RECN, SEND, XSEND

XRNG

Type: Command

Description: x-Axis Display Range Command: Specifies the x-axis display range.

The x-axis display range is stored in the reserved variable *PPAR* as x_{\min} and x_{\max} in the complex numbers (x_{\min}, y_{\min}) and (x_{\max}, y_{\max}) . These complex numbers are the first two elements of *PPAR* and specify the coordinates of the lower left and upper right corners of the display ranges.

The default values of x_{\min} and x_{\max} are -6.5 and 6.5, respectively.

Access: $\left[\rightarrow \right]$ _CAT XRNG

Input/Output:

| Level 2/Argument 1 | Level 1/Argument 2 | | Level 1/Item 1 |
|--------------------|--------------------|---|----------------|
| x_{\min} | x_{\max} | → | |

See also: AUTO, PDIM, PMAX, PMIN, YRNG

XROOT

Type: Analytic function

Description: x th Root of y Command: Computes the x th root of a real number.

XROOT is equivalent to $y^{1/x}$, but with greater accuracy.

If $y < 0$, x must be an integer.

Access: $\boxed{\rightarrow}$ $\boxed{\sqrt[x]{y}}$ ($\boxed{\sqrt[x]{y}}$ is the right-shift of the $\boxed{\sqrt{x}}$ key).

Flags: Numerical Results (-3)

Input/Output(RPN):

| Level 2 | Level 1 | | Level 1 |
|----------------------|----------------------|---|--|
| y | x | → | $\sqrt[x]{y}$ |
| 'symb ₁ ' | 'symb ₂ ' | → | 'XROOT(symb ₂ ,symb ₁)' |
| 'symb' | x | → | 'XROOT(x,symb)' |
| y | 'symb' | → | 'XROOT(symb,y)' |
| y_unit | x | → | $\sqrt[x]{y}$ _unit ^{1/x} |
| y_unit | 'symb' | → | 'XROOT(symb,y_unit)' |

Input/Output(ALG):

| Argument 1 | Argument 2 | | Level 1 |
|----------------------|----------------------|---|--|
| y | x | → | $\sqrt[x]{y}$ |
| 'symb ₁ ' | 'symb ₂ ' | → | 'XROOT(symb ₁ ,symb ₂)' |
| 'symb' | x | → | 'XROOT(symb,x)' |
| y | 'symb' | → | 'XROOT(y,symb)' |
| x | y_unit | → | $\sqrt[x]{y}$ _unit ^{1/x} |
| 'symb' | y_unit | → | 'XROOT(symb,y_unit)' |

XSEND

Type: Command

Description: XModem Send Command: Sends a copy of the named object via XModem.

A receiving hp49g+/hp48gII must execute XRECV to receive an object via XModem.

The transfer occurs more quickly if you start the receiving XModem *after* executing XSEND.

Also, configuring the receiving modem *not* to do CRC checksums (if possible) will avoid a 30 to 60-second delay when starting the transfer.

If you are transferring data between two hp49g+/hp48gIIs, executing {AAA BBB CCC}

XSEND sends AAA, BBB, and CCC. You also need to use a list on the receiving end ({AAA BBB CCC} XRECV, for example).

Access: $\boxed{\rightarrow}$ $\boxed{\text{CAT}}$ XSEND

Flags: I/O Device (-33)

Input/Output:

| Level 1/Argument 1 | | Level 1/Item 1 |
|--------------------|---|----------------|
| 'name' | → | |

See also: BAUD, RECN, RECV, SEND XRECV

XSERV

Type: Command

Description: XModem Server Command: Puts the calculator in Xmodem server mode. When in server mode, the following commands are available:

P: Put a file in the calculator

G: Get a file from the calculator

E: Execute a command line

M Get the calculator memory

L: List the files in the current directory

Access:  CAT XSERV

See also: BAUD, RECN, RECV, SEND XRECV, XGET, XPUT

XVOL

Type: Command

Description: X Volume Coordinates Command: Sets the width of the view volume in the reserved variable *VPAR*.

x_{left} and x_{right} set the x -coordinates for the view volume used in 3D plots. These values are stored in the reserved variable *VPAR*.

Access:  CAT XVOL

Input/Output:

| Level 2/Argument 1 | Level 1/Argument 2 | Level 1/Item 1 |
|--------------------|--------------------|----------------|
| x_{left} | x_{right} | → |

See also: EYEPT, XXRNG, YVOL, YYRNG, ZVOL

XXRNG

Type: Command

Description: X Range of an Input Plane (Domain) Command: Specifies the x range of an input plane (domain) for GRIDMAP and PARSURFACE plots.

x_{min} and x_{max} are real numbers that set the x -coordinates for the input plane. These values are stored in the reserved variable *VPAR*.

Access:  CAT XXRNG

Input/Output:

| Level 2/Argument 1 | Level 1/Argument 2 | Level 1/Item 1 |
|--------------------|--------------------|----------------|
| x_{min} | x_{max} | → |

See also: EYEPT, NUMX, NUMY, XVOL, YVOL, YYRNG, ZVOL

ΣXY

Type: Command

Description: Sum of X times Y command: Sums the products of each of the corresponding values in the independent- and dependent-variable columns of the current statistical matrix (reserved variable *ΣDAT*). The independent column is the column designated as XCOL and the dependent column is the column designated as YCOL.

Access:  CAT ΣXY

Input/Output:

| Level 1/Argument 1 | Level 1/Item 1 |
|--------------------|----------------|
| | → Sum of X*Y |

See also: NΣ, ΣX, XCOL, ΣXY, ΣX2, YCOL, ΣY2

ΣY

Type: Command

Description: Sum of y -Values Command: Sums the values in the dependent variable column of the current statistical matrix (reserved variable ΣDAT).

The dependent variable column is specified by $YCOL$, and is stored as the second parameter in the reserved variable ΣPAR . The default dependent variable column number is 2.

Access:  \underline{CAT} ΣY

Input/Output:

| Level 1/Argument 1 | Level 1/Item 1 |
|--------------------|----------------|
| | → Sum of Y |

See also: $N\Sigma$, ΣX , $XCOL$, ΣXY , $\Sigma X2$, $YCOL$, $\Sigma Y2$

$\Sigma Y2$

Type: Command

Description: Sum of squares of Y-value command: Sums the squares of the values in the dependent-variable columns of the current statistical matrix (reserved variable ΣDAT). The dependent column is the column designated as $YCOL$

Access:  \underline{CAT} $\Sigma Y2$

Input/Output:

| Level 1/Argument 1 | Level 1/Item 1 |
|--------------------|----------------|
| | → Sum of Y^2 |

See also: $N\Sigma$, ΣX , $XCOL$, ΣXY , $\Sigma X2$, $YCOL$

$YCOL$

Type: Command

Description: Dependent Column Command: Specifies the dependent variable column of the current statistics matrix (reserved variable ΣDAT).

The dependent variable column number is stored as the second parameter in the reserved variable ΣPAR . The default dependent variable column number is 2.

$YCOL$ will accept a noninteger real number and store it in ΣPAR , but subsequent commands that utilize the $YCOL$ specification in ΣPAR will cause an error.

Access:  \underline{CAT} $YCOL$

Input/Output:

| Level 1/Argument 1 | Level 1/Item 1 |
|--------------------|----------------|
| n_{col} | → |

See also: $BARPLOT$, $BESTFIT$, $COL\Sigma$, $CORR$, COV , $EXPFIT$, $HISTPLOT$, $LINFIT$, $LOGFIT$, LR , $PREDX$, $PREDY$, $PWRFIT$, $SCATRPLLOT$, $XCOL$

$YRNG$

Type: Command

Description: y -Axis Display Range Command: Specifies the y -axis display range.

The y -axis display range is stored in the reserved variable $PPAR$ as y_{min} and y_{max} in the complex numbers (x_{min}, y_{min}) and (x_{max}, y_{max}) . These complex numbers are the first two elements of $PPAR$ and specify the coordinates of the lower left and upper right corners of the display ranges. The

default values of y_{\min} and y_{\max} are -3.1 and 3.2 , respectively for the hp48gII and -3.9 and 4.0 , respectively for the hp49g+.

Access:  CAT YRNG

Input/Output:

| Level 2/Argument 1 | Level 1/Argument 2 | Level 1/Item 1 |
|--------------------|--------------------|----------------|
| y_{\min} | y_{\max} | \rightarrow |

See also: AUTO, PDIM, PMAX, PMIN, X RNG

YSLICE

Type: Command

Description: Y-Slice Plot Command: Sets the plot type to YSLICE.

When plot type is set YSLICE, the DRAW command plots a slicing view of a scalar function of two variables. YSLICE requires values in the reserved variables EQ , $VPAR$, and $PPAR$.

$VPAR$ has the following form:

$\{ x_{\text{left}}, x_{\text{right}}, y_{\text{near}}, y_{\text{far}}, z_{\text{low}}, z_{\text{high}}, x_{\text{min}}, x_{\text{max}}, y_{\text{min}}, y_{\text{max}}, x_{\text{eye}}, y_{\text{eye}}, z_{\text{eye}}, x_{\text{step}}, y_{\text{step}} \}$

For plot type YSLICE, the elements of $VPAR$ are used as follows:

- x_{left} and x_{right} are real numbers that specify the width of the view space.
- y_{near} and y_{far} are real numbers that specify the depth of the view space.
- z_{low} and z_{high} are real numbers that specify the height of the view space.
- x_{min} and x_{max} are not used.
- y_{min} and y_{max} are not used.
- $x_{\text{eye}}, y_{\text{eye}},$ and z_{eye} are real numbers that specify the point in space from which the graph is viewed.
- x_{step} determines the interval between plotted x-values within each “slice”.
- y_{step} determines the number of slices to draw.

The plotting parameters are specified in the reserved variable $PPAR$, which has this form:

$\{ (x_{\text{min}}, y_{\text{min}}), (x_{\text{max}}, y_{\text{max}}), \text{indep}, \text{res}, \text{axes}, \text{ptype}, \text{depend} \}$

For plot type YSLICE, the elements of $PPAR$ are used as follows:

- $(x_{\text{min}}, y_{\text{min}})$ is not used.
- $(x_{\text{max}}, y_{\text{max}})$ is not used.
- *indep* is a name specifying the independent variable. The default value of *indep* is X .
- *res* is a real number specifying the interval, in user-unit coordinates, between plotted values of the independent variable; or a binary integer specifying the interval in pixels. The default value is 0, which specifies an interval of 1 pixel.
- *axes* is not used.
- *ptype* is a command name specifying the plot type. Executing the command YSLICE places YSLICE in *ptype*.
- *depend* is a name specifying the dependent variable. The default value is Y .

Access:  CAT YSLICE

Input/Output: None

See also: BAR, CONIC, DIFFEQ, FUNCTION, GRIDMAP, HISTOGRAM, PARAMETRIC, PARSURFACE, PCONTOUR, POLAR, SCATTER, SLOPEFIELD, TRUTH, WIREFRAME

YVOL

Type: Command

Description: Y Volume Coordinates Command: Sets the depth of the view volume in the reserved variable $VPAR$.

The variables y_{near} and y_{far} are real numbers that set the y -coordinates for the view volume used in 3D plots. y_{near} must be less than y_{far} . These values are stored in the reserved variable $VPAR$.

Access:  CAT YVOL

Input/Output:

| Level 2/Argument 1 | Level 1/Argument 2 | Level 1/Item 1 |
|--------------------|--------------------|----------------|
| y_{near} | y_{far} | → |

See also: EYEPT, XVOL, XXRNG, YYRNG, ZVOL

YYRNG

Type: Command

Description: Y Range of an Input Plane (Domain) Command: Specifies the y range of an input plane (domain) for GRIDMAP and PARSURFACE plots.

The variables y_{near} and y_{far} are real numbers that set the y -coordinates for the input plane. These values are stored in the reserved variable $VPAR$.

Access:  CAT YYRNG

Input/Output:

| Level 2/Argument 1 | Level 1/Argument 2 | Level 1/Item 1 |
|--------------------|--------------------|----------------|
| y_{near} | y_{far} | → |

See also: EYEPT, XVOL, XXRNG, YVOL, ZVOL

ZEROS

CAS: Return the zeros of a function of one variable, without giving their multiplicity.

ZFACTOR

Type: Function

Description: Gas Compressibility Z Factor Function: Calculates the gas compressibility correction factor for non-ideal behavior of a hydrocarbon gas.

x_{Tr} is the reduced temperature: the ratio of the actual temperature (T) to the pseudocritical temperature (T_c). (Calculate the ratio using absolute temperatures.) x_{Tr} must be between 1.05 and 3.0.

y_{Pr} is the reduced pressure: the ratio of the actual pressure (P) to the pseudocritical pressure (P_c). y_{Pr} must be between 0 and 30.

x_{Tr} and y_{Pr} must be real numbers or unit objects that reduce to dimensionless numbers.

Access:  CAT ZFACTOR

Flags: Numerical Results (-3)

Input/Output:

| Level 2/Argument 1 | Level 1/Argument 2 | Level 1/Item 1 |
|----------------------|----------------------|--|
| x_{Tr} | y_{Pr} | → $x_{Zfactor}$ |
| x_{Tr} | 'symb' | → 'ZFACTOR(x_{Tr} ,symb)' |
| 'symb' | y_{Pr} | → 'ZFACTOR(symb, y_{Pr})' |
| 'symb ₁ ' | 'symb ₂ ' | → 'ZFACTOR(symb ₁ ,symb ₂)' |

ZVOL

Type: Command

Description: Z Volume Coordinates Command: Sets the height of the view volume in the reserved variable *VPAR*.

x_{low} and x_{high} are real numbers that set the z-coordinates for the view volume used in 3D plots. These values are stored in the reserved variable *VPAR*.

Access:  CAT ZVOL

Input/Output:

| Level 2/Argument 1 | Level 1/Argument 2 | Level 1/Item 1 |
|--------------------|--------------------|----------------|
| x_{low} | x_{high} | → |

See also: EYEPT, XVOL, XXRNG, YVOL, YYRNG

^ (Power)

Type: Function

Description: Power Analytic Function: Returns the value of the level 2 object raised to the power of the level 1 object. This can also apply to a square matrix raised to a whole-number power.

If either argument is complex, the result is complex.

The branch cuts and inverse relations for w^z are determined by this relationship:

$$w^z = \exp(z(\ln w))$$

Access:  y^x

Flags: Principal Solution (-1), Numerical Results (-3)

Input/Output:

| Level 2/Argument 1 | Level 1/Argument 2 | Level 1/Item 1 |
|----------------------|----------------------|--------------------------|
| w | z | → w^z |
| z | 'symb' | → $'z^{(symb)}'$ |
| 'symb' | z | → $'(symb)^z'$ |
| 'symb ₁ ' | 'symb ₂ ' | → $'symb_1^{(symb_2)}'$ |
| x_unit | y | → x_unit^y |
| x_unit | 'symb' | → $'(x_unit)^{(symb)}'$ |

See also: EXP, ISOL, LN, XROOT

| (Where)

Type: Function

Description: Where Function: Substitutes values for names in an expression.

| is used primarily in algebraic objects, where its syntax is:

$$'symb_{old} | (name_1 = symb_1, name_2 = symb_2 \dots)'$$

It enables algebraics to include variable-like substitution information about names. Symbolic functions that delay name evaluation (such as \int and ∂) can then extract substitution information from local variables and include that information in the expression, avoiding the problem that would occur if the local variables no longer existed when the local names were finally evaluated.

Access:  |

(| is the right-shift of the  key).

Flags: Numerical Results (-3)

Input/Output:

| Level 2/Argument 1 | Level 1/Argument 2 | Level 1/Item 1 |
|------------------------|--|--------------------------|
| 'symb _{old} ' | { name ₁ , 'symb ₁ ', name ₂ , 'symb ₂ ' ... } | → 'symb _{new} ' |
| x | { name ₁ , 'symb ₁ ', name ₂ , 'symb ₂ ' ... } | → x |
| (x,y) | { name ₁ , 'symb ₁ ', name ₂ , 'symb ₂ ' ... } | → (x,y) |

See also: APPLY, QUOTE

√ (Square Root)

Type: Function

Description: Square Root Analytic Function: Returns the (positive) square root of the argument.

For a complex number (x_1, y_1) , the square root is this complex number:

$$(x_2, y_2) = \left(\sqrt{r} \cos \frac{\theta}{2}, \sqrt{r} \sin \frac{\theta}{2} \right)$$

where $r = \text{ABS}(x_1, y_1)$, and $\theta = \text{ARG}(x_1, y_1)$.

If $(x_1, y_1) = (0, 0)$, then the square root is $(0, 0)$.

The inverse of SQ is a *relation*, not a function, since SQ sends more than one argument to the same result. The inverse relation for SQ is expressed by ISOL as this *general solution*:

's1*√Z'

The function $\sqrt{}$ is the inverse of a *part* of SQ, a part defined by restricting the domain of SQ such that:

1. each argument is sent to a distinct result, and
2. each possible result is achieved. The points in this restricted domain of SQ are called the *principal values* of the inverse relation. The $\sqrt{}$ function in its entirety is called the *principal branch* of the inverse relation, and the points sent by $\sqrt{}$ to the boundary of the restricted domain of SQ form the *branch cuts* of $\sqrt{}$.

The principal branch used by the hp49g+/hp48gII for $\sqrt{}$ was chosen because it is analytic in the regions where the arguments of the *real-valued* inverse function are defined. The branch cut for the complex-valued square root function occurs where the corresponding real-valued function is undefined. The principal branch also preserves most of the important symmetries.

The graphs below show the domain and range of $\sqrt{}$. The graph of the domain shows where the branch cut occurs: the heavy solid line marks one side of the cut, while the feathered lines mark the other side of the cut. The graph of the range shows where each side of the cut is mapped under the function.

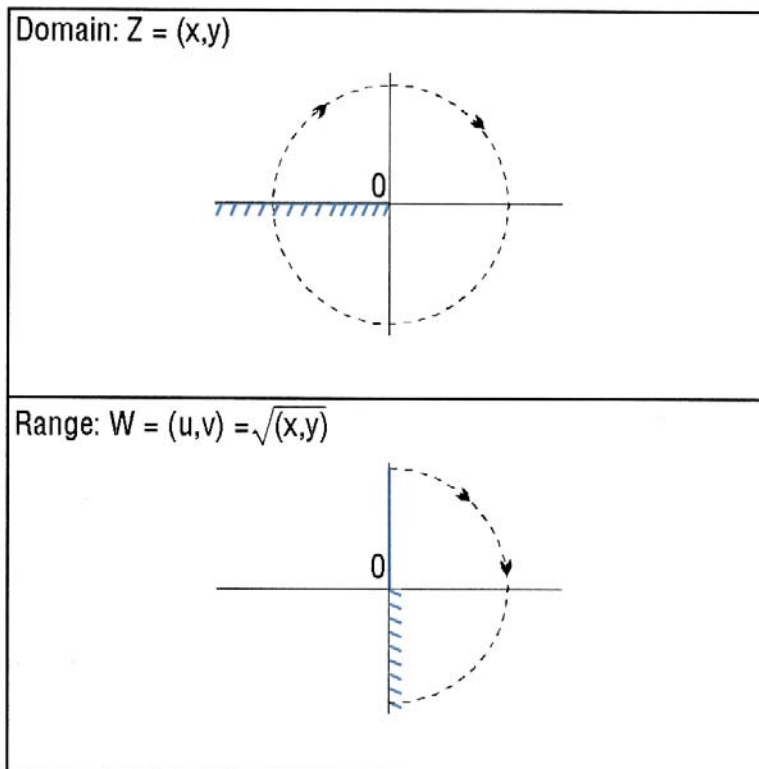

These graphs show the inverse relation 's1*√Z' for the case s1=1. For the other value of s1, the half-plane in the lower graph is rotated. Taken together, the half-planes cover the whole complex plane, which is the domain of SQ.

View these graphs with domain and range reversed to see how the domain of SQ is restricted to make an inverse *function* possible. Consider the half-plane in the lower graph as the restricted domain $Z = (x, y)$. SQ sends this domain onto the whole complex plane in the range $W = (u, v) = SQ(x, y)$ in the upper graph.

Access: \sqrt{x}

Flags: Principal Solution (-1), Numerical Results (-3)

Input/Output:

| Level 1/Argument 1 | | Level 1/Item 1 |
|--------------------|---|-------------------------------|
| z | → | \sqrt{z} |
| x_unit | → | $\sqrt{x} \text{ unit}^{1/2}$ |
| 'symb' | → | $\sqrt{\text{symb}}$ |

See also: SQ, ^, ISOL

∫ (Integrate)

Type: Function

Description: Integral Function: Integrates an *integrand* from *lower limit* to *upper limit* with respect to a specified variable of integration.

The algebraic syntax for ∫ parallels its stack syntax:

∫ (*lower limit*, *upper limit*, *integrand*, *name*)

where *lower limit*, *upper limit*, and *integrand* can be real or complex numbers, unit objects, names, or algebraic expressions.

Evaluating ∫ in Symbolic Results mode (flag -3 *clear*) returns a symbolic result. Some functions that the hp49g+/hp48gII can integrate include the following:

- All built-in functions whose antiderivatives can be expressed in terms of other built-in functions—for example, SIN can be integrated since its antiderivative, COS, is a built-in function. The arguments for these functions must be linear.
- Sums, differences, and negations of built-in functions whose antiderivatives can be expressed in terms of other built-in functions—for example, 'SIN(X)-COS(X)'.
- Derivatives of all built-in functions—for example, 'INV(1+X^2)' can be integrated because it is the derivative of the built-in function ATAN.
- Polynomials whose base term is linear—for example, 'X^3+X^2-2*X+6' can be integrated since X is a linear term. '(X^2-6)^3+(X^2-6)^2' cannot be integrated since X^2-6 is not linear.
- Selected patterns composed of functions whose antiderivatives can be expressed in terms of other built-in functions—for example, '1/(COS(X)*SIN(X))' returns 'LN(TAN(X))'.

If the result of the integration is an expression with no integral sign in the result, the symbolic integration was successful. If, however, the result still contains an integral sign, try rearranging the expression and evaluating again, or estimate the answer using numerical integration.

Evaluating ∫ in Numerical Results mode (flag -3 *set*) returns a numerical approximation, and stores the error of integration in variable *IERR*. ∫ consults the number format setting to determine how accurately to compute the result.

Access: \int (— \int is the right-shift of the TAN key).

Flags: Numerical Result (-3), Number Format (-45 to -50)

Input/Output:

| L4/A1 | L3/A2 | L2/A3 | L1/A4 | | L1/I1 |
|-------------|-------------|-----------|--------|---|-----------------------------|
| lower limit | upper limit | integrand | 'name' | → | 'symb _{integral} ' |

L = Level; A = Argument; I = Item

See also: TAYLR, ∂, Σ

? (Undefined)

CAS: The “undefined” symbol for numeric results that are not defined by the rules of arithmetic.

∞ (Infinity)

CAS: Symbol signifies infinite numeric result, such as division of a non-zero number by zero.

Σ (Summation)

Type: Function

Description: Summation Function: Calculates the value of a finite series.

The summand argument *smnd* can be a real number, a complex number, a unit object, a local or global name, or an algebraic object. The algebraic syntax for Σ differs from the stack syntax. The algebraic syntax is: 'Σ(*index=initial,final,summand*)'

Access:  Σ ($\overline{\Sigma}$ is the right-shift of the  key).

Flags: Symbolic Constants (-2), Numerical Results (-3)

Input/Output:

| L4/A1 | L3/A2 | L2/A3 | L1/A4 | | L1/I1 |
|--------|------------|-------------|-------|---|--|
| 'indx' | x_{init} | x_{final} | smnd | → | x_{sum} |
| 'indx' | 'init' | x_{final} | smnd | → | 'Σ(<i>indx = init, x_{final}, smnd</i>)' |
| 'indx' | x_{init} | 'final' | smnd | → | 'Σ(<i>indx = x_{init}, final, smnd</i>)' |
| 'indx' | 'init' | 'final' | smnd | → | 'Σ(<i>indx = init, final, smnd</i>)' |

L = Level; A = Argument; I = Item

See also: TAYLR, ∫, ∂

Σ+ (Sigma Plus)

Type: Command

Description: Sigma Plus Command: Adds one or more data points to the current statistics matrix (reserved variable ΣDAT).

For a statistics matrix with *m* columns, arguments for Σ+ can be entered several ways:

- To enter one data point with a single coordinate value, the argument for Σ+ must be a real number.
- To enter one data point with multiple coordinate values, the argument for Σ+ must be a vector with *m* real coordinate values.
- To enter several data points, the argument for Σ+ must be a matrix of *n* rows of *m* real coordinate values.

In each case, the coordinate values of the data point(s) are added as new rows to the current statistics matrix (reserved variable ΣDAT). If ΣDAT does not exist, Σ+ creates an *n* x *m* matrix and stores the matrix in ΣDAT. If ΣDAT does exist, an error occurs if it does not contain a real matrix, or if the number of coordinate values in each data point entered with Σ+ does not match the number of columns in the current statistics matrix.

Once ΣDAT exists, individual data points of *m* coordinates can be entered as *m* separate real numbers or an *m*-element vector. LASTARG returns the *m*-element vector in either case.

Access:  $\overline{\text{CAT}}$ Σ+

Input/Output:

| | | |
|-----------------------------|---|---------------|
| $L_m/A_1 \dots L_2/A_{m-1}$ | L_1/A_m | L_1/I_1 |
| | x | \rightarrow |
| | $[X_1, X_2, \dots, X_m]$ | \rightarrow |
| | $[[X_{11}, \dots, X_{1m}] [X_{21}, \dots, X_{2m}]]$ | \rightarrow |
| $X_1 \dots X_{m-1}$ | X_m | \rightarrow |

L = Level; A = Argument; I = Item

See also: $CL\Sigma$, $RCL\Sigma$, $STO\Sigma$, $\Sigma-$

$\Sigma-$ (Sigma Minus)

Type: Command

Description: Sigma Minus Command: Returns a vector of m real numbers (or one number x if $m = 1$) corresponding to the coordinate values of the last data point entered by $\Sigma+$ into the current statistics matrix (reserved variable ΣDAT).

The last row of the statistics matrix is deleted.

The vector returned by $\Sigma-$ can be edited or replaced, then restored to the statistics matrix by $\Sigma+$.

Access: \rightarrow \overline{CAT} $\Sigma-$

Input/Output:

| | |
|---------------------------|-----------------------|
| Level 1/Argument 1 | Level 1/Item 1 |
| | x |
| | $[X_1 X_2 \dots X_m]$ |

See also: $CL\Sigma$, $RCL\Sigma$, $STO\Sigma$, $\Sigma+$

π (Pi)

Type: Function

Description: π Function: Returns the symbolic constant ' π ' or its numerical representation, 3.14159265359.

The number returned for π is the closest approximation of the constant π to 12-digit accuracy.

In Radians mode with flag -2 and -3 clear (to return symbolic results), trigonometric functions of π and $\pi/2$ are automatically simplified. For example, evaluating 'SIN(π)' returns zero.

However, if flag -2 or flag -3 is set (to return numerical results), then evaluating 'SIN(π)' returns the numerical approximation $-2.06761537357E-13$.

Access: \leftarrow π ($\overline{\pi}$ is the left-shift of the \overline{SPC} key).

Flags: Symbolic Constants (-2), Numerical Results (-3)

Input/Output:

| | |
|---------------------------|-----------------------|
| Level 1/Argument 1 | Level 1/Item 1 |
| | ' π ' |
| | 3.14159265359... |

See also: e , i , MAXR, MINR, $\rightarrow Q\pi$

∂ (Derivative)

Type: Function

Description: Derivative Function: Takes the derivative of an expression, number, or unit object with respect to a specified variable of differentiation.

When executed in stack syntax, ∂ executes a *complete* differentiation: the expression 'symb₁' is evaluated repeatedly until it contains no derivatives. As part of this process, if the variable of differentiation *name* has a value, the final form of the expression substitutes that value substituted for all occurrences of the variable.

The algebraic syntax for ∂ is ' ∂ name(symb₁)'. When executed in algebraic syntax, ∂ executes a *stepwise* differentiation of symb₁, invoking the chain rule of differentiation—the result of one evaluation of the expression is the derivative of the argument expression symb₁, multiplied by a new subexpression representing the derivative of symb₁'s argument.

If ∂ is applied to a function for which thehp49g+/hp48gII does not provide a derivative, ∂ returns a new function whose name is *der* followed by the original function name.

Access: $\left[\rightarrow \right]$ $\left[\leftarrow \right]$ ∂ ($\leftarrow \partial$ is the right-shift of the $\left[\text{COS} \right]$ key).

Flags: Numerical Results (-3)

Input/Output:

| Level 2/Argument 1 | Level 1/Argument 2 | | Level 1/Item 1 |
|----------------------|--------------------|---|----------------------|
| 'symb ₁ ' | 'name' | → | 'symb ₂ ' |
| z | 'name' | → | 0 |
| x_unit | 'name' | → | 0 |

See also: TAYLOR, \int , Σ

! (Factorial)

Type: Function

Description: Factorial (Gamma) Function: Returns the factorial *n!* of a positive integer argument *n*, or the gamma function $\Gamma(x+1)$ of a non-integer argument *x*.

For $x \geq 253.1190554375$ or $n < 0$, ! causes an overflow exception (if flag -21 is set, the exception is treated as an error). For non-integer $x \leq -254.1082426465$, ! causes an underflow exception (if flag -20 is set, the exception is treated as an error).

In algebraic syntax, ! follows its argument. Thus the algebraic syntax for the factorial of 7 is 7!.

For non-integer arguments *x*, $x! = \Gamma(x + 1)$, defined for $x > -1$ as:

$$\Gamma(x + 1) = \int_0^{\infty} e^{-t} t^x dt$$

and defined for other values of *x* by analytic continuation: $\Gamma(x + 1) = x \Gamma(x)$

Access: $\left[\leftarrow \right]$ $\left[\text{MTH} \right]$ $\left[\text{NXT} \right]$ PROBABILITY ! ($\left[\leftarrow \right]$ $\left[\text{MTH} \right]$ is the left-shift of the $\left[\text{SYMB} \right]$ key).

Flags: Numerical Results (-3), Underflow Exception (-20), Overflow Exception (-21)

Input/Output:

| Level 1/Argument 1 | | Level 1/Item 1 |
|--------------------|---|-----------------|
| n | → | n! |
| x | → | $\Gamma(x + 1)$ |
| 'symb' | → | '(symb!)' |

See also: COMB, PERM

% (Percent)

Type: Function

Description: Percent Function: Returns *x* percent of *y*.

Common usage is ambiguous about some units of temperature. When °C or °F represents a thermometer reading, then the temperature is a unit with an additive constant: 0 °C=273.15 K,

and $0\text{ }^{\circ}\text{F}=459.67\text{ }^{\circ}\text{R}$. But when $^{\circ}\text{C}$ or $^{\circ}\text{F}$ represents a *difference* in thermometer readings, then the temperature is a unit with no additive constant: $1\text{ }^{\circ}\text{C}=1\text{ K}$ and $1\text{ }^{\circ}\text{F}=1\text{ }^{\circ}\text{R}$.

The arithmetic operators $+$, $-$, $\%$, $\%CH$, and $\%T$ treat temperatures as differences, without any additive constant. However, $+$, $-$, $\%CH$, and $\%T$ require both arguments to be either absolute (K and $^{\circ}\text{R}$), both $^{\circ}\text{C}$, or both $^{\circ}\text{F}$. No other combinations are allowed.

For more information on using temperature units with arithmetic functions, see the entry for $+$.

Access: \leftarrow MTH REAL % (\leftarrow is the left-shift of the $\boxed{\text{SYMB}}$ key).

Input/Output:

| Level 2/Argument 1 | Level 1/Argument 2 | | Level 1/Item 1 |
|----------------------|----------------------|---------------|-------------------------------------|
| x | y | \rightarrow | $xy/100$ |
| x | 'symb' | \rightarrow | $\%(x,\text{symb})'$ |
| 'symb' | x | \rightarrow | $\%(\text{symb},x)'$ |
| 'symb ₁ ' | 'symb ₂ ' | \rightarrow | $\%(\text{symb}_1, \text{symb}_2)'$ |
| x | y_unit | \rightarrow | $(xy/100)\text{-unit}$ |
| x_unit | y | \rightarrow | $(xy/100)\text{-unit}$ |
| 'symb' | x_unit | \rightarrow | $\%(\text{symb},x\text{-unit})'$ |
| x_unit | 'symb' | \rightarrow | $\%(x\text{-unit},\text{symb})'$ |

See also: $+$, $\%CH$, $\%T$

– (Unit attachment)

Type: Unit attachment

Description: Unit attachment symbol: Attaches a unit type to a numeric value.

The hp49g+/hp48gII handles units by attaching the unit to a numeric value using the underscore symbol. For example, the value of 3 kilometers is shown as 3_km, and is created by entering 3 and then the underscore character, followed by attaching the kilometer unit.

Access: \rightarrow $_$ ($_$ is the right-shift of the $\boxed{-}$ key).

Input: Numeric value

Output: Numeric value ready for a unit attachment

⌘ ⌘ (Program delimiters)

Type: Object

Description: Program delimiter object: Enters a pair of program delimiter objects.

A program is a set of instructions enclosed by an open program object delimiter and a close program object delimiter. These can be nested to have a program procedure enclosed within an outer program object.

Access: \rightarrow $\ll\gg$ ($\ll\gg$ is the right-shift of the $\boxed{+}$ key).

Input: None

Output: A pair of program delimiters

< (Less than)

Type: Function

Description: Less Than Function: Tests whether one object is less than another object.



The function $<$ returns a true test result (1) if the first argument is less than the second argument, or a false test result (0) otherwise.

If one object is a symbolic (an algebraic or a name), and the other is a number or symbolic or unit object, < returns a symbolic comparison expression that can be evaluated to return a test result.

For real numbers and binary integers, “less than” means numerically smaller (1 is less than 2). For real numbers, “less than” also means more negative (–2 is less than –1).

For strings, “less than” means alphabetically previous (“ABC” is less than “DEF”; “AAA” is less than “AAB”; “A” is less than “AA”). In general, characters are ordered according to their character codes. This means, for example, that “B” is less than “a”, since “B” is character code 66, and “a” is character code 97.

For unit objects, the two objects must be dimensionally consistent, and are converted to common units for comparison. If you use simple temperature units, the calculator assumes the values represent temperatures and not differences in temperatures. For compound temperature units, the calculator assumes temperature units represent temperature differences. For more information on using temperature units with arithmetic functions, refer to the entry for +.

Access:  \leq (\leq is the right-shift of the  key above the ).

Flags: Numerical Results (-3)

Input/Output:

| Level 2/Argument 1 | Level 1/Argument 2 | | Level 1/Item 1 |
|------------------------|------------------------|---|--|
| x | y | → | 0/1 |
| #n ₁ | #n ₂ | → | 0/1 |
| “string ₁ ” | “string ₂ ” | → | 0/1 |
| x | 'symb' | → | 'x < symb' |
| 'symb' | x | → | 'symb < x' |
| 'symb ₁ ' | 'symb ₂ ' | → | 'symb ₁ < symb ₂ ' |
| x_unit ₁ | y_unit ₂ | → | 0/1 |
| x_unit | 'symb' | → | 'x_unit < symb' |
| 'symb' | x_unit | → | 'symb < x_unit' |

See also: \leq , $>$, \geq , $==$, \neq

\leq (Less than or Equal)



Type: Function

Description: Less Than or Equal Function: Tests whether one object is less than or equal to another object.

The function \leq returns a true test result (1) if the first argument is less than or equal to the second argument, or a false test result (0) otherwise. If one object is a symbolic (an algebraic or a name), and the other is a number or symbolic or unit object, \leq returns a symbolic comparison expression that can be evaluated to return a test result.

For real numbers and binary integers, “less than or equal” means numerically equal or smaller (1 is less than 2). For real numbers, “less than or equal” also means equally or more negative (–2 is less than –1). For strings, “less than or equal” means alphabetically equal or previous (“ABC” is less than or equal to “DEF”; “AAA” is less than or equal to “AAB”; “A” is less than or equal to “AA”). In general, characters are ordered according to their character codes. This means, for example, that “B” is less than “a”, since “B” is character code 66, and “a” is character code 97.

For unit objects, the two objects must be dimensionally consistent and are converted to common units for comparison. If you use simple temperature units, the calculator assumes the values represent temperature and not differences in temperatures. For compound temperature units, the calculator assumes temperature units represent temperature differences. For more information on using temperature units with arithmetic functions, refer to the entry for +.

Access:  \leq (\leq is the left-shift of the  key above the ).

Flags: Numerical Results (-3)

Input/Output:

| Level 2/Argument 1 | Level 1/Argument 2 | | Level 1/Item 1 |
|------------------------|------------------------|---|--|
| x | y | → | 0/1 |
| #n ₁ | #n ₂ | → | 0/1 |
| "string ₁ " | "string ₂ " | → | 0/1 |
| x | 'symb' | → | 'x ≤ symb' |
| 'symb' | x | → | 'symb ≤ x' |
| 'symb ₁ ' | 'symb ₂ ' | → | 'symb ₁ ≤ symb ₂ ' |
| x_unit ₁ | y_unit ₂ | → | 0/1 |
| x_unit | 'symb' | → | 'x_unit ≤ symb' |
| 'symb' | x_unit | → | 'symb ≤ x_unit' |

See also: <, >, ≥, ==, ≠

> (Greater than)

Type: Function

Description: Greater Than Function: Tests whether one object is greater than another object.

The function > returns a true test result (1) if the first argument is greater than the second argument, or a false test result (0) otherwise.

If one object is a symbolic (an algebraic or a name), and the other is a number or symbolic or unit object, > returns a symbolic comparison expression that can be evaluated to return a test result.

For real numbers and binary integers, "greater than" means numerically greater (2 is greater than 1). For real numbers, "greater than" also means less negative (-1 is greater than -2).

For strings, "greater than" means alphabetically subsequent ("DEF" is greater than "ABC"; "AAB" is greater than "AAA"; "AA" is greater than "A"). In general, characters are ordered according to their character codes. This means, for example, that "a" is greater than "B", since "B" is character code 66, and "a" is character code 97.

For unit objects, the two objects must be dimensionally consistent and are converted to common units for comparison. If you use simple temperature units, the calculator assumes the values represent temperatures and not differences in temperatures. For compound temperature units, the calculator assumes temperature units represent temperature differences. For more information on using temperature units with arithmetic functions, refer to the entry for +.

Access:  \longrightarrow (\longrightarrow is the right-shift of the  key).

Flags: Numerical Results (-3)

Input/Output:

| Level 2/Argument 1 | Level 1/Argument 2 | | Level 1/Item 1 |
|------------------------|------------------------|---|--|
| x | y | → | 0/1 |
| #n ₁ | #n ₂ | → | 0/1 |
| "string ₁ " | "string ₂ " | → | 0/1 |
| x | 'symb' | → | 'x > symb' |
| 'symb' | x | → | 'symb > x' |
| 'symb ₁ ' | 'symb ₂ ' | → | 'symb ₁ > symb ₂ ' |
| x_unit ₁ | y_unit ₂ | → | 0/1 |
| x_unit | 'symb' | → | 'x_unit > symb' |
| 'symb' | x_unit | → | 'symb > x_unit' |

See also: <, ≤, ≥, ==, ≠

≥ (Greater than or Equal)

Type: Function

Description: Greater Than or Equal Function: Tests whether one object is greater than or equal to another object.

The function ≥ returns a true test result (1) if the first argument is greater than or equal to the second argument, or a false test result (0) otherwise.

If one object is a symbolic (an algebraic or a name), and the other is a number or symbolic or unit object, ≥ returns a symbolic comparison expression that can be evaluated to return a test result.

For real numbers and binary integers, "greater than or equal to" means numerically equal or greater (2 is greater than or equal to 1). For real numbers, "greater than or equal to" also means equally or less negative (-1 is greater than or equal to -2).

For strings, "greater than or equal to" means alphabetically equal or subsequent ("DEF" is greater than or equal to "ABC"; "AAB" is greater than or equal to "AAA"; "AA" is greater than or equal to "A"). In general, characters are ordered according to their character codes. This means, for example, that "a" is greater than or equal to "B", since "B" is character code 66, and "a" is character code 97.

For unit objects, the two objects must be dimensionally consistent and are converted to common units for comparison. If you use simple temperature units, the calculator assumes the values represent temperatures and not differences in temperatures. For compound temperature units, the calculator assumes temperature units represent temperature differences. For more information on using temperature units with arithmetic functions, refer to the entry for +.

Access:  ≥ ( ≥ is the left-shift of the  key).

Flags: Numerical Results (-3)

Input/Output:

| Level 2/Argument 1 | Level 1/Argument 2 | | Level 1/Item 1 |
|------------------------|------------------------|---|--|
| x | y | → | 0/1 |
| #n ₁ | #n ₂ | → | 0/1 |
| "string ₁ " | "string ₂ " | → | 0/1 |
| x | 'symb' | → | 'x ≥ symb' |
| 'symb' | x | → | 'symb ≥ x' |
| 'symb ₁ ' | 'symb ₂ ' | → | 'symb ₁ ≥ symb ₂ ' |
| x_unit ₁ | y_unit ₂ | → | 0/1 |
| x_unit | 'symb' | → | 'x_unit ≥ symb' |
| 'symb' | x_unit | → | 'symb ≥ x_unit' |

See also: <, ≤, >, ==, ≠

≠ (Not equal)

Type: Function

Description: Not Equal Function: Tests if two objects are not equal.



The function ≠ returns a true result (1) if the two objects have different values, or a false result (0) otherwise. (Lists and programs are considered to have the same values if the objects they contain are identical.)

If one object is algebraic or a name, and the other is a number, a name, or algebraic, ≠ returns a symbolic comparison expression that can be evaluated to return a test result.

If the imaginary part of a complex number is 0, it is ignored when the complex number is compared to a real number, so, for example, 6 and (6,0) and considered to be equal.

For unit objects, the two objects must be dimensionally consistent and are converted to common units for comparison. If you use simple temperature units, the calculator assumes the values represent temperatures and not differences in temperatures. For compound temperature units, the calculator assumes temperature units represent temperature differences. For more information on using temperature units with arithmetic functions, refer to the entry for +.

Access:  ≠

( is the left-shift of the  key).

Flags: Numerical Results (-3)

Input/Output:

| Level 2/Argument 1 | Level 1/Argument 2 | | Level 1/Item 1 |
|----------------------|----------------------|---|--|
| obj ₁ | obj ₂ | → | 0/1 |
| (x,0) | x | → | 0/1 |
| x | (x,0) | → | 0/1 |
| z | 'symb' | → | 'z ≠ symb' |
| 'symb' | z | → | 'symb ≠ z' |
| 'symb ₁ ' | 'symb ₂ ' | → | 'symb ₁ ≠ symb ₂ ' |

See also: SAME, TYPE, <, ≤, >, ≥, ==, ≠

*** (Multiply)**

Type: Function

Description: Multiply Analytic Function: Returns the product of the arguments.

The product of a real number a and a complex number (x, y) is the complex number (xa, ya) .

The product of two complex numbers (x_1, y_1) and (x_2, y_2) is the complex number $(x_1 x_2 - y_1 y_2, x_1 y_2 + x_2 y_1)$.

The product of a real array and a complex array or number is a complex array. Each element x of the real array is treated as a complex element $(x, 0)$.

Multiplying a matrix by an array returns a matrix product. The matrix must have the same number of columns as the array has rows (or elements, if it is a vector).

Although a vector is entered and displayed as a *row* of numbers, the hp49g+/hp48gII treats a vector as an $n \times 1$ matrix when multiplying matrices or computing matrix norms.

Multiplying a binary integer by a real number returns a binary integer that is the product of the two arguments, truncated to the current wordsize. (The real number is converted to a binary integer before the multiplication.)

The product of two binary integers is truncated to the current binary integer wordsize.

When multiplying two unit objects, the scalar parts and the unit parts are multiplied separately.

Access:

Flags: Numerical Results (-3), Binary Integer Wordsize (-5 through -10)

Input/Output:

| Level 2/Argument 1 | Level 1/Argument 2 | | Level 1/Item 1 |
|----------------------|----------------------|---------------|---|
| z_1 | z_2 | \rightarrow | $z_1 z_2$ |
| [[matrix]] | [array] | \rightarrow | [[matrix \times array]] |
| z | [array] | \rightarrow | [$z \times$ array] |
| [array] | z | \rightarrow | [array $\times z$] |
| z | 'symb' | \rightarrow | 'z * symb' |
| 'symb' | z | \rightarrow | 'symb * z' |
| 'symb ₁ ' | 'symb ₂ ' | \rightarrow | 'symb ₁ * symb ₂ ' |
| #n ₁ | n ₂ | \rightarrow | #n ₁ |
| n ₁ | #n ₂ | \rightarrow | #n ₁ |
| #n ₁ | #n ₂ | \rightarrow | #n ₁ |
| x_unit | y_unit | \rightarrow | xy_unit _x \times unit _y |
| x | y_unit | \rightarrow | xy_unit |
| x_unit | y | \rightarrow | xy_unit |
| 'symb' | x_unit | \rightarrow | 'symb * x_unit' |
| x_unit | 'symb' | \rightarrow | 'x_unit * symb' |

See also: +, -, /, =

+ (Add)

Type: Function

Description: Add Analytic Function: Returns the sum of the arguments.

The sum of a real number a and a complex number (x, y) is the complex number $(x+a, y)$.

The sum of two complex numbers (x_1, y_1) and (x_2, y_2) is the complex number (x_1+x_2, y_1+y_2) .

The sum of a real array and a complex array is a complex array, where each element x of the real array is treated as a complex element $(x, 0)$. The arrays must have the same dimensions.

The sum of a binary integer and a real number is a binary integer that is the sum of the two arguments, truncated to the current wordsize. (The real number is converted to a binary integer before the addition.)

The sum of two binary integers is truncated to the current binary integer wordsize.

The sum of two unit objects is a unit object with the same dimensions as the second argument.

The units of the two arguments must be consistent.

The sum of two graphics objects is the same as the result of performing a logical OR, except that the two graphics objects *must* have the same dimensions.

Common usage is ambiguous about some units of temperature. When °C or °F represents a thermometer reading, then the temperature is a unit with an additive constant: 0 °C = 273.15 K, and 0°F = 459.67°R. But when °C or °F represents a *difference* in thermometer readings, then the temperature is a unit with no additive constant: 1 °C=1 K and 1 °F =1 °R.

The calculator assumes that the simple temperature units $x_{}^{\circ}\text{C}$ and $x_{}^{\circ}\text{F}$ represent thermometer temperatures when used as arguments to the functions <, >, ≤, ≥, ==, and ≠. This means that, in order to do the calculation, the calculator will first convert any Celsius temperature to Kelvins and any Fahrenheit temperature to Rankines. (For other functions or *compound* temperature units, such as $x_{}^{\circ}\text{C}/\text{min}$, the calculator assumes temperature units represent temperature differences, so there is no additive constant involved, and hence no conversion.) The arithmetic operators +, −, %CH, and %T treat temperatures as differences, without any additive constant, but require both arguments to be either absolute (K and °R), both °C, or both °F. No other combinations are allowed.

Access: +

Flags: Numerical Results (-3), Binary Integer Wordsize (-5 through -10)

Input/Output:

| Level 2/Argument 1 | Level 1/Argument 2 | | Level 1/Item 1 |
|---|---|---|--|
| z_1 | z_2 | → | $z_1 + z_2$ |
| [array] ₁ | [array] ₂ | → | [array] ₃ |
| z | 'symb' | → | 'z +symb' |
| 'symb' | z | → | 'symb +z' |
| 'symb ₁ ' | 'symb ₂ ' | → | 'symb ₁ + symb ₂ ' |
| { list ₁ } | { list ₂ } | → | { list ₁ ,list ₂ } |
| obj _A | { obj ₁ ... obj _n } | → | { obj _A obj ₁ ... obj _n } |
| { obj ₁ ... obj _n } | obj _A | → | { obj ₁ ... obj _n obj _A } |
| "string ₁ " | "string ₂ " | → | "string ₁ string ₂ " |
| obj | "string" | → | "obj string" |
| "string" | obj | → | "string obj" |
| #n ₁ | n ₂ | → | #n ₃ |
| n ₁ | #n ₂ | → | #n ₃ |
| #n ₁ | #n ₂ | → | #n ₃ |
| $x_1\text{_unit}_1$ | $y_1\text{_unit}_2$ | → | $(x_2 + y)_\text{unit}_2$ |
| 'symb' | $x_1\text{_unit}$ | → | 'symb + $x_1\text{_unit}$ ' |
| $x_1\text{_unit}$ | 'symb' | → | ' $x_1\text{_unit}$ + symb' |
| grob ₁ | grob ₂ | → | grob ₃ |

See also: −, *, /, =, ADD

- (Subtract)

Type: Function

Description: Subtract Analytic Function: Returns the difference of the arguments.

The difference of a real number a and a complex number (x, y) is $(x-a, y)$ or $(a-x, -y)$. The difference of two complex numbers (x_1, y_1) and (x_2, y_2) is $(x_1 - x_2, y_1 - y_2)$.

The difference of a real array and a complex array is a complex array, where each element x of the real array is treated as a complex element $(x, 0)$. The two array arguments must have the same dimensions.

The difference of a binary integer and a real number is a binary integer that is the sum of the first argument and the two's complement of the second argument. (The real number is converted to a binary integer before the subtraction.)

The difference of two binary integers is a binary integer that is the sum of the first argument and the two's complement of the second argument.

The difference of two unit objects is a unit object with the same dimensions as the second argument. The units of the two arguments must be consistent.

Common usage is ambiguous about some units of temperature. When °C or °F represents a thermometer reading, then the temperature is a unit with an additive constant: $0\text{ °C} = 273.15\text{ K}$, and $0\text{ °F} = 459.67\text{ °R}$. But when °C or °F represents a *difference* in thermometer readings, then the temperature is a unit with no additive constant: $1\text{ °C} = 1\text{ K}$ and $1\text{ °F} = 1\text{ °R}$.

The calculator assumes that the simple temperature units $x\text{ °C}$ and $x\text{ °F}$ represent thermometer temperatures when used as arguments to the functions $<$, $>$, \leq , \geq , $=$, and \neq . This means that, in order to do the calculation, the calculator will first convert any Celsius temperature to Kelvins and any Fahrenheit temperature to Rankines. (For other functions or *compound* temperature units, such as $x\text{ °C}/\text{min}$, the calculator assumes temperature units represent temperature differences, so there is no additive constant involved, and hence no conversion.)

The arithmetic operators $+$, $-$, $\%$, $\%CH$, and $\%T$ treat temperatures as differences, without any additive constant, but require both arguments to be either absolute (K and °R), both °C, or both °F. No other combinations are allowed.

Access:

Flags: Numerical Results (-3)

Input/Output:

| Level 2/Argument 1 | Level 1/Argument 2 | | Level 1/Item 1 |
|----------------------|----------------------|---------------|--|
| z_1 | z_2 | \rightarrow | $z_1 - z_2$ |
| $[array]_1$ | $[array]_2$ | \rightarrow | $[array]_{1-2}$ |
| z | 'symb' | \rightarrow | 'z - symb' |
| 'symb' | z | \rightarrow | 'symb - z' |
| 'symb ₁ ' | 'symb ₂ ' | \rightarrow | 'symb ₁ - symb ₂ ' |
| #n ₁ | n ₂ | \rightarrow | #n ₁ |
| n ₁ | #n ₂ | \rightarrow | #n ₁ |
| #n ₁ | #n ₂ | \rightarrow | #n ₁ |
| $x_1_unit_1$ | y_unit_2 | \rightarrow | $(x_2 - y)_unit_2$ |
| 'symb' | x_unit | \rightarrow | 'symb - x_unit' |
| x_unit | 'symb' | \rightarrow | 'x_unit - symb' |

See also: $+$, $*$, $/$, $=$

/ (Divide)

Type: Function

Description: Divide Analytic Function: Returns the quotient of the arguments: the first argument is divided by the second argument.

A real number a divided by a complex number (x, y) returns:

$$\left(\frac{ax}{x^2 + y^2}, \frac{ay}{x^2 + y^2} \right)$$

A complex number (x, y) divided by a real number a returns the complex number $(x/a, y/a)$.

A complex number (x_1, y_1) divided by another complex number (x_2, y_2) returns this complex quotient:

$$\left(\frac{x_1x_2 + y_1y_2}{x_2^2 + y_2^2}, \frac{y_1x_2 - x_1y_2}{x_2^2 + y_2^2} \right)$$

An array **B** divided by a matrix **A** solves the system of equations **AX=B** for **X**; that is, **X = A⁻¹ B**. This operation uses 15-digit internal precision, providing a more precise result than the calculation INV(A)*B. The matrix must be square, and must have the same number of columns as the array has rows (or elements, if the array is a vector).

A binary integer divided by a real or binary number returns a binary integer that is the integral part of the quotient. (The real number is converted to a binary integer before the division.) A divisor of zero returns # 0.

When dividing two unit objects, the scalar parts and the unit parts are divided separately.

Access:

Flags: Numerical Results (-3)

Input/Output:

| Level 2/Argument 1 | Level 1/Argument 2 | | Level 1/Item 1 |
|----------------------|----------------------|---|--|
| z_1 | z_2 | → | z_1 / z_2 |
| [array] | [[matrix]] | → | [[matrix ⁻¹ × array]] |
| z | 'symb' | → | 'z / symb' |
| 'symb' | z | → | 'symb / z' |
| 'symb ₁ ' | 'symb ₂ ' | → | 'symb ₁ / symb ₂ ' |
| #n ₁ | n ₂ | → | #n ₃ |
| n ₁ | #n ₂ | → | #n ₃ |
| #n ₁ | #n ₂ | → | #n ₃ |
| x_unit ₁ | y_unit ₂ | → | (x / y)_unit ₁ /unit ₂ |
| x | y_unit | → | (x / y)_1/unit |
| x_unit | y | → | (x / y)_unit |
| 'symb' | x_unit | → | 'symb / x_unit' |
| x_unit | 'symb' | → | 'x_unit / symb' |

See also: +, -, *, =

= (Equal)

Type: Function

Description: Equals Analytic Function: Returns an equation formed from the two arguments.

The equals sign equates two expressions such that the difference between them is zero.

In Symbolic Results mode, the result is an algebraic equation. In Numerical Results mode, the result is the difference of the two arguments because = acts equivalent to -. This allows expressions and equations to be used interchangeably as arguments for symbolic and numerical rootfinders.

Common usage is ambiguous about some units of temperature. When °C or °F represents a thermometer reading, then the temperature is a unit with an additive constant: 0 °C = 273.15 K, and 0°F = 459.67°R. But when °C or °F represents a *difference* in thermometer readings, then the temperature is a unit with no additive constant: 1°C=1 K and 1°F = 1°R.

The arithmetic operators +, -, %, %CH, and %T treat temperatures as differences, without any additive constant. However, +, -, %CH, and %T require both arguments to be either absolute (K and °R), both °C, or both °F. No other combinations are allowed.

Access:   ( is the right-shift of the  key).

Flags: Numerical Results (-3)

Input/Output:

| Level 2/Argument 1 | Level 1/Argument 2 | | Level 1/Item 1 |
|----------------------|----------------------|---|--|
| z_1 | z_2 | → | $z_1 = z_2$ |
| z | 'symb' | → | 'z = symb' |
| 'symb' | z | → | 'symb = z' |
| 'symb ₁ ' | 'symb ₂ ' | → | 'symb ₁ = symb ₂ ' |
| y_unit | x | → | y_unit = x |
| y_unit | x_unit | → | y_unit = x_unit |
| 'symb' | x_unit | → | 'symb = x_unit' |
| x_unit | 'symb' | → | 'x_unit = symb' |

See also: DEFINE, EVAL, -

== (Logical Equality)

Type: Function

Description: Logical Equality Function: Tests if two objects are equal.

The function == returns a true result (1) if the two objects are the same type and have the same value, or a false result (0) otherwise. Lists and programs are considered to have the same values if the objects they contain are identical. If one object is algebraic (or a name), and the other is a number (real or complex) or an algebraic, == returns a symbolic comparison expression that can be evaluated to return a test result. Note that == is used for comparisons, while = separates two sides of an equation. If the imaginary part of a complex number is 0, it is ignored when the complex number is compared to a real number.

For unit objects, the two objects must be dimensionally consistent and are converted to common units for comparison. If you use simple temperature units, the calculator assumes the values represent temperatures and not differences in temperatures. For compound temperature units, the calculator assumes temperature units represent temperature differences. For more information on using temperature units with arithmetic functions, refer to the entry for +.

Access:  PRG TEST == ( is the left-shift of the  key).

Flags: Numerical Results (-3)

Input/Output:

| Level 2/Argument 1 | Level 1/Argument 2 | | Level 1/Item 1 |
|----------------------|----------------------|---|---|
| obj ₁ | obj ₂ | → | 0/1 |
| (x,0) | x | → | 0/1 |
| x | (x,0) | → | 0/1 |
| z | 'symb' | → | 'z == symb' |
| 'symb' | z | → | 'symb == z' |
| 'symb ₁ ' | 'symb ₂ ' | → | 'symb ₁ == symb ₂ ' |

See also: SAME, TYPE, <, ≤, >, ≥, ≠

▶ **(Store)**

Type: Command

Description: Store Command: Stores an object into a specified variable. To create a backup object, store the *obj* into the desired backup location (identified as *:n_{port}:name_{backup}*). ▶ will not overwrite an existing backup object. To replace an element of an array or list, use STO. Also use STO to store a graphic object into PICT or a library or backup object into a port.

Access: 

Input/Output:

| Level 2/Argument 1 | Level 1/Argument 2 | | Level 1/Item 1 |
|--------------------|--|---|----------------|
| obj | 'name' | → | obj |
| obj | <i>:n_{port}:name_{backup}</i> | → | obj |

See also: DEFINE, RCL, →, STO

→ **(Create Local)**

Type: Command

Description: Create Local Variables Command: Creates local variables.

Local variable structures specify one or more local variables and a defining procedure.

A local variable structure consists of the → command, followed by one or more names, followed by a defining procedure—either a program or an algebraic. The → command stores objects into local variables with the specified names. The resultant *local variables* exist only while the defining procedure is being executed. The syntax of a local variable structure is one of the following:

- → *name₁ name₂ ... name_n « program »*
- → *name₁ name₂ ... name_n 'algebraic expression'*

Access:   (→ is the right-shift of the  key).

Input/Output:

| Level n/Argument 1 ... Level 1/Argument n | | Level 1/Item 1 |
|---|---|----------------|
| obj ₁ ... obj _n | → | |

See also: DEFINE, LOCAL, STO

- Input:** The input argument or arguments that the operation needs. If the operation uses more than one input argument, details of the arguments and the order in which to supply them are provided: in argument order for algebraic mode and in stack order for RPN mode.
- Output:** The output that the operation produces.
- In RPN mode, the outputs are placed on the stack.
 - In algebraic mode, the outputs are displayed; if there is more than one output, they are written to a list.
- As with the input arguments, the outputs for both algebraic and RPN mode are described.
- Flags:** Details of how flag settings affect the operation of the function or command. See also the section below on CAS Settings.
- Example:** An example of the function or command. Examples are also available in the built-in CAS help on the calculator. The examples given here are shown in Algebraic mode, but can be transferred to RPN mode according to the descriptions given in “Input” and “Output”.
- See also:** Related functions or commands.

CAS Settings

Selecting CAS Settings

CAS settings are selected using the CAS MODES input form, described in Chapter 1 of the User’s Manual. Selecting a mode is equivalent to setting or clearing one of the system flags, the flag numbers are given in the “Flags” part of the operation descriptions.

Pressing the $\boxed{\text{NXT}}$ key in the CAS MODES input form displays a menu that allows the user to calculate settings. For example, if the Modulo field is selected in the CAS MODES form, and $\boxed{\text{NXT}}$ is pressed, the following menu keys are available.

$\boxed{\text{MODE}}$ lists the types of object that can be chosen for this setting. For the modulo, this can be a real number or an integer. For checked mode settings, this can only be a real number; if it is zero the mode is unchecked, if it is anything else the mode is checked.

$\boxed{\text{CALC}}$ lets the user calculate a value for the setting, for example a new value for the modulo setting can be calculated. The $\boxed{\text{MENU}}$ menu key allows the user to switch the heading lines between the “CAS MODES” heading and the normal heading lines, so that the user can see what the current settings are while carrying out a calculation.

$\boxed{\text{RESET}}$ allows the setting to be reset to its default value, or all CAS settings to be reset to their default values.

See Appendix C in the User’s Guide for further details of the CAS settings, and for other information about the CAS. Information on the Help system of the CAS is provided in Appendix C and also in Appendix H of the User’s Guide.

The CAS directory, CASDIR

CAS settings are stored as flag settings, and as variables in the CASDIR directory, which is automatically created as a subdirectory of the HOME directory. Variables in this directory include:

- VX:** A name or list of names of the current CAS variable or variables. Default value is X
- MODULO:** The current modulus used for CAS modulo operations. Default value is 13, but is reset to 3 by the $\boxed{\text{MODE}}$ key in the CAS menu.
- PERIOD:** The period for CAS periodic operations, 2π by default.
- EPS:** The value chosen such that coefficients in a polynomial smaller than this value are replaced with 0 by the EPSX0 command. 1E-10 by default.
- REALASSUME:** A list of the names of variables that some CAS operations treat as real numbers when complex mode is set. If additional assumptions are made on any variables, these are included here. By default the list is {X, Y, t, S1, S2}.

- PRIMIT:** Temporary storage of anti-derivative expressions used during CAS operations.
- MATRIX:** Temporary storage of a matrix used during CAS operations.
- CASINFO:** Temporary storage of graphic display during step-by-step operations.
- PPAR:** Plot parameters.

Points to note when choosing settings

The CAS is a powerful tool, and part of that power lies in the many modes and settings available. This means that if a setting is wrong then the CAS can give unexpected results or error messages. The following points should be observed. If an unexpected error occurs, or an unexpected message is seen, check this list.

- Many CAS commands will give numeric results instead of symbolic results if numeric mode is set instead of being cleared. Though these results may be correct, they will not be what the user wants if a symbolic result is needed. For this reason, the Flags section of most operation descriptions says that numeric mode should not be set.
- If approximate mode is set instead of exact mode, CAS commands will often give reasonable results, but unexpected results can be obtained, because, for example, powers are real numbers, not integers, for instance a cube will be treated as $x^{3.0}$ instead of x^3 . For this reason, the Flags section of most operation descriptions says that exact mode should be set. Some commands, like the numeric solvers, will only find approximate solutions if approximate mode is set.
- CAS operations are designed to work with integers if possible, and some CAS operations round their inputs before using them. FIX 0 mode will round to whole numbers, losing accuracy. STD mode will retain full accuracy, so it is the best display mode to use with the CAS and is used in most of the examples in this chapter.
- For the same reasons, the general solutions, symbolic constants and symbolic arguments flags (flags -1, -2 and -3) should normally be clear when working with the CAS.
- Where possible, integer numbers should be used as input, not real numbers. The functions RND, CEIL and FLOOR can round a real number to a whole real number, and $R \rightarrow I$ will convert a whole real number to an integer.
- If complex inputs are given, approximate mode may need to be set to find solutions, and complex mode must be set (flag -103 set).
- Not only the trigonometry rewriting operations, but some other CAS operations require the angle mode to be set to radians (flag -17 clear), even if it is not immediately obvious that this is so. For this reason, the Flags section of many operation descriptions says that radians mode should be set.
- Some CAS operations will work one step at a time if step-by-step mode is set (flag -100 set). If a result is wanted immediately, and the calculator instead displays one step of the operation, cancel the operation, clear flag -100, then repeat the operation.
- If a mode needs to be changed for an operation to work, the calculator will by default ask if the mode can be changed. If the Silent mode switch flag (flag -120) is set, the calculator changes the mode without asking. If the mode switch disallowed flag (flag -123) is set, the mode will not be changed and an error will occur.
- All the system flags from -99 to -128 are intended for use by the CAS. It is worth reading Appendix C in the User's Guide to learn the detailed effects of these flags on CAS operations and displays.
- Remember that in RPN mode, symbolic expressions typed on the command line should be enclosed in single quote marks 'x + y'. For clarity, it can be helpful to type expressions in single quote marks in Algebraic mode too.
- It is important to write symbolic expressions using the current variable. Some CAS operations will work with this variable, but treat other variables simply as unknown numbers. If an expression has been entered using a variable other than the current variable, it may be simpler to change the current variable in the CAS MODES form, rather than rewrite the whole expression.
- In algebraic mode (flag -95 set), some CAS commands will replace variables with their numeric values before returning a result, even if "argument to symbolic" mode is set (flag -3 clear). In RPN mode,









they will be returned as variables. Some other CAS commands will always replace variables with their numeric results.

- Because of the above, variables used in symbolic operations should not have the same names as variables stored in the current directory/folder (or in directories above this directory). If, for example, x is the current variable, and a variable called 'x' exists in the current directory or in the HOME directory, then the value stored in 'x' might be used instead of the symbolic variable x .
- The modulo value used in modulus calculations is 13 after the calculator is reset. If the CAS modes are reset with CASCFG, the modulo is also 13, but if the modes are reset using  as above, the modulo is 3, otherwise it is the value most recently set. It is important to change this to the required value before carrying out any modulus operations.

Using the CAS

Examples and Help

In addition to the examples in this Command Reference, the built-in CAS help provides examples of CAS operations.

- If an operation is selected from the operations catalog,   , and if help is available, then pressing the  key shows help information. Pressing the  menu key copies the operation to the command line, ready for use.
- If an operation is selected from the CASCMD list,   CASCMD, the same help information is available, but instead of  , there is an  key to copy the name and example to the command line. Evaluating the example and comparing it with the result shown in the help text is a quick way to check if the CAS settings are correct.

Compatibility with Other Calculators

Some CAS operations replace similar operations that were available on older HP calculators. The older operation names have been kept on the hp48gII and the hp49g+ so that programs written for the older calculators will work on the new models without being rewritten. This means that some commands and functions have more than one name; the CAS names are in this part of the Command Reference, the older names are listed in Chapter 3. In other cases, operations that would naturally belong with the Computer Algebra System were already available on the older models; these operations too are described in Chapter 3.

The older models whose programs can be run on the hp48gII and the hp49g+ are the HP 28C and HP 28S, the HP 48S and the HP 48SX, and the HP 48G, HP 48GX and HP 48G+. These models only had the RPL programming language, so programs written for them should be used in RPN mode. The HP 49G is a more recent model which does have the CAS, and Algebraic mode, so programs written for it in either RPL or in Algebraic mode can be used on the hp48gII and the hp49g+. The CAS of the hp48gII and the hp49g+ is also very similar to the CAS of the HP40 models, so programs and books written for them may be helpful.

Extending the CAS

Users can extend the CAS by writing their own functions or commands. Functions can be written as UDFs (User Defined Functions); see the descriptions of DEFINE in Chapter 3 of the calculator User's Guide and in Part A of this Command Reference, and also DEF in this part. The pattern matching commands \uparrow MATCH and \downarrow MATCH allow the user to write programs to edit algebraic expressions. Here is an example of an RPL program using \uparrow MATCH to replace the square root of a square of a symbol with the symbol itself. The wildcard &A means that any symbol or expression squared can be replaced. The conditional expression &A \geq 0 means that the replacement is only carried out if the square root is not of a negative value.

```
« { '√(&A^2)' &A '&A $\geq$ 0' }  $\uparrow$ MATCH »
```

Dealing with unexpected CAS results or messages

If a CAS operation gives an unexpected result or message, check the list of points given in the section on CAS settings. Some problems can be caused by unexpected settings, so it can be helpful to reset all CAS settings to their default values, with the CASCFG command, or with the  key in the CAS settings menu.

Computer algebra command categories listed by menu

CAS operations are listed here in order of the keyboard menus they appear in. These menus can be selected from the CAS menu in $\boxed{\text{APPS}}$, or directly from the keyboard. Many CAS commands are also available from the $\boxed{\text{SYMB}}$ menu, or from the $\boxed{\leftarrow} \text{MTH}$ menu; these menus are not listed here, to avoid duplication. The CAS has its own menu commands too, they are included in the alphabetical list of commands. Operations that do not appear in any menu can be spelled out or selected from $\boxed{\rightarrow} \text{CAT}$.

Algebra commands, $\boxed{\rightarrow} \text{ALG}$

| | | |
|-----------|-------|------|
| COLLECT | | 4-19 |
| EXPAND | | 4-29 |
| FACTOR | | 4-30 |
| LIN | | 4-48 |
| LNCOLLECT | | 4-49 |
| PARTFRAC | | 4-56 |
| SOLVE | | 4-67 |
| SUBST | | 4-69 |
| TEXPAND | | 4-74 |

Arithmetic commands

Arithmetic Integer commands, $\boxed{\leftarrow} \text{ARITH}$ INTEGER

| | | |
|------------|-------|------|
| EULER | | 4-28 |
| IABCUV | | 4-38 |
| IBERNOULLI | | 4-39 |
| ICHINREM | | 4-40 |
| IDIV2 | | 4-40 |
| IEGCD | | 4-40 |
| IQUOT | | 4-43 |
| IREMAINDER | | 4-43 |
| ISPRIME? | | 4-44 |
| NEXTPRIME | | 4-55 |
| PA2B2 | | 4-55 |
| PREVPRIME | | 4-59 |

Arithmetic Polynomial commands, $\boxed{\leftarrow} \text{ARITH}$ POLYNOMIAL

| | | |
|------------|-------|------|
| ABCUV | | 4-12 |
| CHINREM | | 4-17 |
| CYCLOTOMIC | | 4-20 |
| DIV2 | | 4-23 |
| EGCD | | 4-27 |
| FACTOR | | 4-30 |
| FCOEF | | 4-31 |
| FROOTS | | 4-33 |
| GCD | | 4-34 |
| HERMITE | | 4-37 |

| | |
|-----------|------|
| HORNER | 4-38 |
| LAGRANGE | 4-45 |
| LCM | 4-46 |
| LEGENDRE | 4-47 |
| PARTFRAC | 4-56 |
| PTAYL | 4-59 |
| QUOT | 4-60 |
| REMAINDER | 4-61 |
| RESULTANT | 4-62 |
| STURM | 4-69 |
| STURMAB | 4-69 |

Other POLYNOMIAL operations are described in Chapter 3.

Arithmetic Modulo commands,  ARITH MODULO

| | |
|-----------|------|
| ADDTMOD | 4-12 |
| DIV2MOD | 4-24 |
| DIVMOD | 4-25 |
| EXPANDMOD | 4-30 |
| FACTORMOD | 4-31 |
| GCDMOD | 4-35 |
| INVMOD | 4-42 |
| MODSTO | 4-53 |
| MULTMOD | 4-54 |
| POWMOD | 4-58 |
| SUBTMOD | 4-70 |

Other MODULO operations are described in Chapter 3.

Arithmetic Permutation commands,  ARITH PERMUTATION

| | |
|------|------|
| C2P | 4-17 |
| CIRC | 4-18 |
| P2C | 4-55 |

Other Arithmetic commands,  ARITH

| | |
|----------|------|
| DIVIS | 4-24 |
| FACTORS | 4-31 |
| LGCD | 4-48 |
| PROPFRAC | 4-59 |
| SIMP2 | 4-66 |

Calculus commands

Derivation and integration commands,  CALC DERIV. & INTEG.

| | |
|---------|------|
| CURL | 4-19 |
| DERIV | 4-21 |
| DERVX | 4-21 |
| DIV | 4-23 |
| FOURIER | 4-32 |
| HESS | 4-37 |

| | | |
|---------|-------|------|
| IBP | | 4-39 |
| INTVX | | 4-42 |
| LAPL | | 4-46 |
| PREVAL | | 4-58 |
| RISCH | | 4-62 |
| SIGMA | | 4-65 |
| SIGMAVX | | 4-65 |

Limits and series commands,  CALC LIMITS & SERIES

| | | |
|---------|-------|------|
| DIVPC | | 4-25 |
| lim | | 4-48 |
| SERIES | | 4-64 |
| TAYLOR0 | | 4-73 |

Other LIMITS & SERIES operations are described in Chapter 3.

Differential equations commands,  CALC DIFFERENTIAL EQNS

| | | |
|---------|-------|------|
| DESOLVE | | 4-22 |
| ILAP | | 4-41 |
| LAP | | 4-45 |
| LDEC | | 4-47 |

Graphing commands,  CALC GRAPH

| | | |
|---------|-------|------|
| SIGNTAB | | 4-65 |
| TABVAL | | 4-71 |
| TABVAR | | 4-71 |

Other GRAPH operations are described in Chapter 3.

Other Calculus commands,  CALC

| | | |
|-------|-------|------|
| DERVX | | 4-21 |
| INTVX | | 4-42 |

These two operations are available directly from the CALC menu as well as being in the Derivation and Integration commands menu.

Exp and Lin commands,  EXP&LN

| | | |
|-----------|-------|------|
| EXPLN | | 4-30 |
| LIN | | 4-48 |
| LNCOLLECT | | 4-49 |
| TEXPAND | | 4-74 |
| TSIMP | | 4-77 |

Other EXP & LN operations are described in Chapter 3.

Matrix-related commands

Create,  MATRICES CREATE

| | | |
|-------------|-------|------|
| AUGMENT | | 4-15 |
| HILBERT | | 4-37 |
| VANDERMONDE | | 4-78 |

Other CREATE operations are described in Chapter 3.

Operations,  MATRICES OPERATIONS

| | |
|----------|------|
| AXL | 4-15 |
| AXM | 4-16 |
| HADAMARD | 4-36 |
| MAD | 4-51 |

Other operations in the OPERATIONS submenu are described Chapter 3.

All operations in the FACTORIZATION submenu are described Chapter 3.

Quadratic form,  MATRICES QUADRATIC FORM

| | |
|-----------|------|
| AXQ | 4-16 |
| CHOLESKY | 4-18 |
| GAUSS | 4-33 |
| QXA | 4-60 |
| SYLVESTER | 4-70 |

Linear Systems,  MATRICES LINEAR SYSTEMS

| | |
|----------|------|
| LINSOLVE | 4-49 |
| REF | 4-60 |
| RREF | 4-62 |
| rref | 4-63 |
| SYST2MAT | 4-71 |

Linear Applications,  MATRICES LINEAR APPL

| | |
|--------|------|
| IMAGE | 4-41 |
| ISOM | 4-43 |
| KER | 4-45 |
| MKISOM | 4-53 |

Eigenvectors,  MATRICES EIGENVECTORS

| | |
|---------|------|
| DIAGMAP | 4-22 |
| JORDAN | 4-44 |
| PCAR | 4-56 |
| PMINI | 4-56 |

Other operations in the EIGENVECTORS submenu are described in Chapter 3.

Vector,  MATRICES VECTOR

| | |
|-------------|------|
| BASIS | 4-16 |
| GRAMSCHMIDT | 4-35 |
| IBASIS | 4-38 |

Other operations in the VECTOR submenu are described in Chapter 3.

Symbolic solve commands,  S.SLV

| | |
|----------|------|
| DESOLVE | 4-22 |
| LDEC | 4-47 |
| LINSOLVE | 4-49 |
| SOLVEVX | 4-68 |

| | | |
|-------|-------|------|
| SOLVE | | 4-67 |
| ZEROS | | 4-80 |

Other S.SLV operations are described in Chapter 3.

Trigonometry commands, TRIG

All operations in the HYPERBOLIC submenu are described in Chapter 3.

| | | |
|----------|-------|------|
| ACOS2S | | 4-12 |
| ASIN2C | | 4-14 |
| ASIN2T | | 4-14 |
| ATAN2S | | 4-15 |
| HALFTAN | | 4-36 |
| SINCOS | | 4-67 |
| TAN2SC | | 4-72 |
| TAN2SC2 | | 4-73 |
| TCOLLECT | | 4-74 |
| TEXPAND | | 4-74 |
| TLIN | | 4-74 |
| TRIG | | 4-75 |
| TRIGCOS | | 4-75 |
| TRIGSIN | | 4-76 |
| TRIGTAN | | 4-76 |
| TSIMP | | 4-77 |

Convert commands, CONVERT

All operations in the UNITS and BASE submenus are described in Chapter 3.

Trigonometric conversions, CONVERT TRIG CONV

| | | |
|---------|-------|------|
| ACOS2S | | 4-12 |
| ASIN2C | | 4-14 |
| ASIN2T | | 4-14 |
| ATAN2S | | 4-15 |
| HALFTAN | | 4-36 |
| SINCOS | | 4-67 |
| TAN2SC | | 4-72 |
| TAN2SC2 | | 4-73 |
| TLIN | | 4-74 |
| TRIG | | 4-75 |
| TRIGCOS | | 4-75 |
| TRIGSIN | | 4-76 |
| TSIMP | | 4-77 |

Rewrite expression, CONVERT REWRITE

| | | |
|---------|-------|------|
| DISTRIB | | 4-23 |
| EXP2POW | | 4-29 |

| | | |
|-----------|-------|------|
| EXPLN | | 4-30 |
| FDISTRIB | | 4-32 |
| LIN | | 4-48 |
| LNCOLLECT | | 4-49 |
| POWEXPAND | | 4-57 |
| SIMPLIFY | | 4-66 |

Other operations in the REWRITE submenu are described in Chapter 3.

Matrix convert,  **CONVERT** MATRIX CONVERT

| | | |
|----------|-------|------|
| AXL | | 4-15 |
| AXQ | | 4-16 |
| QXA | | 4-60 |
| SYST2MAT | | 4-71 |

Other CAS operations,  **CAT**

These operations are in other menus, as described in Access for each one, or can be accessed with

 **CAT** .

Other mathematics operations

| | | |
|-------------|-------|------|
| DEGREE | | 4-21 |
| DOMAIN | | 4-25 |
| DROITE | | 4-26 |
| d/z | | 4-26 |
| EPSX0 | | 4-27 |
| EXLR | | 4-28 |
| EXP2HYP | | 4-28 |
| FXND | | 4-33 |
| GBASIS | | 4-34 |
| GREDUCE | | 4-35 |
| LCXM | | 4-46 |
| LIMIT | | 4-48 |
| LNAME | | 4-49 |
| LVAR | | 4-50 |
| MSLV | | 4-54 |
| P2C | | 4-55 |
| POTENTIAL | | 4-57 |
| REORDER | | 4-61 |
| RREFMOD | | 4-63 |
| SEVAL | | 4-64 |
| TAN2CS2 | | 4-72 |
| TCHEBYCHEFF | | 4-73 |
| TRUNC | | 4-77 |
| VPOTENTIAL | | 4-79 |
| XNUM | | 4-80 |

| | | |
|----------|-------|------|
| XQ | | 4-80 |
| ? | | 4-81 |
| ∞ | | 4-81 |

CAS menu commands, CAT

These commands display menus or lists of CAS operations.

| | | |
|------------|-------|------|
| ALGB | | 4-13 |
| ARIT | | 4-13 |
| CONSTANTS | | 4-19 |
| DIFF | | 4-23 |
| EXP&LN | | 4-28 |
| INTEGER | | 4-42 |
| MAIN | | 4-51 |
| MATHS | | 4-51 |
| MATR | | 4-52 |
| MENUXY | | 4-52 |
| MODULAR | | 4-53 |
| POLYNOMIAL | | 4-57 |
| REWRITE | | 4-62 |
| TESTS | | 4-74 |
| TRIGO | | 4-76 |

CAS utility operations

| | | |
|-----------|-------|------|
| ADDTOREAL | | 4-13 |
| ASSUME | | 4-14 |
| CASCFG | | 4-17 |
| CASCMD | | 4-17 |
| DEDICACE | | 4-20 |
| DEF | | 4-20 |
| HELP | | 4-36 |
| LOCAL | | 4-50 |
| RCLVX | | 4-60 |
| STORE | | 4-68 |
| STOVX | | 4-68 |
| UNASSIGN | | 4-77 |
| UNASSUME | | 4-78 |
| UNBIND | | 4-78 |
| VER | | 4-79 |

Alphabetical command list

The following pages contain the commands in alphabetical order. See "Computer algebra command categories" on page 4-5 to view the commands in the order that they appear on the menus. Chapters 11 to 16 in the User's Guide provide examples using many of these commands.

ABCUV

| | |
|---------------------|--|
| Type: | Command |
| Description: | Returns a solution in polynomials u and v of $au+bv=c$ where a and b are polynomials in the current CAS independent variable, and c is a value. |
| Access: | Arithmetic,  ARITH POLYNOMIAL |
| Input: | Level 3/Argument 1: The polynomial corresponding to a . Level 2/Argument 2: The polynomial corresponding to b . Level 1/Argument 3: The value corresponding to c . |
| Output: | Level 2/Item 1: The solution corresponding to u . Level 1/Item 2: The solution corresponding to v . |
| Flags: | Exact mode must be set (flag -105 clear). Numeric mode must not be set (flag -3 clear). Radians mode must be set (flag -17 set). |
| Example: | Find a solution in polynomials u and v for the following equation: $(x^2 + x + 1)u + (x^2 + 4)v = 13$ |
| Command: | ABCUV (X^2+X+1, X^2+4, 13) |
| Result: | { - (X+3) , X+4 } |
| See also: | IABCUV, EGCD |

ACOS2S

| | |
|---------------------|--|
| Type: | Command |
| Description: | Transforms an expression by replacing $\text{acos}(x)$ in subexpressions with $\pi/2-\text{asin}(x)$. |
| Access: | Trigonometry,  TRIG |
| Input: | The expression to transform. |
| Output: | The transformed expression. |
| Flags: | Exact mode must be set (flag -105 clear). Numeric mode must not be set (flag -3 clear). Radians mode must be set (flag -17 set). |
| Example: | Simplify the following expression: $\arccos\left(\frac{2}{3}\right) + \arccos(x)$ |
| Command: | ACOS2S (ACOS (2/3) +ACOS (X)) |
| Result: | $\pi/2 - \text{ASIN} (2/3) + \pi/2 - \text{ASIN} (X)$ |
| See also: | ASIN2C, ASIN2T, ATAN2S |

ADDTMOD

| | |
|---------------------|---|
| Type: | Function |
| Description: | Adds two expressions or values, modulo the current modulus. |

Access: Arithmetic,  ARITH MODULO

Input: Level 2/Argument 1: The first expression.
Level 1/Argument 2: The second expression.

Output: The sum of the two expressions, modulo the current modulus.

Flags: Exact mode must be set (flag -105 clear).
Numeric mode must not be set (flag -3 clear).
Radians mode must be set (flag -17 set).

Example: Express the result of the following addition in modulo 7.
 $(x^2+3x+6)+(9x+3)$
Note: Before trying this example, use the CAS modes input form to set the modulo to 7.

Command: `ADDTMOD (X^2+3*X+6, 9*X+3)`

Result: $x^2-2*x+2$

ADDTOREAL

Type: Command

Description: Adds specified global names to the reserved variable REALASSUME. This is a list of the global variables that will be treated by some CAS operations as *real* numbers when Complex mode is set.
If a variable is already in the REALASSUME list, this command removes any additional assumptions made on it by ASSUME.

Access: Catalog,  CAT

Input: Level 1/Item 1: The name of the global variable to be added to the REALASSUME list, or a list of names.

Output: No output in RPN mode, NOVAL in Algebraic mode.

Flags: If the “all variables are real” flag is set (flag -128 set), ADDTOREAL will not add anything to the REALASSUME list, as all variables are assumed real anyway. In this case it will only remove further assumptions made by ASSUME.

See also: ASSUME, DEF, STORE, UNASSUME, UNBIND

ALGB

Type: Command

Description: Displays a menu or list of CAS algebraic operations.

Access: Catalog,  CAT

Flags: If the CHOOSE boxes flag is clear (flag -117 clear), displays the operations as a numbered list. If the flag is set, displays the operations as a menu of function keys.

See also: ARIT, CONSTANTS, DIFF, EXP&LN, INTEGER, MAIN, MATHS, MATR, MODULAR, POLYNOMIAL, REWRITE, TESTS, TRIGO

ARIT

Type: Command

Description: Displays a menu or list showing the three CAS submenus for arithmetical operations, INTEGER, MODULAR and POLYNOMIAL.

Access: Catalog,  CAT

Flags: If the CHOOSE boxes flag is clear (flag -117 clear), displays the submenus as a numbered list. If the flag is set, displays the operations as a menu of function keys.

See also: ALGB, CONSTANTS, DIFF, EXP&LN, INTEGER, MAIN, MATHS, MATR, MODULAR, POLYNOMIAL, REWRITE, TESTS, TRIGO

ASIN2C

Type: Command

Description: Transforms an expression by replacing $\text{asin}(x)$ subexpressions with $\pi/2 - \text{acos}(x)$ subexpressions.

Access: Trigonometry,  TRIG

Input: An expression

Output: The transformed expression.

Flags: Exact mode must be set (flag -105 clear).
Numeric mode must not be set (flag -3 clear).
Radians mode must be set (flag -17 set).

See also: ACOS2S, ASIN2T, ATAN2S

ASIN2T

Type: Command

Description: Transforms an expression by replacing $\text{asin}(x)$ subexpressions with the following:

$$\text{atan}\left(\frac{x}{\sqrt{1-x^2}}\right)$$

Access: Trigonometry,  TRIG

Input: An expression.

Output: The transformed expression.

Flags: Exact mode must be set (flag -105 clear).
Numeric mode must not be set (flag -3 clear).
Radians mode must be set (flag -17 set).

See also: ASIN2C, ACOS2S, ATAN2S

ASSUME

Type: Function

Description: Adds global names to the reserved variable REALASSUME, with specific assumptions. REALASSUME is a list of the global variables that will be considered by some CAS operations to represent *real* numbers when complex mode is set. ASSUME adds further assumptions, for example that a variable is greater than or equal to zero. Assumptions must be of the form $v \leq \text{expression}$, or $v \geq \text{expression}$, where v is the variable name. Several assumptions can be combined.
These assumptions are used by the solve commands; for example if a variable is assumed to be greater than zero then the solvers will not look for solutions where that variable is negative. Some of the solvers will give complex solutions for variables even if they are in REALASSUME.

Access: Catalog,  CAT

Input: Level 1/Item 1: An expression giving the name of the global variable to be added to the REALASSUME list, and the assumption to be placed on it, or a list of such assumptions.

Output: Level 1/Item 1: The input expression or list of expressions.

Example: Add the CAS assumption that the global variable Z is real and positive. Note that `ASSUME` will replace $Z > 0$ with $Z \geq 0$, which does not guarantee that Z is positive, so `Z ≥ MINR` is used instead, which guarantees that Z is greater than or equal to the smallest positive number the calculator recognizes.

Command: `ASSUME (Z ≥ MINR)`

Result: $Z \geq \text{MINR}$

See also: `ADDTOREAL`, `UNASSUME`

ATAN2S

Type: Command

Description: Transforms an expression by replacing `atan(x)` subexpressions with the following:

$$\text{asin}\left(\frac{x}{\sqrt{x^2 + 1}}\right)$$

Access: Trigonometry,  `TRIG`

Input: An expression.

Output: The transformed expression.

Flags: Exact mode must be set (flag `-105` clear).
Numeric mode must not be set (flag `-3` clear).
Radians mode must be set (flag `-17` set).

See also: `ASIN2C`, `ACOS2S`, `ASIN2T`

AUGMENT

Type: Command

Description: Concatenate two lists, a list and an element, or a vector and an element. Also creates a matrix from component row vectors.

Access: Matrices,  `MATRICES` `CREATE`

Input: Level 2/Argument 1: A vector, a list, a matrix, or a string.
Level 1/Argument 2: A vector, a list, a matrix, or an element.

Output: The matrix, list or string formed by combining the arguments. In the case of a string in level 2, `AUGMENT` acts exactly like “+” or “ADD”.

Example 1: Append 3 to the list $\{1, 2\}$:

Command: `AUGMENT ({1, 2}, 3)`

Result: $\{1, 2, 3\}$

Example 2: Combine the rows $[1, 2, 3]$ and $[4, 5, 6]$ into a matrix:

Command: `AUGMENT ([1, 2, 3], [4, 5, 6])`

Result:
$$\begin{bmatrix} 1 & 2 & 3 \\ 4 & 5 & 6 \end{bmatrix}$$

AXL

Type: Command

Description: Converts a list to an array, or an array to a list.

Access: Convert,  `CONVERT` `MATRIX CONVERT`, or matrices  `MATRICES` `OPERATIONS`

Input: A list or an array.

Output: If the input is a list, returns the corresponding array. If the input is an array, returns the corresponding list.

Example: Convert the following matrix to a list:

$$\begin{bmatrix} 0 & 1 \\ 1 & 0 \end{bmatrix}$$

Command: AXL ([[0, 1] [1, 0]])

Result: { {0, 1}, {1, 0} }

See also: AXM, AXQ

AXM

Type: Command

Description: Converts a numeric array (object type 3) to a symbolic matrix (object type 29), or a symbolic matrix to a numeric array.

Access: Matrices,  MATRICES OPERATIONS

Input: A numeric array or a symbolic matrix.

Output: The corresponding symbolic matrix or numeric array.

Flags: Exact mode must be set (flag -105 clear).
Numeric mode must not be set (flag -3 clear).

See also: AXL, AXQ

AXQ

Type: Command

Description: Converts a square matrix into the associated quadratic form.

Access: Convert,  CONVERT MATRIX CONVERT, or matrices  MATRICES QUADRATIC FORM

Input: Level 2/Argument 1: An $n \times n$ matrix.
Level 1/Argument 2: A vector containing n variables.

Output: Level 2/Item 1: The corresponding quadratic form.
Level 1/Item 2: The vector containing the variables.

Flags: Exact mode must be set (flag -105 clear).
Numeric mode must not be set (flag -3 clear).
Radians mode must be set (flag -17 set).

Example: Find the quadratic form, expressed in terms of x , y , and z , associated with the following matrix:

$$\begin{bmatrix} 3 & 6 & 0 \\ 2 & 4 & 1 \\ 1 & 1 & 1 \end{bmatrix}$$

Command: AXQ ([[3, 6, 0] [2, 4, 1] [1, 1, 1]] , [X, Y, Z])



Result: { $3 * X^2 + (8 * Y + Z) * X + (4 * Y^2 + 2 * Z * Y + Z^2)$, [X, Y, Z] }

See also: AXL, AXM, GAUSS, QXA

BASIS

Type: Command

Description: Determines the basis of a sub-space of the n -space R^n .

Access: Matrices,  MATRICES  VECTOR

Input: A list of vectors defining a vector sub-space of R^n .

Output: A list containing the vectors of a basis of the vector sub-space.

Flags: Exact mode must be set (flag -105 clear).
Numeric mode must not be set (flag -3 clear).

Example: Find the vectors that form a basis of the sub-space defined by [1,2,3], [1,1,1], and [2,3,4]

Command: BASIS ({ [1, 2, 3] , [1, 1, 1] , [2, 3, 4] })

Result: { [1, 0, -1] , [0, 1, 2] }

See also: IBASIS

C2P

Type: Command

Description: Takes a list of cycles as an argument, and returns the equivalent permutation. In other words, finds a permutation from its cyclical decomposition.

Access: Arithmetic,  ARITH PERMUTATION

Input: A list of cycles equivalent to a permutation. For example, the list {1,3,5} defines a cycle C , such that $C(1)=3$, $C(3)=5$ and $C(5)=1$, while items 2 and 4 are not changed. This could be followed by {2,4} which defines a cycle C , such that $C(2)=4$, and $C(4)=2$.

Output: A list representing the permutation equivalent to the cycles.

Example: Convert the cycles given by {{1,3,5},{2,4}} into a permutation:



Command: C2P ({ {1,3,5}, {2,4} })

Result: { 3 , 4 , 5 , 2 , 1 }

See also: P2C, CIRC

CASCFG

Type: Command



Description: Restores the default CAS mode settings. This command is almost equivalent to pressing , then selecting "Reset all" and pressing , when the CAS Modes input form is displayed. The difference is that CASCFG sets the modulus value to 13, whereas "Reset all" sets the modulus to 3.

Access: Catalog,  CAT

CASCMD

Type: Command

Description: Displays a list of CAS operations. Selecting one with OK displays a description, related operations, an example of the operation, and the option to copy the example to the command line. More details are given in Appendix C and Appendix H of the User's Guide. If level 1 of the stack contains a string, the list of CAS operations will be displayed beginning at this point.

Access: Catalog,  CAT , or tools  

See also: HELP

CHINREM

Type: Command

Description: Chinese Remainder function. Solves a system of simultaneous polynomial congruences in the ring $Z[x]$.

Access: Arithmetic,  ARITH POLYNOMIAL

Input: Level 2/Argument 1: A vector of the first congruence (expression and modulus).
 Level 1/Argument 2: A vector of the second congruence (expression and modulus).

Output: A vector of the solution congruence (expression and modulus).

Flags: Exact mode must be set (flag -105 clear).
 Numeric mode must not be set (flag -3 clear).
 Radians mode must be set (flag -17 set).

Example: Solve the following simultaneous congruences for the polynomial u :

$$u \equiv x^2 + 1 \pmod{x+2}$$

$$u \equiv x - 1 \pmod{x+3}$$

Command: CHINREM ([X^2+1, X+2] , [X-1, X+3])

Result: [X^3+2*X^2+5, - (X^2+5*X+6)]

See also: EGCD, ICHINREM

CHOLESKY

Type: Command

Description: Returns the Cholesky factorization of a square matrix.

Access: Matrices,  MATRICES QUADRATIC FORM

Input: A positive square matrix, M

Output: An upper triangular matrix, P , such that ${}^tP^*P=M$. (tP is the transpose of P .)

Flags: Exact mode must be set (flag -105 clear).
 Numeric mode must not be set (flag -3 clear).
 Radians mode must be set (flag -17 set).

Example: Find the Cholesky factorization of:

$$\begin{bmatrix} 1 & 1 \\ 1 & 5 \end{bmatrix}$$

Command: CHOLESKY $\left(\begin{bmatrix} 1 & 1 \\ 1 & 5 \end{bmatrix} \right)$

Result: $\begin{bmatrix} 1 & 1 \\ 0 & 2 \end{bmatrix}$

CIRC

Type: Command

Description: Composes two permutations.

Access: Arithmetic,  ARITH PERMUTATION

Input: Two lists, $L1$ and $L2$, representing two permutations. The composition $L1 \circ L2$ is the permutation equivalent to performing permutation $L2$ first and $L1$ second.

Level 2/Argument 1: $L1$
 Level 1/Argument 2: $L2$

Output: A list representing the single equivalent permutation, $L = L1 \circ L2$

Example: Compose the permutations given by $\{3,4,5,2,1\}$ and $\{2,1,4,3,5\}$

Command: CIRC($\{3,4,5,2,1\}$, $\{2,1,4,3,5\}$)

Result: $\{4,3,2,5,1\}$

See also: C2P, P2C

COLLECT

Type: Command

Description: Factorizes a polynomial or an integer. This command is identical to the COLCT command and similar to the FACTOR command. Unlike FACTOR it does not factorize symbolically into square roots. It is included to ensure backward-compatibility with earlier calculators.

Access: Algebra,  ALG

Input: An expression or an integer

Output: The factorized expression, or the integer expressed as the product of prime numbers.

Flags: Exact mode must be set (flag -105 clear).
Numeric mode must not be set (flag -3 clear).
Radians mode must be set (flag -17 set).
If complex inputs are given, complex mode must be set (flag -103 set).

Example: Factorize the following:

$$x^2 + 5x + 6$$

Command: COLLECT (X^2+5*X+6)

Result: (X+2) (X+3)

See also: COLCT, EXPAND, FACTOR

CONSTANTS

Type: Command

Description: Displays a menu or list of CAS symbolic constants.

Access: Catalog,  CAT

Flags: If the CHOOSE boxes flag is clear (flag -117 clear), displays the operations as a numbered list. If the flag is set, displays the operations as a menu of function keys.

See also: ALGB, ARIT, DIFF, EXP&LN, INTEGER, MAIN, MATHS, MATR, MODULAR, POLYNOMIAL, REWRITE, TESTS, TRIGO

CURL

Type: Function

Description: Returns the curl of a three-dimensional vector function.

Access: Calculus,  CALC DERIV. & INTEG.

Input: Level 2/Argument 1: A three-dimensional vector function of three variables.
Level 1/Argument 2: An array comprising the three variables.

Output: The curl of the vector function with respect to the specified variables.

Flags: Exact mode must be set (flag -105 clear).
Numeric mode must not be set (flag -3 clear).

Example: Find the curl of the following vector function:

$$v = x^2 y \tilde{i} + x^2 y \tilde{j} + y^2 z \tilde{k}$$

Command: CURL ([X^2*Y, X^2*Y, Y^2*Z] , [X, Y, Z])

Result: [Z*2*Y, 0, Y*2*X-X^2]

See Also: DIV, HESS, VPOTENTIAL

CYCLOTOMIC

Type: Function

Description: Returns the cyclotomic polynomial of order n . This is the polynomial whose roots are all the n th roots of 1, except those that are also roots of 1 for smaller values of n . For example, if n is 4, the 4th roots of 1 are $\{1, i, -1, -i\}$, but 1 is the 1st root of 1 and -1 is a 2nd root of 1, so only i and $-i$ are left, giving the polynomial $(x-i)(x+i) = x^2+1$.

Access: Arithmetic,  ARITH POLYNOMIAL

Input: A non-negative integer n

Output: The cyclotomic polynomial of order n .

Flags: Exact mode must be set (flag -105 clear).
Numeric mode must not be set (flag -3 clear).

Example: Find the 20th cyclotomic polynomial.

Command: CYCLOTOMIC (20)

Result: $X^8 - X^6 + X^4 - X^2 + 1$

DEDICACE

Type: Function

Description: Displays a greeting from the CAS team and dedication to all HP calculator users.

Access: Catalog,  CAT

Example: In algebraic mode, the message can be extended. Try: DEDICACE (Salutations)

DEF

Type: Function

Description: Defines a variable or a function. Works like the DEFINE command, except that it returns a result and can be included in an algebraic expression. Given an expression as input, DEF stores the expression, unlike STORE which evaluates the expression and stores the numerical value.

Access: Catalog,  CAT

Input: Level 1/Argument 1: An expression of the form
 $name = expression$ or
 $name(name_1, \dots, name_n) = expression(name_1, \dots, name_n)$

In the first case, $name$ is the name of a variable, and $expression$ is an expression or a number to be stored in the variable. If the variable does not exist, it is created in the current directory. In the second case, $name$ is the name of a variable that will be treated as a function, $name_1$ to $name_n$ are formal variables used to define inputs the function will take.

Output: Level 1/Item 1: Unlike DEFINE, which returns NOVAL in Algebraic mode, and no result in RPN mode, DEF returns the expression used as the input.

Flags: Exact mode must be set (flag -105 clear).
Numeric mode must not be set (flag -3 clear).

Example 1: Define a new function that calculates:
 $(a-b)/(a+b)$

Command: DEF (NEW (A, B) = (A-B) / (A+B))

Result: NEW (A, B) = (A-B) / (A+B)

Example 2: Check that the newly defined function works:

Command: NEW (2, 1)

Result: 1/3

See also: DEFINE, STORE

DEGREE

Type: Function

Description: Returns the degree of a polynomial expression. Returns 0 for a constant expression, but -1 if the expression is zero.

Access: Catalog,  _CAT

Input: Level 1/Argument 1: A polynomial expression or equation; all powers must be integers or real numbers with no fractional part.

Output: Level 1/Item 1: An integer representing the highest power in the polynomial. If the input contains powers of more than one variable, including the current variable, returns the highest power of the current variable. If the input contains powers of more than one variable, not including the current variable, returns the highest power of the first symbolic variable (one that is not stored in the current directory path). If the input contains powers of more than one variable, and all the variables are stored in the current directory path, returns the highest power of any of the variables.

Flags: If exact mode is set (flag -105 clear), the result is returned as an integer, otherwise it is returned as a real number.

Example 1: Find the degree of the polynomial represented by:
 $x^2 - 17 = x^3 + 2x$

Command: DEGREE (x^2 - 17 = x^3 + 2 * X)

Result: 3

DERIV

Type: Function

Description: Returns the partial derivatives of a function, with respect to the specified variables.

Access: Calculus,  CALCULUS or  CALC DERIV. & INTEG.

Input: Level 2/Argument 1: A function or a list of functions.
Level 1/Argument 2: A variable, or a vector of variables. The variable or variables must not exist as variables stored in the current directory nor directories above it.

Output: The derivative, or a vector of the derivatives, of the function or functions.

Flags: Exact mode must be set (flag -105 clear).
Numeric mode must not be set (flag -3 clear).

Example: Find the gradient of the following function of the spatial variables x , y , and z :
 $2x^2y + 3y^2z + zx$

Command: DERIV (2 * X^2 * Y + 3 * Y^2 * Z + Z * X, [X, Y, Z])
EXPAND (ANS (1))

Result: [4 * Y * X + Z, 2 * X^2 + 6 * Z * Y, X + 3 * Y^2]

See also: DERVX, dn , ∂ , POTENTIAL

DERVX

Type: Function

Description: Returns the derivative of a function with respect to the current variable. This variable must not exist as a variable stored in the current directory path.

Access: Calculus,  CALC or  CALCULUS or  CALC DERIV. & INTEG.

Input: The function or list of functions to be differentiated.
Output: The derivative, or a vector of the derivatives, of the function or functions.
Flags: Exact mode must be set (flag -105 clear).
 Numeric mode must not be set (flag -3 clear).
See also: DERIV, dn , ∂

DESOLVE

Type: Command
Description: Solves certain first-order ordinary differential equations with respect to the current variable.
Access: Symbolic solve, \leftarrow SSLV or calculus, \leftarrow CALC DIFFERENTIAL EQNS.
Input: Level 2/Argument 1: A first-order differential equation.
 Level 1/Argument 2: The function to solve for.
Output: The solution to the equation, either y as a function of x or x as a function of y , or x and y as functions of a parameter.
Flags: Exact mode must be set (flag -105 clear).
 Numeric mode must not be set (flag -3 clear).
Example: Solve the following differential equation:

$$y'(x) + 2y(x) = e^{3x}$$
Command: DESOLVE (d1Y (X) +2*Y (X) =EXP (3*X) , Y (X))
 (See the description of dn and Chapter 16 of the User's Guide for an explanation of the use of "d1" for a derivative.)
Result: { Y (X) = (1/5*EXP (5*X) +cC0) * (1/EXP (X) ^2) }
See also: dn , LDEC

DIAGMAP

Type: Command
Description: Applies an holomorphic operator to a diagonalizable matrix.
Access: Matrices, \leftarrow MATRICES \leftarrow NXT EIGENVECTORS.
Input: Level 2/Argument 1: A diagonalizable matrix.
 Level 1/Argument 2: An operator, expressed as a function. The function can be stored in a variable with DEF, or can be a program, or a single expression.
Output: The matrix that results from applying the operator to the matrix.
Flags: Exact mode must be set (flag -105 clear).
 Numeric mode must not be set (flag -3 clear).

Example: Apply the operator e^x to the matrix $\begin{bmatrix} 1 & 1 \\ 0 & 2 \end{bmatrix}$
Command: DIAGMAP $\left(\begin{bmatrix} 1 & 1 \\ 0 & 2 \end{bmatrix}, \ll \rightarrow X \ll \text{EXP}(X) \gg \gg \right)$
 or DIAGMAP ([[1, 1] , [0, 2]] , exp (X))
Result: $\begin{bmatrix} \text{EXP}(1) - \text{EXP}(1) + \text{EXP}(2) & \\ 0 & \text{EXP}(2) \end{bmatrix}$

DIFF

Type: Command

Description: Displays a menu or list containing the CAS commands for differential calculus, including commands for working with series.

Access: Catalog,  CAT

Flags: If the CHOOSE boxes flag is clear (flag -117 clear), displays the operations as a numbered list. If the flag is set, displays the operations as a menu of function keys.

See also: ALGB, ARIT, CONSTANTS, EXP&LN, INTEGER, MAIN, MATHS, MATR, MODULAR, POLYNOMIAL, REWRITE, TESTS, TRIGO

DISTRIB

Type: Command

Description: Applies one step of the distributive property of multiplication and division with respect to addition and subtraction. Used for single-stepping through a multi-step distribution.

Access:  CONVERT REWRITE

Input: An expression.

Output: An equivalent expression that results from applying the distributive property of multiplication over addition one time.

Flags: Exact mode must be set (flag -105 clear).
Numeric mode must not be set (flag -3 clear).

Example: Expand $(X+1)(X-1)(X+2)$.

Command: DISTRIB ((X+1) * (X-1) * (X+2))

Result: $X * (X-1) * (X+2) + 1 * (X-1) * (X+2)$

See also: FDISTRIB

DIV

Type: Command

Description: Returns the divergence of a vector function.

Access: Calculus,  CALC DERIV. & INTEG.

Input: Level 2/Argument 1: An array representing a vector function.
Level 1/Argument 2: An array containing the variables.

Output: The divergence of the vector function with respect to the specified variables.

Flags: Exact mode must be set (flag -105 clear).
Numeric mode must not be set (flag -3 clear).

Example: Find the divergence of the following vector function:

$$v = x^2 \underline{y}i + x^2 \underline{y}j + y^2 \underline{z}k$$

Command: DIV ([X^2*Y, X^2*Y, Y^2*Z] , [X, Y, Z])

Result: $Y * (2 * X) + (X^2 + Y^2)$

See also: CURL, HESS

DIV2

Type: Command

Description: Performs euclidean division on two expressions. Step-by-step mode is available with this command.

Access: Arithmetic, $\boxed{\leftarrow}$ ARITH POLYNOMIAL

Input: Level 2/Argument 1: The dividend.
Level 1/Argument 2: The divisor.

Output: Level 2/Item 1: The quotient.
Level 1/Item 2: The remainder.

Flags: Exact mode must be set (flag -105 clear).
Numeric mode must not be set (flag -3 clear).
Step-by-step mode can be set (flag -100 set).
Radians mode must be set (flag -17 set).

Example: Perform the following division:

$$\frac{x^2 + x + 1}{2x + 4}$$

Command: DIV2 (X^2+X+1, 2*X+4)

Result: { 1/2 (X-1) , 3 }

DIV2MOD

Type: Command

Description: Performs euclidean division on two expressions modulo the current modulus.

Access: Arithmetic, $\boxed{\leftarrow}$ ARITH MODULO

Input: Level 2/Argument 1: The dividend.
Level 1/Argument 2: The divisor.

Output: Level 2/Item 1: The quotient.
Level 1/Item 2: The remainder.

Flags: Exact mode must be set (flag -105 clear).
Numeric mode must not be set (flag -3 clear).
Radians mode must be set (flag -17 set).

Example: Find the result of $\frac{x^3 + 4}{x^2 - 1}$, modulo 3.

Command: DIV2MOD (X^3+4, X^2-1)

Result: { X X+1 }

DIVIS

Type: Command

Description: Returns a list of divisors of a polynomial or an integer.

Access: Arithmetic, $\boxed{\leftarrow}$ ARITH or $\boxed{\text{SYMB}}$ ARITH

Input: A polynomial or an integer.

Output: A list containing the expressions or integers that exactly divide into the input.

Flags: Exact mode must be set (flag -105 clear).
Numeric mode must not be set (flag -3 clear).

Example: Find the divisors of the following polynomial:

$$x^2 + 3x + 2$$

Command: DIVIS (X^2+3*X+2)

Result: { 1, X+1, X+2, X^2+3*X+2 }

See also: DIV2

DIVMOD

- Type:** Function
- Description:** Divides two expressions modulo the current modulus.
- Access:** Arithmetic,  ARITH MODULO
- Input:** Level 2/Argument 1: The dividend.
Level 1/Argument 2: The divisor.
- Output:** The quotient of the terms modulo the current modulus.
- Flags:** Exact mode must be set (flag -105 clear).
Numeric mode must not be set (flag -3 clear).
- Example:** Modulo 3, divide $5x^2+4x+2$ by x^2+1 .
- Command:** `DIVMOD (5*X^2+4*X+2, X^2+1)`
- Result:** $-((X^2-X+1) / X^2+1)$

DIVPC

- Type:** Command
- Description:** Returns a Taylor polynomial for the quotient of two polynomial expressions.
- Access:** Calculus,  CALC LIMITS & SERIES
- Input:** Level 3/Argument 1: The numerator expression.
Level 2/Argument 2: The denominator expression.
Level 1/Argument 3: The degree of the Taylor polynomial.
- Output:** The Taylor polynomial at $x = 0$ of the quotient of the two expressions, to the specified degree.
- Flags:** Exact mode must be set (flag -105 clear).
Numeric mode must not be set (flag -3 clear). Radians mode must be set (flag -17 set).
Incremental power mode must be set (flag -114 set).
- Example:** Find the fourth degree Taylor polynomial for the following:
- $$\frac{x^3 + 4x + 12}{11x^{11} + 1}$$
- Command:** `DIVPC (X^3+4*X+12, 11*X^11+1, 4)`
- Result:** $12+4*X+X^3$
- See also:** TAYLOR0, TAYLR, SERIES

DOMAIN

- Type:** Command
- Description:** For a function of the current variable, lists the domains of real numbers for which the function is defined and for which it is undefined. DOMAIN works for functions of more than one argument, for example `DOMAIN (X*X)`, and for user defined functions, as in the example below. For functions which it does not recognize, DOMAIN returns the message "Unknown operator".
- Access:** Catalog,  CAT
- Input:** Level 1/Item 1: A function, or an expression, in terms of the current variable.
- Output:** Level 1/Item 1: A list with regions where the function is undefined marked by '?' and regions where the function is defined marked by +. Rational singularities, such as 0 in $1/x$, are not listed.

Flags: Exact mode must be set (flag -105 clear).
 Numeric mode must not be set (flag -3 clear).

Example: Define a function $f = \sqrt{a+1}$ by typing `DEF(F(A)=√(A+1))`. Then tabulate the domain over which it is defined and undefined.

Command: `DOMAIN (F (X))`

Result: `{'-∞' ?' -1 + '+∞'}`, showing that the function f is undefined for values from $-\infty$ to -1 and is defined from -1 to $+\infty$.

See also: `SIGNTAB`, `TABVAR`

DROITE

Type: Function

Description: Returns an equation for the line through two given points in a plane. For more than two points, `LAGRANGE` will fit a polynomial.

Access: Catalog,  `_CAT`

Input: Level 2/Argument 1: The first point, in the form $a+b*i$, or (a,b) , where a and b must be numbers, or variables or expressions that evaluate to numbers.
 Level 1/Argument 2: The second point, in the form $c+d*i$, or (c,d) , where c and d must be numbers, or variables or expressions that evaluate to numbers.

Output: Level 1/Item 1: An equation for the straight line through the two points. The general form is $Y=(d-b)/(c-a)*(X-a)+b$.

Flags: Numeric mode must not be set (flag -3 clear).
 Complex mode must be set (flag -103 set).
 In algebraic mode, if any of a, b, c, d are variables, they will be converted to their numeric values, even if “argument to symbolic” mode is set (flag -3 clear). In RPN mode, they will be returned as variables. If ALG mode is set and “constants to numeric” mode is selected (flag -2 set) π and e used in inputs will be converted to their real number approximations, otherwise they will be returned in symbolic form.

Example 1: Find an equation for the straight line through the points (1, 2), (3, 4).

Command: `DROITE ((1, 2) , (3, 4))`

Result: `Y=X-1.+2.`

Example 2: Find a symbolic equation for the straight line through the points (π, e) , (e, π) .

Command: With “constants to symbolic” mode selected and exact mode set, type:
`DROITE (π+e*i , e+π*i)`

Result: `Y = (π-e) / (e-π) * (X-π) +e`

See also: `LAGRANGE`

dn

Type: Function

Description: Differential of a function with respect to its argument n . For example $d1f(x,y)$ is the differential of $f(x,y)$ with respect to x and $d3g(y,z,t)$ is the differential of $g(y,z,t)$ with respect to t . The second-order derivative of $f(x,y)$ with respect to x is written $d1d1f(x,y)$. The dn function is an alternative to the ∂ function; $d1f(x,y)$ is the same as $\partial_x(f(x,y))$. dn does not require brackets after it, it must be followed immediately by the function name, with no spaces. dn differentiates with respect to the whole of argument n , see the example. dn is mainly used for formal arguments, see the example in `DESOLVE`, but can be used to differentiate expressions, as in the example.

Access: Access is by typing the letter “d” from the alpha keyboard, followed by the number n , before the function whose differential is required.

Output: d/n does not change its argument, it works like the negative sign placed before a number or an expression. If the argument can be differentiated, $\overline{\text{EVAL}}$ will carry out the differentiation.

Flags: Exact mode must be set (flag -105 clear).
 Numeric mode must not be set (flag -3 clear).
 Radians mode must be set (flag -17 set).

Example: Differentiate the function $\sin(2x)$ with respect to its argument:
Command: `EVAL (d1SIN (2*X))`
Result: `COS (2*X)`
 (Note that the function was differentiated with respect to its argument $2x$, not with respect to the variable x .)

See also: DERIV, DERVX, DESOLVE, ∂

EGCD

Type: Command

Description: Given two polynomials, a and b , returns polynomials u , v , and c where: $au+bv=c$
 In the equation, c is the greatest common divisor of a and b .

Access: Arithmetic, $\overline{\leftarrow}$ ARITH POLYNOMIAL

Input: Level 2/Argument 1: The expression corresponding to a in the equation.
 Level 1/Argument 2: The expression corresponding to b in the equation.

Output: Level 3/Item 1: The result corresponding to c in the equation.
 Level 2/Item 2: The result corresponding to u in the equation.
 Level 1/Item 3: The result corresponding to v in the equation.

Flags: Exact mode must be set (flag -105 clear).
 Numeric mode must not be set (flag -3 clear).
 Radians mode must be set (flag -17 set).

Example: Find the polynomials for u , v , and c , where c is the greatest common divisor of a and b such that:
 $u(x^2 + 1) + v(x - 1) = c$
Command: `EGCD (X^2+1, X-1)`
Result: `{ 2, 1, -(X+1) }`

See also: IEGCD, ABCUV

EPSX0

Type: Function

Description: Replaces all coefficients in a polynomial that have an absolute value less than that held in the CASDIR variable EPS, with 0. The default value of EPS is 1E-10, which can be changed by storing a new number in the variable EPS in the CASDIR directory; this must be less than 1.

Access: Catalog, $\overline{\rightarrow}$ CAT

Input: A polynomial.

Output: The polynomial with conforming coefficients replaced with 0.

Flags: Exact mode must be set (flag -105 clear).
 Numeric mode must not be set (flag -3 clear).

Example: Replace with zero the terms smaller than EPS in the expression: $10^{-13}x + 10^{-2}$

Command: EPSX0 (1E-13*X+.01)

Result: 0*X+.01

EULER

Type: Function

Description: For a given integer, returns the number of integers less than the integer that are co-prime with the integer. (Euler's Φ function.)

Access:  ARITH INTEGER

Input: A non-negative integer, or an expression that evaluates to a non-negative integer.

Output: The number of positive integers, less than, and co-prime with, the integer.

Flags: Exact mode must be set (flag -105 clear).
Numeric mode must not be set (flag -3 clear).

EXLR

Type: Command

Description: Returns the left- and right-hand sides of an equation as discrete expressions.

Access: Catalog,  _CAT

Input: An equation.

Output: Level 2/Item 1: The expression to the left of the "=" sign in the original equation, or, if the input is an expression and not an equation, the independent variable.
Level 1/Item 2: The expression to the right of the "=" sign in the original equation, or, if the input is an expression, the expression.

Flags: Numeric mode must not be set (flag -3 clear).
In Algebraic mode (flag -95 set), the output expressions are evaluated (variables are replaced by numeric values) before the result is returned.

Example: Split the following equation into its two component expressions: $\sin(x)=5x+y$

Command: EXLR (SIN (X) =5*X+Y)

Result: {SIN (X) , 5*X+Y}

See also: FXND

EXP&LN

Type: Command

Description: Displays a menu or list of the CAS exponential and logarithmic operations.

Access: Catalog,  _CAT

Flags: If the CHOOSE boxes flag is clear (flag -117 clear), displays the operations as a numbered list. If the flag is set, displays the operations as a menu of function keys.

See also: ALGB, ARIT, CONSTANTS, DIFF, INTEGER, MAIN, MATHS, MATR, MODULAR, POLYNOMIAL, REWRITE, TESTS, TRIGO

EXP2HYP

Type: Function

Description: Converts expressions involving the exponential function into expressions with hyperbolic functions.

Access: Catalog,  _CAT

Input: An expression

Output: The rewritten expression.

Flags: Exact mode must be set (flag -105 clear).
 Numeric mode must not be set (flag -3 clear).

Example: Rewrite in terms of hyperbolic functions the expression $e^{5 \cdot \ln(x)}$

Command: EXP2HYP (EXP (5 * LN (X)))

Result: SINH (5 * LN (X)) + COSH (5 * LN (X))

EXP2POW

Type: Function

Description: Simplifies expressions involving the composition of the exponential and logarithmic functions. Compare this to LNCOLLECT which combines logarithmic terms; the difference is shown in the results of the second example used here and for LNCOLLECT.

Access:  CONVERT REWRITE

Input: An expression

Output: The simplified expression.

Flags: Exact mode must be set (flag -105 clear).
 Numeric mode must not be set (flag -3 clear).

Example 1: Simplify the expression $e^{5 \cdot \ln(x)}$

Command: EXP2POW (EXP (5 * LN (X)))

Result: X^5

Example 2: Simplify the expression $e^{n \cdot \ln(x)}$

Command: EXP2POW (EXP (N * LN (X)))



Result: X^N

See also: LNCOLLECT

EXPAND

Type: Command

Description: Expands and simplifies an algebraic expression. This command is similar to the EXPAN command (which is included to ensure backward-compatibility with the HP 48-series calculators), except that EXPAND does more a more in-depth analysis and often does a better job at simplifying an expression than EXPAN.

Access: Algebra,  ALG or  ALG

Input: An expression, or an array of expressions.

Output: The expanded and simplified expression or array of expressions.

Flags: Exact mode must be set (flag -105 clear).
 Numeric mode must not be set (flag -3 clear).
 Radians mode must be set (flag -17 set).

Example: Simplify the following expression:

$$\frac{(x^2 + 2x + 1)}{x + 1}$$

Command: EXPAND ((X ^ 2 + 2 * X + 1) / (X + 1))

Result: X+1

See also: EXPAN

EXPANDMOD

| | |
|---------------------|--|
| Type: | Function |
| Description: | Expands and simplifies an algebraic expression, or an array of expressions, modulo the current modulus. |
| Access: | $\left[\leftarrow \right]$ <u>ARITH</u> MODULO |
| Input: | An expression, or an array of expressions. |
| Output: | The expanded and simplified expression, or array of expressions, modulo the current modulus. |
| Flags: | Exact mode must be set (flag -105 clear). Numeric mode must not be set (flag -3 clear). Radians mode must be set (flag -17 set). |
| Example: | Expand the following expression and give the result modulo 3: $(x + 3)(x + 4)$ |
| Command: | EXPANDMOD ((X+3) * (X+4)) |
| Result: | $x^2 + x$ |

EXPLN

| | |
|---------------------|---|
| Type: | Command |
| Description: | Transforms the trigonometric terms in an expression to exponential and logarithmic terms. |
| Access: | $\left[\leftarrow \right]$ <u>EXP&LN</u> or Convert, $\left[\leftarrow \right]$ <u>CONVERT</u> REWRITE or $\left[\text{SYMB} \right]$ $\left[\text{NXT} \right]$ EXP & LN |
| Input: | An expression |
| Output: | The transformed expression. |
| Flags: | Exact mode must be set (flag -105 clear). Numeric mode must not be set (flag -3 clear). Radians mode must be set (flag -17 set). Complex mode must be set (flag -103 set). |
| Example: | Transform the following expression and simplify the result using the EXPAND command: $2 \cos(x^2)$ |
| Command: | EXPLN (2 * COS (X^2)) EXPAND (ANS (1)) |
| Result: | $(\text{EXP}(i * X^2) ^2 + 1) / \text{EXP}(i * X^2)$ |
| See also: | SINCOS |

FACTOR

| | |
|---------------------|--|
| Type: | Command |
| Description: | Factorizes a polynomial or an integer: <ul style="list-style-type: none">• The function expresses a polynomial as the product of irreducible polynomials.• The function expresses an integer as the product of prime numbers. |
| Access: | Algebra, $\left[\rightarrow \right]$ <u>ALG</u> or $\left[\text{SYMB} \right]$ ALG or $\left[\leftarrow \right]$ <u>ARITH</u> POLY |
| Input: | An expression or an integer. |
| Output: | The factorized expression, or the integer expressed as the product of prime numbers. |
| Flags: | Exact mode must be set (flag -105 clear). Numeric mode must not be set (flag -3 clear). Results including complex terms are returned if complex mode is set (flag -103 set). |

Example: Factorize the following:

$$x^2 + 5x + 6$$

Command: FACTOR (X^2+5*X+6)

Result: (X+2) (X+3)

See also: EXPAN, EXPAND

FACTORMOD

Type: Function

Description: Factorizes a polynomial modulo the current modulus. The modulus must be less than 100, and a prime number, it can be changed by MODSTO.

Access: Arithmetic,  ARITH MODULO

Input: The expression to be factorized.

Output: The factorized expression modulo the current modulus.

Flags: Exact mode must be set (flag -105 clear).
Numeric mode must not be set (flag -3 clear).
Radians mode must be set (flag -17 set).

Example: Factorize the following expression modulo 3.
 x^2+2

Command: FACTORMOD (X^2+2)

Result: (X+1) * (X-1)

See also: MODSTO

FACTORS

Type: Command

Description: For a value or expression, returns a list of prime factors and their multiplicities.

Access: Arithmetic,  ARITH

Input: A value or expression.

Output: A list of prime factors of the value or expression, with each factor followed by its multiplicity expressed as a real number.

Flags: Exact mode must be set (flag -105 clear).
Numeric mode must not be set (flag -3 clear).
Radians mode must be set (flag -17 set).

Example 1: Find the prime factors of 100.

Command: FACTORS (100)

Result: {5 2. 2 2. }

Example 2: Find the irreducible factors of: $x^2 + 4x + 4$

Command: FACTORS (X^2+4*X+4)

Result: {X+2, 2. }

FCOEF

Type: Command

Description: From an array of roots and multiplicities/poles, returns a rational polynomial with a leading coefficient of 1, with the specified set of roots or poles, and with the specified multiplicities.

Access: Arithmetic,  ARITH POLY 

Input: An array of the form [Root 1, multiplicity/pole 1, Root 2, multiplicity/pole 2, . . .] The multiplicity/pole must be an integer. A positive number signifies a multiplicity. A negative number signifies a pole.

Output: The rational polynomial with the specified roots and multiplicities/poles. The polynomial is written using the current independent variable.

Flags: Exact mode must be set (flag -105 clear).
Numeric mode must not be set (flag -3 clear).

Example: Find the rational polynomial corresponding to the following set of roots and poles:
1, 2, 3, -1

Command: FCOEF ([1 , 2 , 3 , -1])

Result: $(X-1)^2 / (X-3)$

See also: FROOTS

FDISTRIB

Type: Command

Description: Performs a full distribution of multiplication and division with respect to addition and subtraction in a single step.

Access:  CONVERT REWRITE

Input: An expression.

Output: An equivalent expression that results from fully applying the distributive property of multiplication and division over addition and subtraction.

Flags: Exact mode must be set (flag -105 clear).
Numeric mode must not be set (flag -3 clear).

Example: Expand $(X+1)(X-1)(X+2)$:

Command: FDISTRIB ((X+1) * (X-1) * (X+2))

Result: $X*(X*X)+2*(X*X)+(-X*(1*X))+-(2*(1*X))+X*(X*1)+2*(X*1)+(-X*(1*1))+-(2*(1*1))$

See also: DISTRIB

FOURIER

Type: Function

Description: Returns the n^{th} coefficient of a complex Fourier series expansion. The PERIOD variable must be in the CAS directory, CASDIR, or in current path, and set to hold L , the period of the input function. The expression is expanded in terms of the current CAS variable.

Access: Calculus  CALC DERIV. & INTEG.

Input: Level 1/Argument 2: An expression in terms of the current variable
Level 2/Argument 1: The number, n , of the coefficient to return.



Output: The n^{th} Fourier coefficient of the expression.

Flags: Exact mode must be set (flag -105 clear).
Numeric mode must not be set (flag -3 clear).
Radians mode must be set (flag -17 set).
Complex mode must be set, that is, flag -103 must be set.

Example: Obtain the Fourier coefficient as below, with the default value of 2π in the PERIOD variable in CASDIR, and simplify it with EXPAND:

Command: FOURIER (X^2, 0)
EXPAND (ANS (1))
Result: 4/3 * π^2

FROOTS

Type: Command
Description: For a rational polynomial, returns an array of its roots and poles, with their corresponding multiplicities. This is the inverse of FCOEF and uses the same notation for roots and poles.
Access: Arithmetic,  ARITH POLY 
Input: A rational polynomial.
Output: An array of the form [Root 1, Multiplicity 1, Root 2, Multiplicity 2, . . .]
A negative multiplicity indicates a pole.
Flags: Exact mode must be set (flag -105 clear). Numeric mode must not be set (flag -3 clear).
Radians mode must be set (flag -17 set).
If complex mode is set (flag -103 set), FROOTS looks for complex solutions as well as real solutions.
If approximate mode is set (flag -105 set) FROOTS searches for numeric roots.
See also: FCOEF

FXND

Type: Command
Description: Splits an object into a numerator and a denominator.
Access: Catalog,  CAT
Input: A fraction, or an object that evaluates to a fraction.
Output: The object split into numerator and denominator.
Level 2/Item 1: The numerator.
Level 1/Item 2: The denominator.
Flags: Exact mode must be set (flag -105 clear).
Numeric mode must not be set (flag -3 clear).
Example: Return the numerator and the denominator of the following expression:
$$\frac{(x-3)^2}{z+4}$$

Command: FXND ((X-3)^2/(Z+4))
Result: { (X-3)^2, Z+4 }
See also: EXLR

GAUSS

Type: Command
Description: Returns the diagonal representation of a quadratic form.
Access: Matrices,  MATRICES QUADRATIC FORM
Input: Level 2/Argument 1: The quadratic form.
Level 1/Argument 2: A vector containing the independent variables.
Output: Level 4/Item 1: An array of the coefficients of the diagonal.
Level 3/Item 2: A matrix, P, such that the quadratic form is represented as P^TDP, where the diagonal matrix D contains the coefficients of the diagonal representation.

Level 2/Item 3: The diagonal representation of the quadratic form.
Level 1/Item 4: The vector of the variables.

Flags: Exact mode must be set (flag -105 clear).
Numeric mode must not be set (flag -3 clear).
Radians mode must be set (flag -17 set).

Example: Find the Gaussian symbolic quadratic form of the following:
 $x^2 + 2axy$

Command: GAUSS (X^2+2*A*X*Y, [X, Y])

Result: { [1, -A^2], [[1, A] [0, 1]], - (A^2*Y^2) + (A*Y+X)^2, [X, Y] }

See also: AXQ, QXA

GBASIS

Type: Command

Description: Returns a set of polynomials that are a Gröbner basis G of the ideal I generated from an input set of polynomials F.

Access: Catalog,  CAT

Input: Level 2/Argument 1: A vector F of polynomials in several variables.
Level 1/Argument 2: A vector giving the names of the variables.

Output: Level 1/Item 1: A vector containing the resulting set G of polynomials. The command attempts to order the polynomials as given in the vector of variable names.

Flags: Exact mode must be set (flag -105 clear).
Numeric mode must not be set (flag -3 clear).
Radians mode must be set (flag -17 set).

Example: Find a Gröbner basis of the ideal polynomial generated by the polynomials:
 $x^2 + 2xy^2, xy + 2y^3 - 1$

Command: GBASIS ([X^2 + 2*X*Y^2, X*Y + 2*Y^3 - 1], [X, Y])

Result: [X, 2*Y^3-1]

Note this is not the *minimal* Gröbner basis, as the leading coefficient of the second term is not 1; the algorithm used avoids giving results with fractions.

See also: GREDUCE

GCD

Type: Function

Description: Returns the greatest common divisor of two objects.

Access: Arithmetic,  ARITH POLY 

Input: Level 2/Argument 1: An expression, or an object that evaluates to a number.
Level 1/Argument 2: An expression, or an object that evaluates to a number.

Output: The greatest common divisor of the two objects.

Flags: Exact mode must be set (flag -105 clear).
Numeric mode must not be set (flag -3 clear).

Example: Find the greatest common divisor of 2805 and 99.

Command: GCD (2805, 99)



Result: 33

See also: GCDMOD, EGCD, IEGCD, LCM

GCDMOD

- Type:** Function
- Description:** Finds the greatest common divisor of two polynomials modulo the current modulus.
- Access:** Arithmetic,  ARITH MODULO
- Input:** Level 2/Argument 1: A polynomial expression.
Level 1/Argument 2: A polynomial expression.
- Output:** The greatest common divisor of the two expressions modulo the current modulus.
- Flags:** Exact mode must be set (flag -105 clear).
Numeric mode must not be set (flag -3 clear).
Radians mode must be set (flag -17 set).
- Example:** Find the greatest common divisor of $2x^2+5$ and $4x^2-5x$, modulo 13.
- Command:** GCDMOD (2X^2+5, 4X^2-5X)
- Result:** - (4X-5)
- See also:** GCD
-

GRAMSCHMIDT

- Type:** Command
- Description:** Finds an orthonormal base of a vector space with respect to a given scalar product.
- Access:** Matrices,  MATRICES  VECTOR
- Input:** Level 2/Argument 1: A vector representing a basis of a vector space.
Level 1/Argument 2: A function that defines a scalar product in that space. This can be given as a program, or as the name of a variable containing the definition of the function.
- Output:** An orthonormal base of the vector space with respect to the given scalar product.
- Flags:** Exact mode must be set (flag -105 clear).
Numeric mode must not be set (flag -3 clear).
Radians mode must be set (flag -17 set).
- Example:** Find an orthonormal base for the vector space with base $[1, 1+X]$ with respect to the scalar product defined by :

$$P \cdot Q = \int_{-1}^1 P(x) \cdot Q(x) dx$$

Command: GRAMSCHMIDT ([1, 1+X] , < -> P Q < PREVAL (INTVX (P*Q) , -1, 1) > >)

Result:
$$\begin{bmatrix} 1 & X \\ \sqrt{2} & \frac{1}{3} \cdot \sqrt{6} \end{bmatrix}$$

GREDUCE

- Type:** Command
- Description:** Reduces a polynomial with respect to a Gröbner basis.
- Access:** Catalog,  _CAT
- Input:** Level 3/Argument 1: A vector of polynomials in several variables.
Level 2/Argument 2: A vector of polynomials that is a Gröbner basis in the same variables.
Level 1/Argument 3: A vector giving the names of the variables.
- Output:** Level 1/Item 1: A vector containing the input polynomial reduced with respect to the Gröbner basis, up to a constant; as with GBASIS, fractions in the result are avoided.

Flags: Exact mode must be set (flag -105 clear).
Numeric mode must not be set (flag -3 clear).
Radians mode must be set (flag -17 set).

Example: Reduce the polynomial:
 $x^2y - xy - 1$
with respect to the Gröbner basis (obtained in the example for GBASIS):
 $x, 2y^3 - 1$

Command: GREDUCE (X^2*Y-X*Y-1, [X, 2*Y^3-1], [X, Y])

Result: -1

Note this is the remainder of the input polynomial modulo the term x in the Gröbner basis

See also: GBASIS

HADAMARD

Type: Command

Description: Performs an element by element multiplication of two matrices (Hadamard product).

Access: Matrices,  MATRICES OPERATIONS 

Input: Level 2/Argument 1: Matrix 1.
Level 1/Argument 2: Matrix 2.
The matrices must have the same order.

Output: The matrix representing the result of the multiplication.

Flags: Exact mode must be set (flag -105 clear).
Numeric mode must not be set (flag -3 clear).

Example: Find the Hadamard product of the following two matrices:

$$\begin{bmatrix} 3 & -1 & 2 \\ 0 & 1 & 4 \end{bmatrix} \text{ and } \begin{bmatrix} 2 & 3 & 0 \\ 1 & 5 & 2 \end{bmatrix}$$

Command: HADAMARD ([[3, -1, 2] [0, 1, 4]], [2, 3, 0] [1, 5, 2])

Result: [[6, -3, 0] [0, 5, 8]]

HALFTAN

Type: Command

Description: Transforms an expression by replacing $\sin(x)$, $\cos(x)$ and $\tan(x)$ subexpressions with $\tan(x/2)$ terms.

Access: Trigonometry,  TRIG or  TRIG

Input: An expression

Output: The transformed expression.

Flags: Exact mode must be set (flag -105 clear).
Numeric mode must not be set (flag -3 clear).
Radians mode must be set (flag -17 set).

See also: TAN2CS2, TAN2SC2



HELP

Type: Command

Description: Similar to CASCMD, displays a list of CAS operations. Selecting one with OK displays help for it, an example of the operation, and the option to copy the example to the command line. More details are given in Appendix C and Appendix H of the User's Guide.

Access: Catalog,  CAT, or tools  
See also: CASCMD

HERMITE





Type: Function
Description: Returns the n th Hermite polynomial.
Access: Arithmetic,  ARITH POLY 
Input: A non-negative integer.
Output: The corresponding polynomial expression.
Flags: Exact mode must be set (flag -105 clear).
Numeric mode must not be set (flag -3 clear).
Example: Find the Hermite polynomial with degree 4.
Command: HERMITE (4)
Result: $16 * X^4 - 48 * X^2 + 12$
See also: LEGENDRE, TCHEBYCHEFF

HESS

Type: Command
Description: Returns the Hessian matrix and the gradient of an expression with respect to the specified variables.
Access: Calculus  CALC DERIV & INTEG
Input: Level 2/Argument 1: An expression.
Level 1/Argument 2: A vector of the variables.
Output: Level 3/Item 1: The Hessian matrix with respect to the specified variables.
Level 2/Item 2: The gradient with respect to the variables.
Level 1/Item 3: The vector of the variables.
Flags: Exact mode must be set (flag -105 clear).
Numeric mode must not be set (flag -3 clear).
Example: Find the Hessian matrix, and the gradient with respect to each variable, of the expression:
$$t^2 + 2tu^2.$$

Command: HESS (T^2+2*T*U^2, [T, U])
Result: { [[[2, 2*(2*U)], [2*(2*U), 2*(2*T)]], [2*T+2*U^2, 2*T*(2*U)], [T, U] }
See also: CURL, DIV

HILBERT

Type: Command
Description: Returns a square Hilbert matrix of the specified order.
Access: Matrices,  MATRICES CREATE  or  MTH MATRX MAKE  
Input: A positive integer, representing the order.
Output: The Hilbert matrix of the specified order.
Flags: Exact mode must be set (flag -105 clear).
Numeric mode must not be set (flag -3 clear).
Example: Find the order 3 Hilbert matrix.
Command: HILBERT (3)

$$\begin{bmatrix} 1 & \frac{1}{2} & \frac{1}{3} \\ \frac{1}{2} & \frac{1}{3} & \frac{1}{4} \\ \frac{1}{3} & \frac{1}{4} & \frac{1}{5} \end{bmatrix}$$

Result:

See also: CON, IDN, RANM, VANDERMONDE

HORNER

Type: Command

Description: Executes a Horner scheme on a polynomial. That is, for a given polynomial P , and a number r , HORNER returns QUOT($P/(x-r)$), r and also $P(r)$

Access: Arithmetic, \leftarrow ARITH POLY \rightarrow NXT

Input: Level 2/Argument 1: A polynomial, P .
Level 1/Argument 2: A number, r .

Output: Level 3/Item 1: QUOT($P/(x-r)$)
Level 2/Item 2: r
Level 1/Item 3: $P(r)$, the remainder of the division process.

Flags: Exact mode must be set (flag -105 clear).
Numeric mode must not be set (flag -3 clear).
Radians mode must be set (flag -17 set).

Example: For $r = 3$, find the result of executing a Horner scheme on the following polynomial:
 $x^2 + x + 1$

Command: HORNER ($X^2+X+1, 3$)

Results: ($X+4, 3, 13$)

IABCUV

Type: Command

Description: Returns a solution in integers u and v of $au + bv = c$, where a , b , and c are integers.

Access: Arithmetic, \leftarrow ARITH INTEGER

Input: Level 3/Argument 1: the value of a .
Level 2/Argument 2: the value of b .
Level 1/Argument 3: the value of c .

Output: Level 2/Item 1: The value for u .
Level 1/Item 2: The value for v .

Flags: Exact mode must be set (flag -105 clear).
Numeric mode must not be set (flag -3 clear).
Radians mode must be set (flag -17 set).

Example: Find a solution in integers of the equation:
 $6a + 11b = 3$

Command: IABCUV ($6, 11, 3$)

Result: $\{6, -3\}$

See also: ABCUV, IEGCD

IBASIS

Type: Command

Description: Determines the basis of the intersection between two vector spaces.

Access: Matrices, \leftarrow MATRICES \rightarrow VECTOR

Input: Two lists of vectors

Output: A list of vectors.

Flags: Exact mode must be set (flag -105 clear).

Example: Find a vector of a basis of the intersection of the vector sub-spaces defined by [1, 2] and [2, 4]

Command: IBASIS ({ [1, 2] } , { [2, 4] })

Result: { [1, 2] }

See also: BASIS

IBERNOULLI

Type: Function

Description: Returns the n th Bernoulli number for a given integer n .

Access: Arithmetic, \leftarrow ARITH \rightarrow INTEGER

Input: Level 1/Argument 1: an integer.

Output: Level 1/Item 1: The corresponding n th Bernoulli number for the integer. For numbers greater than about 40 the calculation can take a long time.

Flags: Numeric mode must not be set (flag -3 clear).

IBP

Type: Command

Description: Performs integration by parts on a function. The function must be able to be represented as a product of two functions, where the antiderivative of one of the functions is known:
 $f(x) = u(x) \cdot v'(x)$
 Note that the command is designed for use in RPN mode only.

Access: [SYMB] CALC or Calculus, \leftarrow CALC \rightarrow DERIV & INTEG [NXT]

Input: Level 2: The integrand expressed as a product of two functions, $u(x) \cdot v'(x)$
 Level 1: The antiderivative of one of the component functions, $v(x)$.

Output: Level 2: $u(x)v(x)$
 Level 1: $-u'(x)v(x)$

Flags: Exact mode must be set (flag -105 clear).
 Numeric mode must not be set (flag -3 clear).
 Radians mode must be set (flag -17 set).

Example: Use integration by parts to calculate the following:
 $\int x \cos(x) dx$

Command 1: Apply the IBP command in RPN mode:
 Level 2: X * COS (X)
 Level 1: SIN (X)

Result: Level 2: SIN (X) * X
 Level 1: -SIN (X)

Command 2: Apply the INTVX command to level 1, -SIN (X)

Result: Level 2: SIN (X) * X
 Level 1: COS (X)

Command 3: Press [+] to add the result to the value at level 2 to obtain the final result.

Result: $\text{SIN}(X) * (X) + \text{COS}(X)$

See also: INTVX, INT, PREVAL, RISCH

ICHINREM

Type: Command

Description: Solves a system of two congruences in integers using the Chinese Remainder theorem.

Access: Arithmetic,  ARITH INTEGER

Input: Level 2/Argument 1: A vector of the first value and the modulus.
Level 1/Argument 2: A vector of the second value and the modulus.

Output: A vector of the solution.

Flags: Exact mode must be set (flag -105 clear).
Numeric mode must not be set (flag -3 clear).
Radians mode must be set (flag -17 set).

Example: Solve the following system of congruences:

$$x \equiv 2 \pmod{3}$$

$$x \equiv 1 \pmod{5}$$

Command: ICHINREM ([2 , 3] , [1 , 5])

Results: [-4 , 15]

See also: CHINREM

IDIV2

Type: Command

Description: For two integers, a and b , returns the integer part of a/b , and the remainder, r .

Access: Arithmetic,  ARITH INTEGER

Input: Level 2/Argument 1: a .
Level 1/Argument 2: b .

Output: Level 2/Item 1: The integer part of a/b .
Level 1/Item 2: The remainder.

Flags: Numeric mode must not be set (flag -3 clear).
Radians mode must be set (flag -17 set).

Example: Return the integer part and the remainder of $11632/864$.

Command: IDIV2 (11632 , 864)

Result: { 13 , 400 }

See also: DIV2, IQUOT

IEGCD

Type: Command

Description: Given two integers x and y , returns three integers, a , b , and c , such that:
 $ax + by = c$
where c is the GCD of x and y .

Access:  ARITH or Arithmetic,  ARITH INTEGER

Input: Level 2/Argument 1: x .
Level 1/Argument 2: y .

Output: Level 3/Item 1: c .
Level 2/Item 2: a .

Level 1/Item 3: b .
Note the order, c is first.

Flags: Exact mode must be set (flag -105 clear).
Numeric mode must not be set (flag -3 clear).
Radians mode must be set (flag -17 set).

Example: Find a , b and c such that $a18 + b24 = c$, where c is the GCD of 18 and 24.

Command: IEGCD(18, 24)

Result: {6, -1, 1}

See also: ABCUV, EGCD, IABCUV

ILAP

Type: Function

Description: Returns the inverse Laplace transform of an expression. The expression must evaluate to a rational fraction.

Access: Calculus,  CALC DIFFERENTIAL EQNS

Input: A rational expression.

Output: The inverse Laplace transformation of the expression.

Flags: Exact mode must be set (flag -105 clear).
Numeric mode must not be set (flag -3 clear).
Radians mode must be set (flag -17 set).

Example: Find the inverse Laplace transform of: $\frac{1}{(x-5)^2}$

Command: ILAP(1/(X-5)^2)

Result: X*EXP(5*X)

See also: LAP, LAPL

IMAGE

Type: Command

Description: Computes the basis of the image (also called the range) of a linear application f .

Access: Matrices,  MATRICES LINEAR APPL

Input: A matrix representing a linear application f in terms of the standard basis.

Output: A list of vectors representing a basis of the image of f .

Flags: Exact mode must be set (flag -105 clear).
Numeric mode must not be set (flag -3 clear).

Example: Find the image of $\begin{bmatrix} 1 & 1 & 2 \\ 2 & 1 & 3 \\ 3 & 1 & 4 \end{bmatrix}$

Command: IMAGE([1,1,2] [2,1,3] [3,1,4])

Result: { [1, 0, -1] [0, 1, 2] }

See also: BASIS, KER

INT

Type: Function

Description: Calculates the antiderivative of a function for a given variable, at a given point.

Access: Catalog,  CAT

Input: Level 3/Argument 1: A function.
 Level 2/Argument 2: The variable to obtain the derivative with respect to.
 Level 1/Argument 3: The point at which to calculate the antiderivative. This point can be a variable or an expression.

Output: The antiderivative of the function for the given variable, at the point you specified.

Flags: Exact mode must be set (flag -105 clear).
 Numeric mode must not be set (flag -3 clear).
 Radians mode must be set (flag -17 set).

Example: Find the integral of $\sin(x)$ with respect to x , at the point where $x=y$.

Command: `INT (SIN (X) , X, Y)`

Result: `-COS (Y)`

See also: INTVX, RISCH

INTEGER

Type: Command

Description: Displays a menu or list of CAS integer operations.

Access: Catalog,  `CAT`





Flags: If the CHOOSE boxes flag is clear (flag -117 clear), displays the operations as a numbered list. If the flag is set, displays the operations as a menu of function keys.

See also: ALGB, ARIT, CONSTANTS, DIFF, EXP&LN, MAIN, MATHS, MATR, MODULAR, POLYNOMIAL, REWRITE, TESTS, TRIGO

INTVX

Type: Function

Description: Finds the antiderivative of a function symbolically, with respect to the current default variable.

Access: Calculus,  `CALC` or  `CALC` or  `CALC` DERIV. & INTEG 

Input: An expression.

Output: The antiderivative of the expression.

Flags: Exact mode must be set (flag -105 clear).
 Numeric mode must not be set (flag -3 clear).
 Radians mode must be set (flag -17 set).

Example: Find the antiderivative of the following:
 $x^2 \ln x$

Command: `INTVX (X^2 * LN (X))`



Result: `1/3 * X^3 * LN (X) + (-1/9) * X^3`

See also: IBP, RISCH, PREVAL

INVMOD

Type: Function

Description: Performs modular inversion on an object modulo the current modulus.

Access: Arithmetic,  `ARITH` MODULO 

Input: An object.

Output: The modular inverse of the object.

Flags: Exact mode must be set (flag -105 clear).
Numeric mode must not be set (flag -3 clear).

Example: Solve the following for x , modulo the default modulus, 13.
($2x \equiv 1$)



Command: INVMOD (2)

Result: -6

IQUOT

Type: Function

Description: Returns the integer quotient (or Euclidean quotient) of two integers. That is, given two integers, a and b , returns the integer q , such that:
 $a = qb + r$, and $0 \leq r < b$

Access:  ARITH or Arithmetic,  ARITH INTEGER 

Input: Level 2/Argument 1: The dividend.
Level 1/Argument 2: The divisor.

Output: The integer quotient.



Flags: Exact mode must be set (flag -105 clear).
Numeric mode must not be set (flag -3 clear).
Radians mode must be set (flag -17 set).

See also: QUOT, IDIV2

IREMAINDER

Type: Function

Description: Returns the remainder of an integer division.

Access:  ARITH or Arithmetic,  ARITH INTEGER 

Input: Level 2/Argument 1: The numerator.
Level 1/Argument 2: The denominator.

Output: The remainder.

Flags: Exact mode must be set (flag -105 clear).
Numeric mode must not be set (flag -3 clear).
Radians mode must be set (flag -17 set).

See also: IDIV2

ISOM

Type: Command

Description: Determine the characteristics of a 2-d or 3-d linear isometry.

Access: Matrices,  MATRICES LINEAR APPL

Input: A square matrix representing a linear isometry.

Output: A vector and/or an angle that represent the symmetry of the matrix, and 1 (for a direct isometry) or -1 (for an indirect isometry).

Flags: Exact mode must be set (flag -105 clear).
Numeric mode must not be set (flag -3 clear).
Radians mode must be set (flag -17 set).

Example 1: Analyze the isometry given by the matrix

$$\begin{bmatrix} 0 & -1 \\ -1 & 0 \end{bmatrix}$$

Command: ISOM([[0, -1] [-1, 0]])

Result: { [1, 1] -1 }, meaning the matrix represents a symmetry in the line $y = -x$, and this is an indirect isometry.

$$\begin{bmatrix} \frac{1}{2} & \frac{-\sqrt{3}}{2} \\ \frac{\sqrt{3}}{2} & \frac{1}{2} \end{bmatrix}$$

Example 2: Analyze the isometry given by the matrix

Command: ISOM([[1/2, -√3/2] [√3/2, 1/2]])

Result: { $\pi/3$, 1 }, meaning the matrix represents a rotation of $\pi/3$ radians, and this is a direct isometry.

See also: MKISOM

ISPRIME?

Type: Function

Description: Tests if a number is prime. For numbers of the order of 10^{14} or greater (to be exact, greater than 341550071728321), tests if the number is a pseudoprime; this has a chance of less than 1 in 10^{12} of wrongly identifying a number as a prime.

Access: SYMB ARITH or Arithmetic, ← ARITH INTEGER NXT

Input: An object that evaluates to an integer or a whole real number.

Output: 1 (True) if the number is prime, 0 (False) if it is not.

Flags: Exact mode must be set (flag -105 clear).
Numeric mode must not be set (flag -3 clear).

See also: NEXTPRIME, PREVPRIME

JORDAN

Type: Command

Description: Diagonalization, or Jordan cycle decomposition, of a matrix. Computes the eigenvalues, eigenvectors, minimum polynomial, and characteristic polynomial of a matrix.

Access: Matrices, ← MATRICES NXT EIGENVECTORS

Input: An $n \times n$ matrix.

Output: Level 4/Item 1: The minimum polynomial.
Level 3/Item 2: The characteristic polynomial.
Level 2/Item 3: A list of characteristic spaces tagged by the corresponding eigenvalue (either a vector or a list of Jordan chains, each of them ending with an "Eigen:"-tagged eigenvector).
Level 1/Item 4: An array of the eigenvalues, with multiplicities

Flags: Exact mode must be set (flag -105 clear).
Numeric mode must not be set (flag -3 clear).
Radians mode must be set (flag -17 set).

Example: Perform the following diagonalization:

Command: JORDAN([[1, 1] [1, 1]])

Result: { $X^2 - 2X$,
 $X^2 - 2X$,

$\{0: [1, -1]\}, 2: [1, 1]\}$
 $[0, 2]\}$

KER

- Type:** Command
- Description:** Computes the basis of the kernel of a linear application f .
- Access:** Matrices, \leftarrow MATRICES LINEAR APPL
- Input:** A matrix representing a linear application f in terms of the standard basis.
- Output:** A list of vectors representing a basis of the kernel (also called the nullspace) of f .
- Flags:** Exact mode must be set (flag -105 clear).
 Numeric mode must not be set (flag -3 clear).

- Example:** Find the kernel of $\begin{bmatrix} 1 & 1 & 2 \\ 2 & 1 & 3 \\ 3 & 1 & 4 \end{bmatrix}$
- Command:** `KER ([1, 1, 2] [2, 1, 3] [3, 1, 4])`
- Result:** $\{ [1, 1, -1] \}$
- See also:** BASIS, IMAGE

LAGRANGE

- Type:** Command
- Description:** Returns the interpolating polynomial of minimum degree for a set of pairs of values. For two pairs, DROITE will fit a straight line.
- Access:** Arithmetic, \leftarrow ARITH POLY \rightarrow NXT
- Input:** A two \times n matrix of the n pairs of values.
- Output:** The polynomial that results from the Lagrange interpolation of the data.
- Flags:** Exact mode must be set (flag -105 clear).
 Numeric mode must not be set (flag -3 clear).
 Radians mode must be set (flag -17 set).
- Example:** Find an interpolating polynomial for the data (1,6), (3,7), (4,8), (2,9)
- Command:** `LAGRANGE ([[1, 3, 4, 2] [6, 7, 8, 9]])`
- Result:**
$$\frac{8x^3 - 63x^2 + 151x - 60}{6}$$
- See also:** DROITE

LAP

- Type:** Function
- Description:** Performs a Laplace transform on an expression with respect to the current default variable.
- Access:** Calculus, \leftarrow CALC DIFFERENTIAL EQNS
- Input:** An expression.
- Output:** The Laplace transform of the expression.
- Flags:** Exact mode must be set (flag -105 clear).
 Numeric mode must not be set (flag -3 clear).
 Radians mode must be set (flag -17 set).

Example: Find the Laplace transform of e^x .

Command: LAP (EXP (X))

Result: $1 / (X - 1)$

See also: ILAP, LAPL

LAPL

Type: Command

Description: Returns the Laplacian of a function with respect to a list of variables.

Access:  CALC DERIV & INTEG 

Input: Level 2/Argument 1: An expression.
Level 1/Argument 2: A vector of variables.

Output: The Laplacian of the expression with respect to the variables.

Flags: Exact mode must be set (flag -105 clear).
Numeric mode must not be set (flag -3 clear).
Radians mode must be set (flag -17 set).

Example: Find, and simplify, the Laplacian of the following expression:
 $e^x \cos(zy)$

Command: LAPL (EXP (X) * COS (Z * Y) , [X , Y , Z])
EXPAND (ANS (1))

Result: $- ((Y ^ 2 + Z ^ 2 - 1) * EXP (X) * COS (Z * Y))$

See also: LAP, ILAP

LCM

Type: Function

Description: Returns the least common multiple of two objects.

Access: Arithmetic,  ARITH POLYNOMIAL  

Input: Level 2/Argument 1: An expression, a number, or object that evaluates to a number.
Level 1/Argument 2: An expression, a number, or object that evaluates to a number.

Output: The least common multiple of the objects.

Flags: Exact mode must be set (flag -105 clear).
Numeric mode must not be set (flag -3 clear).
Radians mode must be set (flag -17 set).

Example: Find the least common multiple of the following two expressions:
 $x^2 - 1$
 $x - 1$

Command: LCM (X ^ 2 - 1 , X - 1)

Results: $X ^ 2 - 1$

See also: GCD

LCXM

Type: Command

Description: From a program with two arguments, builds a matrix with the specified number of rows and columns, with $a_{ij} = f(i,j)$.

Access: Catalog,  CAT

Input: Level 3/Argument 1: The number of rows you want in the resulting matrix.
 Level 2/Argument 2: The number of columns you want in the resulting matrix.
 Level 1/Argument 3: A program that uses two arguments. An expression with the two variables I, J can be used instead.

Output: The resulting matrix.

Flags: Exact mode must be set (flag -105 clear).
 Numeric mode must not be set (flag -3 clear).

Example: Build a 2×3 matrix with $a_{ij}=i+2j$.

Command: LCXM(2,3,« →I J 'I+2*J' »)

Result:
$$\begin{bmatrix} 3 & 5 & 7 \\ 4 & 6 & 8 \end{bmatrix}$$

LDEC

Type: Command

Description: Solves a linear differential equation with constant coefficients, or a system of first order linear differential equations with constant coefficients.

Access: Symbolic solve, $\left[\leftarrow \right]$ S.SLV or $\left[\text{SYMB} \right]$ SOLVER or $\left[\leftarrow \right]$ CALC DIFF

Input: Level 2/Argument 1: For a single equation, the function forming the right hand side of the equation. For a system of equations, an array comprising the terms not containing the dependent variables.

Level 1/Argument 2: For one equation, the auxiliary polynomial. For a system of equations, the matrix of coefficients of the dependent variables.

Output: The solution.

Flags: Exact mode must be set (flag -105 clear).
 Numeric mode must not be set (flag -3 clear).
 Radians mode must be set (flag -17 set).

Example: Solve $2\sin(x)$, with the auxiliary polynomial x^2+1 :

Command: LDEC(2*SIN(X), X^2+1)

Result: $\cos(X) * (cC0 -X) + (cC1 - -1) * \sin(X)$

See also: DESOLVE

LEGENDRE

Type: Function

Description: Returns the n th degree Legendre polynomial.

Access: Arithmetic, $\left[\leftarrow \right]$ ARITH POLYNOMIAL $\left[\text{NXT} \right]$ $\left[\text{NXT} \right]$

Input: An integer, n .

Output: The n th Legendre polynomial.

Flags: Exact mode must be set (flag -105 clear).
 Numeric mode must not be set (flag -3 clear).

Example: Find the Legendre polynomial with degree 4.

Command: LEGENDRE(4)

Result: $(35*X^4-30*X^2+3)/8$

See also: HERMITE, TCHEBYCHEFF

LGCD

- Type:** Function
- Description:** Returns the greatest common divisor of a list of expressions or values.
- Access:** Arithmetic, $\left[\leftarrow \right]$ ARITH $\left[\text{NXT} \right]$
- Input:** A list of expressions or values.
- Output:** Level 2/Item 1: The list of elements.
Level 1/Item 2: The greatest common divisor of the elements.
- Flags:** Exact mode must be set (flag -105 clear).
Numeric mode must not be set (flag -3 clear).
Radians mode must be set (flag -17 set).
- See also:** GCD
-

LIMIT

- Type:** Function
- Description:** Returns the limit of a function as its argument approaches a specified value. This function is identical to the lim function, described below, and is included to ensure backward-compatibility with the HP49G calculator.
- Access:** Catalog, $\left[\rightarrow \right]$ CAT
-

lim

- Type:** Function
- Description:** Returns the limit of a function as its argument approaches a specified value. Expands and simplifies an algebraic expression.
- Access:** Calculus, $\left[\leftarrow \right]$ CALC LIMITS&SERIES
- Input:** Level 2/Argument 1: An expression.
Level 1/Argument 2: An expression of the form $x = y$, where x is the variable and y is the value at which the limit is to be evaluated. If the variable approaching a value is the current CAS variable, it is sufficient to give its value alone. The ∞ symbol provided by the calculator can be used to set the limiting value at plus or minus infinity.
- Output:** The limit of the expression at the limit point.
- Flags:** Exact mode must be set (flag -105 clear).
Numeric mode must not be set (flag -3 clear).
Radians mode must be set (flag -17 set).
- Example:** Find the following limit:
$$\left(\lim_{x \rightarrow y} \right) \frac{x^n - y^n}{x - y}$$
- Command:** `lim ((X^N-Y^N)/(X-Y), X=Y)`
- Result:** `N*EXP(N*LN(Y))/Y`
- See also:** SERIES
-

LIN

- Type:** Command
- Description:** Linearizes expressions involving exponential terms.
- Access:** $\left[\rightarrow \right]$ ALG or Exponential and logarithm, $\left[\leftarrow \right]$ EXP&LN or $\left[\text{SYMB} \right]$ ALG, or $\left[\leftarrow \right]$ CONVERT REWRITE, or $\left[\text{SYMB} \right]$ $\left[\text{NXT} \right]$ EXPLN.

Input: An expression.
Output: The linearized expression.
Flags: Exact mode must be set (flag -105 clear).
 Numeric mode must not be set (flag -3 clear).
 Radians mode must be set (flag -17 set).

Example: Linearize the following expression:

$$x(e^x e^y)^4$$

Command: LIN (X * (EXP (X) * EXP (Y)) ^4)

Result: X*EXP (4X+4Y)

See also: TEXPAND

LINSOLVE

Type: Command
Description: Solves a system of linear equations.
Access: Symbolic solve, \leftarrow S.SLV , \leftarrow SYMB SOLVE, \leftarrow MATRICES LIN-S
Input: Level 2/Argument 1: An array of equations.
 Level1/Argument 2: A vector of the variables to solve for.
Output: Level 3/Item 1: The system of equations, as a list containing the inputs as above.
 Level 2/Item 2: A list of the pivot points.
 Level 1/Item 3: The solution.
Flags: Exact mode must be set (flag -105 clear).
 Numeric mode must not be set (flag -3 clear).
See also: DESOLVE, SOLVE, MSLV

LNAME

Type: Command
Description: Returns the variable names contained in a symbolic expression.
Access: Catalog, \leftarrow CAT
Input: A symbolic expression.
Output: Level 2/Argument 1: The original expression.
 Level 1/Argument 2: A vector containing the variable names. The variable names are sorted by length, longest first, and ones of equal length are sorted alphabetically.
Flags: Exact mode must be set (flag -105 clear).
 Numeric mode must not be set (flag -3 clear).
Example: List the variables in the expression COS(B)/2*A + MYFUNC(PQ) + 1/T.
Command: LNAME (COS (B) /2*A + MYFUNC (PQ) + INV (T))
Result: {COS (B) /2*A + MYFUNC (PQ) + 1/T, [MYFUNC, PQ, A, B, T] }
See also: LVAR

LNCOLLECT

Type: Command
Description: Simplifies an expression by collecting logarithmic terms. For symbolic powers does not perform the same simplification as EXP2POW; compare example 2 here with example 2 for EXP2POW.
Access: Algebra, \leftarrow ALG , \leftarrow EXP&LN , or \leftarrow SYMB \leftarrow NXT EXP & LN, or \leftarrow CONVERT REWRITE \leftarrow NXT
Input: An expression.
Output: The simplified expression.

Flags: Exact mode must be set (flag -105 clear).
Numeric mode must not be set (flag -3 clear).
Radians mode must be set (flag -17 set).

Example 1: Simplify the following expression:
 $2(\ln(x)+\ln(y))$

Command: LNCOLLECT (2 (LN (X) + LN (Y))

Result: LN (X ^ 2 * Y)

Example 2: Compare the effect of LNCOLLECT with the effect of EXP2POW on the expression $e^{n \ln(x)}$

Command: LNCOLLECT (EXP (N * LN (X))

Result: EXP (N * LN (X))

See also: EXP2POW, TEXPAND

LOCAL

Type: Command

Description: Creates one or more local variables. This command is intended mainly for use in Algebraic mode; it can not be single stepped when a program containing it is being debugged in Algebraic mode.

Access: Catalog,  _CAT

Input: Level 1/Argument 1: A list of one or more local variable names (names beginning with the local variable identifier ←), each one followed by an equals sign and the value to be stored in it. Any variable not followed by an equal sign and a value is set equal to zero.

Output: Level 1/Item 1: The input list.

Flags: Exact mode must be set (flag -105 clear).
Numeric mode must not be set (flag -3 clear).

Example: Create local variables ←A and ←B and store the values 0 in the first and 2 in the second.

Command: LOCAL ({ ←A, ←B=2 })

Result: { ←A, ←B=2 }

See also: DEF, STORE, UNBIND

LVAR

Type: Command

Description: Returns a list of variables in an algebraic object. Differs from LNAME above in that functions of variables, such as COS(X) or LN(AB) are returned, instead of the variable names, X or AB. INV() and SQ() are not treated as functions. Compare the example here with the same example in LNAME.

Access: Catalog,  _CAT

Input: An algebraic object.

Output: Level 2/Item 1: The algebraic object.
Level 1/Item 2: A list which includes both the original expression and a vector containing the variable names. Variable names include functions of variables, as described above. The names are sorted by length, longest first, and ones of equal length are sorted alphabetically.

Flags: Exact mode must be set (flag -105 clear).
Numeric mode must not be set (flag -3 clear).

Example: List the variables and function names in the expression $\cos(B)/2*A + \text{MYFUNC}(PQ) + 1/T$.

Command: LVAR (COS (B) / 2 * A + MYFUNC (PQ) + INV (T))



Result: $\{ \text{COS}(B) / 2 * A + \text{MYFUNC}(PQ) + 1/T, [\text{MYFUNC}(PQ), \text{COS}(B), A, T] \}$

See also: LNAME

MAD

Type: Command

Description: Returns details of a square matrix, including the information needed to obtain the adjoint matrix. The adjoint matrix is obtained by multiplying the inverse matrix by the determinant.

Access: Matrices,  MATRICES OPERATIONS 

Input: A square matrix

Output: Level 4/Item 1: The determinant.
Level 3/Item 2: The formal inverse.
Level 2/Item 3: The matrix coefficients of the polynomial, p , defined by $(xI-a)p(x)=m(x)I$, where a is the matrix, and m is the characteristic polynomial of a .
Level 1/Item 4: The characteristic polynomial.

Flags: Exact mode must be set (flag -105 clear).
Numeric mode must not be set (flag -3 clear).

Example: Obtain the adjoint matrix of:

$$\begin{bmatrix} 0 & -1 \\ 1 & 0 \end{bmatrix}$$

Command: MAD ([[0, -1] [1, 0]])

Result: $\{ 1, [[0, 1] [-1, 0]], \{ [[1, 0] [0, 1]], [[0, -1] [1, 0]] \}, X^{2+1} \}$
The determinant is 1, so the adjoint is the second item $[[0, 1] [-1, 0]]$.

See also: LNAME

MAIN

Type: Command

Description: Displays the main menu (or list) of CAS operations. This displays the CASCFG command, the ALGB, ARIT, DIFF, EXP&LN, MATHS MATR, REWRITE and TRIGO menu commands described in this part of the Command Reference, and the CMPLX and SOLVER menu commands described in the Full Command and Function Reference (Chapter 3). Other menus are not shown because they are within the submenus given by MAIN. More details are given in Appendix K of the User's Guide.

Access: Catalog,  _CAT

Flags: If the CHOOSE boxes flag is clear (flag -117 clear), displays the operations as a list. If the flag is set, displays the operations as a menu of function keys.

See also: ALGB, ARIT, CONSTANTS, DIFF, EXP&LN, INTEGER, MATHS, MATR, MODULAR, POLYNOMIAL, REWRITE, TESTS, TRIGO

MATHS

Type: Command

Description: Displays a menu or list of CAS mathematics submenus. Details are given in Appendix J of the User's Guide.

Access: Catalog,  _CAT

Flags: If the CHOOSE boxes flag is clear (flag -117 clear), displays the submenus as a list. If the flag is set, displays the submenus as a menu of function keys.

See also: ALGB, ARIT, CONSTANTS, DIFF, EXP&LN, INTEGER, MAIN, MATR, MODULAR, POLYNOMIAL, REWRITE, TESTS, TRIGO

MATR

Type: Command

Description: Displays a menu or list containing the CAS commands for matrix operations.

Access: Catalog,  CAT

Flags: If the CHOOSE boxes flag is clear (flag -117 clear), displays the operations as a numbered list. If the flag is set, displays the operations as a menu of function keys.

See also: ALGB, ARIT, CONSTANTS, DIFF, EXP&LN, INTEGER, MAIN, MATHS, MODULAR, POLYNOMIAL, REWRITE, TESTS, TRIGO

MENUXY

Type: Command

Description: Displays a function key menu of computer algebra commands in a specified range.

Access: Catalog,  CAT

Input: Level 2/Argument 1: The number of the first command in the range to be displayed.
Level 1/Argument 2: The number of the last command in the range to be displayed.
Arguments below 0 are treated as 0, arguments above 140 are treated as 140.

Output: On the function key menu, the computer algebra commands in the range specified. NOVAL is returned in Algebraic mode.

This list gives the number of each operation that can be displayed by the command. The complete menu below can be generated by MENUXY(0,140). Items 127 through to 135 allow access from the top row of keys to CAS menus.

| Number | | | Operation | | | |
|---------|-----------|-------------|-----------|----------|-----------|-------------|
| 0-5 | EXPAND | FACTOR | SUBST | DERVX | INTVX | lim |
| 6-11 | TAYLOR0 | SERIES | SOLVEVX | PLOT | PLOTADD | IBP |
| 12-17 | PREVAL | RISCH | DERIV | DESOLVE | LAP | ILAP |
| 18-23 | LDEC | TEXPAND | LIN | TSIMP | LNCOLLECT | EXPLN |
| 24-29 | SINCOS | TLIN | TCOLLECT | TRIG | TRIGCOS | TRIGSIN |
| 30-35 | TRIGTAN | TAN2SC | HALFTAN | TAN2SC2 | ATAN2S | ASIN2T |
| 36-41 | ASIN2C | ACOS2S | DIV2 | IDIV2 | QUOT | IQUOT |
| 42-47 | REMAINDER | IREMAINDER | GCD | LCM | EGCD | IEGCD |
| 48-53 | ABCUV | IABCUV | LGCD | SIMP2 | PARTFRAC | PROPFRAC |
| 54-59 | PTAYL | HORNER | EULER | PA2B2 | CHINREM | ICHINREM |
| 60-65 | ISPRIME? | NEXTPRIME | PREVPRIME | SOLVE | ZEROS | FCOEF |
| 66-71 | FROOTS | FACTORS | DIVIS | TRAN | HADAMARD | rref |
| 72-77 | REF | AXM | AXL | QXA | AXQ | GAUSS |
| 78-83 | SYLVESTER | PCAR | JORDAN | MAD | LINSOLVE | VANDERMONDE |
| 84-89 | HILBERT | LCXM | DIV | CURL | LAPL | HESS |
| 90-95 | LEGENDRE | TCHEBYCHEFF | HERMITE | LAGRANGE | FOURIER | SIGNTAB |
| 96-101 | TABVAR | TABVAL | DIVPC | TRUNC | SEVAL | TEVAL |
| 102-107 | MAP | XNUM | XQ | REORDER | LVAR | FXND |
| 108-113 | EXLR | LNAME | ADDTMOD | SUBTMOD | MULTMOD | DIVMOD |
| 114-119 | DIV2MOD | POWMOD | INVMOD | GCDMOD | EXPANDMOD | FACTORMOD |
| 120-125 | RREFMOD | MODSTO | MENUXY | KEYEVAL | GROBADD | SCROLL |
| 126-131 | CASCFG | MAIN | ALGB | CMPLX | TRIGO | MATR |
| 132-137 | DIFF | ARIT | SOLVER | EXP&LN | EPSX0 | ? |
| 138-140 | ∞ | PROMPTSTO | VER | | | |

Example: Display a menu containing ATAN2S, ASIN2T, ASIN2C and ACOS2S.

Command: MENUXY (34 , 37)

Result: The four functions are displayed above the $\boxed{\text{F1}}$ to $\boxed{\text{F4}}$ keys. In Algebraic mode, NOVAL is returned as item 1.

See also: MENU, TMENU

MKISOM

Type: Command

Description: Returns the matrix representation for a given isometry.

Access: Matrices, $\boxed{\leftarrow}$ MATRICES LINEAR APPL

Input: Level 2/Argument 1: For a 3-d isometry, a list of the characteristic elements of the isometry. For a 2-d isometry, the characteristic element of the isometry (either an angle or a vector).
Level 1/Argument 2: +1 for a direct isometry or -1 for an indirect isometry.

Output: The matrix that represents the given isometry.

Flags: Exact mode must be set (flag -105 clear).
Numeric mode must not be set (flag -3 clear).
Radians mode must be set (flag -17 set).

Example 1: Find the matrix for a rotation of $\pi/2$ radians in two dimensions

Command: MKISOM($\pi/2$, 1)

Result:
$$\begin{bmatrix} 0 & -1 \\ 1 & 0 \end{bmatrix}$$

Example 2: Find the matrix for a rotation with axis [1 1 1] and angle $\pi/3$ radians combined with a reflection in the plane $x + y + z = 0$

Command: MKISOM({ [1, 1, 1], $\pi/3$ }, -1) then simplify with EXPAND(ANS(1))

Result:
$$\begin{bmatrix} 0 & -1 & 0 \\ 0 & 0 & -1 \\ -1 & 0 & 0 \end{bmatrix}$$

See also: ISOM

MODSTO

Type: Command

Description: Changes the modulo setting to the specified number. The number that you set is reflected in the CAS Modes input form. Negative numbers are replaced by their positive value, 0 and 1 are replaced by 2.

Access: Arithmetic, $\boxed{\leftarrow}$ ARITH MODULO $\boxed{\text{NXT}}$

Input: The modulo value that you want to set, an integer or an expression that evaluates to an integer.

Output: The modulo setting is changed to the specified number. In Algebraic mode, NOVAL is returned as argument 1.

Flags: Exact mode must be set (flag -105 clear).
Numeric mode must not be set (flag -3 clear).

MODULAR

Type: Command

Description: Displays a menu or list of the CAS modulo operations.

Access: Catalog, $\boxed{\rightarrow}$ CAT

Flags: If the CHOOSE boxes flag is clear (flag -117 clear), displays the operations as a numbered list. If the flag is set, displays the operations as a menu of function keys.

See also: ALGB, ARIT, CONSTANTS, DIFF, EXP&LN, INTEGER, MAIN, MATHS, MATR, POLYNOMIAL, REWRITE, TESTS, TRIGO

MSLV

Type: Command

Description: Numerically approximates a solution to a system of equations. Searches for a solution accurate to 12 digits, regardless of the display setting. Underdetermined and overdetermined systems are rejected. Complex solutions will be looked for if any of the inputs contain complex values. If a single expression or equation is to be solved, use SOLVE instead, or for linear equations, use LINSOLVE. This command is similar to MSOLVR, but is more appropriate for use with the CAS as it automates the solution instead of working through a menu. Step-by-step mode is available with this command.

Access: Numeric solve, $\left[\rightarrow \right]$ NUM.SLV or catalog, $\left[\rightarrow \right]$ _CAT

Input: Level 3/Argument 1: A vector containing the equations or expressions (assumed equal to zero) to solve.

Level 2/Argument 2: A vector containing the variables to solve for

Level 1/Argument 3: A vector containing initial guesses

Output: Level 3/Item 1: The vector containing the equations to solve.

Level 2/Item 2: The vector containing the variables to solve for

Level 1/Item 3: A vector representing an approximate solution to the system of equations.

Flags: Exact mode must be set (flag -105 clear), The calculator will set approximate mode and will look for approximate results if exact results are not found.

Numeric mode must not be set (flag -3 clear).

Radians mode must be set (flag -17 set).

Complex mode must be set (flag -103 set) if complex results are wanted.

Step-by-step mode can be set (flag -100 set).

Example: Find x and y values, allowing for complex solutions, that solve the following two equations. The first equation is an expression equal to zero, so only the expression needs to be given. Setting the second expression equal to a complex number forces the solver to look for complex solutions:

$$\sin(x)+y=0, \quad x+\sin(y)=1:$$

Command: MSLV (' [SIN(X)+Y, X+SIN(Y)=(1,0)] ', '[X,Y]', [0,0])

Results: (' [SIN(X)+Y, X+SIN(Y)=(1,0)] ', '[X,Y]', [(1.82384112611,0.), (-.968154636174,0.)])

See also: DESOLVE, LINSOLVE, MSOLVR, SOLVE

MULTMOD

Type: Function

Description: Performs modular multiplication of two objects, modulo the current modulus.

Access: Arithmetic, $\left[\leftarrow \right]$ ARITH MODULO $\left[\rightarrow \right]$

Input: Level 2/Argument 1: A number or an expression.

Level 1/Argument 2: A number or an expression.

Output: The result of modular multiplication of the two objects, modulo the current modulus.

Flags: Exact mode must be set (flag -105 clear).
 Numeric mode must not be set (flag -3 clear).
 Radians mode must be set (flag -17 set).

Example: Find the product of $2x$ and $38x^2$, modulo the default modulus, 3.

Command: `MULTMOD (2*X, 38*X^2)`

Result: x^3

NEXTPRIME

Type: Function

Description: Given an integer, returns the next prime number larger than the integer. Like `ISPRIME?`, it uses a pseudoprime check for large numbers.

Access: Arithmetic, \leftarrow ARITH INTEGER \leftarrow NXT

Input: An integer or an expression that evaluates to an integer.

Output: The next prime number larger than the integer.

Example: Find the closest, larger prime number to 145.

Command: `NEXTPRIME (145)`

Result: 149

See also: `ISPRIME?`, `PREVPRIME`

P2C

Type: Command

Description: Takes a list representing a permutation as an argument, and returns the permutation decomposed into lists that represent cycles.

Access: \leftarrow ARITH PERM

Input: A list representing a permutation. For example, the list $\{3,1,2,5,4\}$ defines a permutation P , such that $P(1)=3$, $P(2)=1$, $P(3)=2$, $P(4)=5$, and $P(5)=4$

Output: Level 2/Item 1: A list of cycles equivalent to the permutation. For example, the list $\{3,1,2,5,4\}$ defines a cycle C , such that $C(3)=1$, $C(1)=2$, $C(2)=5$, $C(5)=4$, and $C(4)=3$
 Level 1, Item 2: The signature of the permutation, 1 or -1.

Example: Convert the permutation given by $\{3,4,5,2,1\}$ into cycles:

Command: `P2C ({3, 4, 5, 2, 1})`

Result: $\{\{1, 3, 5\}, \{2, 4\}\}, -1$

See also: `C2P`, `CIRC`

PA2B2

Type: Function

Description: Takes a prime number, p , such that $p=2$ or $p \equiv 1$ modulo 4, and returns a Gaussian integer $a + ib$ such that $p = a^2 + b^2$. This function is useful for factorizing Gaussian integers.

Access: Arithmetic, \leftarrow ARITH INTEGER \leftarrow NXT

Input: A prime number, p , such that $p=2$ or $p \equiv 1$ modulo 4

Output: A Gaussian integer $a+ib$ such that $p=a^2+b^2$

Flags: Exact mode must be set (flag -105 clear).
 Numeric mode must not be set (flag -3 clear).
 Complex mode must be set (flag -103 set).

See also: GAUSS

PARTFRAC

Type: Command

Description: Performs partial fraction decomposition on a partial fraction.

Access: Algebra $\left[\rightarrow \right]$ ALG or Arithmetic, $\left[\leftarrow \right]$ ARITH POLYNOMIAL $\left[\text{NXT} \right]$ $\left[\text{NXT} \right]$

Input: An algebraic expression.

Output: The partial fraction decomposition of the expression.

Flags: Exact mode must be set (flag -105 clear).
Numeric mode must not be set (flag -3 clear).
Radians mode must be set (flag -17 set).

Example: Perform a partial fraction decomposition of the following expression:

$$\frac{1}{x^2 - 1}$$

Command: PARTFRAC (1/ (X^2-1))

Result: 1/2/ (X-1) + -1/2/ (X+1)

See also: PROPFRAC

PCAR

Type: Command

Description: Returns the characteristic polynomial of an $n \times n$ matrix.

Access: Matrices, $\left[\leftarrow \right]$ MATRICES $\left[\text{NXT} \right]$ EIGENVECTORS

Input: A square matrix.

Output: The characteristic polynomial of the matrix.

Flags: Exact mode must be set (flag -105 clear).
Numeric mode must not be set (flag -3 clear).

Example: Find the characteristic polynomial of the following matrix:

$$\begin{bmatrix} 5 & 8 & 16 \\ 4 & 1 & 8 \\ -4 & -4 & -11 \end{bmatrix}$$

Command: PCAR ([[5 , 8 , 16] [4 , 1 , 8] [-4 , -4 , -11]])

Result: X^3+5*X^2+3*X-9

See also: JORDAN, PMINI

PMINI

Type: Command

Description: Finds the minimal polynomial of a matrix.

Access: Matrices, $\left[\leftarrow \right]$ MATRICES $\left[\text{NXT} \right]$ EIGENVECTORS

Input: An $n \times n$ matrix A.

Output: A matrix whose first zero-row contains the minimal polynomial of A. In step-by-step mode, PMINI shows the row-reduction steps.

Flags: Exact mode must be set (flag -105 clear).
Numeric mode must not be set (flag -3 clear).
Step-by-step mode can be set (flag -100 set).

Example: Find the minimal polynomial of $\begin{bmatrix} 0 & 1 \\ 1 & 0 \end{bmatrix}$:

Command: PMINI ([[0, 1] [1, 0]])

Result: $\begin{bmatrix} 1 & 0 & 0 & 1 & 1 \\ 0 & 1 & 1 & 0 & X \\ 0 & 0 & 0 & 0 & X^2 - 1 \end{bmatrix}$ So, the minimal polynomial is $X^2 - 1$, as it is in the first row to contain entirely zeros, except for the result.

See also: JORDAN, PCAR

POLYNOMIAL

Type: Command

Description: Displays a menu or list of CAS operations with polynomials.

Access: Catalog,  CAT

Flags: If the CHOOSE boxes flag is clear (flag -117 clear), displays the operations as a numbered list. If the flag is set, displays the operations as a menu of function keys.

See also: ALGB, ARIT, CONSTANTS, DIFF, EXP&LN, INTEGER, MAIN, MATHS, MATR, MODULAR, REWRITE, TESTS, TRIGO

POTENTIAL

Type: Command

Description: Find the potential field function describing a field whose vector gradient is input. This command is the opposite of DERIV. Given a vector V it attempts to return a function U such that $\text{grad } U$ is equal to V ; $\nabla U = \vec{V}$. For this to be possible, $\text{CURL}(V)$ must be zero, otherwise the command reports a “Bad Argument Value” error. Step-by-step mode is available with this command.

Access: Catalog,  CAT

Input: Level 2/Argument 1: A vector V of expressions.
Level 1/Argument 2: A vector of the names of the variables.

Output: Level 1/Item 1: A function U of the variables that is the potential from which V is derived. An arbitrary constant can be added, the command does not do this.

Flags: Exact mode must be set (flag -105 clear).
Numeric mode must not be set (flag -3 clear).
Radians mode must be set (flag -17 set).
Step-by-step mode can be set (flag -100 set).

Example: To confirm that this command is the opposite of DERIV, use the output of the example in DERIV, and show that the result is the same as the input given in the DERIV example. Find the function of the spatial variables x, y , and z whose gradient is:

$$(4xy + z)\mathbf{i} + (2x^2 + 6yz)\mathbf{j} + (x + 3y^2)\mathbf{k}$$

Command: POTENTIAL ([4*X*Y+Z, 2*X^2+6*Y*Z, X+3*Y^2], [X, Y, Z])
EXPAND (ANS (1))

Result: 2*Y*X^2+Z*X+3*Z*Y^2

See also: DERIV, VPOTENTIAL

POWEXPAND

Type: Function

Description: Rewrites an expression raised to a power as a product. If followed by repeated execution of DISTRIB allows an expression to be expanded fully, step by step.

Access: \leftarrow CONVERT REWRITE $\boxed{\text{NXT}}$

Input: An expression raised to a power.

Output: The result from applying the distributive property of exponentiation over multiplication.

Flags: Exact mode must be set (flag -105 clear).
Numeric mode must not be set (flag -3 clear).

Example: Expand $(X+1)^3$.

Command: POWEXPAND ((X+1) ^3)

Result: $(X+1) \cdot (X+1) \cdot (X+1)$

POWMOD

Type: Function

Description: Raises an object (number or expression) to the specified power, and expresses the result modulo the current modulus.

Access: Arithmetic, \leftarrow ARITH MODULO $\boxed{\text{NXT}}$

Input: Level 2/Argument 1: The object.
Level 1/Argument 2: The exponent.

Output: The result of the object raised to the exponent, modulo the current modulus.

Flags: Exact mode must be set (flag -105 clear).
Numeric mode must not be set (flag -3 clear).
Radians mode must be set (flag -17 set).

PREVAL

Type: Function

Description: With respect to the current default variable, returns the difference between the values of a function at two specified values of the variable.

PREVAL can be used in conjunction with INTVX to evaluate definite integrals. See the example below.

Access: Calculus, \leftarrow CALC DERIV. & INTEG $\boxed{\text{NXT}}$.

Input: Level 3/Argument 1: A function.
Level 2/Argument 2: The lower bound.
Level 3/Argument 1: The upper bound.
The bounds can be expressions.

Output: The result of the evaluation.

Flags: Exact mode must be set (flag -105 clear).
Numeric mode must not be set (flag -3 clear).
Radians mode must be set (flag -17 set).

Example: Evaluate the following:

$$\int_0^3 (x^3 + 3x) dx$$

Command: PREVAL (INTVX (X^3+3*X) , 0 , 3)

Result: 135/4

PREVPRIME

Type: Function

Description: Given an integer, finds the closest prime number smaller than the integer. Like ISPRIME?, it uses a pseudoprime check for large numbers.

Access: Arithmetic, \leftarrow ARITH INTEGER $\text{\textcircled{NXT}}$

Input: An integer or an expression that evaluates to an integer.

Output: The closest prime number smaller than the integer.

Example: Find the closest, smaller prime number to 145.

Command: PREVPRIME (145)

Result: 139

See also: ISPRIME?, NEXTPRIME

PROPFRAC

Type: Command

Description: Toggles between an improper fraction and its corresponding integer and fractional part.

Access: $\text{\textcircled{SYMB}}$ ARITH or Arithmetic, \leftarrow ARITH $\text{\textcircled{NXT}}$

Input: An improper fraction, or an object that evaluates to an improper fraction. It must not contain real numbers. Alternately, the input may be an integer part plus a proper fraction.

Output: An integer part plus a proper fraction; or alternately, if the input was an integer part plus a proper fraction, an improper fraction.

Flags: Exact mode must be set (flag -105 clear).
 Numeric mode must not be set (flag -3 clear).
 Radians mode must be set (flag -17 set).

Example: Express the following as a proper fraction:

$$\frac{x^3 + 4}{x^2}$$

Command: PROPFRAC ((X^3+4) /X^2)

Result: X+ (4/X^2)

PTAYL

Type: Function

Description: Returns the Taylor polynomial at $x = a$ for a specified polynomial.

Access: Arithmetic, \leftarrow ARITH POLYNOMIAL $\text{\textcircled{NXT}}$ $\text{\textcircled{NXT}}$

Input: Level 2/Argument 1: A polynomial, P.
 Level 1/Argument 2: A number, a.

Output: A polynomial, Q such that $Q(x - a) = P(x)$.

Flags: Exact mode must be set (flag -105 clear).
 Numeric mode must not be set (flag -3 clear).
 Radians mode must be set (flag -17 set).

Example: Find the polynomial $Q(x)$ such that $Q(x-2) = x^2 + 3x + 2$.

Command: PTAYL (X^2+3*X+2, 2)

Result: X^2+7*X+12

QUOT

Type: Function

Description: Returns the quotient part of the Euclidean division of two polynomials.

Access: Arithmetic, \leftarrow ARITH POLYNOMIAL \leftarrow PREV

Input: Level 2/Argument 1: The numerator polynomial.
Level 1/Argument 2: The denominator polynomial.

Output: The quotient of the Euclidean division.

Flags: Exact mode must be set (flag -105 clear).
Numeric mode must not be set (flag -3 clear).
Radians mode must be set (flag -17 set).

Example: Find the quotient of the division of $x^3 + 6x^2 + 11x + 6$ by $x^2 + 5x + 6$.

Command: QUOT (X^3+6*X^2+11*X+6, X^2+5*X+6)

Result: X+1

See also: REMAINDER, DIV2, IQUOT

QXA

Type: Command

Description: Expresses a quadratic form in matrix form.

Access: \leftarrow MATRICES QUADF, \leftarrow CONVERT MATRX

Input: Level 2/Argument 1: A quadratic form.
Level 1/Argument 2: A vector containing the variables.

Output: Level 2/Item 1: The quadratic form expressed in matrix form.
Level 1/Item 2: The vector containing the variables.

Flags: Exact mode must be set (flag -105 clear).
Numeric mode must not be set (flag -3 clear).
Radians mode must be set (flag -17 set).

Example: Express the following quadratic form in matrix form:
 $x^2 + xy + y^2$

Command: QXA (X^2+X*Y+Y^2, [X, Y])

Result: { [[1, 1/2] [1/2, 1]], [X, Y] }

See also: AXQ, GAUSS, SYLVESTER

RCLVX

Type: Command

Description: Returns the name or list of names stored in the current CAS variable. This is the same action as recalling the contents of the variable VX in the CASDIR directory.

Access: Catalog, \rightarrow CAT

Input: None.

Output: Level 1/Item 1: The name of the current CAS variable.

See also: STOVX

REF

Type: Command



Description: Reduces a matrix to echelon form. This is a subdiagonal reduction (Gauss, not Gauss-Jordan).

Access: Matrices, \leftarrow MATRICES LINEAR SYSTEMS

Input: A real or complex matrix.

Output: The equivalent matrix in echelon form.
Flags: Exact mode must be set (flag -105 clear).
Numeric mode must not be set (flag -3 clear).
Complex mode must be set (flag -103 set) if the input is complex.
See also: rref, RREFMOD

REMAINDER

Type: Function
Description: Returns the remainder of the Euclidean division of two polynomials.
Access: Arithmetic,  ARITH POLYNOMIAL  PREV
Input: Level 2/Argument 1: The numerator polynomial.
Level 1/Argument 2: The denominator polynomial.
Output: The remainder resulting from the Euclidean division.
Flags: Exact mode must be set (flag -105 clear).
Numeric mode must not be set (flag -3 clear).
Radians mode must be set (flag -17 set).
Complex mode must be set (flag -103 set) if either input is complex.
Example: Find the remainder of the division of $x^3 + 6x^2 + 11x + 6$ by $x^2 + 5x + 6$.
Command: REMAINDER (X^3+6*X^2+11*X+6, X^2+5*X+6)
Result: 0
See also: QUOT

REORDER

Type: Function
Description: Given a polynomial expression and a variable, reorders the variables in the expression in the order of powers set on the CAS Modes screen, that is, either in increasing or decreasing order.
Access: Catalog,  CAT
Input: Level 2/Argument 1: The polynomial expression.
Level 1/Argument 2: The variable with respect to which the reordering is performed.
Output: The reordered expression.
Flags: Exact mode must be set (flag -105 clear).
Numeric mode must not be set (flag -3 clear).
Radians mode must be set (flag -17 set).
Complex mode must be set (flag -103 set) if the polynomial contains complex terms.
The polynomial terms order flag (flag -114) must be set for increasing power order, or clear (the default) for decreasing power order.
Example: Reorder the polynomial $x^2 + 2y^2 + 2x + 3y$ in order of powers of y . Assume that increasing power mode has been set in the CAS modes.
Command: REORDER (X^2+2*Y^2+2*X+6+3*Y, Y)
Result: 2*Y^2+3*Y+(X^2+2*X)

RESULTANT

Type: Function
Description: Returns the resultant of two polynomials of the current variable. That is, it returns the determinant of the Sylvester matrix of the two polynomials.

Access: \leftarrow ARITH POLY \leftarrow PREV

Input: Level 2/Argument 1: The first polynomial.
Level 1/Argument 2: The second polynomial.

Output: The determinant of the two matrices that correspond to the polynomials.

Flags: Exact mode must be set (flag -105 clear).
Numeric mode must not be set (flag -3 clear).
Complex mode must be set (flag -103 set) if either input contains complex terms.

Example: Obtain the resultant of the two polynomials $x^3 - px + q$ and $3x^2 - p$.

Command: RESULTANT (X^3 - P*X + Q, 3*X^2 - P)

Result: 27*Q^2 - 4*P^3

REWRITE

Type: Command

Description: Displays a menu or list of CAS operations that rewrite expressions.

Access: Catalog, \leftarrow CAT

Flags: If the CHOOSE boxes flag is clear (flag -117 clear), displays the operations as a numbered list. If the flag is set, displays the operations as a menu of function keys.

See also: ALGB, ARIT, CONSTANTS, DIFF, EXP&LN, INTEGER, MAIN, MATHS, MATR, MODULAR, POLYNOMIAL, TESTS, TRIGO

RISCH

Type: Function

Description: Performs symbolic integration on a function using the Risch algorithm. RISCH is similar to the INTVX command, except that it allows you to specify the variable of integration.

Access: Calculus \leftarrow CALC DERIV. & INTEG \leftarrow NXT

Input: Level 2/Argument 1: The function to integrate.
Level 1/Argument 2: The variable of integration.

Output: The antiderivative of the function with respect to the variable.

Flags: Exact mode must be set (flag -105 clear).
Numeric mode must not be set (flag -3 clear).
Radians mode must be set (flag -17 set).

Example: Find the antiderivative of the following function, with respect to y :
 $y^2 + 3y + 2$

Command: RISCH (Y^2 - 3*Y + 2, Y)

Result: 1/3*Y^3 - 3*(1/2*Y^2) + 2*Y

See also: IBP, INT, INTVX

RREF

Type: Command

Description: Reduces a matrix to row-reduced echelon form. The reduction is carried out completely, so a square matrix is reduced to an identity matrix. Step-by-step mode can be used to show how the reduction proceeds.

Access: Matrices, \leftarrow MATRICES LINEAR SYSTEMS, \leftarrow MTH MATRIX FACTR

Input: A matrix.

Output: An equivalent matrix in row reduced echelon form.

Flags: Exact mode must be set (flag -105 clear).
 Numeric mode must not be set (flag -3 clear).
 Step-by-step mode can be set (flag -100 set).

Example: Solve the system of linear equations:
 $3x + 4y = 5$
 $5x + 6y = 7$
 by reducing the augmented matrix that represents this system.

Command: `RREF ([[3, 4, 5] [5, 6, 7]])`



Result: `[[1, 0, -1] [0, 1, 2]]`
 This reduced matrix represents the system:
 $1x + 0y = -1$
 $0x + 1y = 2$
 so that the solution is $x = -1, y = 2$.

See also: `rref, RREFMOD`

rref

Type: Command

Description: Reduces a matrix to row-reduced echelon form, and provides a list of pivot points.

Access:  SOLVE, Matrices,  MATRICES LINEAR SYSTEMS

Input: A matrix.

Output: Level 2/Item 1: The pivot points.
 Level 1/Item 2: An equivalent matrix in row reduced echelon form.

Flags: Exact mode must be set (flag -105 clear).
 Numeric mode must not be set (flag -3 clear)
 If flag -126 is clear (the default), row reduction is done with the last column. If the flag is set, row reduction is done without reducing the last column, but the last column will be modified by the reduction of the rest of the matrix.

Example: Reduce to row-reduced echelon form, and find the pivot points, for the matrix:

$$\begin{bmatrix} 2 & 1 \\ 3 & 4 \end{bmatrix}$$

Command: `rref ([[2, 1] [3, 4]])`

Result: `{Pivots: {5, 1., 2, 1.}, [[10, 0] [0, 5]]}`

See also: `RREFMOD`

RREFMOD

Type: Command

Description: Performs modular row-reduction to echelon form on a matrix, modulo the current modulus.

Access: Catalog,  CAT

Input: A matrix.

Output: The modular row-reduced matrix. The modulo value is set using the Modes CAS input form.

Flags: Exact mode must be set (flag -105 clear).
 Numeric mode must not be set (flag -3 clear).
 If flag -126 is clear (the default), row reduction is done with the last column. If the flag is set,

row reduction is done without reducing the last column, but the last column will be modified by the reduction of the rest of the matrix.

Example: Reduce to row-reduced echelon form, modulo 3, the matrix:

$$\begin{bmatrix} 2 & 1 \\ 3 & 4 \end{bmatrix}$$

Command: `rref [[2,1] [3,4]]`



Result: `[-1,0] [0,1]`

See also: `rref`

SERIES

Type: Command

Description: For a given function, computes Taylor series, asymptotic development and limit at finite or infinite points.

Access: Calculus,  CALC, or Limits and series,  CALC. LIMITS & SERIES

Input: Level 3/Argument 1: The function $f(x)$
Level 2/Argument 2: The variable if the limit point is 0, or an equation $x = a$ if the limit point is a . If the function is in terms of the current variable, this can be given as just the value a .
Level 1/Argument 3: The order for the series expansion. The minimum value is 2, and the maximum value is 20.

Output: Level 2/Item 1: A list containing the limit as a value and as the equivalent expression, an expression approximating the function near the limit point, and the order of the remainder. These are expressed in terms of a small parameter b .
Level 1/Item 2: An expression for b in terms of the original variable.

Flags: Exact mode must be set (flag -105 clear).
Numeric mode must not be set (flag -3 clear).
Radians mode must be set (flag -17 set).

Example: Obtain the second order Taylor series expansion of $\ln(x)$ at $x=1$.

Command: `SERIES (LN (X) , 1 , 2)`

Result: `{ {Limit: 0, Equiv: h, Expans: -1/2*h^2+h, Remain: h^3}, h=X- 1}`

See also: `TAYLOR0`

SEVAL

Type: Function

Description: Simplifies the given expression. Simplifies the expression except at the highest level, and also evaluates any existing variables that the expression contains and substitutes these back into the expression.

Access: Catalog,  CAT

Input: Level 1/Argument 1: An algebraic expression.

Output: The expression simplified and with existing variables evaluated.

Flags: Exact mode must be set (flag -105 clear).
Numeric mode must not be set (flag -3 clear).
Radians mode must be set (flag -17 set).

Example: With π stored in the variable Y, and the variables X and Z not in the current path, simplify the following expression. Note that the top-level simplification is not carried out.
 $\sin(3x - y + 2z - (2x - z)) - \sin(x - 2y + (y + 3z))$

Command: SEVAL (SIN (3*X-Y+2*Z- (2*X-Z)) - SIN (X-2*Y+ (Y+3*Z))

Result: -SIN (π - (X+3*Z)) -SIN (π - (X+3*Z))

See also: EXPAND, SIMPLIFY

SIGMA

Type: Function

Description: Calculates the discrete antiderivative of a function f with respect to a specified variable. This is a function G such that:

$$G(x + 1) - G(x) = f(x)$$

where x is the specified variable.

Access:  CALC DERIV 

Input: Level 2/Argument 1: A function

Level 1/Argument 2: The variable to calculate the antiderivative with respect to.

Output: The discrete antiderivative of the function.

Flags: Exact mode must be set (flag -105 clear).
Numeric mode must not be set (flag -3 clear).
Radians mode must be set (flag -17 set).

Example: Obtain the discrete antiderivative with respect to the variable y of the expression:
 $2x-2y$

Command: SIGMA (2*X-2*Y, Y)

Result: - (Y^2 - (2*X+1) *Y)

See also: SIGMAVX, RISCH

SIGMAVX

Type: Function

Description: Calculates the discrete antiderivative of a function f with respect to the current variable. This is a function G such that:

$$G(x + 1) - G(x) = f(x)$$

where x is the current variable.

Access:  CALC DERIV  

Input: Level 1/Argument 1: A function.

Output: The discrete antiderivative of the function.

Flags: Exact mode must be set (flag -105 clear).
Numeric mode must not be set (flag -3 clear).
Radians mode must be set (flag -17 set).

Example: Obtain the discrete antiderivative with respect to the current variable x of the expression:
 $2x-2y$

Command: SIGMAVX (2*X-2*Y)

Result: X^2 - (2*Y+1) *X

See also: SIGMA, RISCH

SIGNTAB

Type: Command

Description: Tabulates the sign of a rational function of the current CAS variable.

Access:  GRAPH,  CALC GRAPH

Input: An algebraic expression.

Output: A list containing, the points where the expression changes sign, and between each pair of points, the sign of the expression between those points.

Flags: Exact mode must be set (flag -105 clear).
 Numeric mode must not be set (flag -3 clear).
 Radians mode must be set (flag -17 set).

Example: Show the ranges of values of x for which the expression $2-x^2$ is positive and negative.

Command: SIGNTAB (2 - X^2)



Result: { '-∞' - '-√2' + '√2' - '+∞' }

See also: TABVAR

SIMP2

Type: Command

Description: Simplifies two objects by dividing them by their greatest common divisor.

Access: Arithmetic,  ARITH  NXT

Input: Level 2/Argument 1: The first object.
 Level 1/Argument 2: The second object.

Output: Level 2/Item 1: The first object divided by the greatest common divisor.
 Level 1/Item 2: The second object divided by the greatest common divisor.

Flags: Exact mode must be set (flag -105 clear).
 Numeric mode must not be set (flag -3 clear).
 Radians mode must be set (flag -17 set).

Example: Divide the following expressions by their greatest common divisor:

$$x^3 + 6x^2 + 11x + 6$$

$$x^3 - 7x - 6$$

Command: SIMP2 (X^3+6*X^2+11*X+6, X^3-7*X-6)



Result: {X+3, X-3}

See also: EGCD

SIMPLIFY

Type: Command

Description: Simplifies an expression.

Access:  CONVERT REWRITE  NXT

Input: An expression

Output: An equivalent simplified expression. SIMPLIFY follows an extensive built-in set of rules, but these might not give exactly the simplification the user expects.

Flags: Exact mode must be set (flag -105 clear).
 Numeric mode must not be set (flag -3 clear).

Example: Simplify $\frac{\sin(3 \cdot X) + \sin(7 \cdot X)}{\sin(5 \cdot X)}$

Command: SIMPLIFY ((SIN (3*X) +SIN (7*X)) /SIN (5*X))

Result: 4 *COS (X) ^2 - 2

See also: COLLECT, EXPAND

SINCOS

Type: Command

Description: Converts complex logarithmic and exponential expressions to expressions with trigonometric terms.

Access: Trigonometry, $\left[\rightarrow \right]$ $\overline{\text{TRIG}}$ $\left[\text{NXT} \right]$, $\left[\text{SYMB} \right]$ $\left[\text{NXT} \right]$ EXPLN

Input: An expression with complex linear and exponential terms.

Output: The expression with logarithmic and exponential subexpressions converted to trigonometric and inverse trigonometric expressions.

Flags: Exact mode must be set (flag -105 clear).
Numeric mode must not be set (flag -3 clear).
Radians mode must be set (flag -17 set).
Must be in complex mode (flag -103 set).

Example: Express e^{ix} in trigonometric terms.

Command: SINCOS (EXP (i *X))

Result: COS (X) +iSIN (X)

See also: EXPLN

SOLVE

Type: Command

Description: Finds zeros of an expression equated to 0, or solves an equation.

Access: Symbolic solve, $\left[\leftarrow \right]$ $\overline{\text{S.SLV}}$, $\left[\text{SYMB} \right]$ SOLVE, $\left[\rightarrow \right]$ $\overline{\text{ALG}}$ $\left[\text{NXT} \right]$

Input: Level 2/Argument 1: The expression or equation. A list of equations and expressions can be given too, each will be solved for the same variable.
Level 1/Argument 2: The variable to solve for.

Output: A zero or solution, or a list of zeros or solutions.

Flags: Radians mode must be set (flag -17 set).
If exact mode is set (flag -105 clear) and there are no exact solutions, the command returns a null list even when there are approximate solutions.
Radians mode must be set (flag -17 set).
If complex mode is set (flag -103 set) then SOLVE will search for complex roots as well as real ones. Complex roots are displayed according to the coordinate system selected.

Example 1: Find the zeros of the following expression:

$$x^3 - x - 9$$

Command: SOLVE (X^3 - X - 9, X)

Result: X=2.24004098747

Example 2: Find the real and complex roots of the two equations:

$$x^4 - 1 = 3, \quad x^2 - A = 0$$

Command: Clear numeric mode, clear approximate mode, set complex mode, set rectangular mode, enter:
SOLVE ({X^4 - 1 = 3, X^2 - A = 0} , X)



Result: { {X= $\sqrt{2} \times i$, X= $\sqrt{2} \times -1$, X= $-(\sqrt{2} \times i)$, X= $\sqrt{2}$ },
{X= $\sqrt{A} \times -1$, X= \sqrt{A} } } Note that in this case, imaginary solutions for X are returned, even if X is in REALASSUME.

See also: DESOLVE, LDEC, LINSOLVE, MSLV, QUAD, SOLVEVX

SOLVEVX

Type: Command

Description: Finds zeros of an expression with respect to the current variable, or solves an equation with respect to the current variable. (You use the CAS modes input form to set the current variable.)

Access: Symbolic solve,  S.SLV,  SOLVE

Input: An expression or equation in the current variable. A list of equations and expressions can be given too, each will be solved for the current variable.

Output: A zero or solution, or a list of zeros or solutions.

Flags: Radians mode must be set (flag -17 set).
For a symbolic result, clear the CAS modes numeric option (flag -3 clear).
If Exact mode is set (flag -105 clear) and there are no exact solutions, the command returns a null list even when there are approximate solutions.
If complex mode is set (flag -103 set) then SOLVE will search for complex roots as well as real ones. Complex roots are displayed according to the coordinate system selected.

Example: Solve the following expression for 0, where X is the default variable on the calculator:
 $x^3 - x - 9$

Command: SOLVEVX (X^3 - X - 9)

Result: X=2.24004098747

Note that if exact mode is set, this example returns a null list as there are no exact solutions to the equation.

See also: LINSOLVE, SOLVE

STORE

Type: Function

Description: Stores a number in a global variable. Given an expression as input, STORE evaluates the expression and stores the numerical value, unlike DEF which stores the expression.

Access: Catalog,  CAT

Input: Level 2/Argument 1: A number or an expression that evaluates to a numeric value.
Level 1/Argument 2: The name of the variable in which the number is to be stored. If this variable does not already exist in the current directory path then it is created.

Output: Level 1/Item 1: The number to which the first argument is evaluated, and which is stored in the variable.

Flags: Exact mode must be set (flag -105 clear).
Numeric mode must not be set (flag -3 clear).

Example: Store in variable Z the result of calculating 17*Y. Assume that Y contains the integer number 2.

Command: STORE (17*Y, Z)

Result: 34

See also: DEF, DEFINE, UNASSIGN

STOVX

Type: Command

Description: Stores a name or list of names in the current CAS variable. This is the same as storing into the VX variable in the CASDIR directory. By default, the CAS variable is called X; this command allows a program to change that name.

Access: Catalog,  _CAT

Input: Level 1/Argument 1: A name or list of names.

Output: None in RPN mode, NOVAL in Algebraic mode.

See also: RCLVX

STURM

Type: Command

Description: For a polynomial P , STURM returns a list containing Sturm's sequences of P and their multiplicities

Access: Arithmetic,  ARITH POLYNOMIAL  PREV

Input: A polynomial P

Output: A list containing the Sturm's sequences for P , and the multiplicity for each (as a real number).

Flags: Exact mode must be set (flag -105 clear).
Numeric mode must not be set (flag -3 clear).
Radians mode must be set (flag -17 set).

Example: Find the Sturm sequences and their multiplicities for the polynomial:
 $x^3 + 1$

Command: STURM(X^3+1)

Result: { [1], -1., [1], 1., [X^3+1, -(3*X^2), -1], 1. }

See also: STURMAB

STURMAB

Type: Command

Description: For a polynomial P and a closed interval $[a, b]$, STURMAB determines the number of zeroes P has in $[a, b]$

Access: Arithmetic,  ARITH POLYNOMIAL  PREV

Input: A polynomial P

Output: A list containing a number that is the same sign as $P(a)$ and the number of zeroes P has in $[a, b]$.

Flags: Exact mode must be set (flag -105 clear).
Numeric mode must not be set (flag -3 clear).
Radians mode must be set (flag -17 set).

Example: For the polynomial:
 $x^3 + 2$
in the interval $[-2, 0]$ find the sign at the lower bound, and the number of zeroes

Command: STURMAB(X^3+2, -2, 0)

Result: { -6, 1 }

See also: STURM, ZEROS

SUBST

Type: Function

Description: Substitutes a value for a variable in an expression. The value can be numeric or an expression. This is similar to the Where function, denoted by the symbol |, but SUBST substitutes without evaluating the resulting expression.

Access: Algebra, $\boxed{\rightarrow}$ ALG $\boxed{\text{NXT}}$, $\boxed{\text{SYMB}}$ ALG

Input: Level 2/Argument 1: An expression.
Level 1/Argument 2: The value or expression to be substituted.

Output: The expression with the substitution made.

Flags: Exact mode must be set (flag -105 clear).
Numeric mode must not be set (flag -3 clear).
Radians mode must be set (flag -17 set).

Example: Substitute $x = z+1$ for x in the following expression, and apply the EXPAND command to simplify the result:

$$x^2 + 3x + 7$$

Command: SUBST (X^2+3*X+7, X=Z+1)
EXPAND (ANS (1))

Result: Z^2+5*Z+11

See also: | (where command)

SUBTMOD

Type: Function

Description: Performs a subtraction, modulo the current modulus.

Access: Arithmetic, $\boxed{\leftarrow}$ ARITH MODULO $\boxed{\text{NXT}}$

Input: Level 2/Argument 1: The object or number to be subtracted from.
Level 1/Argument 2: The object or number to subtract.

Output: The result of the subtraction, modulo the current modulus.

Flags: Exact mode must be set (flag -105 clear).
Numeric mode must not be set (flag -3 clear).
Radians mode must be set (flag -17 set).

SYLVESTER

Type: Command

Description: For a symmetric matrix A, returns D and P where D is a diagonal matrix and $A = P^TDP$

Access: $\boxed{\leftarrow}$ MATRICES QUADF

Input: A symmetric matrix.

Output: Level 2/Item 1: the diagonal matrix, D.
Level 1/Item 2: The matrix P.

Flags: Exact mode must be set (flag -105 clear).
Numeric mode must not be set (flag -3 clear).
Radians mode must be set (flag -17 set).

Example: Rewrite in P^TDP form the matrix:

$$\begin{bmatrix} 1 & 2 \\ 2 & 4 \end{bmatrix}$$

Command: SYLVESTER ([1, 2] [2, 4])

Result: $\{[1, 0], [[1, 2] [0, 1]]\}$

SYST2MAT

Type: Command

Description: Converts a system of linear equations in algebraic form to matrix form.

Access: \leftarrow CONVERT MATRX, Matrices, \leftarrow MATRICES LINEAR SYSTEMS

Input: Level 2/Argument 1: A vector containing a system of linear equations. An expression with no equal sign is treated as an equation setting the expression equal to zero.
Level 1/Argument 2: A vector whose elements are the system's variables. The variables must not exist in the current path.

Output: A matrix that represents the system of linear equations.

Flags: Exact mode must be set (flag -105 clear).
Numeric mode must not be set (flag -3 clear).

Example: Convert this system to a matrix:

$$\begin{aligned} X - Y &= 0 \\ 2X + Y &= 5 \end{aligned}$$

Command: SYST2MAT([X-Y, 2*X+Y=5], [X, Y])

Result: $\begin{bmatrix} 1 & -1 & 0 \\ 2 & 1 & -5 \end{bmatrix}$

TABVAL

Type: Command

Description: For an expression and a list of values, stores the expression in EQ, and returns the results of substituting the values for the current variable in the expression.

Access: SYMB GRAPH \leftarrow CALC GRAPH \leftarrow NEXT

Input: Level 2/Argument 1: An algebraic expression in terms of the current variable.
Level 1/Argument 2: A list of values for which the expression is to be evaluated.

Output: Level 2/Item 1: The algebraic expression.
Level 1/Item 2: A list containing two lists: a list of the values and a list of the corresponding results.

Flags: Exact mode must be set (flag -105 clear).
Numeric mode must not be set (flag -3 clear).

Example: Substitute 1, 2, and 3 into $x^2 + 1$.

Command: TABVAL(X^2+1, {1, 2, 3})

Result: { X^2+1, {{1, 2, 3}, {2, 5, 10}} }

TABVAR

Type: Command

Description: For a function of the current variable, with a rational derivative, computes the variation table, that is the turning points of the function and where the function is increasing or decreasing.

Access: SYMB GRAPH \leftarrow CALC GRAPH \leftarrow NEXT

Input: An expression in terms of the current variable, which has a rational derivative.

Output: Level 3/Item 1: The original rational function.
Level 2/Item 2: A list of two lists. The first list indicates the variation of the function (where it is increasing or decreasing) in terms of the independent variable. The second list indicates

the variation in terms of the dependent variable, the function value.
Level 1/Item 3: A graphic object that shows how the variation table was computed.

Flags: Exact mode must be set (flag -105 clear).
Numeric mode must not be set (flag -3 clear).
Radians mode must be set (flag -17 set).

Example: Tabulate the variation of the function:
 $x^2 - 1$

Command: TABVAR (X^2-1)

Result: {'X^2-1' {{ '-∞' - 0 + '∞' }}{ '+∞' ↓ '-1' ↑ '+∞' }} Graphic 96 × 55 }
Viewing the graphic, one sees the original function F and its derivative, as functions of X, and the variation table for X and F, shown as a matrix

See also: SIGNTAB

TAN2CS2

Type: Command

Description: Replaces $\tan(x)$ terms in an expression with $(1-\cos(2x))/\sin(2x)$ terms.

Access: Catalog,  CAT

Input: An expression

Output: The transformed expression.

Flags: Exact mode must be set (flag -105 clear).
Numeric mode must not be set (flag -3 clear).
Radians mode must be set (flag -17 set).

Example: Replace $\tan(x)$ terms in the function:
 $(\tan(x))^2$

Command: TAN2CS2 (TAN (X) ^2)



Result: ((1-COS(2*X))/SIN(2*X))^2

See also: TAN2SC, TAN2SC2

TAN2SC

Type: Command

Description: Replaces $\tan(x)$ sub-expressions with $\sin(x)/\cos(x)$.

Access:  TRIG, Trigonometry,  TRIG 

Input: An expression

Output: The transformed expression.

Flags: Exact mode must be set (flag -105 clear).
Numeric mode must not be set (flag -3 clear).
Radians mode must be set (flag -17 set).

Example: Replace $\tan(x)$ terms in the function:
 $(\tan(x))^2$

Command: TAN2SC (TAN (X) ^2)



Result: (SIN (X) /COS (X)) ^2

See also: HALFTAN, TAN2CS2, TAN2SC2

TAN2SC2

Type: Command

Description: Replaces $\tan(x)$ terms in an expression with $\sin(2x)/1+\cos(2x)$ terms.

Access:  TRIG, Trigonometry,  

Input: An expression

Output: The transformed expression.

Flags: Exact mode must be set (flag -105 clear).
Numeric mode must not be set (flag -3 clear).
Radians mode must be set (flag -17 set).

In previous versions of the CAS, if flag -116 was set (Prefer $\sin()$), then TAN2SC2 replaced $\tan(x)$ terms with: $1 - \cos(2x)/\sin(2x)$. This action is now performed by the TAN2CS2 command.

Example: Replace $\tan(x)$ terms in the function:
 $(\tan(x))^2$

Command: TAN2SC2 (TAN (X) ^2)

Result: (SIN (2*X) / (1+COS (2*X))) ^2

See also: HALFTAN, TAN2CS2, TAN2SC

TAYLOR0

Type: Function

Description: Performs a fourth-order Taylor expansion of an expression at $x = 0$.

Access: Calculus,  CALC LIMITS & SERIES,  CALC 

Input: An expression

Output: The Taylor expansion of the expression.

Flags: Exact mode must be set (flag -105 clear).
Numeric mode must not be set (flag -3 clear).
Radians mode must be set (flag -17 set).

Example: Obtain the fourth-order Taylor series expansion of $\cos(x)$ at $x=0$.

Command: TAYLOR0 (COS (X))

Result: $1/24 * X^4 + -1/2 * X^2 + 1$

See also: DIVPC, lim, TAYLR, SERIES

TCHEBYCHEFF

Type: Function

Description: Returns the n th Tchebycheff polynomial.

Access: Catalog,  CAT

Input: A non-negative integer, n .

Output: The n th Tchebycheff polynomial.

Flags: Exact mode must be set (flag -105 clear).
Numeric mode must not be set (flag -3 clear).

Example: Obtain the fourth Tchebycheff polynomial.

Command: TCHEBYCHEFF (4)

Result: $8 * X^4 - 8 * X^2 + 1$

See also: HERMITE, LEGENDRE

TCOLLECT

Type: Command

Description: Linearizes products in a trigonometric expression by collecting sine and cosine terms, and by combining sine and cosine terms of the same argument.

Access: Trigonometry,  TRIG 

Input: An expression with trigonometric terms.

Output: The simplified expression.

Flags: Exact mode must be set (flag -105 clear).
Numeric mode must not be set (flag -3 clear).
Radians mode must be set (flag -17 set).

Example: Collect terms in the expression:

$$\sin 2x + \cos 2x$$

Command: TCOLLECT (SIN (2*X) +COS (2*X))

Result: $\sqrt{2} * \cos (2 * X - \pi / 4)$

See also: TEXPAND, TLIN

TESTS

Type: Command

Description: Displays a menu or list containing the ASSUME and UNASSUME commands, and tests that can be included in algebraic expressions.

Access: Catalog,  CAT

Flags: If the CHOOSE boxes flag is clear (flag -117 clear), displays the operations as a numbered list. If the flag is set, displays the operations as a menu of function keys.

See also: ALGB, ARIT, CONSTANTS, DIFF, EXP&LN, INTEGER, MAIN, MATHS, MATR, MODULAR, POLYNOMIAL, REWRITE, TRIGO

TEXPAND

Type: Command

Description: Expands transcendental functions.

Access:  EXP&LN,  ALG,  TRIG,  ALG ,  TRIG ,   EXPLN

Input: An expression.

Output: The transformation of the expression.

Flags: Exact mode must be set (flag -105 clear).
Numeric mode must not be set (flag -3 clear).
Radians mode must be set (flag -17 set).

Example: Expand the following expression:

$$\ln(\sin(x+y))$$

Command: TEXPAND (LN (SIN (X+Y)))



Result: $\ln (\cos (Y) * \sin (X) + \sin (Y) * \cos (X))$

See also: TCOLLECT, TLIN

TLIN

Type: Command

Description: Linearizes and simplifies trigonometric expressions. Note that this function does not collect sin and cos terms of the same angle.

Access:  TRIG, Trigonometry,  TRIG 

Input: An expression.

Output: The transformation of the expression.

Flags: Exact mode must be set (flag -105 clear).
Numeric mode must not be set (flag -3 clear).
Radians mode must be set (flag -17 set).

Example: Linearize and simplify the following:
 $(\cos(x))^4$

Command: TLIN (COS (X) ^4)

Result: $(1/8) * \cos(4X) + (1/2) * \cos(2X) + (3/8)$

See also: SIMPLIFY, TCOLLECT, TEXPAND

TRIG

Type: Command

Description: Converts complex logarithmic and exponential subexpressions into their equivalent trigonometric expressions. It also simplifies trigonometric expressions by using:
 $(\sin x)^2 + (\cos x)^2 = 1$

Access:  TRIG, Trigonometry,  TRIG  

Input: A complex expression with logarithmic and/or exponential terms, or a trigonometric expression.

Output: The transformed expression.

Flags: Exact mode must be set (flag -105 clear).
Numeric mode must not be set (flag -3 clear).
Radians mode must be set (flag -17 set).
Prefers cosine terms if “prefer cos” is selected (flag -116 clear), prefers sine terms if flag -116 is set.
Must be in Complex mode (flag -103 set) if a complex expression is being simplified.

Example: Express the following in trigonometric terms:
 $\ln(x+i)$

Command: TRIG (LN (X+i))

$$\frac{\ln(X^2 + 1) + 2 \times i \times \text{ATAN}\left(\frac{1}{X}\right)}{2}$$

Result:

See also: TRIGCOS, TRIGSIN, TRIGTAN

TRIGCOS

Type: Command

Description: Simplifies a trigonometric expression by applying the identity:
 $(\sin x)^2 + (\cos x)^2 = 1$

Returns only cosine terms if possible.

Access: Trigonometry,  TRIG  



Input: An expression with trigonometric terms.

Output: The transformed expression.
Flags: Exact mode must be set (flag -105 clear).
Numeric mode must not be set (flag -3 clear).
Radians mode must be set (flag -17 set).
See also: TRIG, TRIGSIN, TRIGTAN



TRIGO

Type: Command
Description: Displays a menu or list containing the CAS commands for transforming trigonometric expressions.
Access: Catalog,  CAT
Flags: If the CHOOSE boxes flag is clear (flag -117 clear), displays the operations as a numbered list. If the flag is set, displays the operations as a menu of function keys.
See also: ALGB, ARIT, CONSTANTS, DIFF, EXP&LN, INTEGER, MAIN, MATHS, MATR, MODULAR, POLYNOMIAL, REWRITE, TESTS

TRIGSIN

Type: Command
Description: Simplifies a trigonometric expression by applying the identity:
 $(\sin x)^2 + (\cos x)^2 = 1$
Returns only sine terms if possible.
Access: Trigonometry,  TRIG  
Input: An expression with trigonometric terms.
Output: The transformed expression.
Flags: Exact mode must be set (flag -105 clear).
Numeric mode must not be set (flag -3 clear).
Radians mode must be set (flag -17 set).
See also: TRIG, TRIGCOS, TRIGTAN





TRIGTAN

Type: Command
Description: Replaces sine and cosine terms in a trigonometric expression with tangent terms.
Access: Trigonometry,  TRIG  
Input: An expression with trigonometric terms.
Output: The transformed expression.
Flags: Exact mode must be set (flag -105 clear).
Numeric mode must not be set (flag -3 clear).
Radians mode must be set (flag -17 set).
Example: Express the following in tan terms:
 $(\sin x)^2$
Command: TRIGTAN (SIN (X) ^ 2)
Result: TAN (X) ^ 2 / (TAN (X) ^ 2 + 1)
See also: TRIG, TRIGCOS, TRIGSIN

TRUNC

- Type:** Function
- Description:** Truncates a series expansion.
- Access:** Catalog,  CAT
- Input:** Level 2/Argument 1: The expression that you want to truncate.
Level 1/Argument 2: The expression to truncate with respect to.
- Output:** The expression from Level 2/Argument 1, with terms of order greater than or equal to the order of the expression in Level 1/Argument 2 removed.
- Flags:** Exact mode must be set (flag -105 clear).
Numeric mode must not be set (flag -3 clear).
Radians mode must be set (flag -17 set).
- Example:** Expand the expression $(x+1)^7$, and remove all terms in x^4 and higher powers of x
- Command:** TRUNC ((X+1) ^7, X^4)
- Result:** $35*X^3+21*X^2+7*X+1$
- See also:** DIVPC, EXPAND, SERIES
-

TSIMP

- Type:** Command
- Description:** Performs simplifications on expressions involving exponentials and logarithms. Converts base 10 logarithms to natural logarithms
- Access:** Exponential and logarithms,  EXP&LN , or  TRIG  
- Input:** An expression
- Output:** The simplified expression.
- Flags:** Exact mode must be set (flag -105 clear).
Numeric mode must not be set (flag -3 clear).
- Example:** Simplify $\log(x+x)$
- Command:** TSIMP (LOG (X+X))
- Result:** $(LN (2) +LN (X)) / (LN (5) +LN (2))$
- See also:** TEXPAND, TLIN
-

UNASSIGN

- Type:** Command
- Description:** Removes global variables and returns their values. This is an algebraic version of the PURGE command.
- Access:** Catalog,  CAT
- Input:** Level 1/Item 1: The name of a global variable, or a list of global names, to be purged.
- Output:** Level 1/Item 1: The value or list of values that were stored in the now purged variables. If a variable does not exist, or is not in the current directory path, it is not removed, and its name is returned.
- Flags:** The status of the purge confirm flag (flag -76) is ignored, variables are purged with no request for confirmation.
- Example:** Try to remove the global variable U, which contains 17.5, and the global variable V, which is not on the current directory path.

Command: UNASSIGN({U, V})
Result: {17.5, V}
See also: ADDTOREAL, ASSUME, DEF, LOCAL, PURGE, STO, STORE, UNASSUME, UNBIND







UNASSUME

Type: Command
Description: Removes all assumptions on specified global variables, whether created by default, by ADDTOREAL or by ASSUME. Does this by removing the variable names from the list REALASSUME. Returns the variable names. To remove assumptions on a variable but leave it in REALASSUME, use ADDTOREAL instead of UNASSUME.
Access: Catalog,  CAT
Input: Level 1/Item 1: The name of a global variable, or a list of global names, to be removed from the REALASSUME list.
Output: Level 1/Item 1: The same name or list of names as was input, even if any of the named variables were not in REALASSUME.
Example: Remove the variables S1 and S2 which are include in the REALASSUME list by default.
Command: UNASSUME({S1, S2})
Result: {S1, S2}
See also: ADDTOREAL, ASSUME, DEF, LOCAL, UNASSIGN, UNBIND

UNBIND

Type: Command
Description: Removes all local variables created by the LOCAL command, and returns their values. This is useful only if a program needs to remove local variables created earlier in the same program.
Access: Catalog,  CAT
Input: None
Output: Level 1/Item 1: A list of the local variables that have been removed, with their values.
Example: Remove the local variables ←A and ←B created by the example for LOCAL.
Command: UNBIND
Result: {←B=2, ←A=0}
See also: DEF, LOCAL, STORE, UNASSIGN, UNASSUME

VANDERMONDE

Type: Command
Description: Builds the Vandermonde matrix (also called the alternant matrix) from a list of objects. That is, for a list of n objects, the command creates an $n \times n$ matrix. The i^{th} column in the matrix consists of the list items raised to the power of $(i-1)$. Sometimes the Vandermonde matrix is defined with the i^{th} row containing the items raised to the power of $(i-1)$; to obtain this, transpose the result with the command TRAN.
Access: Matrices,  MATRICES CREATE  ,  MTH MATRX MAKE  
Input: A list of objects. A vector is allowed too.
Output: The corresponding Vandermonde matrix.
Flags: Exact mode must be set (flag -105 clear).
Numeric mode must not be set (flag -3 clear).

Example: Build the row version of the Vandermonde matrix from the following list of objects:

$\{x, y, z\}$

Command: TRAN (VANDERMONDE ({x, y, z}))

$$\begin{bmatrix} 1 & 1 & 1 \\ x & y & z \\ x^2 & y^2 & z^2 \end{bmatrix}$$

Result:

See also: CON, HILBERT, IDN, RANM

VER

Type: Command

Description: Returns the Computer Algebra System version number, and date of release.

Access: Catalog,  _CAT

Input: No input required.

Output: A real number giving the version and release date of the Computer Algebra System software.

Flags: The version and release date are given as a number of the form V.YYYYMMDD, so a display mode showing at least 8 digits after the fraction mark is needed to display the result in full.

VPOTENTIAL

Type: Command

Description: Find a vector potential function describing a field whose curl (or “rot”) is the input. This command is the opposite of CURL. Given a vector V it attempts to return a function U such that curl U is equal to V ; $\vec{\nabla} \times \vec{U} = \vec{V}$. For this to be possible, DIV(V) must be zero, otherwise the command reports a “Bad Argument Value” error. Step-by-step mode is available with this command.

Access: Catalog,  _CAT

Input: Level 2/Argument 1: A vector V of expressions.
Level 1/Argument 2: A vector of the names of the variables.

Output: Level 1/Item 1: A vector U of the variables that is the potential from which V is obtained. An arbitrary constant can be added, the command does not do this.

Flags: Exact mode must be set (flag -105 clear).
Numeric mode must not be set (flag -3 clear).
Radians mode must be set (flag -17 set).
Step-by-step mode can be set (flag -100 set).

Example: To see if this command is the opposite of CURL, use the output of the example in CURL as input to VPOTENTIAL. Find a vector in the spatial variables $x, y,$ and z whose curl is:
 $(2yz)\mathbf{i} + (0)\mathbf{j} + (2xy - x^2)\mathbf{k}$

Command: VPOTENTIAL ([2*Y*Z, 0, 2*X*Y-X^2], [X, Y, Z])
EXPAND (ANS (1))

Result: [0, -((X^3-3*Y*X^2)/3), Z*Y^2]

This shows that the reversal is not unique – more than one vector can have the same curl. However, obtaining the curl of the above result, and then applying VPOTENTIAL to it again will give the same result.

See also: CURL, POTENTIAL

XNUM

Type: Command

Description: Converts an object or a list of objects to 12-digit decimal numeric format. Similar to \rightarrow NUM except that \rightarrow NUM does not work with lists, nor in programs in algebraic mode.

Access: Catalog, $\boxed{\rightarrow}$ CAT

Input: An object or list of objects.

Output: The objects in numeric format.

Example: Find the 12-digit numeric values of $\pi/2$, $3e$, and $4\cos(2)$.

Command: XNUM ({ $\pi/2$, $3*e$, $4*\cos(2)$)

Results: { 1.5707963268 8.15484548538 -1.66458734619 }

See also: I \rightarrow R, \rightarrow NUM

XQ

Type: Command

Description: Converts a number, or a list of numbers in decimal format, to quotient (rational) format. Similar to the \rightarrow Q π command, but also clears numeric constants mode (flag -2) and sets exact mode (flag -105).

Access: Catalog, $\boxed{\rightarrow}$ CAT

Input: A number, or a list of numbers.

Output: The number or list of numbers in rational format. This rational number converts to the input value to the accuracy of the current display setting.

Example 1: Express .3658 in rational format, in Std mode:

Command: XQ (.3658)

Results: 1829/5000

Example 2: Express .3658 in rational format, in Fix 4 mode:

Command: XQ (.3658)

Results: $\sqrt{19/142}$

Example 3: Express 1.04719755120 in rational format, in Eng 11 mode:

Command: XQ (1.04719755120)

Results: $1/3*\pi$

See also: \rightarrow Q, \rightarrow Q π

ZEROS

Type: Command

Description: Returns the zeros of a function of one variable, without multiplicity.

Access: $\boxed{\text{SYMB}}$ SOLVE, Symbolic solve, $\boxed{\leftarrow}$ S.SLV $\boxed{\text{NXT}}$

Input: Level 2/Argument 1: An expression.
Level 1/Argument 2: The variable to solve for.

Output: The solution, or a list of solutions, for the expression equated to 0.

Flags: Radians mode must be set (flag -17 set).
For a symbolic result, clear the CAS modes Numeric option (flag -3 clear).
The following flag -settings affect the result:

- If Exact mode is set (flag -105 is clear), attempts to find exact solutions only. This may return a null list, even if approximate solutions exist.
- If Approximate mode is set (flag -105 set), finds numeric roots.

- If Complex mode is set (flag -103 set), searches for real and complex roots.

Example: Find the roots of the following equation in x , without specifying that $x=2$ is a root twice.
 $x^3 - x^2 - 8x + 12 = 0$:

Command: ZEROS (X^3-X^2-8*X+12)

Results: $\{-3, 2\}$

?

Type: Function

Description: The “undefined” symbol. Used to signify a numeric result that is not defined by the rules of arithmetic, such as the result of dividing zero by zero, or infinity by infinity. Mathematical operations on **?** return **?** as a result. Can be used in programs to check for an earlier undefined operation.

This use of **?** is unrelated to the use of **?** as a spare unit in the units system. The unit **?** can be used to create new units based on it, units that can not be expressed in terms of other base units. For example you could define $\$=1_?$ Then other currencies could be defined as multiples or fractions of $1_?$ The calculator has symbols for Yen, Pounds and Euros; other currencies could be defined using their names. The unit conversion system would then check conversions between them for consistency because **?** is recognized as a base unit.

Access: Catalog,  CAT, or   **3**

∞

Type: Function

Description: Infinity: used to signify a numeric result that is infinite by the rules of arithmetic, such as the result of dividing a non-zero number by zero. The calculator recognizes two kinds of infinity: signed and unsigned. Evaluating '1/0' gives an unsigned infinity '∞'. Selecting infinity from the keyboard, from the CHARS table, or from the catalog  CAT returns '+∞' and the sign can be changed. Calculations with the unsigned infinity return unsigned infinity or **?** as their result. Calculations with the signed infinity can return ordinary numeric results, as in the example. Positive infinity and unsigned infinity are equal if tested with $==$, but are not identical if tested with SAME.

Access: Keyboard, CHARS, or catalog,  CAT

Flags: Exact mode must be set (flag -105 clear), and numeric mode must not be set (flag -3 clear) for mathematical operations to give ∞ as a result, and for executing ∞ from the keyboard or catalog to give +∞ and not an error.

Example: Find the arc tangent of minus infinity. Assume that radians mode is set.

Command: ATAN (-∞)

Results: $-(\pi/2)$

Equation Reference

The Equation Library consists of 15 subjects and more than 100 titles. Each subject and title has a number that you can use with SOLVEQN to specify the set of equations. These numbers are shown in parentheses after the headings.

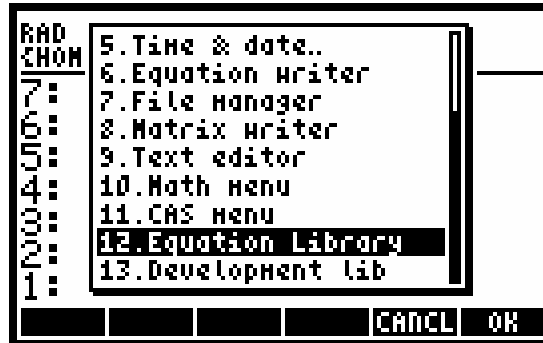

See the end of this section for references given in each subject. Remember that some equations are estimates and assume certain conditions. See the references or other standard texts for assumptions and limitations of the equations. Solutions in the examples have been rounded to four decimal places.

NOTE: You must set system flag -117 in order to enable the soft menus for Equation Library usage.

The next page is a handy one-page table of contents to the equations and groups within the library. The columns headers provide the subject, the number of variables, the presence or absence of a picture, the number of equations and the page number where the group can be found. The example shown below should be read as follows:

```
Subject, var (subj, title) Pic EQ Pg
COLUMNS AND BEAMS, 22 ***** (1) ***
Elastic Buckling (1,1) Y 4 5-4
```

COLUMNS AND BEAMS, 22 *** (1) *****

Columns and beams – The group header.

22 – The number of variables in the group.

(1) – Indicates that Columns and beams are the first group.

```
Elastic Buckling (1,1) Y 4 5-4
```

Elastic Buckling – The subject area of the first set of equations.

(1,1) – Indicates that Elastic Buckling is the first subject area within the columns and beams group.

Y – Indicates that a picture is present for this subject area.

4 – Indicates that there are 4 equations in this subject area.

5-4 – Indicates this subject area can be found on page 5-4.

It is provided as a quick reference.

| Subject, var (subj, title) | Pic | EQ | Pg |
|--|-----|----|------|
| COLUMNS AND BEAMS, 22 ***** (1) ***** | | | |
| Elastic Buckling (1,1) | Y | 4 | 5-4 |
| Eccentric Columns (1,2) | Y | 2 | 5-4 |
| Simple Deflection (1,3) | Y | 1 | 5-5 |
| Simple Slope (1,4) | Y | 1 | 5-5 |
| Simple Moment (1,5) | Y | 1 | 5-6 |
| Simple Shear (1,6) | Y | 1 | 5-6 |
| Cantilever Deflection (1,7) | Y | 1 | 5-7 |
| Cantilever Slope (1,8) | Y | 1 | 5-7 |
| Cantilever Moment (1,9) | Y | 1 | 5-8 |
| Cantilever Shear (1,10) | Y | 1 | 5-8 |
| ELECTRICITY, 47 ***** (2) ***** | | | |
| Coulomb's Law (2,1) | N | 1 | 5-10 |
| Ohm's Law and Power (2,2) | N | 4 | 5-10 |
| Voltage Divider (2,3) | Y | 1 | 5-11 |
| Current Divider (2,4) | Y | 1 | 5-11 |
| Wire Resistance (2,5) | Y | 2 | 5-11 |
| Series and Parallel R (2,6) | Y | 2 | 5-12 |
| Series and Parallel C (2,7) | Y | 2 | 5-12 |
| Series and Parallel L (2,8) | Y | 2 | 5-13 |
| Capacitive Energy (2,9) | N | 1 | 5-13 |
| Inductive Energy (2,10) | N | 1 | 5-13 |
| RLC Current Delay (2,11) | Y | 5 | 5-14 |
| DC Capacitor Current (2,12) | N | 3 | 5-14 |
| Capacitor Charge (2,13) | N | 1 | 5-14 |
| DC Inductor Voltage (2,14) | N | 3 | 5-14 |
| RC Transient (2,15) | Y | 1 | 5-15 |
| RL Transient (2,16) | N | 1 | 5-15 |
| Resonant Frequency (2,17) | N | 4 | 5-16 |
| Plate Capacitor (2,18) | Y | 1 | 5-16 |
| Cylindrical Capacitor (2,19) | Y | 1 | 5-16 |
| Solenoid Inductance (2,20) | Y | 1 | 5-17 |
| Toroid Inductance (2,21) | Y | 1 | 5-17 |
| Sinusoidal Voltage (2,22) | N | 2 | 5-18 |
| Sinusoidal Current (2,23) | N | 2 | 5-18 |
| FLUIDS, 24 ***** (3) ***** | | | |
| Pressure at Depth (3,1) | Y | 1 | 5-19 |
| Bernoulli Equation (3,2) | Y | 10 | 5-19 |
| Flow with Losses (3,3) | Y | 10 | 5-20 |
| Flow in Full Pipes (3,4) | Y | 8 | 5-21 |
| FORCES AND ENERGY, 32 ***** (4) ***** | | | |
| Linear Mechanics (4,1) | N | 8 | 5-22 |
| Angular Mechanics (4,2) | N | 12 | 5-23 |
| Centripetal Force (4,3) | N | 4 | 5-23 |
| Hooke's Law (4,4) | Y | 2 | 5-23 |
| 1D Elastic Collisions (4,5) | Y | 2 | 5-24 |
| Drag Force (4,6) | N | 1 | 5-24 |
| Law of Gravitation (4,7) | N | 1 | 5-24 |
| Mass-Energy Relation (4,8) | N | 1 | 5-24 |
| GASES, 26 ***** (5) ***** | | | |
| Ideal Gas Law (5,1) | N | 2 | 5-25 |
| Ideal Gas State Change (5,2) | N | 1 | 5-26 |
| Isothermal Expansion (5,3) | N | 2 | 5-26 |
| Polytropic Processes (5,4) | N | 2 | 5-26 |
| Isentropic Flow (5,5) | Y | 4 | 5-26 |
| Real Gas Law (5,6) | N | 2 | 5-27 |
| Real Gas State Change (5,7) | N | 1 | 5-27 |
| Kinetic Theory (5,8) | N | 4 | 5-28 |

| Subject, var (subj, title) | Pic | EQ | Pg |
|---|-----|----|------|
| HEAT TRANSFER, 23 ***** (6) ***** | | | |
| Heat Capacity (6,1) | N | 2 | 5-29 |
| Thermal Expansion (6,2) | Y | 2 | 5-29 |
| Conduction (6,3) | Y | 2 | 5-29 |
| Convection (6,4) | Y | 2 | 5-30 |
| Conduction+Convection (6,5) | Y | 4 | 5-30 |
| Black Body Radiation (6,6) | Y | 5 | 5-30 |
| MAGNETISM, 11 ***** (7) ***** | | | |
| Straight Wire (7,1) | Y | 1 | 5-32 |
| Force between Wires (7,2) | Y | 1 | 5-32 |
| Magnetic (B) Field in Solenoid (7,3) | Y | 1 | 5-33 |
| Magnetic (B) Field in Toroid (7,4) | Y | 1 | 5-33 |
| MOTION, 30 ***** (8) ***** | | | |
| Linear Motion (8,1) | N | 4 | 5-35 |
| Object in Free Fall (8,2) | N | 4 | 5-35 |
| Projectile Motion (8,3) | Y | 5 | 5-35 |
| Angular Motion (8,4) | N | 4 | 5-36 |
| Circular Motion (8,5) | N | 3 | 5-36 |
| Terminal Velocity (8,6) | N | 1 | 5-36 |
| Escape Velocity (8,7) | N | 1 | 5-36 |
| OPTICS, 10 ***** (9) ***** | | | |
| Law of Refraction (9,1) | Y | 1 | 5-37 |
| Critical Angle (9,2) | Y | 1 | 5-38 |
| Brewster's Law (9,3) | Y | 2 | 5-38 |
| Spherical Reflection (9,4) | Y | 3 | 5-39 |
| Spherical Refraction (9,5) | Y | 1 | 5-39 |
| Thin Lens (9,6) | Y | 3 | 5-39 |
| OSCILLATIONS, 17 ***** (10) ***** | | | |
| Mass-Spring System (10,1) | Y | 3 | 5-41 |
| Simple Pendulum (10,2) | Y | 3 | 5-41 |
| Conical Pendulum (10,3) | Y | 4 | 5-42 |
| Torsional Pendulum (10,4) | Y | 3 | 5-42 |
| Simple Harmonic (10,5) | N | 4 | 5-42 |
| PLANE GEOMETRY, 21 ***** (11) ***** | | | |
| Circle (11,1) | Y | 5 | 5-44 |
| Ellipse (11,2) | Y | 5 | 5-44 |
| Rectangle (11,3) | Y | 5 | 5-45 |
| Regular Polygon (11,4) | Y | 6 | 5-45 |
| Circular Ring (11,5) | Y | 4 | 5-46 |
| Triangle (11,6) | Y | 5 | 5-46 |
| SOLID GEOMETRY, 12 ***** (12) ***** | | | |
| Cone (12,1) | Y | 5 | 5-47 |
| Cylinder (12,2) | Y | 5 | 5-48 |
| Parallelepiped (12,3) | Y | 4 | 5-48 |
| Sphere (12,4) | Y | 4 | 5-49 |
| SOLID STATE DEVICES, 60 ***** (13) ***** | | | |
| PN Step Junctions (13,1) | Y | 8 | 5-51 |
| NMOS Transistors (13,2) | Y | 10 | 5-52 |
| Bipolar Transistors (13,3) | Y | 8 | 5-53 |
| JFETs (13,4) | Y | 7 | 5-53 |
| STRESS ANALYSIS, 28 ***** (14) ***** | | | |
| Normal Stress (14,1) | Y | 3 | 5-55 |
| Shear Stress (14,2) | Y | 3 | 5-56 |
| Stress on an Element (14,3) | Y | 3 | 5-56 |
| Mohr's Circle (14,4) | Y | 7 | 5-57 |
| WAVES, 16 ***** (15) ***** | | | |
| Traverse Waves (15,1) | Y | 4 | 5-58 |
| Longitudinal Waves (15,2) | N | 4 | 5-58 |
| Sound Waves (15,3) | N | 4 | 5-58 |

Columns and Beams (1)

| Variable | Description |
|----------------|---|
| e | Eccentricity (offset) of load |
| σ_{cr} | Critical stress |
| σ_{max} | Maximum stress |
| θ | Slope at x |
| A | Cross-sectional area |
| a | Distance to point load |
| c | Distance to edge fiber (Eccentric Columns), or Distance to applied moment (beams) |
| E | Modulus of elasticity |
| I | Moment of inertia |
| K | Effective length factor of column |
| L | Length of column or beam |
| M | Applied moment |
| M_x | Internal bending moment at x |
| P | Load (Eccentric Columns), or Point load (beams) |
| P_{cr} | Critical load |
| r | Radius of gyration |
| V | Shear force at x |
| w | Distributed load |
| x | Distance along beam |
| y | Deflection at x |

For simply supported beams and cantilever beams (“Simple Deflection” through “Cantilever Shear”), the calculations differ depending upon the location of x relative to the loads.

- Applied loads are positive downward.
- The applied moment is positive counterclockwise.
- Deflection is positive upward.
- Slope is positive counterclockwise
- Internal bending moment is positive counterclockwise on the left-hand part.
- Shear force is positive downward on the left-hand part.

Reference: 2.

Elastic Buckling (1, 1)

These equations apply to a slender column ($K \cdot L / r > 100$) with length factor K .

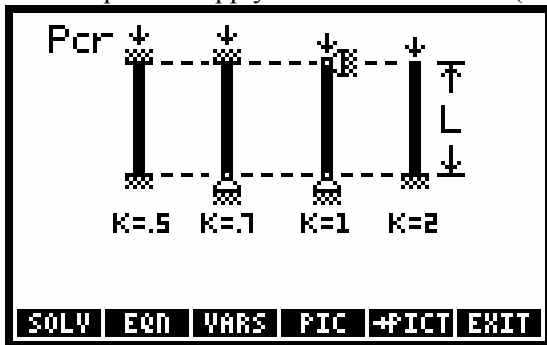

Equations:

$$P_{cr} = \frac{\pi^2 \cdot E \cdot A}{\left(\frac{K \cdot L}{r}\right)^2} \quad P_{cr} = \frac{\pi^2 \cdot E \cdot I}{(K \cdot L)^2} \quad \sigma_{cr} = \frac{P_{cr}}{A} \quad r = \sqrt{\frac{I}{A}}$$

Example:

Given: $L=7.3152_m$, $r=4.1148_cm$, $E=199947961.502_kPa$, $A=53.0967_cm^2$, $K=0.7$, $I=8990598.7930_mm^4$.

Solution: $P_{cr}=676.6019_kN$, $\sigma_{cr}=127428.2444_kPa$.

Eccentric Columns (1, 2)

These equations apply to a slender column ($K \cdot L / r > 100$) with length factor K .

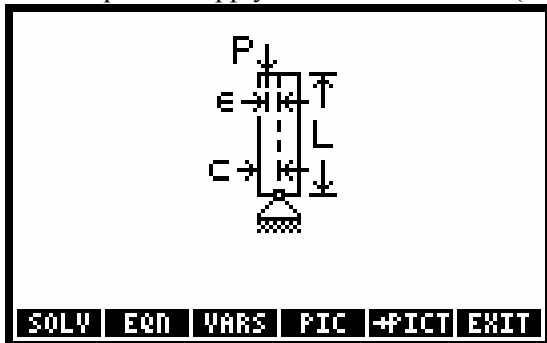

Equations:

$$\sigma_{max} = \frac{P}{A} \cdot \left(1 + \frac{e \cdot c}{r^2} \cdot \left(\frac{1}{\cos\left(\frac{K \cdot L}{2 \cdot r} \cdot \sqrt{\frac{P}{E \cdot A}}\right)} \right) \right) \quad r = \sqrt{\frac{I}{A}}$$

Example:

Given: $L=6.6542_m$, $A=187.9351_cm^2$, $r=8.4836_cm$, $E=206842718.795_kPa$, $I=135259652.16_mm^4$, $K=1$, $P=1908.2571_kN$, $c=15.24_cm$, $e=1.1806_cm$.

Solution: $\sigma_{max}=140853.0970_kPa$.

Simple Deflection (1, 3)

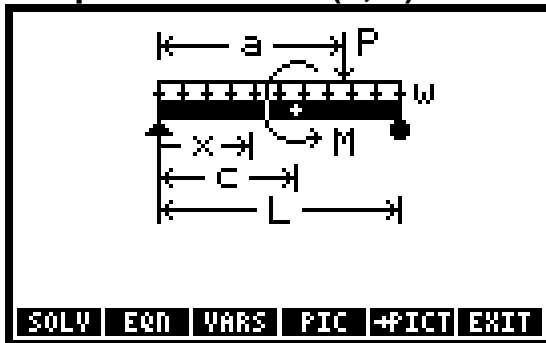

Equation:

$$y = \frac{P \cdot (L - a) \cdot x}{6 \cdot L \cdot E \cdot I} \cdot (x^2 + (L - a)^2 - L^2) - \frac{M \cdot x}{E \cdot I} \cdot \left(c - \frac{x^2}{6 \cdot L} - \frac{L}{3} - \frac{c^2}{2 \cdot L} \right) - \frac{w \cdot x}{24 \cdot E \cdot I} \cdot (L^3 + x^2 \cdot (x - 2 \cdot L))$$

Example:

Given: $L=20$ _ft, $E=29000000$ _psi, $I=40$ _in⁴, $a=10$ _ft, $P=674.427$ _lbf, $c=17$ _ft, $M=3687.81$ _ft*lbf, $w=102.783$ _lbf/ft, $x=9$ _ft.

Solution: $y = -0.6005$ _in.

Simple Slope (1, 4)

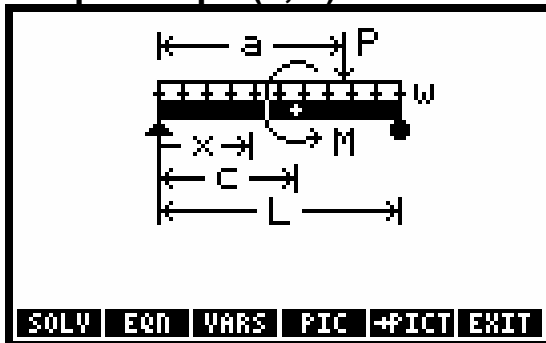

Equation:

$$\Theta = \frac{P \cdot (L - a)}{6 \cdot L \cdot E \cdot I} \cdot (3 \cdot x^2 + (L - a)^2 - L^2) - \frac{M}{E \cdot I} \cdot \left(c - \frac{x^2}{2 \cdot L} - \frac{L}{3} - \frac{c^2}{2 \cdot L} \right) - \frac{w}{24 \cdot E \cdot I} \cdot (L^3 + x^2 \cdot (4 \cdot x - 6 \cdot L))$$

Example:

Given: $L=20_ft$, $E=29000000_psi$, $I=40_in^4$, $a=10_ft$, $P=674.427_lbf$, $c=17_ft$, $M=3687.81_ft\cdot lbf$, $w=102.783_lbf/ft$, $x=9_ft$.

Solution: $\theta = -0.0876_^\circ$.

Simple Moment (1, 5)

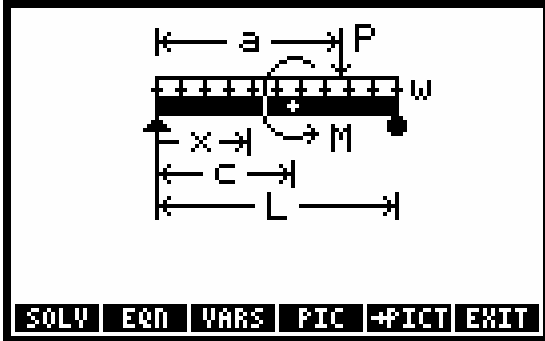

Equation:

$$M_x = \frac{P \cdot (L - a) \cdot x}{L} + \frac{M \cdot x}{L} + \frac{w \cdot x}{2} \cdot (L - x)$$

Example:

Given: $L=20_ft$, $a=10_ft$, $P=674.427_lbf$, $c=17_ft$, $M=3687.81_ft\cdot lbf$, $w=102.783_lbf/ft$, $x=9_ft$.

Solution: $M_x=9782.1945_ft\cdot lbf$

Simple Shear (1, 6)

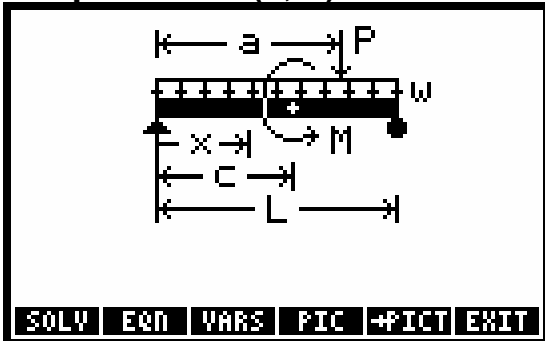

Equation:

$$V = \frac{P \cdot (L - a)}{L} + \frac{M}{L} + \frac{w}{2} \cdot (L - 2 \cdot x)$$

Example:

Given: $L=20_ft$, $a=10_ft$, $P=674.427_lbf$, $M=3687.81_ft\cdot lbf$, $w=102.783_lbf/ft$, $x=9_ft$.

Solution: $V=624.387_lbf$.

Cantilever Deflection (1, 7)

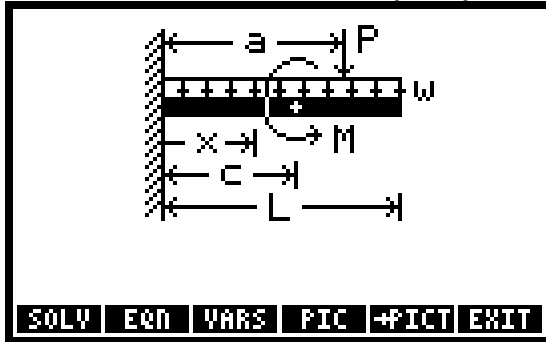

Equation:

$$y = \frac{P \cdot x^2}{6 \cdot E \cdot I} \cdot (x - 3 \cdot a) + \frac{M \cdot x^2}{2 \cdot E \cdot I} - \frac{w \cdot x^2}{24 \cdot E \cdot I} \cdot (6 \cdot L^2 - 4 \cdot L \cdot x + x^2)$$

Example:

Given: $L=10_ft$, $E=29000000_psi$, $I=15_in^4$, $P=500_lbf$, $M=800_ft \cdot lbf$, $a=3_ft$, $c=6_ft$, $w=100_lbf/ft$, $x=8_ft$.

Solution: $y = -0.3316_in$.

Cantilever Slope (1, 8)

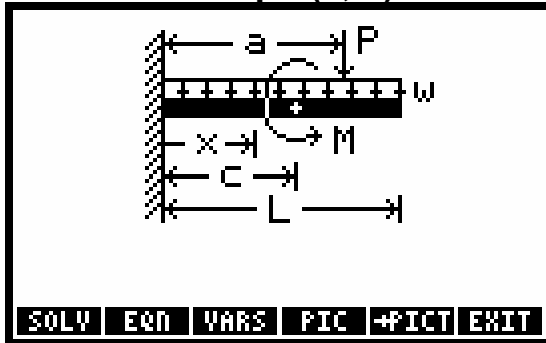

Equation:

$$\Theta = \frac{P \cdot x}{2 \cdot E \cdot I} \cdot (x - 2 \cdot a) + \frac{M \cdot x}{E \cdot I} - \frac{w \cdot x}{6 \cdot E \cdot I} \cdot (3 \cdot L^2 - 3 \cdot L \cdot x + x^2)$$

Example:

Given: $L=10_ft$, $E=29000000_psi$, $I=15_in^4$, $P=500lbf$, $M=800_ft \cdot lbf$, $a=3_ft$, $c=6_ft$, $w=100_lbf/ft$, $x=8_ft$.

Solution: $\Theta = -0.2652_^\circ$.

Cantilever Moment (1, 9)

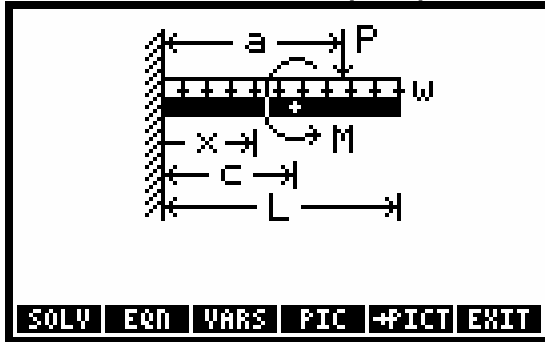

Equation:

$$M_x = P \cdot (x - a) + M - \frac{W}{2} \cdot (L^2 - 2 \cdot L \cdot x + x^2)$$

Example:

Given: $L=10_ft$, $P=500lbf$, $M=800_ft \cdot lbf$, $a=3_ft$, $c=6_ft$, $w=100_lbf/ft$, $x=8_ft$.

Solution: $M_x = -200_ft \cdot lbf$

Cantilever Shear (1, 10)

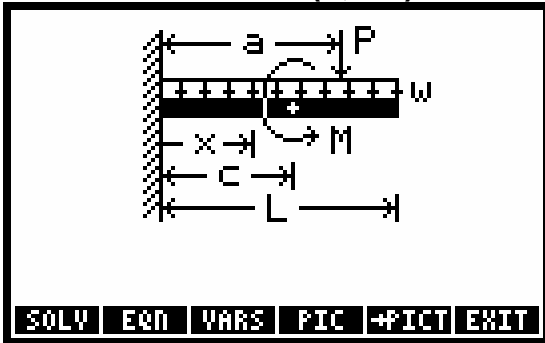

Equation:

$$V = P + w \cdot (L - x)$$

Example:

Given: $L=10_ft$, $P=500lbf$, $a=3_ft$, $x=8_ft$, $w=100_lbf/ft$.

Solution: $V=200_lbf$

Electricity (2)

| Variable | Description |
|------------------|--|
| ϵ_r | Relative permittivity |
| μ_r | Relative permeability |
| ω | Angular frequency |
| ω_0 | Resonant angular frequency |
| ϕ | Phase angle |
| ϕ_p, ϕ_s | Parallel and series phase angles |
| ρ | Resistivity |
| ΔI | Current change |
| Δt | Time change |
| ΔV | Voltage change |
| A | Wire cross-section area (Wire Resistance), or Solenoid cross-section area (Solenoid Inductance), or Plate area (Plate Capacitor) |
| C, C_1, C_2 | Capacitance |
| C_p, C_s | Parallel and series capacitances |
| d | Plate separation |
| E | Energy |
| F | Force between charges |
| f | Frequency |
| f_0 | Resonant frequency |
| I | Current, or Total current (Current Divider) |
| I_1 | Current in R1 |
| I_{max} | Maximum current |
| L | Inductance, or Length (Wire Resistance, Cylindrical Capacitor) |
| L_1, L_2 | Inductance |
| L_p, L_s | Parallel and series inductances |
| N | Number of turns |
| n | Number of turns per unit length |
| P | Power |
| q | Charge |
| q_1, q_2 | Point charge |

| Variable | Description |
|-------------|---|
| Qp, Qs | Parallel and series quality factors |
| r | Charge distance |
| $R, R1, R2$ | Resistance |
| ri, ro | Inside and outside radii |
| Rp, Rs | Parallel and series resistances |
| t | Time |
| ti, tf | Initial and final times |
| V | Voltage, or Total voltage (Voltage Divider) |
| $V1$ | Voltage across R1 |
| Vi, Vf | Initial and final voltages |
| $Vmax$ | Maximum voltage |
| XC | Reactance of capacitor |
| XL | Reactance of inductor |

Reference: 3.

Coulomb's Law (2, 1)

This equation describes the electrostatic force between two charged particles.

Equation:

$$F = \frac{1}{4 \cdot \pi \cdot \epsilon_0 \cdot \epsilon_r} \cdot \left(\frac{q1 \cdot q2}{r^2} \right)$$

Example:

Given: $q1=1.6E-19_C$, $q2=1.6E-19_C$, $r=4.00E-13_cm$, $\epsilon_r=1.00$.

Solution: $F=14.3801_N$.

Ohm's Law and Power (2, 2)

Equations:

$$V = I \cdot R \quad P = V \cdot I \quad P = I^2 \cdot R \quad P = \frac{V^2}{R}$$

Example:

Given: $V=24_V$, $I=16_A$.

Solution: $R=1.5_Ω$, $P=384_W$.

Voltage Divider (2, 3)

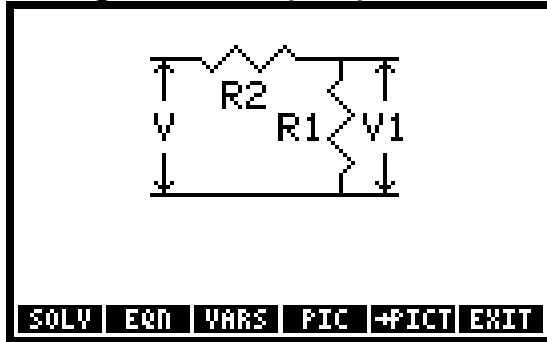

Equation:

$$V_1 = V \cdot \left(\frac{R_1}{R_1 + R_2} \right)$$

Example:

Given: $R_1=40_\Omega$, $R_2=10_\Omega$, $V=100_V$.

Solution: $V_1=80_V$.

Current Divider (2, 4)

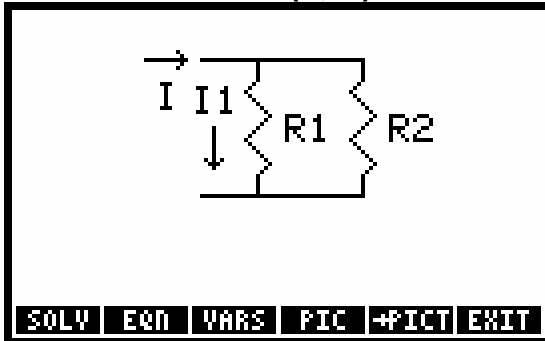

Equation:

$$I_1 = I \cdot \left(\frac{R_2}{R_1 + R_2} \right)$$

Example:

Given: $R_1=10_\Omega$, $R_2=6_\Omega$, $I=15_A$.

Solution: $I_1=5.6250_A$.

Wire Resistance (2, 5)

Equation:

$$R = \frac{\rho \cdot L}{A}$$

Example:

Given: $\rho=0.0035\ \Omega\cdot\text{cm}$, $L=50\ \text{cm}$, $A=1\ \text{cm}^2$.

Solution: $R=0.175\ \Omega$.

Series and Parallel R (2, 6)

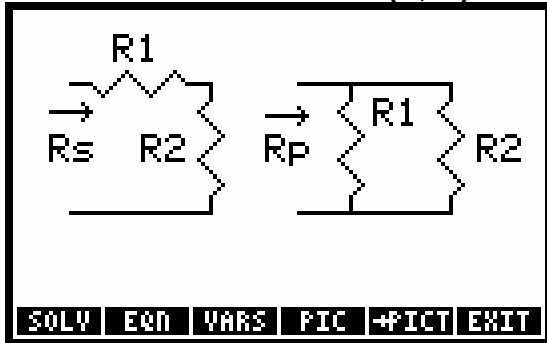

Equation:

$$R_s = R_1 + R_2 \qquad \frac{1}{R_p} = \frac{1}{R_1} + \frac{1}{R_2}$$

Example:

Given: $R_1=2\ \Omega$, $R_2=3\ \Omega$.

Solution: $R_s=5\ \Omega$, $R_p=1.2000\ \Omega$.

Series and Parallel C (2, 7)

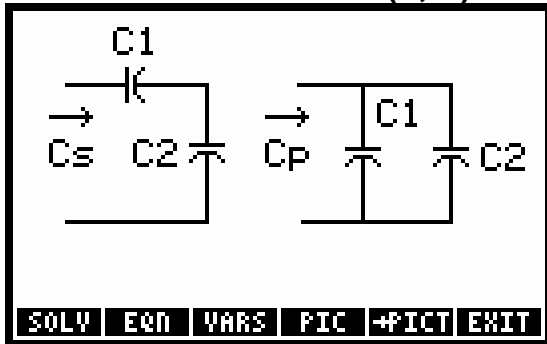

Equations:

$$\frac{1}{C_s} = \frac{1}{C_1} + \frac{1}{C_2} \qquad C_p = C_1 + C_2$$

Example:

Given: $C_1=2\ \mu\text{F}$, $C_2=3\ \mu\text{F}$.

Solution: $C_s=1.2000\ \mu\text{F}$, $C_p=5\ \mu\text{F}$.

Series and Parallel L (2, 8)

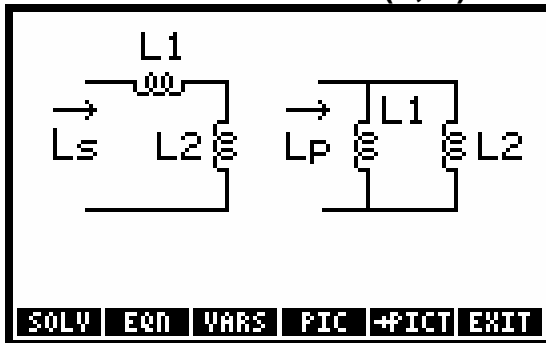

Equations:

$$L_s = L_1 + L_2 \qquad \frac{1}{L_p} = \frac{1}{L_1} + \frac{1}{L_2}$$

Example:

Given: $L_1=17_mH$, $L_2=16.5_mH$,

Solution: $L_s=33.5000_mH$, $L_p=8.3731_mH$.

Capacitive Energy (2, 9)

Equation:

$$E = \frac{C \cdot V^2}{2}$$

Example:

Given: $E=0.025_J$, $C=20_μF$.

Solution: $V=50_V$.

Inductive Energy (2, 10)

Equation:

$$E = \frac{L \cdot I^2}{2}$$

Example:

Given: $E=4_J$, $L=15_mH$.

Solution: $I=23.0940_A$.

RLC Current Delay (2, 11)

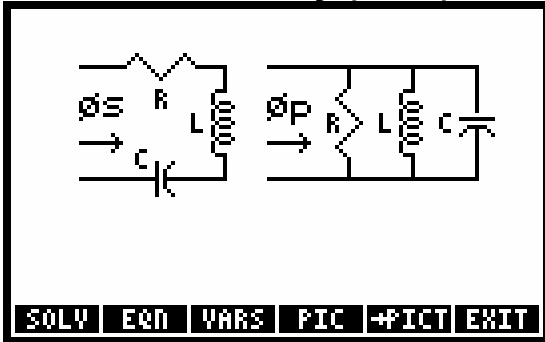

The phase delay (angle) is positive for current lagging voltage.

Equations:

$$\text{TAN}(\phi_s) = \frac{X_L - X_C}{R} \quad \text{TAN}(\phi_p) = \frac{\frac{1}{X_C} - \frac{1}{X_L}}{\frac{1}{R}}$$

$$X_C = \frac{1}{\omega \cdot C} \quad X_L = \omega \cdot L \quad \omega = 2 \cdot \pi \cdot f$$

Example:

Given: $f=1107_Hz$, $C=80_μf$, $L=20_mH$, $R=5_Ω$.

Solution: $\omega=672.3008_r/s$, $\phi_s=-45.8292_°$, $\phi_p=-5.8772_°$, $X_C=18.5929_Ω$, $X_L=13.4460_Ω$.

DC Capacitor Current (2, 12)

These equations approximate the dc current required to charge the voltage on a capacitor in a certain time interval.

Equations:

$$I = C \cdot \left(\frac{\Delta V}{\Delta t} \right) \quad \Delta V = -V_f - V_i \quad \Delta t = t_f \cdot t_i$$

Example:

Given: $C=15_μf$, $V_i=2.3_V$, $V_f=3.2_V$, $I=10_A$, $t_i=0_s$.

Solution: $\Delta V=0.9000_V$, $\Delta t=1.3500_μs$, $t_f=1.3500_μs$.

Capacitor Charge (2, 13)

Equation:

$$q = C \cdot V$$

Example:

Given: $C=20_μF$, $V=100_V$.

Solution: $q=0.0020_C$.

DC Inductor Voltage (2, 14)

These equations approximate the dc voltage induced in an inductor by a change in current in a certain time interval.

Equations:

$$V = -V \cdot \left(\frac{\Delta I}{\Delta t}\right) \quad \Delta V = -I_f - I_i \quad \Delta t = t_f - t_i$$

Example:

Given: $L=100\text{_mH}$, $V=52\text{_V}$, $\Delta t=32\text{_\mu s}$, $I_i=23\text{_A}$, $t_i=0\text{_s}$.

Solution: $\Delta I = -0.0166\text{_A}$, $I_f=22.9834\text{_A}$, $t_f=32\text{_\mu s}$.

RC Transient (2, 15)

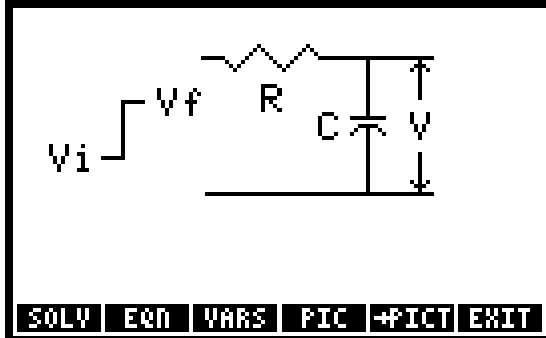

Equation:

$$V = V_f - (V_f - V_i) \cdot e^{-\frac{t}{R \cdot C}}$$

Example:

Given: $V_i=0\text{_V}$, $C=50\text{_\mu F}$, $V_f=10\text{_V}$, $R=100\text{_\omega}$, $t=2\text{_ms}$.

Solution: $V=3.2968\text{_V}$.

RL Transient (2, 16)

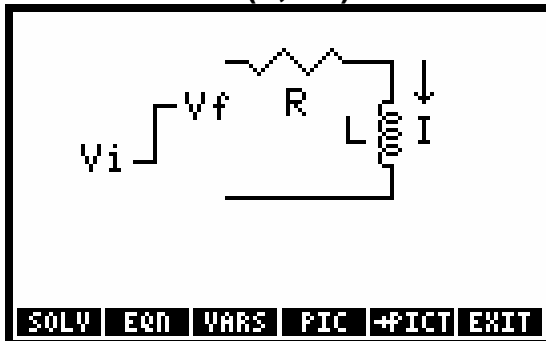

Equation:

$$I = \frac{1}{R} \cdot \left(V_f - (V_f - V_i) \cdot e^{-\frac{t \cdot R}{L}} \right)$$

Example:

Given: $V_i=0\text{_V}$, $V_f=5\text{_V}$, $R=50\text{_\omega}$, $L=50\text{_mH}$, $t=75\text{_\mu s}$.

Solution: $I=0.0072\text{_A}$.

Resonant Frequency (2, 17)

Equation:

$$\omega_0 = \frac{1}{\sqrt{L \cdot C}} \quad Q_s = \frac{1}{R} \cdot \sqrt{\frac{C}{L}} \quad Q_p = R \cdot \sqrt{\frac{C}{L}} \quad \omega_0 = 2 \cdot \pi \cdot f_0$$

Example:

Given: $L=500_mH$, $C=8_μF$, $R=10_Ω$.

Solution: $\omega_0=500_r/s$, $Q_s=25.0000$, $Q_p=0.0400$, $f_0=79.5775_Hz$.

Plate Capacitor (2, 18)

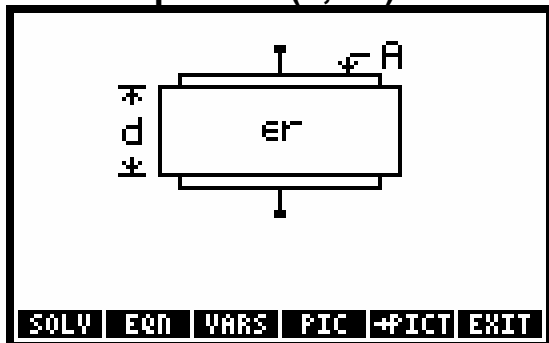

Equation:

$$C = \frac{\epsilon_0 \cdot \epsilon_r \cdot A}{d}$$

Example:

Given: $C=25_μF$, $\epsilon_r=2.26$, $A=1_cm^2$.

Solution: $d=8.0042E-9_cm$.

Cylindrical Capacitor (2,19)

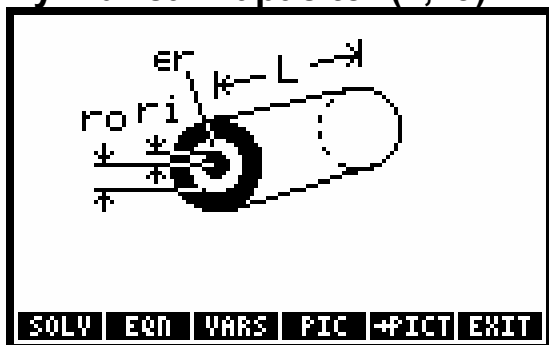

Equation:

$$C = \frac{2 \cdot \pi \cdot \epsilon_0 \cdot \epsilon_r \cdot L}{\ln\left(\frac{r_0}{r_1}\right)}$$

Example:

Given: $\epsilon_r=1$, $r_o=1_cm$, $r_i=.999_cm$, $L=10_cm$.

Solution: $C=0.0056_μF$.

Solenoid Inductance (2, 20)

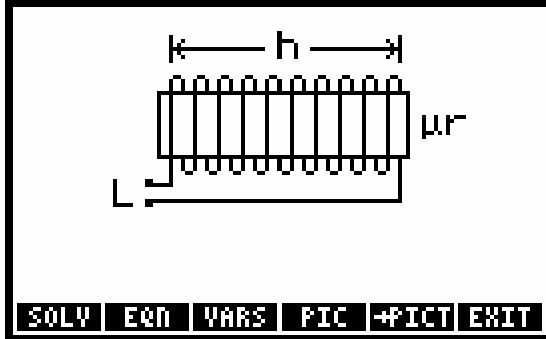

Equation:

$$L = \mu_0 \cdot \mu_r \cdot n^2 \cdot A \cdot h$$

Example:

Given: $\mu_r=2.5$, $n=40_1/cm$, $A=.2_cm^2$, $h=3_cm$.

Solution: $L=0.0302_mH$.

Toroid Inductance (2, 21)

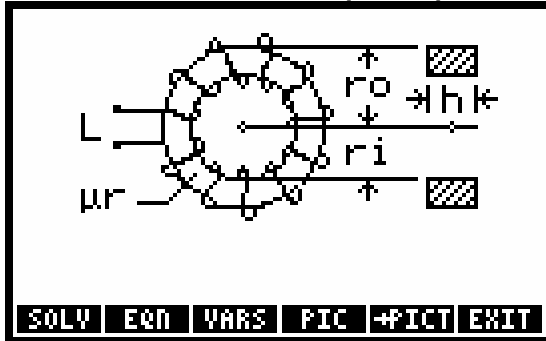

Equation:

$$L = \frac{\mu_0 \cdot \mu_r \cdot N^2 \cdot h}{2 \cdot \pi} \cdot \ln\left(\frac{r_o}{r_i}\right)$$

Example:

Given: $\mu_r=1$, $N=5000$, $h=2_cm$, $r_i=.2_cm$, $r_o=4_cm$.

Solution: $L=69.3147_mH$.

Sinusoidal Voltage (2, 22)

Equations:

$$V = V_{\max} \cdot \text{SIN}(\omega \cdot t + \phi) \quad \omega = 2 \cdot \pi \cdot f$$

Example:

Given: $V_{\max}=110_V$, $t=30_{\mu s}$, $f=60_{\text{Hz}}$, $\phi=15_{\circ}$.

Solution: $\omega=376.9911_{\text{r/s}}$, $V=29.6699_V$.

Sinusoidal Current (2, 23)

Equations:

$$I = I_{\max} \cdot \text{SIN}(\omega \cdot t + \phi) \quad \omega = 2 \cdot \pi \cdot f$$

Example:

Given: $t=32_s$, $I_{\max}=10_A$, $\omega=636_{\text{r/s}}$, $\phi=30_{\circ}$.

Solution: $I=9.5983_A$, $f=101.2225_{\text{Hz}}$.

Fluids (3)

| Variable | Description |
|------------|---|
| ϵ | Roughness |
| μ | Dynamic viscosity |
| ρ | Density |
| ΔP | Pressure change |
| Δy | Height change |
| ΣK | Total fitting coefficients |
| A | Cross-sectional area |
| $A1, A2$ | Initial and final cross-sectional areas |
| D | Diameter |
| $D1, D2$ | Initial and final diameters |
| h | Depth relative to $P0$ reference depth |
| hL | Head loss |
| L | Length |
| M | Mass flow rate |
| n | Kinematic viscosity |
| P | Pressure at h |
| $P0$ | Reference pressure |
| $P1, P2$ | Initial and final pressures |

| Variable | Description |
|-----------|------------------------------|
| Q | Volume flow rate |
| Re | Reynolds number |
| $v1, v2$ | Initial and final velocities |
| v_{avg} | Average velocity |
| W | Power input |
| $y1, y2$ | Initial and final heights |

References: 3,6,9.

Pressure at Depth (3, 1)

This equation describes hydrostatic pressure for an incompressible fluid. Depth h is positive downwards from the reference.

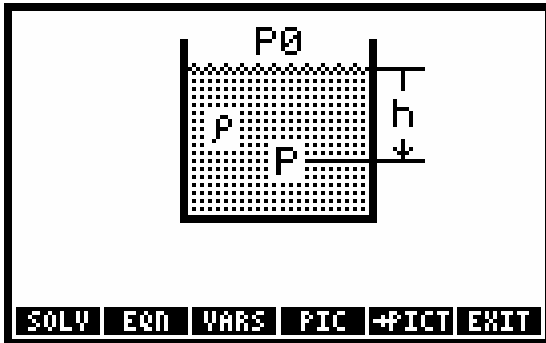

Equation:

$$P = P_0 + \rho \cdot g \cdot h$$

Example:

Given: $h=100_m$, $\rho=1025.1817_kg/m^3$, $P_0=1_atm$.

Solution: $P=1106.6848_kPa$.

Bernoulli Equation (3, 2)

These equations represent the streamlined flow of an incompressible fluid.

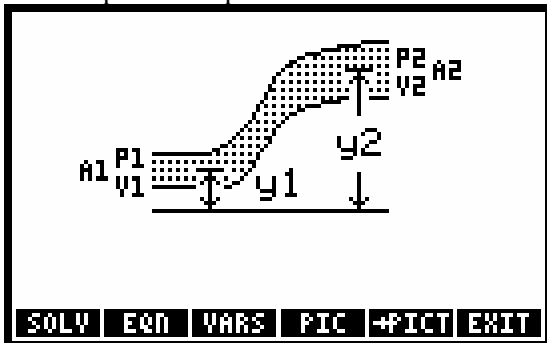

Equations:

$$\frac{\Delta P}{\rho} + \frac{v_2^2 - v_1^2}{2} + g \cdot \Delta y = 0$$

$$\frac{\Delta P}{\rho} + \frac{v_2^2 \cdot \left(1 - \left(\frac{A_2}{A_1}\right)^2\right)}{2} + g \cdot \Delta y = 0$$

$$\frac{\Delta P}{\rho} + \frac{v_1^2 \cdot \left(\left(\frac{A_2}{A_1}\right)^2 - 1\right)}{2} + g \cdot \Delta y = 0$$

$$\Delta P = P_2 - P_1 \quad \Delta y = y_2 - y_1 \quad M = \rho \cdot Q$$

$$Q = A_2 \cdot v_2 \quad Q = A_1 \cdot v_1$$

$$A_1 = \frac{\pi \cdot D_1^2}{4} \quad A_2 = \frac{\pi \cdot D_2^2}{4}$$

Example:

Given: $P_2=25$ _psi, $P_1=75$ _psi, $y_2=35$ _ft, $y_1=0$ _ft, $D_1=18$ _in, $\rho=64$ _lb/ft³, $v_1=100$ _ft/s.

Solution: $Q=10602.8752$ _ft³/min, $M=678584.0132$ _lb/min, $v_2=122.4213$ _ft/s, $A_2=207.8633$ _in², $D_2=16.2684$ _in, $A_1=254.4690$ _in², $\Delta P= -50$ _psi, $\Delta y=35$ _ft.

Flow with Losses (3, 3)

These equations extend Bernoulli's equation to include power input (or output) and head loss.

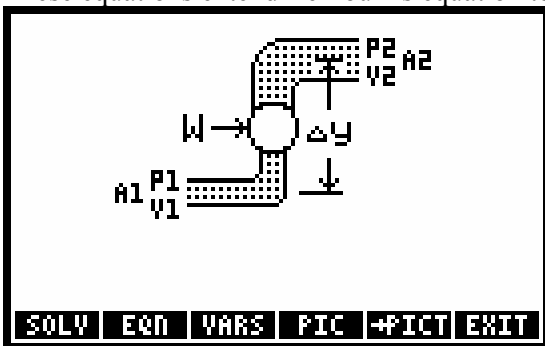

Equations:

$$M \cdot \left(\frac{\Delta P}{\rho} + \frac{v_2^2 - v_1^2}{2} + g \cdot \Delta y + hL \right) = W$$

$$M \cdot \left(\frac{\Delta P}{\rho} + \frac{v_2^2 \cdot \left(1 - \left(\frac{A_2}{A_1}\right)^2\right)}{2} + g \cdot \Delta y + hL \right) = W$$

$$M \cdot \left(\frac{\Delta P}{\rho} + \frac{v_1^2 \cdot \left(\left(\frac{A_1}{A_2}\right)^2 - 1\right)}{2} + g \cdot \Delta y + hL \right) = W$$

$$\Delta P = P_2 - P_1 \quad \Delta y = y_2 - y_1 \quad M = \rho \cdot Q$$

$$Q = A_2 \cdot v_2 \quad Q = A_1 \cdot v_1$$

$$A_1 = \frac{\pi \cdot D_1^2}{4} \quad A_2 = \frac{\pi \cdot D_2^2}{4}$$

Example:

Given: $P_2=30_psi$, $P_1=65_psi$, $y_2=100_ft$, $y_1=0_ft$, $\rho=64_lb/ft^3$, $D1=24_in$, $hL=2.0_ft^2/s^2$, $W=25_hp$, $v1=100_ft/s$.

Solution: $Q=18849.5559_ft^3/min$, $M=1206371.5790_lb/min$, $\Delta P=-35_psi$, $\Delta y=100_ft$, $v_2=93.1269_ft/s$, $A1=452.3893_in^2$, $A2=485.7773_in^2$, $D2=24.8699_in$.

Flow in Full Pipes (3, 4)

These equations adapt Bernoulli's equation for flow in a round, full pipe, including power input (or output) and frictional losses. (See "FANNING" in Chapter 3.)

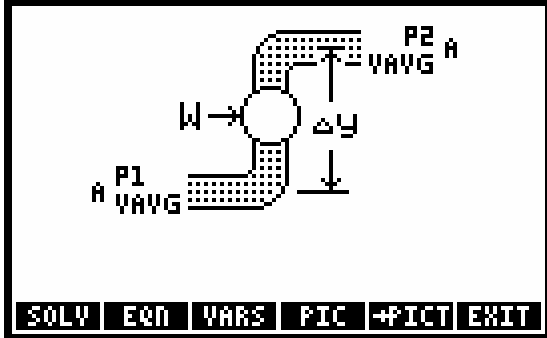

Equations:

$$\rho \cdot \left(\frac{\pi \cdot D^2}{4}\right) \cdot v_{avg} \cdot \left(\frac{\Delta P}{\rho} + g \cdot \Delta y + v_{avg}^2 \cdot \left(2 \cdot f \cdot \left(\frac{L}{D}\right) + \frac{\Sigma K}{2}\right)\right) = W$$

$$\Delta P = P_2 - P_1 \quad \Delta y = y_2 - y_1 \quad M = \rho \cdot Q$$

$$Q = A \cdot v_{avg} \quad A = \frac{\pi \cdot D^2}{4} \quad Re = \frac{D \cdot v_{avg} \cdot \rho}{\mu} \quad n = \frac{\mu}{\rho}$$

Example:

Given: $\rho=62.4_lb/ft^3$, $D=12_in$, $v_{avg}=8_ft/s$, $P_2=15_psi$, $P_1=20_psi$, $y_2=40_ft$, $y_1=0_ft$, $\mu=0.00002_lbf*s/ft^2$, $\Sigma K=2.25$, $\epsilon=0.02_in$, $L=250_ft$.

Solution: $\Delta P=-5_psi$, $\Delta y=40_ft$, $A=113.0973_in^2$, $n=1.0312_ft^2/s$, $Q=376.9911_ft^3/min$, $M=23524.2358_lb/min$, $W=25.8897_hp$, $Re=775780.5$.

Forces and Energy (4)

| Variable | Description |
|----------------------|--------------------------------------|
| α | Angular acceleration |
| ω | Angular acceleration |
| ω_i, ω_f | Initial and final angular velocities |
| ρ | Fluid density |
| τ | Torque |
| Θ | Angular displacement |
| α | Acceleration |

| Variable | Description |
|----------------|---|
| A | Projected area relative to flow |
| ar | Centripetal acceleration at r |
| at | Tangential acceleration at r |
| Cd | Drag coefficient |
| E | Energy |
| F | Force at r or x , or Spring force (Hooke's Law), or attractive force (Law of Gravitation), or Drag force (Drag force) |
| I | Moment of inertia |
| k | Spring constant |
| Ki, Kf | Initial and final kinetic energies |
| $m, m1, m2$ | Mass |
| N | Rotational speed |
| Ni, Nf | Initial and final rotational speeds |
| P | Instantaneous power |
| $Pavg$ | Average power |
| r | Radius from rotation axis, or Separation distance (Law of Gravitation) |
| t | Time |
| v | Velocity |
| $vf, v1f, v2f$ | Final velocity |
| $vi, v1i$ | Initial velocity |
| W | Work |
| x | Displacement |

Reference: 3.

Linear Mechanics (4, 1)

Equations:

$$F = m \cdot a \quad Ki = \frac{1}{2} \cdot m \cdot vi^2 \quad Kf = \frac{1}{2} \cdot m \cdot vf^2 \quad W = F \cdot x$$

$$W = Kf - Ki \quad P = F \cdot v \quad Pavg = \frac{W}{t} \quad vf = vi + a \cdot t$$

Example:

Given: $t=10_s$, $m=50_{lb}$, $a=12.5_{ft/s^2}$, $vi=0_{ft/s}$.

Solution: $vf=125_{ft/s}$, $x=625_{ft}$, $F=19.4256_{lbf}$, $Ki=0_{ft \cdot lbf}$, $Kf=12140.9961_{ft \cdot lbf}$, $W=12140.9961_{ft \cdot lbf}$, $Pavg=2.2075_{hp}$.

Angular Mechanics (4, 2)

Equations:

$$\tau = I \cdot \alpha \quad K_i = \frac{1}{2} \cdot I \cdot \omega_i^2 \quad K_f = \frac{1}{2} \cdot I \cdot \omega_f^2 \quad W = r \cdot \Theta$$

$$W = K_f - K_i \quad P = \tau \cdot \omega \quad P_{avg} = \frac{W}{t} \quad \omega_f = \omega_i + \alpha \cdot t$$

$$a_t = \alpha \cdot r \quad \omega = 2 \cdot \pi \cdot N \quad \omega_i = 2 \cdot \pi \cdot N_i \quad \omega_f = 2 \cdot \pi \cdot N_f$$

Example:

Given: $I=1750_lb \cdot in^2$, $\Theta=360_^\circ$, $r=3.5_in$, $\alpha=10.5_r/min^2$, $\omega_i=0_r/s$.

Solution: $r=1.1017E-3_ft$, $K_i=0_ft \cdot lbf$, $W=6.9221E-3_ft \cdot lbf$, $K_f=6.9221E-3_ft \cdot lbf$,

$a_t=8.5069E-4_ft/s^2$, $N_i=0_rpm$, $\omega_f=11.4868_r/min$, $t=1.0940_min$, $N_f=1.8282_rpm$, $P_{avg}=1.9174E-7_hp$.

Centripetal Force (4, 3)

Equations:

$$F = m \cdot \omega^2 \cdot r \quad \omega = \frac{v}{r} \quad a_r = \frac{v^2}{r} \quad \omega = 2 \cdot \pi \cdot N$$

Example:

Given: $m=1_kg$, $r=5_cm$, $N=2000_Hz$.

Solution: $\omega=12566.3706_r/s$, $a_r=7895683.5209_m/s^2$, $F=7895683.5209_N$, $v=628.3185_m/s$.

Hooke's Law (4, 4)

The force is that exerted by the spring.

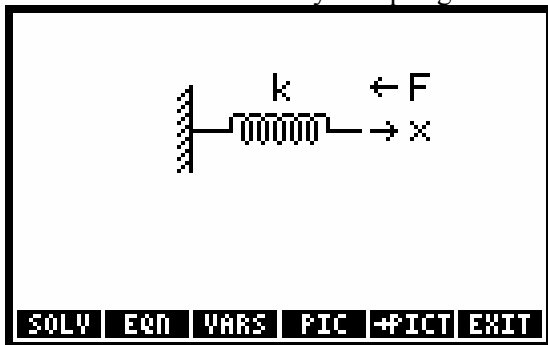

Equations:

$$F = -k \cdot x \quad W = \frac{-1}{2} \cdot k \cdot x^2$$

Example:

Given: $k=1725_lbf/in$, $x=125_in$.

Solution: $F=-2156.25_lbf$, $W=-112.3047_ft \cdot lbf$.

1D Elastic Collisions (4, 5)

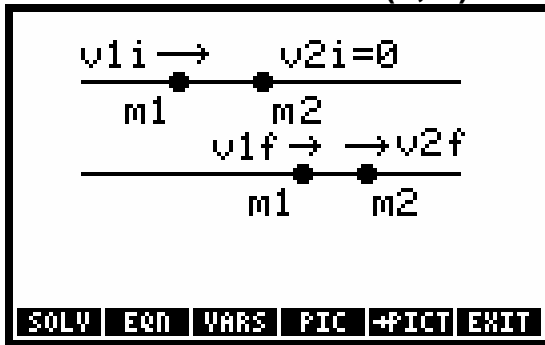

Equations:

$$v_{1f} = \frac{m_1 - m_2}{m_1 + m_2} \cdot v_{1i} \quad v_{2f} = \frac{2 \cdot m_1}{m_1 + m_2} \cdot v_{1i}$$

Example:

Given: $m_1=10_kg$, $m_2=25_kg$, $v_{1i}=100_m/s$.

Solution: $v_{1f}=-42.8571_m/s$, $v_{2f}=57.1429_m/s$.

Drag Force (4, 6)

Equation:

$$F = C_d \cdot \left(\frac{\rho \cdot v^2}{2} \right) \cdot A$$

Example:

Given: $C_d=.05$, $\rho=1000_kg/m^3$, $A=7.5E6_cm^2$, $v=35_m/s$.

Solution: $F=22968750_N$.

Law of Gravitation (4, 7)

Equation:

$$F = G \cdot \left(\frac{m_1 \cdot m_2}{r^2} \right)$$

Example:

Given: $m_1=2E15_kg$, $m_2=2E18_kg$, $r=1000000_km$.

Solution: $F=266903.6_N$.

Mass-Energy Relation (4, 8)

Equation:

$$E = m \cdot c^2$$

Example:

Given: $m=9.1E-31_kg$.

Solution: $E=8.1787E-14_J$.

Gases (5)

| Variable | Description |
|------------|---|
| λ | Mean free path |
| ρ | Flow density |
| ρ_0 | Stagnation density |
| A | Flow area |
| A_t | Throat area |
| d | Molecular diameter |
| k | Specific heat ratio |
| M | Mach number |
| m | Mass |
| MW | Molecular weight |
| n | Number of moles, or Polytropic constant (Polytropic Processes) |
| P | Pressure, or Flow pressure (Isentropic Flow) |
| P_0 | Stagnation pressure |
| P_c | Pseudocritical pressure |
| P_i, P_f | Initial and final pressures |
| T | Temperature, or Flow temperature (Isentropic Flow) |
| T_0 | Stagnation temperature |
| T_c | Pseudocritical temperature |
| T_i, T_f | Initial and final temperature |
| V | Volume |
| V_i, V_f | Initial and final volumes |
| v_{rms} | Root-mean-square (rms) velocity |
| W | Work |

References:1, 3.

Ideal Gas Law (5, 1)

Equations:

$$P \cdot V = n \cdot R \cdot T \quad m = n \cdot MW$$

Example:**Given:** $T=16.85\text{ }^\circ\text{C}$, $P=1\text{ atm}$, $V=25\text{ l}$, $MW=36\text{ g/gmol}$.**Solution:** $n=1.0506\text{ gmol}$, $m=3.7820\text{E-2 kg}$.**Ideal Gas State Change (5, 2)****Equation:**

$$\frac{P_f \cdot V_f}{T_f} = \frac{P_i \cdot V_i}{T_i}$$

Example:**Given:** $P_i=1.5\text{ kPa}$, $P_f=1.5\text{ kPa}$, $V_i=2\text{ l}$, $T_i=100\text{ }^\circ\text{C}$, $T_f=373.15\text{ K}$.**Solution:** $V_f=2\text{ l}$.**Isothermal Expansion (5, 3)**

These equations apply to an ideal gas.

Equations:

$$W = n \cdot R \cdot T \cdot \ln\left(\frac{V_f}{V_i}\right) \quad m = n \cdot MW$$

Example:**Given:** $V_i=2\text{ l}$, $V_f=125\text{ l}$, $T=300\text{ }^\circ\text{C}$, $n=0.25\text{ gmol}$, $MW=64\text{ g/gmol}$.**Solution:** $W=4926.4942\text{ J}$, $M=0.016\text{ kg}$.**Polytropic Processes (5, 4)**

These equations describe a reversible pressure-volume change of an ideal gas such that $P \cdot V^n$ is constant. Special cases include isothermal processes ($n=1$), isentropic processes ($n=k$, the specific heat ratio), and constant-pressure processes ($n=0$).

Equations:

$$\frac{P_f}{P_i} = \left(\frac{V_f}{V_i}\right)^{-n} \quad \frac{T_f}{T_i} = \left(\frac{P_f}{P_i}\right)^{\frac{n-1}{n}}$$

Example:**Given:** $P_i=15\text{ psi}$, $P_f=35\text{ psi}$, $V_i=1\text{ ft}^3$, $V_f=0.50\text{ ft}^3$, $T_i=75\text{ }^\circ\text{F}$.**Solution:** $n=1.2224$, $T_f=164.1117\text{ }^\circ\text{F}$.**Isentropic Flow (5, 5)**

The calculation differs at velocities below and above Mach 1. The Mach number is based on the speed of sound in the compressible fluid.

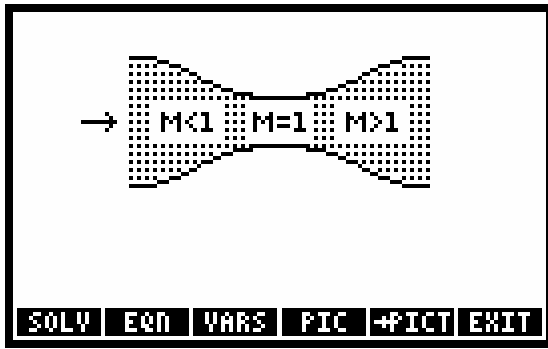

Equations:

$$\frac{T}{T_0} = \frac{2}{2 + (k-1) \cdot M^2} \quad \frac{P}{P_0} = \left(\frac{T}{T_0}\right)^{\frac{k}{k-1}}$$

$$\frac{\rho}{\rho_0} = \left(\frac{T}{T_0}\right)^{\frac{1}{k-1}}$$

$$\frac{A}{A_t} = \frac{1}{M} \cdot \left(\frac{2}{k+1} \cdot \left(1 + \frac{k-1}{2} \cdot M^2\right)\right)^{\frac{k+1}{2 \cdot (k-1)}}$$

Example:

Given: $k=2, M=.9, T_0=26.85\text{ }^\circ\text{C}, T=373.15\text{ }_K, \rho_0=100\text{ }_kg/m^3, P_0=100\text{ }_kPa, A=1\text{ }_cm^2$.

Solution: $P=464.1152\text{ }_kPa, A_t=0.9928\text{ }_cm^2, \rho=215.4333\text{ }_kg/m^3$.

Real Gas Law (5, 6)

These equations adapt the ideal gas law to emulate real-gas behavior. (See “ZFACTOR” in Chapter 3.)

Equations:

$$P \cdot V = n \cdot Z \cdot R \cdot T \quad m = n \cdot MW$$

Example:

Given: $P_c=48\text{ }_atm, T_c=298\text{ }_K, P=5\text{ }_kPa, V=10\text{ }_l, MW=64\text{ }_g/gmol, T=75\text{ }_^\circ\text{C}$.

Solution: $n=0.0173\text{ }_gmol, m=1.1057E-3\text{ }_kg$.

Real Gas State Change (5, 7)

This equation adapts the ideal gas state-change equation to emulate real-gas behavior. (See “ZFACTOR” in Chapter 3.)

Equation:

$$\frac{P_f \cdot V_f}{Z_f \cdot T_f} = \frac{P_i \cdot V_i}{Z_i \cdot T_i}$$

Example:

Given: $P_c=48\text{ }_atm, P_i=100\text{ }_kPa, P_f=50\text{ }_kPa, T_i=75\text{ }_^\circ\text{C}, T_c=298\text{ }_K, V_i=10\text{ }_l, T_f=250\text{ }_^\circ\text{C}$.

(Remember Z_f and Z_i are automatically calculated using these variables)

Solution: $V_f=30.1703\text{ }_l$.

Kinetic Theory (5, 8)

These equations describe properties of an ideal gas.

Equations:

$$P = \frac{n \cdot MW \cdot v_{rms}^2}{3 \cdot V} \quad v_{rms} = \sqrt{\frac{3 \cdot R \cdot T}{MW}}$$

$$\lambda = \frac{1}{\sqrt{2} \cdot \pi \cdot \left(\frac{n \cdot NA}{V}\right) \cdot d^2} \quad m = n \cdot MW$$

Example:

Given: $P=100_kPa$, $V=2_l$, $T=26.85_^{\circ}C$, $MW=18_g/gmol$, $d=2.5_nm$.

Solution: $v_{rms}=644.7678_m/s$, $m=1.4433E-3_kg$, $n=0.0802_gmol$, $\lambda=1.4916_nm$.

Heat Transfer (6)

| Variable | Description |
|------------------------|--|
| α | Expansion coefficient |
| δ | Elongation |
| $\lambda 1, \lambda 2$ | Lower and upper wavelength limits |
| λ_{max} | Wavelength of maximum emissive power |
| ΔT | Temperature difference |
| A | Area |
| c | Specific heat |
| eb_{12} | Emissive power in the range $\lambda 1$ to $\lambda 2$ |
| eb | Total emissive power |
| f | Fraction of emissive power in the range $\lambda 1$ to $\lambda 2$ |
| $h, h1, h3$ | Convective heat-transfer coefficient |
| $k, k1, k2, k3$ | Thermal conductivity |
| $L, L1, L2, L3$ | Length |
| m | Mass |
| Q | Heat capacity |
| q | Heat transfer rate |
| T | Temperature |
| T_c | Cold surface temperature (Conduction), or Cold fluid temperature |
| T_h | Hot surface temperature, or Hot fluid temperature (Conduction + Convection) |
| T_i, T_f | Initial and final temperature |
| U | Overall heat transfer coefficient |

References: 7, 9.

Heat Capacity (6, 1)

Equations:

$$Q = m \cdot c \cdot \Delta T \qquad Q = m \cdot c \cdot (T_f - T_i)$$

Example:

Given: $\Delta T=15\text{ }^\circ\text{C}$, $T_i=0\text{ }^\circ\text{C}$, $m=10\text{ kg}$, $Q=25\text{ kJ}$.

Solution: $T_f=15\text{ }^\circ\text{C}$, $c=.1667\text{ kJ}/(\text{kg}\cdot\text{K})$

Thermal Expansion (6, 2)

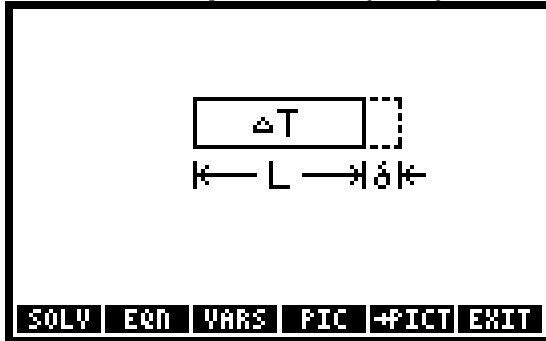

Equations:

$$\delta = \alpha \cdot L \cdot \Delta T \qquad \delta = \alpha \cdot L \cdot (T_f - T_i)$$

Example:

Given: $\Delta T=15\text{ }^\circ\text{C}$, $L=10\text{ m}$, $T_f=25\text{ }^\circ\text{C}$, $\delta=1\text{ cm}$.

Solution: $T_i=10\text{ }^\circ\text{C}$, $\alpha=6.6667\text{E-}5\text{ }1/^\circ\text{C}$.

Conduction (6, 3)

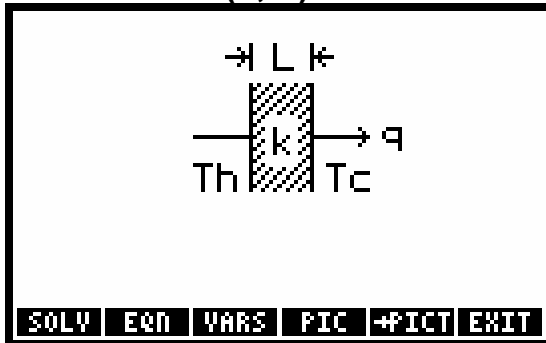

Equations:

$$q = \frac{k \cdot A}{L} \cdot \Delta T \qquad q = \frac{k \cdot A}{L} \cdot (T_h - T_c)$$

Example:

Given: $T_c=25\text{ }^\circ\text{C}$, $T_h=75\text{ }^\circ\text{C}$, $A=12.5\text{ m}^2$, $L=1.5\text{ cm}$, $k=0.12\text{ W}/(\text{m}\cdot\text{K})$

Solution: $q=5000\text{ W}$, $\Delta T= 50\text{ }^\circ\text{C}$.

Convection (6, 4)

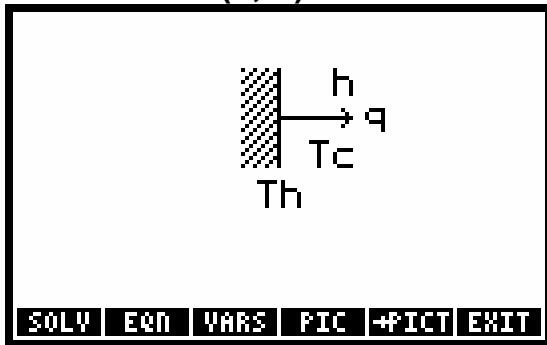

Equations:

$$q = h \cdot A \cdot \Delta T \quad q = h \cdot A \cdot (Th - Tc)$$

Example:

Given: $Tc=300_K$, $A=200_m^2$, $h=0.005_W/(m^2 \cdot K)$, $q=10_W$.

Solution: $\Delta T=10_^\circ C$, $Th=36.8500_^\circ C$.

Conduction + Convection (6, 5)

If you have fewer than three layers, give the extra layers a zero thickness and any nonzero conductivity. The two temperatures are fluid temperatures—if instead you know a *surface* temperature, set the corresponding convective coefficient to 10^{499} .

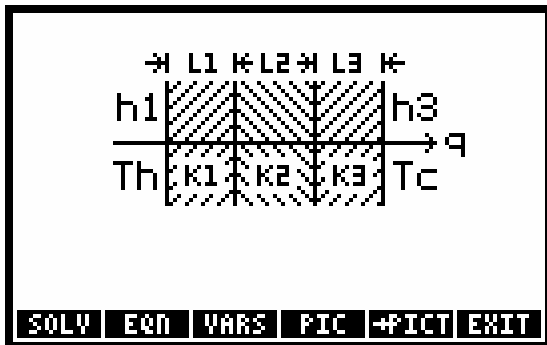

Equations:

$$q = \frac{A \cdot \Delta T}{\frac{1}{h1} + \frac{L1}{k1} + \frac{L2}{k2} + \frac{L3}{k3} + \frac{1}{h3}} \quad q = \frac{A \cdot (Th - Tc)}{\frac{1}{h1} + \frac{L1}{k1} + \frac{L2}{k2} + \frac{L3}{k3} + \frac{1}{h3}}$$

$$U = \frac{q}{A \cdot \Delta T} \quad U = \frac{q}{A \cdot (Th - Tc)}$$

Example:

Given: $\Delta T=35_^\circ C$, $Th=55_^\circ C$, $A=10_m^2$, $h1=0.05_W/(m^2 \cdot K)$, $h3=0.05_W/(m^2 \cdot K)$, $L1=3_cm$, $L2=5_cm$, $L3=3_cm$, $k1=0.1_W/(m \cdot K)$, $k2=.5_W/(m \cdot K)$, $k3=0.1_W/(m \cdot K)$.

Solution: $Tc=20_^\circ C$, $U=0.0246_W/(m^2 \cdot K)$, $q=8.5995_W$.

Black Body Radiation (6, 6)

(See "F0λ" in Chapter 3.)

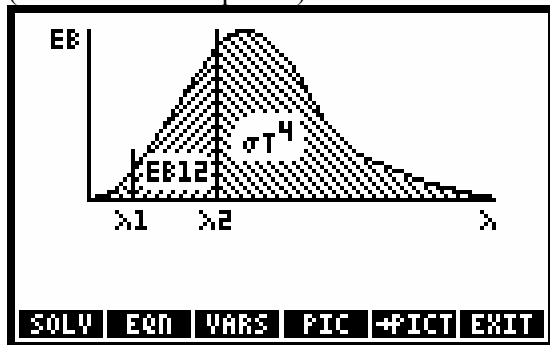

Equations:

$$eb = \sigma \cdot T^4 \quad f = F0\lambda(\lambda_2;T) - F0\lambda(\lambda_1;T)$$

$$eB12=f \cdot eb \quad \lambda_{max} \cdot T = c3 \quad q = eb \cdot A$$

Example:

Given: $T=1000\text{ }^\circ\text{C}$, $\lambda_1=1000\text{ nm}$, $\lambda_2=600\text{ nm}$, $A=1\text{ cm}^2$.

Solution: $\lambda_{max}=2276.0523\text{ nm}$, $eb=148984.2703\text{ W/m}^2$, $f=.0036$, $eB12=537.7264\text{ W/m}^2$, $q=14.8984\text{ W}$.

Magnetism (7)

| Variable | Description |
|---------------|------------------------------------|
| μ_r | Relative permeability |
| B | Magnetic field |
| d | Separation distance |
| Fba | Force |
| I, I_a, I_b | Current |
| L | Length |
| N | Total number of turns |
| n | Number of turns per unit length |
| r | Distance from center of wire |
| r_i, r_o | Inside and outside radii of toroid |
| r_w | Radius of wire |

Reference: 3.

Straight Wire (7, 1)

The magnetic field calculation differs depending upon whether the point is inside or outside the wire.

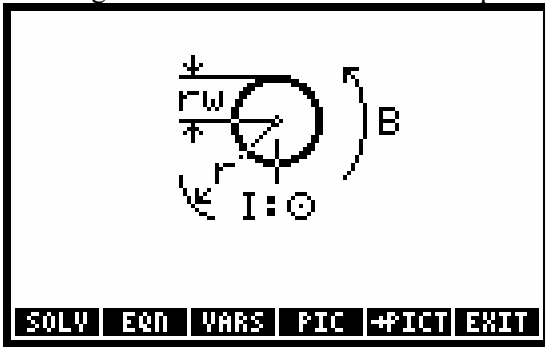

Equation:

$$B = \frac{\mu_0 \cdot \mu_r \cdot I}{2 \cdot \pi \cdot r}$$

Example:

Given: $\mu_r=1$, $r_w=0.25_cm$, $r=0.2_cm$, $I=25_A$.

Solution: $B=0.0016_T$.

Force between Wires (7, 2)

The force between wires is positive for an attractive force (for currents having the same sign).

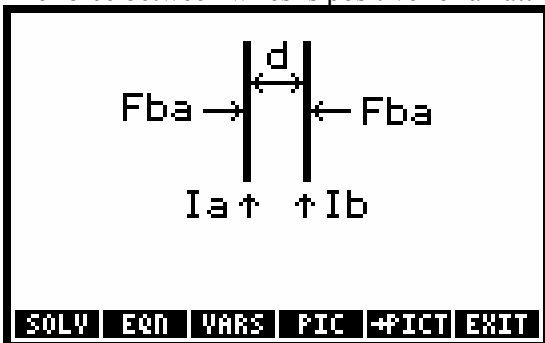

Equation:

$$F_{ba} = \frac{\mu_0 \cdot \mu_r \cdot L \cdot I_b \cdot I_a}{2 \cdot \pi \cdot d}$$

Example:

Given: $I_a=10_A$, $I_b=20_A$, $\mu_r=1$, $L=50_cm$, $d=1_cm$.

Solution: $F_{ba}=2.0000E-3_N$.

Magnetic (B) Field in Solenoid (7, 3)

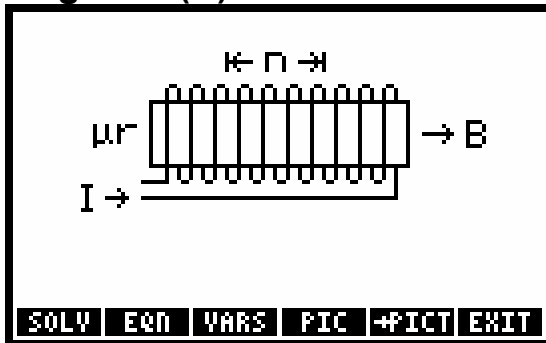

Equation:

$$B = \mu_0 \cdot \mu_r \cdot I \cdot n$$

Example:

Given: $\mu_r=10$, $n=50$, $I=1.25_A$.

Solution: $B=0.0785_T$.

Magnetic (B) Field in Toroid (7, 4)

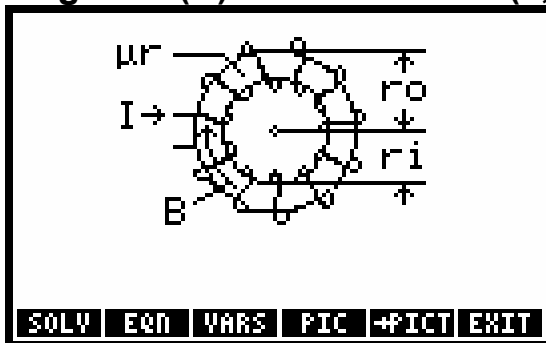

Equation:

$$B = \frac{\mu_0 \cdot \mu_r \cdot I \cdot N}{2 \cdot \pi} \cdot \left(\frac{2}{r_o + r_i} \right)$$

Example:

Given: $\mu_r=10$, $N=50$, $r_i=5_cm$, $r_o=7_cm$, $I=10_A$.

Solution: $B=1.6667E-2_T$.

Motion (8)

| Variable | Description |
|------------|---|
| α | Angular acceleration |
| ω | Angular velocity (Circular Motion), or Angular velocity at t (Angular Motion) |
| ω_0 | Initial angular velocity |
| ρ | Fluid density |
| θ | Angular position at t |
| θ_0 | Initial angular position (Angular Motion), or Initial vertical angle (Projectile Motion) |
| a | Acceleration |
| A | Projected horizontal area |
| ar | Centripetal acceleration at r |
| Cd | Drag coefficient |
| m | Mass |
| M | Planet mass |
| N | Rotational speed |
| R | Horizontal range (Projectile Motion), or Planet radius (Escape Velocity) |
| r | Radius |
| t | Time |
| v | Velocity at t (linear Motion), or Tangential velocity at r (Circular Motion), or Terminal velocity (Terminal Velocity), or Escape velocity (Escape Velocity) |
| v_0 | Initial velocity |
| v_x | Horizontal component of velocity at t |
| v_y | Vertical component of velocity at t |
| x | Horizontal position at t |
| x_0 | Initial horizontal position |
| y | Vertical position at t |
| y_0 | Initial vertical position |

Reference: 3.

Linear Motion (8, 1)

Equations:

$$x = x_0 + v_0 \cdot t + \frac{1}{2} \cdot a \cdot t^2 \quad x = x_0 + v \cdot t + \frac{1}{2} \cdot a \cdot t^2$$

$$x = x_0 + \frac{1}{2} \cdot (v_0 + v) \cdot t \quad v = v_0 + a \cdot t$$

Example:

Given: $x_0=0_m$, $x=100_m$, $t=10_s$, $v_0=1_m/s$

Solution: $v=19_m/s$, $a=1.8_m/s^2$.

Object in Free Fall (8, 2)

Equations:

$$y = y_0 + v_0 \cdot t + \frac{1}{2} \cdot g \cdot t^2 \quad y = y_0 + v \cdot t + \frac{1}{2} \cdot g \cdot t^2$$

$$v^2 = v_0^2 + 2 \cdot g \cdot (y + y_0) \quad v = v_0 + g \cdot t$$

Example:

Given: $y_0=1000_ft$, $y=0_ft$, $v_0=0_ft/s$

Solution: $t=7.8843_s$, $v=-253.6991_ft/s$.

Projectile Motion (8, 3)

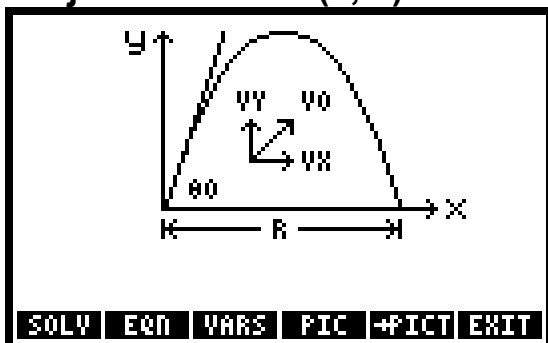

Equations:

$$x = x_0 + v_0 \cdot \cos(\theta_0) \cdot t \quad y = y_0 + v_0 \cdot \sin(\theta_0) \cdot t - \frac{1}{2} \cdot g \cdot t^2$$

$$v_x = v_0 \cdot \cos(\theta_0) \quad v_y = v_0 \cdot \sin(\theta_0) - g \cdot t$$

$$R = \frac{v_0^2}{g} \cdot \sin(2 \cdot \theta_0)$$

Example:

Given: $x_0=0_ft$, $y_0=0_ft$, $\theta_0=45^\circ$, $v_0=200_ft/s$, $t=10_s$.

Solution: $R=1243.2399_ft$, $v_x=141.4214_ft/s$, $v_y=-180.3186_ft/s$, $x=1414.2136_ft$, $y=-194.4864_ft$.

Angular Motion (8, 4)

Equations:

$$\theta = \theta_0 + \omega_0 \cdot t + \frac{1}{2} \cdot \alpha \cdot t^2 \quad \theta = \theta_0 + \omega \cdot t + \frac{1}{2} \cdot \alpha \cdot t^2$$

$$\theta = \theta_0 + \frac{1}{2} \cdot (\omega_0 + \omega) \cdot t \quad \omega = \omega_0 + \alpha \cdot t$$

Example:

Given: $\theta_0=0_\circ$, $\omega_0=0_\text{r/min}$, $\alpha=1.5_\text{r/min}^2$, $t=30_\text{s}$.

Solution: $\theta=10.7430_\circ$, $\omega=0.7500_\text{r/min}$.

Circular Motion (8, 5)

Equations:

$$\omega = \frac{v}{r} \quad ar = \frac{v^2}{r} \quad \omega = 2 \cdot \pi \cdot N$$

Example:

Given: $r=25_\text{in}$, $v=2500_\text{ft/s}$

Solution: $\omega=72000_\text{r/min}$, $ar=3000000_\text{ft/s}^2$, $N=11459.1559_\text{rpm}$.

Terminal Velocity (8, 6)

Equation:

$$v = \sqrt{\frac{2 \cdot m \cdot g}{Cd \cdot \rho \cdot A}}$$

Example:

Given: $Cd=0.15$, $\rho=0.025_\text{lb/ft}^3$, $A=100000_\text{in}^2$, $m=1250_\text{lb}$.

Solution: $v=1757.4709_\text{ft/s}$.

Escape Velocity (8, 7)

Equation:

$$v = \sqrt{\frac{2 \cdot G \cdot M}{R}}$$

Example:

Given: $M=1.5\text{E}23_\text{lb}$, $R=5000_\text{mi}$.

Solution: $v=3485.1106_\text{ft/s}$.

Optics (9)

| Variable | Description |
|---------------|---------------------|
| θ_1 | Angle of incidence |
| θ_2 | Angle of refraction |
| θ_B | Brewster angle |
| θ_c | Critical angle |
| f | Focal length |
| m | Magnification |
| n, n_1, n_2 | Index of refraction |
| r, r_1, r_2 | Radius of curvature |
| u | Distance to object |
| v | Distance to image |

For reflection and refraction problems, the focal length and radius of curvature are positive in the direction of the outgoing light (reflected or refracted). The object distance is positive in front of the surface. The image distance is positive in the direction of the outgoing light (reflected or refracted). The magnification is positive for an upright image. Reference: 3.

Law of Refraction (9, 1)

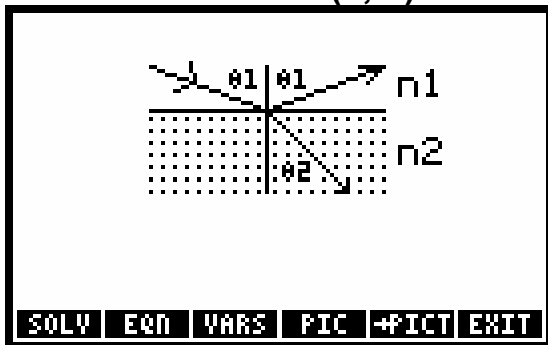

Equation:

$$n_1 \cdot \sin(\theta_1) = n_2 \cdot \sin(\theta_2)$$

Example:

Given: $n_1=1, n_2=1.333, \theta_1=45^\circ$.

Solution: $\theta_2=32.0367^\circ$.

Critical Angle (9, 2)

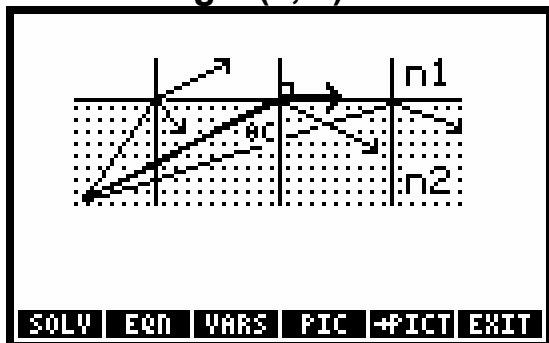

Equation:

$$\sin(\theta_c) = \frac{n_1}{n_2}$$

Example:

Given: $n_1=1, n_2=1.5$.

Solution: $\theta_c=41.8103^\circ$.

Brewster's Law (9, 3)

The Brewster angle is the angle of incidence at which the reflected wave is completely polarized.

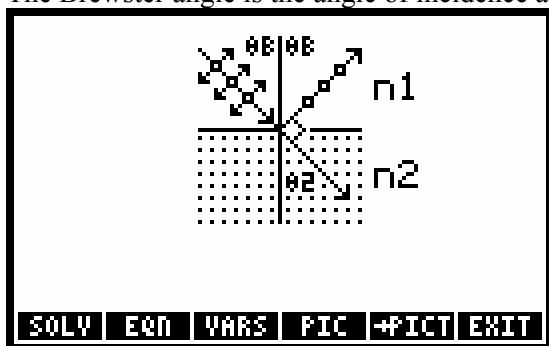

Equations:

$$\tan(\theta_B) = \frac{n_2}{n_1} \quad \theta_B + \theta_2 = 90$$

Example:

Given: $n_1=1, n_2=1.5$.

Solution: $\theta_B=56.3099^\circ, \theta_2=33.6901^\circ$.

Spherical Reflection (9, 4)

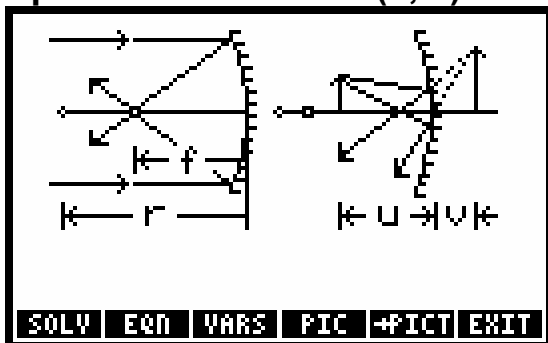

Equations:

$$\frac{1}{u} + \frac{1}{v} = \frac{1}{f} \quad f = \frac{1}{2} \cdot r \quad m = \frac{-v}{u}$$

Example:

Given: $u=10_{\text{cm}}$, $v=300_{\text{cm}}$, $r=19.35_{\text{cm}}$.

Solution: $m=-30$, $f=9.6774_{\text{cm}}$.

Spherical Refraction (9, 5)

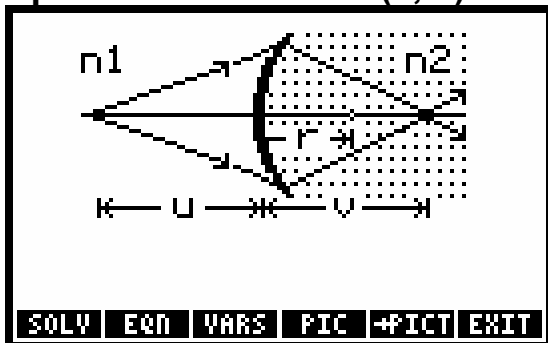

Equation:

$$\frac{n1}{u} + \frac{n2}{v} = \frac{n2 - n1}{r}$$

Example:

Given: $u=8_{\text{cm}}$, $v=12_{\text{cm}}$, $r=2_{\text{cm}}$, $n1=1$.

Solution: $n2=1.5000$.

Thin Lens (9, 6)

$r1$ is for the front surface, and $r2$ is for the back surface.

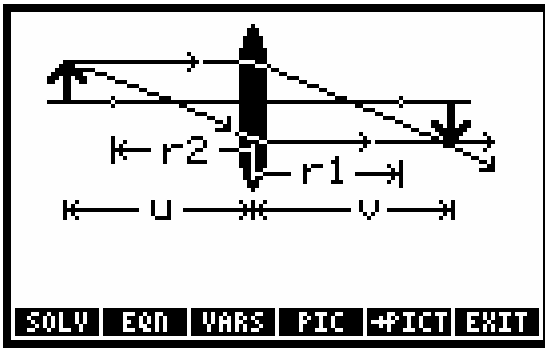

Equations:

$$\frac{1}{u} + \frac{1}{v} = \frac{1}{f} \quad \frac{1}{f} = (n-1) \cdot \left(\frac{1}{r_1} - \frac{1}{r_2} \right) \quad m = \frac{-v}{u}$$

Example:

Given: $r_1=5_cm$, $r_2=20_cm$, $n=1.5$, $u=50_cm$.

Solution: $f=13.3333_cm$, $v=18.1818_cm$, $m=-0.3636$.

Oscillations (10)

| Variable | Description |
|----------|-----------------------------|
| ω | Angular frequency |
| ϕ | Phase angle |
| θ | Cone angle |
| a | Acceleration at t |
| f | Frequency |
| G | Shear modulus of elasticity |
| h | Cone height |
| I | Moment of inertia |
| J | Polar moment of inertia |
| k | Spring constant |
| L | Length of pendulum |
| m | Mass |
| t | Time |
| T | Period |
| v | Velocity at t |
| x | Displacement at t |
| xm | Displace amplitude |

Reference: 3.

Mass-Spring System (10, 1)

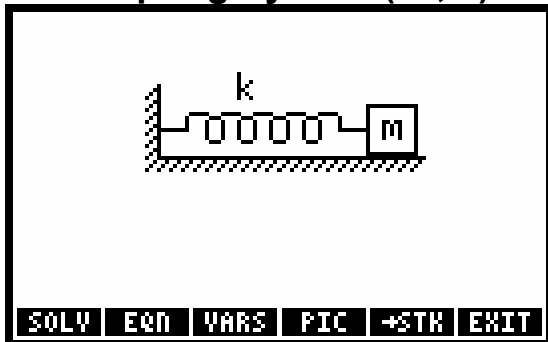

Equations:

$$\omega = \sqrt{\frac{k}{m}} \quad T = \frac{2 \cdot \pi}{\omega} \quad \omega = 2 \cdot \pi \cdot f$$

Example:

Given: $k=20_N/m$, $m=5_kg$.

Solution: $\omega=2_r/s$, $T=3.1416_s$, $f=.3183_Hz$.

Simple Pendulum (10, 2)

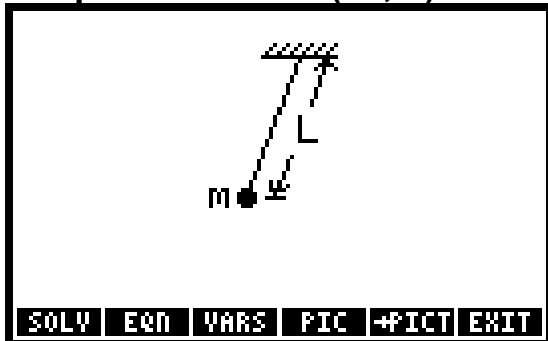

Equations:

$$\omega = \sqrt{\frac{g}{L}} \quad T = \frac{2 \cdot \pi}{\omega} \quad \omega = 2 \cdot \pi \cdot f$$

Example:

Given: $L=15_cm$.

Solution: $\omega=8.0856_r/s$, $T=0.7771_s$, $f=1.2869_Hz$.

Conical Pendulum (10, 3)

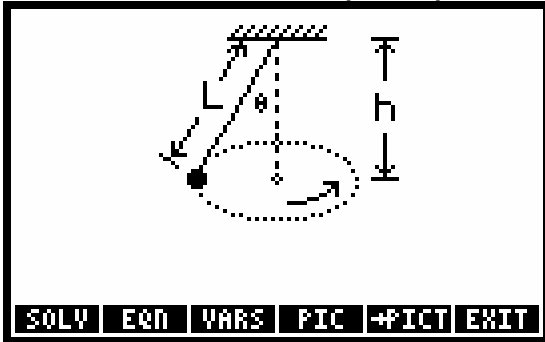

Equations:

$$\omega = \sqrt{\frac{g}{h}} \quad h = L \cdot \cos(\theta) \quad T = \frac{2 \cdot \pi}{\omega}$$

$$\omega = 2 \cdot \pi \cdot f$$

Example:

Given: $L=25_{\text{cm}}$, $h=20_{\text{cm}}$.

Solution: $\theta=36.899_{\circ}$, $T=0.8973_{\text{s}}$, $\omega=7.0024_{\text{r/s}}$, $f=1.1145_{\text{Hz}}$.

Torsional Pendulum (10, 4)

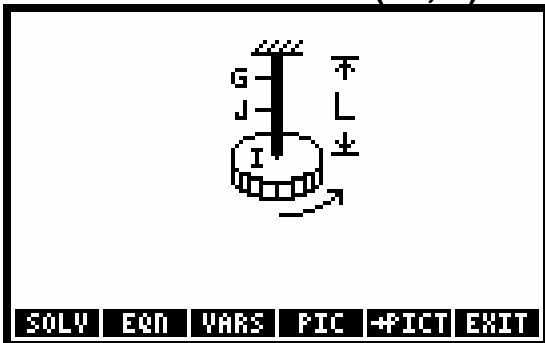

Equations:

$$\omega = \sqrt{\frac{G \cdot J}{L \cdot I}} \quad T = \frac{2 \cdot \pi}{\omega} \quad \omega = 2 \cdot \pi \cdot f$$

Example:

Given: $G=1000_{\text{kPa}}$, $J=17_{\text{mm}^4}$, $L=26_{\text{cm}}$, $I=50_{\text{kg} \cdot \text{m}^2}$.

Solution: $\omega=1.1435\text{E}-3_{\text{r/s}}$, $f=1.8200\text{E}-4_{\text{Hz}}$, $T=5494.4862_{\text{s}}$.

Simple Harmonic (10, 5)

Equations:

$$x = x_m \cdot \cos(\omega \cdot t + \phi) \quad v = -\omega \cdot x_m \cdot \sin(\omega \cdot t + \phi)$$

$$a = -\omega^2 \cdot x_m \cdot \cos(\omega \cdot t + \phi) \quad \omega = 2 \cdot \pi \cdot f$$

Example:**Given:** $xm=10_cm$, $\omega=15_r/s$, $\phi=25_^\circ$, $t=25_us$.**Solution:** $x=9.0615_cm$, $v=-0.6344_m/s$, $a=-20.3884_m/s^2$, $f=2.3873_Hz$.

Plane Geometry (11)

| Variable | Description |
|------------|--|
| β | Central angle of polygon |
| θ | Vertex angle of polygon |
| A | Area |
| b | Base length (Rectangle, Triangle), or Length of semiaxis in x direction (Ellipse) |
| C | Circumference |
| d | Distance to rotation axis in y direction |
| h | Height (Rectangle, Triangle), or Length of semiaxis in y direction (Ellipse) |
| I, I_x | Moment of inertia about x axis |
| I_d | Moment of inertia in x direction at d |
| I_y | Moment of inertia about y axis |
| J | Polar moment of inertia at centroid |
| L | Side length of polygon |
| n | Number of sides |
| P | Perimeter |
| r | Radius |
| r_i, r_o | Inside and outside radii |
| r_s | Distance to side of polygon |
| r_v | Distance to vertex of polygon |
| v | Horizontal distance to vertex |

Reference: 4.

Circle (11, 1)

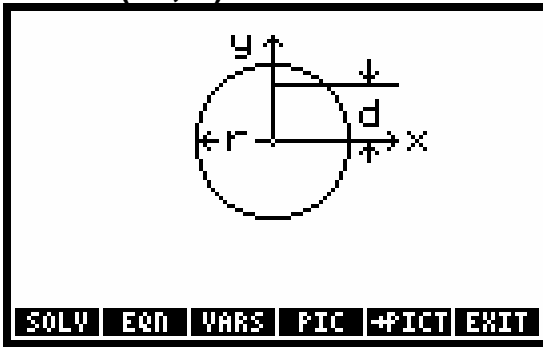

Equations:

$$A = \pi \cdot r^2 \quad C = 2 \cdot \pi \cdot r \quad I = \frac{\pi \cdot r^4}{4}$$

$$J = \frac{\pi \cdot r^4}{2} \quad Id = I + A \cdot d^2$$

Example:

Given: $r=5_cm$, $d=1.5_cm$.

Solution: $C=31.4159_cm$, $A=78.5398_cm^2$, $I=4908738.5_mm^4$, $J=9817477.0_mm^4$,
 $Id=6675884.4_mm^4$.

Ellipse (11, 2)

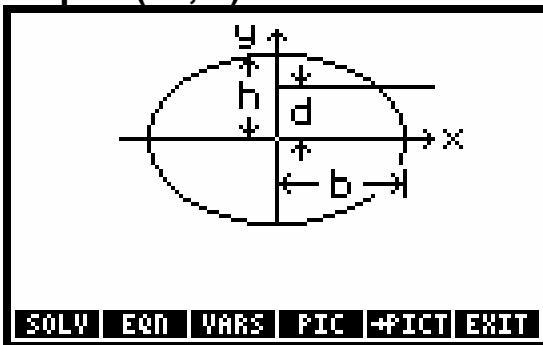

Equations:

$$A = \pi \cdot b \cdot h \quad C = 2 \cdot \pi \cdot \sqrt{\frac{b^2 + h^2}{2}} \quad I = \frac{\pi \cdot b \cdot h^3}{4}$$

$$J = \frac{\pi \cdot b \cdot h}{4} \cdot (b^2 + h^2) \quad Id = I + A \cdot d^2$$

Equations: Example:

Given: $b=17.85_um$, $h=78.9725_um$, $d=.00000012_ft$.

Solution: $A=1.1249E-6_cm^2$, $C=7.9805E-3_cm$, $I=1.1315E-10_mm^4$, $J=9.0733E-9_mm^4$,
 $Id=1.1330E-10_mm^4$.

Rectangle (11, 3)

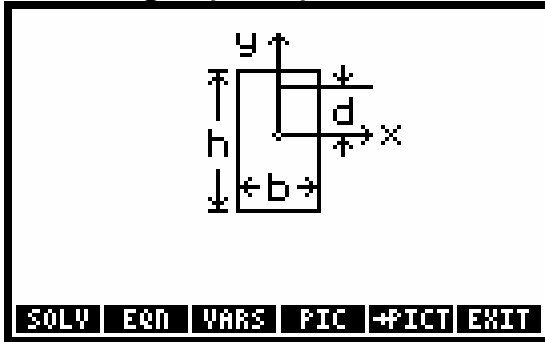

Equations:

$$A = b \cdot h \quad P = 2 \cdot b + 2 \cdot h \quad I = \frac{b \cdot h^3}{12}$$

$$J = \frac{b \cdot h}{12} \cdot (b^2 + h^2) \quad Id = I + A \cdot d^2$$

Example:

Given: $b=4_{\text{chain}}$, $h=7_{\text{rd}}$, $d=39.26_{\text{in}}$. Set guesses for I , J , and Id in km^4 .

Solution: $A=28328108.2691_{\text{cm}^2}$, $P=23134.3662_{\text{cm}}$, $I=2.9257\text{E}-7_{\text{km}^4}$, $J=1.8211\text{E}-6_{\text{km}^4}$, $Id=2.9539\text{E}-7_{\text{km}^4}$.

Regular Polygon (11, 4)

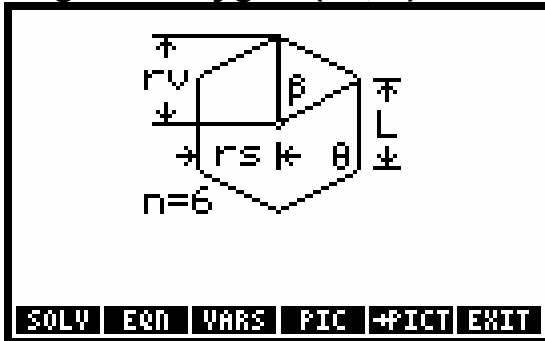

Equations:

$$A = \frac{\frac{1}{4} \cdot n \cdot L^2}{\text{TAN}\left(\frac{180}{n}\right)} \quad P = n \cdot L \quad r_s = \frac{\frac{L}{2}}{\text{TAN}\left(\frac{180}{n}\right)}$$

$$r_v = \frac{\frac{L}{2}}{\text{SIN}\left(\frac{180}{n}\right)} \quad \theta = \frac{n-2}{n} \cdot 180 \quad \beta = \frac{360}{n}$$

Example:

Given: $n=8$, $L=0.5_{\text{yd}}$.

Solution: $A=10092.9501_{\text{cm}^2}$, $P=365.7600_{\text{cm}}$, $r_s=55.1889_{\text{cm}}$, $r_v=59.7361$, $\theta=135_{\text{°}}$, $\beta=45_{\text{°}}$.

Circular Ring (11, 5)

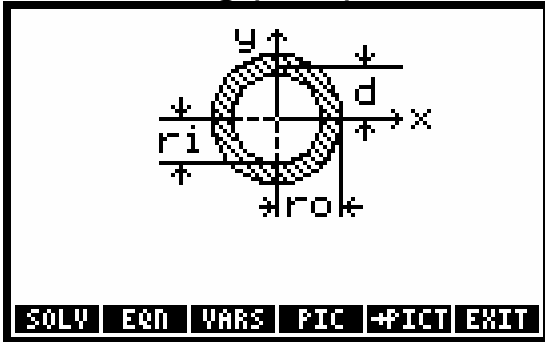

Equations:

$$A = \pi \cdot (ro^2 - ri^2) \quad I = \frac{\pi}{4} \cdot (ro^4 - ri^4)$$

$$J = \frac{\pi}{2} \cdot (ro^4 - ri^4) \quad Id = I + A \cdot d^2$$

Example:

Given: $ro=4_{\mu}$, $ri=25.0\text{\AA}$, $d=.1_{\text{mil}}$.

Solution: $A=3.0631\text{E-}7_{\text{cm}^2}$, $I=1.7038\text{E-}10_{\text{mm}^4}$, $J=3.4076\text{E-}10_{\text{mm}^4}$, $Id=3.0648\text{E-}10_{\text{mm}^4}$.

Triangle (11, 6)

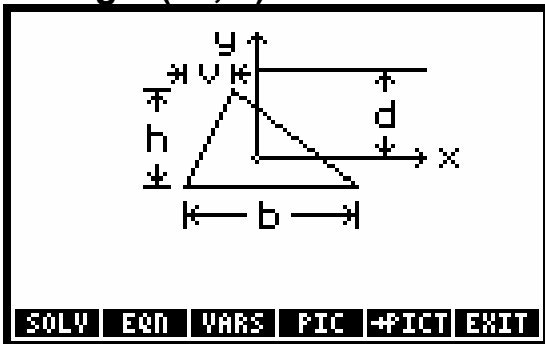

Equations:

$$A = \frac{b \cdot h}{2} \quad P = b + \sqrt{v^2 + h^2} + \sqrt{(b-v)^2 + h^2}$$

$$I_x = \frac{b \cdot h^3}{36} \quad I_y = \frac{b \cdot h}{36} \cdot (b^2 - b \cdot v + v^2)$$

$$J = \frac{b \cdot h}{36} \cdot (h^2 + b^2 - b \cdot v + v^2) \quad Id = I_x + A \cdot d^2$$

Example:

Given: $h=4.33012781892_{\text{in}}$, $v=2.5_{\text{in}}$, $P=15_{\text{in}}$, $d=2_{\text{in}}$.

Solution: $b=5.0000_{\text{in}}$, $I_x=11.2764_{\text{in}^4}$, $I_y=11.2764_{\text{in}^4}$, $J=22.5527_{\text{in}^4}$, $A=10.8253_{\text{in}^2}$, $Id=54.5776_{\text{in}^4}$.

Solid Geometry (12)

| Variable | Description |
|-------------|---|
| A | Total surface area |
| b | Base length |
| d | Distance to rotation axis in z direction |
| h | Height in z direction (Cone, Cylinder), or Height in y direction (Parallelepiped) |
| I, I_{xx} | Moment of inertia about x axis |
| I_d | Moment of inertia in x direction at d |
| I_{zz} | Moment of inertia about z axis |
| m | Mass |
| r | Radius |
| t | Thickness in z direction |
| V | Volume |

Reference: 4.

Cone (12, 1)

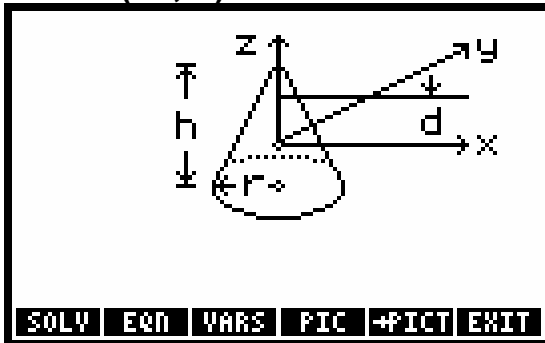

Equations:

$$V = \frac{\pi}{3} \cdot r^2 \cdot h \qquad A = \pi \cdot r^2 + \pi \cdot r \cdot \sqrt{r^2 + h^2}$$

$$I_{xx} = \frac{3}{20} \cdot m \cdot r^2 + \frac{3}{80} \cdot m \cdot h^2 \qquad I_{zz} = \frac{3}{10} \cdot m \cdot r^2$$

$$I_d = I_{xx} + m \cdot d^2$$

Example:

Given: $r=7_cm$, $h=12.5_cm$, $m=12.25_kg$, $d=3.5_cm$.

Solution: $V=641.4085_cm^3$, $A=468.9953_cm^2$, $I_{zz}=0.0162_kg \cdot m^2$, $I_{zz}=0.0180_kg \cdot m^2$,
 $I_d=0.0312_kg \cdot m^2$.

Cylinder (12, 2)

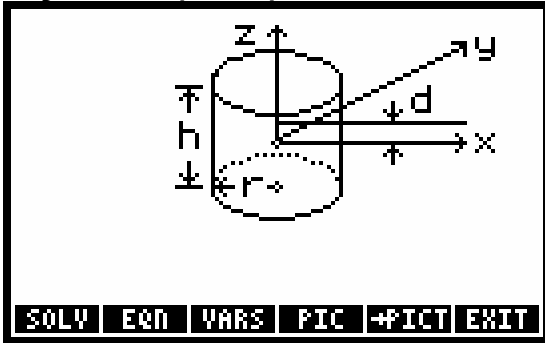

Equations:

$$V = \pi \cdot r^2 \cdot h \qquad A = 2 \cdot \pi \cdot r^2 + 2 \cdot \pi \cdot r \cdot h$$

$$I_{xx} = \frac{1}{4} \cdot m \cdot r^2 + \frac{1}{12} \cdot m \cdot h^2 \qquad I_{zz} = \frac{1}{2} \cdot m \cdot r^2$$

$$I_d = I_{xx} + m \cdot d^2$$

Example:

Given: $r=8.5_{in}$, $h=65_{in}$, $m=12000_{lbs}$, $d=2.5_{in}$.

Solution: $V=14753.7045_{in^3}$, $A=3925.4200_{in^2}$, $I_{zz}=4441750_{lb \cdot in^2}$, $I_{zz}=433500_{lb \cdot in^2}$, $I_d=4516750_{lb \cdot in^2}$.

Parallelepiped (12, 3)

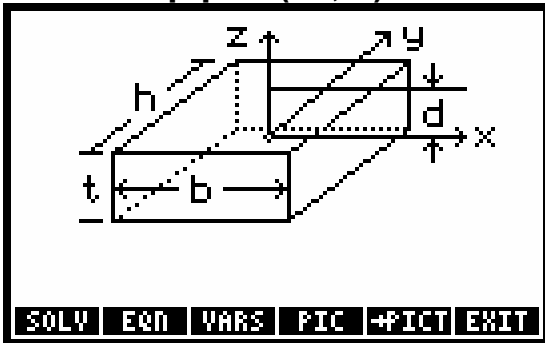

Equations:

$$V = b \cdot h \cdot t \qquad A = 2 \cdot (b \cdot h + b \cdot t + h \cdot t)$$

$$I = \frac{1}{12} \cdot m \cdot (h^2 + t^2) \qquad I_d = I + m \cdot d^2$$

Example:

Given: $b=36_{in}$, $h=12_{in}$, $t=72_{in}$, $m=83_{lb}$, $d=7_{in}$.

Solution: $V=31104_{in^3}$, $A=7776_{in^2}$, $I=36852_{lb \cdot in^2}$, $I_d=40919_{lb \cdot in^2}$.

Sphere (12, 4)

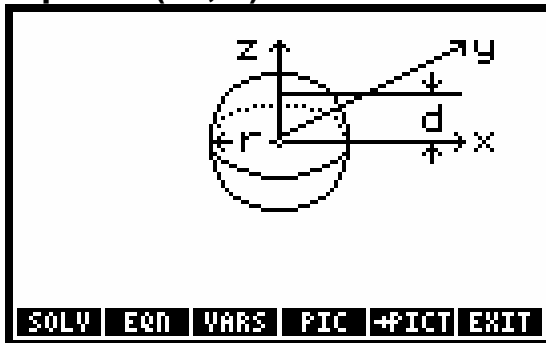

Equations:

$$V = \frac{4}{3} \cdot \pi \cdot r^3 \quad A = 4 \cdot \pi \cdot r^2 \quad I = \frac{2}{5} \cdot m \cdot r^2 \quad Id = I + m \cdot d^2$$

Example:

Given: $d=14_cm$, $m=3.75_kg$, $Id=486.5_lb \cdot in^2$.

Solution: $r=21.4273_cm$, $V=41208.7268_cm^3$, $A=5769.5719_cm^2$, $I=0.0689_kg \cdot m^2$.

Solid State Devices (13)

| Variable | Description |
|------------|---|
| αF | Forward common-base current gain |
| αR | Reverse common-base current gain |
| γ | Body factor |
| λ | Modulation parameter |
| μn | Electron mobility |
| ϕp | Fermi potential |
| ΔL | Length adjustment (PN Step Junctions), or Channel encroachment (NMOS Transistors) |
| ΔW | Width adjustment (PN Step Junctions), or Width contraction (NMOS Transistors) |
| a | Channel thickness |
| A_j | Effective junction area |
| BV | Breakdown voltage |
| C_j | Junction capacitance per unit area |
| C_{ox} | Silicon dioxide capacitance per unit area |
| EI | Breakdown-voltage field factor |
| E_{max} | Maximum electric field |
| $G0$ | Channel conductance |

| Variable | Description |
|-----------------|--|
| g_{ds} | Output conductance |
| g_m | Transconductance |
| I | Diode current |
| I_B | Total base current |
| I_C | Total collector current |
| I_{CEO} | Collector current (collector-to-base open) |
| I_{CO} | Collector current (emitter-to-base open) |
| I_{CS} | Collector-to-base saturation current |
| I_D, I_{DS} | Drain current |
| I_E | Total emitter current |
| I_{ES} | Emitter-to-base saturation current |
| I_S | Transistor saturation current |
| J | Current density |
| J_s | Saturation current density |
| L | Drawn mask length (PN Step Junctions), or |
| L_e | Effectives gate length |
| N_A | P-side doping (PN Step Junctions), or |
| N_D | N-side doping (PN Step Junctions), or |
| T | Temperature |
| t_{ox} | Gate silicon dioxide thickness |
| V_a | Applied voltage |
| V_{BC} | Base-to-collector voltage |
| V_{BE} | Base-to-emitter voltage |
| V_{bi} | Built-in voltage |
| V_{BS} | Substrate voltage |
| V_{CEsat} | Collector-to-emitter saturation voltage |
| V_{DS} | Applied drain voltage |
| V_{Dsat} | Saturation voltage |
| V_{GS} | Applied gate voltage |

| Variable | Description |
|------------|---|
| V_t | Threshold voltage |
| V_{t0} | Threshold voltage (at zero substrate voltage) |
| W | Drawn mask width (PN Step Junctions), or Drawn width (NMOS Transistors), or Channel width (JFETs) |
| W_e | Effective width |
| x_d | Depletion-region width |
| x_{dmax} | Depletion-layer width |
| x_j | Junction depth |

References: 5, 8.

PN Step Junctions (13, 1)

These equations for a silicon PN-junction diode use a "two-sided step-junction" model—the doping density changes abruptly at the junction. The equation assume the current density is determined by minority carries injected across the depletion region and the PN junction is rectangular in its layout, The temperature should be between 77 and 500 K. (See "SIDENS" in Chapter 3.)

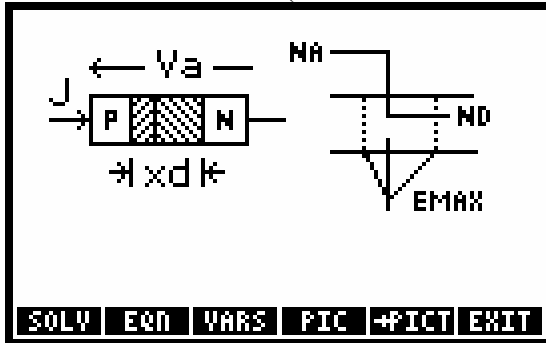

Equations:

$$V_{bi} = \frac{k \cdot T}{q} \cdot \text{LN}\left(\frac{N_A \cdot N_D}{n_i^2}\right)$$

$$x_d = \sqrt{\frac{2 \cdot \epsilon_{si} \cdot \epsilon_0}{q} \cdot (V_{bi} - V_a) \cdot \left(\frac{1}{N_A} + \frac{1}{N_D}\right)}$$

$$C_j = \frac{\epsilon_{si} \cdot \epsilon_0}{x_d} \quad E_{max} = \frac{2 \cdot (V_{bi} - V_a)}{x_d}$$

$$BV = \frac{\epsilon_{si} \cdot \epsilon_0 \cdot E_1^2}{2 \cdot q} \cdot \left(\frac{1}{N_A} + \frac{1}{N_D}\right) \quad J = J_s \cdot \left(e^{\frac{q \cdot V_a}{k \cdot T}} - 1\right)$$

$$A_j = (W + 2 \cdot \Delta W) \cdot (L + 2 \cdot \Delta L)$$

$$\pi \cdot (W + L + 2 \cdot \Delta W + 2 \cdot \Delta L) \cdot x_j + 2 \cdot \pi \cdot x_j^2$$

$$I = J \cdot A_j$$

Example:

Given: $ND=1E22\text{ cm}^{-3}$, $NA=1E15\text{ 1/cm}^3$, $T=26.85\text{ }^\circ\text{C}$, $J_s=1E-6\text{ }\mu\text{A/cm}^2$, $V_a=-20\text{ V}$,
 $E1=3.3E5\text{ V/cm}$, $W=10\text{ }\mu$, $\Delta W=1\text{ }\mu$, $L=10\text{ }\mu$, $\Delta L=1\text{ }\mu$, $x_j=2\text{ }\mu$.

Solution: $V_{bi}=.9962\text{ V}$, $x_d=5.2551\text{ }\mu$, $C_j=2005.0141\text{ pF/cm}^2$, $E_{max}=79908.5240\text{ V/cm}$,
 $BV=358.0825\text{ V}$, $J=-1.0E-12\text{ A/cm}^2$, $A_j=3.1993E-6\text{ cm}^2$, $I=-3.1993E-15\text{ mA}$.

NMOS Transistors (13, 2)

These equations for a silicon NMOS transistor use a two-port network model. They include linear and nonlinear regions in the device characteristics and are based on a gradual-channel approximation (the electric fields in the direction of current flow are small compared to those perpendicular to the flow). The drain current and transconductance calculations differ depending on whether the transistor is in the linear, saturated, or cutoff region. The equations assume the physical geometry of the device is a rectangle, second-order length-parameter effects are negligible, shot-channel, hot-carrier, and velocity-saturation effects are negligible, and subthreshold currents are negligible. (See "SIDENS" in Chapter 3.)

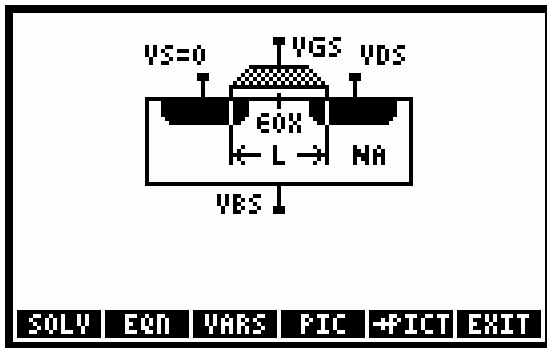

Equations:

$$W_e = W - 2 \cdot \Delta W \quad L_e = L - 2 \cdot \Delta L \quad C_{ox} = \frac{\epsilon_{ox} \cdot \epsilon_0}{t_{ox}}$$

$$I_{DS} = C_{ox} \cdot \mu_n \cdot \left(\frac{W_e}{L_e} \right) \cdot \left((V_{GS} - V_t) \cdot V_{DS} - \frac{V_{DS}^2}{2} \right) \cdot (1 + \lambda \cdot V_{DS})$$

$$\gamma = \frac{\sqrt{2 \cdot \epsilon_{si} \cdot \epsilon_0 \cdot q \cdot NA}}{C_{ox}}$$

$$V_t = V_{t0} + \gamma \cdot (\sqrt{2 \cdot ABS(\phi_p) - ABS(V_{BS})} - \sqrt{2 \cdot ABS(\phi_p)})$$

$$\phi_p = \frac{-k \cdot T}{q} \cdot \ln\left(\frac{NA}{ni}\right) \quad g_{ds} = I_{DS} \cdot \lambda$$

$$g_m = \sqrt{C_{ox} \cdot \mu_n \cdot \left(\frac{W_e}{L_e} \right) \cdot (1 + \lambda \cdot V_{DS}) \cdot 2 \cdot I_{DS}}$$

$$V_{Dsat} = V_{GS} - V_t$$

Example:

Given: $t_{ox}=700\text{ \AA}$, $NA=1E15\text{ 1/cm}^3$, $\mu_n=600\text{ cm}^2/(\text{V}\cdot\text{s})$, $T=26.85\text{ }^\circ\text{C}$, $V_{t0}=0.75\text{ V}$, $V_{GS}=5\text{ V}$,
 $V_{BS}=0\text{ V}$, $V_{DS}=5\text{ V}$, $W=25\text{ }\mu$, $\Delta W=1\text{ }\mu$, $L=4\text{ }\mu$, $\Delta L=0.75\text{ }\mu$, $\lambda=0.05\text{ 1/V}$.

Solution: $W_e=23\text{ }\mu$, $L_e=2.5\text{ }\mu$, $C_{ox}=49330.4750\text{ pF/cm}^2$, $\gamma=0.3725\text{ V}^{.5}$, $\phi_p=-.2898\text{ V}$, $V_t=0.75\text{ V}$,
 $V_{Dsat}=4.25\text{ V}$, $I_{DS}=3.0741\text{ mA}$, $g_{ds}=1.5370E-4\text{ S}$, $g_m=1.4466\text{ mA/V}$.

Bipolar Transistors (13, 3)

These equations for an NPN silicon bipolar transistor are based on large-signal models developed by J.J. Ebers and J.L. Moll. The offset-voltage calculation differs depending on whether the transistor is saturated or not. The equations also include the special conditions when the emitter-base or collector-base junction is open, which are convenient for measuring transistor parameters.

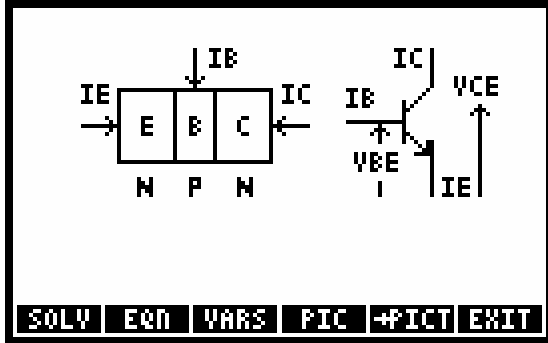

Equations:

$$I_E = -I_{ES} \cdot \left(e^{\frac{q \cdot V_{BE}}{k \cdot T}} - 1 \right) + \alpha_R \cdot I_{CS} \cdot \left(e^{\frac{q \cdot V_{BE}}{k \cdot T}} - 1 \right)$$

$$I_C = -I_{CS} \cdot \left(e^{\frac{q \cdot V_{BC}}{k \cdot T}} - 1 \right) + \alpha_F \cdot I_{ES} \cdot \left(e^{\frac{q \cdot V_{BE}}{k \cdot T}} - 1 \right)$$

$$I_S = \alpha_R \cdot I_{ES} \quad I_S = \alpha_R \cdot I_{CS} \quad I_B + I_E + I_C = 0$$

$$I_{CO} = I_{CS} \cdot (1 - \alpha_F \cdot \alpha_R) \quad I_{CEO} = \frac{I_{CO}}{1 - \alpha_F}$$

$$V_{CEsat} = \frac{k \cdot T}{q} \cdot \text{LN} \left(\frac{1 + \frac{I_C}{I_B} \cdot (1 - \alpha_R)}{\alpha_R \cdot \left(1 - \frac{I_C}{I_B} \cdot \left(\frac{1 - \alpha_F}{\alpha_F} \right) \right)} \right)$$

Example:

Given: $I_{ES}=1E-5_nA$, $I_{CS}=2E-5_nA$, $T=26.85_°C$, $\alpha_F=.98$, $\alpha_R=.49$, $I_C=1_mA$, $V_{BC}=-10_V$.

Solution: $V_{BE}=0.6553_V$, $I_S=0.0000098_nA$, $I_{CO}=0.000010396_nA$, $I_{CEO}=0.0005198_nA$,

$I_E = -1.0204_mA$, $I_B=0.0204_mA$, $V_{CEsat}=0_V$.

JFETs (13, 4)

These equations for a silicon N-channel junction field-effect transistor (JFET) are based on the single-sided step-junction approximation, which assumes the gates are heavily doped compared to the channel doping. The drain-current calculation differs depending on whether the gate-junction depletion-layer thickness is less than or greater than the channel thickness. The equations assume the channel is uniformly doped and end effects (such as contact, drain, and source resistances) are negligible. (See "SIDENS" in Chapter 3.)

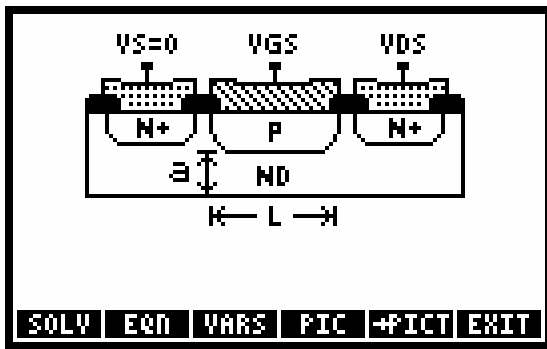

Equations:

$$V_{bi} = \frac{k \cdot T}{q} \cdot \ln\left(\frac{ND}{n_i}\right)$$

$$x_{dmax} = \sqrt{\frac{2 \cdot \epsilon_{si} \cdot \epsilon_0}{q \cdot ND} \cdot (V_{bi} - V_{GS} + V_{DS})}$$

$$G_0 = q \cdot ND \cdot \mu_n \cdot \left(\frac{a \cdot W}{L}\right)$$

$$I_D = G_0 \cdot \left(V_{DS} - \left(\frac{2}{3} \cdot \sqrt{\frac{2 \cdot \epsilon_{si} \cdot \epsilon_0}{q \cdot ND \cdot a^2}} \right) \cdot \left((V_{bi} - V_{GS} + V_{DS})^{\frac{3}{2}} - (V_{bi} - V_{GS})^{\frac{3}{2}} \right) \right)$$

$$V_{Dsat} = \frac{q \cdot ND \cdot a^2}{2 \cdot \epsilon_{si} \cdot \epsilon_0} \cdot (V_{bi} - V_{GS}) \quad V_t = V_{bi} - \frac{q \cdot ND \cdot a^2}{2 \cdot \epsilon_{si} \cdot \epsilon_0}$$

$$g_m = G_0 \cdot \left(1 - \sqrt{\frac{2 \cdot \epsilon_{si} \cdot \epsilon_0}{q \cdot ND \cdot a^2} \cdot (V_{bi} - V_{GS})} \right)$$

Example:

Given: $ND=1E16_1/cm^3$, $W=6_\mu$, $a=1_\mu$, $L=2_\mu$, $\mu_n= 1248_cm^2/(V \cdot s)$, $V_{GS}= -4_V$, $V_{DS}=4_V$, $T=26.85^\circ C$.

Solution: $V_{bi}=0.3493_V$, $x_{dmax}=1.0479_\mu$, $G_0=5.9986E-4_S$, $I_D=0.2268_mA$, $V_{Dsat}=3.2537_V$, $V_t=-7.2537_V$, $g_m=0.1462_mA/V$.

Stress Analysis (14)

| Variable | Description |
|------------|---------------------------------|
| δ | Elongation |
| ϵ | Normal strain |
| γ | Shear strain |
| ϕ | Angle of twist |
| σ | Normal stress |
| σI | Maximum principal normal stress |

| Variable | Description |
|----------------|---|
| σ_2 | Minimum principal normal stress |
| σ_{avg} | Normal stress on plane of maximum shear stress |
| σ_x | Normal stress in x direction |
| σ_{x1} | Normal stress in rotated- x direction |
| σ_y | Normal stress in y direction |
| σ_{y1} | Normal stress in rotated- y direction |
| τ | Shear stress |
| τ_{max} | Maximum shear stress |
| τ_{x1y1} | Rotated shear stress |
| τ_{xy} | Shear stress |
| θ | Rotation angle |
| θ_{p1} | Angle to plane of maximum principal normal stress |
| θ_{p2} | Angle to plane of minimum principal normal stress |
| θ_s | Angle to plane of maximum shear stress |
| A | Area |
| E | Modulus of elasticity |
| G | Shear modulus of elasticity |
| J | Polar moment of inertia |
| L | Length |
| P | Load |
| r | Radius |
| T | Torque |

Reference: 2.

Normal Stress (14, 1)

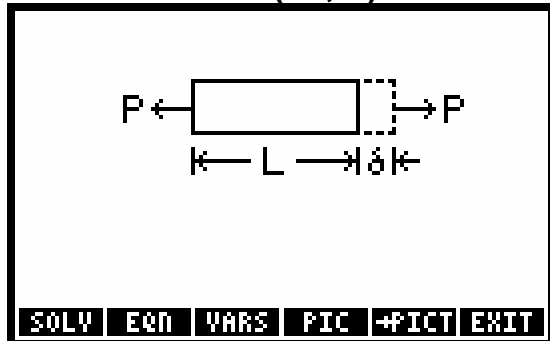

Equations:

$$\sigma = E \cdot \epsilon \quad \epsilon = \frac{\delta}{L} \quad \sigma = \frac{P}{A}$$

Example:

Given: $P=40000_lbf$, $L=1_ft$, $A=3.14159265359_in^2$, $E=10E6_psi$,

Solution: $\delta=0.0153_in$, $\epsilon=0.0013$, $\sigma=12732.3954_psi$.

Shear Stress (14, 2)

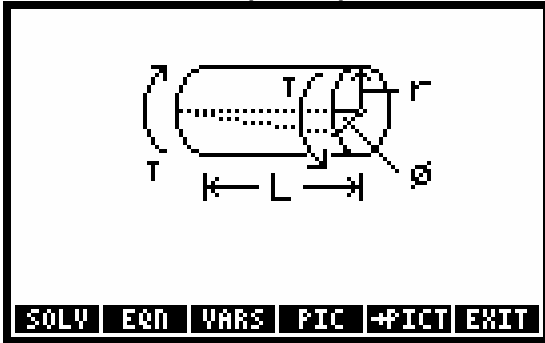

Equations:

$$\tau = G \cdot \gamma \quad \gamma = \frac{r \cdot \phi}{L} \quad \tau = \frac{T \cdot r}{J}$$

Example:

Given: $L=6_ft$, $r=2_in$, $J=10.4003897419_in^4$, $G=12000000_psi$, $\tau=12000_psi$.

Solution: $T=5200.1949_ft\cdot lbf$, $\phi=2.0626_^\circ$, $\gamma=5.7296E-2_^\circ$.

Stress on an Element (14, 3)

Stresses and strains are positive in the directions shown.

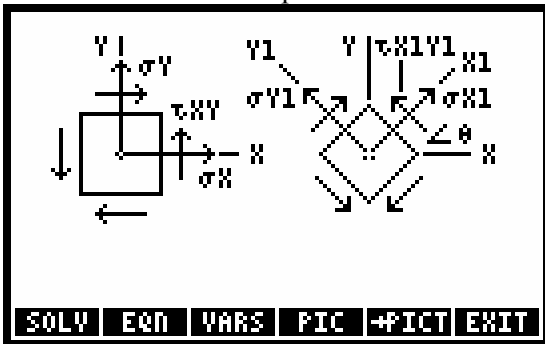

Equations:

$$\sigma_{x1} = \frac{\sigma_x + \sigma_y}{2} + \frac{\sigma_x - \sigma_y}{2} \cdot \cos(2 \cdot \theta) + \tau_{xy} \cdot \sin(2 \cdot \theta)$$

$$\sigma_{x1} + \sigma_{y1} = \sigma_x + \sigma_y$$

$$\tau_{x1y1} = -\left(\frac{\sigma_x - \sigma_y}{2}\right) \cdot \sin(2 \cdot \theta) + \tau_{xy} \cdot \cos(2 \cdot \theta)$$

Example:

Given: $\sigma_x=15000_kPa$, $\sigma_y=4755_kPa$, $\tau_{xy}=7500_kPa$, $\theta=30_^\circ$.

Solution: $\sigma_1=18933.9405_kPa$, $\sigma_2=821.0595_kPa$, $\tau_{x1y1}=-686.2151_kPa$.

Mohr's Circle (14, 4)

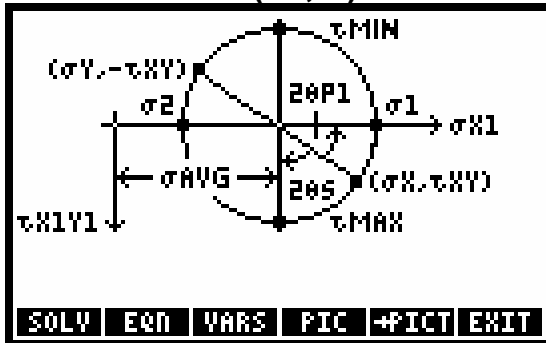

Equations:

$$\sigma_1 = \frac{\sigma_x + \sigma_y}{2} + \sqrt{\left(\frac{\sigma_x - \sigma_y}{2}\right)^2 + \tau_{xy}^2}$$

$$\sigma_1 + \sigma_2 = \sigma_x + \sigma_y$$

$$\sin(2 \cdot \theta_{p1}) = \frac{\tau_{xy}}{\sqrt{\left(\frac{\sigma_x - \sigma_y}{2}\right)^2 + \tau_{xy}^2}}$$

$$\theta_{p2} = \theta_{p1} + 90 \quad \tau_{max} = \frac{\sigma_1 - \sigma_2}{2}$$

$$\theta_s = \theta_{p1} - 45 \quad \sigma_{avg} = \frac{\sigma_x + \sigma_y}{2}$$

Example:

Given: $\sigma_x=-5600_psi$, $\sigma_y=-18400_psi$, $\tau_{xy}=4800_psi$.

Solution: $\sigma_1=-4000_psi$, $\sigma_2=-20000_psi$, $\theta_{p1}=18.4349^\circ$, $\theta_{p2}=108.4349^\circ$, $\tau_{max}=8000_psi$, $\theta_s=-26.5651^\circ$, $\sigma_{avg}=-12000_psi$.

Waves (15)

| Variable | Description |
|-----------|--|
| β | Sound level |
| λ | Wavelength |
| ω | Angular frequency |
| ρ | Density of medium |
| B | Bulk modulus of elasticity |
| f | Frequency |
| I | Sound intensity |
| k | Angular wave number |
| s | Longitudinal displacement at x and t |

| Variable | Description |
|----------|--|
| sm | Longitudinal amplitude |
| t | Time |
| v | Speed of sound in medium (Sound Waves), or Wave speed (Transverse Waves, Longitudinal Waves) |
| x | Position |
| y | Transverse displacement at x and t |
| ym | Transverse amplitude |

Reference: 3.

Transverse Waves (15,1)

Equations:

$$y = ym \cdot \text{SIN}(k \cdot x - \omega \cdot t) \quad v = \lambda \cdot f \quad k = \frac{2 \cdot \pi}{\lambda} \quad \omega = 2 \cdot \pi \cdot f$$

Example:

Given: $ym=6.37_cm$, $k=32.11_r/cm$, $x=.03_cm$, $\omega=7000_r/s$, $t=1_s$.

Solution: $f=1114.0846_Hz$, $\lambda=0.0020_cm$, $y=2.6655_cm$, $v=218.0006_cm/s$.

Longitudinal Waves (15, 2)

Equations:

$$s = sm \cdot \text{COS}(k \cdot x - \omega \cdot t) \quad v = \lambda \cdot f \quad k = \frac{2 \cdot \pi}{\lambda} \quad \omega = 2 \cdot \pi \cdot f$$

Example:

Given: $sm=6.37_cm$, $k=32.11_r/cm$, $x=0.03_cm$, $\omega=7000_r/s$, $t=1_s$.

Solution: $s=5.7855_cm$, $v=2.1800_m/s$, $\lambda=0.1957_cm$, $f=1114.08456_Hz$.

Sound Waves (15, 3)

Equations:

$$v = \sqrt{\frac{B}{\rho}} \quad I = \frac{1}{2} \cdot \rho \cdot v \cdot \omega^2 \cdot sm^2$$

$$\beta = 10 \cdot \text{LOG}\left(\frac{I}{I_0}\right) \quad \omega = 2 \cdot \pi \cdot f$$

Example:

Given: $sm=10_cm$, $\omega=6000_r/s$, $B=12500_kPa$, $\rho=65_kg/m^3$.

Solution: $v=438.5290_m/s$, $I=5130789412.97_W/m^2$, $\beta=217.018_dB$, $f=954.9297_Hz$.

References

1. Dranchuk, P.M., R.A. Purvis, and D.B. Robinson. "Computer Calculations of Natural Gas Compressibility Factors Using the Standing and Katz Correlation," *In Institute of Petroleum Technical Series*, no. IP 74-008. 1974.
2. Gere, James M., and Stephen P. Timoshenko. *Mechanics of Materials*, 2d ed. PWS Engineering, Boston, 1984.
3. Halliday, David, and Robert Resnick. *Fundamentals of Physics*, 3d ed. John Wiley & Sons, 1988.
4. Meriam, J. L., and L. G. Kraige. *Engineering Mechanics*, 2d ed. John Wiley & Sons, 1986
5. Muller, Richard S., and Theodore I. Kamins. *Device Electronics for Integrated Cicuits*, 2d ed. John Wiley & Sons 1986.
6. Serghides, T. K. "Estimate Friction Factor Accurately," *In Chemical Engineering*, Mar. 5, 1984.
7. Siegel, Robert, and John Howell. *Thermal Radiation Heat Transfer*, Vol. 1. National Aeronautics and Space Administration, 1968.
8. Sze, S. *Physics of Semiconductors*, 2d ed. John Wiley & Sons, 1981.
9. Welty, Wicks, and Wilson. *Fundamentals of Momentum, Heat and Mass Transfer*. John Wiley & Sons, 1969.

PEEKARM

Memory read: reads nibbles from a specified address in memory in the ARM address space.

| | | | |
|--------------------------|---|----|---------|
| Level 2 | Level 1 | -> | Level 1 |
| Binary integer (address) | Binary Integer (number of byte to read) | -> | String |

POKEARM

Memory write command: Writes bytes in ARM memory address space.

Note: You can not write data in the Flash ROM using this command.

Note: Writing data in memory randomly will cause memory lost.

| | | | |
|---|-------------------------------|----|---------|
| Level 1 | Level 2 | -> | Level 1 |
| Binary integer (Address where to write) | String (Data to write in hex) | -> | |

A→

Address out: Returns the object stored at a specific address.

| | | |
|----------------|----|---------|
| Level 1 | -> | Level 1 |
| Binary integer | -> | Object |

→A

Get Address: Returns the address of an object.

| | | |
|---------|----|----------------|
| Level 1 | -> | Level 1 |
| Object | -> | Binary integer |

→RAM

Improved NEWOB: This command makes a copy of an object in RAM, wherever the object is.

This commands allows you to copy a ROM object in RAM.

| | | |
|---------|----|-----------------------|
| Level 1 | -> | Level 1 |
| Object | -> | Object located in RAM |

A→H

Address to string: Returns the hex representation of an address (you can then use this with the POKE command).

The hex representation of an address is a 5 character string where the address is written backwards.

| | | |
|----------------|----|---------|
| Level 1 | -> | Level 1 |
| Binary integer | -> | string |

H→A

String to address: Returns the address represented by a 5 character string.

The hex representation of an address is a 5 character string where the address is written backwards.

| | | |
|---------|----|----------------|
| Level 1 | -> | Level 1 |
| String | -> | binary integer |

CD→

Code to hex: Returns the hex representation of a code (Assembly program) object.

| | | |
|---------|----|---------|
| Level 1 | -> | Level 1 |
| Code | -> | string |

→CD

Hex to Code: Returns the code (Assembly program) object represented by an hex string.
A hex string is a string that only contains the characters '0' to '9' and 'A' to 'F'.

| | | |
|---------|----|---------|
| Level 1 | -> | Level 1 |
| String | -> | Code |

→H

Object to hex: Returns the hex representation of a object.

| | | |
|---------|----|---------|
| Level 1 | -> | Level 1 |
| Object | -> | string |

H→

Hex to object: Returns the object represented by a hex string.

A hex string is a string that only contains the characters '0' to '9' and 'A' to 'F'.

Note: if the string does not represent a valid object, this can corrupt your memory;

| | | |
|---------|----|---------|
| Level 1 | -> | Level 1 |
| String | -> | Object |

S→H

String to hex: Returns the hex representation of the characters of a string.

Example: "A" S→H → "14"

| | | |
|---------|----|---------|
| Level 1 | -> | Level 1 |
| String | -> | String |

H→S

Hex to string: Returns the string whose data are represented by a hex string.

A hex string is a string that only contains the characters '0' to '9' and 'A' to 'F'.

Example: "14" H→S → "A"

| | | |
|---------|----|---------|
| Level 1 | -> | Level 1 |
| String | -> | String |

SREV

String reverse: Gives the mirror image of a string.

Example: "ABC" SREV → "CBA"

| | | |
|---------|----|---------|
| Level 1 | -> | Level 1 |
| String | -> | String |

MAKESTR

Create a string of the given size.

Example: 10 MAKESTR -> "ABCDEFGG<cr>AB"

| | | |
|---------|----|---------|
| Level 1 | -> | Level 1 |
| Real | -> | String |

SERIAL

Retrieve the calculator serial number

| | | |
|---------|----|---------|
| Level 1 | -> | Level 1 |
| | -> | String |

→S2

Decompile an object in System RPL mode.

Example: << >> →S2 -> "!NO CODE !RPL :: x<< x>> ; <cr>@"

| | | |
|---------|----|---------|
| Level 1 | -> | Level 1 |
| Object | -> | String |

XLIB~

Convert reals to an XLIB.

| | | |
|---------|------------|---------|
| Level 2 | Level 1 -> | Level 1 |
| Real | Real -> | Xlib |
| Binary | Real -> | Xlib |
| Real | Binary -> | Xlib |
| Binary | Binary -> | Xlib |

CRC

CRC computation: gives the CRC of a library or a string.

This command gives you the CRC of the data in a library object or string (the CRC computation starts on the size of the object and finishes 4 nibbles before the end of the object)

| | | |
|----------------|----|----------------|
| Level 1 | -> | Level 1 |
| String/Library | -> | System integer |

S~N

String to name conversions: This command converts a string to a name and a name to a string.

This command allows you to create invalid names.

Note: Do not purge or move the null directory in HOME. Do not modify data in this directory.

| | | |
|-------------|----|-------------|
| Level 1 | -> | Level 1 |
| String | -> | Global name |
| Global name | -> | String |

R~SB

Real to System binary conversions: This command converts a system binary to a real and a real to a system binary.

| | | |
|---------------|----|---------------|
| Level 1 | -> | Level 1 |
| Real | -> | System binary |
| integer | -> | System binary |
| System binary | -> | Real |

SB~B

Binary integer to System binary conversions: This command converts a system binary to a binary integer and a binary integer to a system binary.

| | | |
|----------------|----|----------------|
| Level 1 | -> | Level 1 |
| Binary integer | -> | System binary |
| System binary | -> | Binary integer |

LR~R

Long real to real: This command converts a long real to a real and a real to a long real.

| | | |
|-----------|----|-----------|
| Level 1 | -> | Level 1 |
| Long real | -> | Real |
| Real | -> | Long real |

LC~C

Long complex to complex: This command converts a long complex to a complex and a complex to a long complex.

| | | |
|--------------|----|--------------|
| Level 1 | -> | Level 1 |
| Long complex | -> | Complex |
| Complex | -> | Long complex |

COMP→

Composite out: This is equivalent to the RPL LIST→ command, but it also works on Program and Symbolic objects.

| | | | |
|-----------------------|----|--------------|----------|
| Level 1 | -> | Level n+1..2 | Level 1 |
| List/Program/Symbolic | -> | Objects | n (real) |

→ALG

Create symbolic: This is equivalent to the RPL →LIST command, but it creates a symbolic object.

Note: this command will also convert a program or a list in a symbolic object.

| | | | |
|--------------|-----------------------|----|----------|
| Level n+1..2 | Level 1 | -> | Level 1 |
| | List/Program/Symbolic | -> | Symbolic |
| Objects | real (n) | -> | Symbolic |

→PRG

Create program: This is equivalent to the RPL →LIST command, but it creates a program object.

Note: this command will also convert a symbolic or a list in a program object.

| | | | |
|--------------|-----------------------|----|---------|
| Level n+1..2 | Level 1 | -> | Level 1 |
| | List/Program/Symbolic | -> | Program |
| Objects | real (n) | -> | Program |

→LST

Create symbolic: This is equivalent to the RPL →LIST command, but it can also convert a program or symbolic in a list.

| | | | |
|--------------|-----------------------|----|---------|
| Level n+1..2 | Level 1 | -> | Level 1 |
| | List/Program/Symbolic | -> | List |
| Objects | real (n) | -> | List |

Section 3 - CRLIB

Create library command.

A library is one of the most complex objects in the hp49+/hp48gII. One of the basic uses of a library is to group all the files of an application.

In order to create a library, you must store in a directory all the variables that will be part of this library. Then, you must store configuration information in some special variables.

The \$TITLE variable must contain a character string defining the title of the library. This string must be less than 256 characters long. The first five characters will be used for the name that is shown in the library menu.

The \$ROMID variable must contain the library number or your library. This number must be in the range 769 to 1791. In order to avoid conflicts, you should go to www.hp48.org to check whether the number is already in use. This variable may contain either a real or an integer.

The \$CONFIG variable contains the library configuration object which is run at warmstart. The basic action that this program should perform is to attach the library to the home directory. Placing a real or an integer in the \$CONFIG variable will cause the CRLIB command to generate a default CONFIG object. This Program must leave the stack intact and is not allowed to produce errors.

The \$VISIBLE variable contains a list of all the variables in the current directory that you want to have visible in the library menu.

The \$HIDDEN variable contains a list of all the variables in the current directory that you want to have invisible in the library. They are generally subprograms of your application.

The \$EXTPRG variable contains the name of the extension program of the library. This program must be either a visible or an hidden object of the library. See the Extension program for more information.

Then, once you have specified the required variables, you can type CRLIB to create the library.

| | |
|----|---------|
| -> | Level 1 |
| -> | Library |

3.1 Extension program

It is possible to enhance some of the statistics menus using a user library. The hp49g+/hp48gII does not provide every possible function in every area, but they let you customize the built in menu in order to add your functions as if they were built in.

Example: Customize the main statistic menu.

Go in RPL mode (MODE), (+/-), (ENTER) and attach the development library (256 ATTACH).

In a directory, create the following variables:

```
$ROMID      1324
$CONFIG     1
$TITLE      "Statistic enhancements"
$VISIBLE    { ABOUT }
$HIDDEN     { MessageHandler }
$EXTPRG     'MessageHandler'
ABOUT      "This library is a statistic enhancement example"
```

MessageHandler

```
<<
  IF DUP 1 R~SB ==
  THEN
    SWAP
    { { "7.New entry" << "My Stats" 1 DISP 7 * FREEZE >> } } +
    SWAP
  END
>>
```

Create the library (CRLIB) and store it in an extension port (0 (STO▶))

Now, run the statistic menu (▶ 5)!

How does it work?

Each time the stat menu pops up, the hp49g+/hp48gII executes every extension program of every library in the system. This extension program takes on the stack a message number (and leaves it on the stack!). Each message number has a specific meaning as described below.

Here are the expected inputs and outputs for the extension program for different menus:

APPS menu

Input: { { "String" Action } ... } ZERO

Output: Modified list ZERO

Main Statistics menu

Input: { { "String" Action } ... } ONE

Output: Modified list ONE

Hypothesis statistics menu

Input: { { "String" Action } ... } TWO

Output: Modified list TWO

Confidence interval statistics menu
Input: { { "String" Action } ... } THREE
Output: Modified list THREE

Finance menu
Input: { { "String" Action } ... } FOUR
Output: Modified list FOUR

Numeric solver menu
Input: { { "String" Action } ... } FIVE
Output: Modified list FIVE

Section 4 - ASM

The Machine Language and System RPL Compiler (MASD)

4.1 Introduction

4.1.1 Warnings

The operating system can not control what a low level program is doing. Therefore, any programming error is likely to cause the calculator to crash (with potential memory lost). A careful developer will always save source code in the internal flash ROM or port 1 for protection before trying low level programs.

This document does not intend to be a programming course – it just presents the syntax of the compiler. Ample resources are available on the web (www.hpcalc.org) to learn how to program the Saturn CPU in assembler, how to program in System RPL or how to program in ARM assembly.

With the introduction of the new ARM based series of calculators, some new things have been included that are not backward compatible with previous calculators. The careful programmer should be wary of this.

4.1.2 Starting MASD

To compile a program, put the source code on the level 1 of the stack and type `ASM` (the development library must be attached) or use the `ASM` menu of the Development library.

If you have a new version of MASD packaged as a library 259, the command to type is `asm` (note the lowercase).

4.1.3 Modes

MASD can be used to compile program in 3 different languages: Saturn ASM, ARM ASM and System RPL. Although some things are common to all modes, some are not. As a programmer, you should always know the current mode.

Compilation directives instructions are used to switch from one mode to another:

`!ASM` (switch to Saturn ASM mode, referred in the rest of this document as the Saturn mode)

`!RPL` (switch to System RPL mode)

`!ARM` (switches to ARM ASM mode)

In addition, in RPL mode,

`CODE`

`% here we are in ASM mode`

`ENDCODE`

Allows switching from RPL mode to Saturn mode (and generate an assembly program object)

4.1.4 Syntax

MASD expects a character string (called source) on the stack level 1.

A source is a set of instructions, comments, and separation characters and ends with a carriage return and an `␣` character.

MASD is case sensitive, so be careful, as `«loop»` and `«LOOP»` are two different things for MASD.

Separation characters are those with an ASCII number below 32. They include spaces, tabs, line feed and carriage return.

In Saturn mode, some instructions need a parameter. Separation characters between an instruction and the parameter are spaces, tabs, and points. Therefore `A+B.A` can be used instead of `A+B A`.

In ARM mode, parameters for the instruction are separated by spaces and commas. In Saturn or ARM mode, comments can be placed everywhere and begin with `⌘` or `⌚` and finish at the end of the current line.

In RPL mode, comments are delimited by `{` `'` `}` as isolated characters and can be multi line. A line that starts with a `*` on the first character will also be considered a comment.

Directives change the way MASD interprets your source. These directives begin with a `!` and will be explained later.

4.1.5 Errors

If MASD detects one or more syntax error, it will push a list describing all errors on the stack. The `ER` command can help you make sense of that list, point you on the errors and let you correct them.

MASD will report a maximum of 16 errors before stopping compilation.

The `ER` command takes 2 objects as arguments:

The original source code (level 2)

The error list generated by MASD (level 1)

Normally, you should compile using a process similar to: `IFERR ASM THEN ER END` (this is what the `ASM2` command does BTW). Most peoples will just type the `ASM` command followed, if error, by the `ER` command.

4.1.5.1 Format of the error list:

It's a list of at most 16 sub-lists.

Each sub-list contains 3 system-binary and 1 global-name.

The first system binary is an error message number.

The second is an extra system binary used to indicate how 'too long' a jump is.

The third one is the position in the source where the error is.

The global name is either a `NULLNAME` if the error was in the main source or the filename of the buggy source.

4.1.5.2 Error messages

| | |
|------------------------|--|
| Invalid File | The file is not a valid source or macro. (must end with a <code>␣</code>) |
| Too many | You can not do this operation as you are limited to a certain amount of them (for example, you can not have more than 64 simultaneous skips) |
| Unknown Instruction | Unknown instruction |
| Invalid Field | Incorrect field |
| Val betw 0-15 expected | An integer between 0 and 15 is expected |
| Val betw 1-16 expected | An integer between 1 and 16 is expected |
| Val betw 1-8 expected | An integer between 1 and 8 is expected |
| Label Expected | A label is expected |
| Hexa Expected | An hexadecimal number is expected |
| Decimal Expected | An decimal number is expected |
| Can't find | This object can not be located |
| Label already defined | This name is already in use |
| { expected | A { character was expected |
| } expected | A } character was expected (this can happen if you do not close all the open skips for example) |
| (expected | A (character was expected |
| [or] expected | A [or] character was expected |
| Forbidden | This can not be done |
| Bad Expression | This expression is invalid |
| Jump too long | This jump is above the limit of the instruction (use a different type of jump) |

| | |
|-----------------------|---|
| Insuffisant Memory | There is not enough memory to compile |
| Matrix Error | You can not do this thing here because you are creating a matrix object |
| Define Error | You can not do this operation in a DEFINE |
| ARM register expected | No comments. |
| ARM invalid imediate | In ARM mode, constants must be representable on 8 bit with an even number of rotation |

4.1.6 Links

Links are secondary source files that MASD can be directed to compile (equivalent to the `{ $I }` directive in Pascal and `#include` in C). As there is no linking phase with MASD (like in C), a multi source project will usually have the form of a main source file that contains a certain number of links.

An example of main source would be:

```
"
'Constant_definition
'initialization
'graphic_functions
'other
@"
```

When a link call is encountered, MASD suspends compilation of the current source, compiles the new source and then continues compiling the first one.

Program and data in the final object will be in the order in which MASD encounters the links.

Syntax in ASM and ARM mode:

`'FileName` links the file called `FileName`.

Syntax in RPL mode:

`INCLUDE FileName` links the file called `FileName`.

Note 1: A link can call other links

Note 2: You can not use more than 64 links in your project

Note 3: To know how MASD looks for files, see the File search section

Note 4: Links are useful to cut projects in independent parts to allow fast and easy access to source code

Note 6: It is beneficial to place all constants definitions at the beginning of the compilation process as this will speed up compilation and give more flexibility

4.1.7 Labels

A label is a marker in the program. The principal use of labels is to determine jump destinations.

A label is a set of less than 64 characters other than space, `'+''`, `'-''`, `'*''` and `'/''`. A label begins with a star `'*''` and ends with a separation character.

Syntax in ASM and ARM mode:

`*BigLoop` is the `BigLoop` label declaration.

Syntax in RPL mode:

`LABEL BigLoop` is the `BigLoop` label declaration.

Be careful about upper and lower cases!

Three types of labels can be used:

- Global labels
 - A global label is a label that can be used everywhere in the project, like global variables in Pascal or C.
- Local labels
 - A Local label is a label that is only accessible in a local section like local variables in Pascal or C.
 - A local section starts at the beginning of a source, after a global label or after a link (see link section).
 - A local section finishes at the end of a source, before a link or before a global label.
 - A local label is identified by a `'_'` as the first character.
- Link labels
 - A link label is a label that exists only in the link where it is declared, like a private clause in Object Pascal.

A link label is identified by a ‘_’ as the first character.

Note 1: In projects, using less global labels is better because a global label takes longer to compile and because it gives a better program structure. A good habit is to use global labels to cut the program in subroutines, and to use local labels inside these subroutines.

Note 2: The command line editor is able to find labels in a source. See the `GOTO` selection in the command line `TOOL` menu.

Note 3: labels in System RPL should only be used by people who know what they are doing. They are only used for fixed address program (absolute mode) which is pretty advanced programming.

Note 4: Labels can not be given the same name as constants.

4.1.8 “extable”

“extable” is an external library that contains a list of constants. This list can be used by MASD as a basic list of constants and is especially useful to the System RPL programmer as most entry points are defined there (like `TURNMENUOFF` for example). In addition, it also contains a set of supported constants and ASM entry points for the ASM programmer. Please read the extable section in this document to find more information about this library.

4.1.9 Constants

Constants are a way for the user to associate a value to an alphanumerical name. This is extremely useful as it makes programs much easier to read and makes them more portable. One of the most popular ways to use constants is to represent memory address for storage of variables.

For example, instead of typing `D1=80100` every time it is needed, it is better to declare `DC Result 80100` at the beginning of the project and then to type `D1=(5)Result` when needed (it is more portable, more readable and less likely to cause errors).

You can create a constant in ASM or ARM mode by doing:

```
DC CstName ExpressionHex or  
DEFINE CstName ExpressionHex or  
EQU CstName ExpressionHex
```

In RPL mode, the only valid way to define a constant is:

```
EQU CstName ExpressionHex
```

`ExpressionHex` is either a hexadecimal number or an expression (starting with a char that can not be confused with the start of a hex number (`0..9,A..F`)). An expression starting with a hexadecimal number can be typed with a leading `$`, an expression starting with a decimal number can be typed with a leading `#` character. For an expression starting with a constant that starts with a `0..9` or `A..F` character, you should put the constant in brackets.

Note 1: A constant cannot be given the same name as a label.

Note 2: The name of a constant follows the same rules as the name of a label.

Note 3: A constant value is stored in 16 nibbles.

Note 4: Having constants starting with something that can be interpreted as a hex number, or an ARM register is not a good idea as the compiler might get confused. For example: `DC SPFOO 4 MOV R4 SPFOO` will generate an error on `FOO` as the compiler will interpret the mov as a mov from SP to R4.

MASD introduces a ‘constant pointer’ called CP which helps to define constants. CP is defined by:

```
CP=ExpressionHex
```

CP is defined on 5 nibbles, its default value is 80100 (an area of memory that can be used freely by programmers).

```
EQUCP Increment ConstantName
```

Declares a constant with the current CP value and then increase CP by Increment.

Note 1: in ASM and ARM mode, `DCCP Increment ConstantName` is also valid

Note 2: Increment is a hexadecimal value, to use a decimal value, put a leading `#`.

For example, if CP equals to `$10`

```
EQUCP 5 Foo
```

Defines a `Foo` constant with a value of `$10` and then change the value of CP to `$15`.

Several constants can be defined at once using CP.

```
· Inc CstName0 CstName1 ... CstNameN-1 ·
```

Defines N constants $CstName_x$ with a value of $CP+x*Inc$ and then changes the CP value to $CP+N*Inc$.

By default, Inc is a decimal number or an expression that can be immediately evaluated.

These features are extremely useful to define area of memory for storage of ASM program variables.

Note 1: If the entry point library (see related section) is installed on your calculator, all the values in the constant library will be available in your programs the same way than constants are.

Note 2: You can define a constant in your program to override the value of an entry in the equation library.

4.1.10 Expressions

An expression is a mathematical operation that is calculated at compilation time. Terms of this operation are hexadecimal or decimal values, constants or labels. An expression stops on a separation character or a ']'.

```
DCCP 5 @Data
D1=(5)@Data+#10/#2
D0=(5)$5+DUP
LC(5)"DUP"+#5
```

are correct expressions (provided that the entry point library is installed).

Notes:

- A hexadecimal value must begin with a \$.
- A decimal value may begin with a # or a number directly.
- A & or (<#>) equals the offset of the current instruction in the program (This value has no meaning in itself, but may be used to calculate the distance between a label and the current instruction). In absolute mode, this represents the final address of the instruction.
- The value of a label is the offset of the label in the program (This value has no meaning in itself, but may be used to calculate the distance between a label and the current instruction). In absolute mode, this represents the final address of the instruction.
- Entries from the EXTABLE may be used. As the EXTABLE does not have the label names limitations with operators, in ambiguous case (DUP+#5 may either be an addition $DUP + 5$, or an entry $DUP\#5$), add "" around the word: "DUP"+#5.
- Calculations are done with 64 bits.
- X divide by 0 = \$FFFFFFFFFFFFFFFF.
- In order to avoid wasting memory, MASD tries to compile expressions as soon as it sees them. If MASD is not able to compile an expression directly, it's compiled at the end of the compilation. In order to use less memory, it's a good idea to define your constants at the beginning of the sources so MASD can compile expression using the constants directly.
- The only operator symbols not allowed in labels are +, -, * and /; therefore, if you want to use a symbol operator after a label, you must put the symbol between " in order to 'limit' the symbol. Meaningless Example: "DUP"<<5.
- A label/constant with strange char may be 'protected' between " chars.
- The evaluation stack of MASD allows you to have around 10 pending computations (parenthesis, operator priority).
- MASD only works with integers. You can represent signed values using standard 2's complement, but be careful as all operators are unsigned.

MASD recognizes the following operators:

| Operator | Priority | Notes |
|----------|----------|---|
| << | 7 | Left Shift $1 \ll 5 = \$20$ |
| >> | 7 | Right shift $\$20 \gg 5 = 1$ |
| % | 6 | Modulo (remainder of division) $X \% 0 = 0$ |
| * | 5 | Multiplication |
| / | 5 | Division $X / 0 = \$FFFFFFFFFFFFFFFF$ |
| + | 4 | Addition |
| - | 4 | Subtraction |
| < | 3 | Is smaller (true=1, false = 0) |
| > | 3 | Is greater (true=1, false = 0) |
| <=, ≤ | 3 | Is smaller or equal (true=1, false = 0) |
| >=, ≥ | 3 | Is greater or equal (true=1, false = 0) |
| = | 3 | Is equal (true = 1, false = 0) |
| #, ≠ | 3 | Is different (true = 1, false = 0) |
| & | 2 | Logical and |
| ! | 1 | Logical or |
| ^ | 1 | Logical xor |

Note: throughout this documentation, you will see talks about expressions that can be “immediately” evaluated. This refers to any expression that contains only number and labels/constants that have already been declared.

4.1.11 Macros and includes

If data are to be included in a project, it can be entered in hex in a source file, using `$.` However, a simpler way is to include data from an external file, called a macro. The macro file must be a character string, a graphic, a code object or a list.

- In case of a string or a code, MASD includes only the data part (after the length) of the object
- In case of a graphic, only the graphic data will be included (no length, no dimensions)
- In case of a list, only the first object of the list will be included following the previous rules

The syntax in ASM or ARM mode is: `!FileName`

Note: To know how MASD looks for the FileName file, see the following section.

You can also include a complete object (prologue included) using `INCLUDE` or `INCLOB`. In ASM or ARM mode, use `INCLUDE` or `INCLOB` followed by a filename to include an object, in RPL mode, use `INCLOB`.

4.1.12 Filename conventions

MASD sometimes needs to find a file in the calculator’s memory. The file can be found either by specifying the file name and location, or only the file name to be search in the directory search list.

The initial directory search list contains the current directory, and all parents directory up to the HOME directory. You can add a directory in the directory search list using `!PATH+ RepName` where RepName identifies a directory name using filename rules.

To specify a full path, use

`H/` to specify HOMEDIR as the root.

`x/` where *x* is a port number, to specify a port as root. Note: you can not use 3 (SD card) here.

This root is followed by a list of directories, ending with the name of the file.

`2/FOO/BAR/BRA` specifies the BRA file in the BAR directory, stored in the FOO backup of the port 2.

`H/ME/YOU` specifies the YOU file in the ME directory, in the HOMEDIR.

Note: You can not have more than 16 entries in the directory search path.

4.1.13 Compilation directive

The following instruction modifies the way MASD reacts and compiles things. They are valid in all modes:

| | |
|----------------|---|
| !PATH+ DirName | Add the specified directory in the search path list. |
| !NO CODE | MASD will not generate a \$02DCC prologue but will directly output the data. If the generated file is not a valid object, an error will be generated. |
| !DBGON | MASD will generate code when DISP or DISPKEY are found in the source. |
| !DBGOFF | MASD will not generate code when DISP or DISPKEY are found in the source. |
| !1-16 | Switch to 1-16 mode. |
| !1-15 | Switch to 0-15 mode. |
| !RPL | Switch to RPL mode. |
| !ASM | Switch to ASM mode. |
| !ARM | Switch to ARM mode. |
| !FL=0.a | Clear the <i>a</i> compilation flag. |
| !FL=1.a | Set the <i>a</i> compilation flag. |
| !?FL=0.a | Compile the end of the line if flag <i>a</i> is set. |
| !?FL=1.a | Compile the end of the line if flag <i>a</i> is clear. |
| !ABSOLUTE Addr | Switch to absolute mode. The program begins at the address <i>Addr</i> . Note: MASD always considers the prolog \$02DCC and code length to be the beginning of the program even if !NO CODE is set. |
| !ABSADR Addr | If in absolute mode, add blank nibbles to continue at the specified address. If not possible, errors. |
| !EVEN | In absolute mode, cause an error if the directive is not on an even address. |
| !ADR | MASD will generate a source defining all constants and labels used in the program instead of the program. |
| !COMPEXP | Cause MASD to calculate all previous expressions. |
| !STAT | Display/update compilation statistics |
| !DBGINF | Causes MASD to generate debugging information (see next section for more information) |
| !JAZZ | See local variable documentation in RPL mode |
| !MASD | See local variable documentation in RPL mode |

4.1.13.1 The !DBGINF directive

If you put the !DBGINF directive into a MASD source, the assembler not only generates your compiled object, but it also returns a string (on level 1) full of debug information. The structure of this string is as follows:

5 DOCSTR

5 Length

5 Number of links (source files)

n*[

2 Number of characters

.. Name of link file

]

5 Number of symbols (labels and constants)

n*[

2 Number of characters

.. Name of symbol

1 Type: 9=Label 2=Constant
 for labels: 5 Address of label
 for constants: 16 Value of constant
]

5 Number of source->code associations
 n*[
 5 Offset in code (this list is sorted by offset)
 2 Number of link this instruction comes from
 5 Character offset in link where this instruction starts
]

Notes:

- If the source string is unnamed, i.e. in TEMPOB, the number of links is 00001 and the number of characters is 00, immediately followed by the symbol table.
- The label symbol table is supposed to be an *offset* table. However the current MASD may sometimes place *addresses* into this table. The “associations” table correctly contains offsets.

This instruction is intended for the case where someone decides to create a source level debugger.

4.2 Saturn ASM mode

This section is only applicable to the Saturn ASM mode.

4.2.1 CPU architecture

This section purpose is to make experienced ASM programmers familiar with the Saturn architecture, not to teach anyone to program in Saturn ASM.

The Saturn CPU has 12 main registers:

A, B, C, D, R0, R1, R2, R3 and R4 are 64 bits register (see description bellow),
 D0 and D1 are 20 bits pointers (you can only access memory through them, the Saturn is a little endian),
 PC, 20 bit program counter.

In addition, there are 16 flags ST0 to ST15 (12-15 being reserved for the system) 1 bit register accessible separately, a carry that is set when operation overflow or tests are validated and can be tested using the GOC (Go On Carry) and GONC (Go On No Carry) jump instruction, a decimal/hexadecimal mode (SETHEX and SETDEC) that affects the way + and – instructions on the A, B, C and D register works (default is HEX), and a 8 level return stack for GOSUBs (and RTN).

4.2.1.1 64 bits register

Most operations on 64 bits register will act on a specific “field”. A field is a division in a 64 bit register. If this represents the 16 nibbles of a 64 bit register, the fields cover the register as follows:

| | | | | | | | | | | | | | | | |
|---|---|---|---|----|---|---|---|---|---|---|---|---|----|---|---|
| F | E | D | C | B | A | 9 | 8 | 7 | 6 | 5 | 4 | 3 | 2 | 1 | 0 |
| | | | | P | | | | | | | | | | | |
| | | | | WP | | | | | | | | | | | |
| S | M | | | | | | | | | | | | XS | B | |
| | | | | | | | | | | | | | A | | |
| | | | | | | | | | | | | | X | | |

The P field location depends of the value of the 4 bit P register (ie: you can move it), and so does the WP field. Please look at the instruction set to see what instructions are available to the programmer.

I usually write “Rf” to indicate a register (uppercase) and a field (lowercase) as in \overline{Rf} .

In addition, in the new simulated Saturn architecture, 7 new fields F1 to F7 have been introduced.

You can define the field mask by using the SETFLD_n where n is a number between 1 and 7 to define the field F_n using the mask in C_w as in this example:

```
LC FF00000000000000FF SETFLD1
LA 123456789ABCDEF0
LC 0FEDCBA987654321
A=A!C.F1
```

A is now equal to:

```
1F3456789ABCDEF1
```

ie: the instruction on F fields equate to:

reg1= (reg1 & ~ mask) | ((reg1 & mask) operation (reg2 & mask))

These new fields are available for all instructions that previously used the so called 'P' encoding and includes the following instructions:

Reg=Reg&Reg.f, Reg=Reg!Reg.f, DATx=Reg.f, Reg=DATx.f, Reg=Reg+Cte.f, Reg=Reg-Cte.f, RegSRB.f, RReg=Reg.f, Reg=RReg.f and RegRRegEX.f.

4.2.1.2 Other notes

You should read documentations on the internal structure of RPL objects (www.hpcalc.org has good documentation) D0, D1, Ba and Da are used by the system (next RPL instruction pointer, RPL stack pointer (@@object on level 1 of the stack), start of free memory and free memory in 5 nibble blocks). The SAVE instruction will save these registers in dedicated memory areas, the LOADRPL instruction will restore them and continue the execution in the system.

Please consult documentation on memory map for more information.

4.2.1.3 New instructions

In addition to the F fields, the following new instructions have been created:

r=s.f, r=r+s.f, r=r-s.f, r=r*s.f, r=r/s.f, r=r%_s.f (modulo) r=-s-1.f (logical not), r=-s.f (mathematical not), r=r<s.f (left shift), r=r>s.f (right shift), r=r^s.f (logical xor).

r=1.f (alias for r=r/r.f) has also been created.

Note 1: any combination of the A, B, C and D registers can be used (notated r and s here)

Note 2: all field (including F1-F7 fields) are valid

Note 3: MASD will always choose the shortest version of the instruction (e.g.: A=A+B.A will use the standard C0 encoding AND affect the carry)

Note 4: the carry is not affected by these instructions.

The following other new instructions have been added (see description in the ASM syntax section):

| | | | |
|---------------|---------|--------|----------|
| NATIVE? \$hex | GOSLOW | REMON | CONFIGD |
| HST=1.x | WSCREEN | SERIAL | BIGAPP? |
| ?HST=1.x () | SETTIME | OUTBYT | RESETOS |
| SETFLD(1-7) | SETLNED | MOVEUP | REFRESHD |
| OFF | SETOFFD | MOVEDN | AUTOTEST |
| RPL2 | HSCREEN | ARMSYS | ACCESSSD |
| KEYDN | UNCNFGD | ARMSAT | PORTTAG? |
| CRTMP | GETTIME | REMOFF | MIDAPP? |
| BEEP2 | | | |

4.2.2 Skips

Skips are a first step from ML to a third generation language, even if they are only another way to write ASM instructions.

Skips are wonderful as they allow you to:

- structure your program
- avoid using gotos
- make programs and piece of code that can be easily copied and past (because there is no label)

The foundation of Skips is the Block structure.

A block is enclosed in { and }, and can be nested within another block.
 The following instructions deal with blocks.

| SKIPS instructions | Equivalents |
|-------------------------|---|
| { ... } | Defines a block (generates no code) |
| SKIP { ... } | GOTO .S ... *.S |
| SKIPL { ... } | GOTOL .S ... *.S |
| SKIPC { ... } | GOC .S ... *.S |
| SKC { ... } | GOC .S ... *.S |
| SKIPNC { ... } | GONC .S ... *.S |
| SKNC { ... } | GONC .S ... *.S |
| Test SKIPYES { ... } | Test GOYES .S ... *.S |
| Test { ... } | Test GOYES .S ... *.S |
| Test → { ... } | /Test GOYES .S ... *.S |
| Test → { ... } | /Test GOYES .S ... *.S |
| SKUB { ... } | GOSUB .S ... *.S |
| SKUBL { ... } | GOSUBL .S ... *.S |
| STRING { ... } | \$/02A2C GOIN5 *.S ... *.S (to create a character string) |
| CODE { ... } | \$/02DCC GOIN5 *.S ... *.S (to create a code object) |
| STROBJ \$PROLOG { ... } | \$(5)PROLOG GOIN5 .S ... *.S (to create a 'prolog - length' object) |

/Test is the opposite of Test. For example if Test is ?A<C.A, /Test is ?A>=C.A. The test instructions dealing with the hardware register (?HST=0, ?MP=0, ?SR=0, ?XM=0, ?SB=1, ?HST=1, ?MP=1, ?SR=1, ?XM=1 and ?SB=1) cannot be inverted.

Once blocks are defined, special instructions can be used in them. The instructions called EXIT and UP allow jumping to the end or to the beginning of a block.

| These instructions | are equivalent to |
|--------------------|--------------------|
| { | *.Beginning |
| EXIT | GOTO.End |
| EXITC | GOC.End |
| EXITNC | GONC.End |
| ?A=0.A EXIT | ?A=0.A *.End |
| UP | GOTO.Beginning |
| UPC | GOC.Beginning |
| UPNC | GONC.Beginning |
| ?A=0.A UP | ?A=0.A *.Beginning |
| } | *.End |

Note: in Saturn mode do not make confusion between EXIT and UP instructions, which are GOTOs, and EXIT and UP after a test, which are GOYES's. EXIT and UP can jump to the beginning or to the end of an upper-level block by specifying the number of blocks to exit, after the UP or EXIT instructions.

| These instructions | Are equivalent to |
|--------------------|-------------------|
| { | *.Beg3 |
| { | *.Beg2 |
| { | *.Beg1 |
| UP2 | GOTO.Beg2 |
| UP3 | GOTO.Beg3 |
| EXIT1 | GOTO.End1 |
| EXIT3 | GOTO.End3 |
| } | *.End1 |
| } | *.End2 |
| } | *.End3 |

Note 1: EXIT1 is equivalent to EXIT, and UP1 is equivalent to UP.

Note 2: the same rules apply in ARM mode: EXITGE3 for example is a BGE for the exit label 3 blocks down

Using SKELSE, SKEC, SKENC, SKLSE instructions, two blocks create an IFNOT-THEN-ELSE structure.

| These instructions | Are equivalent to | Or in high-level language |
|---|---|---|
| <pre>?A=0.A SKIP YES { EXIT UP } SKELSE { A+1.A EXIT UP }</pre> | <pre>?A=0.A GOYES.Beg2 *.Beg1 GOTO.End2 % and not End1 GOTO.Beg1 *.End1 GOTO.End2 *.Beg2 A+1.A GOTO.End2 GOTO.Beg2 *.End2</pre> | <pre>IF NOT A=0 THEN BEGIN ... END ELSE BEGIN END</pre> |

Note: SKELSE places a GOTO between the 2 blocks, SKEC places a GOC, SKENC a GONC and SKLSE places nothing.

Notes:

UPs are compiled directly when encountered while EXITS and block openings are compiled later on. You can not have more than 64 pending EXITS and block openings simultaneously.

4.2.3 Tests

A test instruction (`?A=0.A`) may be followed by:

- A `GOYES Label, → Label` or `-> Label` instruction
- A `-> {` or `→ {` instruction. In this case, the test is inverted and a skip block is open.
- A `RTY` or `RTNYES` instruction.
- A `SKIPYES {` or `{` instruction. In this case, a skip block is open.
- A `GOTO`, `GOTOL`, `GOVLNG`, `GOSUB`, `GOSUBL` or `GOSEVL`. In this case, the test is inverted and a proper jump instruction is generated (ie: `?A=B.A GOTO A` is compiled as `?A#B.A { GOTO A }`).
- A `EXIT` or `UP`.

4.2.4 Saturn instructions syntax

In this section:

x is a decimal number between 1 and 16. An expression can be used if its value can be determined at the first encounter.

b is a hexadecimal digit.

a is a decimal number ranging from 1 to 16 or a 0 to 15 number depending of the current mode (0-15 or 1-16). An expression can be used, if it's value can be determined at the first encounter.

f is a field A, B, X, XS, P, WP, M, S, F1, F2, F3, F4, F5, F6 or F7.

Reg is a working register A, B, C or D.

RReg is a scratch register R0, R1, R2, R3 or R4.

Exp is an expression.

Cst is a decimal constant. An expression can be used if its value can be determined at the first encounter.

DReg is a pointer register D0 or D1.

Data is memory data pointed by D0 or D1. It means `DAT0` or `DAT1`.

Note: For instructions that use two working registers, instruction using the pairs A-B, B-C, C-D and A-C are smaller and faster (if the `Fn` fields are not used).

For instructions like `Reg1=Reg1...` you can write only `Reg1...` Example: `A=A+C.A` is the same as `A+C.A`.

| Syntax | Example | Notes |
|--|---|--|
| Reg=0.f | A=0.M | Sets the specific field of the register to 0 |
| Reg=1.f | A=1.M | Sets the specific field of the register to 1 |
| LC hhh..hhh LA hhh..hhh | LC 80100 LA #1024 | The number of nibbles loaded in the register is the number of characters necessary to write the value. So LC #12 will be equivalent to LC 00C. Note: the less significant nibble is loaded in the nibble P (as in the value of the register P) of the register, the next one into nibble p+1 mod 16, and etcetera. |
| LCASC(x) chrs LAASC(x) chrs | LCASC(4) MASD LAASC(5) ROCKS | Loads the hexadecimal value of x characters into C. x must be between 1 and 8. See note on LC instruction |
| LC(x) Exp LA(x) Exp | LC(5)@Buf+Off | Loads the result of an expression into C or A, using x nibbles. See note on LC instruction |
| Reg1=Reg2.f | A=B.X | Copies the value of a specific field of a register into the same field of another register |
| Reg1Reg2EX.f | ABEX.W | Exchanges the value of 2 registers on the given field. Note: this is not valid for the F _n fields |
| Reg1=Reg1+Reg2.f Reg1+Reg2.f | A=A+B.A C+D.A | Adds the value of the specific field of one register to the other register. Note: If Reg1 and Reg2 are the same, this is a multiply by 2 instruction Note: This instruction is affected by the DEC/HEX mode only if the field is not a F field and the registers are AB, BC, CD or AC. |
| Reg1=Reg1-Reg2.f Reg1-Reg2.f | A=A-B.A C-D.A | The following instructions are also available (but not on the F _n fields): A=B-A.f B=C-B.f C=A-C.f D=C-D.f see note on Reg1=Reg1+Reg2.f |
| Reg=Reg+Cst.f Reg+Cst.f Reg=Reg-Cst.f Reg-Cst.f | A=A+10.A A+10.A A=A-10.A A-FOO.A | Note 1: The Saturn processor is not able to add a constant greater than 16 to a register. If cst is greater than 16, MASD will generate as many instructions as needed. Note 2: Even if adding constants to a register is very useful, large values should be avoided because this generates a large program. Prefer another solution like LC(5) Cte A+C.A Note 3: Adding a constant greater than 1 to a P, WP, XS or S field is a bugged Saturn instruction (problem with carry propagation). Use these instructions with care. Note 4: After adding a constant greater than 16 to a register, the carry should not be tested (because you do not know if the last generated instruction generated the carry or not) Note 5: You can put an expression instead of the constant (MASD must be able to evaluate the expression strait away). If the expression is negative, MASD will invert the addition in a subtraction and vice versa. Note 6: Be careful when using subtraction; it's easy to be misled. A-5-6.A is equivalent to A+1.A, not A-11.A because the instruction is: A-(5-6).A Note 7: If using F _n fields, be careful if non nibble bounded masks are used. |
| RegSR.f | ASR.W | Shift register right by 4 bit on the specified field, set SB if bits are lost. Note: this instruction is not available on the F _n fields |
| RegSL.f | ASL.W | Shift register left by 4 bit on the specified field, set carry if bits are lost. Note: this instruction is not available on the F _n fields |
| Reg1=Reg1<Reg2.f Reg1<Reg2.f | A=A<B.W | Shift register left by n bits (as defined by the value of Reg2) on the specified field |
| Reg1=Reg1>Reg2.f Reg1>Reg2.f | A=A>B.W | Shift register right by n bits (as defined by the value of Reg2) on the specified field |
| RegSRB.f | BSRB.X | Shift register right by 1 bit on the specified field, set SB if bits are lost. |
| RegSRC | ASRC | Circular right shift by 1 nibble |
| RegSLC | BSLC | Circular left shift by 1 nibble |
| Reg1=Reg1&Reg2.f Reg1&Reg2.f | A=A&B.X A&C.B | Logical and on the specified field |
| Reg1=Reg1!Reg2.f Reg1!Reg2.f | A=A!B.X A!C.B | Logical or on the specified field |

| Syntax | Example | Notes |
|---|---|---|
| Reg1=Reg1^Reg2.f Reg1^Reg2.f | A=A^B.X A^C.B | Logical xor on the specified field |
| Reg1=-Reg1.f | C=-C.A | Mathematical not on the specified field |
| Reg1=-Reg1-1.f Reg1=~Reg1.f | C=-C-1.A C=~C.A | Logical not on the specified field |
| RReg=Reg.f | R0=A.W | Sets the specified field of RReg to the value of the specified field of Reg. Only A and C are valid for Reg. If f is W, the shorter encoding of the instruction is used |
| Reg=RReg.f | A=R0.A | Sets the specified field of Reg to the value of the specified field of RReg. Only A and C are valid for Reg. If f is W, the shorter encoding of the instruction is used |
| RegRRegEX.f | AR0EX.A | Exchanged the value of the specified field of RReg with the value of the specified field of Reg. Only A and C are valid for Reg. If f is W, the shorter encoding of the instruction is used |
| Data=Reg.f Data=Reg.x | DAT1=C.A DAT0=A.10 | Write the content of the specified field of the specified register in the memory location pointed by Data register (POKE) Reg can only be A or C |
| Reg=Data.f RegData.x | C=DAT1.A A=DAT0.10 | Read the content of the memory location pointed by Data register in the specified field of the REG register (PEEK) Reg can only be A or C |
| DReg=hb DReg=hbbb DReg=hhbbb DReg=(2)Exp DReg=(4)Exp DReg=(5)Exp | D0=AD D0=0100 D0=80100 D0=(2)label D0=(4)lab+\$10 D1=(5)Variable | Change the first 2, 4 or all nibbles of the Data register with the given value |
| Dreg=Reg | D0=A | Reg can only be A or C |
| Dreg=RegS | D0=CS | Sets the first 4 nibbles of Dreg with the 4 first nibble of Reg Reg can only be A or C |
| RegDRegEX | AD0EX | Reg can only be A or C |
| RegDRegXS | AD1XS | Exchange the first 4 nibbles of Dreg with the 4 first nibble of Reg Reg can only be A or C |
| DReg=DReg+Cst DReg+Cst DReg=DReg-Cst DReg-Cst | D0=D0+12 D1+25 D1=D1-12 D1-5 | Note 1: The Saturn processor is not able to add a constant greater than 16 to a register but if <i>cst</i> is greater than 16, MASD will generate as many instructions as needed. Note 2: Even if adding constants to a register is very useful, big constants should be avoided because this will slow down execution, and generate a big program. Note 3: After adding a constant greater than 16, the carry should not be tested. Note 4: You can put an expression instead of the constant (MASD must be able to evaluate the expression strait away). If the expression is negative, MASD will invert the addition in a subtraction and vice versa. Note 5: Be careful when using subtraction; it's easy to be misled. D0-5-6.A is equivalent to D0+1.A, not D0-11.A |

Please read the section on test above for information on what MUST follow a test instruction.

f can NOT be a Fn field.

| | | |
|----------------------------|-----------------------------|---|
| ?Reg1=Reg2.f | ?A=C.B | |
| ?Reg1#Reg2.f | ?A#C.A | The HP special character can also be used |
| ?Reg=0.f | ?A=0.B | |
| ?Reg#0.f | ?A#0.A | The HP special character can also be used |
| ?Reg1<Reg2.f | ?A<B.X | |
| ?Reg1>Reg2.f | ?C>D.W | |
| ?Reg1<=Reg2.f | ?A<=B.X | The HP <= character can be used |
| ?Reg1>=Reg2.f | ?C>=D.W | The HP >= character can be used |
| ?RegBIT=0.a ?RegBIT=1.a | ?ABIT=0.5 ?ABIT=1.number | Test if a specific bit of A or C register is 0 or 1 Reg must be A or C |

| Syntax | Example | Notes |
|--------|---|--|
| | <pre>A=PC C=PC PC=A PC=C APCEX CPCEX PC=(A) PC=(C)</pre> | <p>Sets Aa or Ca to the address of the next instruction</p> <p>Set PC to the value contained in Aa or Ca</p> <p>Exchange the value of PC with register Aa or Ca</p> <p>Sets PC to the value read at the address contained in Aa or Ca</p> |
| | <pre>SB=0 XM=0 SR=0 MP=0 HST=0.a ?SB=0 ?XM=0 ?SR=0 ?MP=0 ?HST=0.a</pre> | <p>SB, XM, SR and MP are 4 bits in the HST register. They can be set to 0 by the specific instruction and tested.</p> <p>SB is set to 1 by RegSR and RegSRB instruction, XM by RTNSXM instruction and SR and MP should always be 0 (hardware related stuff).</p> <p>HST=a sets all bits set to 1 in a to 0 in the HST register.</p> <p>?HST=a test that all bits set to 1 in a are 0 in the HST register</p> |
| | <pre>SB=1 XM=1 SR=1 MP=1 HST=a ?SB=1 ?XM=1 ?SR=1 ?MP=1 ?HST=1.a</pre> | <p>See above. This is only valid in emulated Saturn</p> |
| | <pre>P=a P=P+1 P+1 P=P-1 P-1 ?P=a ?P#a P=C.a C=P.a CPEX.a C=C+P+1 C+P+1</pre> | <p>The HP special character can be used instead of #</p> |
| | <pre>GOTO label GOTOL label GOLONG Lab GOVLNG hex GOVLNG =Label GOVLNG ="COMND" GOSUB label GOSUBL label GOSBVL hex GOSBVL =Label GOSBVL ="COMND" GOC label GONC label GOTOC label GOTONC label</pre> | <p>GOTO is limited to 1kb jumps</p> <p>GOTOL can jump over 16KB of code</p> <p>this jump to a specific address</p> <p>GOSUB is limited to 1kb jumps</p> <p>GOSUBL is limited to &6kb jumps</p> <p>GOSBVL jumps to a specific address</p> <p>GO if Carry set (limited to 64byte)</p> <p>GO if no carry (limited to 64 bytes)</p> <p>Equivalent to SKNC { GOTO label }</p> <p>Equivalent to SKC { GOTO label }</p> |
| | <pre>RTN RTNSXM RTNCC RTNSC RTNC RTNNC RTI RTNYES RTY</pre> | <p>Return from subroutine (GOSUB call)</p> <p>RTN + XM=1</p> <p>RTN + set carry</p> <p>RTN + clear carry</p> <p>RTN if carry set</p> <p>RTN if carry not set</p> <p>Return from interrupt</p> <p>Return if test true (see test section)</p> |
| | <pre>C=RSTK RSTK=C</pre> | <p>Pop value from RSTK in Ca</p> <p>Push value from Ca in RSTK</p> |
| | <pre>OUT=CS OUT=C A=IN C=IN</pre> | <p>Set the first 2 nibbles of the OUT register to the value of Cb</p> <p>Set the OUT register to the value of C4</p> <p>Copy the IN register in Ax or Cx (bugged instruction, do not use if you do not know what you are doing)</p> |

| Syntax | Example | Notes |
|--------|--|--|
| | SETDEC SETHEX UNCNGF CONFIG RESET SHUTDN INTON INTOFF RSI | Set the SPU in DECIMAL or HEXADECIMAL mode Deconfigure/Configure memory modules Deconfigure ALL memory modules STOP the CPU waiting for an interrupt Enable/disable keyboard interrupts Reset interrupt system |
| | GOINC <i>label</i> | Equivalent to LC(5) <i>label</i> -&. (& is the address of the instruction) |
| | GOINA <i>label</i> | Equivalent to LA(5) <i>label</i> -&. (& is the address of the instruction) |
| | <i>hhh...hhh</i> NIBHEX <i>hhh...hh</i> | Includes hexadecimal data in the program. Example: \$12ACD545680B. |
| | <i>h/hhh...hhh</i> | Includes hexadecimal data in reverse order. Example: <i>h/123ABC</i> is equivalent to \$CBA321. |
| | \$(<i>x</i>) <i>Exp</i> CON(<i>x</i>) <i>Exp</i> EXP(<i>x</i>) <i>Exp</i> | Places the value of <i>Exp</i> in the code, on <i>x</i> nibbles. |
| | <i>Ascii</i> "Ascii" | Includes ASCII data. The end of the string is the next <i>¢</i> or carriage return. Example: <i>¢Hello¢</i> . To output a <i>¢</i> character, put it twice. To put an char from its number, use <i>\xx</i> where <i>xx</i> is an hex number. To put a <i>\</i> , put the <i>\</i> chr twice. |
| | GOIN5 <i>lab</i> G5 <i>lab</i> GOIN4 <i>lab</i> G4 <i>lab</i> GOIN3 <i>lab</i> G3 <i>lab</i> GOIN2 <i>lab</i> G2 <i>lab</i> | Same as \$(<i>x</i>) <i>label</i> -& with <i>x</i> =5, 4, 3 or 2. Useful to create a jump table. |
| | SAVE | Equivalent to GOSBVL SAVPTR |
| | LOAD | Equivalent to GOSBVL GETPTR |
| | RPL or LOOP | Equivalent to A=DAT0.A D0+5 PC=(A) |
| | LOADRPL | Equivalent to GOVLNG GETPTRLOOP |
| | INTOFF2 | Equivalent to GOSBVL DisableIntr |
| | INTON2 | Equivalent to GOSBVL AllowIntr |
| | ERROR_C | Equivalent to GOSBVL ErrjmpC |
| | A=IN2 | Equivalent to GOSBVL AINRTN |
| | C=IN2 | Equivalent to GOSBVL CINRTN |
| | OUT=C=IN | Equivalent to GOSBVL OUTCINRTN |
| | RES.STR | Equivalent to GOSBVL MAKE#N |
| | RES.ROOM | Equivalent to GOSBVL GETTEMP |
| | RESRAM | Equivalent to GOSBVL MAKERAM# |
| | SHRINK# | Equivalent to GOSBVL SHRINK# |
| | COPY← COPY← COPYDN | Equivalent to GOSBVL MOVEDOWN |
| | COPY→ COPY→ COPYUP | Equivalent to GOSBVL MOVEUP |
| | DISP | Equivalent to GOSBVL DEBUG (only if debug is on) |
| | DISPKEY | Equivalent to GOSBVL DEBUG.KEY (only if debug is on) |
| | SRKLST | Equivalent to GOSBVL SHRINKLIST |
| | SCREEN | Equivalent to GOSBVL D0→Row1 |
| | MENU | Equivalent to GOSBVL D0→Sft1 |
| | ZEROMEM | Equivalent to GOSBVL WIPEOUT |
| | MULT.A | Equivalent to GOSBVL MULTBAC |
| | MULT | Equivalent to GOSBVL MPY |
| | DIV.A | Equivalent to GOSBVL IntDiv |
| | DIV | Equivalent to GOSBVL IDIV |
| | BEEP | Equivalent to GOSBVL makebeep |
| | NATIVE? \$hex | Set carry if native function <i>xx</i> is undefined, clear it if defined. |

| Syntax | Example | Notes |
|--------|--------------|--|
| | HST=1.x | Sets bits in the HST register (XM=1, SB=1, SR=1 and MP=1 are also available). Note: the program ST=0.0 SB=1 ?SB=0 { ST=1.0 } will set ST0 to 0 if the calculator is non-emulated and to 1 if it is emulated. |
| | ?HST=1.x { } | Test for HST bits. See HST=1.x comments |
| | SETFLD(1-7) | See section 5.2.1 |
| | OFF | Turns the calculator off. |
| | RPL2 | Simulates a LOOP (A=DAT0.A D0+5 PC=(A)). |
| | KEYDN | (C[A]) kbd peeks with immediate rtn CS if keydn. Also - Sets DOUSEALARM flag if [ON][9] sequence. Entry: P=0, HEX Mode, C[A]: #kbd peeks (loop count) |
| | CRTMP | Abstract: Creates a hole in the tempob area of the specified size + 6 (5 for the link field and 1 for marker nibble). Sets the link field of the "hole" to size+6 and adjusts AVMEM, RSKTOP and TEMPTOP. Entry Conditions: RPL variables in system RAM C(A) contains desired size of hole Exit Conditions: carry clear, RPL variables in system RAM D1 -> link field of hole, D0 -> object position B(A), C(A)= desired size+6 Error Exits: Returns with carry set when there's not enough memory to create a hole of size+6. |
| | BEEP2 | Entry: C[A]: d ;d=Beep duration (msec) D[A]: f ;f=Beep frequency (hz) P=0 Exit: CARRY:0 |
| | REMON | Enables the remote control mode (ON+R). |
| | SERIAL | Copy serial number to address pointed to by D1 in Saturn memory. |
| | OUTBYT | Purpose: Send byte to IR printer Entry: A[B]: Byte Exit: CC, P=0, Byte Sent Alters: P:0, CARRY:0, SETHEX. |
| | MOVEUP | Abstract: Used to move block of memory to higher address. No check is made to ensure that the source and destination do not overlap. Code is moved from high to low addresses. Entry Conditions: D0 -> end of source + 1 D1 -> end of destination + 1 C(A) = number of nibs to move (unsigned) Exit Conditions: HEX mode, P=0, carry clear D0 -> start of source D1 -> start of destination |
| | MOVEDN | Abstract: Used to move block of memory to lower address. No check is made to ensure that the source and destination do not overlap. Code is moved from lower to higher addresses. Entry Conditions: D0 -> start of source; D1 -> start of destination; C(A) = number of nibs to move (unsigned) Exit Conditions: P=0, carry clear; D0 -> end of source + 1; D1 -> end of destination + 1 |
| | ARMSYS | Call a function at global dword address C[0-7]&~3. The function takes should be of the form: U32 f(U32 pc, Chipset* c) { /* put your code here */ return pc; } |
| | ARMSAT | Call a function at Saturn address C.A&~7. The function should have the following format: U32 f(U32 pc, Chipset* c) { /* put your code here */ return pc; } In RAM asm, this means that as you enter the function, pc is in R0, @Chipset is in R1 and the return address is in LP. R2 and R3 are free to use, and R0 should normally not be modified except if you want to change the PC when exiting the function. |

| Syntax | Example | Notes |
|--------|----------|--|
| | REMOFF | Stops the remote control (ON+S). |
| | GOSLOW | Wait for (C[A]/183) ms. |
| | WSCREEN | Return how many columns the screen contains in Ca |
| | SETTIME | Sets the RTC time from C[W] in ticks. |
| | SETLINED | Set number of lines of disp0 from C[B], refresh display. |
| | SETOFFD | Set offset of display inside disp0 in bytes from C[X]&7FF. |
| | HSCREEN | Return how many lines the screen contains. In Ca |
| | UNCNFGD | Unconfigure the 4KB block containing the top 16-line header. This will refresh the header on the display. |
| | GETTIME | Emulates gettimeofday function in ROM, and also updates the 8192Hz timer accordingly. Purpose: Get current time: (=NEXTIRQ)-Timer2 Return CS iff time appears corrupt. Entry: Timer2 Running Exit: Timer2 Running CC - A:NEXTIRQ (ticks) C:Time (ticks) D:Timer2 (sgn extended ticks) P:0, HEX CS - Same as the non-error case but the time system is corrupt because of one of: (1) TIMESUM # CRC(NEXTIRQ) -- CheckSum Error (2) TIMER2 was not running on entry. (3) Time not in range: [BegofTime, EndofTime] |
| | MIDAPP? | Carry=1 on HP48, 0 otherwise. |
| | CONFIGD | Configure a 4KB block containing the top 16-line header. C.A = Start address of the block (must be multiple of 4KB). If already configured, unconfig, refresh and re-config. |
| | BIGAPP? | Carry=1 on HP49, 0 otherwise. |
| | RESETOS | Reset the calculator (including the OS). This code doesn't return, the calculator restarts at 00000000. |
| | REFRESHD | Force to refresh the header on the display. |
| | AUTOTEST | - 003AA: AUTO_USER_TEST - 003A3: MANU_USER_TEST - 0039C: MANUFACTURE_TEST - Other: signed index, OS-specific, see OS_API.doc. |
| | ACCESSSD | SD Card functions (depending on P, see HP's vgeraccess for more details). |
| | PORTTAG? | Return port number depending on tag name. Entry: D1: name (size+chars) Exit: A[A]: port number (0-3) D1: after name Carry: clear if ok, set if wrong name |

4.3 ARM mode

4.3.1 ARM architecture

For all user intents and purposes the ARM CPU has sixteen 32 bit registers noted R0 to R15 (R15 is also the program counter, R14 is the link register (ie: a BL (GOSUB) instruction copies the return address in R14 before jumping, a Return From Subroutine is performed by doing MOV PC, LR), and R13 is the Stack pointer).

Each instruction can be conditionally executed depending on the value of 5 flags.

Each instruction can be told to modify or not modify these 5 flags (add the S suffix to the instruction).

Please read the ARM ARM (ARM Architecture and Reference Manual) for more information.

Please look at the ARMSAT Saturn instruction and the ARM mode documentation to see the instruction set and the rules of calling ARM code from Saturn code.

4.3.2 Skips

Skips are a first step from ML to a third generation language, even if they are only another way to write ASM instructions.

Skips are wonderful as they allow you to:

- structure your program
- avoid using gotos
- make programs and piece of code that can be easily copied and past (because there is no label)

The foundation of Skips is the Block structure.

A block is enclosed in { and }, and can be nested within another block.

The following instructions deal with blocks.

| SKIPS instructions | Equivalents |
|--------------------|-------------------------------------|
| { ... } | Defines a block (generates no code) |
| SK<Cond> { ... } | B<cond> .S ... *.S |
| SKUB<Cond> { ... } | BL<cond> .S ... *.S |

Once blocks are defined, special instructions can be used in them. The instructions called EXIT and UP allow jumping to the end or to the beginning of a block.

| These instructions | are equivalent to |
|----------------------------------|--|
| { EXIT<Cond> UP<Cond> } | *.Beginning B<Cond> .End B<Cond> .Beginning *.End |

EXIT and UP can jump to the beginning or to the end of an upper-level block by specifying the number of blocks to exit, after the UP or EXIT instructions.

| These instructions | Are equivalent to |
|--|--|
| { { { UP<Cond>2 UP<Cond>3 EXIT<Cond>1 EXIT<Cond>3 } } } | *.Beg3 *.Beg2 *.Beg1 B<Cond> .Beg2 B<Cond> .Beg3 B<Cond> .End1 B<Cond> .End3 *.End1 *.End2 *.End3 |

Note 1: EXIT1 is equivalent to EXIT, and UP1 is equivalent to UP.

4.3.3 Instruction set

Note: for instruction names, the case does not matter.

Register names are:

R0, R1, R2, R3, R4, R5, R6, R7, R8, R9, R10, R11, R12, R13 (or SP), R14 (or LP or LR) and R15 (or PC).

Setting the S flag on an instruction causes the instruction to modify the flags.

Every instruction is evaluated ONLY if the attached condition is true. By default, the instruction is always evaluated.

Separation between arguments can be either ',' or spaces.

| Operation | Assembler | Action | S flags |
|-----------------|---|--|---------|
| Copy and shift | MOV{cond}(S) Rd, <Oprnd> | d:= <Oprnd> | NZCR |
| Not | MVN{cond}(S) Rd, <Oprnd> | d:= ~<Oprnd> | NZCR |
| Add | ADD{cond}(S) Rd, Rn, <Oprnd> | d:= Rn + <Oprnd> | NZCVR |
| Add w carry | ADC{cond}(S) Rd, Rn, <Oprnd> | d:= Rn + <Oprnd> + Carry | NZCVR |
| Sub | SUB{cond}(S) Rd, Rn, <Oprnd> | d:= Rn - <Oprnd> | NZCVR |
| Sub w carry | SBC{cond}(S) Rd, Rn, <Oprnd> | d:= Rn - <Oprnd> - Not(Carry) | NZCVR |
| Reverse Sub | RSB{cond}(S) Rd, Rn, <Oprnd> | d:= <Oprnd> - Rn | NZCVR |
| Rev sub w carry | RSC{cond}(S) Rd, Rn, <Oprnd> | d:= <Oprnd> - Rn - Not(Carry) | NZCVR |
| Multiply | MUL{cond}(S) Rd, Rm, Rs | d:= Rm * Rs | NZR |
| Multiply Add | MLA{cond}(S) Rd, Rm, Rs, Rn | d:= (Rm * Rs) + Rn | NZR |
| Compare | CMP{cond} Rd, <Oprnd> | flags:= Rn - <Oprnd> | NZCV |
| Cmp Negative | CMN{cond} Rd, <Oprnd> | flags:= Rn + <Oprnd> | NZCV |
| Test | TST{cond} Rn, <Oprnd> | flags:= Rn And <Oprnd> | NZC |
| Tst equivalence | TEQ{cond} Rn, <Oprnd> | flags:= Rn Xor <Oprnd> | NZC |
| And | AND{cond}(S) Rd, Rn, <Oprnd> | Rd:= Rn And <Oprnd> | NZC |
| Xor | EOR{cond}(S) Rd, Rn, <Oprnd> | Rd:= Rn Xor <Oprnd> | NZC |
| | XOR{cond}(S) Rd, Rn, <Oprnd> | Rd:= Rn Xor <Oprnd> | NZC |
| Or | ORR{cond}(S) Rd, Rn, <Oprnd> | Rd:= Rn Or <Oprnd> | NZC |
| BitClear (NAnd) | BIC{cond}(S) Rd, Rn, <Oprnd> | Rd:= Rn And Not <Oprnd> | NZC |
| Branch | B{cond} label | R15/PC:= address | |
| Gosub | BL{cond} label | R14:=R15/PC, R15/PC:= address | |
| Load Int | LDR{cond} Rd, <a_mode> LDR{cond} Rd, Label | Rd:= [address] Rd:= data at label. The label address is calculated relative to the PC. This does not work with constants | |
| Load Byte | LDR{cond}B Rd, <a_mode> LDRB{cond} Rd, Label | Rd:= [byte at address] 0 extended Rd:= data at label. The label address is calculated relative to the PC. This does not work with constants | |
| Multiple load | | Stack operations (Pop) | |
| Inc Before | LDM{cond}IB Rd(!), (reg list) | ! sets the W bit (updates the base | |
| Inc After | LDM{cond}IA Rd(!), (reg list) | register after the transfer) | |
| Dec Before | LDM{cond}DB Rd(!), (reg list) | | |
| Dec After | LDM{cond}DA Rd(!), (reg list) | | |
| Store Int | STR{cond} Rd, <a_mode> STR{cond} Rd, Label | [address]:= Rd data at label:= Rd. The label address is calculated relative to the PC. This does not work with constants | |
| Store Byte | STRB{cond} Rd, <a_mode> STRB{cond} Rd, Label | [address]:= byte value from Rd data at label:= Rd. The label address is calculated relative to the PC. This does not work with constants | |
| Multiple Store | | Stack operations (Push) | |
| Inc Before | STM{cond}IB Rd(!), (reg list) | ! Sets the W bit (updates the base | |
| Inc After | STM{cond}IA Rd(!), (reg list) | register after the transfer | |
| De Before | STM{cond}DB Rd(!), (reg list) | | |
| De After | STM{cond}DA Rd(!), (reg list) | | |
| multiplication | MUL rd, r1 r2 | rd=r1*r2 | |
| | MLA rd, r1, r2, r3 | rd=r1*r2+r3 | |
| | SMULL rd1, rd2, r1, r2 | Signed mul rd1=low r1*r2, rd2=high r1*r2 | |
| | SMLAL rd1, rd2, r1, r2 | Signed mul add rd1+=low r1*r2, rd2+=high r1*r2 | |
| | UMULL rd1, rd2, r1, r2 | rd1=low r1*r2, rd2=high r1*r2 | |
| | UMLAL rd1, rd2, r1, r2 | mul add rd1+=low r1*r2, rd2+=high r1*r2 | |
| *labelName | | Creates a label | |
| \$ | | See \$ in ASM mode | |
| €, † | | See ASM mode | |

Where cond can be any of:

| EQ | NE | CS HS | CC LO | MI | PL | VS | VC | HI | LS | GE | LT | GT | LE |
|-------|-----------|---------------------------|------------------|----------|---------------|----------|-------------|------------|----------------|----|----|----|----|
| equal | Non equal | Carry set, unsigned >= | Carry clear < | Negative | Positive or 0 | Overflow | No overflow | Unsigned > | Unsigned <= | <= | <= | < | <= |

Oprnd can be of the form:

| | |
|------------------------|--|
| Immediate value | Cte Note: cte is encoded on 8 bits + a rotation right encoded on 4 bits. This means that not every value is possible. |
| Logical shift left | Rm LSL Cte Rm < Cte |
| Logical shift right | Rm LSR Cte Rm > Cte |
| Arithmetic shift right | Rm ASR Cte Rm >> Cte |
| Rotate right | Rm ROR Cte Rm >>> Cte |
| Register | Rm |
| Logical shift left | Rm LSL Rs Rm < Rs |
| Logical shift right | Rm LSR Rs Rm > Rs |
| Arithmetic shift right | Rm ASR Rs Rm >> Rs |
| Rotate right | Rm ROR Rs Rm >>> Rs |

In all cases, Cte must be a decimal value or an expression that can be evaluated immediately.

A_mode can be:

| | |
|--|--|
| [Rn +/-Cte] | Value of rn + or - constant |
| [Rn +/-Rm] | Value of rn + or - value of rm |
| [Rn +/-Rm LSL Cte] [Rn +/-Rm < Cte] | Value of rn + or - value of rm shifted left |
| [Rn +/-Rm LSR Cte] [Rn +/-Rm > Cte] | Value of rn + or - value of rm shifted right |
| [Rn +/-Rm ASR Cte] [Rn +/-Rm >> Cte] | Value of rn + or - value of rm shifted arithmetically right |
| [Rn +/-Rm ROR Cte] [Rn +/-Rm >>> Cte] | Value of rn + or - value of rm rotated right |
| [Rn +/-Cte]! | Value of rn + or - constant Rn is updated with that value |
| [Rn +/-Rm]! | Value of rn + or - value of rm Rn is updated with that value |
| [Rn +/-Rm LSL Cte]! [Rn +/-Rm < Cte]! | Value of rn + or - value of rm shifted left Rn is updated with that value |
| [Rn +/-Rm LSR Cte]! [Rn +/-Rm > Cte]! | Value of rn + or - value of rm shifted right Rn is updated with that value |
| [Rn +/-Rm ASR Cte]! [Rn +/-Rm >> Cte]! | Value of rn + or - value of rm shifted arithmetically right Rn is updated with that value |
| [Rn +/-Rm ROR Cte]! [Rn +/-Rm >>> Cte]! | Value of rn + or - value of rm rotated right Rn is updated with that value |

| | |
|--|--|
| [Rn] +/-Cte | The value used is the value of rn, but rn is then updated with Value of rn + or – constant |
| [Rn] +/-Rm | The value used is the value of rn, but rn is then updated with Value of rn + or – value of rm |
| [Rn] +/-Rm LSL Cte [Rn] +/-Rm < Cte | The value used is the value of rn, but rn is then updated with Value of rn + or – value of rm shifted left |
| [Rn] +/-Rm LSR Cte [Rn] +/-Rm > Cte | The value used is the value of rn, but rn is then updated with Value of rn + or – value of rm shifted right |
| [Rn] +/-Rm ASR Cte [Rn] +/-Rm >> Cte | The value used is the value of rn, but rn is then updated with Value of rn + or – value of rm shifted arithmetically right |
| [Rn] +/-Rm ROR Cte [Rn] +/-Rm >>> Cte | Value of rn + or – value of rm rotated right Rn is updated with that value |

4.3.4 ARMSAT instruction

When using the ARMSAT instruction, the Saturn pc is in register r0 and the address chipset structure that contains the state of the Saturn CPU is in r1.

That structure has the following elements at the following offsets:

| | |
|------|--|
| 0 | P_U32 read_map[256+1]; read_map[x] points on the 2Kb of Saturn address space at Saturn address x<<12 |
| 1028 | P_U32 write_map[256+1]; read_map[x] points on the 2Kb of Saturn address space at Saturn address x<<12 for write purpose (write_map[x]=0 if x points on some non readable memory) |
| 2056 | enum ModulePriority top_map[256+1]; // Type of block on top, to know if new configured block takes over |
| 2316 | REG A; |
| 2324 | REG B; |
| 2332 | REG C; |
| 2340 | REG D; |
| 2348 | REG R0; |
| 2356 | REG R1; |
| 2364 | REG R2; |
| 2372 | REG R3; |
| 2380 | REG R4; |
| 2388 | U32 D0 |
| 2392 | U32 D1; |
| 2396 | U32 P, P4, P4_32; // P4 = 4*P, P4_32 = 4*P-32, use setP() to modify P. |
| 2408 | U32 ST; |
| 2412 | U32 HST; |
| 2416 | U32 carry; // 0 or !0 |
| 3420 | BOOL dec; // 0->hex or 1->dec |
| | U32 RSTK[NB_RSTK]; |
| | U32 RSTK_i; // Index for next push. |
| | REG FIELD[32]; // Field masks. |
| | U32 FIELD_START[32]; // Lowest nibble of the field. |
| | U32 FIELD_LENGTH[32]; // Length of the field. |

Therefore, LDR R2 [R1 2316] allows you to read the lower 32 bits of the Saturn register A.

```
LDR R2 [R1 1]
LDR R3 [R2 1]
```

allows you to read the first 8 nibbles at Saturn address 01008

The following file can be used to declare your Saturn chipset structure.

```
" IASM
CP=0
DCCP #1028 SREAD
DCCP #1028 SWRITE
DCCP #260 SPRIORITY
```

```

DCCP 8 SRA
DCCP 8 SRB
DCCP 8 SRC
DCCP 8 SRD
DCCP 8 SR0
DCCP 8 SR1
DCCP 8 SR2
DCCP 8 SR3
DCCP 8 SR4
DCCP 4 SD0
DCCP 4 SD1
DCCP 4 SRP
DCCP 4 SRP4
DCCP 4 SRP32
DCCP 4 SST
DCCP 4 SHST
DCCP 4 SCARRY
DCCP 4 SDEC
DCCP #32 SRSCK
DCCP 4 SRSTKP
DCCP #256 SFMASK
DCCP #128 SFSTART
DCCP #128 SFLENGTH
@"

```

4.4 System RPL mode

MASD can also compile SysRPL programs (you should read the book “An Introduction to System RPL” before trying to write System RPL programs).

The `!RPL` directive will switch MASD in RPL mode.

Note: if the Flag `-92` is Set, MASD starts in `!RPL` and `!NO CODE` mode.

4.4.1 Instructions

In RPL mode, MASD interprets instructions/tokens in the following order.

Reals and system binary

If the instruction is a decimal number, a system binary is created (MASD will try, if possible, to use the internally defined system binary). If that number has a decimal point (in the middle, or starts with the decimal point), a real number is created.

Unnamed local variables

If the instruction is a recall or a set of a local variable defined by `{ {` the correct instruction is generated.

A local environment is created using:

```
{ { var1 var2 ... varN } } with N<23
```

These variables have names during compile time, but they are implemented as unnamed local variables, which are faster to access than named local variables.

A local variable is recalled by typing its name or with an optional ending `@`.

Data can be stored in a local variable by typing its name, with a leading or ending `!` or a leading `=`.

Note 1: Local variables are available until the next local definition.

Note 2: The local environment is not closed automatically, use `ÆEND` or other provided words.

Example:

```
{ { label1 label2 .. labelN } } will become:
```

```
' NULLLAM <#N> NDUPN DOBIND (or 1LAMBIND if there is only one variable)
```

And:

```
label1 → 1GETLAM
label1@ → 1GETLAM
=label1 → 1PUTLAM
!label1 → 1PUTLAM
label1! → 1PUTLAM
```

Program example

| | |
|---|---|
| <pre> :: (< A B >) B A! ABND ; </pre> | <pre> :: ' NULLLAM TWO NDUPN DOBIND 2GETLAM 1PUTLAM ABND ; </pre> |
|---|---|

Note that it is your responsibility to destroy the local environment using ABND and that MASD does not handle multiple level of definition of local variables, nor it is destroying the current environment, even if ABND is used. Variables defined this way will be valid until a new set of variables are defined.

Defines

If the instruction matches a define, the correct code is inserted (see the DEFINE instruction)

Labels

If the instruction matches the name of a constant or a label, the value of the said constant or label is inserted (if you insert a label, be sure to know what you are doing and to be in absolute mode).

extable

If the instruction matches an entry in the extable (see appropriate section at the end of this document) the value associated with this entry is used.

DUP Will produce 88130

Note: Using an external table is much faster than using constants. On the other hand, constants are project dependent, which is not the case of an external table.

Tokens

Then, the following instructions are tested:

| | |
|--------------------|--|
| :: | Program prologue \$02D9D |
| ; or END | List, Program or Algebraic end \$0312B |
| { | List prologue \$02A74 |
| } | List end \$0312B |
| MATRIX | Algebraic matrix object |
| SYMBOLIC | Algebraic prologue \$02AB8 |
| UNIT | Unit prolog \$02ADA |
| FPTR2 ^constant | flash pointer from constant |
| FPTR bank value | flash pointer from value |
| # cst | System Binary of <i>cst</i> value, given in hexadecimal. If there is no spaces between the # and the <i>cst</i> , MASD will try, if possible to use the internally defined system binary |
| PTR cst | Address. FTR 4E2CF generates FC2E4. |
| ACPTR cst1 cst2 | Extended pointer with given hexadecimal values for the address and switch address |
| ROMPTR2 ~xlib_name | XLIB object from constant |
| ROMPTR LibN ObjN | XLIB object from value |
| % real | Real number |
| %% real | Long real number |
| C% real1 real2 | Complex number |
| C%% real1 real2 | Long complex number |
| "..." | Character string. Special characters can be included by typing \ and the ASCII value on two hexadecimal characters. \ can be inserted by typing \\ |
| ZINT decimalvalue | Integer |
| ID name | Global name (see " for info on character encoding) |
| LAM name | Local name (see " for info on character encoding) |
| TAG chrs | Tagged object |

| | |
|---|---|
| <code>×libName</code> | XLIB identified by its name. If it is a standard HP49 command (like <code>×DUP</code>), the address is used instead of an XLIB object. |
| <code>HXS Size Data</code> | Binary integer (<code>\$02A4E</code>), Size is in hexadecimal and Data is a set of hexadecimal characters. Example: <code>HXS 5 FFA21</code> |
| <code>GROB Size Data</code> | <code>GROB</code> (<code>\$02B1E</code>). |
| <code>LIBDAT Size Data</code> | Library data (<code>\$02B88</code>). |
| <code>BAK Size Data</code> | Backup (<code>\$02B62</code>). |
| <code>LIB Size Data</code> | Library (<code>\$02B40</code>). |
| <code>EXT3 Size Data</code> | Extended3 (<code>\$02BEE</code>). |
| <code>ARRAY Size Data</code> | Array (<code>\$029E8</code>). |
| <code>LNKARRAY Size Data</code> | Linked Array (<code>\$02A0A</code>). |
| <code>MINIFON Size Data</code> | Minifont object |
| <code>ARRY2 Size Data</code> | Array object |
| <code>ARRY [...]</code> <code>ARRY [[.] [.]]</code> | Array object, which can have 1 or 2 dimensions. All objects in the array must be of same type |
| <code>×RplName</code> | If <code>RplName</code> is a RPL instruction, compiles the RPL instruction (or <code>xlib</code> depending) |
| <code>CHR character</code> | Character object. See rules on " for more information |
| <code>LABEL labelname</code> | Creates a label at this position. Use carefully |
| <code>EXTERNAL name xlib name</code> | Equivalent to <code>DEFINE name ROMPTR2 xlibname</code> |
| <code>FEXTERNAL name fptr rname</code> | Equivalent to <code>DEFINE name FPTR2 fptrname</code> |
| <code>CODE Size Data</code> | Code object (<code>\$02DCC</code>). |
| <code>CODE</code> <code>Assembly stuff</code> <code>ENDCODE</code> | Include a code object, change to ASM mode and closed the code object on the next <code>ENDCODE</code> . |
| <code>NIBB Size Data or</code> <code>NIBHEX Data or</code> <code>NIBBHEX Data or</code> <code>CON(Size) Expr</code> | Includes directly hexadecimal data (no prolog). |
| <code>INCL0B FileName</code> | Includes the content of the file <i>FileName</i> . |
| <code>INCLUDE FileName</code> | Includes the source of the file <i>FileName</i> to be compiled (Like ' in ASM mode). |
| <code>LABEL label</code> | Defines a label (like * in ASM mode). |
| <code>EQU CstName ExpHex</code> | Defines a constant (Like <code>DC</code> in ASM mode). |
| <code>EQUCP Interleave C stName</code> | Defines a constant (Like <code>DCCP</code> in ASM mode). |
| <code>DEFINE name ...</code> | Associate the data compiled between the name and the end of the line with the name. After that, if the name is used again, the associated data is placed in the compiled file |
| <code>DIR</code> <code>VARNAME name1 obj1</code> <code>VARNAME name2 obj2</code> <code>...</code> <code>ENDDIR</code> | Creates a directory containing the objects in the given variables. |

4.5 Examples of program using the MASD compiler

```

"!NO CODE !RPL
* This program display a 131*64 graphic in a pretty way :-)
* DO LCD->, run it, and enjoy!
* This program has been created by Philippe Pamart
::
* remove the menu and test for a grob
CK1&Dispatch grob
::
TURNMENUOFF
CODE

% R0a: X
% R1a: Y
% R2a: @ grob

```

```

SAVE GOSBVL DisableIntr          % No interrupts
A=DAT1.A D0=A LC 00014 A+C.A R2=A.A % adr 1st pixels of the grob
D0+10 A=0.W A=DAT0.10 C=0.W LC 8300040 ?A=C.W % test the size
( *.End GOSBVL AllowIntr LOADRPL ) % if not ok, return to RPL

GOSBVL "D0->Row1" D1=A D0-15 C=DAT0.A C-15.A GOSBVL WIPEOUT % erase screen
LC 0003F R1=C.W % initial position in Z

(
LC 00082 % we are ready to scan right to left
(
R0=C.A % save the counter
LC 001 GOSBVL OUTCINRTN ?CBIT=1.6 -> .End % If backspace, then stop
GOSUB .PointAndLine % test the current point
C=R0.A C-1.A UPNC % go one pixel on the right
)
A=R1.W A-1.A R1=A.A % go one line higher
( % ready to scan from right to left
LC 001 GOSBVL OUTCINRTN ?CBIT=1.6 -> .End % If backspace, then stop
GOSUB .PointAndLine % test the current point
A=R0.A A+1.A R0=A.A LC 83 ?A#C.B UP % go one pixel on the left
)
A=R1.A A-1.A R1=A.A UPNC % go one line higher (if not finish)
)
GOTO .End

*.PointAndLine % This tests the current pix, returns
% if the pixel is white, draw a line
% if it is black
A=R1.A A+A.A C=R2.A C+A.A ASL.A A+C.A % Aa: @ line of pixel in the grob
C=R0.A P=C.0 CSR.B.A CSR.B.A A+C.A D0=A % D0: point on the pixel to test,
% P = number of the pixel to test in
% nibble (in Z/4Z)
LC 2481248124812481 P=0 % Cp: pixel mask
A=DAT0.B A&C.P ?A=0.P RTY % test the pixel. if white, return
GOSUB LIGNE GOSUB LIGNE % else, draw line twice in Xor mode
GOSBVL "D0->Row1" D0-20 % and draw the pixel in black.
A=R0.A C=R1.A GOVLNG aPixonB

*LIGNE
GOSBVL "D0->Row1" D0-20 % D0 point on the screen
A=R0.A B=A.A LA 00041 % A/B: X coordinates
C=R1.A D=C.A C=0.A % C/D: Y coordinates
GOVLNG aLineXor % draw the line!

ENDCODE
:
:
@

"!NO CODE !RPL ( turn into RPL mode)
: ( open a RPL program )
TURNMENUOFF ( remove the menu line )

CODE % open an assembly program

% this program takes control of the screen and
% display a mandelbrot set using the standard algorithm
% ie: for each point from x=-1.5 to 0.5,
% for each point from y=-1 to 1
% if any an, n<256 in the serie
% a0=x+iy (complex number), an+1=a0+an^2
% has an absolute value > 2, the point is not part of the set
% the numbers are stored on 32 bits.
% the numbers are shifted by 12 bits, the lower 12 bits representing

```

```

% the decimal part of the number (in 1/4096)

SAVE                                % save the RPL pointers
INTOFF                              % disable keyboard interrupts
SKUB (                               % jump over the ARM code
*start

!ARM                                % switch to ARM mode
STMDB sp! (R4 R5 R6 R7 R8 LP)      % save registers in the stack

LDR R2, [R1, #2324]                 % load R2=x (content of saturn
% reg B, nibbles 0-7)
LDR R3, [R1, #2340]                 % load R3=y (content of saturn
% reg B, nibbles 0-7)

MOV R7 R2                           % copy X in r7
MOV R8 R3                           % copy Y in r8
MOV R6 256                          % copy 256 in R6

(
  MUL R4, R2, R2                     % r4= x2 << 12
  MOV R4 R4 >> 12                   % r4= x2
  MUL R5, R3, R3                     % r5= y2
  MOV R5 R5 >> 12

  ADD LP R4 R5                       % LP = x2 + y2
  CMP LP #4000                       % if abs2 an > 4
  EXITGT                             % exit

  SUB R4 R4 R5                       % r4= x2-y2

  MUL R3 R2 R3                       % R3= X*Y

  ADD R2 R7 R4                       % r2= X + x2-y2 = new x

  MOV R3 R3 >> 11                   % r3= x*y*2
  ADD R3 R8 R3                       % r3= Y+2*x*y = new Y

  SUBS R6 R6 1                       % decrement loop counter
  UPNE                                % up if not 0

  % we have looped 256 times and abs(An)<2, the point is in the set!
  LDRB R6 [R1 2408]                 % clear the flag ST0
  BIC R6 R6 1
  STRB R6 [R1 2408]
  LDMIA sp! (R4 R5 R6 R7 R8 PC)    % restore all registers and return
)

% we have reached a An where abs(An)>2, the point is out of the set
LDRB R6 [R1 2408]                 % set the flag ST0
ORR R6 R6 1
STRB R6 [R1 2408]
LDMIA sp! (R4 R5 R6 R7 R8 PC)    % restore all registers and return

!ASM                                % back in ASM mode
#end
)
C=RSTK D0=C                        % D0 points to ARM instruction
D1=80100                           % D1 points at a place where
% I can copy the program
LC(5) end-start MOVEDN            % copy n nibbles

C=0.B SETLNE                        % hide the header

D1=8229E                            % point on 2Kb free memory
LC R9 A=0.W A-1.W ( DAT1=A.W D1+16 C-1.B UPNC ) % paint it in black
D0=00120 LC 8229E DAT0=C.A        % point the screen to that memory

```

```

D0=C                                % D0 points to that memory

LC FFFFFFFF D=C.W                    % D=Y=-1
LC 4F R3=C.B                          % loop 80 times
(
  C=0.W LC 1800 C=-C.W B=C.W % B=X=-1.5
  LC 82                                % loop 131 times
  A=0.S A+1.S                          % set bit 0 in As
  (
    RSTK=C                              % save loop counter in RSTK
    LC 80100 ARMSAT                      % evaluate the ARM code
    ?ST=0.0                              % if point is in the set, do nothing
    (
      C=DAT0.S C-A.S DAT0=C.S           % else, turn the pixel off
    )
  )

  A+A.S SKNC ( D0+1 A+1.S ) % next pixel

  C=0.W LC 40 B+C.W                    % increment X
  C=RSTK C-1.B UPNC                     % count down and loop
)
D0+2                                  % next graphic line
C=0.W LC 66 D+C.W                      % increment Y
C=R3.W C-1.B R3=C.W UPNC               % count down and loop
)
LC FF OUT=C ( C=IN2 ?C=0.B UP )        % wait for no key down
( C=IN2 ?C#0.B UP )                   % Wait for 1 key down
INTON                                  % restore the keyboard interrupt
LC 10 SETLND                            % restore the header size
SCREEN CD0EX D0=00120 DAT0=C.A        % restore the screen pointer
LOADRPL                                 % return to RPL
ENDCODE                                 ( end of ASM program )
;                                       ( end of RPL program )

@"

```

Section 5 – Disassemblers

ASM→

The ASM-> disassembler converts Saturn assembly into a source string.

The syntax used is MASD syntax, in mode 0-15.

Each line contains an address and an instruction.

If the system flag -71 is set (with **-71 SF**), addresses are not shown, except for the destinations of jumps. In this case, the resulting source may be then reassembled if needed.

ASM-> can either disassemble a CODE object or the memory area between 2 given addresses (as binary integer)

Example:

| -71 CF2 (default) | -71 SF2 |
|--------------------|--------------|
| AE734 GOSBVL 0679B | GOSBVL 0679B |
| AE73B LC 01000 | LC 01000 |
| AE742 C-A A | *AE742 |
| AE744 GONC AE742 | C-A A |
| AE747 GOVLNG 138B9 | GONC AE742 |
| | GOVLNG 138B9 |

| | | | |
|--|----------------------------|----|--|
| Level 2 | Level 1 | -> | Level 1 |
| Binary integer (start address of the memory area to disassemble) | Binary integer end address | -> | String (disassemble between the 2 address) |
| | Code object | -> | String |

ARM→

The ARM-> disassembler converts ARM assembly into a source string.

Each line contains an address and an instruction.

If the system flag -71 is set (with **-71 SF**), addresses are not shown, except for the destinations of jumps. In this case, the resulting source may be then reassembled if needed.

ARM-> can either disassemble a CODE object (which does not make much sense at this point in time) or the memory area between 2 given Saturn addresses (as binary integer).

Example:

| -71 CF2 (default) | -71 SF2 |
|--------------------------------------|--------------------------------|
| 874FF LDMGEIA R0 !{ R5 R6 R7 LP PC } | LDMGEIA R0 !{ R5 R6 R7 LP PC } |
| 87507 STMDB R5 { R5 R12 PC } | STMDB R5 { R5 R12 PC } |
| 8750F BL 87527 | BL 876E3 |
| 87517 BLGE 87527 | BLGE 876E3 |
| 8751F BGE 87527 | BGE 876E3 |
| 87527 ADD R0 R0 R0 | *876E3 |
| 8752F MOV R0 R1 | ADD R0 R0 R0 |
| 87537 TST R4 R5 | MOV R0 R1 |
| | TST R4 R5 |
| | @ |

| | | | |
|--|----------------------------|----|--|
| Level 2 | Level 1 | -> | Level 1 |
| Binary integer (start address of the memory area to disassemble) | Binary integer end address | -> | String (disassemble between the 2 address) |
| | Code object | -> | String |

Section 6 – The Entry Point Library: Extable

The entry point library is an external library (you can get it from the HP web site) that contains a table of entry point names and addresses. This is used by the MASD compiler to get the value of System RPL entry points or assembler constants (like TURNMENUOFF for example).

This library should be stored in port 0, 1 or 2. If you want to program in System RPL, you must install this library. This library also contains 4 functions:

nop

This function is here for internal purposes and should not be used. Running this function does nothing

GETNAME

Lookup for the name of an entry from its address.

Example: #054AFh GETNAME -> "INNERCOMP"

Note: as multiple entries might have the same address, GETNAME is not a bijective (one-to-one) function

Level 1 -> Level 1
Binary integer -> String

GETADR

Lookup for the address of an entry.

Example: "INNERCOMP" GETADR -> #054Afh

| | | |
|---------|----|----------------|
| Level 1 | -> | Level 1 |
| String | -> | Binary integer |

GETNAMES

Find all the entry whose name starts with a specific string.

Note: giving a null string as an input will return a list of all the entry points.

| | | |
|---------|----|----------------------|
| Level 1 | -> | Level 1 |
| String | -> | List of entry names. |

Error and Status Messages

The following table lists the most frequently encountered error and status messages on the hp49g+/hp48gII. They are arranged alphabetically by name. The second table lists all the built-in messages numerically by message number.

Messages Listed Alphabetically

| Message | Meaning | # (hex) |
|------------------------|--|-----------|
| Acknowledged | Alarm acknowledged. | 619 |
| All Variables known | No unknowns to solve for. | E405 |
| Autoscaling | Calculator is autoscaling x - and/or y -axis. | 610 |
| Awaiting Server Cmd. | Indicates Server mode active. | C0C |
| Bad Argument Type | One or more stack arguments were incorrect type for operation. | 202 |
| Bad Argument Value | Argument value out of operation's range. | 203 |
| Bad Guess(es) | Guess(es) supplied to HP Solve application or ROOT lie outside domain of equation. | A01 |
| Bad Packet Block check | Computed packet checksum doesn't match checksum in packet. | C01 |
| Can't Edit Null Char. | Attempted to edit a string containing character = (character code 0). | 102 |
| Circular Reference | Attempted to store a variable name into itself. | 129 |
| Connecting | Indicates verifying IR or serial connection. | C0A |
| Constant? | HP Solve application or ROOT returned same value at every sample point of current equation. | A02 |
| Copied to stack |  copied selected equation to stack. | 623 |





Messages Listed Alphabetically (continued)

| Message | Meaning | # (hex) |
|--|---|-----------|
| Current equation# | Identifies current equation. | 608 |
| Deleting Column | Matrix Writer application is deleting a row. | 504 |
| Deleting Row | Name of existing directory variable used as argument. | 503 |
| Directory Not Allowed | Name of existing directory variable used as argument. | 12A |
| Directory Recursion | Attempted to store a directory into itself. | 002 |
| Empty catalog | No data in current catalog (Equation, Statistics, Alarm) | 60D |
| Empty stack | The stack contains no data. | C15 |
| Enter alarm, press SET | Alarm entry prompt. | 61A |
| Enter eqn, press NEW | Store new equation in <i>EQ</i> . | 60A |
| Enter value (zoom out if >1), press ENTER | Zoom operations prompt. | 622 |
| EQ Invalid for MINIT | <i>EQ</i> must contain at least two equations (or programs) and two variables. | E403 |
| Extremum | Result returned by HP Solve application or ROOT is an extremum rather than a root. | A06 |
| HALT Not Allowed | A program containing HALT executed while MatrixWriter application, DRAW, or HP Solve application active. | 126 |
| Illegal During MROOT | Multiple-Equation Solver command attempted during MROOT execution. | E406 |
| Implicit () off | Implicit parentheses off. | 207 |
| Implicit () on | Implicit parentheses on. | 208 |
| Incomplete Subexpression | ◀, ▶ or ENTER pressed before all function arguments supplied. | 206 |

Messages Listed Alphabetically (continued)

| Message | Meaning | # (hex) |
|----------------------------|---|-----------|
| Inconsistent Units | Attempted unit conversion with incompatible units. | B02 |
| Infinite Result | Math exception: Calculation such as 1/0 infinite result. | 305 |
| Inserting Column | MatrixWriter application is inserting a column. | 506 |
| Inserting Row | MatrixWriter application is inserting a row. | 505 |
| Insufficient Memory | Not enough free memory to execute operation. | 001 |
| Insufficient Σ Data | A Statistics command was executed when Σ DATA did not contain enough data points for calculation. | 603 |
| Interrupted | The HP Solve application or ROOT was interrupted by <u>CANCEL</u> | A03 |
| Invalid Array Element | <u>ENTER</u> returned object of wrong type for current matrix. | 502 |
| Invalid Card Data | Machine does not recognize data on plug-in card | 008 |
| Invalid Date | Date argument not real number in correct format, or was out of range. | D01 |
| Invalid Definition | Incorrect structure of equation argument for DEFINE. | 12C |
| Invalid Dimension | Array argument had wrong dimensions. | 501 |
| Invalid EQ | Attempted operation from FCN menu when EQ did not contain algebraic, or, attempted DRAW with CONIC plot type when EQ did not contain algebraic. | 607 |
| Invalid IOPAR | IOPAR not a list, or one or more objects in list missing or invalid. | C12 |
| Invalid Mpar | Mpar variable not created by MINIT. | E401 |
| Invalid Name | Received illegal filename, or server asked to send illegal filename. | C17 |
| Invalid PPAR | PPAR not a list, or one or more objects in list missing or invalid. | 12E |

Messages Listed Alphabetically (continued)

| Message | Meaning | # (hex) |
|-------------------------------|---|-----------|
| Invalid PRTPAR | <i>PRTPAR</i> not a list, or one or more objects in list missing or invalid. | C13 |
| Invalid PTYPE | Plot type invalid for current equation. | 620 |
| Invalid Repeat | Alarm repeat interval out of range. | D03 |
| Invalid Server Cmd. | Invalid command received while in Server mode. | C08 |
| Invalid Syntax | hp49g+/hp48gII unable execute  , OBJ→, or STR→ due to invalid object syntax. | 106 |
| Invalid Time | Time argument not real number in correct format or out of range. | D02 |
| Invalid Unit | Unit operation attempted with invalid or undefined user unit. | B01 |
| Invalid User Function | Type or structure of object executed as user-defined function was incorrect. | 103 |
| Invalid Σ Data | Statistics command executed with invalid object stored in Σ DATA. | 601 |
| Invalid Σ Data LN(Neg) | Non-linear curve fit attempted when Σ DATA matrix contained a negative element. | 605 |
| Invalid Σ Data LN(0) | Non-linear curve fit attempted when Σ DATA matrix contained a 0 element. | 606 |
| Invalid Σ PAR | Σ PAR not list, or one or more objects in list missing or invalid. | 604 |
| LAST CMD Disabled |  CMD pressed while that recovery feature disabled. | 125 |
| LAST STACK Disabled |  UNDO pressed while that recovery feature disabled. | 124 |
| LASTARG Disabled |  ARG pressed while that recovery feature disabled. | 205 |
| Low Battery | System batteries too low to safely print or perform I/O. | C14 |
| Memory Clear | hp49g+/hp48gII memory was cleared. | 005 |

Messages Listed Alphabetically (continued)

| Message | Meaning | # (hex) |
|---------------------------------|--|-----------|
| Name Conflict | Execution of \int (where) attempted to assign value to variable of integration or summation index. | 13C |
| Name the equation, press ENTER | Name equation and store it in <i>EQ</i> . | 60B |
| Name the stat data, press ENTER | Name statistics data and store it in <i>ΣDAT</i> . | 621 |
| Negative Underflow | Math exception: Calculation returned negative, non-zero result greater than –MINR. | 302 |
| No Current Equation | Solver, DRAW, or RCEQ executed with nonexistent <i>EQ</i> . | 104 |
| No current equation. | Plot and HP Solve application status message. | 609 |
| No Room in Port | Insufficient free memory in the specified port. | 00B |
| No Room to Save Stack | Not enough free memory to save copy of the stack. LAST STACK is automatically disabled. | 101 |
| No Room to Show Stack | Stack objects displayed by type only due to low memory condition. | 131 |
| No stat data to plot | No data stored in <i>ΣDAT</i> . | 60F |
| Non-Empty Directory | Attempted to purge non-empty directory. | 12B |
| Non-Real Result | Execution of HP Solve application, ROOT, DRAW, or \int returned result other than real number or unit. | 12F |
| Nonexistent Alarm | Alarm list did not contain alarm specified by alarm command. | D04 |
| Nonexistent ΣDAT | Statistics command executed when <i>ΣDAT</i> did not exist. | 602 |
| Object In Use | Attempted PURGE or STO into a backup object when its stored object was in use. | 009 |
| Object Not in Port | Attempted to access a nonexistent backup object or library. | 00C |

Messages Listed Alphabetically (continued)

| Message | Meaning | # (hex) |
|------------------------|--|-----------|
| (OFF SCREEN) | Function value, root, extremum, or intersection was not visible in current display. | 61F |
| Out of Memory | One or more objects must be purged to continue calculator operation. | 135 |
| Overflow | Math exception: Calculation returned result greater in absolute value than MAXR. | 303 |
| Packet # | Indicates packet number during send or receive. | C10 |
| Parity Error | Received bytes' parity bit doesn't match current parity setting. | C05 |
| Plot Type: | Label introducing current plot type. | 61D |
| Port Closed | Possible I/R or serial hardware failure. Run self-test. | C09 |
| Port Not Available | Used a port command on an empty port, or one containing ROM instead of RAM. Attempted to execute a server command that itself uses the I/O port. | 00A |
| Positive Underflow | Math exception: Calculation returned positive, non-zero result less than MINR. | 301 |
| Power Lost | Calculator turned on following a power loss. Memory may have been corrupted. | 006 |
| Processing Command | Indicates processing of host command packet. | C11 |
| Protocol Error | Received a packet whose length was shorter than a null packet. Maximum packet length parameter from other machine is illegal. | C07 |
| Receive Buffer Overrun | Kermit: More than 255 bytes of retries sent before calculator received another packet. SRECV: Incoming data overflowed the buffer. | C04 |
| Receive Error | UART overrun of framing error. | C03 |
| Receiving | Identifies object name while receiving. | C0E |
| Retry # | Indicates number of retries while retrying packet exchange. | C0B |
| Select a model | Select statistics curve fitting model. | 614 |
| Select plot type | Select plot type. | 60C |

Messages Listed Alphabetically (continued)

| Message | Meaning | # (hex) |
|------------------------|--|-----------|
| Select repeat interval | Select alarm repeat interval. | 61B |
| Sending | Identifies object name while sending. | C0D |
| Sign Reversal | HP Solve application or ROOT unable to find point at which current equation evaluates to zero, but did find two neighboring points at which equation changed sign. | A05 |
| Single Equation | Only one equation supplied to Multiple-Equation Solver. Use HP Solve application. | E402 |
| Timeout | Printing to serial port: Received XOFF and timed out waiting for XON. | C02 |
| Too Few Arguments | Command required more arguments than were available on stack. | 201 |
| Too Many Unknowns | Multiple Equation Solver can't calculate a value given the current knowns. Supply another value or add an equation. | E404 |
| Transfer Failed | Ten successive attempts to receive a good packet were unsuccessful. | C06 |
| Unable to find root | PROOT is unable to determine all roots of the polynomial. | C001 |
| Unable to Isolate | ISOL failed because specified name absent or contained in argument a function with no inverse. | 130 |
| Undefined FPTR Name | Executed a Flash Pointer that did not exist. | 011 |
| Undefined Local Name | Executed or recalled local name for which corresponding local variable did not exist. | 003 |
| Undefined Name | Executed or recalled global name for which corresponding variable did not exist. | 204 |
| Undefined Result | Calculation such as 0/0 generated mathematically undefined result. | 304 |
| Undefined XLIB Name | Executed an XLIB name when specified library absent. | 004 |

Messages Listed Alphabetically (continued)

| Message | Meaning | # (hex) |
|----------------------|--|-----------|
| Warning: | Label introducing current status message. | 007 |
| Wrong Argument Count | User-defined function evaluated with an incorrect number of parenthetical arguments. | 128 |
| x and y-axis zoom. | Identifies zoom option. | 627 |
| x axis zoom. | Identifies zoom option. | 625 |
| x axis zoom w/AUTO. | Identifies zoom option. | 624 |
| y axis zoom. | Identifies zoom option. | 626 |
| ZERO | Result returned by the HP Solve application or ROOT is a root (a point at which current equation evaluates to zero). | A04 |
| "" | Identifies no execution action when  pressed. | 61E |

Messages Listed Numerically

| # (hex) | Message |
|-------------------------|--------------------------|
| General Messages | |
| 001 | Insufficient Memory |
| 002 | Directory Recursion |
| 003 | Undefined Local Name |
| 004 | Undefined XLIB Name |
| 005 | Memory Clear |
| 006 | Power Lost |
| 007 | Warning: |
| 008 | Invalid Card Data |
| 009 | Object In use |
| 00A | Port Not Available |
| 00B | No Room in Port |
| 00C | Object Not in Port |
| 00D | Recovering Memory |
| 00E | Try To Recover Memory? |
| 00F | Replace RAM, Press ON |
| 010 | No Mem To Config All |
| 011 | Undefined FPTR Name |
| 012 | Invalid Bank Data |
| 013 | Full Check Bad Crc |
| 014 | Cmprs: not a user bank |
| 015 | No or 2 system bank |
| 016 | Invalid bank |
| 017 | Invalid bank number |
| 018 | Inexisting pack |
| 019 | Pack twice |
| 01A | Ins. Mem. |
| 01B | Erase Fail, Rom faulty |
| 01C | Erase Fail, Low bats |
| 01D | Erase Fail, Locked Block |
| 01E | Write Adr outside ROM |
| 01F | Write Fail, Rom Faulty |
| 020 | Write Fail, Low bats |
| 021 | Write Fail, Locked Block |
| 022 | Invalid DOS Name |
| 023 | File already opened |
| 024 | Invalid File Handle |
| 025 | Invalid File Index |

Messages Listed Numerically (continued)

| # (hex) | Message |
|-----------|-----------------------|
| 026 | Invalid File Mode |
| 027 | Disk Full |
| 028 | Disk Format Error |
| 029 | Disk Change |
| 02A | No SD card inserted |
| 02B | Not enough ARM memory |
| 02C | DOS call unsupported |
| 02D | DOS unknown error |
| 02E | Disk Protected |
| 101 | No Room to Save Stack |
| 102 | Can't Edit Null Char. |
| 103 | Invalid User Function |
| 104 | No Current Equation |
| 105 | (enterrmerr) |
| 106 | Invalid Syntax |
| 107 | Real Number |
| 108 | Complex Number |
| 109 | String |
| 10A | Real Array |
| 10B | Complex Array |
| 10C | List |
| 10D | Global Name |
| 10E | Local Name |
| 10F | Program |
| 110 | Algebraic |
| 111 | Binary Integer |
| 112 | Graphic |
| 113 | Tagged |
| 114 | Unit |
| 115 | XLIB Name |
| 116 | Directory |
| 117 | Library |
| 118 | Backup |
| 119 | Function |
| 11A | Command |
| 11B | System Binary |
| 11C | Long Real |

Messages Listed Numerically (continued)

| # (hex) | Message |
|------------------------------|--------------------------------------|
| 11D | Long Complex |
| 11E | Linked Array |
| 11F | Character |
| 120 | Code |
| 121 | Library Data |
| 122 | External |
| 123 | ({h DOERR is equivalent to KILL) |
| 124 | LAST STACK Disabled |
| 125 | LAST CMD Disabled |
| 126 | HALT Not Allowed |
| 127 | Array |
| 128 | Wrong Argument Count |
| 129 | Circular Reference |
| 12A | Directory Not Allowed |
| 12B | Non-Empty Directory |
| 12C | Invalid Definition |
| 12D | Missing Library |
| 12E | Invalid PPAR |
| 12F | Non-Real Result |
| 130 | Unable to Isolate |
| 131 | No Room to Show Stack |
| 132 | Warning: |
| 133 | Error: |
| Out-of-Memory Prompts | |
| 134 | Purge? |
| 135 | Out of Memory |
| 136 | Stack |
| 137 | Last Stack |
| 138 | Last Commands |
| 139 | Key Assignments |
| 13A | Alarms |
| 13B | Last Arguments |
| 13C | Name Conflict |
| 13D | Command Line |
| 13E | (Eh DOERR is equivalent to CONT) |
| 13F | Interrupted |
| 140 | Integer |

Messages Listed Numerically (continued)

| # (hex) | Message |
|---|--|
| 141 | Symbolic Matrix |
| 142 | Font |
| 143 | Aplet |
| 144 | Extended Real |
| 145 | Extended Complex |
| 146 | FlashPtr |
| 147 | Extended Ptr |
| 148 | MiniFont |
| 149 | Extended 1 |
| 14A | Extended 2 |
| 14B | Extended 3 |
| 14C | YES |
| 14D | NO |
| 14E | TRUE |
| 14F | FALSE |
| 150 | Are you sure? |
| 151 | Low Memory Condition Please Wait... |
| Object Editing Messages | |
| 152 | CATALOG |
| 153 | Nonexistent Find Pattern |
| 154 | Not Found |
| 155 | Nonexistent Replace Pattern |
| 156 | Can't Find Selection |
| 157 | Y= not available |
| 158 | Warning: Changes will not be saved |
| 159 | Result not editable in EQW |
| Stack Errors and Messages | |
| 201 | Too Few Arguments |
| 202 | Bad Argument Type |
| 203 | Bad Argument Value |
| 204 | Undefined Name |
| 205 | LASTARG Disabled |
| Equation Writer Application Messages | |
| 206 | Incomplete Subexpression |
| 207 | Implicit () off |
| 208 | Implicit () on |

Messages Listed Numerically (continued)

| # (hex) | Message |
|--|--------------------------------|
| Floating-Point Errors | |
| 301 | Positive Underflow |
| 302 | Negative Underflow |
| 303 | Overflow |
| 304 | Undefined Result |
| 305 | Infinite Result |
| Array Messages | |
| 501 | Invalid Dimension |
| 502 | Invalid Array Element |
| 503 | Deleting Row |
| 504 | Deleting Column |
| 505 | Inserting Row |
| 506 | Inserting Column |
| Statistics Messages | |
| 601 | Invalid Σ Data |
| 602 | Nonexistent Σ DAT |
| 603 | Insufficient Σ Data |
| 604 | Invalid Σ PAR |
| 605 | Invalid Σ Data LN(Neg) |
| 606 | Invalid Σ Data LN(0) |
| Plot, I/O, Time and HP Solve Application Messages | |
| 607 | Invalid EQ |
| 608 | Current equation: |
| 609 | No current equation. |
| 60A | Enter eqn, press NEW |
| 60B | Name the equation, press ENTER |
| 60C | Select plot type |
| 60D | Empty catalog |
| 60E | undefined |
| 60F | No stat data to plot |
| 610 | Autoscaling |
| 611 | Solving for |
| 612 | No current data. Enter |
| 613 | data point, press Σ + |
| 614 | Select a model |
| 615 | No alarms pending. |
| 616 | Press ALRM to create |
| 617 | Next alarm: |
| 618 | Past due alarm: |
| 619 | Acknowledged |

Messages Listed Numerically (continued)

| # (hex) | Message |
|---|---|
| 61A | Enter alarm, press SET |
| 61B | Select repeat interval |
| 61C | I/O setup menu |
| 61D | Plot type: |
| 61E | "" |
| 61F | (OFF SCREEN) |
| 620 | Invalid PTYPE |
| 621 | Name the stat data, press ENTER |
| 622 | Enter value (zoom out if>1), press ENTER |
| 623 | Copied to stack |
| 624 | x axis zoom w/AUTO. |
| 625 | x axis zoom. |
| 626 | y axis zoom. |
| 627 | x and y axis zoom. |
| 628 | IR/wire: |
| 629 | ASCII/binary: |
| 62A | baud: |
| 62B | parity: |
| 62C | checksum type: |
| 62D | translate code: |
| 62E | Enter matrix, then NEW |
| 62F | No Associated Numeric View |
| Mode and Plot Input Form Prompts | |
| 701 | Algebraic |
| 702 | RPN |
| 703 | Standard |
| 704 | Std |
| 705 | Fixed |
| 706 | Fix |
| 707 | Scientific |
| 708 | Sci |
| 709 | Engineering |
| 70A | Eng |
| 70B | Degrees |
| 70C | Radians |
| 70D | Grads |
| 70E | Rectangular |

Messages Listed Numerically (continued)

| # (hex) | Message |
|-----------|----------------------------------|
| 70F | Polar |
| 710 | Spherical |
| 711 | Operating Mode... |
| 712 | Number Format.... |
| 713 | Angle Measure.... |
| 714 | Coord System..... |
| 715 | FM, |
| 716 | Beep |
| 717 | Key Click |
| 718 | Last Stack |
| 719 | Choose calculator operating mode |
| 71A | Choose number display format |
| 71B | Choose decimal places to display |
| 71C | Choose angle measure |
| 71D | Choose coordinate system |
| 71E | Use comma as fraction mark? |
| 71F | Enable standard beep? |
| 720 | Enable key click? |
| 721 | Save last stk for UNDO and ANS? |
| 722 | CALCULATOR MODES |
| 723 | Font: |
| 724 | Stack: |
| 725 | Small |
| 726 | Textbook |
| 727 | Edit: |
| 728 | Small |
| 729 | Full Page |
| 72A | Indent |
| 72B | EQW: |
| 72C | Small |
| 72D | Small Stack Disp |
| 72E | Header: |
| 72F | Clock |
| 730 | Analog |
| 731 | Choose system font |
| 732 | Display stack using small font? |
| 733 | Use pretty print in the stack? |
| 734 | Edit using small font? |

Messages Listed Numerically (continued)

| # (hex) | Message |
|-----------|----------------------------------|
| 735 | Edit in full page? |
| 736 | Automatically indent new lines? |
| 737 | Edit in EQW using small font? |
| 738 | Display EQW using small font? |
| 739 | Choose header height |
| 73A | Display ticking clock? |
| 73B | Analog clock? |
| 73C | DISPLAY MODES |
| 73D | Indep var: |
| 73E | Modulo: |
| 73F | Verbose |
| 740 | Step/Step |
| 741 | Complex |
| 742 | Approx |
| 743 | Incr Pow |
| 744 | Simp Non-Rational |
| 745 | Rigorous |
| 746 | Numeric |
| 747 | Enter independent variable name |
| 748 | Enter modulo value |
| 749 | Display calculus information? |
| 74A | Perform operations step by step? |
| 74B | Allow complex numbers? |
| 74C | Perform approx calculations? |
| 74D | Increasing polynomial ordering? |
| 74E | Simplify non rational expr? |
| 74F | Don't simplify X to X? |
| 750 | Replace constants by values? |
| 751 | CAS MODES |
| 752 | Goto row: |
| 753 | Goto column: |
| 754 | Specify a row to go to |
| 755 | Specify a column to go to |
| 756 | Matrix Writer |
| 757 | Bad range value |
| 758 | Start: |
| 759 | Step: |
| 75A | Type: |

Messages Listed Numerically (continued)

| # (hex) | Message |
|-----------|---------------------------------|
| 75B | Zoom: |
| 75C | Small Font |
| 75D | File: |
| 75E | Enter starting value |
| 75F | Enter increment value |
| 760 | Choose table format |
| 761 | Enter zoom factor |
| 762 | Display table using small font? |
| 763 | Enter a filename to save data |
| 764 | TABLE SETUP |
| 765 | Automatic |
| 766 | Build Your Own |
| 767 | Function |
| 768 | Polar |
| 769 | Parametric |
| 76A | Diff Eq |
| 76B | Conic |
| 76C | Truth |
| 76D | Histogram |
| 76E | Bar |
| 76F | Scatter |
| 770 | Slopefield |
| 771 | Fast3D |
| 772 | Wireframe |
| 773 | Ps-Contour |
| 774 | Y-Slice |
| 775 | Gridmap |
| 776 | Pr-Surface |
| 777 | Deg |
| 778 | Rad |
| 779 | Grad |
| 77A | Type: |
| 77B | ∠: |
| 77C | EQ: |
| 77D | Indep: |
| 77E | Connect |
| 77F | Simult |
| 780 | H-Tick: |

Messages Listed Numerically (continued)

| # (hex) | Message |
|-----------|---------------------------------|
| 781 | V-Tick# |
| 782 | Pixels |
| 783 | Depnd# |
| 784 | Save Animation |
| 785 | ΣDAT# |
| 786 | Col# |
| 787 | Cols# |
| 788 | F# |
| 789 | H-Var# |
| 78A | V-Var# |
| 78B | Stiff |
| 78C | ∂F∂Y# |
| 78D | ∂F∂T# |
| 78E | Choose type of plot |
| 78F | Choose angle measure |
| 790 | Enter function(s) to plot |
| 791 | Enter independent variable name |
| 792 | Connect plot points? |
| 793 | Plot functions simultaneously? |
| 794 | Enter horizontal tick spacing |
| 795 | Enter vertical tick spacing |
| 796 | Tick spacing units are pixels? |
| 797 | Enter dependent variable name |
| 798 | Save slices animation? |
| 799 | Enter data to plot |
| 79A | Enter col to use for horizontal |
| 79B | Enter col to use for vertical |
| 79C | Enter horizontal variable |
| 79D | Enter vertical variable |
| 79E | Use stiff diff eq solver? |
| 79F | Enter derivative w.r.t. soln |
| 7A0 | Enter derivative w.r.t. indep |
| 7A1 | PLOT SETUP |
| 7A2 | H-View# |
| 7A3 | V-View# |
| 7A4 | Indep Low# |
| 7A5 | High# |
| 7A6 | Step# |
| 7A7 | Pixels |

Messages Listed Numerically (continued)

| # (hex) | Message |
|-----------|---------------------------------|
| 7A8 | Depnd Low: |
| 7A9 | High: |
| 7AA | X-Left: |
| 7AB | X-Right: |
| 7AC | Y-Near: |
| 7AD | Y-Far: |
| 7AE | Step Indep: |
| 7AF | Depnd: |
| 7B0 | Bar Width: |
| 7B1 | Z-Low: |
| 7B2 | Z-High: |
| 7B3 | XE: |
| 7B4 | YE: |
| 7B5 | ZE: |
| 7B6 | Init: |
| 7B7 | Final: |
| 7B8 | Init-Soln: |
| 7B9 | Tol: |
| 7BA | XXLeft: |
| 7BB | XXRight: |
| 7BC | YYNear: |
| 7BD | YYFar: |
| 7BE | Enter minimum horizontal value |
| 7BF | Enter maximum horizontal value |
| 7C0 | Enter minimum vertical value |
| 7C1 | Enter maximum vertical value |
| 7C2 | Enter minimum indep var value |
| 7C3 | Enter maximum indep var value |
| 7C4 | Enter indep var increment |
| 7C5 | Indep step units are pixels? |
| 7C6 | Enter minimum depend var value |
| 7C7 | Enter maximum depend var value |
| 7C8 | Enter bar width |
| 7C9 | Enter minimum Z view-volume val |
| 7CA | Enter maximum Z view-volume val |
| 7CB | Enter X eyepoint coordinate |
| 7CC | Enter Y eyepoint coordinate |

Messages Listed Numerically (continued)

| # (hex) | Message |
|-------------------------------------|---------------------------------|
| 7CD | Enter Z eyepoint coordinate |
| 7CE | Enter absolute error tolerance |
| 7CF | Enter minimum XX range value |
| 7D0 | Enter maximum XX range value |
| 7D1 | Enter minimum YY range value |
| 7D2 | Enter maximum YY range value |
| 7D3 | PLOT WINDOW |
| 7D4 | Default |
| 7D5 | FUNCTION |
| 7D6 | POLAR |
| 7D7 | PARAMETRIC |
| 7D8 | DIFF EQ |
| 7D9 | CONIC |
| 7DA | TRUTH |
| 7DB | HISTOGRAM |
| 7DC | BAR |
| 7DD | SCATTER |
| 7DE | SLOPEFIELD |
| 7DF | FAST3D |
| 7E0 | WIREFRAME |
| 7E1 | PS-CONTOUR |
| 7E2 | Y-SLICE |
| 7E3 | GRIDMAP |
| 7E4 | PR-SURFACE |
| 7E5 | PLOT WINDOW - |
| 7E6 | Enter minimum X view-volume val |
| 7E7 | Enter maximum X view-volume val |
| 7E8 | Enter minimum Y view-volume val |
| 7E9 | Enter maximum Y view-volume val |
| 7EA | Enter indep var sample count |
| 7EB | Enter depnd var sample count |
| 7EC | Goto Level: |
| 7ED | Specify a level to go to |
| 7EE | HISTORY |
| Advanced Statistics Messages | |
| 801 | Must be ≥ 0 |
| 802 | Must be bewteen 0 and 1 |
| 803 | $\mu 0$: |

Messages Listed Numerically (continued)

| # (hex) | Message |
|-----------|----------------------------------|
| 804 | \bar{x} : |
| 805 | N: |
| 806 | α : |
| 807 | σ : |
| 808 | Null hypothesis population mean |
| 809 | Sample mean |
| 80A | Sample Size |
| 80B | Significance level |
| 80C | Population standard deviation |
| 80D | Z-TEST: 1 μ , KNOWN σ |
| 80E | Alternative Hypothesis |
| 80F | \bar{x}_1 : |
| 810 | σ_1 : |
| 811 | N1: |
| 812 | α : |
| 813 | \bar{x}_2 : |
| 814 | σ_2 : |
| 815 | N2: |
| 816 | Sample mean for population 1 |
| 817 | Std deviation for population 1 |
| 818 | Sample size for population 1 |
| 819 | Significance level |
| 81A | Sample mean for population 2 |
| 81B | Std deviation for population 2 |
| 81C | Sample size for population 2 |
| 81D | Z-TEST: 2 μ , KNOWN σ |
| 81E | π_0 : |
| 81F | x: |
| 820 | N: |
| 821 | α : |
| 822 | Null hyp. population proportion |
| 823 | Success count |
| 824 | Sample size |
| 825 | Significance level |
| 826 | Z-TEST: 1 P |
| 827 | X1: |
| 828 | N1: |
| 829 | α : |

Messages Listed Numerically (continued)

| # (hex) | Message |
|-----------|------------------------------------|
| 82A | X2: |
| 82B | N2: |
| 82C | Success count for sample 1 |
| 82D | Size of sample 1 |
| 82E | Significance level |
| 82F | Success count for sample 2 |
| 830 | Size of sample 2 |
| 831 | Z-TEST: 2 P |
| 832 | \bar{x} : |
| 833 | Sx: |
| 834 | μ_0 : |
| 835 | α : |
| 836 | N: |
| 837 | Null hypothesis population mean |
| 838 | Sample Standard deviation |
| 839 | Sample Mean |
| 83A | Significance level |
| 83B | Sample size |
| 83C | T-TEST: 1 μ , UNKNOWN σ |
| 83D | \bar{x}_1 : |
| 83E | S1: |
| 83F | N1: |
| 840 | α : |
| 841 | \bar{x}_2 : |
| 842 | S2: |
| 843 | N2: |
| 844 | Pooled? |
| 845 | Sample mean for population 1 |
| 846 | Std deviation for sample 1 |
| 847 | Sample size for population 1 |
| 848 | Significance level |
| 849 | Sample mean for population2 |
| 84A | Std deviation for sample 2 |
| 84B | Sample size for population 2 |
| 84C | "Pooled" if checked |
| 84D | T-TEST: 2 μ , UNKNOWN σ |
| 84E | \bar{x} : |
| 84F | σ : |

Messages Listed Numerically (continued)

| # (hex) | Message |
|-----------|--------------------------------------|
| 850 | N: |
| 851 | C: |
| 852 | Sample mean |
| 853 | Population standard deviation |
| 854 | Sample size |
| 855 | Confidence level |
| 856 | CONF. INT.: 1 μ , KNOWN σ |
| 857 | $\bar{x}1$: |
| 858 | $\sigma1$: |
| 859 | N1: |
| 85A | C: |
| 85B | $\bar{x}2$: |
| 85C | $\sigma2$: |
| 85D | N2: |
| 85E | Sample mean for population 1 |
| 85F | Std deviation for sample 1 |
| 860 | Size of sample 1 |
| 861 | Sample mean for population 2 |
| 862 | Std deviation for sample 2 |
| 863 | Size of sample 2 |
| 864 | Confidence level |
| 865 | CONF. INT.: 2 μ , KNOWN σ |
| 866 | x: |
| 867 | N: |
| 868 | C: |
| 869 | Sample success count |
| 86A | Sample size |
| 86B | Confidence level |
| 86C | CONF. INT.: 1 P |
| 86D | $\bar{x}1$: |
| 86E | N1: |
| 86F | C: |
| 870 | $\bar{x}2$: |
| 871 | N2: |
| 872 | Sample 1 success count |
| 873 | Sample 1 size |
| 874 | Sample 2 success count |
| 875 | Sample 2 size |

Messages Listed Numerically (continued)

| # (hex) | Message |
|--------------------------------|--|
| 876 | Confidence level |
| 877 | CONF. INT.: 2 P |
| 878 | \bar{x} : |
| 879 | S_x : |
| 87A | N : |
| 87B | C : |
| 87C | Sample mean |
| 87D | Sample standard deviation |
| 87E | Sample size |
| 87F | Confidence level |
| 880 | CONF. INT.: 1 μ , UNKNOWN σ |
| 881 | \bar{x}_1 : |
| 882 | S_1 : |
| 883 | N_1 : |
| 884 | C : |
| 885 | \bar{x}_2 : |
| 886 | S_2 : |
| 887 | N_2 : |
| 888 | Pooled |
| 889 | Sample 1 mean |
| 88A | Std deviation for sample 1 |
| 88B | Sample 1 size |
| 88C | Sample 2 mean |
| 88D | Std deviation for sample 2 |
| 88E | Sample 2 size |
| 88F | Confidence level |
| 890 | Pooled if checked |
| 891 | CONF. INT.: 2 μ , UNKNOWN σ |
| Object Editing Messages | |
| 892 | Search for: |
| 893 | Replace by: |
| 894 | Case Sensitive |
| 895 | Search For: |
| 896 | Enter search pattern |
| 897 | Enter replace pattern |
| 898 | Case sensitive search? |
| 899 | Enter search pattern |

Messages Listed Numerically (continued)

| # (hex) | Message |
|--------------------------------------|---|
| 89A | FIND REPLACE |
| 89B | FIND |
| 89C | Goto Line: |
| 89D | Specify a line to go to |
| 89E | GOTO LINE |
| 89F | Goto Position: |
| 8A0 | Specify a position to go to |
| 8A1 | GOTO POSITION |
| 8A2 | H-Factor: |
| 8A3 | V-Factor: |
| 8A4 | Recenter on cursor |
| 8A5 | Enter horizontal zoom factor |
| 8A6 | Enter vertical zoom factor |
| 8A7 | Recenter plot on cursor? |
| 8A8 | ZOOM FACTOR |
| 8A9 | Object: |
| 8AA | Name: |
| 8AB | Directory |
| 8AC | Enter New Object |
| 8AD | Enter variable name |
| 8AE | Create a new directory? |
| 8AF | NEW VARIABLE |
| 8B0 | Select Object |
| Statistics Help Messages | |
| 901-90C | (Help messages for Hypothesis Tests and Confidence Intervals) |
| 90D | Inconclusive result |
| HP Solve Application Messages | |
| A01 | Bad Guess (es) |
| A02 | Constant? |
| A03 | Interrupted |
| A04 | Zero |
| A05 | Sign Reversal |
| A06 | Extremum |
| A07 | Left |
| A08 | Right |
| A09 | Expr |

Messages Listed Numerically (continued)

| # (hex) | Message |
|-----------------------------|---|
| Unit Management | |
| B01 | Invalid Unit |
| B02 | Inconsistent Units |
| I/O and Printing | |
| C01 | Bad Packet Block check |
| C02 | Timeout |
| C03 | Receive Error |
| C04 | Receive Buffer Overrun |
| C05 | Parity Error |
| C06 | Transfer Failed |
| C07 | Protocol Error |
| C08 | Invalid Server Cmd. |
| C09 | Port Closed |
| C0A | Connecting |
| C0B | Retry # |
| C0C | Awaiting Server Cmd. |
| C0D | Sending |
| C0E | Receiving |
| C0F | Object Discarded |
| C10 | Packet # |
| C11 | Processing Command |
| C12 | Invalid IOPAR |
| C13 | Invalid PRTPAR |
| C14 | Low Battery |
| C15 | Empty Stack |
| C16 | Row |
| C17 | Invalid Name |
| Time Messages | |
| D01 | Invalid Date |
| D02 | Invalid Time |
| D03 | Invalid Repeat |
| D04 | Nonexistent Alarm |
| A Programmer's DOERR | |
| DFF | (Causes silent interruption, leaving all pending HALTs intact.) |
| Input Form Prompts | |
| B901 | Press [CONT] for menu |
| B902 | reset/delete this field |
| B903 | Reset value |
| B904 | Delete value |
| B905 | Reset all |

Messages Listed Numerically (continued)

| # (hex) | Message |
|-----------|---------------------------------|
| B906 | Valid object types: |
| B907 | Valid object type: |
| B908 | Any object |
| B909 | Real number |
| B90A | (Complex num) |
| B90B | "String" |
| B90C | [Real array] |
| B90D | [(Cmpl array)] |
| B90E | { List } |
| B90F | Name |
| B910 | * Program * |
| B911 | 'Algebraic' |
| B912 | # Binary int |
| B913 | _Unit object |
| B914 | Invalid object type |
| B915 | Invalid object value |
| B916 | Calculator Modes |
| B917 | Number Format: |
| B918 | Angle Measure: |
| B919 | Coord System: |
| B91A | Beep |
| B91B | Clock |
| B91C | FM: |
| B91D | Choose number display format |
| B91E | Enter decimal places to display |
| B91F | Choose angle measure |
| B920 | Choose coordinate system |
| B921 | Enable standard beep? |
| B922 | Display ticking clock? |
| B923 | Use comma as fraction mark? |
| B924 | Standard |
| B925 | Std |
| B926 | Fixed |
| B927 | Fix |
| B928 | Scientific |
| B929 | Sci |
| B92A | Engineering |
| B92B | Eng |

Messages Listed Numerically (continued)

| # (hex) | Message |
|--|----------------------|
| B92C | Degrees |
| B92D | Deg |
| B92E | Radians |
| B92F | Rad |
| B930 | Grads |
| B931 | Grad |
| B932 | Rectangular |
| B933 | Polar |
| B934 | Spherical |
| System Flags Choose Box Prompts | |
| B935 | SYSTEM FLAGS |
| B936 | 01 General solutions |
| B937 | 02 Constant → symb |
| B938 | 03 Function → symb |
| B939 | 14 Payment at end |
| B93A | 19 →V2 → vector |
| B93B | 20 Underflow → 0 |
| B93C | 21 Overflow → ±9E499 |
| B93D | 22 Infinite → error |
| B93E | 27 'X+Y*i' → '(X,Y)' |
| B93F | 28 Sequential plot |
| B940 | 29 Draw axes too |
| B941 | 31 Connect points |
| B942 | 32 Solid cursor |
| B943 | 33 Transfer via wire |
| B944 | 34 Print via IR |
| B945 | 35 ASCII transfer |
| B946 | 36 RECV renames |
| B947 | 37 Single-space prnt |
| B948 | 38 Add linefeeds |
| B949 | 39 Show I/O messages |
| B94A | 40 Don't show clock |
| B94B | 41 12-hour clock |
| B94C | 42 mm/dd/yy format |
| B94D | 43 Reschedule alarm |
| B94E | 44 Delete alarm |
| B94F | 51 Fraction mark: . |
| B950 | 52 Show many lines |

Messages Listed Numerically (continued)

| # (hex) | Message |
|-----------|-----------------------|
| B951 | 53 No extra parens |
| B952 | 54 Tiny element → 0 |
| B953 | 55 Save last args |
| B954 | 56 Standard beep on |
| B955 | 57 Alarm beep on |
| B956 | 58 Show INFO |
| B957 | 59 Show variables |
| B958 | 60 [×][×] locks |
| B959 | 61 [USR][USR] locks |
| B95A | 62 User keys off |
| B95B | 63 Custom ENTER off |
| B95C | 65 All multiline |
| B95D | 66 Stack:~x lines str |
| B95E | 67 Digital clock |
| B95F | 68 No AutoIndent |
| B960 | 69 Line edit |
| B961 | 70 →GROB 1 line str |
| B962 | 71 Show addresses |
| B963 | 72 Stack:current fnt |
| B964 | 73 Edit:current font |
| B965 | 74 Right stack disp |
| B966 | 75 Key click off |
| B967 | 76 Purge confirm |
| B968 | 79 Textbook on |
| B969 | 80 EQW cur stk font |
| B96A | 81 GRB Alg cur font |
| B96B | 82 EQW edit cur font |
| B96C | 83 Display grobs on |
| B96D | 85 Normal stk disp |
| B96E | 90 CHOOSE:~cur font |
| B96F | 91 MTRW:~matrix |
| B970 | 92 MASD asm mode |
| B971 | 94 Result = LASTCMD |
| B972 | 95 RPN mode |
| B973 | 97 List:~horiz disp |
| B974 | 98 Vector:~horiz disp |
| B975 | 99 CAS:~quiet |

Messages Listed Numerically (continued)

| # (hex) | Message |
|-----------|---|
| B976 | 100 Step by step off |
| B977 | 103 Complex off |
| B978 | 105 Exact mode on |
| B979 | 106 Simp. in series |
| B97A | 109 Sym. factorize |
| B97B | 110 Normal matrices |
| B97C | 111 Simp non rat. |
| B97D | 112 i simplified |
| B97E | 113 Linear simp on |
| B97F | 114 Disp $1+x \rightarrow x+1$ |
| B980 | 115 SQRT simplified |
| B981 | 116 Prefer cos() |
| B982 | 117 CHOOSE boxes |
| B983 | 119 Rigorous on |
| B984 | 120 Silent mode off |
| B985 | 123 Allow Switch Mode |
| B986 | 125 Accur. Sign-Sturm |
| B987 | 126 rref w/ last col |
| B988 | 127 IrDA mode |
| B989 | 128 Cmplx var allowed |
| B98A | 01 Principal value |
| B98B | 02 Constant \rightarrow num |
| B98C | 03 Function \rightarrow num |
| B98D | 14 Payment at begin |
| B98E | 19 $\rightarrow V2 \rightarrow$ complex |
| B98F | 20 Underflow \rightarrow error |
| B990 | 21 Overflow \rightarrow error |
| B991 | 22 Infinite $\rightarrow \pm 9E499$ |
| B992 | 27 'X+Y*i' \rightarrow 'X+Y*i' |
| B993 | 28 Simultaneous plot |
| B994 | 29 Don't draw axes |
| B995 | 31 Plot points only |
| B996 | 32 Inverse cursor |
| B997 | 33 Transfer via IR |
| B998 | 34 Print via wire |
| B999 | 35 Binary transfer |
| B99A | 36 RECV overwrites |

Messages Listed Numerically (continued)

| # (hex) | Message |
|-----------|-----------------------|
| B99B | 37 Double-space prnt |
| B99C | 38 No linefeeds |
| B99D | 39 No I/O messages |
| B99E | 40 Show clock |
| B99F | 41 24-hour clock |
| B9A0 | 42 dd.mm.yy format |
| B9A1 | 43 Don't reschedule |
| B9A2 | 44 Save alarm |
| B9A3 | 51 Fraction mark: , |
| B9A4 | 52 Show one line |
| B9A5 | 53 Show all parens |
| B9A6 | 54 Use tiny element |
| B9A7 | 55 No last args |
| B9A8 | 56 Standard beep off |
| B9A9 | 57 Alarm beep off |
| B9AA | 58 Don't show INFO |
| B9AB | 59 Show names only |
| B9AC | 60 [α] locks Alpha |
| B9AD | 61 [USR] locks User |
| B9AE | 62 User keys on |
| B9AF | 63 Custom ENTER on |
| B9B0 | 65 Level 1 multiline |
| B9B1 | 66 Stk: 1 line str |
| B9B2 | 67 Analog clock |
| B9B3 | 68 AutoIndent |
| B9B4 | 69 Infinite line edit |
| B9B5 | 70 →GROB x lines str |
| B9B6 | 71 No addresses |
| B9B7 | 72 Stack:mini font |
| B9B8 | 73 Edit:mini font |
| B9B9 | 74 Left stack disp |
| B9BA | 75 Key click on |
| B9BB | 76 No purge confirm |
| B9BC | 79 Textbook off |
| B9BD | 80 EQW mini stk font |
| B9BE | 81 GRB Alg mini font |

Messages Listed Numerically (continued)

| # (hex) | Message |
|--------------------|--------------------------|
| B9BF | 82 EQW edit mini fnt |
| B9C0 | 83 Display grobs off |
| B9C1 | 85 SysRPL stk disp |
| B9C2 | 90 CHOOSE:mini font |
| B9C3 | 91 MTRW:list of list |
| B9C4 | 92 MASD SysRPL mode |
| B9C5 | 94 Result <> LASTCMD |
| B9C6 | 95 Algebraic mode |
| B9C7 | 97 List:vert disp |
| B9C8 | 98 Vector:vert disp |
| B9C9 | 99 CAS:verbose |
| B9CA | 100 Step by step on |
| B9CB | 103 Complex on |
| B9CC | 105 Approx. mode on |
| B9CD | 106 !Simp. in series |
| B9CE | 109 Num. factorize |
| B9CF | 110 Large matrices |
| B9D0 | 111 !Simp non rat. |
| B9D1 | 112 i not simplified |
| B9D2 | 113 Linear simp off |
| B9D3 | 114 Disp x+1 → 1+x |
| B9D4 | 115 SQRT !simplified |
| B9D5 | 116 Prefer sin() |
| B9D6 | 117 Soft MENU |
| B9D7 | 119 Rigorous off |
| B9D8 | 120 Silent mode on |
| B9D9 | 123 Forb. Switch Mode |
| B9DA | 125 FastSign-no Sturm |
| B9DB | 126 rref w/o last col |
| B9DC | 127 HP-IR mode |
| B9DD | 128 Vars are reals |
| I/O Prompts | |
| B9DE | Object: |
| B9DF | Obs in |
| B9E0 | Name: |
| BA01 | 1.Send to HP 49/48GII... |
| BA02 | 2.Get from HP 49/48GII |

Messages Listed Numerically (continued)

| # (hex) | Message |
|-----------|----------------------------------|
| BA03 | 3.Print display |
| BA04 | 4.Print... |
| BA05 | 5.Transfer... |
| BA06 | 6.Start Server |
| BA07 | Enter names of vars to send |
| BA08 | Vars in |
| BA09 | SEND TO HP 49/48GII |
| BA0A | Port: |
| BA0B | Dbl-Space |
| BA0C | Delay: |
| BA0D | Xlat: |
| BA0E | Linef |
| BA0F | Baud: |
| BA10 | Parity: |
| BA11 | Len: |
| BA12 | Choose print port |
| BA13 | Enter object(s) to print |
| BA14 | Print extra space between lines? |
| BA15 | Enter delay between lines |
| BA16 | Choose character translations |
| BA17 | Print linefeed between lines? |
| BA18 | Choose baud rate |
| BA19 | Choose parity |
| BA1A | Enter printer line length |
| BA1B | PRINT |
| BA1C | Type: |
| BA1D | OvrW |
| BA1E | Fmt: |
| BA1F | Chk: |
| BA20 | Choose transfer port |
| BA21 | Choose type of transfer |
| BA22 | Enter names of vars to transfer |
| BA23 | Choose transfer format |
| BA24 | Choose checksum type |
| BA25 | Overwrite existing variables? |
| BA26 | TRANSFER |
| BA27 | Local vars |

Messages Listed Numerically (continued)

| # (hex) | Message |
|-----------|--------------------------------|
| BA28 | Remote PC files |
| BA29 | Files in |
| BA2A | Enter name of dir to change to |
| BA2B | Choose Remote Directory |
| BA2C | Infrared |
| BA2D | IR |
| BA2E | Wire |
| BA2F | Kermit |
| BA30 | XModem |
| BA31 | Odd |
| BA32 | Even |
| BA33 | Mark |
| BA34 | Space |
| BA35 | Spc |
| BA36 | ASCII |
| BA37 | ASC |
| BA38 | Binary |
| BA39 | Bin |
| BA3A | None |
| BA3B | Newline (Ch 10) |
| BA3C | Newl |
| BA3D | Chr 128-159 |
| BA3E | →159 |
| BA3F | →255 |
| BA40 | Chr 128-255 |
| BA41 | One-digit arith |
| BA42 | Two-digit arith |
| BA43 | Three-digit CRC |
| BA44 | HP-IR |
| BA45 | IrDA |
| BA46 | 14K |
| BA47 | 19K |
| BA48 | 38K |
| BA49 | 57K |
| BA4A | 115K |
| BA4B | 15K |
| BA4C | 1200 |

Messages Listed Numerically (continued)

| # (hex) | Message |
|---------------------------|---------------------------------|
| BA4D | 2400 |
| BA4E | 4800 |
| BA4F | 9600 |
| Statistics Prompts | |
| BB01 | 1.Single-var... |
| BB02 | 2.Frequencies... |
| BB03 | 3.Fit data.. |
| BB04 | 4.Summary stats.. |
| BB05 | SINGLE-VARIABLE STATISTICS |
| BB06 | ΣDAT: |
| BB07 | Type: |
| BB08 | Mean |
| BB09 | Std Dev |
| BB0A | Variance |
| BB0B | Total |
| BB0C | Maximum |
| BB0D | Minimum |
| BB0E | Enter statistical data |
| BB0F | Enter variable column |
| BB10 | Choose statistics type |
| BB11 | Calculate mean? |
| BB12 | Calculate standard deviation? |
| BB13 | Calculate variance? |
| BB14 | Calculate column total? |
| BB15 | Calculate column maximum? |
| BB16 | Calculate column minimum? |
| BB17 | Sample |
| BB18 | Population |
| BB19 | FREQUENCIES |
| BB1A | X-Min: |
| BB1B | Bin Count: |
| BB1C | Bin Width: |
| BB1D | Enter minimum first bin X value |
| BB1E | Enter number of bins |
| BB1F | Enter bin width |
| BB20 | FIT DATA |
| BB21 | X-Col: |

Messages Listed Numerically (continued)

| # (hex) | Message |
|-------------------------------|----------------------------------|
| BB22 | Y-Col# |
| BB23 | Model# |
| BB24 | Enter indep column number |
| BB25 | Enter dependent column number |
| BB26 | Choose statistical model |
| BB27 | Correlation |
| BB28 | Covariance |
| BB29 | PREDICT VALUES |
| BB2A | Y# |
| BB2B | Enter indep value or press PRED |
| BB2C | Enter dep value or press PRED |
| BB2D | SUMMARY STATISTICS |
| BB2E | Calculate# |
| BB2F | ΣX |
| BB30 | ΣY |
| BB31 | ΣX^2 |
| BB32 | ΣY^2 |
| BB33 | ΣXY |
| BB34 | $N\Sigma$ |
| BB35 | Calculate sum of X column? |
| BB36 | Calculate sum of Y column? |
| BB37 | Calculate sum of squares of X? |
| BB38 | Calculate sum of squares of Y? |
| BB39 | Calculate sum of products? |
| BB3A | Calculate number of data points? |
| BB3B | Linear Fit |
| BB3C | Logarithmic Fit |
| BB3D | Exponential Fit |
| BB3E | Power Fit |
| BB3F | Best Fit |
| BB40 | 5.Hypoth. tests... |
| BB41 | 6.Conf. interval... |
| Time and Alarm Prompts | |
| BC01 | 1.Browse alarms... |
| BC02 | 2.Set alarm... |
| BC03 | 3.Set time, date... |
| BC04 | SET ALARM |

Messages Listed Numerically (continued)

| # (hex) | Message |
|-----------|--------------------------------|
| BC05 | Message: |
| BC06 | Time: |
| BC07 | Date: |
| BC08 | Repeat: |
| BC09 | Enter "message" or < action > |
| BC0A | Enter hour |
| BC0B | Enter minute |
| BC0C | Enter second |
| BC0D | Choose AM, PM, or 24-hour time |
| BC0E | Enter month |
| BC0F | Enter day |
| BC10 | Enter year |
| BC11 | Enter alarm repeat multiple |
| BC12 | Enter alarm repeat unit |
| BC13 | SET TIME AND DATE |
| BC14 | Choose date display format |
| BC15 | Monday |
| BC16 | Tuesday |
| BC17 | Wednesday |
| BC18 | Thursday |
| BC19 | Friday |
| BC1A | Saturday |
| BC1B | Sunday |
| BC1C | None |
| BC1D | AM |
| BC1E | PM |
| BC1F | 24-hour time |
| BC20 | 24-hr |
| BC21 | 1 January |
| BC22 | 2 February |
| BC23 | 3 March |
| BC24 | 4 April |
| BC25 | 5 May |
| BC26 | 6 June |
| BC27 | 7 July |
| BC28 | 8 August |
| BC29 | 9 September |

Messages Listed Numerically (continued)

| # (hex) | Message |
|-------------------------------------|---------------------------------|
| BC2A | 10 October |
| BC2B | 11 November |
| BC2C | 12 December |
| BC2D | Week |
| BC2E | Day |
| BC2F | Hour |
| BC30 | Minute |
| BC31 | Second |
| BC32 | Weeks |
| BC33 | Days |
| BC34 | Hours |
| BC35 | Minutes |
| BC36 | Seconds |
| BC37 | Month/Day/Year |
| BC38 | M/D/Y |
| BC39 | Day.Month.Year |
| BC3A | D.M.Y |
| BC3B | ALARMS |
| Symbolic Application Prompts | |
| BD01 | 1.Integrate... |
| BD02 | 2.Differentiate... |
| BD03 | 3.Taylor poly... |
| BD04 | 4.Isolate var... |
| BD05 | 5.Solve quad... |
| BD06 | 6.Manip expr... |
| BD07 | INTEGRATE |
| BD08 | Expr: |
| BD09 | Var: |
| BD0A | Result: |
| BD0B | Enter expression |
| BD0C | Enter variable name |
| BD0D | Enter lower limit |
| BD0E | Enter upper limit |
| BD0F | Choose result type |
| BD10 | Choose disp format for accuracy |
| BD11 | DIFFERENTIATE |
| BD12 | Value: |

Messages Listed Numerically (continued)

| # (hex) | Message |
|---------------------------------|--------------------------------|
| BD13 | Enter variable value |
| BD14 | Expression |
| BD15 | TAYLOR POLYNOMIAL |
| BD16 | Order: |
| BD17 | Enter Taylor polynomial order |
| BD18 | ISOLATE A VARIABLE |
| BD19 | Principal |
| BD1A | Get principal solution only? |
| BD1B | SOLVE QUADRATIC |
| BD1C | MANIPULATE EXPRESSION |
| BD1D | MATCH EXPRESSION |
| BD1E | Pattern: |
| BD1F | Replacement: |
| BD20 | Subexpr First |
| BD21 | Cond: |
| BD22 | Enter pattern to search for |
| BD23 | Enter replacement object |
| BD24 | Search subexpressions first? |
| BD25 | Enter conditional expression |
| BD26 | Symbolic |
| BD27 | Numeric |
| Plot Application Prompts | |
| BE01 | Plot |
| BE02 | Type: |
| BE03 | ∠: |
| BE04 | H-View: |
| BE05 | Autoscale |
| BE06 | V-View: |
| BE07 | Choose type of plot |
| BE08 | Choose angle measure |
| BE09 | Enter function(s) to plot |
| BE0A | Enter minimum horizontal value |
| BE0B | Enter maximum horizontal value |
| BE0C | Autoscale vertical plot range? |
| BE0D | Enter minimum vertical value |
| BE0E | Enter maximum vertical value |
| BE0F | Plot (x(t), y(t)) |

Messages Listed Numerically (continued)

| # (hex) | Message |
|-----------|----------------------------------|
| BE10 | Enter complex-valued func(s) |
| BE11 | Plot $y'(t)=f(t,y)$ |
| BE12 | Enter function of INDEP and SOLN |
| BE13 | Enter derivative w.r.t. SOLN |
| BE14 | Enter derivative w.r.t. INDEP |
| BE15 | Use Stiff diff eq solver? |
| BE16 | ΣDat: |
| BE17 | Col: |
| BE18 | Wid: |
| BE19 | Enter data to plot |
| BE1A | Arrays in |
| BE1B | Enter column to plot |
| BE1C | Enter bar width |
| BE1D | Cols: |
| BE1E | Enter col to use for horizontal |
| BE1F | Enter col to use for vertical |
| BE20 | Steps: |
| BE21 | Enter indep var sample count |
| BE22 | Enter dep var sample count |
| BE23 | Plot Options |
| BE24 | Lo: |
| BE25 | Hi: |
| BE26 | Axes |
| BE27 | Simult |
| BE28 | Connect |
| BE29 | Pixels |
| BE2A | H-Tick: |
| BE2B | V-Tick: |
| BE2C | Enter minimum indep var value |
| BE2D | Enter maximum indep var value |
| BE2E | Draw axes before plotting? |
| BE2F | Connect plot points? |
| BE30 | Plot functions simultaneously? |
| BE31 | Enter indep var increment |
| BE32 | Indep step units are pixels? |
| BE33 | Enter horizontal tick spacing |
| BE34 | Enter vertical tick spacing |

Messages Listed Numerically (continued)

| # (hex) | Message |
|-----------|---------------------------------|
| BE35 | Tick spacing units are pixels? |
| BE36 | Depnd# |
| BE37 | Enter dependent var name |
| BE38 | Enter minimum dep var value |
| BE39 | Enter maximum dep var value |
| BE3A | H-Var# |
| BE3B | V-Var# |
| BE3C | Enter max indep var increment |
| BE3D | Choose horizontal variable |
| BE3E | Choose vertical variable |
| BE3F | 0 INDEP |
| BE40 | 1 SOLN |
| BE41 | SOLN< |
| BE42 | X-Left# |
| BE43 | X-Right# |
| BE44 | Y-Near# |
| BE45 | Y-Far# |
| BE46 | Z-Low# |
| BE47 | Z-High# |
| BE48 | Enter minimum X view-volume val |
| BE49 | Enter maximum X view-volume val |
| BE4A | Enter minimum Y view-volume val |
| BE4B | Enter maximum Y view-volume val |
| BE4C | Enter minimum Z view-volume val |
| BE4D | Enter maximum Z view-volume val |
| BE4E | XE# |
| BE4F | YE# |
| BE50 | ZE# |
| BE51 | Enter X eyepoint coordinate |
| BE52 | Enter Y eyepoint coordinate |
| BE53 | Enter Z eyepoint coordinate |
| BE54 | Save Animation |
| BE55 | Save animation data after plot? |
| BE56 | XX-Left# |
| BE57 | XX-Right# |
| BE58 | YY-Near# |
| BE59 | YY-Far# |

Messages Listed Numerically (continued)

| # (hex) | Message |
|----------------------------------|------------------------------|
| BE5A | Enter minimum XX range value |
| BE5B | Enter maximum XX range value |
| BE5C | Enter minimum YY range value |
| BE5D | Enter maximum YY range value |
| BE5E | XX and YY Plot Options |
| BE5F | Zoom Factors |
| BE60 | H-Factor: |
| BE61 | V-Factor: |
| BE62 | Recenter at Crosshairs |
| BE63 | Enter horizontal zoom factor |
| BE64 | Enter vertical zoom factor |
| BE65 | Recenter plot at crosshairs? |
| BE66 | Reset plot |
| BE67 | Dflt |
| BE68 | Auto |
| BE69 | Function |
| BE6A | Polar |
| BE6B | Conic |
| BE6C | Truth |
| BE6D | Parametric |
| BE6E | Diff Eq |
| BE6F | Histogram |
| BE70 | Bar |
| BE71 | Scatter |
| BE72 | Slopefield |
| BE73 | Wireframe |
| BE74 | Ps-Contour |
| BE75 | Y-Slice |
| BE76 | Gridmap |
| BE77 | Pr-Surface |
| Solve Application Prompts | |
| BF01 | 1.Solve equation... |
| BF02 | 2.Solve diff eq... |
| BF03 | 3.Solve poly... |
| BF04 | 4.Solve lin sys... |
| BF05 | 5.Solve finance... |
| BF06 | SOLVE EQUATION |

Messages Listed Numerically (continued)

| # (hex) | Message |
|-----------|-----------------------------------|
| BF07 | Enter value or press SOLVE |
| BF08 | Eq: |
| BF09 | Enter function to solve |
| BF0A | Funcs in |
| BF0B | Solver Variable Order |
| BF0C | Variables: |
| BF0D | Enter order of vars to display |
| BF0E | SOLVE Y'(T)=F(T,Y) |
| BF0F | f: |
| BF10 | $\partial f / \partial y$: |
| BF11 | $\partial f / \partial t$: |
| BF12 | Indep: |
| BF13 | Init: |
| BF14 | Final: |
| BF15 | Soln: |
| BF16 | Tol: |
| BF17 | Step: |
| BF18 | Stiff |
| BF19 | Enter function of INDEP and SOLN |
| BF1A | Enter derivative w.r.t. SOLN |
| BF1B | Enter derivative w.r.t. INDEP |
| BF1C | Enter independent var name |
| BF1D | Enter initial indep var value |
| BF1E | Enter final indep var value |
| BF1F | Enter solution var name |
| BF20 | Enter initial solution var value |
| BF21 | Press SOLVE for final soln value |
| BF22 | Enter absolute error tolerance |
| BF23 | Enter initial step size |
| BF24 | Calculate stiff differential? |
| BF25 | f |
| BF26 | Tolerance |
| BF27 | Solution |
| BF28 | SOLVE AN·X^N+...+A1·X+A0 |
| BF29 | Coefficients [an ... a1 a0]: |
| BF2A | Roots: |
| BF2B | Enter coefficients or press SOLVE |

Messages Listed Numerically (continued)

| # (hex) | Message |
|-----------|--------------------------------|
| BF2C | Enter roots or press SOLVE |
| BF2D | Coefficients |
| BF2E | Roots |
| BF2F | SOLVE SYSTEM A·X=B |
| BF30 | A: |
| BF31 | B: |
| BF32 | X: |
| BF33 | Enter coefficients matrix A |
| BF34 | Enter constants or press SOLVE |
| BF35 | Enter solutions or press SOLVE |
| BF36 | Constants |
| BF37 | Solutions |
| BF38 | N: |
| BF39 | I%/YR: |
| BF3A | PV: |
| BF3B | PMT: |
| BF3C | P%/YR: |
| BF3D | FV: |
| BF3E | Enter no. of payments or SOLVE |
| BF3F | Enter yearly int rate or SOLVE |
| BF40 | Enter present value or SOLVE |
| BF41 | Enter payment amount or SOLVE |
| BF42 | Enter no. of payments per year |
| BF43 | Enter future value or SOLVE |
| BF44 | Choose when payments are made |
| BF45 | TIME VALUE OF MONEY |
| BF46 | N |
| BF47 | I%/YR |
| BF48 | PV |
| BF49 | PMT |
| BF4A | FV |
| BF4B | End |
| BF4C | Begin |
| BF4D | Beg |
| BF4E | AMORTIZE |
| BF4F | Payments: |
| BF50 | Principal: |

Messages Listed Numerically (continued)

| # (hex) | Message |
|---------------------|--------------------------------|
| BF51 | Interest: |
| BF52 | Balance: |
| BF53 | Enter no. of payments to amort |
| BF54 | Principal |
| BF55 | Interest |
| BF56 | Balance |
| C001 | Unable to find root |
| CAS Messages | |
| DE01 | denominator(s) |
| DE02 | root(s) |
| DE03 | last |
| DE04 | obvious |
| DE05 | factorizing |
| DE06 | value |
| DE07 | test(s) |
| DE08 | searching |
| DE09 | TAYLR of ↓ at |
| DE0A | nth |
| DE0B | is |
| DE0C | numerator(s) |
| DE0D | Less than |
| DE0E | multiplicity |
| DE0F | list of |
| DE10 | at |
| DE11 | factor(s) |
| DE12 | Eigenvalues |
| DE13 | Computing for |
| DE14 | Root mult < |
| DE15 | Numerical to symbolic |
| DE16 | Invalid operator |
| DE17 | Result: |
| DE18 | Pivots |
| DE19 | Press CONT to go on |
| DE1A | Test |
| DE1B | To be implemented |
| DE1C | Unable to factor |
| DE1D | Z is not = 1 mod 4 |

Messages Listed Numerically (continued)

| # (hex) | Message |
|-----------|--|
| DE1E | Z is not prime |
| DE1F | Empty () of equations |
| DE20 | Not reducible to a rational expression |
| DE21 | Non unary operator |
| DE22 | User function |
| DE23 | Non isolable operator |
| DE24 | Not exact system |
| DE25 | Parameters not allowed |
| DE26 | CAS internal error |
| DE27 | Invalid ^ for SERIES |
| DE28 | Operator not implemented (SERIES) |
| DE29 | No variable in expr. |
| DE2A | No solution found |
| DE2B | Invalid derivation arg |
| DE2C | No solution in ring |
| DE2D | Not a linear system |
| DE2E | Can't derive int. var |
| DE2F | Diff equation order>2 |
| DE30 | INT:invalid var change |
| DE31 | Mode switch cancelled |
| DE32 | No name in expression |
| DE33 | Invalid user function |
| DE34 | Can't find ODE type |
| DE35 | Integer too large |
| DE36 | Unable to find sign |
| DE37 | Non-symmetric matrix |
| DE38 | ATAN insufficient order |
| DE39 | ASIN at infinity undef |
| DE3A | Unsigned inf error |
| DE3B | LN[Var] comparison err |
| DE3C | Undef limit for var |
| DE3D | Bounded var error |
| DE3E | Got expr. indep of var |
| DE3F | Can't state remainder |
| DE40 | LN of neg argument |
| DE41 | Insufficient order |
| DE42 | ABS of non-signed 0 |

Messages Listed Numerically (continued)

| # (hex) | Message |
|-----------|---|
| DE43 | Numeric input |
| DE44 | Singularity! Continue? |
| DE45 | Cancelled |
| DE46 | Negative integer |
| DE47 | Parameter is cur. var. dependent |
| DE48 | Unsimpified sqrt |
| DE49 | Non polynomial system |
| DE4A | Unable to solve ODE |
| DE4B | Array dimension too large |
| DE4C | Unable to reduce system |
| DE4D | Complex number not allowed |
| DE4E | Polyn. valuation must be 0 |
| DE4F | Mode switch not allowed here |
| DE50 | Non algebraic in expression |
| DE51 | Purge current variable |
| DE52 | Reduction result |
| DE53 | Matrix not diagonalizable |
| DE54 | Int[u'*F(u)] with u= |
| DE55 | Int. by part u'*v, u= |
| DE56 | Square root |
| DE57 | Rational fraction |
| DE58 | Linearizing |
| DE59 | Risch alg. of tower |
| DE5A | Trig. fraction, u= |
| DE5B | Unknown operator (DOMAIN) |
| DE5C | Same points |
| DE5D | Unsigned inf. Solve? |
| DE5E | CAS not available |
| DE5F | Can not store current var |
| DE60 | Not available on the HP40G |
| DE61 | Not available on the HP49G |
| DE62 | SERIES remainder is O(1) at order 3 |
| DE63 | Delta/Heaviside not available from HOME |
| DE64 | Warning, integrating in approx mode |
| DE65 | Function is constant |
| DE66 | Can not unbind local vars |

Messages Listed Numerically (continued)

| # (hex) | Message |
|----------------------------------|--|
| DE67 | Replacing strict with large inequality |
| DE68 | No valid environment stored |
| File Application Messages | |
| DF01 | File Manager |
| DF02 | NO |
| DF03 | ABORT |
| DF04 | ALL |
| DF05 | YES |
| DF06 | REN |
| DF07 | Already Exists |
| DF08 | Overwrite ? |
| DF09 | Rename |
| DF0A | PICK DESTINATION |
| DF0B | Are You Sure? |
| DF0C | Search Mode OFF |
| DF0D | Search Mode ON |
| DF0E | New DIR? |
| DF0F | Sort by: |
| DF10 | Original |
| DF11 | Type |
| DF12 | Name |
| DF13 | Size |
| DF14 | Inv. Type |
| DF15 | Inv. Name |
| DF16 | Inv. Size |
| DF17 | Sending with Xmodem: |
| DF18 | EDIT |
| DF19 | COPY |
| DF1A | MOVE |
| DF1B | RCL |
| DF1C | EVAL |
| DF1D | TREE |
| DF1E | PURGE |
| DF1F | RENAME |
| DF20 | NEW |
| DF21 | ORDER |
| DF22 | SEND |

Messages Listed Numerically (continued)

| # (hex) | Message |
|-----------------------------------|-------------------|
| DF23 | RECV |
| DF24 | HALT |
| DF25 | VIEW |
| DF26 | EDITB |
| DF27 | HEADER |
| DF28 | LIST |
| DF29 | SORT |
| DF2A | XSEND |
| DF2B | CHDIR |
| DF2C | CANCL |
| DF2D | OK |
| DF2E | CHECK |
| Constants Library Messages | |
| E101 | Avogadro's number |
| E102 | Boltzmann |
| E103 | molar volume |
| E104 | universal gas |
| E105 | std temperature |
| E106 | std pressure |
| E107 | Stefan-Boltzmann |
| E108 | speed of light |
| E109 | permittivity |
| E10A | permeability |
| E10B | accel of gravity |
| E10C | gravitation |
| E10D | Planck's |
| E10E | Dirac's |
| E10F | electronic charge |
| E110 | electron mass |
| E111 | q/me ratio |
| E112 | proton mass |
| E113 | mp/me ratio |
| E114 | fine structure |
| E115 | mag flux quantum |
| E116 | Faraday |
| E117 | Rydberg |
| E118 | Bohr radius |
| E119 | Bohr magneton |

Messages Listed Numerically (continued)

| # (hex) | Message |
|--|-----------------------|
| E11A | nuclear magneton |
| E11B | photon wavelength |
| E11C | photon frequency |
| E11D | Compton wavelen |
| E11E | 1 radian |
| E11F | 2 π radians |
| E120 | \angle in trig mode |
| E121 | Wien's |
| E122 | k/q |
| E123 | ϵ_0/q |
| E124 | $q*\epsilon_0$ |
| E125 | dielectric const |
| E126 | SiO2 dielec cons |
| E127 | ref intensity |
| E128 | CONSTANTS LIBRARY |
| E129 | Undefined Constant |
| Equation Library Messages | |
| E301 | Starting Solver |
| E302 | OF |
| E303 | Keyword Conflict |
| E304 | No Picture Available |
| Minehunt Game Prompts | |
| E305 | NEAR |
| E306 | MINE |
| E307 | MINES |
| E308 | SCORE: |
| E309 | YOU MADE IT!! |
| E30A | YOU BLEW UP!! |
| Multiple-Equation Solver Messages | |
| E401 | Invalid Mpar |
| E402 | Single Equation |
| E403 | EQ Invalid for MINIT |
| E404 | Too Many Unknowns |
| E405 | All Variables Known |
| E406 | Illegal During MROOT |
| E407 | Solving for |
| E408 | Searching |

Messages Listed Numerically (continued)

| # (hex) | Message |
|---|------------------------|
| Financial Solver Messages | |
| E601 | No Solution |
| E602 | Many or No Solutions |
| E603 | IXYR/PYR \<= -100 |
| E604 | Invalid N |
| E605 | Invalid PYR |
| E606 | Invalid #Periods |
| E607 | Undefined TVM Variable |
| E608 | END mode |
| E609 | BEGIN mode |
| E60A | payments/year |
| E60B | Principal |
| E60C | Interest |
| E60D | Balance |
| Development Library and Miscellaneous Messages | |
| 10001 | Invalid \$ROMID |
| 10002 | Invalid \$TITLE |
| 10003 | Invalid \$MESSAGE |
| 10004 | Invalid \$VISIBLE |
| 10005 | Invalid \$HIDDEN |
| 10006 | Invalid \$EXTPRG |
| 10101 | Invalid File |
| 10102 | Too Many |
| 10103 | Unknown Instruction |
| 10104 | Invalid Field |
| 10105 | Val betw 0-15 expected |
| 10106 | Val betw 1-16 expected |
| 10107 | Label Expected |
| 10108 | Hexa Expected |
| 10109 | Decimal Expected |
| 1010A | Can't Find |
| 1010B | Label already defined |
| 1010C | { expected |
| 1010D | } expected |
| 1010E | < expected |
| 1010F | Forbidden |
| 10110 | Bad Expression |

Messages Listed Numerically (continued)

| # (hex) | Message |
|------------------|--|
| 10111 | Jump too Long |
| 10112 | Val betw 1-8 expected |
| 10113 | Insuffisant Memory |
| 10114 | Matrix Error |
| 10115 | Define Error |
| 10116 | [or] expected |
| 10117 | ARM register expected |
| 10118 | ARM invalid imediate |
| 31401 | No Message here |
| 70000 | (user-defined message created with DOERR) |

Table of Units

| Unit (Full Name) | Value in SI Units |
|--------------------------------------|--|
| a (are) | 100 m ² |
| A (ampere) | 1 A |
| acre (acre) | 4046.87260987 m ² |
| arcmin (minute of arc) | 2.90888208666 x 10 ⁻⁴ r |
| arcs (second of arc) | 4.8481368111 x 10 ⁻⁶ r |
| atm (atmosphere) | 101325 kg / m•s ² |
| au (astronomical unit) | 1.495979 x 10 ¹¹ m |
| Å (Angstrom) | 1 x 10 ⁻¹⁰ m |
| b (barn) | 1 x 10 ⁻²⁸ m ² |
| bar (bar) | 100000 kg / m•s ² |
| bb1 (barrel) | .158987294928 m ³ |
| Bq (becquerel) | 1 1 / s |
| Btu (international table Btu) | 1055.05585262 kg•m ² / s ² |
| bu (bushel) | .03523907 m ³ |
| °C (degree Celsius) | 1K or 274.15 K |
| c (speed of light) | 299792458 m / s |
| C (coulomb) | 1 A•s |
| cal (calorie) | 4.1868 kg•m ² / s ² |
| cd (candela) | 1 cd |
| chain (chain) | 20.1168402337 m |
| Ci (curie) | 3.7 x 10 ¹⁰ 1 / s |
| ct (carat) | .0002 kg |
| cu (US cup) | 2.365882365 x 10 ⁻⁴ m ³ |
| ° (degree) | 1.74532925199 x 10 ⁻² r |
| d (day) | 86400 s |
| dyn (dyne) | .00001 kg / m•s ² |
| erg (erg) | .0000001 kg•m ² / s ² |
| eV (electron volt) | 1.60217733 x 10 ⁻¹⁹ kg•m ² /s ² |
| F (farad) | 1 A ² •s ⁴ / kg•m ² |

Units (continued)

| Unit (Full Name) | Value in SI Units |
|---------------------------------------|--|
| °F (degrees Fahrenheit) | 0.555555555556 K or 255.927777778 K |
| fath (fathom) | 1.82880365761 m |
| fbm (board foot) | .002359737216 m ³ |
| fc (footcandle) | 10.7639104167 cd•sr / m ² |
| Fdy (faraday) | 96487 A•s |
| fermi (fermi) | 1 x 10 ⁻¹⁵ m |
| flam (footlambert) | 3.42625909964 cd / m ² |
| ft (international foot) | .3048 m |
| ftUS (survey foot) | .304800609601 m |
| g (gram) | .001 kg |
| ga (standard freefall) | 9.80665 m / s ² |
| gal (US gallon) | .003785411784 m ³ |
| galC (Canadian gallon) | .00454609 m ³ |
| galUK (UK gallon) | .004546092 m ³ |
| gf (gram-force) | .00980665 kg•m / s ² |
| grad (gradient) | 1.57079632679 x 10 ⁻² r |
| grain (grain) | .00006479891 kg |
| Gy (gray) | 1 m ² / s ² |
| H (henry) | 1 kg•m ² / A ² •s ² |
| h (Hour) | 3600 s |
| hp (horsepower) | 745.699871582 kg•m ² / s ³ |
| Hz (hertz) | 1 / s |
| in (inch) | .0254 m |
| inHg (inches of mercury, 0 °C) | 3386.38815789 kg / m•s ² |
| inH2O (inches of water, 60 °F) | 248.84 kg / m•s ² |
| J (joule) | 1 kg•m ² / s ² |
| K (kelvins) | 1 K |
| kg (kilogram) | 1 kg |
| kip (kilopound-force) | 4448.22161526 kg•m / s ² |
| knot (nautical miles per hour) | .514444444444 m / s |
| kph (kilometers per hour) | .277777777778 m / s |
| l (liter) | .001 m ³ |
| lam (lambert) | 3183.09886184 cd / m ² |
| lb (avoirdupois pound) | .45359237 kg |
| lbf (pound -force) | 4.44822161526 kg•m / s ² |

Units (continued)

| Unit (Full Name) | Value in SI Units |
|--|--|
| lbt (troy pound) | .3732417216 kg |
| lm (lumen) | 1 cd•sr |
| lx (lux) | 1 cd•sr / m ² |
| lyr (light year) | 9.46052840488 x 10 ¹⁵ m |
| m (meter) | 1 m |
| μ (micron) | 1 x 10 ⁻⁶ m |
| mho (mho) | 1 A ² •s ³ / kg•m ² |
| mi (international mile) | 1609.344 m |
| mil (mil) | .0000254 m |
| min (minute) | 60 s |
| miUS (US statute mile) | 1609.34721869 m |
| mmHg (millimeter of mercury (torr), 0 °C) | 133.322368421 kg / m•s ² |
| mol (mole) | 1 mol |
| mph (miles per hour) | .44704 m / s |
| N (newton) | 1 kg•m / s ² |
| nmi (nautical mile) | 1852 m |
| Ω (ohm) | 1 kg•m ² / A ² •s ³ |
| oz (ounce) | .028349523125 kg |
| ozfl (US fluid ounce) | 2.95735295625 x 10 ⁻⁵ m ³ |
| ozt (troy ounce) | .311034768 kg |
| ozUK (UK fluid ounce) | 2.8413075 x 10 ⁻⁵ m ³ |
| P (poise) | .1 kg / m•s |
| Pa (pascal) | 1 kg / m•s ² |
| pc (parsec) | 3.08567818585 x 10 ¹⁶ m |
| pdl (poundal) | .138254954376 kg•m / s ² |
| ph (phot) | 10000 cd•sr / m ² |
| pk (peck) | .0088097675 m ³ |
| psi (pounds per square inch) | 6894.75729317 kg•m / s ² |
| pt (pint) | .000473176473 m ³ |
| qt (quart) | .000946352946 m ³ |
| r (radian) | 1 r |
| R (roentgen) | .000258 A•s / kg |
| °R (degrees Rankine) | 0.555555555556 K |
| rad (rad) | .01 m ² / s ² |
| rd (rod) | 5.02921005842 m |

Units (continued)

| Unit (Full Name) | Value in SI Units |
|--------------------------------|--|
| rem (rem) | .01 m ² / s ² |
| s (second) | 1 s |
| S (siemens) | 1 A ² •s ³ / kg•m ² |
| sb (stilb) | 10000 cd / m ² |
| slug (slug) | 14.5939029372 kg |
| sr (steradian) | 1 sr |
| st (stere) | 1 m ³ |
| St (stokes) | .0001 m ² / s |
| Sv (sievert) | 1 m ² / s ² |
| t (metric ton) | 1000kg |
| T (tesla) | 1 kg / A•s ² |
| tbsp (tablespoon) | 1.47867647813 x 10 ⁻⁵ m ³ |
| therm (EEC therm) | 105506000 kg•m ² / s ² |
| ton (short ton) | 907.18474 kg |
| tonUk (long ton (UK)) | 1016.0469088 kg |
| torr (torr (mmHg)) | 133.322368421 kg / m•s ² |
| tsp (teaspoon) | 4.92892159375 x 10 ⁻⁶ m ³ |
| u (unified atomic mass) | 1.6605402 x 10 ⁻²⁷ kg |
| V (volt) | 1 kg•m ² / A•s ³ |
| W (watt) | 1 kg•m / s ³ |
| Wb (weber) | 1 kg•m ² / A•s ² |
| yd (international yard) | .9144 m |
| yr (year) | 31556925.9747 s |

System Flags

This appendix lists the hp49g+/hp48gII system flags. You can set, clear, and test all flags, although certain flags are used for specific purposes by the CAS and should not be altered. The default state of the flags is *clear* — except for flags -17 , -27 , -34 , -90 , -95 and -128 and the Binary Integer Math flags (flags -5 through -12).

System Flags

| Flag | Description |
|-----------------------|---|
| -1 | Principal Solution. <i>Clear:</i> Symbolic commands return a result representing all possible solutions. <i>Set:</i> Symbolic commands return only the principal solution. |
| -2 | Symbolic Constants. <i>Clear:</i> Symbolic constants (e , i , π , MAXR, and MINR) retain their symbolic form when evaluated, unless the Numerical Results flag -3 is set. <i>Set:</i> Symbolic constants evaluate to numbers, regardless of the state of the Numerical results flag -3 . |
| -3 | Numerical Results. <i>Clear:</i> Functions with symbolic arguments, including symbolic constants, evaluate to symbolic results. <i>Set:</i> Functions with symbolic arguments, including symbolic constants, evaluate to numbers. |
| -4 | <i>Not used.</i> (Originally intended to control the careful evaluation mode in the HP 48SX, without ever being implemented, though). |
| -5 thru -10 | Binary Integer Wordsize. Combined states of flag -5 through -10 (the most significant bit) set the wordsize from 1 to 64 bits. |
| -11 and -12 | Binary Integer Base. HEX (default): -11 set, -12 set. DEC: -11 clear, -12 clear. OCT: -11 set, -12 clear. BIN: -11 clear, -12 set. |
| -13 | <i>Not used.</i> |
| -14 | Financial Payment Mode. <i>Clear:</i> TVM calculations assume end-of-period payments. <i>Set:</i> TVM calculations assume beginning-of-period payments. |
| -15 and -16 | Coordinate System. Rectangular: -16 clear. Polar/Cylindrical: -15 clear, -16 set. Polar/Spherical: -15 set, -16 set. |
| -17 and -18 | Trigonometric Angle Mode. Radians (default): -17 set. Degrees: -17 clear, -18 clear. Grads: -17 clear, -18 set. |

System Flags (continued)

| Flag | Description |
|--------------------------|--|
| -19 | Vector/Complex. <i>Clear:</i> →V2 creates a 2-dimensional vector from 2 real numbers. <i>Set:</i> →V2 creates a complex number from 2 real numbers. |
| -20 | Underflow Exception. <i>Clear:</i> Underflow exception returns 0, sets flag -23 or -24. <i>Set:</i> Underflow exception treated as an error. |
| -21 | Overflow Exception. <i>Clear:</i> Overflow exception returns $\pm 9.999999999999999E499$ and sets flag -25. <i>Set:</i> Overflow exception treated as an error. |
| -22 | Infinite Result Exception. <i>Clear:</i> Infinite result exception treated as an error. <i>Set:</i> Infinite result exception returns $\pm 9.999999999999999E499$ and sets flag -26. |
| -23 -24 -25 -26 | Negative Underflow Indicator. Positive Underflow Indicator. Overflow Indicator. Infinite Result Indicator. When an exception occurs, corresponding flag (-23 through -26) is set only if the exception is not treated as an error. |
| -27 | Display of symbolic complex numbers. <i>Clear:</i> Displays symbolic complex numbers in coordinate form (i.e. ' $x+yi$ '). <i>Set (default):</i> Displays symbolic complex numbers using ' i ' (i.e. ' $x+yi$ '). |
| -28 | Simultaneous Plotting of Multiple Functions. <i>Clear:</i> Multiple equations are plotted serially. <i>Set:</i> Multiple equations are plotted simultaneously. |
| -29 | Draw Axes. <i>Clear:</i> Axes are drawn for two-dimensional and statistical plots. <i>Set:</i> Axes are not drawn for two-dimensional and statistical plots. |
| -30 | <i>Not used.</i> |
| -31 | Curve Filling. <i>Clear:</i> Curve filling between plotted points enabled. <i>Set:</i> Curve filling between plotted points suppressed. |
| -32 | Graphics Cursor. <i>Clear:</i> Graphics cursor always dark. <i>Set:</i> Graphics cursor dark on light background and light on dark background. |
| -33 | I/O Device. <i>Clear:</i> I/O directed to USB/serial port. <i>Set:</i> I/O directed to IrDA port. |









System Flags (continued)

| Flag | Description |
|--------------------|--|
| -34 | <p>Printing Device.</p> <p><i>Clear:</i> Prints via IR to the HP82240 printer. Flag -33 is ignored.</p> <p><i>Set (default):</i> Printer output directed to USB/serial port if flag -33 is clear, or to IrDA compatible printer otherwise.</p> |
| -35 | <p>Kermit I/O Data Format.</p> <p><i>Clear:</i> Objects transmitted in ASCII form.</p> <p><i>Set:</i> Objects transmitted in binary (memory image) form.</p> |
| -36 | <p>I/O Receive Overwrite.</p> <p><i>Clear:</i> If file name received by HP 49G+/48GII matches existing variable name, new variable name with number extension is created to prevent overwrite.</p> <p><i>Set:</i> If file name received by HP 49G+/48GII matches existing variable name, existing variable is overwritten.</p> |
| -37 | <p>Double-Spaced Printing.</p> <p><i>Clear:</i> Single-spaced printing.</p> <p><i>Set:</i> Double-spaced printing.</p> |
| -38 | <p>Line Feed.</p> <p><i>Clear:</i> Linefeed added at end of each print line.</p> <p><i>Set:</i> No linefeed added at end of each print line.</p> |
| -39 | <p>I/O Messages.</p> <p><i>Clear:</i> I/O messages displayed.</p> <p><i>Set:</i> I/O messages suppressed.</p> |
| -40 | <p>Clock Display.</p> <p><i>Clear:</i> Clock is not displayed.</p> <p><i>Set:</i> Ticking clock displayed at all times, provided the header height is 2.</p> |
| -41 | <p>Clock Format.</p> <p><i>Clear:</i> 12-hour clock.</p> <p><i>Set:</i> 24-hour clock.</p> |
| -42 | <p>Date Format.</p> <p><i>Clear:</i> Month/Day format.</p> <p><i>Set:</i> Day/Month format.</p> |
| -43 | <p>Repeat Alarm Not Rescheduled.</p> <p><i>Clear:</i> Unacknowledged repeat appointment alarms automatically rescheduled.</p> <p><i>Set:</i> Unacknowledged repeat appointment alarms not rescheduled.</p> |
| -44 | <p>Acknowledged Alarms Saved.</p> <p><i>Clear:</i> Acknowledged appointment alarms deleted from alarm list.</p> <p><i>Set:</i> Acknowledged appointment alarms saved in alarm list.</p> |
| -45 thru -48 | <p>Number of Decimal Digits.</p> <p>Combined states of flags -45 through -48 sets the number of decimal digits in Fix, Scientific, and Engineering modes.</p> |

System Flags (continued)

| Flag | Description |
|--------------------|---|
| -49 thru -50 | Number Display Format. <i>Standard:</i> -49 <i>clear</i> , -50 <i>clear</i> . <i>Fix:</i> -49 <i>set</i> , -50 <i>clear</i> . <i>Scientific:</i> -49 <i>clear</i> , -50 <i>set</i> . <i>Engineering:</i> -49 <i>set</i> , -50 <i>set</i> . |
| -51 | Fraction Mark. <i>Clear:</i> Fraction mark is . (period). <i>Set:</i> Fraction mark is , (comma). |
| -52 | Single-Line Display. <i>Clear:</i> Display gives preference to object in level 1, using multiple lines of stack display. <i>Set:</i> Display of object in level 1 restricted to one line. |
| -53 | Precedence. <i>Clear:</i> Certain parentheses in algebraic expressions suppressed to improve legibility. <i>Set:</i> All parentheses in algebraic expressions displayed. |
| -54 | Tiny Array Elements. <i>Clear:</i> Singular values computed by RANK (and other commands that compute the rank of a matrix) that are more than 1×10^{-14} times smaller than the largest computed singular value in the matrix are converted to zero. Automatic rounding for DET is enabled. <i>Set:</i> Small computed singular values (see above) not converted. Automatic rounding for DET is disabled. |
| -55 | Last Arguments. <i>Clear:</i> Command arguments saved. <i>Set:</i> Command arguments not saved. |
| -56 | Error Beep. <i>Clear:</i> Error, key click and BEEP-command beeps enabled. <i>Set:</i> Error, key click and BEEP-command beeps suppressed. |
| -57 | Alarm Beep. <i>Clear:</i> Alarm beep enabled. <i>Set:</i> Alarm beep suppressed. |
| -58 | Verbose Messages. <i>Clear:</i> Parameter variable data automatically displayed. <i>Set:</i> Automatic display of parameter variable data is suppressed. |
| -59 | <i>No longer used.</i> (It was the Fast Catalog/Browser Display flag in the HP 48SX/GX). |
| -60 | Units Type. <i>User flag.</i> <i>Clear:</i> CONST returns values in SI units. <i>Set:</i> CONST returns values in English units. |
| -61 | Units Usage. <i>User flag.</i> <i>Clear:</i> CONST uses units. <i>Set:</i> CONST uses no units. |

System Flags (continued)

| Flag | Description |
|------|---|
| -60 | Alpha Lock. <i>Clear:</i> Single-Alpha activated by pressing  once. Alpha lock activated by pressing  twice. <i>Set:</i> Alpha lock activated by pressing  once. (Single-Alpha not available.) |
| -61 | User-Mode Lock. <i>Clear:</i> 1-User mode activated by pressing  once. User mode activated by pressing  twice. <i>Set:</i> User mode activated by pressing  once. (1-User mode not available.) |
| -62 | User Mode. <i>Clear:</i> User mode not active. <i>Set:</i> User mode active. |
| -63 | Vectored  . <i>Clear:</i>  evaluates command line. <i>Set:</i> User-defined  activated. |
| -64 | Index Wrap Indicator. <i>Clear:</i> Last execution of GETI or PUTI did not increment index to first element. <i>Set:</i> Last execution of GETI or PUTI did increment index to first element. |
| -65 | Multi-line Mode. <i>Clear:</i> Displays all levels over multiple lines. <i>Set:</i> Displays only the first level over multiple lines. Depends on flag -52. |
| -66 | Multi-line Strings. <i>Clear:</i> Displays long strings in multiple lines. <i>Set:</i> Displays long strings in single lines. Depends on flags -52 and -65. |
| -67 | Digital Clock. <i>Clear:</i> When the clock is displayed (see flag -40), it is digital-style. <i>Set:</i> When the clock is displayed (see flag -40), it is analog-style. |
| -68 | Auto-indenting. <i>Clear:</i> Command line does not automatically indent, like HP 48GX. <i>Set:</i> Command line automatically indents. |
| -69 | Full-screen Editing. <i>Clear:</i> The cursor cannot move out of the text line, like HP 48GX. <i>Set:</i> Full-screen editing allowed. |
| -70 | Multi-line Text Grobs. <i>Clear:</i> →GROB can accept only single-line strings. Newlines are turned into blobs. <i>Set:</i> →GROB can accept multi-line strings. |
| -71 | Disassembler Addresses. <i>Clear:</i> Disassembler shows (non-re-assemblable) addresses. <i>Set:</i> Disassembler does not show addresses. |

System Flags (continued)

| Flag | Description |
|------|--|
| -72 | Stack Font. <i>Clear:</i> The stack display uses the current system font. <i>Set:</i> The stack display uses mini-font. |
| -73 | Command Line Font. <i>Clear:</i> Command line editing uses the current system font. <i>Set:</i> Command line editing uses mini-font. |
| -74 | Stack Setting. <i>Clear:</i> The stack is right-justified, like the HP 48GX calculator. <i>Set:</i> The stack is left-justified. |
| -75 | Keystroke Beep. <i>Clear:</i> Silent keyboard. <i>Set:</i> Key click activated if flag -56 is clear. |
| -76 | File Manager Purge Confirmation. <i>Clear:</i> File Manager purges need confirmation. <i>Set:</i> No purge confirmation in File Manager. |
| -77 | Filer Confirmation flag. <i>Not used.</i> |
| -78 | Kernel parameter. <i>Not used.</i> |
| -79 | Pretty Print Mode. <i>Clear:</i> Algebraic objects appear on the stack in textbook (EQW) form. (Only in multi-line levels, see flag -65). <i>Set:</i> Algebraic objects appear on the stack in linear form. |
| -80 | Font used to show algebraics on stack if flag -79 is clear. <i>Clear:</i> Textbook stack display uses the current system font. <i>Set:</i> Textbook stack display uses mini-font. |
| -81 | Font used by →GROB on algebraics. <i>Clear:</i> Editing a textbook grob uses current font. <i>Set:</i> Editing a textbook grob uses mini-font. |
| -82 | Equation Writer Font. <i>Clear:</i> Current font used to edit algebraics in textbook mode. <i>Set:</i> Mini-font used to edit algebraics in textbook mode. |
| -83 | Grob Display. <i>Clear:</i> Grob contents (picture) displayed on the stack. <i>Set:</i> Grob description (dimensions) displayed on the stack. |
| -84 | Menu Font Size. <i>Not used.</i> |
| -85 | Stack Display. <i>Clear:</i> Standard stack display. <i>Set:</i> System-RPL stack display. In textbook mode (see flag -79), objects displayed on multiple lines (see flag -65) are always shown in standard form. |
| -86 | Program Prefix. <i>Clear:</i> Program prefix off. <i>Set:</i> Program prefix on. |

System Flags (continued)

| Flag | Description |
|------|--|
| -87 | Recursive Stack Display. <i>Clear:</i> Non-recursive stack display. <i>Set:</i> In System-RPL stack display (see flag -85), unsupported (unnamed) entry points are exploded into their elements. |
| -88 | Recursive Editing. <i>Not used.</i> |
| -89 | Extable Library Usage. <i>Not used.</i> |
| -90 | Choose Box Font. <i>Clear:</i> Choose boxes displayed in current font. <i>Set (default):</i> Choose boxes displayed in mini-font. |
| -91 | Matrix Writer Object Type. <i>Clear:</i> Matrix Writer returns arrays only, like the HP 48GX calculator. <i>Set:</i> Matrix Writer returns a list of lists. |
| -92 | Assembler Mode. <i>Clear:</i> Assembler defaults to making code objects. <i>Set:</i> Assembler defaults to making System-RPL programs. |
| -93 | Erable Header. <i>Not used.</i> |
| -94 | Auto-saving. <i>Clear:</i> In RPN mode, results are stored in LASTCMD. <i>Set:</i> In RPN mode, results are not stored in LASTCMD. |
| -95 | Entry Mode. <i>Clear:</i> RPN mode <i>Set (default):</i> Algebraic mode. |
| -96 | Soft Menu Toggle Switch. <i>Not used.</i> |
| -97 | Vertical Lists. <i>Clear:</i> Lists on stack are displayed horizontally only, like HP 48GX. <i>Set:</i> Lists are displayed vertically. |
| -98 | Vertical Vectors. <i>Clear:</i> Vectors on stack are displayed horizontally only, like HP 48GX. <i>Set:</i> Vectors are displayed vertically. |
| -99 | Verbose CAS Mode. <i>Clear:</i> CAS concise mode. <i>Set:</i> CAS verbose mode. |
| -100 | Step-by-step CAS Mode. <i>Clear:</i> Step-by-step mode. <i>Set:</i> Final result mode. |
| -101 | <i>Internal use only.</i> (Set if VXXL success). |
| -102 | GCD Computations. <i>Clear:</i> GCD computations allowed. <i>Set:</i> No GCD computations. |
| -103 | Real/Complex Mode. <i>Clear:</i> Real mode. "R" annunciator in header. <i>Set:</i> Complex mode. "C" annunciator in header. |
| -104 | <i>Internal use only.</i> (If set, LN→ -INV[-LN]). |

System Flags (continued)

| Flag | Description |
|------|--|
| -105 | Exact/Approximate Mode. <i>Clear:</i> Exact mode. “=” annunciator in header. <i>Set:</i> Approximate mode, like HP 48GX. “~” annunciator in header. |
| -106 | TSIMP Calls. <i>Clear:</i> TSIMP calls are allowed in SERIES. <i>Set:</i> TSIMP calls are not allowed in SERIES. |
| -107 | <i>Internal use only.</i> (Modular computation). |
| -108 | <i>Internal use only.</i> (Testing reminder to be zero). |
| -109 | Numeric/Symbolic Factorization. <i>Clear:</i> Numeric factorization is not allowed. <i>Set:</i> Numeric factorization is allowed. |
| -110 | Large Matrices. <i>Clear:</i> Use normal-size-matrix code, like HP 48GX. <i>Set:</i> Use code optimized for large matrices. |
| -111 | Simplifying Inside Non-rational Expressions. <i>Clear:</i> Recursive simplification in EXPAND and TSIMP. <i>Set:</i> No recursive simplification in EXPAND and TSIMP. |
| -112 | Simplifying ‘i’. <i>Clear:</i> ‘i’ can be simplified (i.e. $i^2 = -1$) <i>Set:</i> ‘i’ cannot be simplified. |
| -113 | Linear Simplification Mode. <i>Clear:</i> Apply linearity simplification when using integration CAS commands. <i>Set:</i> Do not apply linearity simplification when using integration CAS commands. |
| -114 | Polynomial Term Order. <i>Clear:</i> Polynomial expressed in decreasing power order. <i>Set:</i> Polynomial expressed in increasing power order. |
| -115 | SQRT Simplification. <i>Clear:</i> Square roots can be simplified. <i>Set:</i> Square roots cannot be simplified. |
| -116 | Trigonometric Manipulations. <i>Clear:</i> Simplification to cosine terms. <i>Set:</i> Simplification to sine terms. |
| -117 | Menu Display Mode. <i>Clear:</i> Menus displayed as choose boxes. <i>Set:</i> Menus displayed as softkeys, like HP 48GX. |
| -118 | INT Simplification. <i>Clear:</i> INT is simplified. <i>Set:</i> INT is not simplified. |
| -119 | Rigorous Mode. <i>Clear:</i> Rigorous mode on: $ X $ is not simplified to X . <i>Set:</i> Rigorous mode off: $ X $ is simplified to X . |
| -120 | Silent Mode Switch. <i>Clear:</i> Calculator prompts when it needs to change modes. <i>Set:</i> Calculator changes modes when necessary without prompting. |

System Flags (continued)

| Flag | Description |
|------|--|
| -121 | <i>Internal use only.</i> (LN returns LN[ABS()] if set). |
| -122 | <i>Internal use only.</i> (0/0 occurred). |
| -123 | Mode Switch. <i>Clear:</i> Mode switch allowed. <i>Set:</i> Mode switch not allowed. |
| -124 | CAS Object Evaluation. <i>Clear:</i> Non-algebraic CASCOMPEVAL is allowed. <i>Set:</i> Non-algebraic CASCOMPEVAL is not allowed. |
| -125 | Sign Determination Mode. <i>Clear:</i> Accurate sign determination using polynomial Sturm sequences. <i>Set:</i> Fast sign determination. Polynomial Sturm sequences are not used. Auto-simplification of square roots canceled. |
| -126 | Row Reduction Mode. <i>Clear:</i> RREF done with last column. <i>Set:</i> RREF done without last column. |
| -127 | <i>Not used.</i> |
| -128 | <i>Clear:</i> Complex variables allowed. <i>Set (default):</i> All variables are real. |

Reserved Variables

The hp49g+/hp48gII uses the following *reserved variables*. These have specific purposes, and their names are used as implicit arguments for certain commands. Avoid using these variables' names for other purposes, or you may interfere with the execution of the commands that use these variables.

You can change some of the values in these variables with programmable commands, while others require you to store new values into the appropriate place.

| Reserved Variable | What It Contains | Used By |
|-------------------|--------------------------------------|--|
| α ENTER | Program run on ENTER | Vectored ENTER |
| ALRMDAT | Alarm parameters. | TIME ALRM operations |
| β ENTER | Program run after ENTER | Vectored ENTER |
| CST | List defining the CST (custom) menu. | MENU,  CUSTOM |
| "der"- names | User-defined derivative. | ∂ |
| ENVSTACK | Flags and current path | PUSH, POP |
| EQ | Current equation. | ROOT, DRAW |
| EXITED | Program run after EDIT | EDIT |
| EXPR | Current expression. | SYMBOLIC |
| IOPAR | I/O parameters. | I/O commands |
| MASD.INI | Valid source code. | Compiler |
| MHpar | Minehunt game status. | MINEHUNT |
| Mpar | Multiple-Equation Solver equations. | EQ LIB |
| $n1, n2, \dots$ | Arbitrary integers. | ISOL, QUAD |
| Nmines | Minehunt game data. | MINEHUNT |
| PPAR | Plotting parameters. | DRAW |
| PRTPAR | Printing parameters. | PRINT commands |
| REALASSUME | List of variable names of reals | CAS |

| Reserved Variable | What It Contains | Used By |
|-------------------|---------------------------|------------------------------|
| <i>STARTED</i> | Program run on EDIT | EDIT |
| <i>STARTEQW</i> | CST Commands list for EQW | Equation Writer |
| <i>STARTERR</i> | Program run on error | Error processing |
| <i>STARTOFF</i> | Program run at turnoff | OFF |
| <i>STARTRECV</i> | Program run at RECV | Filer, RECV |
| <i>STARTSEND</i> | Program run at SEND | Filer, SEND |
| <i>STARTUP</i> | Program run at reset | Reset |
| <i>s1, s2,...</i> | Arbitrary signs. | ISOL, QUAD |
| <i>TOFF</i> | Time in ticks until OFF | Turnoff delay |
| <i>VPAR</i> | Viewing parameters. | DRAW |
| <i>ZPAR</i> | Plot zoom factors. | DRAW |
| <i>ΣDAT</i> | Statistical data. | Statistics application, DRAW |
| <i>ΣPAR</i> | Statistical parameters. | Statistics application, DRAW |

Contents of the Reserved Variables

Most reserved variables (except *ALRMDAT*, *IOPAR* and *PRTRAT*) can be stored with different contents in different directories. This allows you, for example, to save several sets of statistical data in different directories.

αENTER

This is the vectored ENTER pre-processor. It is active when flags -62 and -63 are set. When ENTER is pressed, the command line is placed on the stack as a string and αENTER is executed.

ALRMDAT

ALRMDAT does not reside in a particular directory. You cannot access the variable itself, but you can access its data from any directory using the RCLALARM and STOALARM commands, or through the Alarm Catalog.

ALRMDAT contains a list of these alarm parameters:

| Parameter (Command) | Description | Default Value |
|---------------------|--|-----------------------------------|
| <i>date</i> (→DATE) | A real number specifying the date of the alarm: <i>MM.DDYYYY</i> (or <i>DD.MMYYYY</i> if flag -42 is set). If <i>YYYY</i> is not included, the current year is used. | Current date. |
| <i>Time</i> (→TIME) | A real number specifying the time of the alarm: <i>HH. MMSS</i> . | 00.0000 |
| <i>action</i> | A string or object: <ul style="list-style-type: none"> ■ a string creates an <i>appointment alarm</i>, which beeps and displays the string ■ any other object creates a <i>control alarm</i>, which executes the object | Empty string (appointment alarm). |
| <i>Repeat</i> | A real number specifying the interval between automatic recurrences of the alarm, given in ticks (a tick is $1/8192$ of a second). | 0 |





Parameters without commands can be modified with a program by storing new values in the list contained in ALRMDAT (use the PUT command).

βENTER

This is the vectored ENTER post-processor. If flags -62 and -63 are set and ENTER is pressed, the command that triggered the command-line processing is put on the stack as a string and βENTER is evaluated.

CST

CST contains a list (or a name specifying a list) of the objects that define the CST (*custom*) menu. Objects in the custom menu behave as do objects in built-in menus. For example:

- Names behave like the VAR menu keys. Thus, if *ABC* is a variable name,  evaluates *ABC*,  recalls its contents, and   stores new contents in *ABC*.
- The menu label for the name of a directory has a bar over the left side of the label; pressing the menu key switches to that directory.
- Unit objects act like unit catalog entries (and have left-shifted conversion capabilities, for example).
- String keys echo the string.
- You can include backup objects in the list defining a custom menu by tagging the name of the backup object with its port location.

You can specify menu labels and key actions independently by replacing a single object within the custom-menu list with a list of the form `{ "label-object" action-object }`.

To provide different shifted actions for custom menu keys, *action-object* can be a list containing three action objects in this order:

- The unshifted action (required if you want to specify the shifted actions).
- The left-shifted action.
- The right-shifted action.

ENVSTACK

ENVSTACK is a variable stored in the CAS directory. It is used by PUSH and POP to save the status of flags and the current directory. (PUSH saves the data in ENVSTACK; POP restores it.)

EQ

EQ contains the current equation or the name of the variable containing the current equation,

EQ supplies the equation for ROOT, as well as for the plotting command DRAW. (*ΣDAT* supplies the information when the plot type is HISTOGRAM, BAR, or SCATTER.)

The object in *EQ* can be an algebraic object, a number, a name, or a program. How DRAW interprets *EQ* depends on the plot type.

For graphics use, *EQ* can also be a list of equations or other objects. If *EQ* contains a list, then DRAW treats each object in turn as the current equation, and plots them successively. However, ROOT in the HP Solve application cannot solve an *EQ* containing a list.

To alter the contents of *EQ*, use the command STEQ.

EXITED

EXITED can be stored in any directory. If there is an EXITED program that exists in the path, it will be called upon exiting the command line. This can be used in conjunction with STARTED, for instance, to set a header size of 0 when entering the command line and restore it to 2 when exiting (in order to increase the editor window size). Note, this is only valid when entering the command line through a EDIT function.

EXPR

EXPR contains the current algebraic expression (or the name of the variable containing the current expression) used by the SYMBOLIC application and its associated commands. The object in *EQ* must be an algebraic or a name.

IOPAR

IOPAR is a variable in the HOME directory that contains a list of the I/O parameters needed for a communications link with a computer. It is created the first time you transfer data or open the serial port (OPENIO), and is automatically updated whenever you change the I/O settings. All *IOPAR* parameters are integers.

| Parameter (Command) | Description | Default Value |
|-----------------------------------|--|----------------------|
| <i>baud</i> (BAUD) | The baud rate: 2400, 4800, 9600, 14400, 19200, 38400 or 115200. | 9600 |
| <i>parity</i> (PARITY) | The parity used: 0=none, 1=odd, 2=even, 3=mark, 4=space. The value can be positive or negative: a positive parity is used upon both transmit and receive; a negative parity is used only upon transmit. | 0 |
| <i>receive pacing</i> | Controls whether receive pacing is used: a nonzero real value enables pacing, while zero disables it. Receive pacing sends an XOFF signal when the receive buffer is almost full, and sends an XON signal when it can take more data again. Pacing is not used for Kermit I/O, but is used for other serial I/O transfers. | 0 (no pacing) |
| <i>transmit pacing</i> | Controls whether transmit pacing is used: a nonzero real value enables pacing, while zero disables it. Transmit pacing stops transmission upon receipt of XOFF, and resumes transmission upon receipt of XON. Pacing is not used for Kermit I/O, but is used for other serial I/O transfers. | 0 (no pacing) |
| <i>checksum</i> (CKSM) | Error-detection scheme requested when initiating SEND: <ul style="list-style-type: none"> ■ 1=1-digit arithmetic checksum ■ 2=2-digit arithmetic checksum ■ 3=3-digit cyclic redundancy check. | 3 |
| <i>translation code</i> (TRANSIO) | Controls which characters are translated: <ul style="list-style-type: none"> ■ 0=none ■ 1=translate character 10 (line feed only) to / from characters 10 and 13 (line feed and carriage return) ■ 2=translate characters with numbers 128 through 159 (80-9F hex) ■ 3=translate characters with numbers 128 through 255. | 1 |

Parameters without commands can be modified with a program by storing new values in the list contained in *IOPAR* (use the PUT command), or by editing *IOPAR* directly.

MASD.INI

MASD.INI must contain valid MASD source code. This source code will be parsed/compiled before the source on the stack. It is useful to always include a basic set of commands or definitions in all compiled source.

MHpar

MHpar stores the status of an interrupted Minehunt game. *MHpar* is created when you exit Minehunt by pressing $\overline{\text{STOP}}$. If *MHpar* still exists when you restart Minehunt, the interrupted game resumes and *MHpar* is purged.

Mpar

Mpar is created when you use the Equation Library's Multiple-Equation Solver, and it stores the set of equations you're using.

When the Equation Library starts the Multiple-Equation Solver, it first stores a list of the equation set in *EQ*, and stores the equation set, a list of variables, and additional information in *Mpar*. *Mpar* is then used to set up the Solver menu for the current equation set.

Mpar is structured as library data dedicated to the Multiple Equation Solver application. This means that although you can view and edit *Mpar* directly, you can edit it only indirectly by executing commands that modify it.

You can also use the MINIT command to create *Mpar* from a set of equations on the stack.

n1, n2, ...

The ISOL and QUAD commands return *general* solutions (as opposed to *principal* solutions) or operations. A general solution contains variables for arbitrary integers or arbitrary signs, or both.

The variable *n1* represents an arbitrary integer 0, ± 1 , ± 2 , etc. Additional arbitrary integers are represented by *n2*, *n3*, etc.

If flag -1 is set, then ISOL and QUAD return principal solutions, in which case the arbitrary integer is always zero.

Nmines





Nmines is a variable you create in the current directory to control the number of mines used in the Minehunt game. *Nmines* contains an integer in the range 1 to 64; if *Nmines* is negative, the mines are visible during the game.

PPAR

PPAR is a variable in the current directory. It contains a list of plotting parameters used by the DRAW command for all mathematical and statistical plots, by AUTO for autoscaling, and by the interactive (nonprogrammable) graphics operations.

| Parameter (Command) | Description | Default Value |
|-----------------------------------|--|---|
| (x_{min}, y_{min}) (XRNG, YRNG) | A complex number specifying the lower left corner of <i>PICT</i> (the lower left corner of the display range). | (-6.5, -3.1) 48gII (-6.5, -3.9) 49g+ |
| (x_{max}, y_{max}) (XRNG, YRNG) | A complex number specifying the upper right corner of <i>PICT</i> (the upper right corner of the display range). | (6.5, 3.2) 48gII (6.5, 4.0) 49g+ |
| <i>indep</i> (INDEP) | A name specifying the independent variable, or a list containing that name and two numbers that specify the minimum and maximum values for the independent variable (the plotting range). | <i>X</i> |
| <i>res</i> (RES) | Resolution. A real number specifying the interval between values of the independent variable. For plots of equations, this determines the plotting interval along the <i>x</i> -axis. A binary number specifies the <i>pixel</i> resolution (how many columns of pixels between points). An integer specifies the resolution in <i>user</i> units (how many user units between points). Resolution for statistical plots is different (see below). | 0 |
| <i>axes</i> (AXES) | A complex number specifying the user-unit coordinates of the plot origin, or a list containing the following: <ul style="list-style-type: none"> ■ the complex number specifying the origin ■ a real number, binary integer, or list containing two real numbers or binary integers specifying the tick-mark annotation (see ATICK) ■ two strings specifying labels for the horizontal and vertical axes | (0, 0) |
| <i>ptype</i> (BAR, etc.) | A command name specifying the plot type (BAR, CONIC, DIFFEQ, FAST3D, FUNCTION, GRIDMAP, HISTOGRAM, PARAMETRIC, PARSURFACE, PCONTOUR, POLAR, SCATTER, SLOPEFIELD, TRUTH, WIREFRAME, or YSLICE). | FUNCTION |
| <i>depend</i> (DEPND) | A name specifying the dependent variable, or a list containing the name and two numbers that specify vertical plotting range. For DIFFEQ, the second element of the list may also be a real vector that represents the initial value. | <i>Y</i> |

Parameters without commands can be modified with a program *y* storing new values in the list contained in *PPAR* (use the PUT command).

The  operation ( & 2D/3D  ) resets the *PPAR* parameters (except *ptype*) to their default values, and erases *PICT*. (Note: the & means to press and hold the  key while pressing 2D/3D).

Note that *res* behaves differently for the statistical plot types BAR, HISTOGRAM, and SCATTER than for other plot types. For BAR, *res* specifies bar width; for HISTOGRAM, *res* specifies bin width; *res* does not affect SCATTER.

PRTPAR

PRTPAR is a variable in the *HOME* directory that contains a list of printing parameters. It is created automatically the first time you use a printing command.

| Parameter (Command) | Description | Default Value |
|--|---|-------------------------------|
| <i>delay time</i> (DELAY) | A real number, in the range 0 to 6.9, specifying the number of seconds the HP 49 waits between sending lines. This should be at least as long as the time required to print the longest line. If the delay is too short for the printer, you will lose data. The delay setting also affects serial printing if transmit-pacing (in <i>IOPAR</i>) is not being used. | 1.8 |
| <i>remap</i> (OLDPRT stores the character-remapping string for the HP 82240A Infrared Printer) | A string defining the current remapping of the extended character set for printing. The string can contain as many characters as you want to remap, with the first character being the new character 128, the second being the new character 129, etc. (Any character number that exceeds the string length will not be remapped.) See the example below. | Empty string. |
| <i>line length</i> | A real number specifying the number of characters in a line for serial printing. This does <i>not</i> affect infrared printing. | 80 |
| <i>line termination</i> | A string specifying the line-termination method for serial printing. This does <i>not</i> affect infrared printing. Note that control character 13 is the carriage return and 10 is the line feed. | Control characters 13 and 10. |

Parameters without modified commands can be modified with a program by storing new values in the list contained in *PRTPAR* (use the PUT command).

Example: If the remapping string were “ABCDEFGH” and the character to be printed had value 131, then the character actually printed would be “D”, since 131–128=3 and “A” has the value zero. A character code of 136 or greater would not be remapped since 136–128=8, which exceeds the length of the string.

REALASSUME

The variable REALASSUME contains a list of variables which the CAS assumes are real values.

STARTED

If it exists, the STARTED variable is evaluated when the command-line editor is evaluated.

STARTEQW

If it exists, the STARTEQW variable is evaluated whenever an element in the Equation Writer is selected.

STARTERR

If it exists, the STARTERR variable is evaluated whenever an error message is displayed.

STARTOFF

If it exists, the STARTOFF variable is evaluated when the calculator turnsoff automatically.

STARTRECV

If it exists, the STARTRECV variable is evaluated when the user presses RECV from inside the Filer. It takes as an argument, the selected argument's name.

STARTSEND

If it exists, the STARTSEND variable is evaluated when the user presses SEND from inside the Filer. It takes as arguments the selected object and its name.

STARTUP

If it exists, the STARTUP variable is evaluated when the calculator warm starts.

s1, s2, ...

The ISOL and QUAD commands return *general* solutions (as opposed to *principal* solutions) for operations. A general solution contains variables for arbitrary integers or arbitrary signs or both.

The variable *s1* represents an arbitrary + or – sign. Additional arbitrary signs are represented by *s2*, *s3*, etc.

If flag –1 is set, the ISOL and QUAD return principal solutions, in which case the arbitrary sign is always +1.

TOFF

TOFF contains a binary integer #xxxxh that defines the number of clock ticks until the next calculator auto shutoff (with a default of 5 minutes or 6*60*8192 ticks)

VPAR

VPAR is a variable in the current directory. It contains a list of parameters used by the 3D plot types. The main data structure stored in VPAR describes the “view volume,” the abstract three-dimensional region in which the function is plotted.

| Parameter (Command) | Description | Default Value |
|---|---|---------------|
| (x_{left} , x_{right}) (XVOL) | Real numbers that specify the width of the view volume. | (-1, 1) |
| (y_{far} , y_{near}) (YVOL) | Real numbers that specify the depth of the view volume. | (-1, 1) |
| (z_{low} , z_{high}) (ZVOL) | Real numbers that specify the height of the view volume. | (-1, 1) |
| (x_{eye} , y_{eye} , z_{eye}) (EYEPT) | Real numbers that specify the point in space from which the plot is viewed. | (0, -3, 0) |
| (x_{step} , y_{step}) (NUMX, NUMY) | Real numbers that specify the increments between of x-coordinates and y-coordinates plotted. The increments are equal to the range for the axes divided by the number of steps. Used instead of (or in combination with) <i>res</i> . | (10, 8) |
| (x_{xleft} , x_{xright}) (XXRNG) | Real numbers that specify the width of the input plane (domain). Used by GRIDMAP and PARSURFACE. | (-1, 1) |
| (y_{yfar} , y_{ynear}) (YYRNG) | Real numbers that specify the depth of the input plane (domain). Used by GRIDMAP and PARSURFACE. | (-1, 1) |

Parameters without commands can be modified programmatically by storing new values in the list contained in *VPAR* (use the PUT command).

ZPAR

ZPAR is a variable in the current directory. It contains a list of zooming parameters used by the DRAW command for all 2-D mathematical and statistical plots.

| Parameter (Command) | Description | Default Value |
|----------------------|--|---------------|
| <i>h-factor</i> | Real number that specifies the horizontal zoom factor. | 4 |
| <i>v-factor</i> | Real number that specifies the vertical zoom factor. | 4 |
| <i>recenter flag</i> | 0 or 1 depending on whether the recenter at crosshairs option was selected in the set zoom factors input form. | 0 |
| { <i>list</i> } | An empty list, or a copy of the last <i>PPAR</i> . | |

Use the set zoom factors input form () to modify *ZPAR*.

ΣDAT

ΣDAT is a variable in the current directory that contains either the current statistical matrix or the name of the variable containing this matrix. This matrix contains the data used by the Statistics applications.

| | | | |
|----------|----------|----------|----------|
| var_1 | var_2 | ... | var_m |
| x_{11} | x_{21} | ... | x_{m1} |
| x_{12} | x_{22} | ... | x_{m2} |
| \vdots | \vdots | \vdots | \vdots |
| x_{1n} | x_{2n} | ... | x_{mn} |

Statistical Matrix for Variables 1 to m

You can designate a new current statistical matrix by entering new data, editing the current data, or selecting another matrix.

The command $CL\Sigma$ clears the current statistical matrix.

ΣPAR

ΣPAR is a variable in the current directory that contains either the current statistical parameter list or the name of the variable containing this list.

| Parameter (Command) | Description | Default Value |
|----------------------------|--|----------------------|
| $column_{indep}$ (XCOL) | A real number specifying the independent-variable's column number. | 1 |
| $column_{dep}$ (YCOL) | A real number specifying the dependent-variable's column number. | 2 |
| $intercept$ (LR) | A real number specifying the coefficient of intercept as determined by the current regression. | 0 |
| $slope$ (LR) | A real number specifying the coefficient of slope as determined by the current regression. | 0 |
| $model$ (LINFIT, etc.) | A command specifying the regression model (LINFIT, EXPFIT, PWRFIT, or LOGFIT). | LINFIT |

Technical Reference

This appendix contains the following information:

- Object sizes.
- Mathematical simplification rules used by the hp49g+/hp48gII.
- Symbolic differentiation patterns used by the hp49g+/hp48gII.
- The Equation Writer's expansion rules.
- References and as sources for constants and equations in the hp49g+/hp48gII (other than those in the Equation Library).

Object Sizes

The following table lists object types and their size in bytes. (Note that characters in names, strings, and tags use 1 byte each.)

| Object Size | |
|-----------------------------|--|
| Object Type | Size (bytes) |
| Algebraic | 5 + size of included objects |
| Backup Object | 12 + number of name characters + size of included object |
| Binary Integer | 13 |
| Command | 2.5 |
| Complex matrix | 15 + 16 × number of elements |
| Complex number | 18.5 |
| Complex vector | 12.5 + 16 × number of elements |
| Directory | 6.5 + size of included variables + size of variable names + 2.5 bytes for header |
| Graphics Object | 10 + number of rows × CEIL (columns/8) |
| Integer | 2.5 or (5 + 0.5 × number of digits) |
| List | 5 + size of included objects |
| Matrix | 15 + 8 × number of elements |
| Program | 10 + size of included objects |
| Quoted global or local name | 8.5 + number of characters |
| Real number | 2.5 or 10.5 |
| String | 5 + number of characters |
| Tagged Object | 3.5 + number of tag characters + size of untagged object |

Object Size, continued

| Object Type | Size (bytes) |
|-------------------------------|-------------------------------|
| Unit object | 7.5 + |
| real magnitude | 2.5 or 10.5 |
| each prefix | 6 |
| each unit name | 5 + number of characters |
| each ×, ^, or / | 2.5 |
| each exponent | 2.5 or 10.5 |
| Unquoted global or local name | 3.5 + number of characters |
| Vector | 12.5 + 8 × number of elements |
| XLIB name | 5.5 |

Symbolic Integration Patterns

This table lists the symbolic integration patterns used by the hp49g+/hp48gII. These are the integrands that the hp49g+/hp48gII can integrate symbolically.

ϕ is a linear function of the variable of integration. The antiderivatives should be divided by the first-order coefficient in ϕ to reduce the expression to its simplest form. Also, patterns beginning with 1 / match INV: for example, $1 / \phi$ is the same as $INV(\phi)$.

Symbolic Integration

| Pattern | Antiderivative |
|--------------------------------------|--|
| $ACOS(\phi)$ | $\phi \times ACOS(\phi) - \sqrt{1 - \phi^2}$ |
| $ALOG(\phi)$ | $.434294481904 \times ALOG(\phi)$ |
| $ASIN(\phi)$ | $\phi \times ASIN(\phi) + \sqrt{1 - \phi^2}$ |
| $ATAN(\phi)$ | $\phi \times ATAN(\phi) - LN(1 + \phi^2) / 2$ |
| $COS(\phi)$ | $SIN(\phi)$ |
| $1 / (COS(\phi) \times SIN(\phi))$ | $LN(TAN(\phi))$ |
| $COSH(\phi)$ | $SINH(\phi)$ |
| $1 / (COSH(\phi) \times SINH(\phi))$ | $LN(TANH(\phi))$ |
| $1 / (COSH(\phi)^2)$ | $TANH(\phi)$ |
| $EXP(\phi)$ | $EXP(\phi)$ |
| $EXPM(\phi)$ | $EXP(\phi)$ |
| $LN(\phi)$ | $\phi \times LN(\phi) - \phi$ |
| $LOG(\phi)$ | $.434294481904 \times \phi \times LN(\phi) - \phi$ |
| $SIGN(\phi)$ | $ABS(\phi)$ |
| $SIN(\phi)$ | $-COS(\phi)$ |
| $1 / (SIN(\phi) \times COS(\phi))$ | $LN(TAN(\phi))$ |
| $1 / (SIN(\phi) \times TAN(\phi))$ | $-INV(SIN(\phi))$ |

Symbolic Integration (continued)

| Pattern | Antiderivative |
|--|--|
| $1/(\text{SIN}(\phi) \times \text{TAN}(\phi))$ | $-\text{INV}(\text{SIN}(\phi))$ |
| $1/(\text{SIN}(\phi)^2)$ | $-\text{INV}(\text{TAN}(\phi))$ |
| $\text{SINH}(\phi)$ | $\text{COSH}(\phi)$ |
| $1/(\text{SINH}(\phi) \times \text{COSH}(\phi))$ | $\text{LN}(\text{TANH}(\phi))$ |
| $1/(\text{SINH}(\phi) \times \text{TANH}(\phi))$ | $-\text{INV}(\text{SINH}(\phi))$ |
| $\text{SQ}(\phi)$ | $\phi^3/3$ |
| $\text{TAN}(\phi)^2$ | $\text{TAN}(\phi) - \phi$ |
| $\text{TAN}(\phi)$ | $-\text{LN}(\text{COS}(\phi))$ |
| $\text{TAN}(\phi)/\text{COS}(\phi)$ | $\text{INV}(\text{COS}(\phi))$ |
| $1/\text{TAN}(\phi)$ | $\text{LN}(\text{SIN}(\phi))$ |
| $1/\text{TAN}(\phi) \times \text{SIN}(\phi)$ | $-\text{INV}(\text{SIN}(\phi))$ |
| $\text{TANH}(\phi)$ | $\text{LN}(\text{COSH}(\phi))$ |
| $\text{TANH}(\phi)/\text{COSH}(\phi)$ | $\text{INV}(\text{COSH}(\phi))$ |
| $1/\text{TANH}(\phi)$ | $\text{LN}(\text{SINH}(\phi))$ |
| $1/\text{TANH}(\phi) \times \text{SINH}(\phi)$ | $-\text{INV}(\text{SINH}(\phi))$ |
| $\sqrt{\phi}$ | $2 \times \phi^{1.5}/3$ |
| $1/\sqrt{\phi}$ | $2 \times \sqrt{\phi}$ |
| $1/(2 \times \sqrt{\phi})$ | $2 \times \sqrt{\phi} \times .5$ |
| ϕ^z (z symbolic) | $\text{IFTE}(z = -1, \text{LN}(\phi), \phi^{(z+1)}/(z+1))$ |
| ϕ^z (z real, $\neq 0, -1$) | $\phi^{(z+1)}/(z+1)$ |
| ϕ^0 | ϕ |
| ϕ^{-1} | $\text{LN}(\phi)$ |
| $1/\phi$ | $\text{LN}(\phi)$ |
| $1/(1-\phi^2)$ | $\text{ATANH}(\phi)$ |
| $1/(1+\phi^2)$ | $\text{ATAN}(\phi)$ |
| $1/(\phi^2+1)$ | $\text{ATAN}(\phi)$ |
| $1/(\sqrt{\phi-1} \times \sqrt{\phi+1})$ | $\text{ACOSH}(\phi)$ |
| $1/\sqrt{1-\phi^2}$ | $\text{ASIN}(\phi)$ |
| $1/\sqrt{1+\phi^2}$ | $\text{ASINH}(\phi)$ |
| $1/\sqrt{\phi^2+1}$ | $\text{ASINH}(\phi)$ |

Trigonometric Expansions

The following tables list expansions for trigonometric functions in Radians mode when using the →DEF, TRG*, and →TRG operations. These operations appear in the Equation Writer RULES menu.

→DEF Expansions

| Function | Expansion |
|----------|---|
| SIN (x) | $\frac{EXP(x \times i) - EXP(-(x \times i))}{2 \times i}$ |
| COS (x) | $\frac{EXP(x \times i) + EXP(-(x \times i))}{2 \times i}$ |
| TAN (x) | $\frac{EXP(x \times i \times 2) - 1}{(EXP(x \times i \times 2) + 1) \times i}$ |
| SINH(x) | $-(SIN(x \times i) \times i)$ |
| COSH(x) | $COS(x \times i)$ |
| TANH(x) | $TAN(x \times i) \times -i$ |
| ASIN(x) | $-i \times LN(\sqrt{1 - x^2} + i \times x)$ |
| ACOS(x) | $\frac{\pi}{2} + i \times LN(\sqrt{1 - x^2} + i \times x)$ |
| ATAN(x) | $-i \times LN\left(\frac{(1 + i \times x)}{\sqrt{1 + x^2}}\right)$ |
| ASINH(x) | $-LN(\sqrt{1 + x^2} - x)$ |
| ACOSH(x) | $\sqrt{-\left(\frac{\pi}{2} + i \times LN(\sqrt{1 - x^2} + i \times x)\right)^2}$ |
| ATANH(x) | $-LN\left(\frac{(1 - x)}{\sqrt{1 - x^2}}\right)$ |

TRG* Expansions

| Function | Expansion |
|-------------|--|
| SIN (x + y) | $SIN(x) \times COS(y) + COS(x) \times SIN(y)$ |
| COS (x + y) | $COS(x) \times COS(y) - SIN(x) \times SIN(y)$ |
| TAN (x + y) | $\frac{TAN(x) + TAN(y)}{1 - TAN(x) \times TAN(y)}$ |
| SINH(x + y) | $SINH(x) \times COSH(y) + COSH(x) \times SINH(y)$ |
| COSH(x + y) | $COSH(x) \times COSH(y) + SINH(x) \times SINH(y)$ |
| TANH(x + y) | $\frac{TANH(x) + TANH(y)}{1 + TANH(x) \times TANH(y)}$ |

→TRG Expansions

| Function | Expansion |
|----------|--|
| EXP (x) | $COS\left(\frac{x}{i}\right) + SIN\left(\frac{x}{i}\right) \times i$ |

Source References

The following references were used as sources for many of the constants and equations used in the hp49g+/hp48gII. (See “References” in chapter 5, “Equation Reference,” for the references used as sources for the Equation Library.)

1. E.A. Mechtly. *The International System of Units, Physical Constants and Conversion Factors*, Second Revision. National Aeronautics and Space Administration, Washington DC, 1973.
2. *The American Heritage Dictionary*. Houghton Mifflin Company, Boston, MA, 1979.
3. *American National Standard Metric Practice ANSI/IEEE Std 268-1982*. The Institute of Electrical and Electronics Engineers, Inc., New York, 1982.
4. *ASTM Standard Practice for Use of the International System of Units (SI) E380-89a*. American Society for Testing and Materials, Philadelphia, 1989.
5. *Handbook of Chemistry and Physics*, 64th Edition, 1983-1984. CRC Press, Inc, Boca Raton, FL, 1983.
6. *International Standard publication No. ISO 31/l-1978 (E)*.
7. *The International System of Units (SI)*, Fourth Edition. The National Bureau of Standards Special Publication 330, Washington D.C., 1981.
8. *National Aerospace Standard*. Aerospace Industries Association of America, Inc., Washington D.C., 1977.
9. *Physics Letters B*, vol 204, 14 April 1988 (ISSN 0370-2693).

Parallel Processing with Lists

Parallel processing is the idea that, generally, if a command can be applied to one or more individual arguments, then it can also be extended to be applied to one or more *sets* of arguments. (Note: some examples assume approximate mode.)

Some examples:

- `5 INV` returns `.2`, so `{4 5 8} INV` returns `{.25 .2 .125}`.
- `4 5 *` returns `20`, so `{4 5 6} {5 6 7} *` returns `{20 30 42}`, and `{4 5 6} 5 *` returns `{20 25 30}`.

General rules for parallel processing

As a rule-of-thumb, a given command can use parallel list processing if all the following are true:

- The command checks for valid argument types. Commands that apply to all object types, such as `DUP`, `SWAP`, `ROT`, and so forth, do not use parallel list processing.
- The command takes exactly one, two, three, four, or five arguments, none of which may itself be a list. Commands that use an indefinite number of arguments (such as `→LIST`) do not use parallel list processing.
- The command isn't a programming branch command (`IF`, `FOR`, `CASE`, `NEXT`, and so forth).

The remainder of this appendix describes how the many and various commands available on the calculator are grouped with respect to parallel processing.

Group 1: Commands that cannot parallel process

A command must take arguments before it can parallel process, since a zero-argument command (such as `RAND`, `VARs`, or `REC`) has no arguments with which to form a group.

Group 2: Commands that must use DOLIST to parallel process

This group of commands cannot use parallel processing directly, but can be "coerced" into it using the `DOLIST` command (see Using D later in this appendix). This group consists of several subgroups:

- **Stack manipulation commands.** A stack manipulation command cannot parallel process because the stack is manipulated as a whole and list objects are treated the same as any other object. Stack commands (such as `DROP`) that take level 1 arguments will not accept level 1 list arguments.
- **Commands that operate on a list as a whole.** Certain commands accept lists as arguments but treat them no differently than any other data object. They perform their function on the object as a whole without respect to its elements. For example, `→STR` converts the entire list object to a string rather than converting each individual element, and the `==` command tests the level 1 object against the level 2 object regardless of the objects' types.
- **List manipulation commands.** List manipulation commands will not parallel process since they operate on list arguments as lists rather than as sets of parallel data. However, a list manipulation command can be forced to parallel process lists of lists by using the `DOLIST` command. For example, `{ {1 2 3} {4 5 6} } * TLIST * DOLIST` returns `{6 120}`.
- **Other commands that have list arguments.** Because a list can hold any number of objects of any type, it is commonly used to hold a variable number of parameters of various types. Some commands accept such lists, and because of this are insensitive to parallel processing, except by using `DOLIST`.

- **Index-oriented commands.** Many array commands either establish the size of an array in rows and columns or manipulate individual elements by their row and column indices. These commands expect these row and column indices to be real number pairs collected in lists. For example, `{3 4} RANM` will generate a random integer matrix having 3 rows and 4 columns. Since these commands can normally use lists as arguments, they cannot perform parallel processing, except by using DOLIST.

- **Program control commands.** Program control structures and commands do not perform parallel processing and cannot be forced to do so. However, programs containing these structures can be made to parallel process by using DOLIST. For example, `{1 2 3 4 5 6} 1 * IF DUP 3 ≤ THEN DROP END * DOLIST` returns `{3 4 5 6}`.

Group 3: commands that sometimes work with parallel processing

- Graphics commands that can take pixel coordinates as arguments expect those coordinates to be presented as two-element lists of binary integers. Since these commands can normally use lists as arguments, they cannot parallel process, except by using DOLIST.



- For the two-argument graphics commands (BOX, LINE, TLINE), if either argument is not a list (a complex number, for example), then the commands will parallel process, taking the list argument to be multiple complex number coordinates. For example, `{0,0} {(1,1) (3,2)} LINE` will draw two lines — between (0,0) and (1,1) and between (0,0) and (3,2).

Group 4: ADD and +

- On HP 48S and HP 48SX calculators, the + command has been used to append lists or to append elements to lists. Thus `{1 2 3} 4 +` returns `{1 2 3 4}`. With the advent of parallel processing in the hp 48g and hp49g series, the ADD command was created to perform parallel addition instead of +.

This has several ramifications:

- To add two lists in parallel, you must do one of the following:

- Use ADD from the  MTH  menu.
- Create a custom menu containing the ADD command.
- Assign the ADD command to a user-defined key.

- User programs must be written using ADD instead of + if the program is to be able to perform direct parallel processing, or written with + and applied to their arguments by using DOLIST. For example, programs such as `* ÷ × 'x+2' *` will produce list concatenation when x is a list rather than parallel addition, unless rewritten as `* ÷ × 'x ADD 2' *`

- Algebraic expressions capable of calculating with variables containing lists (including those intended to become user-defined functions) cannot be created in RPN syntax since using ADD to add two symbolic arguments concatenates the arguments with + rather than with ADD. For example, `'X' DUP 2 ^ SWAP 4 * ADD 'F(X)' SWAP =` produces `'F(X)=X^2+4*X'` rather than `'F(X)=X^2 ADD 4*X'`.

Group 5: Commands that set modes / states

Commands that store values in system-specific locations so as to control certain modes and machine states can generally be used to parallel process data. The problem is that each successive parameter in the list cancels the setting established by the previous parameter. For example, `{1 2 3 4 5} FIX` is effectively the same as `5 FIX`.

Group 6: One-argument, one-result commands

These commands are the easiest to use with parallel processing. Simply provide the command with a list of arguments instead of the expected single argument. Some examples:

`{1 -2 3 -4} ABS` returns `{1 2 3 4}`

F - 2 Parallel Processing With Lists

```
DEG {0 30 60 90} SIN returns {0. 5. 866025403784 1}
{1 A 'SIN(Z)'} INV returns {1 'INV(A)' 'INV(SIN(Z))'}
```

Group 7: Two -argument, one result commands

Two-argument commands can operate in parallel in any of three different ways:

- `{ list } { list }`
- `{ list } object`
- `object { list }`

In the first form, parallel elements are combined by the command:

```
{1 2 3} {4 5 6} % returns {.04 .1 .18}.
```

In the second form, the level 1 object is combined with each element in the level 2 list in succession:

```
{1 2 3} 30 %CH returns {2900 1400 900}.
```

In the third form, the level 2 object is combined with each element of the level 1 list in succession:

```
50 {1 2 3} %T returns {2 4 6}.
```

Group 8: Multiple-argument, one-result commands

Commands that take multiple (3, 4, or 5) arguments can perform parallel processing only if all arguments are lists. For example, `{ 'SIN(X)' 'COS(X)' 'TAN(X)' } {XXX} {000} ROOT` returns `{0 90 0}`. Notice that lists must be used even though the level 1 and level 2 lists each contain multiples of the same element.

Group 9: Multiple-result commands

Any command that allows parallel processing, but produces multiple results from its input data, will return its results as a single list. For example, `{1 2 3} {4 5 6} R→C C→R` produces `{1 4 2 5 3 6}` rather than the more expected `{1 2 3} {4 5 6}`.

The following `UNMIX` program will unmix the data given the number of expected result lists:

```
« OVER SIZE → l n s
« l n
  FOR j j s
    FOR i l i GET n
      STEP s n / →LIST
    NEXT
  »
»
```

Taking `{1 4 2 5 3 6}` from above as the result of `C→R` (a command which should return two results), `2 UNMIX` gives `{1 2 3} {4 5 6}`.

Group 10: Quirky commands

A few commands behave uniquely with respect to parallel processing:

- **DELALARM.** This command can take a list of arguments. Note, however, that deletions from early in the alarm list will change the alarm indices of the later alarm entries. Thus, if there are only three alarms, `{1 3} DELALARM` will cause an error, whereas `{3 1} DELALARM` will not.
- **DOERR.** This command forces an error state that causes all running programs and commands to halt. Thus, even though providing the command with a list argument will cause the command to perform parallel processing, the first error state will cause the command to abort and none of the rest of the list arguments will be used.
- **FREE, MERGE.** These commands are for the HP 48GX and do not apply to the hp49g+/hp48gII.

- **RESTORE.** This command performs a system warmstart after installing the backup object into memory. All functions are terminated at that time. Thus, only the first backup object in a list will be restored.
- **_ (Attach Unit).** This command will create unit objects in parallel only if level 1 contains a list. Thus 1 <ft in m> _ produces <1_ft 1_in 1_m> while <1 2 3> 'm' _ produces an error.
- **STO+.** STO+ performs parallel list addition only if both arguments are lists. If one argument is a list and the other is not, STO+ appends the non-list argument to each element in the list.
- **STO-, STO*, STO/.** These commands perform parallel processing if both arguments are lists, but fail otherwise.

Using DOLIST for Parallel Processing

Almost any command or user program can be made to work in parallel over a list or lists of data y using the DOLIST command. Use DOLIST as follows.

- Level 1 must contain a command, a program object, or the name of a variable that contains a command or program object.
- Level 2 must contain an argument count unless the level 1 object is a command that accepts parallel processing, or a user-defined function. In these special cases, Level 2 contains the first of the list arguments.
- If level 2 was the argument count, then level 3 is the first of the argument lists. Otherwise, levels 2 through are the argument lists.

As an example, the following program takes three objects from the stack, tags them with the names a, b, and c, and displays them one after the other in line 1 of the display.

```



« → a b c
  « ( a b c ) DUP « EVAL » DOLIST
    SWAP « →TAG » DOLIST
      CLLCD 1 « 1 DISP 1 WAIT » DOLIST
    »
  »
»



```



































Keyboard Shortcuts



































Each key on the hp49g+/hp48gII performs so many different functions that only the most fundamental ones are actually shown on the keyboard (on the keys themselves or on the space around the keys). The following is the complete list of the "hidden" functions of the hp49g+/hp48gII keyboard.

Notation: In this appendix, there are two ways of showing key presses:

  means: press Right Shift, release it, then press .

 &  means: while holding Right Shift, press .

| Keystroke | Definition |
|---|---|
|  | If no command line, performs SWAP in RPN mode |
|  | If no command line, performs DROP in RPN mode |
|  DEL | ( ) If no command line, clears the stack |
|  CLEAR | ( ) If no command line, clears the stack |
|  | Toggles through available values when cursor is on a choose field. For example,   will change operating modes from RPN to algebraic, or algebraic to RPN. |
|  | If no command line, interactive stack (same as  key) |
|  | PICTURE |
|  | EDITB |
|   | If no command line, XSERV |
|  &  | SERVER |
|   | VISIT for variables, EDIT for everything else. |
|  &  | VISITB for variables, EDITB for everything else. |
|   | If the current menu has a special info-screen, this displays it; otherwise, the menu itself is displayed full-screen, with the VAR menu also showing the beginning of each object. |
|  &  | ( & ) Toggles real/complex mode |
|  &  | Toggles exact/approximate mode |
|  &  | ( & ) HOME |

| Keystroke | Definition |
|---|--|
|  & <u>PREV</u> ( & ) | Last Menu |
|  & <u>CHARS</u> ( & ) | Brings up the character menu |
|  & <u>EQW</u> ( & ) | Places back-tics on the command line |
|   7, 8, or 9 | Modifies the most recent letter on the command line to make the character international. |
|  &  | Holding these two keys during the entire turn-on routine prevents all added libraries from being attached AND prevents 'STARTUP' from being executed. This is useful if the calculator seems to hang up during turn-on. |
|  &  | Warmstart. Clears the stack, PICT, LASTARG, and other temporary things like those, and turns off USER Mode. Doesn't clear any variables. Useful when the calculator is taking too long to finish a complicated function and pressing  doesn't seem to interrupt it. Also useful if you lock out the keyboard with a bad USER mode set of key assignments. |
|  &  | Displays the current ROM's version and build numbers, then enters Factory Test Mode. Press  &  to exit |
|  &  | Like  &  but a friendlier and more complete set of tests, designed for the end-user. Follow the instructions on the screen. Do NOT format the SD card unless you wish to lose all of its contents! |
|  &  | Print Screen. Send the current display to the current printer |
|  &  | Adjusts the display contrast up. |
|  &  | Adjusts the display contrast down. |
|  & <u>TIME</u> ( & ) | Forces the very next system interrupt to be ignored. This is intended to allow the user to shutdown rapidly repeating alarms, but it must be noted that keystrokes also cause a system interrupt, so be sure NOT to press any key between pressing  & <u>TIME</u> and the next repeating alarm, or the alarm will come due and continue repeating. |

Press and Hold key combinations

The table below indicates the function performed by pressing and holding two keys at the same time. The shift key listed is pressed first and while that key is still being held down, the second key listed is pressed.

| Keycode | Keystroke | Definition |
|---------------------|---------------------------|--------------------------------------|
| 11.21 through 16.21 | & through | Accesses the graphing input forms |
| 22.21 | & CUSTOM (&) | MODES menu (menu 63) |
| 23.21 | & (&) | Real/Complex toggle (flag -103) |
| 31.21 | & UPDIR (&) | HOME |
| 33.21 | & PREV (&) | Last Menu |
| 35.21 | & | VISITB/EDITB (instead of VISIT/EDIT) |
| 36.31 | & | SERVER (if no command line) |
| 42.31 | & CHARS (&) | CHARS menu (menu 62) |
| 43.31 | & | ' ' |
| 72.31 | & NUM.SLV (&) | Solver menu (menu 74) |
| 74.31 | & TIME (&) | TIME menu (menu 167) |
| 104.31 | & (&) | ; or . (depends on flag -51) |
| 105.31 | & \rightarrow NUM (&) | Exact/Approx toggle (flag -105) |
| 43.61 | ALPHA & | Ω (omega) |
| 84.61 | ALPHA & | ° (degree symbol) |
| 93.61 | ALPHA & | ¡ (upside down exclamation point) |
| 94.61 | ALPHA & | ¿ (upside down question mark) |
| 104.61 | ALPHA & (&) | ; or . (depends on flag -51) |

Shifted softkeys

This section describes the effect of using the shift keys and menu labels displayed above the through keys.

= 'varname' RCL

Applies to the VAR menu, CUSTOM menus obtained by pressing CUSTOM, or via the programmable MENU or TMENU commands, and any menu containing a variable (e.g. pressing in the ROOT menu [menu number 75] yields 'EQ' RCL even in program mode.)

\leftarrow **VARIABLE** = 'varname' **STO**.

Applies to the VAR menu, CUSTOM menus obtained by pressing \leftarrow **CUSTOM**, (the left shift of the **MODE** key) or via the programmable MENU or TMENU commands, and any menu containing a variable (e.g. pressing \leftarrow **EQ** in the ROOT menu [menu number 75] yields 'EQ' **STO** even in program mode.)

The function \leftarrow **ANS** (the left shift of the **ENTER** key) is really the LASTARG key in RPL mode. It performs the LASTARG command EXCEPT when pressed immediately after pressing a **STO** or **PURGE** key, including a \leftarrow varname **STO**. If \leftarrow **ANS** is pressed immediately after a **STO**, then the PREVIOUS contents of the variable are returned (if any). If \leftarrow **ANS** is pressed immediately after a **PURGE** key is pressed, then the purged variable AND ITS CONTENTS are both returned to the stack. This does not apply if the variable is a directory object. The purpose of these exceptions is to prevent disaster: If you accidentally PURGE a variable, or wipe out a variable's contents by accidentally STOing something else into it, you can recover simply by pressing \leftarrow **ANS**.

Pressing **EDIT** by itself is the same as pressing \odot : it performs an EDITB. \leftarrow **EDIT** performs an EDIT.

In the ROOT SOLVR (\rightarrow & **NUM.SLV**, **ROOT**, **SOLVE**), pressing **VARIABLE** performs 'varname' **STO**. \rightarrow **VARIABLE** performs 'varname' \leftarrow **RCL**. \leftarrow **VARIABLE** solves for varname in the current equation. Pressing ANY key (other than **ON**) while the solver is working causes it to display the current solution interval until a solution is found. Watching the progress of the solver this way lets you avoid waiting for solutions when the process is not converging.

Menus that contain mode-toggling keys (e.g. the MISC menu (\leftarrow **PRG** **NXT** **MISC** **NXT** **MISC**)) handle the shift keys in a special way. Pressing \leftarrow **MISC** *sets* the corresponding system flag (unrelated to the previous or subsequent presence or absence of the "bullet" in the menu key), and in program mode types nn SF where nn is the flag number. \rightarrow **MISC** performs the opposite: nn CF. Modes that do not behave this way (e.g. STK and CMD) are not programmable modes.

In the first page of the PRG BRCH menu, pressing the shift keys before pressing any menu key provides a handy typing shortcut for programmers. In all these cases, the cursor is placed at the end of the first command. Thus these shifted keys can be thought of as "program structure delimiters". While entering a program,

| | | |
|---------------------|-------|-------------------|
| \leftarrow IF | types | IF THEN END |
| \rightarrow IF | types | IF THEN ELSE END |
| \leftarrow CASE | types | CASE THEN END END |
| \rightarrow CASE | types | THEN END |
| \leftarrow START | types | START NEXT |
| \rightarrow START | types | START STEP |
| \leftarrow FOR | types | FOR NEXT |
| \rightarrow FOR | types | FOR STEP |
| \leftarrow DO | types | DO UNTIL END |
| \leftarrow WHILE | types | WHILE REPEAT END |

In the EDIT menu, shift **SEEK** and shift **DEL** perform skip-to-end and delete-to-end, respectively.

\rightarrow **GOTO** is a shortcut for GOTO LABEL.

In the units menu, pressing a unit menu key multiplies by that unit, whereas \rightarrow **UNIT** divides by that unit.

\leftarrow **UNIT** converts to that unit, if possible.

G - 4 Keyboard Shortcuts

The Menu-Number Table

-- MENU NUMBERS --

"*" in the first column means the menu is not one of the keyboard menus and is therefore only available through the MENU command.

Menus are identified by keyboard path (used when flag -117 is clear) followed by choose-box path (used when flag -117 is set) followed by its displayed name.

RS-9 means "press right-shift, let go, then press 9".

RS&9 means "press right-shift, hold it down, and press 9".

"Abandoned" means that the menu was used in a former ROM version but has been obsoleted by subsequent improvements to the operating system.

SYNTAX EXAMPLE:

| |
|--|
| 16 [MTH] BASE NXT LOGIC (MTH 6 7 or BASE 7: "LOGIC") |
|--|

This means that menu 16 can be reached in eight different ways:

In algebraic mode:

- (1) MENU(16)
- (2) TMENU(16)

In RPL mode:

- (3) 16 MENU
- (4) 16 TMENU

In either algebraic or RPL mode:

With flag -117 set (soft-menu mode):

- (5) Press MTH BASE NXT LOGIC
- (6) Press BASE NXT LOGIC

With flag -117 clear (choose-box mode):

- (7) Press MTH 6 ENTER 7 ENTER
- (8) Press BASE 7 ENTER

... and name shown at the top of the choose box is "LOGIC MENU".

Note: When a choose-box path is "1", just press ENTER since the first choice is automatically highlighted in menu choose boxes.

-- menus 0-117 are semi-compatible with 48G menus --

- 0 LAST MENU
- 1 CUSTOM (no choose-box version available)
- 2 VAR (no choose-box version available)
- 3 MTH (or APPS 10: "MATH")
- 4 MTH VECTR (MTH 1: "VECTOR")
- 5 MTH MATRX (MTH 2: "MATRIX")
- 6 MTH MATRX MAKE (MTH 2 1: "MATRIX MAKE")
- 7 MTH MATRX NORM (MTH 2 2: "MATRIX NORM")
- 8 MTH MATRX FACTR (MTH 2 3: "MATRIX FACTOR.")
- 9 MTH MATRX COL (MTH 2 4: "CREATE COL")
- 10 MTH MATRX ROW (MTH 2 5: "CREATE ROW")
- 11 MTH LIST (MTH 3: "LIST")
- 12 MTH HYP (MTH 4: "HYPERBOLIC")
- 13 MTH NXT PROB (MTH 7: "PROBABILITY")
- 14 MTH REAL (MTH 5: "REAL")
- 15 [MTH] BASE (MTH 6 or BASE: "BASE")
- 16 [MTH] BASE NXT LOGIC (MTH 6 7 or BASE 7: "LOGIC")
- 17 [MTH] BASE NXT BIT (MTH 6 8 or BASE 8: "BIT")
- 18 [MTH] BASE NXT BYTE (MTH 6 9 or BASE 9: "BYTE")
- 19 MTH NXT FFT (MTH 8: "FFT")
- 20 MTH NXT CMLX (MTH 9: "COMPLEX")
- 21 MTH NXT CONST (MTH 10: "CONSTANTS")
- 22 PRG (PRG: "PROG")
- 23 PRG BRCH (PRG 3: "BRANCH")
- 24 PRG BRCH IF (PRG 3 1: "IF")
- 25 PRG BRCH CASE (PRG 3 2: "CASE")
- 26 PRG BRCH START (PRG 3 3: "START")
- 27 PRG BRCH FOR (PRG 3 4: "FOR")
- 28 TOOL EDIT (no choose-box version available)
- 29 PRG BRCH DO (PRG 3 5: "DO")
- * 30 old soft-menu solver (no choose-box version available)
- 31 PRG BRCH WHILE (PRG 3 6: "WHILE")
- 32 PRG TEST (PRG 4: "TEST")
- 33 PRG TYPE (PRG 5: "TYPE")
- 34 PRG LIST (PRG 6: "LIST")
- 35 PRG LIST ELEM (PRG 6 1: "ELEMENT")
- 36 PRG LIST PROC (PRG 6 2: "PROC")
- 37 PRG NXT GROB (PRG 7: "GROB")
- 38 PRG NXT PICT (PRG 8: "PICTURE")
- 39 PRG NXT IN (PRG 11: "INPUT")
- 40 PRG NXT OUT (PRG 12: "OUTPUT")
- 41 PRG NXT NXT RUN (no choose-box version available)
- 42 [CONVERT] UNITS (CONVERT 1 or UNITS: "UNITS")
- 43 [CONVERT] UNITS LENG (CONVERT 1 2 or UNITS 2: "LENGTH")
- 44 [CONVERT] UNITS AREA (CONVERT 1 3 or UNITS 3: "AREA")
- 45 [CONVERT] UNITS VOL (CONVERT 1 4 or UNITS 4: "VOLUME")
- 46 [CONVERT] UNITS TIME (CONVERT 1 5 or UNITS 5: "TIME")
- 47 [CONVERT] UNITS SPEED (CONVERT 1 6 or UNITS 6: "SPEED")
- 48 [CONVERT] UNITS NXT MASS (CONVERT 1 7 or UNITS 7: "MASS")
- 49 [CONVERT] UNITS NXT FORCE (CONVERT 1 8 or UNITS 8: "FORCE")
- 50 [CONVERT] UNITS NXT ENRG (CONVERT 1 9 or UNITS 9: "ENERGY")

51 [CONVERT] UNITS NXT POWR (CONVERT 1 10 or UNITS 10: "POWER")
52 [CONVERT] UNITS NXT PRESS (CONVERT 1 11 or UNITS 11: "PRESSURE")
53 [CONVERT] UNITS NXT TEMP (CONVERT 1 12 or UNITS 12: "TEMPERATURE")
54 [CONVERT] UNITS NXT NXT ELEC (CONVERT 1 13 or UNITS 13: "ELECTRIC CURRENT")
55 [CONVERT] UNITS NXT NXT ANGL (CONVERT 1 14 or UNITS 14: "ANGLE")
56 [CONVERT] UNITS NXT NXT LIGHT (CONVERT 1 15 or UNITS 15: "LIGHT")
57 [CONVERT] UNITS NXT NXT RAD (CONVERT 1 16 or UNITS 16: "RADIATION")
58 [CONVERT] UNITS NXT NXT VISC (CONVERT 1 17 or UNITS 17: "VISCOSITY")
59 [CONVERT] UNITS TOOLS (CONVERT 1 1 or UNITS 1: "TOOLS")
60 PRG NXT NXT ERROR IFERR (PRG 14 6: "IF ERROR")
61 PRG NXT NXT ERROR (PRG 14: "ERROR")
62 PRG NXT CHARS (PRG 9: "CHAR")
63 PRG NXT MODES (LS&MODE or PRG 10: "MODES")
64 PRG NXT MODES FMT (LS&MODE 1: "FORMAT")
65 PRG NXT MODES ANGLE (LS&MODE 2: "ANGLE")
66 PRG NXT MODES FLAG (LS&MODE 3: "FLAG")
67 PRG NXT MODES KEYS (LS&MODE 4: "KEYS")
68 PRG NXT MODES MENU (LS&MODE 5: "MENU")
69 PRG NXT MODES MISC (LS&MODE 6: "MISC")
70 PRG MEM (PRG 2: "MEMORY")
71 PRG MEM DIR (PRG 2 5: "DIRECTORY")
72 PRG MEM ARITH (PRG 2 6: "ARITH")
73 PRG/TOOL STACK (PRG 1 1: "STACK")
74 RS&NUM.SLV (similar to RS-NUM.SLV; no name)
75 RS&NUM.SLV ROOT (74 MENU ROOT: "ROOT")
76 RS&NUM.SLV DIFFEQ (74 MENU DIFFEQ: "DIF EQ")
77 RS&NUM.SLV POLY (74 MENU POLY: "POLY")
78 RS&NUM.SLV SYS (74 MENU SYS: "SYS")
79 RS&NUM.SLV TVM (74 MENU TVM: "TVM")
80 RS&NUM.SLV TVM SOLVR (FINANCE is the input-form version)
* 81 old soft-menu PLOT (no choose-box version available)
* 82 old soft-menu PLOT PTYPE (no choose-box version available)
* 83 old soft-menu PLOT PPAR (no choose-box version available)
* 84 old soft-menu PLOT 3D (81.02 MENU 3D: "3-D")
* 85 old soft-menu PLOT 3D PTYPE (no choose-box version available)
* 86 old soft-menu PLOT 3D VPAR (no choose-box version available)
* 87 old soft-menu PLOT STAT (81.02 MENU STAT: "PLOT STAT")
* 88 old soft-menu PLOT STAT PTYPE (no choose-box version available)
* 89 old soft-menu PLOT STAT EPAR (no choose-box version available)
* 90 old soft-menu PLOT STAT EPAR MODL (no choose-box version available)
* 91 old soft-menu PLOT STAT DATA (87 MENU DATA: "PLOT EDAT")
* 92 old soft-menu PLOT FLAG (no choose-box version available)
* 93 old SYMBOLIC menu (93 DUP MENU MENU LS&PREV: "SYMBOLIC")
94 PRG NXT NXT TIME (RS&TIME or PRG 13: "TIME")
95 PRG NXT NXT TIME ALRM (RS&TIME 6 or TIME 4 6 or PRG 13 6 or APPS 5 4 6: "ALARM")
* 96 old soft-menu STAT (97 MENU STAT: "STATISTIC")
* 97 old soft-menu STAT DATA (96 MENU DATA: "STAT DATA")
* 98 old soft-menu STAT EPAR (no choose-box version available)
* 99 old soft-menu STAT EPAR MODL (no choose-box version available)
*100 old soft-menu STAT 1VAR (96 MENU 1VAR: "STAT 1VAR")
*101 old soft-menu STAT PLOT (96 MENU PLOT: "STAT PLOT")
*102 old soft-menu STAT FIT (96 MENU FIT: "STAT FIT")

```

*103 old soft-menu STAT SUMS (96 MENU SUMS: "STAT SUM")
*104 old soft-menu I/O (105 MENU I/O: "INPUT/OUTPUT")
*105 old soft-menu I/O SRVR (104 MENU SRVR: "SERVER")
*106 old soft-menu I/O IOPAR (no choose-box version available)
*107 old soft-menu I/O PRINT (104 MENU PRINT: "PRINT")
*108 old soft-menu I/O PRINT PRTPAR (no choose-box version available)
*109 old soft-menu I/O SERIAL (104.02 MENU SERIAL: "SERIAL IO")
*110 LIBRARY commands (110 DUP MENU MENU LS&PREV: "LIBRARY")
    111 same result as LIB (no choose-box version available)
    112 same result as LIB (no choose-box version available)
    113 APPS 12 ("EQN LIBRARY")
    114 APPS 12 EQLIB (APPS 12 1: "EQN LIB")
    115 APPS 12 COLIB (APPS 12 2: "CON LIB")
    116 APPS 12 MES (APPS 12 3: "MES LIB")
    117 APPS 12 UTILS (APPS 12 4: "UTIL LIB")

-- 49G-only menus start here ---
*118 abandoned UNITS TOOLS (see menu #59; "TOOLS")
    119 APPS CAS (APPS 11: "CAS")
    120 S.SLV (S.SLV: "S.SLV")
    121 EXP&LN (EXP&LN: "EXP&LN")
    122 TRIG (TRIG: "TRIG")
    123 CALC (CALC: "CALC")
    124 ALG (ALG: "ALG")
    125 ARITH (ARITH: "ARITH")
    126 ARITH POLY (ARITH 2: "POLYNOMIAL")
    127 ARITH INTEG (ARITH 1: "INTEGER")
    128 ARITH MODUL (ARITH 3: "MODULAR")
    129 MATRICES (MATRICES: "MATRICES")
    130 CMLPX (CMLPX: "COMPLEX")
    131 CONVERT (CONVERT: "CONVERT")
    132 RS&NUM.SLV (NUM.SLV: "NUM.SLV")
*133 soft-menu TVM (133 DUP MENU MENU LS&PREV: "FINANCE")
    134 SYMB ARITH (SYMB 2: "SYMBOLIC ARITH")
*135 abandoned SYMB CONV ("SYMBOLIC CONV")
*136 abandoned SYMB DIFF or SYMB CALC ("SYMBOLIC CALC")
*137 abandoned SYMB MATRX ("SYMBOLIC MAT")
*138 abandoned SYMB MOD ("SYMBOLIC MOD")
    139 SYMB TRIG (SYMB 6: "SYMBOLIC TRIG")
    140 CONVERT TRIG (CONVERT 3: "TRIG CONVERT")
*141 abandoned SYMB UNARY ("SYMBOLIC UNARY")
*142 abandoned SYMB BASE (meaning basic, not binary; "SYMBOLIC BASE")
    143 SYMB (SYMB: "SYMBOLIC")
*144 abandoned PRG (the MODES menu is missing; "PROG")
*145 abandoned PRG BRCH (like PRG BRCH but flat; "BRANCH")
    146 MATRICES CREAT (MATRICES 1: "MATRIX CREATE")
*147 abandoned MATRICES NORM menu (a subset of MATRICES OPER; "MATRIX NORM")
    148 MATRICES FACT (MATRICES 3: "MATRIX FACTOR.")
*149 abandoned MATRICES COL ("CREATE COL")
*150 abandoned MATRICES ROW ("CREATE ROW")
    151 SYMB ALG (SYMB 1: "SYMBOLIC ALGEBRA")
    152 SYMB CALC (SYMB 3: "SYMBOLIC CALC")

```

H - 4 The Menu-Number Table

153 SYMB GRAPH (SYMB 4: "SYMBOLIC GRAPH")
 154 SYMB SOLVE (SYMB 5: "SYMBOLIC SOLVER")
 155 SYMB NXT EXPLN (SYMB 7: "SYMBOLIC EXP & LN")
 156 MATRICES OPER (MATRICES 2: "MATRIX OPERATIONS")
 157 MATRICES QUADF (MATRICES 4: "MATRIX QUAD. FORM")
 158 MATRICES LIN-S (MATRICES 5: "MATRIX LINEAR SYS.")
 159 MATRICES NXT EIGEN (MATRICES 7: "MATRIX EIGENVECT.")
 160 MATRICES NXT VECT (MATRICES 8: "MATRIX VECTOR")
 161 TRIG HYP (TRIG 1: "TRIG HYPERBOLIC")
 162 CALC DERIV (CALC 1: "DERIV. & INTEG.")
 163 CALC LIMIT (CALC 2: "LIMITS & SERIES")
 164 CALC DIFF (CALC 3: "DIFFERENTIAL EQNS")
 165 MATRICES CREAT COL (MATRICES 1 1: "CREATE COL")
 166 MATRICES CREAT ROW (MATRICES 1 2: "CREATE ROW")
 167 APPS TIME TOOLS (APPS 5 4: "TIME")
 168 CONVERT BASE (CONVERT 2: "BASE")
 169 CONVERT BASE NXT LOGIC (CONVERT 2 3: "LOGIC")
 170 CONVERT BASE NXT BIT (CONVERT 2 4: "BIT")
 171 CONVERT BASE NXT BYTE (CONVERT 2 5: "BYTE")
 172 CONVERT REWRITE (CONVERT 4: "REWRITE")
 173 CONVERT MATRIX (CONVERT 5: "MATRIX CONVERT")
 174 ARITH PERM (ARITH 4: "PERMUTATION")
 175 MATRICES LINAP (MATRICES 6: "LINEAR APPL")
 176 MTH SPECIAL (MTH 11: "SPECIAL FUNCTIONS")
 177 CALC GRAPH (CALC 4: "SYMBOLIC GRAPH")

178-255 (nonexistent)

-- MENU NUMBERS THAT CORRESPOND TO BUILT-IN LIBRARIES --

256 Development Library (256 MENU, or APPS UP OK if lib 256 is attached)
 Note: Warmstart with B C and D held down forces "smart" mode, in which lib 256 is
 attached and RPN mode is the default.
 257 MASD V5.2 Assembler (use 256 instead)
 258 extable
 788 CAS version 4.20030721 (new, improved Erable library)
 1792 Program structure commands (same as in 48S/G)
 2050 Library 2: 48S command set + new ones; see below
 2057 Library 9: Statistical test functions (do not use)
 2219 Library 171: 48G command set + new ones; see below
 2269 Library 221: MetaKernel commands (not in any menus)
 2270 Library 222: new commands (see below) & CAS messages
 2275 Library 227: Equation Library + MINEHUNT (new in Version 2.00)
 2289 Library 241: Statistics commands

-- New Library 222 --

{ expr = real, complex, or sym }
{ sym = name or algebraic }
{ var = name of a variable, e.g. 'X' } 0
{ name = global name or local name }
{ | = or }

0 ADDTOREAL(var)
1 SIGMAVX(sym)
2 SIGMA(sym,var)
3 Psi(expr)
4 PSI(expr,integer | sym,sym)
5 RESULTANT(symb,symb)
6 IBERNOULLI(integer | real)
7 GAMMA(expr)
8 qr(matrix | list)
9 GRAMSCHMIDT(array,program)
10 SYST2MAT(array,array | list,list)
11 CHOLESKY(matrix | list)
12 DIAGMAP(matrix,program|sym)
13 ISOM(matrix)
14 MKISOM(any,integer)
15 KER(matrix)
16 IMAGE(matrix | list)
17 BASIS(list | array)
18 IBASIS(list,list)
19 AUGMENT(list|array|string,any)
20 PMINI(matrix)
21 CYCLOTOMIC(integer | real)
22 STURM(polynomial)
23 STURMAB(polynomial,sym,sym)
24 FDISTRIB(sym)
25 DISTRIB(sym)
26 EXP2POW(sym)
27 POWEXPAND(sym)
28 TAN2CS2(sym | array)
29 CIRC(program,list)
30 C2P(list)
31 P2C(list)
32 MSLV(array,array,array)
33 DOMAIN(function)
34 SIMPLIFY(expr | array)
35 DROITE(sym,sym | complex,complex)
36 STORE(any,var|any,symb)
37 DEF(expr)
38 ASSUME(var | symb)
39 UNASSUME(var)
40 REWRITE
41 INTEGER
42 CONSTANTS
43 HYPERBOLIC

```

44 MODULAR
45 POLYNOMIAL
46 TESTS
47 MATHS
48 COLLECT(symb)
49 UNASSIGN(var | symb)
50 HELP
51 CASCMD [string]
52 PUSH
53 POP
54 DEGREE(polynomial | real | complex)
55 DEDICACE
56 POTENTIAL(array,array)
57 VPOTENTIAL(array,array)
58 GBASIS(array)
59 GREduce(sym,array,array)
60 LOCAL(lam | sym | list)
61 UNBIND(?)
62 EXP2HYP(sym)
63 RCLVX
64 STOVX(var)

```

-- New LIB 2 commands (only 2.5 bytes each) --

```

342 (algebraic STO) (called xSTO> in SRPL)
386 INT(any,globalname,any)
387 ANS(real) (same as PICK)
388 ;(any) (Performs a DROP. Stack empty --> no error if ROM is 1.10+)
389 R-I(integer | real | symbolic) (converts real to integer)
390 I-R(integer | real | symb) (converts integer to real)
391 NOVAL(none) (not in lib 171 any more)
392 CMDAPPLY (?) (hidden)
393 RPL> ( :: CK0 ; )
394 UNROT(any3) (same as ROT ROT or 3 ROLLD)
    Example: 333 22 1 UNROT --> 1 333 22
395 UNPICK(real) (replaces one object anywhere on the stack)
    Example: Replace the 4th object with an "X":
    55555 4444 333 22 1 "X" 4 UNPICK --> 55555 "X" 333 22 1
    Can be thought of as a "stack poke".
396 NIP(any2) (same as SWAP DROP)
    Example: 333 22 1 NIP --> 333 1
397 PICK3(any3) (same as 3 PICK)
    Example: 333 22 1 PICK3 --> 333 22 1 333
398 DUPDUP(any) (same as DUP DUP)
399 NDUPN(any,real) (does DUP n-1 times and leaves n on the stack)
    Example: To make a list of 100 "X"s: "X" 100 NDUPN -LIST
400 FAST3D(none)

```

-- New LIB 171 commands --

107 DRAW3DMATRIX(array,real,real)
108 →KEYTIME(real) (sets keyboard debounce delay from 0 to 4096 ticks)
109 KEYTIME→(none) (returns current KEYTIME; default = 1365)
110 XSERV(none) (starts XMODEM server mode)
111 ROMUPLOAD(none) (transfers ROM from this HP49G to another)
112 XGET(globalname) (gets a variable from other 49G in XSERV mode)
113 XPUT(globalname) (sends a variable to other 49G in XSERV mode)
114 MSOLVR(none -- but Mpar must exist already)
115 MINIT(none)
116 MITM(list,"title")
117 MUSER(globalname | list | "ALL")
118 MCALC(globalname | list | "ALL")
119 MROOT(globalname | "ALL")

The Command Menu-Path Table

The hp49g+/hp48gII programmable commands in CAT order. An "H" in the first column means this command has a HELP screen. A "-" in the first column means "not shown in the 49g+ CAtalog". Following each command is its menu path or key sequence (if any) with alternatives separated by a semicolon. "/" means "either". The most efficient key sequence is shown first if several exist, assuming that NXT NXT is better than PREV, etc. "[" = optional. This list assumes that library 256 is attached, flag -95 is off, and flag -117 is set.

SYNTAX EXAMPLES:

! (key ALPHA-RS-2; MTH NXT PROB)

This means that you can either press [ALPHA] [RIGHT-SHIFT] [2] or press [MTH] [NXT] [PROB] [!] to get the ! function.

+ (key 95.1)

This means that [+] is on the keyboard in row 9, column 5. The

.1 means unshifted;

.2 means left-shifted;

.3 means right-shifted;

.4 means alpha-shifted;

.5 means alpha-left-shifted; and

.6 means alpha-right-shifted.

.01 added means hold down the shift key while pressing the key, e.g. key 22.21 is MODE with the left-shift key held down...also called LS&MODE.

AMORT (79 MENU)

This means that AMORT is not in any keyboard menu, but you can find it in numbered menu 79 (type 79 MENU to go to that menu).

QUOT («POLYNOMIAL» NXT; ARITH POLY PREV)

This means that QUOT is in the POLYNOMIAL menu, a special menu which is not a numbered menu, nor on the keyboard, but is seen by executing the «programmable» command POLYNOMIAL. QUOT can also be found in the ARITH POLY PREV menu.

CATALOG: 812 COMMANDS (802 are shown by CAT)

! (key ALPHA-RS-2; MTH NXT PROB)
% (key ALPHA-LS-1; MTH REAL)
%CH (MTH REAL)
%T (MTH REAL)
' (key 43.1)
* (key 75.1)
- *H (alias for SCALEH)
- *W (alias for SCALEW)
+ (key 95.1)
- (key 85.1)
/ (key 65.1; RS&NUM.SLV SYS)
; (key RS&SPC; key ALPHA-LS-2)
< (key 63.3; PRG TEST; «TESTS»)
= (key 62.3)
== (PRG TEST; «TESTS» NXT)
> (key 64.3; PRG TEST; «TESTS»)
H ? (key ALPHA-RS-3)
H ABCUV (ARITH POLY)
ABS (key 65.2; CMPLX; MATRICES OPER; MTH VECTR; MTH REAL NXT; MTH MATRX NORM;
MTH NXT CMPLX; «CMPLX»)
ACK (RS&TIME ALRM; PRG NXT NXT TIME ALRM)
ACKALL (RS&TIME ALRM; PRG NXT NXT TIME ALRM)
ACOS (key 54.2)
H ACOS2S (TRIG; CONVERT TRIG; «TRIGO»)
ACOSH (MTH HYP; TRIG HYP; «HYPERBOLIC»)
ADD (MTH LIST)
H ADDTMOD (ARITH MODUL; «MODULAR»)
H ADDTOREAL (CAT)
H ALGB («MAIN»)
ALOG (key 61.2: 10^x)
AMORT (RS&NUM.SLV TVM)
AND (PRG TEST NXT; [MTH/CONVERT] BASE NXT LOGIC; «TESTS» NXT)
ANIMATE (PRG NXT GROB NXT)
ANS (key 105.2 in ALG mode; CAT in RPL mode)
APEEK (256.04 MENU)
APPLY (93.02 MENU)
ARC (PRG NXT PICT)
ARCHIVE (PRG MEM NXT)
ARG (key 65.3; CMPLX; MTH NXT CMPLX; «CMPLX»)
H ARIT («MAIN» NXT)
ARM→ (256.06 MENU)
ARRY→ (CAT)
ASIN (key 53.2)
H ASIN2C (TRIG; CONVERT TRIG; «TRIGO»)
H ASIN2T (TRIG; CONVERT TRIG; «TRIGO»)
ASINH (MTH HYP; TRIG HYP; «HYPERBOLIC»)

ASM (257 MENU; 256.06 MENU)
 ASM→ (256.05 MENU)
 ASN (LS&MODE KEYS; PRG NXT MODES KEYS)
 ASR ([MTH/CONVERT] BASE NXT BIT)
 H ASSUME («TESTS»)
 ATAN (key 55.2)
 H ATAN2S (TRIG; CONVERT TRIG; «TRIGO»)
 ATANH (MTH HYP; TRIG HYP; «HYPERBOLIC»)
 ATICK (83.02 MENU)
 ATTACH (110 MENU)
 H AUGMENT (MATRICES CREAT)
 AUTO (81.02 MENU)
 AXES (83.02 MENU)
 H AXL (CONVERT MATRX; MATRICES OPER; «MATR»)
 H AXM (MATRICES OPER; «MATR»)
 H AXQ (CONVERT MATRIX; MATRICES QUADF; «MATR» NXT)
 A→ (256 MENU)
 A-H (256 MENU)
 BAR (88 MENU)
 BARPLOT (101 MENU)
 H BASIS (MATRICES NXT VECT)
 BAUD (106 MENU)
 BEEP (PRG NXT OUT NXT)
 BESTFIT (90/99 MENU)
 BIN ([MTH/CONVERT] BASE)
 BINS (100 MENU)
 BLANK (PRG NXT GROB)
 BOX (PRG NXT PICT)
 BUFLen (109 MENU)
 BYTES (PRG MEM)
 BetaTesting (256.05 MENU)
 B-R ([MTH/CONVERT] BASE)
 H C2P (ARITH PERM)
 H CASCFG («MAIN»)
 CASCMD (TOOL NXT)
 CASE (PRG BRCH CASE)
 CD→ (256.02 MENU)
 CEIL (MTH REAL NXT NXT)
 CENTR (83.02 MENU)
 CF (LS&MODE FLAG; PRG TEST NXT NXT; PRG NXT MODES FLAG)
 H CHINREM (ARITH POLY)
 H CHOLESKY (MATRICES QUADF)
 CHOOSE (PRG NXT IN)
 CHR (RS&CHARS; PRG TYPE NXT; PRG NXT CHARS)
 H CIRC (ARITH PERM)
 CKSM (106 MENU)
 CLEAR (key 45.3)
 CLKADJ (RS&TIME NXT NXT; PRG NXT NXT TIME NXT NXT; APPS 5 4 NXT NXT)
 CLLCD (PRG NXT OUT)
 CLOSEIO (104.02 MENU)
 CLUSR (alias for CLVAR)
 CLVAR (CAT)

CLE (91/97 MENU)
 H CMLPX («MATHS»; «MAIN» NXT)
 CNRM (MATRICES OPER; MTH MATRX NORM)
 COL+ (MTH MATRX COL; MATRICES CREAT COL)
 COL- (MTH MATRX COL; MATRICES CREAT COL)
 COLCT (93 MENU)
 H COLLECT (ALG; «ALGB»)
 COLE (CAT)
 COL→ (MTH MATRX COL; MATRICES CREAT COL)
 COMB (MTH NXT PROB)
 COMP→ (256.03 MENU)
 CON (MATRICES CREAT; MTH MATRX MAKE)
 COND (MATRICES OPER; MTH MATRX NORM)
 CONIC (82 MENU)
 CONJ (CMLPX; MTH NXT CMLPX NXT; «CMLPX»)
 CONLIB (APPS 3; APPS 12 COLIB; 115 MENU)
 CONST (APPS 12 COLIB; 115 MENU)
 H CONSTANTS («MATHS»)
 CONT (key 101.02)
 CONVERT ([CONVERT] UNITS TOOLS)
 CORR (102 MENU)
 COS (key 54.1)
 COSH (MTH HYP; TRIG HYP; «HYPERBOLIC»)
 COV (102 MENU)
 CR (107 MENU)
 CRC (256.05 MENU)
 CRDIR (PRG MEM DIR)
 CRLIB (256.05 MENU)
 CROSS (MTH VECTR; MATRICES NXT VECT)
 CSWP (MTH MATRX COL; MATRICES CREAT COL)
 H CURL (CALC DERIV)
 H CYCLOTOMIC (ARITH POLY)
 CYLIN (LS&MODE ANGLE; MTH VECTR NXT; PRG NXT MODES ANGLE)
 C→PX (PRG NXT PICT NXT)
 C→R (PRG TYPE NXT; MTH NXT CMLPX)
 DARCY (APPS 12 UTILS; 117 MENU)
 DATE (RS&TIME; PRG NXT NXT TIME; APPS 5 4)
 DATE+ (RS&TIME NXT; PRG NXT NXT TIME NXT; APPS 5 4 NXT)
 DEBUG (CAT)
 DDAYS (RS&TIME NXT; PRG NXT NXT TIME NXT; APPS 5 4 NXT)
 DEC ([MTH/CONVERT] BASE)
 DECR (PRG MEM ARITH)
 DEDICACE (CAT)
 H DEF («ALGB»)
 DEFINE (key 93.2; SYMB GRAPH; CALC GRAPH)
 DEG (LS&MODE ANGLE; PRG NXT MODES ANGLE)
 H DEGREE (CAT)
 DELALRM (RS&TIME ALRM; PRG NXT NXT TIME ALRM)
 DELAY (108 MENU)
 DELKEYS (LS&MODE KEYS; PRG NXT MODES KEYS)

I - 4 The Command Menu-Path Table

DEPND (83 MENU)
 DEPTH (PRG/TOOL STACK NXT)
 H DERIV (SYMB CALC; CALC DERIV; «DIFF»)
 H DERVX (CALC; SYMB CALC; CALC DERIV; «DIFF»)
 H DESOLVE (S.SLV; CALC DIFF; «SOLVER»)
 DET (MATRICES OPER; MTH MATRX NORM NXT)
 DETACH (110 MENU)
 H DIAGMAP (MATRICES NXT EIGEN)
 DIAG→ (MATRICES CREAT NXT; MTH MATRX NXT; MTH MATRX MAKE NXT NXT)
 H DIFF («MAIN»)
 DIFFEQ (82 MENU)
 DIR (CAT)
 DISP (PRG NXT OUT)
 DISPHY (CAT)
 H DISTRIB (CONVERT REWRITE; «REWRITE»)
 H DIV (CALC DERIV)
 H DIV2 (ARITH POLY)
 H DIV2MOD (ARITH MODUL)
 H DIVIS (ARITH; SYMB ARITH; «INTEGER»)
 H DIVMOD (ARITH MODUL; «MODULAR»)
 H DIVPC (CALC LIMIT; «DIFF»)
 DO (PRG BRCH [DO])
 DOERR (PRG NXT NXT ERROR)
 DOLIST (PRG LIST PROC)
 H DOMAIN (CAT)
 DOSUBS (PRG LIST PROC)
 DOT (MTH VECTR; MATRICES NXT VECT)
 DRAW (81 MENU)
 H DRAW3DMATRIX (CAT)
 DRAX (81 MENU)
 H DROITE («CMLX»)
 DROP (PRG/TOOL STACK; backspace key when not editing)
 DROP2 (PRG/TOOL STACK NXT NXT)
 DROPN (PRG/TOOL STACK NXT NXT)
 DTAG (PRG TYPE NXT)
 DUP (PRG/TOOL STACK; ENTER key when not editing)
 DUP2 (PRG/TOOL STACK NXT NXT)
 DUPDUP (PRG/TOOL STACK NXT NXT)
 DUPN (PRG/TOOL STACK NXT NXT)
 D-R (MTH REAL NXT NXT)
 EDIT (key LS-⓪; TOOL LS-EDIT)
 EDITB (key ⓪; TOOL)
 H EGCD (ARITH POLY; «POLYNOMIAL»)
 EGV (MATRICES NXT EIGEN; MTH MATRX NXT)
 EGVL (MATRICES NXT EIGEN; MTH MATRX NXT)
 ELSE (PRG BRCH IF; PRG NXT NXT ERROR IFERR)
 END (PRG BRCH IF/CASE/DO/WHILE; PRG NXT NXT ERROR IFERR)
 ENDSUB (PRG LIST PROC)
 ENG (LS&MODE FMT; PRG NXT MODES FMT)
 H EPSX0 («REWRITE»)
 EQNLIB (APPS 12 EQLIB; 114 MENU)
 EQW (CAT) - not the same as the EQW key (key 43.3)

EQ→ (PRG TYPE NXT)
 ER (257 MENU; 256.06 MENU)
 ERASE (81 MENU)
 ERRO (PRG NXT NXT ERROR)
 ERRM (PRG NXT NXT ERROR)
 ERRN (PRG NXT NXT ERROR)
 H EULER (ARITH INTEG; «INTEGER»)
 EVAL (key 41.1; in EQW; in FILER; 142 MENU)
 H EXLR (108 DUP MENUXY)
 EXP (key 51.2: e^x ; 141 MENU)
 H EXP&LN («MAIN» NXT)
 H EXP2HYP (CAT)
 H EXP2POW (CONVERT REWRITE; «REWRITE»)
 EXPAN (93/142 MENU)
 H EXPAND (ALG; SYMB ALG; «ALGB»)
 H EXPANDMOD (ARITH MODUL; «MODULAR»)
 EXPFIT (90/99 MENU)
 H EXPLN (EXP&LN; CONVERT REWRITE; SYMB NXT EXPLN; «EXP&LN»; «REWRITE»)
 EXPM (EXP&LN; MTH HYP NXT)
 EYEPT (86.02 MENU)
 F0λ (APPS 12 UTILS; 117 MENU)
 FACT (CAT)
 H FACTOR (ALG; SYMB ALG; ARITH POLY; «ALGB»; «INTEGER»; «POLYNOMIAL»; in EQW)
 H FACTORMOD (ARITH MODUL; «MODULAR»)
 H FACTORS (ARITH)
 FANNING (APPS 12 UTILS; 117 MENU)
 FAST3D (CAT)
 FC? (LS&MODE FLAG; PRG TEST NXT NXT; PRG NXT MODES FLAG)
 FC?C (LS&MODE FLAG; PRG TEST NXT NXT; PRG NXT MODES FLAG)
 H FCOEF (ARITH POLY NXT; «SOLVER»)
 H FDISTRIB (CONVERT REWRITE; «REWRITE»)
 FFT (MTH NXT FFT)
 FILER (key 21.2; CAT)
 FINDALARM (RS&TIME ALRM; PRG NXT NXT TIME ALRM)
 FINISH (105 MENU)
 FIX (LS&MODE FMT; PRG NXT MODES FMT)
 FLASHEVAL (CAT)
 FLOOR (MTH REAL NXT NXT; «CMPLX»)
 FONT6 (CAT)
 FONT7 (CAT)
 FONT8 (CAT)
 FONT→ (CAT)
 FOR (PRG BRCH [FOR])
 H FOURIER (CALC DERIV; «DIFF»)
 FP (MTH REAL NXT)
 FREE (CAT) - do not use
 FREEZE (PRG NXT OUT)
 H FROOTS (ARITH POLY NXT; «SOLVER»)
 FS? (LS&MODE FLAG; PRG TEST NXT NXT; PRG NXT MODES FLAG)
 FS?C (LS&MODE FLAG; PRG TEST NXT NXT; PRG NXT MODES FLAG)

I - 6 The Command Menu-Path Table

FUNCTION (82 MENU)
 H FXND (107 DUP MENUXY)
 H GAMMA (MTH NXT SPECIAL)
 H GAUSS (MATRICES QUADF; «MATR» NXT)
 H GBASIS (CAT)
 H GCD (ARITH POLY NXT; «INTEGER»; «POLYNOMIAL»)
 H GCDMOD (ARITH MODUL; «MODULAR»)
 GET (PRG LIST ELEM; MATRICES CREAT NXT; MTH MATRX MAKE NXT)
 GETI (PRG LIST ELEM; MATRICES CREAT NXT; MTH MATRX MAKE NXT)
 GOR (PRG NXT GROB)
 GRAD (LS&MODE ANGLE; PRG NXT MODES ANGLE)
 H GRAMSCHMIDT (MATRICES NXT VECT)
 - GRAPH (alias for PICTURE)
 H GREDUCE (CAT)
 - GREY (must be typed in)
 GRIDMAP (85 MENU)
 GROB (CAT)
 H GROBADD (SYMB GRAPH; CALC GRAPH)
 GXOR (PRG NXT GROB)
 H HADAMARD (MATRICES OPER NXT; «MATR»)
 H HALFTAN (TRIG; SYMB TRIG; CONVERT TRIG; «TRIGO»)
 HALT (PRG NXT NXT RUN)
 HEAD (RS&CHARS NXT; PRG LIST ELEM NXT; PRG NXT CHARS NXT)
 HEADER→ (CAT)
 HELP (TOOL NXT)
 H HERMITE (ARITH POLY NXT; «POLYNOMIAL»)
 H HESS (CALC DERIV)
 HEX ([MTH/CONVERT] BASE)
 H HILBERT (MATRICES CREAT NXT; MTH MATRX MAKE NXT NXT)
 HISTOGRAM (88 MENU)
 HISTPLOT (101 MENU)
 HMS+ (RS&TIME NXT; PRG NXT NXT TIME NXT; APPS 5 4 NXT)
 HMS- (RS&TIME NXT; PRG NXT NXT TIME NXT; APPS 5 4 NXT)
 HMS→ (RS&TIME NXT; PRG NXT NXT TIME NXT; APPS 5 4 NXT)
 HOME (key LS&UPDIR)
 H HORNER (ARITH POLY NXT)
 H HYPERBOLIC («MATHS»)
 H→ (256 MENU)
 H-A (256 MENU)
 H-S (256.02 MENU)
 H IABCUV (ARITH INTEG)
 H IBASIS (MATRICES NXT VECT)
 H IBERNOULLI (ARITH INTEG)
 H IBP (SYMB CALC; CALC DERIV NXT; «DIFF»)
 H ICHINREM (ARITH INTEG)
 H IDIV2 (ARITH INTEG)
 IDN (MATRICES CREAT; MTH MATRX MAKE)
 H IEGCD (SYMB ARITH; ARITH INTEG; «INTEGER»)
 IF (PRG BRCH [IF])
 IFERR (PRG NXT NXT ERROR [IFERR])
 IFFT (MTH NXT FFT)
 IFT (PRG BRCH NXT)

IFTE (PRG BRCH NXT; «TESTS» NXT)
 H ILAP (CALC DIFF; «DIFF» NXT NXT)
 IM (CMLPX; MTH NXT CMLPX; «CMLPX» NXT)
 H IMAGE (MATRICES LINAP)
 INCR (PRG MEM ARITH)
 INDEP (83 MENU)
 INFORM (PRG NXT IN)
 INPUT (PRG NXT IN)
 INT (CAT)
 H INTEGER («ARIT»; «MATHS»)
 H INTVX (CALC; SYMB CALC; CALC DERIV NXT; «DIFF»)
 INV (key 64.1: 1/x)
 H INVMOD (ARITH MODUL NXT; «MODULAR»)
 IP (MTH REAL NXT)
 H IQUOT (SYMB ARITH; ARITH INTEG NXT; «INTEGER»)
 H IREMAINDER (SYMB ARITH; ARITH INTEG NXT; «INTEGER» NXT)
 ISOL (S.SLV; «SOLVER»)
 H ISOM (MATRICES LINAP)
 H ISPRIME? (SYMB ARITH; ARITH INTEG NXT; «INTEGER» NXT)
 I→R (CONVERT REWRITE)
 H JORDAN (MATRICES NXT EIGEN; «MATR» NXT)
 H KER (MATRICES LINAP)
 KERRM (104.02 MENU)
 KEY (PRG NXT IN)
 H KEYEVAL (123 DUP MENUXY)
 KEYTIME→ (CAT)
 KGET (105 MENU)
 KILL (PRG NXT NXT RUN)
 LABEL (81.02 MENU)
 H LAGRANGE (ARITH POLY NXT)
 LANGUAGE→ (CAT)
 H LAP (CALC DIFF; «DIFF» NXT NXT)
 H LAPL (CALC DERIV NXT)
 - LAST (alias for LASTARG)
 LASTARG (key 105.2 in RPL mode; PRG NXT NXT ERROR)
 LCD→ (PRG NXT GROB NXT)
 H LCM (ARITH POLY NXT NXT; «POLYNOMIAL»; «INTEGER» NXT)
 H LCXM (137.02 MENU; 85 DUP MENUXY)
 LC~C (256.04 MENU)
 H LDEC (S.SLV; SYMB SOLVE; CALC DIFF; «SOLVER»)
 H LEGENDRE (ARITH POLY NXT NXT; «POLYNOMIAL»)
 H LGCD (ARITH NXT)
 LIBEVAL (CAT)
 LIBS (110 MENU)
 - LIMIT (alias for lim)
 H LIN (ALG; EXP&LN; SYMB ALG; CONVERT REWRITE; SYMB NXT EXPLN; «EXP&LN»; «REWRITE»)
 LINE (PRG NXT PICT)
 LINFIT (90/99 MENU)
 LININ (PRG TEST PREV)
 H LINSOLVE (S.SLV; SYMB SOLVE; MATRICES LIN-S; «SOLVER»; «MATR» NXT NXT)

I - 8 The Command Menu-Path Table

LIST→ (CAT)
 LN (key 51.3; 141 MENU)
 H LNAME (109 DUP MENUXY)
 H LNCOLLECT (ALG; EXP&LN; SYMB NXT EXPLN; CONVERT REWRITE NXT; <<EXP&LN>>; <<REWRITE>>)
 LNP1 (EXP&LN; MTH HYP NXT)
 H LOCAL (CAT)
 LOG (key 61.3; 141.02 MENU)
 LOGFIT (90/99 MENU)
 LQ (MATRICES FACT; MTH MATRX FACTR)
 LR (102 MENU)
 LR~R (256.04 MENU)
 LSQ (MTH MATRX; RS&NUM.SLV SYS; MATRICES OPER NXT)
 LU (MATRICES FACT; MTH MATRX FACTR)
 H LVAR (106 DUP MENUXY)
 H MAD (MATRICES OPER NXT; <<MATR>> NXT NXT)
 H MAIN (<<ARIT>>, <<CONSTANTS>>)
 MAKESTR (256.05 MENU)
 MANT (MTH REAL NXT)
 H MAP (102 DUP MENUXY)
 H MATHS (<<MAIN>>)
 H MATR (<<MAIN>> NXT)
 MAX (MTH REAL)
 MAXR (MTH NXT CONST NXT)
 MAXΣ (100 MENU)
 MCALC (APPS 12 MES; 116 MENU)
 MEAN (100 MENU)
 MEM (PRG MEM)
 MENU (LS&MODE MENU; PRG NXT MODES MENU)
 H MENUXY (788.21 MENU)
 MERGE (CAT) - do not use
 MIN (MTH REAL)
 MINEHUNT (APPS 12 UTILS; 117 MENU)
 MINIFONT→ (CAT)
 MINIT (APPS 12 MES; 116 MENU)
 MINR (MTH NXT CONST NXT)
 MINE (100 MENU)
 MITM (APPS 12 MES; 116 MENU)
 H MKISOM (MATRICES LINAP)
 MOD (MTH REAL; ARITH MODUL NXT; <<CMLPX>> NXT)
 H MODSTO (ARITH MODUL NXT; <<MODULAR>> NXT)
 H MODULAR (<<ARIT>>; <<MATHS>>)
 MROOT (APPS 12 MES; 116 MENU)
 MSGBOX (PRG NXT OUT)
 H MSLV (NUM.SLV 6; 132 MENU)
 MSOLVR (APPS 12 EQLIB/MES; 114/116 MENU)
 H MULTMOD (ARITH MODUL NXT; <<MODULAR>> NXT)
 MUSER (APPS 12 MES; 116 MENU)
 NDIST (MTH NXT PROB NXT)
 NDUPN (PRG/TOOL STACK PREV)
 NEG (key 62.1: +/-; CMLPX; MTH NXT CMLPX NXT; <<CMLPX>> NXT)
 NEWOB (PRG MEM)
 NEXT (PRG BRCH START/FOR)

H NEXTPRIME (ARITH INTEG NXT; «INTEGER» NXT)
NIP (PRG/TOOL STACK NXT NXT)
NOT (PRG TEST NXT; [MTH/CONVERT] BASE NXT LOGIC; «TESTS» NXT)
NOVAL (PRG NXT IN)
NSUB (PRG LIST PROC)
NUM (RS&CHARS; PRG TYPE NXT; PRG NXT CHARS)
NUMX (86.02 MENU)
NUMY (86.02 MENU)
NE (103 MENU)
OBJ→ (PRG TYPE; PRG LIST; RS&CHARS NXT; PRG NXT CHARS NXT)
OCT ([MTH/CONVERT] BASE)
OFF (PRG NXT NXT RUN NXT)
OLDPRT (108 MENU)
OPENIO (109 MENU)
OR (PRG TEST NXT; [MTH/CONVERT] BASE NXT LOGIC; «TESTS» NXT)
ORDER (PRG MEM DIR NXT)
OVER (PRG/TOOL STACK)
H P2C (ARITH PERM)
H PA2B2 (ARITH INTEG NXT)
PARAMETRIC (82 MENU)
PARITY (106 MENU)
PARSURFACE (85 MENU)
H PARTFRAC (ALG; ARITH POLY NXT NXT; «ALGB»; «POLYNOMIAL» NXT)
PATH (PRG MEM DIR)
H PCAR (MATRICES NXT EIGEN; «MATR» NXT)
PCOEF (RS&NUM.SLV POLY; ARITH POLY NXT NXT)
PCONTOUR (85 MENU)
PCOV (102.02 MENU)
PDIM (PRG NXT PICT)
PEEK (256.03 MENU)
PEEKARM (256.07 MENU)
PERM (MTH NXT PROB)
PEVAL (RS&NUM.SLV POLY)
PGDIR (PRG MEM DIR)
PICK (PRG/TOOL STACK NXT)
PICK3 (PRG/TOOL STACK NXT)
PICT (PRG NXT PICT)
PICTURE (CAT; key left-arrow when not editing)
PINIT (110 MENU)
PIX? (PRG NXT PICT NXT)
PIXOFF (PRG NXT PICT NXT)
PIXON (PRG NXT PICT NXT)
PKT (105 MENU)
H PLOT (SYMB GRAPH; CALC GRAPH)
H PLOTADD (SYMB GRAPH; CALC GRAPH)
PMAX (CAT)
PMIN (CAT)
H PMINI (MATRICES NXT EIGEN)
POKE (256.03 MENU)
POKEARM (256.06 MENU)

I - 10 The Command Menu-Path Table

POLAR (82 MENU)
 H POLYNOMIAL («ARIT»; «MATHS»)
 H POP (CAT)
 POS (RS&CHARS; PRG LIST ELEM; PRG NXT CHARS)
 H POTENTIAL (CAT)
 H POWEXPAND (CONVERT REWRITE NXT; «REWRITE»)
 H POWMOD (ARITH MODUL NXT; «MODULAR» NXT)
 PR1 (104/107 MENU)
 PREDV (CAT)
 PREDX (102 MENU)
 PREDY (102 MENU)
 H PREVAL (CALC DERIV NXT; «DIFF» NXT)
 H PREVPRIME (ARITH INTEG NXT; «INTEGER» NXT)
 PRLCD (107 MENU) (hotkey: ON+uparrow)
 PROMPT (PRG NXT IN NXT)
 H PROMPTSTO (139 DUP MENUXY)
 PROOT (RS&NUM.SLV POLY; ARITH POLY NXT NXT)
 H PROPFRAC (SYMB ARITH; ARITH NXT; «POLYNOMIAL» NXT)
 PRST (107 MENU)
 PRSTC (107 MENU)
 PRVAR (107 MENU)
 PSDEV (100.02 MENU)
 H PSI (MTH NXT SPECIAL)
 H Psi (MTH NXT SPECIAL)
 H PTAYL (ARITH POLY NXT NXT; «POLYNOMIAL» NXT)
 PURGE (TOOL; PRG MEM; PRG MEM DIR)
 H PUSH (CAT)
 PUT (PRG LIST ELEM; MATRICES CREAT NXT; MTH MATRX MAKE NXT)
 PUTI (PRG LIST ELEM; MATRICES CREAT NXT; MTH MATRX MAKE NXT)
 PVAR (100.02 MENU)
 PVARs (110 MENU)
 PVIEW (PRG NXT OUT; PRG NXT PICT NXT)
 PWRFIT (90/99 MENU)
 PX-C (PRG NXT PICT NXT)
 QR (MATRICES FACT; MTH MATRX FACTR)
 QUAD (93 MENU)
 H QUOT (ARITH POLY PREV; «POLYNOMIAL» NXT)
 QUOTE («ALGB»; 93.03 MENU)
 H QXA (MATRICES QUADF; CONVERT MATRX; «MATR» NXT)
 RAD (LS&MODE ANGLE; PRG NXT MODES ANGLE)
 RAND (MTH NXT PROB)
 RANK (MATRICES OPER NXT; MTH MATRX NORM NXT)
 RANM (MTH MATRX MAKE; MATRICES CREAT NXT NXT)
 RATIO (CAT)
 RCEQ (RS&NUM.SLV ROOT RS-EQ)
 RCI (MTH MATRX ROW; MATRICES CREAT ROW)
 RCIJ (MTH MATRX ROW; MATRICES CREAT ROW)
 RCL (key 32.2; TOOL; PRG MEM DIR)
 RCLALARM (RS&TIME ALRM; PRG NXT NXT TIME ALRM)
 RCLF (LS&MODE FLAG NXT; PRG NXT MODES FLAG NXT)
 RCLKEYS (LS&MODE KEYS; PRG NXT MODES KEYS)
 RCLMENU (LS&MODE MENU; PRG NXT MODES MENU)

H RCLVX (CAT)
 RCLE (91/97 MENU RS-EDAT)
 RCWS ([MTH/CONVERT] BASE NXT)
 RDM (MTH MATRX MAKE; MATRICES CREAT NXT NXT)
 RDZ (MTH NXT PROB)
 RE (CMLPX NXT; MTH NXT CMLPX; «CMLPX» NXT)
 RECN (104.02 MENU)
 RECT (LS&MODE ANGLE; MTH VECTR NXT; PRG NXT MODES ANGLE)
 RECV (104 MENU)
H REF (MATRICES LIN-S; «MATR»)
H REMAINDER (ARITH POLY PREV; «POLYNOMIAL» NXT)
 RENAME (CAT)
H REORDER (105 DUP MENUXY)
 REPEAT (PRG BRCH WHILE)
 REPL (RS&CHARS; PRG LIST; PRG NXT GROB; PRG NXT CHARS; MTH MATRX MAKE NXT;
 MATRICES CREAT NXT NXT)
 RES (83 MENU)
 RESTORE (PRG MEM NXT)
H RESULTANT (ARITH POLY PREV)
 REVLIST (MTH LIST; PRG LIST PROC)
H REWRITE («MAIN» NXT)
H RISCH (CALC DERIV NXT; «DIFF» NXT)
 RKF (RS&NUM.SLV DIFFEQ)
 RKFERR (RS&NUM.SLV DIFFEQ)
 RKFSTEP (RS&NUM.SLV DIFFEQ)
 RL ([MTH/CONVERT] BASE NXT BIT)
 RLB ([MTH/CONVERT] BASE NXT BYTE)
 RND (MTH REAL NXT NXT)
 RNRM (MTH MATRX NORM; MATRICES OPER NXT)
 ROLL (PRG/TOOL STACK NXT)
 ROLLD (PRG/TOOL STACK NXT)
 ROMUPLOAD (CAT)
 ROOT (RS&NUM.SLV ROOT)
 ROT (PRG/TOOL STACK)
 ROW+ (MTH MATRX ROW; MATRICES CREAT ROW)
 ROW- (MTH MATRX ROW; MATRICES CREAT ROW)
 ROW→ (MTH MATRX ROW; MATRICES CREAT ROW)
 RPL> (CAT)
 RR ([MTH/CONVERT] BASE NXT BIT)
 RRB ([MTH/CONVERT] BASE NXT BYTE)
 RREF (MATRICES LIN-S; MTH MATRX FACTR)
H RREFMOD (120 DUP MENUXY)
 RRK (RS&NUM.SLV DIFFEQ)
 RRKSTEP (RS&NUM.SLV DIFFEQ)
 RSBERR (RS&NUM.SLV DIFFEQ)
 RSD (MTH MATRX NXT; RS&NUM.SLV SYS; MATRICES OPER NXT)
 RSWP (MTH MATRX ROW NXT; MATRICES CREAT ROW NXT)
 RULES (CAT)
 R~SB (256.04 MENU)
 R→B ([MTH/CONVERT] BASE)

R--C (PRG TYPE NXT; MTH NXT CMPLX)
R--D (MTH REAL NXT NXT)
R--I (CONVERT REWRITE NXT NXT)
SAME (PRG TEST NXT)
SBRK (109 MENU)
SB~B (256.04 MENU)
SCALE (83.02 MENU)
SCALEH (83.02 MENU)
SCALEW (83.02 MENU)
SCATRLOT (101 MENU)
SCATTER (88 MENU)
SCHUR (MATRICES FACT; MTH MATRX FACTR)
SCI (LS&MODE FMT; PRG NXT MODES FMT)
SCLE (CAT)
SCONJ (PRG MEM ARITH NXT)
H SCROLL (TOOL VIEW is the same as SCROLL DROP; 125 DUP MENUXY)
SDEV (100 MENU)
SEND (104 MENU)
SEQ (PRG LIST PROC NXT)
SERIAL (256.05 MENU)
H SERIES (SYMB CALC; CALC LIMIT; «DIFF» NXT)
SERVER (105 MENU)
H SEVAL (100 DUP MENUXY)
SF (LS&MODE FLAG; PRG TEST NXT NXT; PRG NXT MODES FLAG)
SHOW (93 MENU)
SIDENS (APPS 12 UTILS; 117 MENU)
H E (CALC DERIV NXT)
H EVX (CALC DERIV NXT NXT)
SIGN (CMPLX NXT; MTH REAL NXT; MTH NXT CMPLX NXT; «CMPLX» NXT)
H SIGNTAB (SYMB GRAPH; CALC GRAPH)
H SIMP2 (ARITH NXT)
H SIMPLIFY (in EQW; CONVERT REWRITE NXT; «REWRITE»; «EQW»)
SIN (key 53)
H SINCOS (TRIG NXT; CONVERT TRIG; SYMB NXT EXPLN; «TRIGO»; «REWRITE»)
SINH (MTH HYP; TRIG HYP; «HYPERBOLIC»)
SINV (PRG MEM ARITH NXT)
SIZE (RS&CHARS; MTH MATRX MAKE; PRG LIST ELEM; PRG NXT CHARS; PRG NXT GROB NXT;
MATRICES OPER NXT NXT)
SL ([MTH/CONVERT] BASE NXT BIT)
SLB ([MTH/CONVERT] BASE NXT BYTE)
SLOPEFIELD (85 MENU)
SNEG (PRG MEM ARITH NXT)
SNRM (MTH MATRX NORM; MATRICES OPER NXT NXT)
H SOLVE (S.SLV; SYMB SOLVE; ALG NXT; «SOLVER»)
SOLVEQN (APPS 12 EQLIB; 114 MENU)
H SOLVER («MAIN»)
H SOLVEVX (S.SLV; SYMB SOLVE; «SOLVER»)
SORT (MTH LIST; PRG LIST PROC NXT)
SPHERE (LS&MODE ANGLE; MTH VECTR NXT; PRG NXT MODES ANGLE)
SQ (key 52.2: x^2)
SR ([MTH/CONVERT] BASE NXT BIT)
SRAD (MTH MATRX NORM; MATRICES OPER NXT NXT)

SRB ([MTH/CONVERT] BASE NXT BYTE)
 SRECV (109 MENU)
 SREPL (RS&CHARS NXT; PRG NXT CHARS NXT)
 SREV (256.03 MENU)
 START (PRG BRCH [START])
 STD (LS&MODE FMT; PRG NXT MODES FMT)
 STEP (PRG BRCH START/FOR)
 STEQ (RS&NUM.SLV ROOT LS-EQ)
 STIME (109 MENU)
 STO (key 32.1; PRG MEM DIR)
 STO* (PRG MEM ARITH)
 STO+ (PRG MEM ARITH)
 STO- (PRG MEM ARITH)
 STO/ (PRG MEM ARITH)
 STOALARM (RS&TIME ALRM; PRG NXT NXT TIME ALRM)
 STOF (LS&MODE FLAG NXT; PRG NXT MODES FLAG NXT)
 STOKEYS (LS&MODE KEYS; PRG NXT MODES KEYS)
 H STORE («ALGB» NXT)
 H STOVX (CAT)
 STOE (91/97 MENU LS-EDAT)
 STREAM (PRG LIST PROC)
 STR→ (CAT)
 H STURM (ARITH POLY PREV)
 H STURMAB (ARITH POLY PREV)
 STWS ([MTH/CONVERT] BASE NXT)
 SUB (RS&CHARS; PRG LIST; PRG NXT GROB; PRG NXT CHARS; MATRICES CREAT NXT NXT;
 MTH MATRX MAKE NXT)
 H SUBST (ALG NXT; SYMB ALG; «ALGB» NXT)
 H SUBTMOD (ARITH MODUL NXT; «MODULAR» NXT)
 SVD (MATRICES FACT; MTH MATRX FACTR)
 SVL (MATRICES FACT NXT; MTH MATRX FACTR NXT)
 SWAP (PRG/TOOL STACK)
 H SYLVESTER (MATRICES QUADF; «MATR» NXT)
 SYSEVAL (CAT)
 H SYST2MAT (CONVERT MATRX; MATRICES LIN-S)
 S~N (256.04 MENU)
 S→H (256.02 MENU)
 H TABVAL (SYMB GRAPH NXT; CALC GRAPH NXT)
 H TABVAR (SYMB GRAPH NXT; CALC GRAPH NXT; «DIFF» NXT)
 TAIL (RS&CHARS NXT; PRG LIST ELEM NXT; PRG NXT CHARS NXT)
 TAN (key 55.1)
 H TAN2CS2 («TRIGO» NXT)
 H TAN2SC (SYMB TRIG; TRIG NXT; CONVERT TRIG NXT; «TRIGO» NXT)
 H TAN2SC2 (SYMB TRIG; TRIG NXT; CONVERT TRIG NXT; «TRIGO» NXT)
 TANH (MTH HYP; TRIG HYP; «HYPERBOLIC»)
 H TAYLOR0 (CALC LIMIT; SYMB CALC NXT; «DIFF» NXT)
 TAYLR (CALC LIMIT)
 H TCHEBYCHEFF («POLYNOMIAL» NXT; 91 DUP MENUXY)
 H TCOLLECT (TRIG NXT; «TRIGO» NXT)
 TDELTA (APPS 12 UTILS NXT; 117.02 MENU)

H TESTS («MATHS» NXT)
H TEVAL (101 DUP MENUXY)
H TEXPAND (EXP&LN; SYMB ALG; SYMB TRIG; ALG NXT; TRIG NXT; SYMB NXT EXPLN; «EXP&LN»;
«TRIGO» NXT; «ALGB» NXT)
TEXT (PRG NXT OUT)
THEN (PRG BRCH IF/CASE; PRG NXT NXT ERROR IFERR)
TICKS (RS&TIME; PRG NXT NXT TIME; APPS 5 4)
TIME (RS&TIME; PRG NXT NXT TIME; APPS 5 4)
TINC (APPS 12 UTILS NXT; 117.02 MENU)
H TLIN (SYMB TRIG; TRIG NXT; CONVERT TRIG NXT; «TRIGO» NXT)
TLINE (PRG NXT PICT)
TMENU (LS&MODE MENU; PRG NXT MODES MENU)
TOT (100 MENU)
TRACE (MATRICES OPER NXT NXT; MTH MATRX NORM NXT)
H TRAN (MATRICES OPER NXT NXT; MTH MATRX NORM NXT; «MATR»)
TRANSIO (106 MENU)
H TRIG (SYMB TRIG; TRIG NXT NXT; CONVERT TRIG NXT; «TRIGO» NXT NXT)
H TRIGCOS (TRIG NXT NXT; CONVERT TRIG NXT; «TRIGO» NXT NXT)
H TRIGO («MAIN»)
H TRIGSIN (TRIG NXT NXT; CONVERT TRIG NXT; «TRIGO» NXT NXT)
H TRIGTAN (TRIG NXT NXT; «TRIGO» NXT NXT)
TRN (MTH MATRX MAKE)
TRNC (MTH REAL NXT NXT)
H TRUNC («DIFF» NXT NXT; 99 DUP MENUXY)
TRUTH (82 MENU)
H TSIMP (EXP&LN NXT; TRIG NXT NXT; CONVERT TRIG NXT NXT; «EXP&LN»)
TSTR (RS&TIME NXT NXT; PRG NXT NXT TIME NXT NXT; APPS 5 4 NXT NXT)
TVARS (PRG MEM DIR NXT)
TVM (RS&NUM.SLV TVM SOLVR)
TVMBEG (CAT; RS&NUM.SLV TVM LS-BEG)
TVMEND (CAT; RS&NUM.SLV TVM RS-BEG)
TVMROOT (RS&NUM.SLV TVM)
TYPE (PRG TEST NXT; PRG TYPE NXT NXT)
UBASE ([CONVERT] UNITS TOOLS)
UFACT ([CONVERT] UNITS TOOLS)
UFL1-MINIF (CAT)
H UNASSIGN («ALGB» NXT)
H UNASSUME («TESTS»)
H UNBIND (CAT)
UNPICK (PRG/TOOL STACK NXT)
UNROT (PRG/TOOL STACK)
UNTIL (PRG BRCH DO)
UPDIR (key 31.2)
UTPC (MTH NXT PROB NXT)
UTPF (MTH NXT PROB NXT)
UTPN (MTH NXT PROB NXT)
UTPT (MTH NXT PROB NXT)
UVAL ([CONVERT] UNITS TOOLS)
H VANDERMONDE (MATRICES CREAT NXT NXT; MTH MATRX MAKE NXT NXT; «MATR» NXT NXT)
VAR (100.02 MENU)
VARS (PRG MEM DIR NXT)
H VER (140 DUP MENUXY)

VERSION (CAT)
 VISIT (key LS- \odot)
 VISITB (CAT)
 H VPOTENTIAL (CAT)
 VTYPE (PRG TYPE NXT NXT)
 V \rightarrow (MTH VECTR)
 WAIT (PRG NXT IN)
 WHILE (PRG BRCH [WHILE])
 WIREFRAME (85 MENU)
 WSLOG (CAT)
 XCOL (89/98 MENU)
 XGET (CAT)
 XLIB~ (256.06 MENU)
 XMIT (109 MENU)
 H XNUM («REWRITE»; 142.02 MENU)
 XOR (PRG TEST NXT; [MTH/CONVERT] BASE NXT LOGIC)
 XPON (MTH REAL NXT)
 XPUT (CAT)
 H XQ («REWRITE»; 142.02 MENU)
 XRCV (104.02 MENU)
 XRNG (83 MENU)
 XROOT (key 52.3: x-root-of-y)
 XSEND (104.02 MENU)
 XSERV (CAT)
 XVOL (86 MENU)
 XXRNG (86 MENU)
 YCOL (89/98 MENU)
 YRNG (83 MENU)
 YSLICE (85 MENU)
 YVOL (86 MENU)
 YYRNG (86 MENU)
 H ZEROS (SYMB SOLVE; S.SLV NXT; «SOLVER»)
 ZFACTOR (APPS 12 UTILS; 117 MENU)
 ZVOL (86 MENU)
 ^ (key 51.1: y^x)
 _ (key 85.3)
 dB (APPS 12 UTILS NXT; 117.02 MENU)
 e (ALPHA-LS-E; MTH NXT CONST; «CONSTANTS»)
 gmol (APPS 12 UTILS NXT; 117.02 MENU)
 i (key 23.2; CMPLX; MTH NXT CONST; «CMPLX»; «CONSTANTS»)
 lbmol (APPS 12 UTILS NXT; 117.02 MENU)
 H lim (SYMB CALC; CALC LIMIT; «DIFF» NXT)
 H qr (MATRICES FACT)
 rpm (APPS 12 UTILS NXT; 117.02 MENU)
 H rref (SYMB SOLVE; MATRICES LIN-S; «MATR»)
 | (key 23.3; «ALGB» NXT; 93.02 MENU)
 $\sqrt{\quad}$ (key 52.1)
 \int (key 55.3)
 Σ (key 53.3)
 $\Sigma+$ (91/97 MENU)

E- (91/97 MENU)
 ELINE (102 MENU)
 ELIST (MTH LIST)
 EX (103 MENU)
 - EX^2 (alias for EX2)
 EX2 (103 MENU)
 - EX*Y (alias for EXY)
 EXY (103 MENU)
 EY (103 MENU)
 - EY^2 (alias for EY2)
 EY2 (103 MENU)
 ► (key 32.1: STO)
 π (key 104.2; MTH NXT CONST; «CONSTANTS»)
 ∂ (key 54.3)
 ≤ (key 63.2; PRG TEST; «TESTS»)
 ≥ (key 64.2; PRG TEST; «TESTS»)
 ≠ (key 62.2; PRG TEST; «TESTS» NXT)
 → (key 102.3)
 -A (256 MENU)
 -ALG (256.02 MENU)
 -ARRAY (PRG TYPE)
 -CD (256.02 MENU)
 -COL (MTH MATRX COL; MATRICES CREAT COL)
 -DATE (RS&TIME; PRG NXT NXT TIME; APPS 5 4)
 -DIAG (MATRICES CREAT; MTH MATRX NXT; MTH MATRX MAKE NXT NXT)
 -FONT (CAT)
 -GROB (PRG NXT GROB)
 -H (256 MENU)
 -HEADER (CAT)
 -HMS (RS&TIME NXT; PRG NXT NXT TIME NXT; APPS 5 4 NXT)
 -KEYTIME (CAT)
 -LANGUAGE (CAT)
 -LCD (PRG NXT GROB NXT)
 -LIST (PRG TYPE; PRG LIST)
 -LST (256.02 MENU)
 -MINIFONT (CAT)
 -NDISP (CAT)
 -NUM (key 105.3; CONVERT REWRITE NXT)
 -PRG (256.03 MENU)
 -Q (CONVERT REWRITE NXT)
 -Qπ (CONVERT REWRITE NXT)
 -RAM (256.03 MENU)
 -ROW (MTH MATRX ROW; MATRICES CREAT ROW)
 -S2 (256.06 MENU)
 -STR (PRG TYPE; RS&CHARS NXT; PRG NXT CHARS NXT)
 -TAG (PRG TYPE)
 -TIME (RS&TIME; PRG NXT NXT TIME; APPS 5 4)
 -UNIT (PRG TYPE; [CONVERT] UNITS TOOLS)
 -V2 (MTH VECTR)
 -V3 (MTH VECTR)
 ↓MATCH (93.02 MENU)
 ↑MATCH (93.02 MENU)

```
ΔLIST (MTH LIST)
ΠLIST (MTH LIST)
H ∞ (key 102.2; «CONSTANTS»)
<< (key 95.3)
>> (key 95.3)
```

ASCII Character Codes and Translations

The following tables show the relation between character codes (results of NUM, arguments to CHR) and characters (results of CHR, arguments to NUM). The second table includes ASCII character translations.

Character Codes (0-127)

| NUM | CHR | NUM | CHR | NUM | CHR | NUM | CHR |
|-----|------|-----|-----|-----|-----|-----|-----|
| 0 | ␣ | 32 | | 64 | @ | 96 | ' |
| 1 | ␣ | 33 | ! | 65 | A | 97 | a |
| 2 | ␣ | 34 | " | 66 | B | 98 | b |
| 3 | ␣ | 35 | # | 67 | C | 99 | c |
| 4 | ␣ | 36 | \$ | 68 | D | 100 | d |
| 5 | ␣ | 37 | % | 69 | E | 101 | e |
| 6 | ␣ | 38 | & | 70 | F | 102 | f |
| 7 | ␣ | 39 | ' | 71 | G | 103 | g |
| 8 | ␣ | 40 | (| 72 | H | 104 | h |
| 9 | ␣ | 41 |) | 73 | I | 105 | i |
| 10 | <cr> | 42 | * | 74 | J | 106 | j |
| 11 | ␣ | 43 | + | 75 | K | 107 | k |
| 12 | ␣ | 44 | , | 76 | L | 108 | l |
| 13 | ␣ | 45 | - | 77 | M | 109 | m |
| 14 | ␣ | 46 | . | 78 | N | 110 | n |
| 15 | ␣ | 47 | / | 79 | O | 111 | o |
| 16 | ␣ | 48 | 0 | 80 | P | 112 | p |
| 17 | ␣ | 49 | 1 | 81 | Q | 113 | q |
| 18 | ␣ | 50 | 2 | 82 | R | 114 | r |
| 19 | ␣ | 51 | 3 | 83 | S | 115 | s |
| 20 | ␣ | 52 | 4 | 84 | T | 116 | t |
| 21 | ␣ | 53 | 5 | 85 | U | 117 | u |
| 22 | ␣ | 54 | 6 | 86 | V | 118 | v |
| 23 | ␣ | 55 | 7 | 87 | W | 119 | w |
| 24 | ␣ | 56 | 8 | 88 | X | 120 | x |
| 25 | ␣ | 57 | 9 | 89 | Y | 121 | y |
| 26 | ␣ | 58 | : | 90 | Z | 122 | z |
| 27 | ␣ | 59 | ; | 91 | [| 123 | < |
| 28 | ⬦ | 60 | < | 92 | \ | 124 | |
| 29 | ■ | 61 | = | 93 |] | 125 | > |
| 30 | ... | 62 | > | 94 | ^ | 126 | ~ |
| 31 | ... | 63 | ? | 95 | _ | 127 | ⌘ |

The table shown below includes the codes to be used to transmit characters from the upper half of the ASCII character table when transmitted from the calculator to a remote device.

Character Codes 128-255 With ASCII Character Translations

| NUM | CHR | TRANS | NUM | CHR | TRANS | NUM | CHR | TRANS |
|-----|-----|-------|-----|-----|-------|-----|-----|-------|
| 128 | € | \<> | 171 | « | \<< | 214 | ö | \214 |
| 129 |  | \x- | 172 |  | \172 | 215 |  | \.x |
| 130 |  | \.v | 173 | - | \173 | 216 | ø | \0/ |
| 131 | | \w/ | 174 |  | \164 | 217 |  | \217 |
| 132 |  | \.s | 175 | - | \175 | 218 |  | \218 |
| 133 |  | \GS | 176 |  | \^o | 219 |  | \219 |
| 134 |  | \ > | 177 |  | \177 | 220 |  | \220 |
| 135 |  | \pi | 178 |  | \178 | 221 |  | \221 |
| 136 |  | \.d | 179 |  | \179 | 222 |  | \222 |
| 137 |  | \<= | 180 |  | \180 | 223 |  | \Gb |
| 138 |  | \>= | 181 |  | \Gm | 224 |  | \224 |
| 139 |  | \=/ | 182 |  | \182 | 225 |  | \225 |
| 140 |  | \Ga | 183 |  | \183 | 226 |  | \226 |
| 141 |  | \-> | 184 |  | \184 | 227 |  | \227 |
| 142 |  | \<- | 185 |  | \185 | 228 |  | \228 |
| 143 |  | \ v | 186 |  | \186 | 229 |  | \229 |
| 144 |  | \ ^ | 187 |  | \>> | 230 |  | \230 |
| 145 |  | \Gg | 188 |  | \188 | 231 |  | \231 |
| 146 |  | \Gd | 189 |  | \189 | 232 |  | \232 |
| 147 |  | \Ge | 190 |  | \190 | 233 |  | \233 |
| 148 |  | \Gn | 191 | | \191 | 234 |  | \234 |
| 149 |  | \Gh | 192 | ¡ | \192 | 235 |  | \235 |
| 150 |  | \G1 | 193 | ¢ | \193 | 236 |  | \236 |
| 151 |  | \Gr | 194 | £ | \194 | 237 |  | \237 |
| 152 |  | \Gs | 195 | ¤ | \195 | 238 |  | \238 |
| 153 |  | \Gt | 196 | ¥ | \196 | 239 |  | \239 |
| 154 |  | \Gw | 197 | ¦ | \197 | 240 |  | \240 |
| 155 |  | \GD | 198 | § | \198 | 241 |  | \241 |
| 156 |  | \PI | 199 | ¨ | \199 | 242 |  | \242 |
| 157 |  | \GW | 200 | © | \200 | 243 |  | \243 |
| 158 |  | \[] | 201 | ª | \201 | 244 |  | \244 |
| 159 |  | \oo | 202 | « | \202 | 245 |  | \245 |
| 160 |  | \160 | 203 | ¬ | \203 | 246 |  | \246 |
| 161 |  | \161 | 204 | ­ | \204 | 247 |  | \:- |
| 162 |  | \162 | 205 | ® | \205 | 248 |  | \248 |
| 163 |  | \163 | 206 | ¯ | \206 | 249 |  | \249 |
| 164 |  | \164 | 207 | ° | \207 | 250 |  | \250 |
| 165 |  | \165 | 208 | ± | \208 | 251 |  | \251 |
| 166 |  | \166 | 209 | ² | \209 | 252 |  | \252 |
| 167 |  | \167 | 210 | ³ | \210 | 253 |  | \253 |
| 168 |  | \168 | 211 | ´ | \211 | 254 |  | \254 |
| 169 |  | \169 | 212 | µ | \212 | 255 |  | \255 |
| 170 |  | \170 | 213 | ¶ | \213 | | | |

Index

| Symbols | | | |
|------------------------------|-------------|---|-------------|
| - (Subtract) | 3-222 | →MAP | 6-2 |
| ! (Factorial) | 3-214 | →ROW | 3-152 |
| % (Percent) | 3-214 | →S2 | 6-4 |
| %CH | 3-26 | →STR | 3-176 |
| %T | 3-179 | →TAG | 3-180 |
| %TILE (Percentile of a list) | 2-10 | →TIME | 3-183 |
| * (Multiply) | 3-219 | →UNIT | 3-191 |
| / (Divide) | 3-223 | →V2 | 3-195 |
| ? (Undefined) | 3-212, 4-81 | →V3 | 3-195 |
| ^ (Power) | 3-209 | ∂ (Derivative) | 3-213 |
| _ (Unit attachment) | 3-215 | ≠ (Not equal) | 3-219 |
| (Where) | 3-209 | 1D Elastic Collisions (4, 5) | 5-24 |
| MATCH | 3-101 | ≥ (Greater than or Equal) | 3-218 |
| ↓MATCH | 3-100 | ∞ (Infinity) | 3-212, 4-81 |
| + (Add) | 3-220 | | |
| < (Less than) | 3-215 | A | |
| = (Equal) | 3-223 | A→ | 6-2 |
| == (Logical Equality) | 3-224 | A→H | 6-2 |
| > (Greater than) | 3-217 | ABCUV | 3-4, 4-12 |
| ► (Store) | 3-225 | ABS | 3-4 |
| « » (Program delimiters) | 3-215 | ACK | 3-4 |
| √ (Square Root) | 3-210 | ACKALL | 3-4 |
| ∫ (Integrate) | 3-211 | ACOS | 3-5 |
| ≤ (Less than or Equal) | 3-216 | ACOS2S | 3-6, 4-12 |
| → (Create Local) | 3-225 | ACOSH | 3-6 |
| →A | 6-2 | ADD | 3-7 |
| →ALG | 6-5 | ADDTMOD | 3-8, 4-12 |
| →ARRAY | 3-12 | ADDTOREAL | 3-8, 4-13 |
| →CD | 6-3 | ALGB | 3-8, 4-13 |
| →COL | 3-30 | ALOG | 3-8 |
| →DATE | 3-39 | ALRMDAT | D-2 |
| →DIAG | 3-45 | AMORT | 3-8 |
| →FONT | 3-67 | AND | 3-8 |
| →GROB | 3-74 | Angular Mechanics (4, 2) | 5-23 |
| →H | 6-3 | Angular Motion (8, 4) | 5-36 |
| →HEADER | 3-76 | ANIMATE | 3-9 |
| →HMS | 3-79 | Animating a Graphical Image | 2-39 |
| →KEYTIME | 3-89 | Animation of Successive Taylor's Polynomials | 2-30 |
| →LANGUAGE | 3-91 | ANS | 3-10 |
| →LCD | 3-92 | APEEK | 6-1 |
| →LIST | 3-94 | APPLY | 3-10 |
| →LST | 6-6 | Applying a Program to an Array | 2-20 |
| →MINIFONT | 3-105 | ARC | 3-10 |
| →NDISP | 3-108 | ARCHIVE | 3-11 |
| →NUM | 3-111 | ARG | 3-11 |
| →PRG | 6-6 | ARIT | 3-12, 4-13 |
| →Q | 3-135 | ARM→ | 6-35 |
| →Qπ | 3-135 | ARRAY→ | 3-12 |
| | | ASCII Character Codes and Translations | J-1 |

| | | | |
|------------------------------|------------|---|------------|
| ASIN | 3-12 | CAS Operations | 4-1 |
| ASIN2C | 3-14, 4-14 | CAS Settings | 4-2 |
| ASIN2T | 3-14, 4-14 | CAS Settings, Selecting | 4-2 |
| ASINH | 3-14 | CAS, Using the | 4-4 |
| ASM | 6-8 | CASCFG | 3-25, 4-17 |
| ASM→ | 6-34 | CASCMD | 3-25, 4-17 |
| ASN | 3-14 | CASE | 3-25 |
| ASR | 3-15 | Causing and Analyzing Errors | 1-32 |
| ASSUME | 3-16, 4-14 | CD→ | 6-3 |
| ATAN | 3-16 | CEIL | 3-25 |
| ATAN2S | 3-17, 4-15 | CENTR | 3-26 |
| ATANH | 3-17 | Centripetal Force (4, 3) | 5-23 |
| ATICK | 3-18 | CF | 3-26 |
| ATTACH | 3-18 | CHINREM | 3-27, 4-17 |
| AUGMENT | 3-19, 4-15 | CHOLESKY | 3-27, 4-18 |
| AUTO | 3-19 | CHOOSE | 3-27 |
| AXES | 3-20 | CHR | 3-27 |
| AXL | 3-20, 4-15 | CIRC | 3-28, 4-18 |
| AXM | 3-20, 4-16 | Circle (11, 1) | 5-44 |
| AXQ | 3-20, 4-16 | Circular Motion (8, 5) | 5-36 |
| | B | Circular Ring (11, 5) | 5-46 |
| B→R | 3-24 | CKSM | 3-28 |
| BAR | 3-20 | CLEAR | 3-28 |
| BARPLOT | 3-21 | CLKADJ | 3-28 |
| BASIS | 3-22, 4-16 | CLLCD | 3-29 |
| BAUD | 3-22 | CLOSEIO | 3-29 |
| BDISP (Binary Display) | 2-7 | CLVAR | 3-29 |
| BEEP | 3-22 | CLΣ | 3-29 |
| Beeping to Get Attention | 1-45 | CMLPX | 3-29 |
| Bernoulli Equation (3, 2) | 5-19 | CNRM | 3-30 |
| Bessel Functions | 2-29 | COL- | 3-30 |
| BESTFIT | 3-22 | COL+ | 3-31 |
| BIN | 3-22 | COL→ | 3-30 |
| BINS | 3-23 | COLCT | 3-31 |
| Bipolar Transistors (13, 3) | 5-53 | COLLECT | 3-31, 4-19 |
| Black Body Radiation (6, 6) | 5-31 | Columns and Beams (1) | 5-3 |
| BLANK | 3-23 | COLΣ | 3-31 |
| BOX | 3-23 | COMB | 3-32 |
| Brewster's Law (9, 3) | 5-38 | COMP→ | 6-5 |
| BUFLEN | 3-24 | Command Menu-Path Table, The | 1-1 |
| BYTES | 3-24 | Compatibility with Other Calculators | 4-4 |
| | C | Compiled Local Variables | 1-10 |
| C→PX | 3-38 | Computer Algebra Commands | 4-1 |
| C→R | 3-39 | CON | 3-32 |
| C2P | 3-24, 4-17 | COND | 3-33 |
| Calculations in a Program | 1-2 | Conditional Structures and Commands, Using | 1-13 |
| Cantilever Deflection (1, 7) | 5-7 | Conduction (6, 3) | 5-29 |
| Cantilever Moment (1, 9) | 5-8 | Conduction + Convection (6, 5) | 5-30 |
| Cantilever Shear (1, 10) | 5-8 | Cone (12, 1) | 5-47 |
| Cantilever Slope (1, 8) | 5-7 | CONIC | 3-33 |
| Capacitive Energy (2, 9) | 5-13 | Conical Pendulum (10, 3) | 5-42 |
| Capacitor Charge (2, 13) | 5-14 | CONJ | 3-34 |
| CAS Commands Introduction | 4-1 | CONLIB | 3-34 |
| CAS directory, CASDIR, The | 4-2 | | |

| | | | |
|---|------------|--|------------|
| CONST | 3-35 | DEGREE | 3-42, 4-21 |
| CONSTANTS | 3-35, 4-19 | DELALARM | 3-42 |
| CONT | 3-35 | DELAY | 3-42 |
| Contents of a Program, The | 1-1 | DELKEYS | 3-42 |
| Contents of the Reserved Variables | D-2 | DEPND | 3-43 |
| Convection (6, 4) | 5-30 | DEPTH | 3-44 |
| CONVERT | 3-35 | DERIV | 3-44, 4-21 |
| Converting Between Number Bases | 2-22 | DERVX | 3-44, 4-21 |
| Converting Procedures from Algebraic to RPN | 2-27 | DESOLVE | 3-44, 4-22 |
| CORR | 3-35 | DET | 3-44 |
| COS | 3-36 | DETACH | 3-44 |
| COSH | 3-36 | Development Library, The | 6-1 |
| Coulomb's Law (2, 1) | 5-10 | DIAG→ | 3-45 |
| COV | 3-37 | DIAGMAP | 3-45, 4-22 |
| CR | 3-37 | DIFF | 3-45, 4-23 |
| CRC | 6-4 | DIFFEQ | 3-46 |
| CRDIR | 3-37 | DIR | 3-47 |
| Creating Local Variables | 1-7 | Disassemblers | 6-34 |
| Creating Programs on a Computer | 1-7 | DISP | 3-47 |
| Creating User-Defined Functions as Programs | 1-10 | DISP FREEZE HALT ... CONT for Input, Using | 1-37 |
| Critical Angle (9, 2) | 5-38 | Displaying a Binary Integer | 2-5 |
| CRLIB | 6-6 | DISPXY | 3-47 |
| CROSS | 3-37 | DISTRIB | 3-48, 4-23 |
| CST | D-3 | DIV | 3-48, 4-23 |
| CSWP | 3-38 | DIV2 | 3-48, 4-23 |
| CURL | 3-38, 4-19 | DIV2MOD | 3-48, 4-24 |
| Current Divider (2, 4) | 5-11 | DIVIS | 3-48, 4-24 |
| CYCLOTOMIC | 3-38, 4-20 | DIVMOD | 3-48, 4-25 |
| CYLIN | 3-38 | DIVPC | 3-48, 4-25 |
| Cylinder (12, 2) | 5-48 | DLIST | 3-95 |
| Cylindrical Capacitor (2,19) | 5-16 | dn | 3-48, 4-26 |
| | D | DO | 3-48 |
| D→R | 3-54 | DOERR | 3-49 |
| DARCY | 3-39 | DOLIST | 3-49 |
| Data Input Commands | 1-35 | DOMAIN | 3-50, 4-25 |
| Data Output Commands | 1-47 | DOSUBS | 3-50 |
| DATE | 3-39 | DOT | 3-50 |
| DATE+ | 3-40 | Drag Force (4, 6) | 5-24 |
| DEBUG | 3-40 | DRAW | 3-51 |
| DC Capacitor Current (2, 12) | 5-14 | DRAW3DMATRIX | 3-51 |
| DC Inductor Voltage (2, 14) | 5-14 | DRAX | 3-51 |
| DDAYS | 3-40 | DROITE | 3-52, 4-26 |
| Dealing with unexpected CAS results or messages | 4-4 | DROP | 3-52 |
| DEC | 3-41 | DROP2 | 3-52 |
| DECR | 3-41 | DROPN | 3-52 |
| DEDICAGE | 3-41, 4-20 | DTAG | 3-52 |
| DEF | 3-41, 4-20 | DUP | 3-53 |
| DEFINE | 3-41 | DUP2 | 3-53 |
| Defining the Scope of Local Variables | 1-9 | DUPDUP | 3-53 |
| Definite Loop Structures, Using | 1-17 | DUPN | 3-53 |
| DEG | 3-42 | | E |
| | | e | 3-54 |
| | | Eccentric Columns (1, 2) | 5-4 |

| | | | |
|-----------------------------------|------------|---|------------|
| GRAD | 3-73 | INDEP | 3-84 |
| GRAMSCHMIDT | 3-73, 4-35 | Inductive Energy (2, 10) | 5-13 |
| GREDUCE | 3-73, 4-35 | INFORM | 3-85 |
| GRIDMAP | 3-73 | INFORM and CHOOSE for Input, Using | 1-42 |
| GROB | 3-74 | Input | 1-35 |
| GROBADD | 3-74 | INPUT | 3-86 |
| GXOR | 3-75 | INPUT ... ENTER for Input, Using | 1-38 |
| H | | | |
| H→ | 6-3 | INT | 3-86, 4-41 |
| H→A | 6-2 | INTEGER | 3-87, 4-42 |
| H→S | 6-3 | INTVX | 3-87, 4-42 |
| HADAMARD | 3-75, 4-36 | INV | 3-87 |
| HALFTAN | 3-75, 4-36 | Inverse-Function Solver | 2-38 |
| HALT | 3-75 | INVMOD | 3-87, 4-42 |
| HEAD | 3-75 | IOPAR | D-4 |
| HEADER→ | 3-76 | IP | 3-87 |
| Heat Capacity (6, 1) | 5-29 | IQUOT | 3-87, 4-43 |
| Heat Transfer (6) | 5-28 | IREMAINDER | 3-87, 4-43 |
| HELP | 3-76, 4-36 | Isentropic Flow (5, 5) | 5-26 |
| HERMITE | 3-76, 4-37 | ISOL | 3-87 |
| HESS | 3-76, 4-37 | ISOM | 3-88, 4-43 |
| HEX | 3-76 | Isothermal Expansion (5, 3) | 5-26 |
| HILBERT | 3-77, 4-37 | ISPRIME? | 3-88, 4-44 |
| HISTOGRAM | 3-77 | J | |
| HISTPLOT | 3-77 | JFETs (13, 4) | 5-53 |
| HMS- | 3-78 | JORDAN | 3-88, 4-44 |
| HMS+ | 3-78 | K | |
| HMS→ | 3-79 | KER | 3-88, 4-45 |
| HOME | 3-79 | KERRM | 3-88 |
| Hooke's Law (4, 4) | 5-23 | KEY | 3-89 |
| HORNER | 3-79, 4-38 | KEY for Keystroke Input, Using | 1-46 |
| I | | | |
| i | 3-80 | Keyboard Shortcuts | G-1 |
| I→R | 3-88 | KEYEVAL | 3-89 |
| IABCUV | 3-80, 4-38 | KEYTIME→ | 3-89 |
| IBASIS | 3-80, 4-38 | KGET | 3-90 |
| IBERNOULLI | 3-80, 4-39 | KILL | 3-90 |
| IBP | 3-80, 4-39 | Kinetic Theory (5, 8) | 5-28 |
| ICHINREM | 3-80, 4-40 | L | |
| Ideal Gas Law (5, 1) | 5-25 | LABEL | 3-90 |
| Ideal Gas State Change (5, 2) | 5-26 | Labeling and Displaying Output as Strings | 1-48 |
| IDIV2 | 3-81, 4-40 | Labeling Output with Tags | 1-47 |
| IDN | 3-80 | LAGRANGE | 3-90, 4-45 |
| IEGCD | 3-81, 4-40 | LANGUAGE→ | 3-91 |
| IF | 3-81 | LAP | 3-91, 4-45 |
| IFERR | 3-81 | LAPL | 3-91, 4-46 |
| IFFT | 3-82 | LAST | 3-91 |
| IFT | 3-83 | LASTARG | 3-91 |
| IFTE | 3-83 | Law of Gravitation (4, 7) | 5-24 |
| ILAP | 3-83, 4-41 | Law of Refraction (9, 1) | 5-37 |
| IM | 3-83 | LC~C | 6-5 |
| IMAGE | 3-84, 4-41 | LCD→ | 3-92 |
| INCR | 3-84 | LCM | 3-92, 4-46 |
| Indefinite Loop Structures, Using | 1-21 | LCXM | 3-92, 4-46 |
| | | LDEC | 3-92, 4-47 |

| | | | |
|--------------------------------|-------------|---|-------------|
| NUM | 3-112 | PLOTADD | 3-123 |
| NUMX | 3-112 | PMAX | 3-123 |
| NUMY | 3-112 | PMIN | 3-123 |
| O | | | |
| OBJ→ | 3-113 | PMINI | 3-124, 4-56 |
| Object in Free Fall (8, 2) | 5-35 | PN Step Junctions (13, 1) | 5-51 |
| Object Sizes | E-1 | Points to note when choosing settings | 4-3 |
| OCT | 3-113 | POKE | 6-1 |
| OFF | 3-113 | POKEARM | 6-2 |
| Ohm's Law and Power (2, 2) | 5-10 | POLAR | 3-124 |
| OLDPRT | 3-114 | POLYNOMIAL | 3-125, 4-57 |
| OPENIO | 3-114 | Polytropic Processes (5, 4) | 5-26 |
| Optics (9) | 5-37 | POP | 3-125 |
| OR | 3-114 | POS | 3-125 |
| ORDER | 3-115 | POTENTIAL | 3-125, 4-57 |
| Oscillations (10) | 5-40 | POWEXPAND | 3-125, 4-57 |
| Output | 1-46 | POWMOD | 3-125, 4-58 |
| OVER | 3-115 | PPAR | D-6 |
| P | | | |
| π (Pi) | 3-213 | PR1 | 3-125 |
| P2C | 3-115, 4-55 | PREDV | 3-126 |
| PA2B2 | 3-115, 4-55 | PREDX | 3-126 |
| PAD (Pad with Leading Spaces) | 2-5 | PREDY | 3-127 |
| Parallel Processing with Lists | F-1 | PRESERVE (Save and Restore Previous Status) | 2-6 |
| Parallelepiped (12, 3) | 5-48 | Pressure at Depth (3, 1) | 5-19 |
| PARAMETRIC | 3-116 | PREVAL | 3-127, 4-58 |
| PARITY | 3-116 | PREVPRIME | 3-127, 4-58 |
| PARSURFACE | 3-117 | PRLCD | 3-128 |
| PARTFRAC | 3-118, 4-56 | Programmatic Use of Statistics and Plotting | 2-34 |
| PATH | 3-118 | Projectile Motion (8, 3) | 5-35 |
| Pausing to Display Output | 1-48 | PROMPT | 3-128 |
| PCAR | 3-118, 4-56 | PROMPT ... CONT for Input, Using | 1-35 |
| PCOEF | 3-118 | PROMPTSTO | 3-128 |
| PCONTOUR | 3-118 | PROOT | 3-128 |
| PCOV | 3-119 | PROPFRAC | 3-129, 4-59 |
| PDIM | 3-119 | PRST | 3-129 |
| PEEK | 6-1 | PRSTC | 3-129 |
| PEEKARM | 6-2 | PRTPAR | D-8 |
| PERM | 3-120 | PRVAR | 3-129 |
| PEVAL | 3-120 | PSDEV | 3-130 |
| PGDIR | 3-120 | PSI | 3-130 |
| PICK | 3-121 | Psi | 3-130 |
| PICK3 | 3-121 | PTAYL | 3-130, 4-59 |
| PICT | 3-121 | PURGE | 3-131 |
| PICTURE | 3-121 | PUSH | 3-131 |
| PINIT | 3-122 | PUT | 3-131 |
| PIX? | 3-122 | PUTI | 3-132 |
| PIXOFF | 3-122 | PVAR | 3-133 |
| PIXON | 3-122 | PVARS | 3-133 |
| PKT | 3-122 | PVIEW | 3-134 |
| Plane Geometry (11) | 5-43 | PWFIT | 3-134 |
| Plate Capacitor (2, 18) | 5-16 | PX→C | 3-134 |
| PLIST | 3-95 | Q | |
| PLOT | 3-123 | qr | 3-135 |

| | | | |
|---------------------------------------|-------------|---------------------------|-------------|
| QR | 3-136 | RISCH | 3-147, 4-62 |
| QUAD | 3-136 | RKF | 3-147 |
| QUOT | 3-136, 4-59 | RKFERR | 3-147 |
| QUOTE | 3-136 | RKFSTEP | 3-148 |
| QXA | 3-137, 4-60 | RL | 3-148 |
| | R | RL Transient (2, 16) | 5-15 |
| R~SB | 6-5 | RLB | 3-148 |
| R→B | 3-156 | RLC Current Delay (2, 11) | 5-14 |
| R→C | 3-156 | RND | 3-149 |
| R→D | 3-157 | RNRM | 3-149 |
| R→I | 3-157 | ROLL | 3-150 |
| RAD | 3-137 | ROLLD | 3-150 |
| RAND | 3-137 | ROMUPLOAD | 3-150 |
| RANK | 3-137 | ROOT | 3-150 |
| RANM | 3-138 | ROT | 3-151 |
| RATIO | 3-138 | ROW- | 3-151 |
| RC Transient (2, 15) | 5-15 | ROW+ | 3-151 |
| RCEQ | 3-139 | ROW→ | 3-151 |
| RCI | 3-139 | RPL Programming | 1-1 |
| RCIJ | 3-139 | RPL Programming Examples | 2-1 |
| RCL | 3-139 | RPL> | 3-152 |
| RCLALARM | 3-140 | RR | 3-152 |
| RCLF | 3-140 | RRB | 3-153 |
| RCLKEYS | 3-141 | rref | 3-153, 4-63 |
| RCLMENU | 3-141 | RREF | 3-153, 4-62 |
| RCLS | 3-141 | RREFMOD | 3-153, 4-63 |
| RCLVX | 3-141, 4-60 | RRK | 3-153 |
| RCWS | 3-142 | RRKSTEP | 3-154 |
| RDM | 3-142 | RSBERR | 3-155 |
| RDZ | 3-142 | RSD | 3-155 |
| RE | 3-143 | RSWP | 3-156 |
| Real Gas Law (5, 6) | 5-27 | RULES | 3-156 |
| Real Gas State Change (5, 7) | 5-27 | | S |
| REALASSUME | D-8 | S~N | 6-4 |
| Recalling and Storing the Flag States | 1-27 | S→H | 6-3 |
| RECN | 3-143 | s1, s2, ... | D-9 |
| RECT | 3-143 | SAME | 3-157 |
| Rectangle (11, 3) | 5-45 | SB~B | 6-5 |
| RECV | 3-144 | SBRK | 3-157 |
| REF | 3-144, 4-60 | SCALE | 3-158 |
| References | 5-59 | SCALEH | 3-158 |
| Regular Polygon (11, 4) | 5-45 | SCALEW | 3-158 |
| REMAINDER | 3-144, 4-61 | SCATRLOT | 3-158 |
| RENAME | 3-144 | SCATTER | 3-159 |
| REORDER | 3-144, 4-61 | SCHUR | 3-159 |
| REPEAT | 3-144 | SCI | 3-160 |
| REPL | 3-144 | SCLS | 3-160 |
| RES | 3-145 | SCONJ | 3-160 |
| Reserved Variables | D-1 | SCROLL | 3-160 |
| Resonant Frequency (2, 17) | 5-16 | SDEV | 3-161 |
| RESTORE | 3-146 | SEND | 3-161 |
| RESULTANT | 3-146, 4-61 | SEQ | 3-161 |
| REVLIST | 3-146 | SERIAL | 6-4 |
| REWRITE | 3-147, 4-62 | SERIES | 3-162, 4-64 |

| | | | |
|--|-------------|--|-------------|
| Series and Parallel C (2, 7) | 5-12 | Spherical Refraction (9, 5) | 5-39 |
| Series and Parallel L (2, 8) | 5-13 | SQ | 3-168 |
| Series and Parallel R (2, 6) | 5-12 | SR | 3-169 |
| SERVER | 3-162 | SRAD | 3-169 |
| Setting, Clearing, and Testing Flags | 1-26 | SRB | 3-169 |
| SETTS (Superimposing Taylor's polynomials) | 2-32 | SRECV | 3-169 |
| SEVAL | 3-162, 4-64 | SREPL | 3-170 |
| SF | 3-162 | SREV | 6-3 |
| Shear Stress (14, 2) | 5-56 | START | 3-170 |
| SHOW | 3-162 | STARTED | D-8 |
| SIDENS | 3-163 | STARTEQW | D-9 |
| SIGMA | 3-163, 4-65 | STARTERR | D-9 |
| SIGMAVX | 3-163, 4-65 | STARTOFF | D-9 |
| SIGN | 3-163 | STARTRECV | D-9 |
| SIGNTAB | 3-164, 4-65 | STARTSEND | D-9 |
| SIMP2 | 3-164, 4-66 | STARTUP | D-9 |
| Simple Deflection (1, 3) | 5-5 | STD | 3-171 |
| Simple Harmonic (10, 5) | 5-42 | STEP | 3-172 |
| Simple Moment (1, 5) | 5-6 | STEQ | 3-172 |
| Simple Pendulum (10, 2) | 5-41 | STIME | 3-172 |
| Simple Shear (1, 6) | 5-6 | STO | 3-172 |
| Simple Slope (1, 4) | 5-5 | STO- | 3-174 |
| SIMPLIFY | 3-164, 4-66 | STO* | 3-175 |
| SIN | 3-164 | STO/ | 3-175 |
| SINCOS | 3-164, 4-67 | STO+ | 3-174 |
| Single-Stepping through a Program | 1-29 | STOALARM | 3-173 |
| SINH | 3-164 | STOF | 3-173 |
| SINTP (Converting a Plot to a Graphics Object) | 2-31 | STOKEYS | 3-174 |
| Sinusoidal Current (2, 23) | 5-18 | Stopping a Program for Keystroke Input | 1-46 |
| Sinusoidal Voltage (2, 22) | 5-18 | STORE | 3-174, 4-68 |
| SINV | 3-165 | STOS | 3-176 |
| SIZE | 3-165 | STOVX | 3-174, 4-68 |
| SL | 3-165 | STR→ | 3-176 |
| SLB | 3-166 | Straight Wire (7, 1) | 5-32 |
| SLINE | 3-93 | STREAM | 3-176 |
| SLIST | 3-95 | Stress Analysis (14) | 5-54 |
| SLOPEFIELD | 3-166 | Stress on an Element (14, 3) | 5-56 |
| SNEG | 3-167 | STURM | 3-177, 4-69 |
| SNRM | 3-167 | STURMAB | 3-177, 4-69 |
| Solenoid Inductance (2, 20) | 5-17 | STWS | 3-177 |
| Solid Geometry (12) | 5-47 | SUB | 3-177 |
| Solid State Devices (13) | 5-49 | Subroutines, Using | 1-28 |
| SOLVE | 3-167, 4-67 | SUBST | 3-178, 4-69 |
| SOLVEQN | 3-167 | SUBTMOD | 3-178, 4-70 |
| SOLVER | 3-168 | Summations Instead of Loops, Using | 1-25 |
| SOLVEVX | 3-168, 4-68 | SVD | 3-178 |
| SORT | 3-168 | SVL | 3-178 |
| Sound Waves (15, 3) | 5-58 | SWAP | 3-179 |
| Source References | E-5 | SX | 3-200 |
| SPHERE | 3-168 | SX2 | 3-200 |
| Sphere (12, 4) | 5-49 | SXY | 3-205 |
| Spherical Reflection (9, 4) | 5-39 | SY | 3-206 |
| | | SY2 | 3-206 |
| | | SYLVESTER | 3-179, 4-70 |

| | | | |
|---|-------------|---|-------------|
| Symbolic Integration Patterns | E-2 | TRIGTAN | 3-186, 4-76 |
| SYSEVAL | 3-179 | TRN | 3-186 |
| SYST2MAT | 3-179, 4-71 | TRNC | 3-186 |
| System Flags | C-1 | TRUNC | 3-187, 4-77 |
| | T | TRUTH | 3-187 |
| Table of Units | B-1 | TSA (Animating Taylor's Polynomials) | 2-33 |
| TABVAL | 3-180, 4-71 | TSIMP | 3-188, 4-77 |
| TABVAR | 3-180, 4-71 | TSTR | 3-188 |
| TAIL | 3-180 | Turning Off the hp49g+/hp48gII from a Program | 1-52 |
| TAN | 3-180 | TVARS | 3-188 |
| TAN2CS2 | 3-181, 4-72 | TVM | 3-188 |
| TAN2SC | 3-181, 4-72 | TVMBEG | 3-189 |
| TAN2SC2 | 3-181, 4-73 | TVMEND | 3-189 |
| TANH | 3-181 | TVMROOT | 3-189 |
| TAYLOR0 | 3-181, 4-73 | TYPE | 3-189 |
| TAYLR | 3-181 | Types of Flags | 1-26 |
| TCHEBYCHEFF | 3-182, 4-73 | | U |
| TCOLLECT | 3-182, 4-74 | UBASE | 3-190 |
| TDELTA | 3-182 | UFACT | 3-190 |
| Technical Reference | E-1 | UFL1→MINIF | 3-191 |
| Techniques used in SINTP | 2-31 | UNASSIGN | 3-191, 4-77 |
| Terminal Velocity (8, 6) | 5-36 | UNASSUME | 3-191, 4-78 |
| Testing Conditions | 1-11 | UNBIND | 3-191, 4-78 |
| TESTS | 3-182, 4-74 | Understanding Programming | 1-1 |
| Tests and Conditional Structures, Using | 1-11 | UNPICK | 3-191 |
| TEVAL | 3-182 | UNROT | 3-191 |
| TEXPAND | 3-183, 4-74 | UNTIL | 3-192 |
| TEXT | 3-183 | UPDIR | 3-192 |
| THEN | 3-183 | UTPC | 3-192 |
| Thermal Expansion (6, 2) | 5-29 | UTPF | 3-192 |
| Thin Lens (9, 6) | 5-39 | UTPN | 3-193 |
| TICKS | 3-183 | UTPT | 3-193 |
| TIME | 3-183 | UVAL | 3-194 |
| TINC | 3-184 | | V |
| TLIN | 3-184, 4-74 | V→ | 3-194 |
| TLINE | 3-184 | VANDERMONDE | 3-195, 4-78 |
| TMENU | 3-184 | VAR | 3-196 |
| TOFF | D-9 | VARS | 3-196 |
| Tools of the development library, The | 6-1 | VER | 3-196, 4-79 |
| Toroid Inductance (2, 21) | 5-17 | Verifying Program Arguments | 2-24 |
| Torsional Pendulum (10, 4) | 5-42 | VERSION | 3-196 |
| TOT | 3-185 | Viewing and Editing Programs | 1-6 |
| TRACE | 3-185 | VISIT | 3-196 |
| Trace Mode | 2-37 | VISITB | 3-197 |
| TRAN | 3-185 | Voltage Divider (2, 3) | 5-11 |
| TRANSIO | 3-185 | VPAR | D-9 |
| Transverse Waves (15, 1) | 5-58 | VPOTENTIAL | 3-197, 4-79 |
| Trapping Errors | 1-32 | VTYPE | 3-197 |
| Triangle (11, 6) | 5-46 | | W |
| TRIG | 3-186, 4-75 | WAIT | 3-197 |
| TRIGCOS | 3-186, 4-75 | WAIT for Keystroke Input, Using | 1-46 |
| TRIGO | 3-186, 4-76 | Waves (15) | 5-57 |
| Trigonometric Expansions | E-4 | WHILE | 3-198 |
| TRIGSIN | 3-186, 4-76 | | |

| | | | | |
|------------------------|----------|-------------|----------------------|-------------|
| Wire Resistance (2, 5) | | 5-11 | | |
| WIREFRAME | | 3-198 | | |
| WSLOG | | 3-199 | | |
| | X | | | |
| XCOL | | 3-201 | YCOL | 3-206 |
| XGET | | 3-201 | YRNG | 3-206 |
| XLIB~ | | 6-4 | YSLICE | 3-207 |
| XMIT | | 3-201 | YVOL | 3-207 |
| XNUM | | 3-202, 4-79 | YRNG | 3-208 |
| XOR | | 3-202 | | |
| XPON | | 3-202 | Z | |
| XPUT | | 3-203 | ZEROS | 3-208, 4-80 |
| XQ | | 3-203, 4-80 | ZFACTOR | 3-208 |
| XRECV | | 3-203 | ZPAR | D-10 |
| XRNG | | 3-203 | ZVOL | 3-208 |
| XROOT | | 3-204 | | |
| XSEND | | 3-204 | Greek Letters | |
| XSERV | | 3-205 | αENTER | D-2 |
| XVOL | | 3-205 | βENTER | D-3 |
| XXRNG | | 3-205 | Σ – (Sigma Minus) | 3-213 |
| | | | Σ (Summation) | 3-212 |
| | | | Σ+ (Sigma Plus) | 3-212 |
| | | | ΣDAT | D-10 |
| | | | ΣPAR | D-11 |