



HP Officejet 4630 e-All-in-One series

Table of contents

| | |
|---|-----------|
| 1 HP Officejet 4630 e-All-in-One series Help | 1 |
| 2 Get to know the HP Officejet 4630 series | 3 |
| Printer parts | 4 |
| Control panel and status lights | 6 |
| Wireless settings | 8 |
| 3 Print | 9 |
| Print documents | 10 |
| Print photos | 12 |
| Print envelopes | 14 |
| Print Quick Forms | 16 |
| Print with HP wireless direct | 17 |
| Print using the maximum dpi | 19 |
| Tips for print success | 21 |
| 4 Paper basics | 25 |
| Recommended papers for printing | 26 |
| Load media | 28 |
| Load original | 32 |
| Order HP paper supplies | 34 |
| 5 Copy and scan | 35 |
| Copy documents | 36 |
| Scan to a computer | 39 |
| Tips for copy success | 41 |
| Tips for scan success | 42 |
| 6 Fax | 43 |
| Send a fax | 44 |
| Receive a fax | 49 |

| | |
|--|-----------|
| Set up speed-dial entries | 53 |
| Change fax settings | 55 |
| Fax and digital phone services | 59 |
| Fax on Voice over Internet Protocol | 60 |
| Use reports | 61 |
| Tips for fax success | 64 |
| 7 Use Web Services | 65 |
| HP ePrint | 66 |
| Use HP Printables | 68 |
| Use the HP Connected website | 69 |
| Tips for using Web Services | 70 |
| 8 Work with cartridges | 71 |
| Check the estimated ink levels | 72 |
| Order ink supplies | 73 |
| Choose right ink cartridges | 74 |
| Replace the cartridges | 75 |
| Use single-cartridge mode | 77 |
| Cartridge warranty information | 78 |
| Tips for working with cartridges | 79 |
| 9 Connectivity | 81 |
| Wi-Fi Protected Setup (WPS – requires WPS router) | 82 |
| Traditional wireless connection (requires router) | 83 |
| USB connection (non-network connection) | 85 |
| Change from a USB connection to a wireless network | 86 |
| Connect wirelessly to the printer without a router | 87 |
| Tips for setting up and using a networked printer | 88 |
| Advanced printer management tools (for networked printers) | 89 |
| 10 Solve a problem | 91 |
| Clear a paper jam | 92 |
| Improve print quality | 98 |
| Unable to print | 103 |
| Resolve copy and scan issues | 108 |
| Resolve fax issues | 109 |
| Resolve networking issues | 110 |
| HP support | 111 |

| | |
|---|------------|
| Appendix A Technical information | 119 |
| Hewlett-Packard Company notices | 120 |
| Specifications | 121 |
| Environmental product stewardship program | 125 |
| Regulatory notices | 129 |
| | |
| Appendix B Additional fax setup | 139 |
| Set up faxing (parallel phone systems) | 140 |
| Serial-type fax setup | 162 |
| Test fax setup | 163 |
| | |
| Index | 165 |

1 HP Officejet 4630 e-All-in-One series Help

Learn how to use your HP Officejet 4630 series

- [Printer parts on page 4](#)
- [Control panel and status lights on page 6](#)
- [Load media on page 28](#)
- [Print on page 9](#)
- [Copy documents on page 36](#)
- [Scan to a computer on page 39](#)
- [Replace the cartridges on page 75](#)
- [Clear a paper jam on page 92](#)
- [Check the estimated ink levels on page 72](#)

2 Get to know the HP Officejet 4630 series

- [Printer parts](#)
- [Control panel and status lights](#)
- [Wireless settings](#)

Printer parts

- Front and top views of the HP Officejet 4630 series



| | |
|----|---|
| 1 | Lid |
| 2 | Lid-backing |
| 3 | Scanner glass |
| 4 | Automatic Document Feeder (ADF) |
| 5 | Cartridge access door |
| 6 | Cleanout |
| 7 | Printer display |
| 8 | Control panel |
| 9 | Paper tray |
| 10 | Paper tray extender (also referred to as the tray extender) |
| 11 | Cartridge access area |
| 12 | Paper-width guides |

- Rear view of the HP Officejet 4630 series

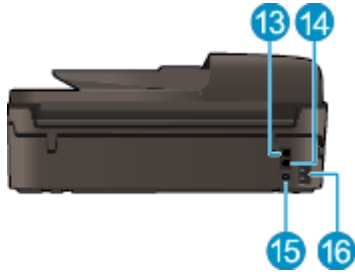

| | |
|-----------|-------------------|
| 13 | Fax port (2-EXT) |
| 14 | Fax port (1-LINE) |
| 15 | USB port |
| 16 | Power connection |

Control panel and status lights

Figure 2-1 Control panel features

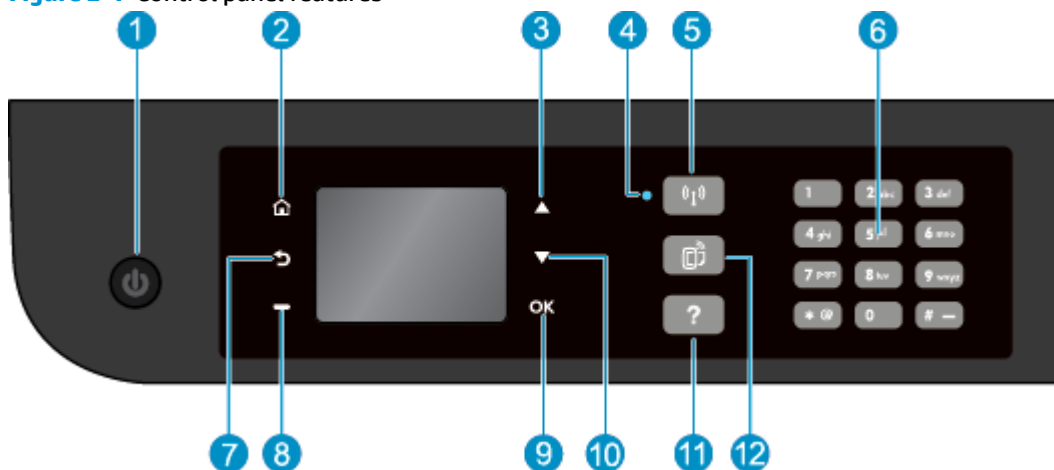

| Feature | Description |
|---------|---|
| 1 | On button: Turns the printer on or off. |
| 2 | Home : Returns to the Home screen, the screen that is displayed when you first turn on the printer. |
| 3 | Up button: Use this button to navigate menus and select number of copies. |
| 4 | Wireless status light: Blue light indicates wireless connection. |
| 5 | Wireless button: Press the button to view wireless status and menu options. Press and hold down the button until light blinks to start Wi-Fi Protected Setup (WPS) push button mode. |
| 6 | Keypad : Use the keypad to enter numbers and text. |
| 7 | Back : Returns to the previous screen. |
| 8 | Selection button : The function of this button changes depending on what is displayed on the printer display. |
| 9 | OK : Confirms the current selection. |
| 10 | Down button: Use this button to navigate menus and select number of copies. |
| 11 | Help : On the Home screen, shows all Help topics. On another screen, shows information or animation on the display to assist in the current operation. |
| 12 | ePrint button: Press the button to display the Web Services Settings menu where you can view the printer's email address and make ePrint settings. |

Figure 2-2 On button light



| Light behavior | Solution |
|----------------|--|
| Off | The printer is powered off. |
| Dimmed | Indicates the printer is in Sleep mode. The printer automatically enters Sleep mode after 5 minutes of inactivity. |

| Light behavior | Solution |
|----------------|--|
| Fast blinking | Error has occurred. Refer to the messages on the printer display. |
| Pulsing | Indicates that the printer is initializing or is being shut down. |
| On | The printer is printing, scanning, copying, or is on and ready to print. |

Figure 2-3 Wireless status light



| Light behavior | Solution |
|----------------|--|
| Off | Wireless is off. Press the Wireless button to access the wireless menu on the printer display. Use the wireless menu to enable wireless printing. |
| Slow blinking | Wireless is connecting or is on but not connected to a network. If the connection cannot be established, make sure the printer is within the range of wireless signal. |
| Fast blinking | A wireless error has occurred. Refer to the messages on the printer display. |
| On | Wireless connection has been established and you can print. |

Wireless settings

Press the **Wireless** button to view wireless status and menu options.

- If the printer has an active connection to a wireless network, the wireless light is on solid blue and the printer display shows **Connected** and the printer IP address.
- If wireless is turned off, the wireless light is off and the display screen shows **Wireless Off**.
- If wireless is enabled (wireless radio on) and a wireless connection has not been established, the wireless light is blinking and the display screen shows **Connecting** or **Not Connected**.

You can use the printer display to retrieve information about your wireless network, establish a wireless connection, and more.

| How do I? | Instructions |
|--|--|
| Print a network configuration page. The network configuration page displays the network status, hostname, network name, and more. | <ol style="list-style-type: none">1. Press the Wireless button to access the Wireless Status menu.2. Press the button next to Settings to access the Wireless Settings menu.3. Select Print Report, and then select Configuration Page. |
| Print a wireless network test report. The wireless network test report displays the diagnostics results for the status of the wireless network, wireless signal strength, detected networks, and more. | <ol style="list-style-type: none">1. Press the Wireless button to access the Wireless Status menu.2. Press the button next to Settings to access the Wireless Settings menu.3. Select Print Report, and then select Test Report. |
| Restore network settings to default settings. | <ol style="list-style-type: none">1. Press the Wireless button to access the Wireless Status menu.2. Press the button next to Settings to access the Wireless Settings menu.3. Select Restore Defaults.4. Confirm the selection to restore defaults. |
| Turn wireless on or off. | <ol style="list-style-type: none">1. Press the Wireless button to access the Wireless Settings menu.2. Select Wireless.3. From the Wireless On/Off menu select On or Off. |
| Establish a Wi-Fi Protected Setup (WPS) connection. | For more information, see Wi-Fi Protected Setup (WPS – requires WPS router) on page 82 . |
| Connect the printer to a wireless network. | For more information, see Traditional wireless connection (requires router) on page 83 . |

3 Print

- [Print documents](#)
- [Print photos](#)
- [Print envelopes](#)
- [Print Quick Forms](#)
- [Print with HP wireless direct](#)
- [Print using the maximum dpi](#)
- [Tips for print success](#)

Print documents

To load paper

1. Make sure the paper tray is open.
2. Slide the paper-width guides all the way open.
3. Place the paper in the paper tray. The side to be printed on should face down.
4. Push the stack of paper into the printer until it stops.
5. Slide the paper-width guides firmly against the edge of the paper.



To print a document

1. On the **File** menu in your software, click **Print**.
2. Make sure your printer is selected.
3. Click the button that opens the **Properties** dialog box.

Depending on your software application, this button might be called **Properties**, **Options**, **Printer Setup**, **Printer Properties**, **Printer**, or **Preferences**.

4. Select the appropriate options.
 - On the **Paper/Quality** tab, select the appropriate paper type from the **Media** drop-down list in the **Tray Selection** area, and then select the appropriate print quality in the **Quality Settings** area.
 - Click the **Advanced** button, in the **Paper/Output** area, select the appropriate paper size from the **Paper Size** drop-down list.

For more printing options, see [Tips for print success on page 21](#).

5. Click **OK** to close the **Properties** dialog box.
6. Click **Print** or **OK** to begin printing.

To print from software

1. From the **File** menu in your software, choose **Print**.
2. Make sure the HP Officejet 4630 series is the selected printer.
3. Specify the page properties.

Do the following if you do not see options on the Print dialog.

- **OS X v10.6:** Click the blue disclosure triangle next to the Printer selection to access the print options.
- **OS X Lion and Mountain Lion:** Click **Show Details** to access the print options.



NOTE: The following options are available for your printer. Locations for the options can vary from one application to another.

- Choose the paper size.
- Select the orientation.
- Enter the scaling percentage.

4. Click **Print**.

To print on both sides of the page

1. On the **File** menu in your software, click **Print**.
2. Make sure your printer is selected.
3. Click the button that opens the **Properties** dialog box.

Depending on your software application, this button might be called **Properties, Options, Printer Setup, Printer Properties, Printer, or Preferences**.

4. Select the appropriate options.
 - On the **Paper/Quality** tab, select the appropriate paper type from the **Media** drop-down list in the **Tray Selection** area, and then select the appropriate print quality in the **Quality Settings** area.
 - Click the **Advanced** button, in the **Paper/Output** area, select the appropriate paper size from the **Paper Size** drop-down list.

For more printing options, see [Tips for print success on page 21](#).

5. On the **Layout** tab, select **Flip on Long Edge** or **Flip on Short Edge** from the **Print on Both Sides** drop-down list.
6. Click **OK** to print.



NOTE: After one page of the document is printed, you are prompted to wait for a few seconds. Then the printer automatically reloads the paper back to print on the other side. You do not need to manually reload the paper.

To print on both sides of the page

1. From the **File** menu in your software, choose **Print**.
2. In the Print dialog, choose **Layout** from the pop-up menu.
3. Choose the type of binding you want for your two-sided pages, and then click **Print**.

Print photos

To load photo paper

1. Make sure the paper tray is open.
2. Slide the paper-width guides all the way open.
3. Remove all paper from the paper tray, and then load the photo paper with side to be printed on facing down.
4. Push the stack of photo papers into the printer until it stops.
5. Slide the paper-width guides firmly against the edge of the photo papers.



To print a photo on photo paper

1. On the **File** menu in your software, click **Print**.
2. Make sure your printer is selected.
3. Click the button that opens the **Properties** dialog box.
Depending on your software application, this button might be called **Properties**, **Options**, **Printer Setup**, **Printer Properties**, **Printer**, or **Preferences**.
4. Select the appropriate options.
 - On the **Paper/Quality** tab, select the appropriate paper type from the **Media** drop-down list in the **Tray Selection** area, and then select the appropriate print quality in the **Quality Settings** area.
 - Click **Advanced** to select the appropriate paper size from the **Paper Size** drop-down list.

For more printing options, see [Tips for print success on page 21](#).

 **NOTE:** For maximum dpi resolution, go to **Paper/Quality** tab, select **Photo Paper** from the **Media** drop-down list, and then select **Best** in the **Quality Settings** area. Then click the **Advanced** button and select **Yes** from the **Print in Max DPI** drop-down list. If you want to print max DPI in grayscale, select **High Quality Grayscale** from the **Print in Grayscale** drop-down list.

5. Click **OK** to return to the **Properties** dialog box.
6. Click **OK**, and then click **Print** or **OK** in the **Print** dialog box.

 **NOTE:** After the printing is finished, remove unused photo paper from the paper tray. Store the photo paper so it does not start to curl, which could reduce the quality of your printout.

To print a photo from the computer

1. From the **File** menu in your software, choose **Print**.
2. Make sure the HP Officejet 4630 series is the selected printer.
3. Set the print options.

Do the following if you do not see options on the Print dialog.

- **OS X v10.6:** Click the blue disclosure triangle next to the Printer selection to access the print options.
- **OS X Lion and Mountain Lion:** Click **Show Details** to access the print options.



NOTE: The following options are available for your printer. Locations for the options can vary from one application to another.

- a. Choose the appropriate paper size in the **Paper Size** pop-up menu.
 - b. Select an **Orientation**.
 - c. From the pop-up menu, choose **Paper Type/Quality**, and then choose the following settings:
 - **Paper Type:** The appropriate photo paper type
 - **Quality: Best or Maximum dpi**
 - Click the **Color Options** disclosure triangle, and then choose the appropriate **Photo Fix** option.
 - **Off:** applies no changes to the image.
 - **Basic:** automatically focuses the image; moderately adjusts image sharpness.
4. Select any other print settings you want, and then click **Print**.

Print envelopes

You can load one or more envelopes into the paper tray of the HP Officejet 4630 series. Do not use shiny or embossed envelopes, or envelopes that have clasps or windows.

 **NOTE:** For details on how to format on envelopes, see the help files in your word application.

To load envelopes

1. Make sure the paper tray is open.
2. Slide the paper-width guides all the way open.
3. Place the envelopes in the center of the paper tray. The side to be printed on should face down. The flap should be on the left side.
4. Push the stack of envelopes into the printer until it stops.
5. Slide the paper-width guides firmly against the edge of the envelopes.



To print an envelope

1. On the **File** menu in your software, click **Print**.
2. Make sure your printer is selected.
3. Click the button that opens the **Properties** dialog box.
Depending on your software application, this button might be called **Properties**, **Options**, **Printer Setup**, **Printer Properties**, **Printer**, or **Preferences**.
4. Select the appropriate options.
 - On the **Paper/Quality** tab, select the appropriate paper type from the **Media** drop-down list in the **Tray Selection** area, and then select the appropriate print quality in the **Quality Settings** area.
 - Click **Advanced** to select the appropriate paper size from the **Paper Size** drop-down list.

For more printing options, see [Tips for print success on page 21](#).

5. Click **OK**, and then click **Print** or **OK** in the **Print** dialog box.

To print envelopes

1. From the **File** menu in your software, choose **Print**.
2. Make sure the HP Officejet 4630 series is the selected printer.

3. Set the print options.

Do the following if you do not see options on the Print dialog.

- **OS X v10.6:** Click the blue disclosure triangle next to the Printer selection to access the print options.
- **OS X Lion and Mountain Lion:** Click **Show Details** to access the print options.



NOTE: The following options are available for your printer. Locations for the options can vary from one application to another.

- a. Select the appropriate envelope size from the **Paper Size** pop-up menu.
 - b. From the pop-up menu, choose **Paper Type/Quality**, and verify the paper type setting is set to **Plain Paper**.
- 4.** Click **Print**.

Print Quick Forms

Use **Quick Forms** to print calendars, check lists, games, notebook paper, graph paper, music paper, and games.

To print Quick Forms

1. From the Home screen on the printer display, press the **Up** and **Down** buttons to select **Quick Forms**, and then press **OK**.
-  **TIP:** If the **Quick Forms** option does not appear on the printer display, press the **Home** button, and then press the **Up** and **Down** buttons until you see **Quick Forms**.
2. Press the **Up** and **Down** buttons to select one of the Quick Forms options, and then press **OK**.
3. After you have selected the type of form that you want to print, select the number of copies, and then press **OK**.

Print with HP wireless direct

With HP wireless direct, you can print wirelessly from a computer, smart phone, tablet, or other wireless-capable device—without connecting to an existing wireless network.

When using HP wireless direct, note the following guidelines:

- Make sure your computer or mobile device has the necessary software.
If you are using a computer, make sure you have installed the printer software provided with the printer.
- If you are using a mobile device, make sure you have installed a compatible printing app. For more information about mobile printing, visit www.hp.com/global/us/en/eprint/mobile_printing_apps.html.
- Make sure HP wireless direct is turned on in the printer and, if necessary, security is enabled. For more information, see [Connect wirelessly to the printer without a router on page 87](#).
- Up to five computers and mobile devices can use the same HP wireless direct connection.
- HP wireless direct can be used while the printer is also connected to a computer using USB cable or to a network using a wireless connection.
- HP wireless direct cannot be used to connect a computer, mobile device, or printer to the Internet.

 [Click here to go online for more information.](#)

 **NOTE:** At this time, these websites might not be available in all languages.

This section contains the following topics:

- [Print from a wireless-capable mobile device](#)
- [Print from a wireless-capable computer](#)

Print from a wireless-capable mobile device

Make sure you have installed a compatible printing app on your mobile device. For more information, visit www.hp.com/global/us/en/eprint/mobile_printing_apps.html.

1. Make sure you have turned on HP wireless direct on the printer. For more information, see [Connect wirelessly to the printer without a router on page 87](#).
2. Turn on the Wi-Fi connection on your mobile device. For more information, see the documentation provided with the mobile device.

 **NOTE:** If your mobile device does not support Wi-Fi, you are not able to use HP wireless direct.

3. From the mobile device, connect to a new network. Use the process you normally use to connect to a new wireless network or hotspot. Choose the HP wireless direct name from the list of wireless networks shown such as HP-Print-**-Officejet 4630 series (where ** are the unique characters to identify your printer).

If HP wireless direct is turned on with security, enter the password when prompted.

4. Print your document.

Print from a wireless-capable computer

1. Make sure you have turned on HP wireless direct on the printer. For more information, see [Connect wirelessly to the printer without a router on page 87](#) for more information.
2. Turn on the computer's Wi-Fi connection. For more information, see the documentation provided with the computer.



NOTE: If your computer does not support Wi-Fi, you are not able to use HP wireless direct.

3. From the computer, connect to a new network. Use the process you normally use to connect to a new wireless network or hotspot. Choose the HP wireless direct name from the list of wireless networks shown such as HP-Print-**-Officejet 4630 series (where ** are the unique characters to identify your printer).

If HP wireless direct is turned on with security, enter the password when prompted.

4. Proceed to step 5 if the printer has been installed and connected to the computer over a wireless network. If the printer has been installed and connected to your computer with a USB cable, follow the steps below to install the printer software using the HP wireless direct connection.
 - a. Depending on your operating system, do one of the following:
 - **Windows 8:** On the **Start** screen, right-click an empty area on the screen, click **All Apps** on the app bar, and then click **Printer Setup & Software**.
 - **Windows 7, Windows Vista, and Windows XP:** From the computer desktop, click **Start**, select **All Programs**, click **HP**, click **HP OFFICEJET 4630 series**, and then click **Printer Setup & Software**.
 - b. Select **Connect New Printer**.
 - c. When the **Connection Options** software screen appears, select **Wireless**.
Select **HP OFFICEJET 4630 series** from the list of detected printers.
 - d. Follow the on-screen instructions.

5. Print your document.

1. Make sure you have turned on HP wireless direct printing on the printer.
2. Turn on AirPort.

For more information, see the documentation provided by Apple.

3. Click the AirPort icon and choose the HP wireless direct name, such as HP-Print-**-Officejet 4630 series (where ** are the unique characters to identify your printer).

If HP wireless direct is turned on with security, enter the password when prompted.

4. Add the printer.
 - a. In **System Preferences**, select **Print & Fax** or **Print & Scan**, depending on your operating system.
 - b. Click + below the list of printers at the left.
 - c. Select the printer from the list of detected printers (the word “Bonjour” is listed the right column beside the printer name), and click **Add**.

Print using the maximum dpi

Use maximum dots per inch (dpi) mode to print high-quality, sharp images on photo paper.

Printing in maximum dpi takes longer than printing with other settings and requires a large amount of memory.

To print in maximum dpi mode

1. From your software, select **Print**.
2. Make sure your printer is selected.
3. Click the button that opens the **Properties** dialog box.
Depending on your software application, this button might be called **Properties**, **Options**, **Printer Setup**, **Printer Properties**, **Printer**, or **Preferences**.
4. Click the **Paper/Quality** tab.
5. From the **Media** drop-down list, select a media type from the available list.
 - Plain Paper
 - HP Photo Paper or other photo paper
 - HP Matte Brochure or Professional Paper
 - HP Glossy Brochure or Professional Paper
 - HP Iron-on Transfers or other specialty Paper
 - HP Matte Presentation or other matte paper
 - Other glossy specialty paper
6. Click the **Advanced** button.
7. In the **Printer Features** area, select **Yes** from the **Print in Max DPI** drop-down list.
8. Select the appropriate paper size from the **Paper Size** drop-down list.
9. Click **OK** to close the advanced options.
10. Confirm **Orientation** on the **Layout** tab, and then click **OK** to print.

To print using maximum dpi

1. From the **File** menu in your software, choose **Print**.
2. Make sure the HP Officejet 4630 series is the selected printer.
3. Set the print options.

Do the following if you do not see options on the Print dialog.

- **OS X v10.6:** Click the blue disclosure triangle next to the Printer selection to access the print options.
- **OS X Lion and Mountain Lion:** Click **Show Details** to access the print options.



NOTE: The following options are available for your printer. Locations for the options can vary from one application to another.

- a. Choose the appropriate paper size in the **Paper Size** pop-up menu.
 - b. From the pop-up menu, choose **Paper Type/Quality**, and then choose the following settings:
 - **Paper Type:** The appropriate photo paper type
 - **Quality: Best** or **Maximum dpi**
4. Select any other print settings that you want, and then click **Print**.

Tips for print success

To print successfully, the HP cartridges should be functioning properly with sufficient ink, the paper should be loaded correctly, and the printer should have the appropriate settings. Print settings do not apply to copying or scanning.

Ink tips

- Use Original HP ink cartridges.
- Install both the black and tri-color cartridges correctly.
For more information, see [Replace the cartridges on page 75](#).
- Check the estimated ink levels in the cartridges to make sure there is sufficient ink.
For more information, see [Check the estimated ink levels on page 72](#).
- If the print quality is not acceptable, see [Improve print quality on page 98](#) for more information.
- Always turn off the printer with the **On** button to allow the printer to protect the nozzles.

Paper loading tips

- Load a stack of paper (not just one page). All of the paper in the stack should be the same size and type to avoid a paper jam.
- Load paper with side to be printed on facing down.
- Ensure that paper loaded in the paper tray lays flat and the edges are not bent or torn.
- Adjust the paper-width guides in the paper tray to fit snugly against all paper. Make sure the paper-width guides do not bend the paper in the paper tray.
For more information, see [Load media on page 28](#).

Printer settings tips

- To change default print settings, click **Print, Scan & Fax**, and then click **Set Preferences** in the printer software.
Depending on your operating system, do one of the following to open the printer software:
 - **Windows 8:** On the **Start** screen, right-click an empty area on the screen, click **All Apps** on the app bar, and then click the icon with the printer's name.
 - **Windows 7, Windows Vista, and Windows XP:** From the computer desktop, click **Start**, select **All Programs**, click **HP**, click **HP Officejet 4630 series**, and then click **HP Officejet 4630 series**.
- To select the number of pages to print per sheet, on the **Layout** tab, select the appropriate option from the **Pages per Sheet** drop-down list.
- If you want to change the page orientation, set it in your application interface.
- To view more printing settings, on the **Layout** or **Paper/Quality** tab, click the **Advanced** button to open the **Advanced Options** dialog box.

- **Print in Grayscale:** Allows you to print a black and white document using the black ink only. Select **Black Ink Only**, and then click the **OK** button.
- **Borderless Printing:** Select this feature to print photos without border. Not all media types support this feature. You will see an alert icon beside the option if the selected media type in the **Media** drop-down list does not support it.
- **Preserve Layout:** This feature only works with the duplex printing. If the image is larger than the printable area, select this feature to scale the page content to be within the smaller margins so that extra pages are not created.
- **HP Real Life Technologies:** This feature smooths and sharpens images and graphics for improved print quality.
- **Booklet:** Allows you to print multiple-page document as a booklet. It places two pages on each side of a sheet that can then be folded into a booklet in half size of the paper. Select a binding method from the drop-down list, and then click **OK**.
 - **Booklet-LeftBinding:** The binding side after folded into a booklet appears at the left side. Select the option if your reading habit is from left to right.
 - **Booklet-RightBinding:** The binding side after folded into a booklet appears at the right side. Select the option if your reading habit is from right to left.



NOTE: The preview on the **Layout** tab cannot reflect what you select from the **Booklet** drop-down list.

- **Pages per Sheet Layout:** Helps you specify the order of the pages if you print document in more than two pages per sheet.



NOTE: The preview on the **Layout** tab cannot reflect what you select from the **Pages per Sheet Layout** drop-down list.

- You can use printing shortcut to save setting time. A printing shortcut stores the setting values that are appropriate for a particular kind of job, so that you can set all the options with a single click. To use it, go to the **Printing Shortcut** tab, select one printing shortcut, and then click **OK**.

To add a new printing shortcut, after making settings on the **Layout** or **Paper/Quality** tab, click the **Printing Shortcut** tab, click **Save As** and enter a name, and then click **OK**.

To delete a printing shortcut, select it, and then click **Delete**.



NOTE: You cannot delete the default printing shortcuts.

Printer settings tips

- On the Print dialog, use the **Paper Size** pop-up menu to select the size of paper loaded in the printer.
- On the Print dialog, choose the **Paper Type/Quality** pop-up menu and select the appropriate paper type and quality.
- To print a black and white document using only black ink, choose the **Paper Type/Quality** from the pop-up menu and choose **Grayscale** from the Color pop-up menu.

Notes

- Original HP ink cartridges are designed and tested with HP printers and papers to help you easily produce great results, time after time.



NOTE: HP cannot guarantee the quality or reliability of non-HP supplies. Product service or repairs required as a result of using a non-HP supply will not be covered under warranty.

If you believe you purchased Original HP ink cartridges, go to www.hp.com/go/anticounterfeit.

- Ink level warnings and indicators provide estimates for planning purposes only.



NOTE: When you receive a low-ink warning message, consider having a replacement cartridge available to avoid possible printing delays. You do not need to replace the cartridges until print quality becomes unacceptable.

- Software settings selected in the print driver only apply to printing, they do not apply to copying or scanning.
- You can print your document on both sides of the paper.

4 Paper basics

- [Recommended papers for printing](#)
- [Load media](#)
- [Load original](#)
- [Order HP paper supplies](#)

Recommended papers for printing

If you want the best print quality, HP recommends using HP papers that are specifically designed for the type of project you are printing.

Depending on your country/region, some of these papers might not be available.

ColorLok

- HP recommends plain papers with the ColorLok logo for printing and copying of everyday documents. All papers with the ColorLok logo are independently tested to meet high standards of reliability and print quality, and produce documents with crisp, vivid color, bolder blacks, and dry faster than ordinary plain papers. Look for papers with the ColorLok logo in a variety of weights and sizes from major paper manufacturers.



Photo printing

- **HP Premium Plus Photo Paper**

HP Premium Plus Photo Paper is HP's highest-quality photo paper for your best photos. With HP Premium Plus Photo Paper, you can print beautiful photos that are instant-dry so you can share them right off the printer. It is available in several sizes, including A4, 8.5 x 11 inches, 4 x 6 inches (10 x 15 cm), 5 x 7 inches (13 x 18 cm), and 11 x 17 inches (A3), and in two finishes - glossy or soft gloss (semi-gloss). Ideal for framing, displaying, or gifting your best photos and special photo projects. HP Premium Plus Photo Paper delivers exceptional results with professional quality and durability.

- **HP Advanced Photo Paper**

This thick photo paper features an instant-dry finish for easy handling without smudging. It resists water, smears, fingerprints, and humidity. Your prints have a look and feel comparable to a store-processed photo. It is available in several sizes, including A4, 8.5 x 11 inches, 10 x 15 cm (4 x 6 inches), 13 x 18 cm (5 x 7 inches). It is acid-free for longer lasting documents.

- **HP Everyday Photo Paper**

Print colorful, everyday snapshots at a low cost, using paper designed for casual photo printing. This affordable photo paper dries quickly for easy handling. Get sharp, crisp images when you use this paper with any inkjet printer. It is available in glossy finish in several sizes, including A4, 8.5 x 11 inches, and 10 x 15 cm (4 x 6 inches). For longer-lasting photos, it is acid-free.

Business documents

- **HP Premium Presentation Paper 120g Matte or HP Professional Paper 120 Matt**

These papers are heavy two-sided matte papers perfect for presentation, proposals, reports, and newsletters. They are heavyweight for an impressive look and feel.

- **HP Brochure Paper 180g Glossy or HP Professional Paper 180 Glossy**

These papers are glossy-coated on both sides for two-sided use. They are the perfect choice for near-photographic reproductions and business graphics for report covers, special presentations, brochures, mailers, and calendars.

- **HP Brochure Paper 180g Matte or HP Professional Paper 180 Matt**

These papers are matte-coated on both sides for two-sided use. They are the perfect choice for near-photographic reproductions and business graphics for report covers, special presentations, brochures, mailers, and calendars.

Everyday printing

- **HP Bright White Inkjet Paper**

HP Bright White Inkjet Paper delivers high-contrast colors and sharp text. It is opaque enough for two-sided color usage with no show-through, which makes it ideal for newsletters, reports, and flyers. It features ColorLok Technology for less smearing, bolder blacks, and vivid colors.

- **HP Printing Paper**

HP Printing Paper is a high-quality multifunction paper. It produces documents that look and feel more substantial than documents printed on standard multipurpose or copy paper. It features ColorLok Technology for less smearing, bolder blacks, and vivid colors. It is acid-free for longer lasting documents.

- **HP Office Paper**

HP Office Paper is a high-quality multifunction paper. It is suitable for copies, drafts, memos, and other everyday documents. It features ColorLok Technology for less smearing, bolder blacks, and vivid colors. It is acid-free for longer lasting documents.

- **HP Office Recycled Paper**

HP Office Recycled Paper is a high-quality multifunction paper made with 30% recycled fiber. It features ColorLok Technology for less smearing, bolder blacks and vivid colors.

Special projects

- **HP Iron-On Transfers**

HP Iron-on Transfers (for light or white fabrics) are the ideal solution for creating custom T-shirts from your digital photos.

Load media

Select a paper size to continue.

To load full-size paper

1. Lower the paper tray, and then pull out the paper tray and tray extender.



2. Slide the paper-width guides outward.



3. Load the paper.

- Insert a stack of paper into the paper tray with the short edge forward and the print side down.



- Slide the stack of paper forward until it stops.

- Adjust the paper-width guides so they fit against both sides of the stack of paper.



- Slide the paper tray in.



To load small-size paper

1. Lower the paper tray, and then pull out the paper tray and tray extender.



2. Slide the paper-width guides outward.



3. Load the photo paper.

- Insert a stack of photo paper into the paper tray with the short edge forward and the print side down.



- Slide the stack of photo paper forward until it stops.
- Adjust the paper-width guides so they fit against both sides of the stack of photo paper.
- Slide the paper tray in.



To load envelopes

1. Lower the paper tray, and then pull out the paper tray and tray extender.



2. Slide the paper-width guides outward.



3. Load the envelopes.

- Insert one or more envelopes in the center of the paper tray. The side to be printed on should face down. The flap should be on the left side and facing up.



- Slide the stack of envelopes forward until it stops.
- Adjust the paper-width guides so they fit against both sides of the stack of envelopes.
- Slide the paper tray in.



Load original

You can load your original print-side up in the automatic document feeder or print-side down on the right front corner of the scanner glass.

To load original in the automatic document feeder

1. Slide paper-width guides outwards.



2. Load original print-side up, head first, in the ADF.



3. Slide paper-width guides inward until they stop at the edge of paper.



To load original on the scanner glass

1. Lift the scanner lid.



2. Load original print-side down on the right corner of the scanner glass.

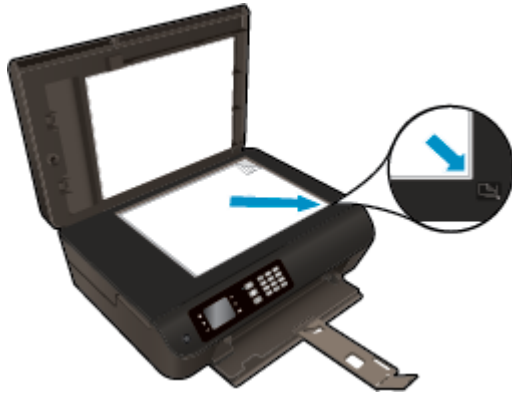

3. Close the scanner lid.



Order HP paper supplies

The printer is designed to work well with most types of office media. Use HP media for optimum print quality. Visit the HP website at www.hp.com for more information about HP media.

HP recommends plain papers with the ColorLok logo for printing and copying of everyday documents. All papers with the ColorLok logo are independently tested to meet high standards of reliability and print quality, and produce documents with crisp, vivid color, bolder blacks and dry faster than ordinary plain papers. Look for papers with the ColorLok logo in a variety of weights and sizes from major paper manufacturers.

To purchase HP papers, go to [Shop for Products and Services](#) and select ink, toner and paper.

5 Copy and scan

- [Copy documents](#)
- [Scan to a computer](#)
- [Tips for copy success](#)
- [Tips for scan success](#)

Copy documents

The **Copy** menu on the printer display allows you to easily select number of copies and color or black and white for copying on plain paper. You can also easily access advanced settings, such as changing the paper type and size, adjusting the darkness of the copy, and resizing the copy.

Make a 1-sided copy

1. Load full-size paper in the paper tray.



2. Load the original print-side up in the ADF or print-side down on the scanner glass.

For more information about loading the original, see [Load original on page 32](#).

3. Select **Copy** from the Home screen on the printer display to access the copy menu.

If you do not see **Copy** on the printer display, press the **Home** button, and then press the **Up** and **Down** buttons until you see **Copy**.

4. From the **Copy** menu, select **Copies** to increase or decrease the number of copies, and then press **OK** to confirm.
5. Select **Start Black Copy** or **Start Color Copy**, and then press **OK** to make a black or color copy.

Make a 2-sided copy from the scanner glass

1. Load full-size paper in the paper tray.



2. Load the original print side down on the right front corner of the scanner glass.

For more information about loading the original, see [Load original on page 32](#).

3. Select **Copy** from the Home screen on the printer display to access the copy menu.

If you do not see **Copy** on the printer display, press the **Home** button, and then press the **Up** and **Down** buttons until you see **Copy**.

4. From the **Copy** menu, select **Copies** to increase or decrease the number of copies, and then press **OK** to confirm.

5. Select **2-Sided** to enable it, and then press **OK** to confirm.
6. Select **Start Black Copy** or **Start Color Copy**.
7. When prompted, load the second original and press **OK**.

Make a 2-sided copy from the document feeder

1. Load full-size paper in the paper tray.



2. Load 1-sided originals print side up into the document feeder.

For more information about loading the original, see [Load original on page 32](#).

- Use two 1-sided originals to create a 2-sided copy.
 - Use multiple 1-sided original pages to create several pages of 2-sided copy. For example: eight pages of 1-sided originals make four pages of 2-sided copy.
3. Select **Copy** from the Home screen on the printer display to access the copy menu.
If you do not see **Copy** on the printer display, press the **Home** button, and then press the **Up** and **Down** buttons until you see **Copy**.
 4. From the **Copy** menu, select **Copies** to increase or decrease the number of copies, and then press **OK** to confirm.
 5. Select **2-Sided** to enable it, and then press **OK** to confirm.
 6. Select **Start Black Copy** or **Start Color Copy**.

More copy features

While in the **Copy** menu, press the **Up** and **Down** buttons to select among settings.

- **Paper Type:** Selects paper size and paper type. A plain paper setting will print in plain paper normal print quality. A photo paper setting will print in photo paper best quality.
- **Resize:** Controls the size of the image or document to be copied.
 - **Actual size:** Makes a copy that is the same as the size of the original, but the margins of the copied image may be clipped.
 - **Fit to Page:** Makes a copy that is centered with a white border around the edges. The resized image is either enlarged or reduced to fit the size of the selected output paper.



NOTE: The scanner glass must be clean to make sure the **Fit to Page** feature works properly.

- **Custom Size:** Allows you to increase the size of the image by selecting values greater than 100% or reduce the image size by selecting values less than 100%.

- **ID Copy:** Allows you to copy both sides of ID card.
- **Lighter / Darker:** Adjusts the copy settings to make copies lighter or darker.



NOTE: After two minutes of inactivity the copy options will automatically return to the default settings of plain paper A4 or 8.5" x 11" (depending on region).

Scan to a computer

You can scan from the control panel of the printer or from your computer. Scan from the control panel if you want to quickly scan one page to an image file. Scan from your computer if you want to scan multiple pages into one file, define the file format of the scan, or make adjustments to the scanned image.

To prepare the scan

1. Load the original print-side up in the ADF or print-side down on the scanner glass.
For more information about loading the original, see [Load original on page 32](#).
2. Start the scan.

To scan from the printer control panel

1. Select **Scan** from the Home screen on the printer display, and then press **OK**.
 **TIP:** If you do not see **Scan** on the printer display, press the **Home** button, and then press the **Up** and **Down** buttons until you see **Scan**.
2. Select the computer that you want to scan to from the printer display, and then press **OK**.

If you do not see your computer listed on the printer display make sure that your computer is connected to the printer either wirelessly or through a USB cable. If you have a wireless connection and you have confirmed that the connection is working, you will need to enable wireless scanning in the software.

To scan from your computer

1. Depending on your operating system, do one of the following to open the printer software.
 - **Windows 8:** On the **Start** screen, right-click an empty area on the screen, click **All Apps** on the app bar, and then click the icon with the printer's name.
 - **Windows 7, Windows Vista, and Windows XP:** From the computer desktop, click **Start**, select **All Programs**, click **HP**, click **HP Officejet 4630 series**, and then click **HP Officejet 4630 series**.
2. In the printer software, click the **Print, Scan & Fax** icon, and then select **Scan a Document or Photo**.
3. Select the type of scan that you want from the shortcut menu and then click **Scan**.

 **NOTE:** If **Show Scan Preview** is selected, you will be able to make adjustments to the scanned image in the preview screen.

4. Select **Save** if you want to keep the application open for another scan, or select **Done** to exit the application.
5. After the scan is saved, a Windows Explorer window will open in the directory where the scan was saved.

 **NOTE:** There is a limited number of computers that can have the scan function activated at the same time. Select **Scan** on the printer display and you will see the computers that are currently available for scanning.

Scan from your computer

1. Open HP Scan.

HP Scan is located in the **Applications/Hewlett-Packard** folder at the top level of the hard disk.

2. Choose the type of scan profile you want and follow the on-screen instructions.

Tips for copy success

- Clean the scanner glass and make sure that there are no foreign materials adhering to it.
- To increase or decrease the contrast of your printed output, select **Copy** from the printer display and then select **Lighter/Darker** to adjust the contrast.
- To select the paper size and paper type of the printed output, select **Copy** from the printer display. From the **Copy** menu select **Paper Type** to choose plain or photo paper and photo paper size.
- To resize the image, select **Copy** from the printer display and then select **Resize**.

Tips for scan success

- Clean the scanner glass and make sure that there are no foreign materials adhering to it.
- After you select **Scan** from the printer display, choose the computer that you want to scan to from the list of printers on the printer display.
- If you have a wireless connection from your printer to your computer, and you want to always be able to quickly scan to your connected computer, make sure to have **Scan to Computer** always active.
- If you want to scan a document with several pages into one file instead of multiple files, start the scan with the printer software instead of selecting **Scan** from the printer display.

6 Fax

You can use the printer to send and receive faxes, including color faxes. You can schedule faxes to be sent at a later time and set up speed-dials to send faxes quickly and easily to frequently used numbers. From the printer control panel, you can also set a number of fax options, such as resolution and the contrast between lightness and darkness on the faxes you send.



NOTE: Before you begin faxing, make sure you have set up the printer correctly for faxing. You might have already done this as part of the initial setup, by using either the control panel or the HP software provided with the printer. You can verify the fax is set up correctly by running the fax setup test from the control panel. For more information on the fax test, see [Test fax setup on page 163](#).

- [Send a fax](#)
- [Receive a fax](#)
- [Set up speed-dial entries](#)
- [Change fax settings](#)
- [Fax and digital phone services](#)
- [Fax on Voice over Internet Protocol](#)
- [Use reports](#)
- [Tips for fax success](#)

Send a fax

You can send a fax in a variety of ways. Using the printer control panel, you can send a black-and-white or color fax. You can also send a fax manually from an attached phone. This allows you to speak with the recipient before sending the fax.

This section contains the following topics:

- [Send a standard fax](#)
- [Send a standard fax from the computer](#)
- [Send a fax manually from a phone](#)
- [Send a fax using monitor dialing](#)
- [Schedule a fax to send later](#)
- [Send a fax in Error Correction Mode](#)

Send a standard fax

You can easily send a single- or multiple-page black-and-white or color fax by using the printer control panel.



NOTE: If you need printed confirmation that your faxes were successfully sent, fax confirmation must be enabled.



TIP: You can also send a fax manually from a phone or by using monitor dialing. These features allow you to control the pace of your dialing. They are also useful when you want to use a calling card to charge the call and you have to respond to tone prompts while dialing.

To send a standard fax from the printer control panel

1. Load your original print-side down on the right front corner of the glass or print-side up in the ADF.

For more information about loading the original, see [Load original on page 32](#).

2. From the Home screen on the printer display, press the **Up** and **Down** buttons to select **Fax**, and then press **OK**.
3. Select **Black Fax** or **Color Fax**.

If an original is loaded in the ADF, the document is sent to the number you entered. If no original is detected in the ADF, a message appears that prompts you to make a selection.



TIP: If the recipient reports issues with the quality of the fax you sent, you can try changing the resolution or contrast of your fax.

4. Enter the fax number by using the keypad, and then press **OK**.



TIP: To add a pause in the fax number you are entering, press * repeatedly, until a dash (-) appears on the display.

Send a standard fax from the computer

You can send a document on your computer as a fax, without printing a copy and faxing it from the printer.



NOTE: Faxes sent from your computer by this method use the printer's fax connection, not your Internet connection or computer modem. Therefore, make sure the printer is connected to a working telephone line and that the fax function is set up and functioning correctly.

To use this feature, you must install the printer software using the installation program provided on the HP software CD provided with the printer.

To send a standard fax from the computer

1. Open the document on your computer that you want to fax.
2. On the **File** menu in your software application, click **Print**.
3. From the **Name** list, select the printer that has “**fax**” in the name.
4. To change settings (such as selecting to send the document as a black fax or a color fax), click the button that opens the **Properties** dialog box. Depending on your software application, this button might be called **Properties**, **Options**, **Printer Setup**, **Printer**, or **Preferences**.
5. After you have changed any settings, click **OK**.
6. Click **Print** or **OK**.
7. Enter the fax number and other information for the recipient, change any further settings for the fax, and then click **Send Fax**. The printer begins dialing the fax number and faxing the document.

Send a standard fax from the computer

1. Open the document on your computer that you want to fax.
2. From the **File** menu in your software, click **Print**.
3. Select the printer that has “**(Fax)**” in the name.
4. Select **Fax Recipients** from the pop-up menu below the **Orientation** setting.



NOTE: If you cannot find the pop-up menu, try clicking the disclosure triangle next to the **Printer selection**.

5. Enter the fax number and other information in the boxes provided, and then click **Add to Recipients**.
6. Select the **Fax Mode** and any other fax options you want, and then click **Send Fax Now** to begin dialing the fax number and faxing the document.

Send a fax manually from a phone

Sending a fax manually allows you to make a phone call and talk with the recipient before you send the fax. This is useful if you want to inform the recipient that you are going to send them a fax before sending it. When you send a fax manually, you can hear the dial tones, telephone prompts, or other sounds through the handset on your telephone. This makes it easy for you to use a calling card to send your fax.

Depending on how the recipient has their fax machine set up, the recipient might answer the phone, or the fax machine might take the call. If a person answers the phone, you can speak with the recipient before sending the fax. If a fax machine answers the call, you can send the fax directly to the fax machine when you hear the fax tones from the receiving fax machine.

To send a fax manually from an extension phone

1. Load your original print-side down on the right front corner of the glass or print-side up in the ADF.
For more information about loading the original, see [Load original on page 32](#).
2. From the Home screen on the printer display, press the **Up** and **Down** buttons to select **Fax**, and then press **OK**.
3. Dial the number by using the keypad on the phone that is connected to the printer.



NOTE: Do not use the keypad on the control panel of the printer when manually sending a fax. You must use the keypad on your phone to dial the recipient's number.

4. If the recipient answers the telephone, you can engage in a conversation before sending your fax.



NOTE: If a fax machine answers the call, you will hear fax tones from the receiving fax machine. Proceed to the next step to transmit the fax.

5. When you are ready to send the fax, press **OK**, select **Send New Fax**, and then select **Black** or **Color**.

If you were speaking with the recipient before sending the fax, inform the recipient that they should press **Receive Fax Manually** on their fax machine after they hear fax tones.

The telephone line is silent while the fax is transmitting. At this point, you can hang up the telephone. If you want to continue speaking with the recipient, remain on the line until the fax transmission is complete.

Send a fax using monitor dialing

Monitor dialing allows you to dial a number from the printer control panel as you would dial a regular telephone. When you send a fax using monitor dialing, you can hear the dial tones, telephone prompts, or other sounds through the speakers on the printer. This enables you to respond to prompts while dialing, as well as control the pace of your dialing.



TIP: If you are using a calling card and do not enter your PIN fast enough, the printer might start sending fax tones too soon and cause your PIN not to be recognized by the calling card service. If this is the case, you can create a speed dial entry to store the PIN for your calling card. For more information, see [Set up speed-dial entries on page 53](#).



NOTE: Make sure the volume is turned on to hear a dial tone.

To send a fax using monitor dialing from the printer control panel

1. Load your original print-side down on the right front corner of the glass or print-side up in the ADF.
For more information about loading the original, see [Load original on page 32](#).
2. From the Home screen on the printer display, press the **Up** and **Down** buttons to select **Fax**, and then press **OK**.
3. Select **Black Fax** or **Color Fax**.
 - If the printer detects an original loaded in the ADF, you hear a dial tone.
 - If the original is loaded on the scanner glass, select **Fax from Glass**.

4. When you hear the dial tone, enter the number by using the keypad on the printer control panel.
5. Follow any prompts that might occur.

Your fax is sent when the receiving fax machine answers.

Schedule a fax to send later

You can schedule a black-and-white fax to be sent within the next 24 hours. This enables you to send a black-and-white fax late in the evening, when phone lines are not as busy or phone rates are lower, for example. The printer automatically sends your fax at the specified time.

You can only schedule one fax to be sent at a time. You can continue to send faxes normally, however, while a fax is scheduled.



NOTE: You can only send a black-and-white fax from memory.

To schedule a fax from the printer control panel

1. Load your original print-side up in the ADF.
For more information about loading the original, see [Load original on page 32](#).
2. From the Home screen on the printer display, press the **Up** and **Down** buttons to select **Fax**, and then press **OK**.
3. Select **Settings**, and then select **Schedule a Fax**.
4. Enter the fax delay time by pressing the **Up** and **Down** buttons, and then press **OK** to confirm.
5. When you hear the dial tone, enter the number by using the keypad on the printer control panel.
6. Select **Scan**, and then select **Start**.

The printer scans all pages and sends the fax at the scheduled time.

To cancel a scheduled fax

1. From the Home screen on the printer display, press the **Up** and **Down** buttons to select **Fax**, and then press **OK**.
2. Select **Settings**, and then select **Schedule a Fax**.
3. Select the scheduled fax that you want to delete, and then select **Delete**.

Send a fax in Error Correction Mode

Error Correction Mode (ECM) prevents loss of data due to poor phone lines by detecting errors that occur during transmission and automatically requesting retransmission of the erroneous portion. Phone charges are unaffected, or might even be reduced, on good phone lines. On poor phone lines, ECM increases sending time and phone charges, but sends the data much more reliably. The default setting is **On**. Turn ECM off only if it increases phone charges substantially, and if you can accept poorer quality in exchange for reduced charges.

Before turning the ECM setting off, consider the following. If you turn ECM off:

- The quality and transmission speed of faxes you send and receive are affected.
- The **Fax Speed** is automatically set to **Medium**.
- You can no longer send or receive faxes in color.

To change the ECM setting from the control panel

1. From the Home screen on the printer display, press the **Up** and **Down** buttons to select **Fax**, and then press **OK**.
2. Select **Settings**, and then select **Advanced Settings**.
3. Select **Error Correction**.
4. Select **On** or **Off**, and then press **OK**.

Receive a fax

You can receive faxes automatically or manually. If you turn off the **Auto Answer** option, you must receive faxes manually. If you turn on the **Auto Answer** option (the default setting), the printer automatically answers incoming calls and receives faxes after the number of rings that are specified by the **Rings to Answer** setting. (The default **Rings to Answer** setting is five rings.)

If you receive a Legal-size or larger fax and the printer is not currently set to use Legal-size paper, the printer reduces the fax so that it fits on the paper that is loaded.



NOTE: If you are copying a document when a fax arrives, the fax is stored in the printer memory until the copying finishes. This can reduce the number of fax pages stored in memory.

- [Receive a fax manually](#)
- [Reprint received faxes from memory](#)
- [Forward faxes to another number](#)
- [Set the paper size for received faxes](#)
- [Block unwanted fax numbers](#)

Receive a fax manually

When you are on the phone, the person you are speaking with can send you a fax while you are still connected. This is referred to as manual faxing. Use the instructions in this section to receive a manual fax.



NOTE: You can pick up the handset to talk or listen for fax tones.

You can receive faxes manually from a phone that is:

- Directly connected to the printer (on the 2_EXT port)
- On the same phone line, but not directly connected to the printer

To receive a fax manually

1. Make sure the printer is turned on and you have paper loaded in the main tray.
2. Remove any originals from the ADF tray.
3. Set the **Rings to Answer** setting to a high number to allow you to answer the incoming call before the printer answers. Or, turn off the **Auto Answer** setting so that the printer does not automatically answer incoming calls.
4. If you are currently on the phone with the sender, instruct the sender to press **Send New Fax** on their fax machine.
5. When you hear fax tones from a sending fax machine, do the following:
 - a. From the Home screen on the printer display, press the **Up** and **Down** buttons to select **Fax**, press **OK**, and then select **Receive Fax Manually**.
 - b. After the printer begins to receive the fax, you can hang up the phone or remain on the line. The phone line is silent during fax transmission.

Reprint received faxes from memory

The received faxes, which are not printed out, are stored in memory.

 **NOTE:** After the memory becomes full, the printer cannot receive the new fax until you print or delete the faxes from memory. You might also want to delete the faxes in memory for security or privacy purposes.

Depending on the sizes of the faxes in memory, you can reprint up to eight of the most recently printed faxes, if they are still in memory. For example, you might need to reprint your faxes if you lost the copy of your last printout.

To reprint faxes in memory from the printer control panel

1. Make sure you have paper loaded in the main tray. For more information, see [Load media on page 28](#).
2. From the Home screen on the printer display, press the **Up** and **Down** buttons to select **Fax**, and then press **OK**.
3. Select **Settings**, and then select **Reprint Missed Faxes**.

The faxes are displayed in the reverse order from which they were received with the most recently received fax first, and so on.

4. Select the fax you want to print, and then select **Print**.
5. If you want to stop reprinting the fax, select **Cancel**.

Forward faxes to another number

You can set up the printer to forward your faxes to another fax number. A received color fax is forwarded in black and white.

HP recommends that you verify the number you are forwarding to is a working fax line. Send a test fax to make sure the fax machine is able to receive your forwarded faxes.

To forward faxes from the printer control panel

1. From the Home screen on the printer display, press the **Up** and **Down** buttons to select **Fax**, and then press **OK**.
2. Select **Settings**, and then select **Advanced Settings**.
3. Select **Fax Forwarding**, and then select **Select Fax Forward**.
4. Select **On with Print** to print and forward the fax, or select **On** to forward the fax.

 **NOTE:** If the printer is not able to forward the fax to the designated fax machine (for example, if it is not turned on), the printer prints the fax. If you set up the printer to print error reports for received faxes, it also prints an error report.

5. At the prompt, enter the number of the fax machine intended to receive the forwarded faxes, and then select **Done**. Enter the required information for each of the following prompts: start date, start time, end date, and end time.
6. Fax forwarding is activated. Select **OK** to confirm.

If the printer loses power when fax forwarding is set up, it saves the fax forwarding setting and phone number. When the power is restored to the printer, the fax forwarding setting is still **On**.

 **NOTE:** You can cancel fax forwarding by selecting **Off** from the **Fax Forward** menu.

Set the paper size for received faxes

You can select the paper size for received faxes. The paper size you select should match what is loaded in your main tray. Faxes can be printed on Letter, A4, or Legal paper only.

 **NOTE:** If an incorrect paper size is loaded in the main tray when you receive a fax, the fax does not print and an error message appears on the display. Load Letter, A4, or Legal paper, and then press **OK** to print the fax.

To set the paper size for received faxes from the printer control panel

1. From the Home screen on the printer display, press the **Up** and **Down** buttons to select **Fax**, and then press **OK**.
2. Select **Settings**.
3. Select **Fax Paper Size**, and then select an option.

Block unwanted fax numbers

If you subscribe to a caller ID service through your phone provider, you can block specific fax numbers so the printer does not print faxes received from those numbers. When an incoming fax call is received, the printer compares the number to the list of junk fax numbers to determine if the call should be blocked. If the number matches a number in the blocked fax numbers list, the fax is not printed. (The maximum number of fax numbers you can block varies by model.)

 **NOTE:** This feature is not supported in all countries/regions. If it is not supported in your country/region, **Junk Fax Blocker** does not appear in the **Fax Options** or **Fax Settings** menu.

 **NOTE:** If no phone numbers are added in the Caller ID list, it is assumed that you are not subscribed to a Caller ID service.

- [Add numbers to the junk fax list](#)
- [Remove numbers from the junk fax list](#)

Add numbers to the junk fax list

You can block specific numbers by adding them to the junk fax list.

To add a number to the junk fax list

1. From the Home screen on the printer display, press the **Up** and **Down** buttons to select **Fax**, and then press **OK**.
2. Select **Settings**, and then select **Junk Fax**.
3. A message appears stating that Caller ID is required to block junk faxes. Select **OK** to continue.
4. Select **Add a Number**.
5. To select a fax number to block from the caller ID list, select **From Call History**.

- or -

To manually enter a fax number to block, select **Enter New Number**.

6. After entering a fax number to block, select **Done**.



NOTE: Make sure you enter the fax number as it appears on the control panel display, and not the fax number that appears on the fax header of the received fax, as these numbers can be different.

Remove numbers from the junk fax list

If you no longer want to block a fax number, you can remove a number from your junk fax list.

To remove numbers from the list of junk fax numbers

1. From the Home screen on the printer display, press the **Up** and **Down** buttons to select **Fax**, and then press **OK**.
2. Select **Settings**, and then select **Junk Fax**.
3. Select the number you want to remove, and then select **Remove a Number**.
4. Press **OK** to confirm the deletion.

Set up speed-dial entries

You can set up frequently used fax numbers as speed-dial entries. This lets you dial those numbers quickly by using the printer control panel.

 **TIP:** In addition to creating and managing speed-dial entries from the printer's control panel, you can also use tools available on your computer, such as the HP software included with the printer and the printer's embedded web server (EWS).

This section contains the following topics:

- [Set up and change speed-dial entries](#)
- [Delete speed-dial entries](#)

Set up and change speed-dial entries

You can store fax numbers as speed-dial entries.

To set up speed-dial entries

1. From the Home screen on the printer display, press the **Up** and **Down** buttons to select **Fax**, and then press **OK**.
2. Select **Settings**, and then select **Phone Book**.
3. Select **Add Contact**.
4. Type the name of the entry, and then select **Next**.
5. Type the fax number, and then select **Done**.

 **NOTE:** Be sure to include any pauses or other required numbers, such as an area code, an access code for numbers outside a PBX system (usually a 9 or 0), or a long-distance prefix.

To change speed-dial entries

1. From the Home screen on the printer display, press the **Up** and **Down** buttons to select **Fax**, and then press **OK**.
2. Select **Settings**, and then select **Phone Book**.
3. Select the entry you want to change, and then press **OK**.
4. Select **Edit**, and then make your changes in the fax name, and then select **Next**.
5. Make your changes in the fax number, and then select **Done**.

 **NOTE:** Be sure to include any pauses or other required numbers, such as an area code, an access code for numbers outside a PBX system (usually a 9 or 0), or a long-distance prefix.

Delete speed-dial entries

To delete speed-dial entries

1. From the Home screen on the printer display, press the **Up** and **Down** buttons to select **Fax**, and then press **OK**.
2. Select **Settings**, and then select **Phone Book**.
3. Select the entry you want to delete, and then select **Delete** to confirm.

Change fax settings

Use the following steps to change the initial settings or to configure other options for faxing.

- [Configure the fax header](#)
- [Set the answer mode \(Auto answer\)](#)
- [Set the number of rings before answering](#)
- [Change the answer ring pattern for distinctive ring](#)
- [Set the dial type](#)
- [Set the redial options](#)
- [Set the fax speed](#)
- [Set the fax sound volume](#)

Configure the fax header

The fax header prints your name and fax number on the top of every fax you send. HP recommends that you set up the fax header by using the HP software provided with the printer. You can also set up the fax header from the printer control panel, as described here.



NOTE: In some countries/regions, the fax header information is a legal requirement.

To set or change the fax header

1. From the Home screen on the printer display, press the **Up** and **Down** buttons to select **Fax**, and then press **OK**.
2. Select **Settings**, and then select **Fax Header**.
3. Enter your personal or company name and fax number, and then select **Done**.

Set the answer mode (Auto answer)

The answer mode determines whether the printer answers incoming calls.

- Turn on the **Auto Answer** setting if you want the printer to answer faxes **automatically**. The printer answers all incoming calls and faxes.
- Turn off the **Auto Answer** setting if you want to receive faxes **manually**. You must be available to respond in person to the incoming fax call or else the printer does not receive faxes.

To set the answer mode

1. From the Home screen on the printer display, press the **Up** and **Down** buttons to select **Fax**, and then press **OK**.
2. Select **Settings**.
3. Select **Auto Answer**, select **On** or **Off**, and then press **OK**.

Set the number of rings before answering

If you turn on the **Auto Answer** setting, you can specify how many rings occur before incoming calls are automatically answered.

The **Rings to Answer** setting is important if you have an answering machine on the same phone line as the printer, because you want the answering machine to answer the phone before the printer does. The number of rings to answer for the printer should be greater than the number of rings to answer for the answering machine.

For example, set your answering machine to a low number of rings and the printer to answer in the maximum number of rings. (The maximum number of rings varies by country/region.) In this setup, the answering machine answers the call and the printer monitors the line. If the printer detects fax tones, it receives the fax. If the call is a voice call, the answering machine records the incoming message.

To set the number of rings before answering

1. From the Home screen on the printer display, press the **Up** and **Down** buttons to select **Fax**, and then press **OK**.
2. Select **Settings**, and then select **Advanced Settings**.
3. Select **Ring Settings**, and then select **Rings to Answer**.
4. Select up and down arrows to change the number of rings.
5. Select **OK** to accept the setting.

Change the answer ring pattern for distinctive ring

Many phone companies offer a distinctive ring feature that allows you to have several phone numbers on one phone line. When you subscribe to this service, each number is assigned a different ring pattern. You can set up the printer to answer incoming calls that have a specific ring pattern.

If you connect the printer to a line with distinctive ring, have your telephone company assign one ring pattern to voice calls and another ring pattern to fax calls. HP recommends that you request double or triple rings for a fax number. When the printer detects the specified ring pattern, it answers the call and receives the fax.

 **TIP:** You can also use the Ring Pattern Detection feature in the printer's control panel to set distinctive ring. With this feature, the printer recognizes and records the ring pattern of an incoming call and, based on this call, automatically determines the distinctive ring pattern assigned by your telephone company to fax calls.

If you do not have a distinctive ring service, use the default ring pattern, which is **All Rings**.

 **NOTE:** The printer cannot receive faxes when the main phone number is off the hook.

To change the answer ring pattern for distinctive ring

1. Verify that the printer is set to answer fax calls automatically.
2. From the Home screen on the printer display, press the **Up** and **Down** buttons to select **Fax**, and then press **OK**.
3. Select **Settings**, and then select **Advanced Settings**.
4. Select **Ring Settings**, and then select **Distinctive Ring**.

5. A message appears stating that this setting should not be changed unless you have multiple numbers on the same telephone line. Select **Yes** to continue.
6. Do one of the following:
 - Select the ring pattern assigned by your telephone company to fax calls.
 - Or -
 - Select **Auto Detect**, and then follow the instructions on the printer control panel.

 **NOTE:** If the Ring Pattern Detection feature cannot detect the ring pattern or if you cancel the feature before it finishes, the ring pattern is automatically set to the default, which is **All Rings**.

 **NOTE:** If you are using a PBX phone system that has different ring patterns for internal and external calls, you must call the fax number from an external number.

Set the dial type

Use this procedure to set tone-dialing or pulse-dialing mode. The factory-set default is **Tone**. Do not change the setting unless you know that your phone line cannot use tone dialing.

 **NOTE:** The pulse-dialing option is not available in all countries/regions.

To set the dial type

1. From the Home screen on the printer display, press the **Up** and **Down** buttons to select **Fax**, and then press **OK**.
2. Select **Settings**, and then select **Advanced Settings**.
3. Select **Dial Type**, select **Tone Dialing** or **Pulse Dialing**, and then press **OK**.

Set the redial options

If the printer was unable to send a fax because the receiving fax machine did not answer or was busy, the printer attempts to redial based on the settings for the busy-redial and no-answer-redial options. Use the following procedure to turn the options on or off.

- **When Busy:** If this option is turned on, the printer redials automatically if it receives a busy signal. The factory-set default for this option is **Redial**.
- **When No answer:** If this option is turned on, the printer redials automatically if the receiving fax machine does not answer. The factory-set default for this option is **No Redial**.

To set the redial options

1. From the Home screen on the printer display, press the **Up** and **Down** buttons to select **Fax**, and then press **OK**.
2. Select **Settings**, and then select **Auto Redial**.
3. Select the appropriate option, and then press **OK**.

Set the fax speed

You can set the fax speed used to communicate between your printer and other fax machines when sending and receiving faxes.

If you use one of the following, setting the fax speed to a slower speed might be required:

- An Internet phone service
- A PBX system
- Fax on Voice over Internet Protocol (VoIP)
- An integrated services digital

If you experience problems sending and receiving faxes, try using a lower **Fax Speed**. The following table provides the available fax speed settings.

| Fax speed setting | Fax speed |
|-------------------|------------------|
| Fast | v.34 (33600 bps) |
| Medium | v.17 (14400 bps) |
| Slow | v.29 (9600 bps) |

To set the fax speed

1. From the Home screen on the printer display, press the **Up** and **Down** buttons to select **Fax**, and then press **OK**.
2. Select **Settings**, and then select **Advanced Settings**.
3. Select **Fax Speed**.
4. Select an option, and then press **OK**.

Set the fax sound volume

Use this procedure to increase or decrease the volume of the fax sounds.

To set the fax sound volume

1. From the Home screen on the printer display, press the **Up** and **Down** buttons to select **Fax**, and then press **OK**.
2. Select **Settings**, and then select **Advanced Settings**.
3. Select **Ring Settings**, and then select **Fax Sound Volume**.
4. Select **Soft**, **Loud**, or **Off**, and then press **OK**.

Fax and digital phone services

Many telephone companies provide their customers with digital phone services, such as the following:

- DSL: A Digital subscriber line (DSL) service through your telephone company. (DSL might be called ADSL in your country/region.)
- PBX: A private branch exchange (PBX) phone system.
- ISDN: An integrated services digital network (ISDN) system.
- VoIP: A low-cost phone service that allows you to send and receive faxes with your printer by using the Internet. This method is called Fax on Voice over Internet Protocol (VoIP).

For more information, see [Fax on Voice over Internet Protocol on page 60](#).

HP printers are designed specifically for use with traditional analog phone services. If you are in a digital phone environment (such as DSL/ADSL, PBX, or ISDN), you might need to use digital-to-analog filters or converters when setting up the printer for faxing.



NOTE: HP does not guarantee that the printer will be compatible with all digital service lines or providers, in all digital environments, or with all digital-to-analog converters. It is always recommended that you discuss with the telephone company directly for the correct setup options based on their line services provided.

Fax on Voice over Internet Protocol

You might be able to subscribe to a low cost phone service that allows you to send and receive faxes with your printer by using the Internet. This method is called Fax on Voice over Internet Protocol (VoIP).

The following are indications you probably use a VoIP service.

- Dial a special access code along with the fax number.
- Have an IP converter box that connects to the Internet and provides analog phone ports for the fax connection.



NOTE: You can only send and receive faxes by connecting a phone cord to the port labeled "1-LINE" on the printer. This means that your connection to the Internet must be done either through a converter box (which supplies regular analog phone jacks for fax connections) or your telephone company.



TIP: Support for traditional fax transmission over any Internet protocol telephone systems are often limited. If you experience problems faxing, try using a slower fax speed or disabling the fax error-correction mode (ECM). However, if you turn off ECM, you cannot send and receive color faxes.

For more information about changing the fax speed, see [Set the fax speed on page 58](#). For more information about using ECM, see [Send a fax in Error Correction Mode on page 47](#).

If you have questions about Internet faxing, contact your Internet faxing services support department or your local service provider for further assistance.

Use reports

You can set up the printer to print error reports and confirmation reports automatically for each fax you send and receive. You can also manually print system reports as required; these reports provide useful system information about the printer.

By default, the printer is set to print a report only if there is a problem sending or receiving a fax. A confirmation message that indicates whether a fax was successfully sent appears briefly on the control panel display after each transaction.

 **NOTE:** If the reports are not legible, you can check the estimated ink levels from the control panel or the HP software.

 **NOTE:** Ink level alerts and indicators provide estimates for planning purposes only. When you receive a low-ink alert, consider having a replacement cartridge available to avoid possible printing delays. You do not need to replace the ink cartridges until prompted to do so.

 **NOTE:** Ensure that the printheads and ink cartridges are in good conditions and installed properly. For more information, see [Work with cartridges on page 71](#).

This section contains the following topics:

- [Print fax confirmation reports](#)
- [Print and view the fax log](#)
- [Print the details of the last fax transaction](#)
- [Print a Caller ID Report](#)
- [View the Call History](#)

Print fax confirmation reports

If you require printed confirmation that your faxes were successfully sent, follow these instructions to enable fax confirmation **before** sending any faxes.

The default fax confirmation setting is **Error Only**.

To enable fax confirmation

1. From the Home screen on the printer display, press the **Up** and **Down** buttons to select **Fax**, and then press **OK**.
2. Select **Settings**, select **Advanced Settings**, and then select **Fax Confirmation**.
3. Select one of the following options, and then press **OK**.

| | |
|--------------------------|--|
| Off | Does not print a fax confirmation report when you send and receive faxes successfully. |
| After Send Fax | Prints a fax confirmation report for every fax you send. |
| After Receive Fax | Prints a fax confirmation report for every fax you receive. |

| | |
|-------------------|--|
| On Always | Prints a fax confirmation report for every fax you send and receive. |
| Error Only | Prints a fax confirmation report for every fax error. This is the default setting. |

Print and view the fax log

You can print a log of faxes that have been received and sent by the printer.

To print the fax log from the printer control panel

1. From the Home screen on the printer display, press the **Up** and **Down** buttons to select **Fax**, and then press **OK**.
2. Select **Settings**, select **Advanced Settings**, and then select **Fax Reports**.
3. Select **Fax Log**, and then press **OK**.

Print the details of the last fax transaction

The Last Fax Transaction report prints the details of the last fax transaction to occur. Details include the fax number, number of pages, and the fax status.

To print the Last Fax Transaction report

1. From the Home screen on the printer display, press the **Up** and **Down** buttons to select **Fax**, and then press **OK**.
2. Select **Settings**, select **Advanced Settings**, and then select **Fax Reports**.
3. Select **Last Transaction Report**, and then press **OK**.

Print a Caller ID Report

Use the following procedure to print a list of Caller ID fax numbers.

To print a Caller ID History Report

1. From the Home screen on the printer display, press the **Up** and **Down** buttons to select **Fax**, and then press **OK**.
2. Select **Settings**, select **Advanced Settings**, and then select **Fax Reports**.
3. Select **Caller ID Report**, and then press **OK**.

View the Call History

Use the following procedure to print a list of all the calls placed from the printer.

To view the Call History

1. From the Home screen on the printer display, press the **Up** and **Down** buttons to select **Fax**, and then press **OK**.
2. Select **Settings**, and then select **Junk Fax**.
3. Select **Add a Number**, select **From Call History**, and then press **OK**.

Tips for fax success

- Load your original print-side down on the right front corner of the glass or print-side up in the ADF.

For more information about loading the original, see [Load original on page 32](#).

- Clean the scanner glass and make sure that there are no foreign materials adhering to it.
- Turn on **Error Correction Mode** (ECM) to send color faxes.

For more information about turning on ECM, see [Send a fax in Error Correction Mode on page 47](#).

- After the fax memory becomes full, the printer does not receive any faxes until you print or delete the faxes from memory.

For more information about reprinting the faxes in the memory, see [Reprint received faxes from memory on page 50](#).

- You can set up the printer to answer incoming calls with a specific ring pattern. Use this feature only when you have subscribed to the service, which allows several phone numbers on one phone line from your phone service provider.

7 Use Web Services

- [HP ePrint](#)
- [Use HP Printables](#)
- [Use the HP Connected website](#)
- [Tips for using Web Services](#)

HP ePrint

HP ePrint is a free service from HP that allows you to print to your HP ePrint-enabled printer anytime, from any location. It's as simple as sending an email to the email address assigned to your printer when you enable Web Services on the printer. No special drivers or software are needed. If you can send an email, you can print from anywhere, using HP ePrint.

Once you have signed up for an account on HP Connected (www.hpconnected.com), you can sign in to view your ePrint job status, manage your HP ePrint printer queue, control who can use your printer's HP ePrint email address to print, and get help for HP ePrint.

HP ePrint allows you to print to your HP ePrint-enabled printer anytime, from any location.

To use HP ePrint, make sure to have the following:

- An Internet- and email-capable computer or mobile device
- An HP ePrint-capable printer on which Web Services has been enabled

 **NOTE:** The email will be printed once it is received. As with any email, there is no guarantee when or whether it will be received. You can check the print status on HP Connected (www.hpconnected.com).

 **NOTE:** Documents printed with HP ePrint may appear different from the original. Style, formatting, and text flow may differ from the original document. For documents that need to be printed with a higher quality (such as legal documents), we recommend that you print from the software application on your computer, where you will have more control over what your printout looks like.

 **TIP:** For more information about managing and configuring HP ePrint settings and to learn about the latest features, visit HP Connected (www.hpconnected.com).

To print using HP ePrint

1. Enable Web Services.
 - a. From the printer control panel, press the **ePrint** button.
 - b. Accept the Terms of Use, and then follow the on-screen instructions to enable Web Services.
 - c. Print the ePrint information page, and then follow the instructions on the page to sign up for an HP ePrint account.

2. On your computer or mobile device, open your email application.

 **NOTE:** For information about using the email application on your computer or mobile device, see the documentation provided with the application.

3. Create a new email message, and then attach the file that you want to print.
4. Enter the printer's email address in the "To" line of the email message, and then select the option to send the email message.

 **NOTE:** Do not include any email address in the "Bcc" field; this field is required to be blank. If there is an email address or printer address in the "Bcc" field the job will not be printed.

To find the printer's email address

1. Press the **ePrint** button on the control panel. You will see the **Web Services Settings** menu on the printer display.
2. Select **Display Email Address** from the printer display to view the printer's email address.

 **TIP:** To customize the email address, select **Print Info Page** from the **Web Services Settings** menu on the printer display. The printer prints an information page that contains the printer code and instructions on how to customize the email address.

To turn off ePrint

1. Press the **ePrint** button on the control panel. You will see the **Web Services Settings** menu on the printer display.
2. Select **ePrint** from the printer display, and then select **Off**.

Use HP Printables

HP Printables, a free service from HP, delivers a wide range of news, recipes, business tips, coloring pages, puzzles, personalized coupons, and more - directly to your web-connected printer, on your schedule. Browse from a range of options, including top brands, to find the content you want and get the prints you love. You can get the prints you want immediately or, with some printables, you can set them to be automatically delivered on the days and times that you want.

Preformatted content designed specifically for your printer means no cut-off text and pictures and no extra pages with only one line of text.



NOTE: To use HP Printables, the printer must be connected to a network that provides an Internet connection, and you must register for this service. Printable availability varies by country, language, and agreements, and might require a firmware upgrade.

For more information, visit www.hpconnected.com. On some printers and websites, HP Printables might be called Print Apps.

Use the HP Connected website

Use HP's free HP Connected website to set up increased security for HP ePrint, and specify the email addresses that are allowed to send email to your printer. You can also get product updates, more HP Printables, and other free services.

Go to the HP Connected website for more information and specific terms and conditions:

www.hpconnected.com.

Tips for using Web Services

Use the following tips to print HP Printables and use HP ePrint.

Tips for printing HP Printables and using HP ePrint

- Learn about HP Printables for printing recipes, coupons, and other content from the web, simply and easily. [Click here to go online for more information.](#)

8 Work with cartridges

- [Check the estimated ink levels](#)
- [Order ink supplies](#)
- [Choose right ink cartridges](#)
- [Replace the cartridges](#)
- [Use single-cartridge mode](#)
- [Cartridge warranty information](#)
- [Tips for working with cartridges](#)

Check the estimated ink levels

You can easily check the ink supply level to determine how soon you might need to replace a cartridge. The ink supply level shows an estimate of the amount of ink remaining in the cartridges.

To check the ink levels from the printer control panel

- From the Home screen on the printer display, select **Ink Levels**, and then press **OK**. Then the printer displays the current ink levels.



NOTE: If you do not see the Home screen, press the **Home** button.

To check the ink levels from the printer software

1. Depending on your operating system, do one of the following to open the printer software:
 - **Windows 8:** On the **Start** screen, right-click an empty area on the screen, click **All Apps** on the app bar, and then click the icon with the printer's name.
 - **Windows 7, Windows Vista, and Windows XP:** From the computer desktop, click **Start**, select **All Programs**, click **HP**, click **HP Officejet 4630 series**, and then click **HP Officejet 4630 series**.
2. In the printer software, click **Estimated Ink Levels**.

To check the ink levels from HP Utility

1. Open HP Utility.

HP Utility is located in the **Hewlett-Packard** folder in the **Applications** folder at the top level of the hard disk.
2. Select the HP Officejet 4630 series from the list of devices at the left of the window.
3. Click **Supplies Status**.

The estimated ink levels appear.
4. Click **All Settings** to return to the **Information and Support** pane.



NOTE: If you have installed a refilled or remanufactured cartridge, or a cartridge that has been used in another printer, the ink level indicator might be inaccurate or unavailable.



NOTE: Ink level warnings and indicators provide estimates for planning purposes only. When you receive a low-ink warning message, consider having a replacement cartridge available to avoid possible printing delays. You do not have to replace the cartridges until the print quality is unacceptable.



NOTE: Ink from the cartridges is used in the printing process in a number of different ways, including in the initialization process, which prepares the printer and cartridges for printing, and in printhead servicing, which keeps print nozzles clear and ink flowing smoothly. In addition, some residual ink is left in the cartridge after it is used. For more information, see www.hp.com/go/inkusage.

Order ink supplies

Before ordering cartridges, locate the correct cartridge number.

Locate the cartridge number on the printer

- The cartridge number is located inside the cartridge access door.



Locate the cartridge number in the printer software

1. Depending on your operating system, do one of the following to open the printer software:
 - **Windows 8:** On the **Start** screen, right-click an empty area on the screen, click **All Apps** on the app bar, and then click the icon with the printer's name.
 - **Windows 7, Windows Vista, and Windows XP:** From the computer desktop, click **Start**, select **All Programs**, click **HP**, click **HP Officejet 4630 series**, and then click **HP Officejet 4630 series**.
2. In the printer software, click **Shop**, and then click **Shop For Supplies Online**.

The correct cartridge number appears when you use this link.

To find the print cartridge reorder numbers

1. Open HP Utility.

 **NOTE:** HP Utility is located in the **Hewlett-Packard** folder in the **Applications** folder at the top level of the hard disk.

2. Click **Supplies Info**.

The print cartridge ordering numbers appear.

3. Click **All Settings** to return to the **Information and Support** pane.

To order original HP supplies for the HP Officejet 4630 series, go to www.hp.com/buy/supplies. If prompted, choose your country/region, follow the prompts to select your product, and then click one of the shopping links on the page.

 **NOTE:** Ordering ink cartridges online is not supported in all countries/regions. If it is not available in your country/region, you may still view supplies information and print a list for reference when shopping at a local HP reseller.

Choose right ink cartridges

HP recommends that you use Original HP ink cartridges. Original HP ink cartridges are designed and tested with HP printers to help you easily produce great results, time after time.

Replace the cartridges

To replace the cartridges

1. Check that power is on.
2. Remove cartridge.
 - a. Open the cartridge access door.



Wait for print carriage to move to the right side of the printer.

- b. Lift up the cartridge tab, and then remove it from the slot.

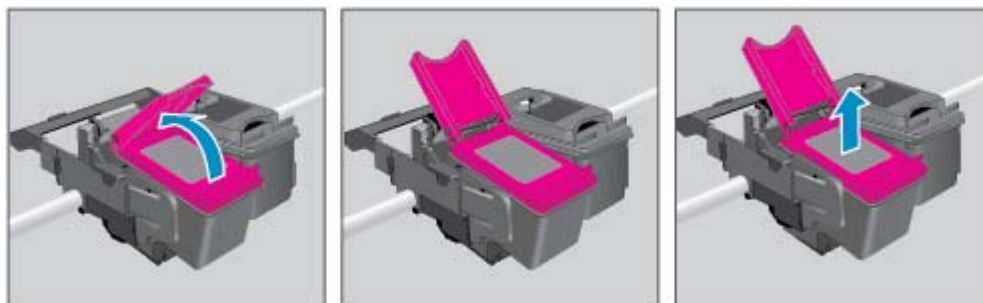

3. Insert new cartridge.
 - a. Remove cartridge from packaging.



- b. Remove the plastic tape using the pull tab.

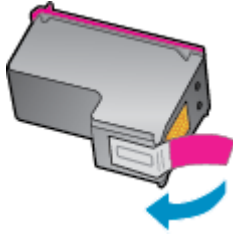

- c. Place new cartridge in slot at an angle under the opened tab, and then squeeze the tab closed as the cartridge slides into place.

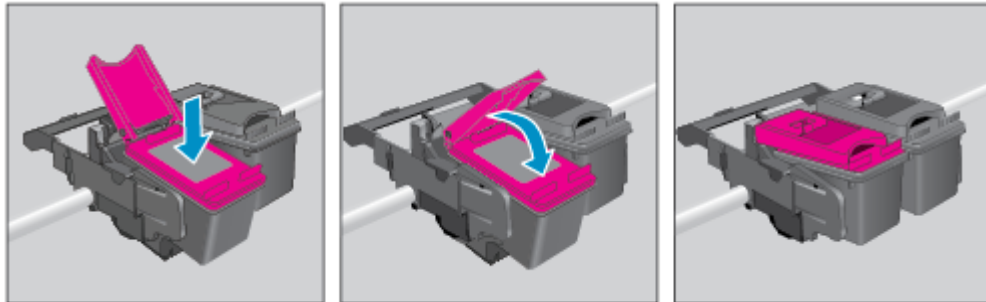

- d. Close the cartridge access door.



4. Load plain paper and print out the alignment page.
5. Load the alignment page print-side down on the right front corner of the scanner glass, close the lid, and then press **OK** to complete the alignment.

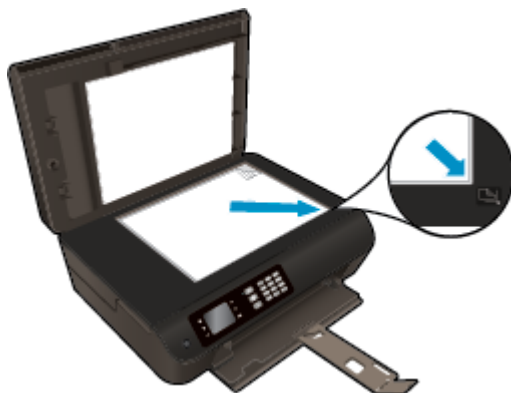

Use single-cartridge mode

Use the single-cartridge mode to operate the HP Officejet 4630 series with only one ink cartridge. The single-cartridge mode is initiated when an ink cartridge is removed from the ink cartridge carriage.

 **NOTE:** When the HP Officejet 4630 series operates in single-cartridge mode, a message is displayed on the printer display. If the message is displayed and two ink cartridges are installed in the printer, verify that the protective piece of plastic tape has been removed from each ink cartridge. When plastic tape covers the ink cartridge contacts, the printer cannot detect that the ink cartridge is installed.

To exit single-cartridge mode

- Install both the black and tri-color cartridges in the HP Officejet 4630 series to exit single-cartridge mode.

Cartridge warranty information

The HP cartridge warranty is applicable when the cartridge is used in its designated HP printing device. This warranty does not cover HP ink cartridges that have been refilled, remanufactured, refurbished, misused, or tampered with.

During the warranty period the cartridge is covered as long as the HP ink is not depleted and the end of warranty date has not been reached. The end of warranty date, in YYYY/MM/DD format, may be found on the cartridge as indicated:

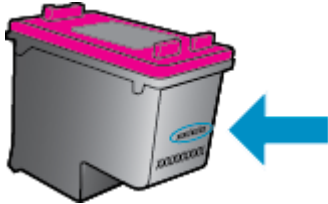

For a copy of the HP Limited Warranty Statement, see the printed documentation that came with the printer.

Tips for working with cartridges

Use the following tips to work with cartridges:

- To protect the cartridges from drying out, always turn the printer off using the **On** button, and wait until the **On** button light goes out.
- Do not open or untape cartridges until you are ready to install them. Leaving tape on the cartridges reduces ink evaporation.
- Insert the cartridges into the correct slots. Match the color and icon of each cartridge to the color and icon for each slot. Make sure the cartridges snap into place.
- Align the printer for best print quality. See [Improve print quality on page 98](#) for more information.
- When the Estimated Ink Levels screen shows one or both cartridges in a low state, consider getting replacement cartridges to avoid possible printing delays. You do not need to replace the cartridges until print quality becomes unacceptable. See [Replace the cartridges on page 75](#) for more information.
- If you remove a cartridge from the printer for any reason, try to replace it again as soon as possible. Outside of the printer, if unprotected, cartridges begin to dry out.

9 Connectivity

- [Wi-Fi Protected Setup \(WPS – requires WPS router\)](#)
- [Traditional wireless connection \(requires router\)](#)
- [USB connection \(non-network connection\)](#)
- [Change from a USB connection to a wireless network](#)
- [Connect wirelessly to the printer without a router](#)
- [Tips for setting up and using a networked printer](#)
- [Advanced printer management tools \(for networked printers\)](#)

Wi-Fi Protected Setup (WPS – requires WPS router)

 **NOTE:** Make sure you have installed the HP software that came with the printer and the printer network drives.

To connect the HP Officejet 4630 series to a wireless network using Wi-Fi Protected Setup (WPS), you will need the following:

- A wireless 802.11b/g/n network that includes a WPS-enabled wireless router or access point.

 **NOTE:** The HP Officejet 4630 series only supports connections using 2.4GHz.

- Routers that support WPS often have a (WPS) button.
- If you use WPS PIN method to set up the wireless connection, the computer must be connected to the wireless network that you intend to install the HP Officejet 4630 series on.

Push Button (PBC) method

1. Press and hold the **Wireless** button on the printer for at least 3 seconds until the wireless light starts blinking. When the light blinks, you have two minutes to press the WPS button on the router.
2. Press the Wi-Fi Protected Setup (WPS) button on your router.

 **NOTE:** The printer begins a timer for approximately two minutes while a wireless connection is established.

PIN method

1. Press the **Wireless** button on the printer control panel to display the Wireless menu. If the printer is printing, in an error state, or performing a critical task, wait until the task has been completed or the error cleared before pressing the **Wireless** button.
2. Select **Settings** from the printer display.
3. Select **Wi-Fi Protected Setup** from the printer display.
4. If prompted, select **PIN**, and then follow the on-screen instructions.

 **NOTE:** The printer begins a timer for approximately four minutes during which the corresponding button on the networking device needs to be pressed or the router PIN needs to be entered on the router's configuration page.

Traditional wireless connection (requires router)

To connect the HP Officejet 4630 series to an integrated wireless WLAN 802.11 network, you will need the following:

- A wireless 802.11b/g/n network that includes a wireless router or access point.



NOTE: The HP Officejet 4630 series only supports connections using 2.4GHz.

- The computer must be connected to the wireless network that you intend to install the HP Officejet 4630 series on.
- Network name (SSID).
- WEP key or WPA Passphrase (if needed).

To connect the printer

1. Press the **Wireless** button from the printer control panel, and then select **Settings**.
2. Scroll to select **Wireless Setup Wizard**, and then press **OK**.
3. Follow the on-screen instructions to set up the wireless connection.
4. Insert the printer software CD in the computer CD-ROM drive.
5. Follow the on-screen instructions to install the printer software.

To connect a new printer

If you have not connected the printer to your computer, or you want to connect another new printer of the same model to your computer, you can use the **Connect a new printer** function to set up the connection.



NOTE: Use this method if you have already installed the printer software.

1. Press the **Wireless** button from the printer control panel, and then select **Settings**.
2. Scroll to select **Wireless Setup Wizard**, and then press **OK**.
3. Follow the on-screen instructions to set up the wireless connection.
4. Depending on your operating system, do one of the following.
 - **Windows 8:** On the **Start** screen, right-click an empty area on the screen, click **All Apps** on the app bar.
 - **Windows 7, Windows Vista, and Windows XP:** From the computer desktop, click **Start**, select **All Programs**, click **HP**, and then click **HP Officejet 4630 series**.
5. Select **Printer Setup & Software**.
6. Select **Connect a new printer**. Follow the on-screen instructions.

Connect a new printer

1. In **System Preferences**, select **Print & Fax**.
2. Click **+** below the printer list on the left.
3. Select the new printer from the list.

To change network settings

To change the printer wireless settings, run the Wireless Setup Wizard.

To change more advanced settings,



NOTE: Only the person who manages your network can change the advanced settings.

1. Press the **Wireless** button from the printer control panel, and then select **Settings**.
2. Scroll to select **Advanced Settings**.
3. Select the item to be changed from the **Advanced Settings** menu.
4. Follow the on-screen instructions.

USB connection (non-network connection)

The HP Officejet 4630 series supports a rear USB 2.0 High Speed port for connection to a computer.



NOTE: Web services will not be available with a USB direct connection.

To connect the printer with the USB cable

1. Insert the printer software CD in the computer CD-ROM drive.



NOTE: Do not connect the USB cable to the printer until you are prompted to do so.

2. Follow the on-screen instructions. When you are prompted, connect the printer to the computer by selecting **USB** on the **Connection Options** screen.
3. Follow the on-screen instructions.

If the printer software has been installed, the printer will operate as a plug-and-play printer. If the software has not been installed, insert the CD that came with the printer and follow the on-screen instructions.

Change from a USB connection to a wireless network

If you first setup your printer and installed the software with a USB cable, directly connecting the printer to your computer, you can easily change to a wireless network connection. You will need a wireless 802.11b/g/n network that includes a wireless router or access point.



NOTE: The HP Officejet 4630 series only supports connections using 2.4GHz.

Before changing from a USB connection to a wireless network, make sure that:

- The printer is connected to your computer with the USB cable until you are prompted to disconnect the cable.
- The computer is connected to the wireless network that you intend to install the printer on.

To change from a USB connection to a wireless network

1. Depending on your operating system, do one of the following.
 - **Windows 8:** On the **Start** screen, right-click an empty area on the screen, click **All Apps** on the app bar.
 - **Windows 7, Windows Vista, and Windows XP:** From the computer desktop, click **Start**, select **All Programs**, click **HP**, and then click **HP Officejet 4630 series**.
2. Select **Printer Setup & Software**.
3. Select **Convert a USB connected printer to wireless**. Follow the on-screen instructions.

To change from a USB connection to a wireless network

1. Connect the printer to your wireless network.
2. Use **HP Setup Assistant** in **Applications/Hewlett-Packard/Device Utilities** to change the software connection to wireless for this printer.

Connect wirelessly to the printer without a router

HP wireless direct allows your Wi-Fi devices such as computers, smart phones, and tablets, to connect to your printer directly through Wi-Fi, using the process you currently use to connect your Wi-Fi device to new wireless networks and hotspots. With wireless direct, you can print directly to the printer wirelessly, without a wireless router, from your Wi-Fi enabled devices.

To connect wirelessly to the printer without a router

1. From the Home screen on the printer display, select **Wireless Direct**, and then press **OK**.
2. In the **Wireless Direct** menu, select **Wireless Direct**, and then press **OK**.
3. Using the buttons to the right, select **On without Security**, and then press **OK**.

 **TIP:** If you would like to use HP wireless direct with greater security and if the computer or mobile device supports WPA2 encryption, select the option that will enable security. With security enabled, only users with the password can connect wirelessly to the printer. Without enabling security, anyone with a wireless device within the wireless range of the printer can connect to the printer.

4. Press the button next to **Display Name** to display the wireless direct name.
5. If you have enabled security, press the button next to **Display Password** to display the wireless direct password.

 **TIP:** You can also turn on HP wireless direct from the embedded web server (EWS). For more information about using the EWS, see [To open the embedded Web server on page 89](#).

6. After connecting to wireless direct, you need to install the printer software if you use a desktop computer or laptop. If you use a mobile device, you need to install a compatible app on your mobile device. You can start to use the printer over wireless direct if you have already installed the printer over a network.

For more information about printing wirelessly, see [Print with HP wireless direct on page 17](#).

Tips for setting up and using a networked printer

Use the following tips to set up and use a networked printer:

- When the Wireless Setup Wizard on the printer is launched, the printer searches for wireless routers, and then lists the detected network names on the printer display.
- If your computer is connected to a Virtual Private Network (VPN), you need to disconnect from the VPN before you can access any other device on your network, including the printer.
- Learn how to find your network security settings. [Click here to go online for more information.](#)
- Learn about the HP Print and Scan Doctor. [Click here to go online for more information.](#)
- Learn about the network troubleshooting tips. [Click here to go online for more information.](#)
- Learn how to change from a USB to wireless connection. [Click here to go online for more information.](#)
- Learn how to work with your firewall and antivirus programs during printer setup. [Click here to go online for more information.](#)

Advanced printer management tools (for networked printers)

When the printer is connected to a network, you can use the embedded Web server to view status information, change settings, and manage the printer from your computer.

 **NOTE:** To view or change some settings, you might need a password.

You can open and use the embedded Web server without being connected to the Internet. However, some features are not available.

- [To open the embedded Web server](#)
- [About cookies](#)

To open the embedded Web server

You can access the embedded Web server through either the network or Wireless Direct.

Open the embedded Web server through network

 **NOTE:** The printer must be on a network and must have an IP address. The IP address for the printer can be found by pressing the **Wireless** button or by printing a network configuration page.

- In a supported Web browser on your computer, type the IP address or hostname that has been assigned to the printer.

For example, if the IP address is 192.168.0.12, type the following address into a Web browser: `http://192.168.0.12`.

To open the embedded Web server through Wireless Direct

1. Press the **Wireless** button from the printer control panel, and then select **Settings**.
2. If the display shows that wireless direct is **Off**, select **Wireless Direct** and then select **On with Security** or **On without Security**.
3. From your wireless computer, turn wireless on, search for and connect to the wireless direct name, for example: HP-Print-XX-Deskjet 3510 series. If you have wireless direct security on, enter the wireless direct password when prompted.
4. In a supported Web browser on your computer, type the following address: `http://192.168.223.1`.

About cookies

The embedded Web server (EWS) places very small text files (cookies) on your hard drive when you are browsing. These files let the EWS recognize your computer the next time you visit. For example, if you have configured the EWS language, a cookie helps remember which language you have selected so that the next time you access the EWS, the pages are displayed in that language. Some cookies (such as the cookie that stores customer-specific preferences) are stored on the computer until you clear them manually.

You can configure your browser to accept all cookies, or you can configure it to alert you every time a cookie is offered, which allows you to decide which cookies to accept or refuse. You can also use your browser to remove unwanted cookies.

 **NOTE:** Depending on your printer, if you disable cookies, you also disable one or more of the following features:

- Starting where you left the application (especially useful when using setup wizards)
- Remembering the EWS browser language setting
- Personalizing the EWS Home page

For information about how to change your privacy and cookie settings and how to view or delete cookies, see the documentation available with your Web browser.

10 Solve a problem

This section contains the following topics:

- [Clear a paper jam](#)
- [Improve print quality](#)
- [Unable to print](#)
- [Resolve copy and scan issues](#)
- [Resolve fax issues](#)
- [Resolve networking issues](#)
- [HP support](#)

Clear a paper jam

Clear a paper jam from the paper path.

To clear a paper jam from paper path

1. Open the cartridge access door.



2. Remove the cleanout.



3. Remove the jammed paper from the rear roller.

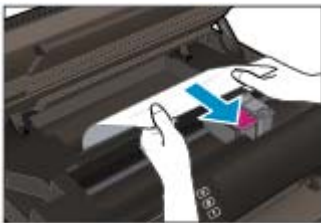

4. Place the cleanout back.



5. Close the cartridge access door.



6. Press the **OK** button on the control panel to continue the current job.

Clear a paper jam from the duplexer.

To clear a paper jam from duplexer

1. Open the cartridge access door.



2. Remove the cleanout.



3. Press on the hole of the duplexer path cover to lift it up. Remove the jammed paper.



4. Place the cleanout back.



5. Close the cartridge access door.



6. Press the **OK** button on the control panel to continue the current job.

Clear a paper jam from the print zone.

To clear a paper jam from print zone

1. Open the cartridge access door.



2. Remove the jammed paper from inside the printer.



3. Close the cartridge access door.



4. Press the **OK** button on the control panel to continue the current job.

Clear a jam in the automatic document feeder

To clear a jam in the automatic document feeder

1. Lift the cover of the ADF.



2. Lift the tab located on the front edge of the ADF.
3. Gently pull the paper out of the rollers.

CAUTION: If the paper tears when you are removing it from the rollers, check the rollers and wheels for torn pieces of paper that might remain inside the printer. If you do not remove all the pieces of paper from the printer, more paper jams are likely to occur.



4. Close the cover of the ADF, pressing down firmly until it snaps into place.
5. Press the **OK** button on the control panel to continue the current job.

If the above solutions do not resolve the problem, [click here for more online troubleshooting](#).

To prevent paper jams

- Do not overfill the paper tray.
- Remove printed papers from the paper tray frequently.
- Ensure that paper loaded in the paper tray lays flat and the edges are not bent or torn.
- Do not combine different paper types and paper sizes in the paper tray; the entire stack of paper in the paper tray must be the same size and type.
- Adjust the paper-width guides in the paper tray to fit snugly against all paper. Make sure the paper-width guides do not bend the paper in the paper tray.
- Do not force the paper too far forward in the paper tray.
- Do not add paper while the printer is printing. If the printer is about to run out of paper, wait until the out of paper message appears before adding paper.

If the above solutions do not resolve the problem, [click here for more online troubleshooting](#).

Clear the print carriage

Remove any objects, such as paper, that are blocking the print carriage.

See [Clear a paper jam on page 92](#) for more information.



NOTE: Do not use any tools or other devices to remove jammed paper. Always use caution when removing jammed paper from inside the printer.



[Click here to go online for more information.](#)

Improve print quality



NOTE: To protect the cartridges from drying out, always turn the printer off using the **On** button, and wait until the **On** button light goes out.

1. Make sure you are using Original HP ink cartridges and HP recommended papers.

For more information, see [Recommended papers for printing on page 26](#).

2. Check the printer software to make sure you have selected the appropriate paper type from the **Media** drop-down list and print quality from the **Quality Settings** drop-down list.

In the printer software, click **Print, Scan & Fax** and then click **Set Preferences** to access the print properties.

3. Check the estimated ink levels to determine if the cartridges are low on ink.

For more information, see [Check the estimated ink levels on page 72](#). If the ink cartridges are low on ink consider replacing them.

4. Align the cartridges.

To align the cartridges from the printer software



NOTE: Aligning the cartridges ensures the high-quality output. The printer prompts you to align the cartridges every time you install a new cartridge. If you remove and reinstall the same ink cartridge, the HP All-in-One will not prompt you to align the ink cartridges. The HP All-in-One remembers the alignment values for that ink cartridge, so you do not need to realign the ink cartridges.

- a. Load letter or A4 unused plain white paper into the paper tray.
- b. Depending on your operating system, do one of the following to open the printer software:
 - **Windows 8:** On the **Start** screen, right-click an empty area on the screen, click **All Apps** on the app bar, and then click the icon with the printer's name.
 - **Windows 7, Windows Vista, and Windows XP:** From the computer desktop, click **Start**, select **All Programs**, click **HP**, click **HP Officejet 4630 series**, and then click **HP Officejet 4630 series**.
- c. In the printer software, click **Print, Scan & Fax**, and then click **Maintain Your Printer** to access the **Printer Toolbox**.
- d. The **Printer Toolbox** appears.
- e. Click **Align Ink Cartridges** on the **Device Services** tab. The printer prints an alignment sheet.

- f. Load the cartridge alignment sheet print side down on the right front corner of the scanner glass.

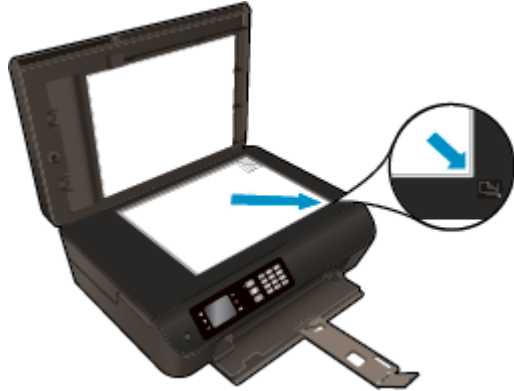

- g. Follow the instructions on the printer display to align the cartridges. Recycle or discard the cartridge alignment sheet.

To align the cartridges from the printer display

- a. From the Home screen on the printer display, press the **Up** and **Down** buttons to select **Tools**, and then press **OK**.



NOTE: If you do not see the Home screen, press the **Home** button.

- b. From the **Tools** menu on the printer display, select **Align Printer**. Follow the on-screen instructions.

5. Print a diagnostics page if the cartridges are not low on ink.

To print a diagnostics page from the printer software

- a. Load letter or A4 unused plain white paper into the paper tray.
- b. Depending on your operating system, do one of the following to open the printer software:
- **Windows 8:** On the **Start** screen, right-click an empty area on the screen, click **All Apps** on the app bar, and then click the icon with the printer's name.
 - **Windows 7, Windows Vista, and Windows XP:** From the computer desktop, click **Start**, select **All Programs**, click **HP**, click **HP Officejet 4630 series**, and then click **HP Officejet 4630 series**.
- c. In the printer software, click **Print, Scan & Fax**, and then click **Maintain Your Printer** to access the printer toolbox.

- d. Click **Print Diagnostic Information** on the **Device Reports** tab to print a diagnostics page. Review the blue, magenta, yellow, and black boxes on the diagnostics page. If you are seeing streaks in the color and black boxes, or no ink in portions of the boxes, then automatically clean the cartridges.

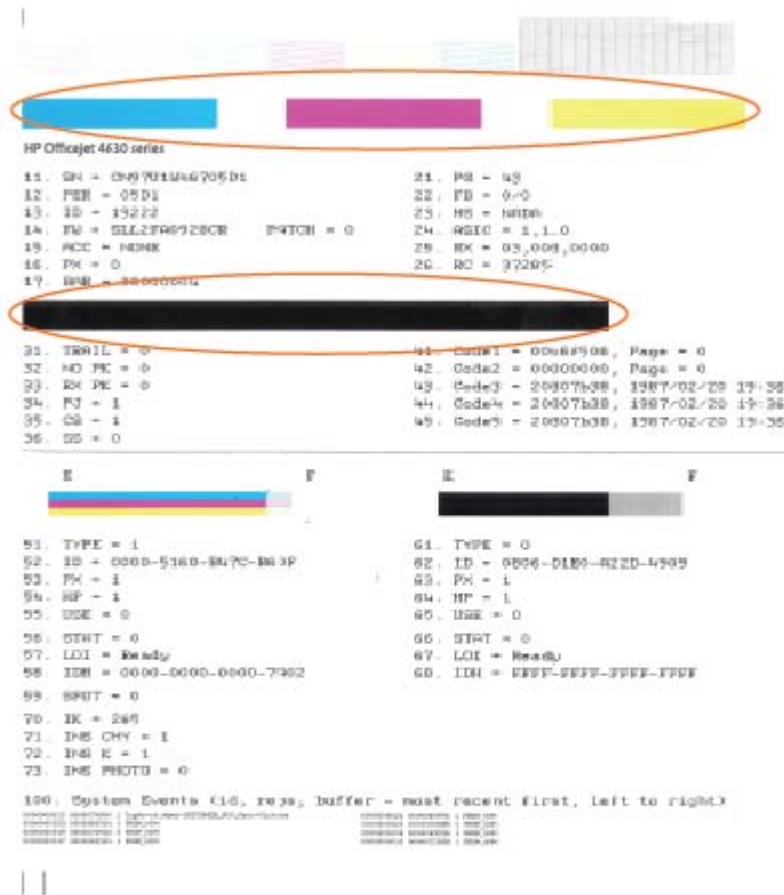

To print a diagnostics page from the printer display

- a. From the Home screen on the printer display, press the **Up** and **Down** buttons to select **Tools**, and then press **OK**.



NOTE: If you do not see the Home screen, press the **Home** button.

- b. From the **Tools** menu on the printer display, select **Print Quality Report**. Follow the on-screen instructions.
6. Clean the ink cartridges automatically, if the diagnostic page shows streaks or missing portions of the color and black boxes.

To clean the cartridges from the printer software

- a. Load letter or A4 unused plain white paper into the paper tray.
- b. Depending on your operating system, do one of the following to open the printer software:
 - **Windows 8:** On the **Start** screen, right-click an empty area on the screen, click **All Apps** on the app bar, and then click the icon with the printer's name.
 - **Windows 7, Windows Vista, and Windows XP:** From the computer desktop, click **Start**, select **All Programs**, click **HP**, click **HP Officejet 4630 series**, and then click **HP Officejet 4630 series**.
- c. In the printer software, click **Print, Scan & Fax**, and then click **Maintain Your Printer** to access the **Printer Toolbox**.
- d. Click **Clean Ink Cartridges** on the **Device Services** tab. Follow the on-screen instructions.

To clean the cartridges from the printer display

- a. From the Home screen on the printer display, press the **Up** and **Down** buttons to select **Tools**, and then press **OK**.



NOTE: If you do not see the Home screen, press the **Home** button.

- b. From the **Tools** menu on the printer display, select **Clean Printhead**. Follow the on-screen instructions.

To improve print quality

1. Make sure you are using original HP cartridges.
2. Make sure you have selected the appropriate paper type and print quality in the **Print** dialog.
3. Check the estimated ink levels to determine if the cartridges are low on ink.
Consider replacing the print cartridges if they are low on ink.
4. Align the printer cartridges

To align print cartridges from the software

- a. Load Letter or A4 plain, white paper in the paper tray.
- b. Open HP Utility.



NOTE: HP Utility is located in the **Hewlett-Packard** folder in the **Applications** folder at the top level of the hard disk.

- c. Select the HP Officejet 4630 series from the list of devices at the left of the window.
 - d. Click **Align**.
 - e. Click **Align** and follow the on-screen instructions.
 - f. Click **All Settings** to return to the **Information and Support** pane.
5. Print a test page.

To print a test page

- a. Load Letter or A4 plain, white paper in the paper tray.
- b. Open HP Utility.



NOTE: HP Utility is located in the **Hewlett-Packard** folder in the **Applications** folder at the top level of the hard disk.

- c. Select the HP Officejet 4630 series from the list of devices at the left of the window.
- d. Click **Test Page**.
- e. Click the **Print Test Page** button, and follow the on-screen instructions.

Check the test page for jagged lines in the text or streaks in the text and colored boxes. If you are seeing jagged lines, or streaks, or no ink in portions of the boxes, then automatically clean the cartridges.

6. If the diagnostic page shows streaks or missing portions of the text or colored boxes, clean the print cartridges automatically.

To automatically clean the print head

- a. Load Letter or A4 plain, white paper in the paper tray.
- b. Open HP Utility.



NOTE: HP Utility is located in the **Hewlett-Packard** folder in the **Applications** folder at the top level of the hard disk.

- c. Select the HP Officejet 4630 series from the list of devices at the left of the window.
- d. Click **Clean Printheads**.
- e. Click **Clean**, and follow the on-screen instructions.



CAUTION: Clean the print head only when necessary. Unnecessary cleaning wastes ink and shortens the life of the print head.



NOTE: If print quality still seems poor after you complete cleaning, try aligning the printer. If print quality problems persist after cleaning and aligning, contact HP support.

- f. Click **All Settings** to return to the **Information and Support** pane.

If the above solutions do not resolve the problem, [click here for more online troubleshooting](#).

Unable to print

If you're having trouble printing, you can download the HP Print and Scan Doctor, which can troubleshoot this issue for you automatically. To get the utility, click the appropriate link:



NOTE: The HP Print and Scan Doctor may not be available in all languages.

[Take me to the HP Print and Scan Doctor download page.](#)

To resolve print issues



NOTE: Make sure that the printer is turned on and that there is paper in the tray. If you are still unable to print, try the following in order:

1. Check for error messages from the printer display and resolve them by following the on-screen instructions.
2. If your computer is connected to the printer with a USB cable, disconnect and reconnect the USB cable. If your computer is connected to the printer with a wireless connection, confirm that the connection is working.
3. Verify that the printer is not paused or offline.

To verify that the printer is not paused or offline

- a. Depending on your operating system, do one of the following.
 - **Windows 8:** Point to or tap the upper-right corner of the screen to open the Charms bar, click the **Settings** icon, click or tap **Control Panel**, and then click or tap **View devices and printers**.
 - **Windows 7:** From the Windows **Start** menu, click **Devices and Printers**.
 - **Windows Vista:** From the Windows **Start** menu, click **Control Panel**, and then click **Printers**.
 - **Windows XP:** From the Windows **Start** menu, click **Control Panel**, and then click **Printers and Faxes**.
- b. Either double-click the icon for your printer or right-click the icon for your printer and select **See what's printing** to open the print queue.
- c. On the **Printer** menu, make sure there are no check marks next to **Pause Printing** or **Use Printer Offline**.
- d. If you make any changes, try to print again.
4. Verify that the printer is set as the default printer.

To verify that the printer is set as the default printer

- a. Depending upon your operating system, do one of the following:
 - **Windows 8:** Point to or tap the upper-right corner of the screen to open the Charms bar, click the **Settings** icon, click or tap **Control Panel**, and then click or tap **View devices and printers**.
 - **Windows 7:** From the Windows **Start** menu, click **Devices and Printers**.

- **Windows Vista:** From the Windows **Start** menu, click **Control Panel**, and then click **Printers**.
 - **Windows XP:** From the Windows **Start** menu, click **Control Panel**, and then click **Printers and Faxes**.
- b. Make sure the correct printer is set as the default printer.
The default printer has a check mark in a black or green circle next to it.
 - c. If the wrong printer is set as the default printer, right-click the correct printer and select **Set as Default Printer**.
 - d. Try using your printer again.
5. Restart the print spooler.

To restart the print spooler

- a. Depending upon your operating system, do one of the following:

Windows 8

- i. Point to or tap the upper-right corner of the screen to open the Charms bar, and then click the **Settings** icon.
- ii. Click or tap **Control Panel**, and then click or tap **System and Security**.
- iii. Click or tap **Administrative Tools**, and then double-click or double-tap **Services**.
- iv. Right-click or touch and hold **Print Spooler**, and then click **Properties**.
- v. On the **General** tab, next to **Startup type**, make sure that **Automatic** is selected.
- vi. If the service is not already running, under **Service status**, click or tap **Start**, and then click or tap **OK**.

Windows 7

- i. From the Windows **Start** menu, click **Control Panel**, **System and Security**, and then **Administrative Tools**.
- ii. Double-click **Services**.
- iii. Right-click the **Print Spooler**, and then click **Properties**.
- iv. On the **General** tab, next to **Startup type**, make sure that **Automatic** is selected.
- v. If the service is not already running, under **Service status**, click **Start**, and then click **OK**.

Windows Vista

- i. From the Windows **Start** menu, click **Control Panel**, **System and Maintenance**, **Administrative Tools**.
- ii. Double-click **Services**.
- iii. Right-click the **Print Spooler service**, and then click **Properties**.

- iv. On the **General** tab, next to **Startup type**, make sure that **Automatic** is selected.
- v. If the service is not already running, under **Service status**, click **Start**, and then click **OK**.

Windows XP

- i. From the Windows **Start** menu, right click **My Computer**.
 - ii. Click **Manage**, and then click **Services and Applications**.
 - iii. Double-click **Services**, and then select **Print Spooler**.
 - iv. Right-click **Print Spooler**, and click **Restart** to restart the service.
- b. Make sure the correct printer is set as the default printer.
- The default printer has a check mark in a black or green circle next to it.
- c. If the wrong printer is set as the default printer, right-click the correct printer and select **Set as Default Printer**.
 - d. Try using your printer again.
6. Restart the computer.
7. Clear the print queue.

To clear the print queue

- a. Depending upon your operating system, do one of the following:
 - **Windows 8:** Point to or tap the upper-right corner of the screen to open the Charms bar, click the **Settings** icon, click or tap **Control Panel**, and then click or tap **View devices and printers**.
 - **Windows 7:** From the Windows **Start** menu, click **Devices and Printers**.
 - **Windows Vista:** From the Windows **Start** menu, click **Control Panel**, and then click **Printers**.
 - **Windows XP:** From the Windows **Start** menu, click **Control Panel**, and then click **Printers and Faxes**.
- b. Double-click the icon for your printer to open the print queue.
- c. On the **Printer** menu, click **Cancel all documents** or **Purge Print Document**, and then click **Yes** to confirm.
- d. If there are still documents in the queue, restart the computer and try printing again after the computer has restarted.
- e. Check the print queue again to make sure it is clear, and then try to print again.

Resolve print issues

1. Check for error messages and resolve.
2. Disconnect and reconnect the USB cable.
3. Verify that the product is not paused or offline.

To verify that the product is not paused or offline

- a. In **System Preferences**, click **Print & Fax**.
- b. Click the **Open Print Queue** button.
- c. Click a print job to select it.

Use the following buttons to manage the print job:

- **Delete:** Cancel the selected print job.
- **Hold:** Pause the selected print job.
- **Resume:** Continue a paused print job.
- **Pause Printer:** Pause all print jobs in the print queue.

- d. If you made any changes, try to print again.

4. Restart the computer.

To check the power connection and reset the printer

1. Make sure the power cord is firmly connected to the printer.

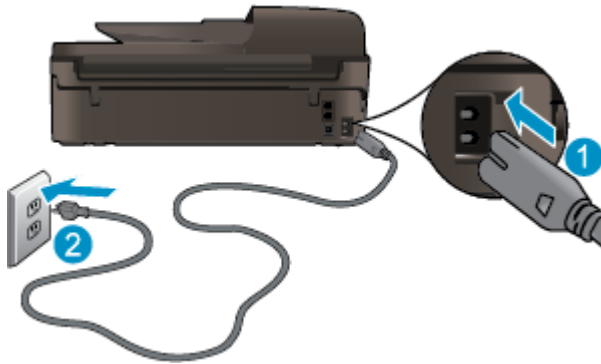

-
- | | |
|---|---------------------------------|
| 1 | Power connection to the printer |
| 2 | Connection to a power outlet |
-

2. Look inside the printer and check for a green light indicating the printer is receiving electrical power. If it is not lit, make sure the cord is fully plugged into the printer, or connect to another power outlet.
3. Look at the On button located on the printer. If it is not lit, the printer is turned off. Press the On button to turn on the printer.



NOTE: If the printer is not receiving electrical power, connect it to another power outlet.

4. With the printer turned on, disconnect the power cord from the side of the printer under the cartridge access door.
5. Unplug the power cord from the wall outlet.
6. Wait at least 15 seconds.
7. Plug the power cord back into the wall outlet.

8. Reconnect the power cord to the side of the printer under the cartridge access door.
9. If the printer does not turn on by itself, press the On button to turn on the printer.
10. Try using the printer again.

If the above solutions do not resolve the problem, [click here for more online troubleshooting](#).

Resolve copy and scan issues

HP provides an HP Print and Scan Doctor (Windows only) that can help solve many common “Unable to scan” issues. To get the utility, click the appropriate link:



NOTE: The HP Print and Scan Doctor may not be available in all languages.

[Take me to the HP Print and Scan Doctor download page.](#)

Learn more about how to solve scan issues. [Click here to go online for more information.](#)

Learn how to solve copy issues. [Click here to go online for more information.](#)

Resolve fax issues

If you are having faxing problems, you can print a fax test report to check the status of the printer. The test fails if the printer is not set up correctly for faxing. Perform this test after you have completed setting up the printer for faxing. For more information, see [Test fax setup on page 163](#).

Learn more about how to solve fax issues. [Click here to go online for more information](#).

For further assistance, visit the HP online support website: www.hp.com/support.

Resolve networking issues

- Learn how to find your network security settings. [Click here to go online for more information.](#)
- Learn about the HP Print and Scan Doctor. [Click here to go online for more information.](#)
- Learn about the network troubleshooting tips. [Click here to go online for more information.](#)
- Learn how to change from a USB to wireless connection. [Click here to go online for more information.](#)
- Learn how to work with your firewall and antivirus programs during printer setup. [Click here to go online for more information.](#)

HP support

- [Register printer](#)
- [Support process](#)
- [HP support by phone](#)
- [Additional warranty options](#)

Register printer

By taking just a few quick minutes to register, you can enjoy quicker service, more efficient support, and product support alerts. If you did not register your printer while installing the software, you can register now at <http://www.register.hp.com>.

Support process

If you have a problem, follow these steps:

1. Check the documentation that came with the printer.
2. Visit the HP online support website at www.hp.com/support.

HP online support is available to all HP customers. It is the fastest source for up-to-date product information and expert assistance, and includes the following features:

- Fast access to qualified online support specialists
 - Software and driver updates for the printer
 - Valuable troubleshooting information for common problems
 - Proactive printer updates, support alerts, and HP newsgrams that are available when you register the printer
3. Call HP support.

Support options and availability vary by printer, country/region, and language.

HP support by phone

Phone support options and availability vary by printer, country/region, and language.

This section contains the following topics:

- [Phone support period](#)
- [Placing a call](#)
- [Support phone numbers](#)
- [After the phone support period](#)

Phone support period

One year of phone support is available in North America, Asia Pacific, and Latin America (including Mexico). To determine the duration of phone support in Europe, the Middle East, and Africa, go to www.hp.com/support. Standard phone company charges apply.

Placing a call

Call HP support while you are in front of the computer and the printer. Be prepared to provide the following information:

- Product name (Located on the printer, such as HP Officejet 4630)
- Product number (located inside the cartridge access door)



- Serial number (located on the back or bottom of the printer)
- Messages that appear when the situation occurs
- Answers to these questions:
 - Has this situation happened before?
 - Can you recreate it?
 - Did you add any new hardware or software to your computer at about the time that this situation began?
 - Did anything else occur prior to this situation (such as a thunderstorm, the printer was moved, etc.)?

Support phone numbers

For the most current HP list of telephone support numbers and call costs information, see www.hp.com/support.

After the phone support period

After the phone support period, help is available from HP at an additional cost. Help may also be available at the HP online support website: www.hp.com/support. Contact your HP dealer or call the support phone number for your country/region to learn more about support options.

Additional warranty options

Extended service plans are available for the HP Officejet 4630 series at additional costs. Go to www.hp.com/support, select your country/region and language, then explore the services and warranty area for information about the extended service plans.

Prepare paper trays

To open paper tray

- ▲ Paper tray must be open to begin printing.



To close cartridge access door

- ▲ Cartridge door must be closed to begin printing.



 [Click here to go online for more information.](#)

Printer failure

To resolve printer failure

- ▲ Turn the printer off, then on. If that does not resolve the problem, contact HP.

 [Please contact HP support for help.](#)

Resolve ink cartridge problem

First try removing and reinserting the cartridges. If this does not work, clean the cartridge contacts. If your problem is still not resolved, see [Replace the cartridges on page 75](#) for more information.

To clean the ink cartridge contacts

⚠ CAUTION: The cleaning procedure should take only a few minutes. Make sure that the ink cartridges are reinstalled in the printer as soon as possible. It is not recommended to leave the ink cartridges outside of the printer longer than 30 minutes. This could result in damage to the printhead or the ink cartridges.

1. Check that power is on.
2. Open the cartridge access door.



Wait for the print carriage to move to the right side of the printer.

3. Remove the cartridge indicated in the error message.

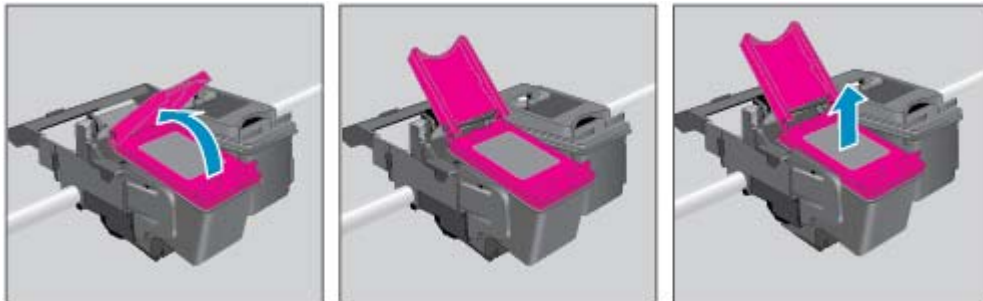

4. Hold the ink cartridge by its sides with the bottom pointing up and locate the electrical contacts on the ink cartridge. The electrical contacts are the small gold-colored dots on the cartridge.

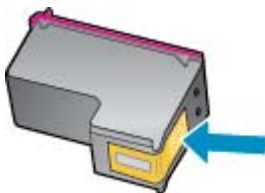

5. Wipe only the contacts with a dry swab or lint-free cloth.

⚠ CAUTION: Be careful to wipe only the contacts, and do not smear any of the ink or other debris elsewhere on the cartridge.

6. On the inside of the printer, locate the contacts in the printhead. The contacts look like a set of gold-colored bumps positioned to meet the contacts on the ink cartridge.

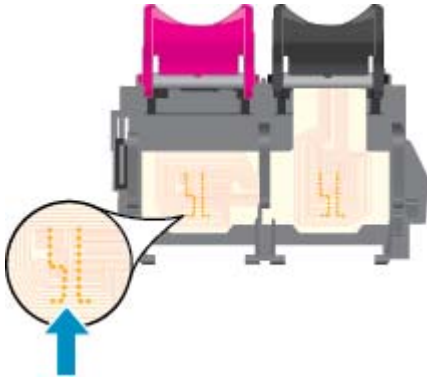

7. Use a dry swab or lint-free cloth to wipe the contacts.
8. Reinstall the ink cartridge.
9. Close the cartridge access door, and check if the error message has gone away.
10. If you still receive the error message, turn the printer off, and then on again.



NOTE: If one ink cartridge is causing problems, you can remove it and use the single-cartridge mode to operate the HP Officejet 4630 series with only one cartridge.

 [Click here to go online for more information.](#)

Ink cartridge problem

The ink cartridge is not compatible with your printer. This error can occur if you install an HP Instant Ink cartridge into a printer that has not been enrolled in the HP Instant Ink program. It can also occur if the HP Instant Ink cartridge was previously used in a different printer enrolled in the HP Instant Ink program.

Visit the [HP Instant Ink program](#) website for more information.

Older generation cartridges

You will need to use a newer version of this cartridge. In most cases you can identify a newer version of the cartridge by looking at the exterior of the cartridge package and finding the Warranty Ends date.



If it says 'v1' several spaces to the right of the date, then the cartridge is the updated newer version. If it is an older generation cartridge, contact HP support for help or replacement.

 [Click here to go online for more information.](#)

A Technical information

The technical specifications and international regulatory information for the HP Officejet 4630 series are provided in this section.

For additional specifications, see the printed documentation that came with the HP Officejet 4630 series.

This section contains the following topics:

- [Hewlett-Packard Company notices](#)
- [Specifications](#)
- [Environmental product stewardship program](#)
- [Regulatory notices](#)

Hewlett-Packard Company notices

The information contained herein is subject to change without notice.

All rights reserved. Reproduction, adaptation, or translation of this material is prohibited without prior written permission of Hewlett-Packard, except as allowed under the copyright laws. The only warranties for HP products and services are set forth in the express warranty statements accompanying such products and services. Nothing herein should be construed as constituting an additional warranty. HP shall not be liable for technical or editorial errors or omissions contained herein.

© 2012 Hewlett-Packard Development Company, L.P.

Microsoft®, Windows®, Windows® XP, Windows Vista®, Windows® 7 and Windows® 8 are U.S. registered trademarks of Microsoft Corporation.

Specifications

Technical specifications for the HP Officejet 4630 series are provided in this section. For more product specifications, see the Product Data Sheet at www.hp.com/support.

- [System requirements](#)
- [Environmental specifications](#)
- [Input tray capacity](#)
- [Output tray capacity](#)
- [Paper size](#)
- [Paper weights](#)
- [Print specifications](#)
- [Copy specifications](#)
- [Scan specifications](#)
- [Fax specifications](#)
- [Print resolution](#)
- [Power safety](#)
- [Cartridge yield](#)
- [Acoustic information](#)

System requirements

Software and system requirements are located in the Readme file.

For information about future operating system releases and support, visit the HP online support website at www.hp.com/support.

Environmental specifications

- Recommended operating temperature range: 15°C to 32°C (59°F to 90°F)
- Allowable operating temperature range: 5°C to 40°C (41°F to 104°F)
- Humidity: 15% to 80% RH non-condensing; 28°C maximum dewpoint
- Nonoperating (Storage) temperature range: -40°C to 60°C (-40°F to 140°F)
- In the presence of high electromagnetic fields, it is possible the output from the HP Officejet 4630 series may be slightly distorted
- HP recommends using a USB cable less than or equal to 3 m (10 feet) in length to minimize injected noise due to potential high electromagnetic fields

Input tray capacity

Plain paper sheets (80 g/m² [20lb]): Up to 50

Envelopes: Up to 5

Index cards: Up to 20

Photo paper sheets: Up to 20

Output tray capacity

Plain paper sheets (80 g/m² [20lb]): Up to 20

Envelopes: Up to 5

Index cards: Up to 10

Photo paper sheets: Up to 10

Paper size

For a complete list of supported media sizes, see the printer software.

Paper weights

Plain Paper: 64 to 90 g/m² (16 to 24 lb)

Envelopes: 75 to 90 g/m² (20 to 24 lb)

Cards: Up to 200 g/m² (110-lb index maximum)

Photo Paper: Up to 280 g/m² (75 lb)

Print specifications

- Print speeds vary according to the complexity of the document
- Method: drop-on-demand thermal inkjet
- Language: PCL3 GUI

Copy specifications

- Digital image processing
- Copy speeds vary according to the complexity of the document and model
- Resolution for photo paper copy: up to 600 dpi

Scan specifications

- Optical resolution: up to 1200 dpi
- Hardware resolution: up to 1200 x 1200 dpi
- Enhanced resolution: up to 1200 x 1200 dpi
- Bitdepth: 24-bit color, 8-bit grayscale (256 levels of gray)
- Maximum scan size from the scanner glass: 21.6 x 29.7 cm (8.5 x 11.7 inches)

- Supported file types: BMP, JPEG, PNG, TIFF, PDF
- Twain version: 1.9

Fax specifications

- Send/Receive black-and-white or color faxes.
- Up to 99 speed dials.
- Up to 99-page memory (based on ITU-T Test Image #1 at standard resolution). More complicated pages or higher resolution takes longer and uses more memory.
- Manual fax send and receive.
- Automatic busy redial up to five times (varies by model).
- Automatic no-answer redial one time or two times (varies by model).
- Confirmation and activity reports.
- CCITT/ITU Group 3 fax with Error Correction Mode.
- 33.6 Kbps transmission.
- 4 seconds per page speed at 33.6 Kbps (based on ITU-T Test Image #1 at standard resolution). More complicated pages or higher resolution takes longer and uses more memory.
- Ring detect with automatic fax/answering machine switching.

| | Fine (dpi) | Standard (dpi) |
|-------|------------|----------------|
| Black | 208 x 196 | 208 x 98 |
| Color | 208 x 200 | 208 x 200 |

Print resolution

Draft mode

- Color Input/Black Render: 300x300dpi
- Output (Black/Color): Automatic

Normal mode

- Color Input/Black Render: 600x300dpi
- Output (Black/Color): Automatic

Plain-Best mode

- Color Input/Black Render: 600x600dpi
- Automatic

Photo-Best mode

- Color Input/Black Render: 600x600dpi
- Output (Black/Color): Automatic

Max DPI mode

- Color Input/Black Render: 1200x1200dpi
- Output: Automatic (Black), 4800x1200 optimized dpi (Color)

Power safety



NOTE: Use only with the power cord supplied by HP.

Cartridge yield

Visit www.hp.com/go/learnaboutsupplies for more information on estimated cartridge yields.

Acoustic information

If you have Internet access, you can get acoustic information from the HP website. Go to: www.hp.com/support.

Environmental product stewardship program

Hewlett-Packard is committed to providing quality products in an environmentally sound manner. Design for recycling has been incorporated into this product. The number of materials has been kept to a minimum while ensuring proper functionality and reliability. Dissimilar materials have been designed to separate easily. Fasteners and other connections are easy to locate, access, and remove using common tools. High priority parts have been designed to access quickly for efficient disassembly and repair.

For more information, visit HP's Commitment to the Environment website at:

www.hp.com/hpinfo/globalcitizenship/environment/index.html

- [Eco-Tips](#)
- [Paper use](#)
- [Plastics](#)
- [Material safety data sheets](#)
- [Recycling program](#)
- [HP inkjet supplies recycling program](#)
- [Power consumption](#)
- [Sleep mode](#)
- [Disposal of waste equipment by users](#)
- [Chemical substances](#)
- [Toxic and hazardous substance table \(China\)](#)
- [Restriction of hazardous substance \(Ukraine\)](#)
- [Restriction of hazardous substance \(India\)](#)
- [Battery disposal in the Netherlands](#)
- [Battery disposal in the Taiwan](#)
- [California Perchlorate Material Notice](#)

Eco-Tips

HP is committed to helping customers reduce their environmental footprint. Please visit the HP Environmental Programs and Initiatives website for more information on HP's environmental initiatives.

www.hp.com/hpinfo/globalcitizenship/environment/

Paper use

This product is suited for the use of recycled paper according to DIN 19309 and EN 12281:2002.

Plastics

Plastic parts over 25 grams are marked according to international standards that enhance the ability to identify plastics for recycling purposes at the end of product life.

Material safety data sheets

Material safety data sheets (MSDS) can be obtained from the HP website at:

www.hp.com/go/msds

Recycling program

HP offers an increasing number of product return and recycling programs in many countries/regions, and partners with some of the largest electronic recycling centers throughout the world. HP conserves resources by reselling some of its most popular products. For more information regarding recycling of HP products, please visit:

www.hp.com/hpinfo/globalcitizenship/environment/recycle/

HP inkjet supplies recycling program

HP is committed to protecting the environment. The HP Inkjet Supplies Recycling Program is available in many countries/regions, and lets you recycle used print cartridges and ink cartridges free of charge. For more information, go to the following website:

www.hp.com/hpinfo/globalcitizenship/environment/recycle/

Power consumption

Hewlett-Packard printing and imaging equipment marked with the ENERGY STAR® logo is qualified to the U.S. Environmental Protection Agency's ENERGY STAR specifications for imaging equipment. The following mark will appear on ENERGY STAR qualified imaging products:



Additional ENERGY STAR qualified imaging product model information is listed at: www.hp.com/go/energystar

Sleep mode

Power usage is reduced while in Sleep mode.

After initial setup of printer, the printer will enter Sleep mode after 5 minutes of inactivity.

To change the time to Sleep mode

1. From the Home screen on the printer display, select **Preferences**.
2. Select **Sleep**, and then select the desired option.

Disposal of waste equipment by users



This symbol means do not dispose of your product with your other household waste. Instead, you should protect human health and the environment by handing over your waste equipment to a designated collection point for the recycling of waste electrical and electronic equipment. For more information, please contact your household waste disposal service, or go to <http://www.hp.com/recycle>.

Chemical substances

HP is committed to providing our customers with information about the chemical substances in our products as needed to comply with legal requirements such as REACH (*Regulation EC No 1907/2006 of the European Parliament and the Council*). A chemical information report for this product can be found at: www.hp.com/go/reach.

Toxic and hazardous substance table (China)

| 有毒有害物质表 | | | | | | |
|----------------------|-----------|---|---|-----|------|-------|
| 根据中国《电子信息产品污染控制管理办法》 | | | | | | |
| 零件描述 | 有毒有害物质和元素 | | | | | |
| | 铅 | 汞 | 镉 | 六价铬 | 多溴联苯 | 多溴联苯醚 |
| 外壳和托盘* | 0 | 0 | 0 | 0 | 0 | 0 |
| 电缆* | 0 | 0 | 0 | 0 | 0 | 0 |
| 印刷电路板* | X | 0 | 0 | 0 | 0 | 0 |
| 打印系统* | X | 0 | 0 | 0 | 0 | 0 |
| 显示屏* | X | 0 | 0 | 0 | 0 | 0 |
| 喷墨打印机墨盒* | 0 | 0 | 0 | 0 | 0 | 0 |
| 驱动光盘* | X | 0 | 0 | 0 | 0 | 0 |
| 扫描仪* | X | X | 0 | 0 | 0 | 0 |
| 网络配件* | X | 0 | 0 | 0 | 0 | 0 |
| 电池板* | X | 0 | 0 | 0 | 0 | 0 |
| 自动双面打印系统* | 0 | 0 | 0 | 0 | 0 | 0 |
| 外部电源* | X | 0 | 0 | 0 | 0 | 0 |

0: 指此零件的所有均一材质中包含的这种有毒有害物质, 含量低于SJ/T11363-2006 的限制
X: 指此零件使用的均一材质中至少有一种包含的这种有毒有害物质, 含量高于SJ/T11363-2006 的限制
注: 环保使用期限的参考标识取决于产品正常工作的温度和湿度等条件
*以上只适用于使用这些零件的产品

Restriction of hazardous substance (Ukraine)

Технічний регламент щодо обмеження використання небезпечних речовин (Україна)

Обладнання відповідає вимогам Технічного регламенту щодо обмеження використання деяких небезпечних речовин в електричному та електронному обладнанні, затвердженого постановою Кабінету Міністрів України від 3 грудня 2008 № 1057

Restriction of hazardous substance (India)

Restriction of hazardous substances (India)

This product complies with the "India E-waste (Management and Handling) Rule 2011" and prohibits use of lead, mercury, hexavalent chromium, polybrominated biphenyls or polybrominated diphenyl ethers in concentrations exceeding 0.1 weight % and 0.01 weight % for cadmium, except for the exemptions set in Schedule 2 of the Rule.

Battery disposal in the Netherlands



Dit HP Product bevat een lithium-manganees-dioxide batterij. Deze bevindt zich op de hoofdprintplaat. Wanneer deze batterij leeg is, moet deze volgens de geldende regels worden afgevoerd.

Battery disposal in the Taiwan



廢電池請回收

Please recycle waste batteries.

California Perchlorate Material Notice

California Perchlorate Material Notice

Perchlorate material - special handling may apply. See:
<http://www.dtsc.ca.gov/hazardouswaste/perchlorate/>

This product's real-time clock battery or coin cell battery may contain perchlorate and may require special handling when recycled or disposed of in California.

Regulatory notices

The HP Officejet 4630 series meets product requirements from regulatory agencies in your country/region.

This section contains the following topics:

- [Regulatory model identification number](#)
- [FCC statement](#)
- [Notice to users in Korea](#)
- [VCCI \(Class B\) compliance statement for users in Japan](#)
- [Notice to users in Japan about the power cord](#)
- [Noise emission statement for Germany](#)
- [European Union Regulatory Notice](#)
- [Visual display workplaces statement for Germany](#)
- [Declaration of conformity](#)
- [Regulatory wireless statements](#)
- [Notice to users of the U.S. telephone network: FCC requirements](#)
- [Notice to users of the Canadian telephone network](#)
- [Notice to users in the European Economic Area](#)
- [Notice to users of the German telephone network](#)
- [Australia wired fax statement](#)

Regulatory model identification number

For regulatory identification purposes, your product is assigned a Regulatory Model Number. The Regulatory Model Number for your product is SNPRH-1201. This regulatory number should not be confused with the marketing name (HP Officejet 4630 e-All-in-One series, etc.) or product numbers (B4L03A, B4L03B, etc.).

FCC statement

FCC statement

The United States Federal Communications Commission (in 47 CFR 15.105) has specified that the following notice be brought to the attention of users of this product.

This equipment has been tested and found to comply with the limits for a Class B digital device, pursuant to Part 15 of the FCC Rules. These limits are designed to provide reasonable protection against harmful interference in a residential installation. This equipment generates, uses and can radiate radio frequency energy and, if not installed and used in accordance with the instructions, may cause harmful interference to radio communications. However, there is no guarantee that interference will not occur in a particular installation. If this equipment does cause harmful interference to radio or television reception, which can be determined by turning the equipment off and on, the user is encouraged to try to correct the interference by one or more of the following measures:

- Reorient or relocate the receiving antenna.
- Increase the separation between the equipment and the receiver.
- Connect the equipment into an outlet on a circuit different from that to which the receiver is connected.
- Consult the dealer or an experienced radio/TV technician for help.

For further information, contact:

Manager of Corporate Product Regulations
Hewlett-Packard Company
3000 Hanover Street
Palo Alto, Ca 94304
(650) 857-1501

Modifications (part 15.21)

The FCC requires the user to be notified that any changes or modifications made to this device that are not expressly approved by HP may void the user's authority to operate the equipment.

This device complies with Part 15 of the FCC Rules. Operation is subject to the following two conditions: (1) this device may not cause harmful interference, and (2) this device must accept any interference received, including interference that may cause undesired operation.

Notice to users in Korea

| | |
|------------------------|--|
| B 급 기기 (가정용 방송통신기기) | 이 기기는 가정용(B급)으로 전자파적합등록을 한 기기로서 주로 가정에서 사용하는 것을 목적으로 하며, 모든 지역에서 사용할 수 있습니다. |
|------------------------|--|

VCCI (Class B) compliance statement for users in Japan

この装置は、クラスB情報技術装置です。この装置は、家庭環境で使用することを目的としていますが、この装置がラジオやテレビジョン受信機に近接して使用されると、受信障害を引き起こすことがあります。取扱説明書に従って正しい取り扱いをして下さい。

VCCI-B

Notice to users in Japan about the power cord

製品には、同梱された電源コードをお使い下さい。
同梱された電源コードは、他の製品では使用出来ません。

Noise emission statement for Germany

Geräuschemission

LpA < 70 dB am Arbeitsplatz im Normalbetrieb nach DIN 45635 T. 19

European Union Regulatory Notice

Products bearing the CE marking comply with the following EU Directives:

- Low Voltage Directive 2006/95/EC
- EMC Directive 2004/108/EC
- Ecodesign Directive 2009/125/EC, where applicable

CE compliance of this product is valid only if powered with the correct CE-marked AC adapter provided by HP.

If this product has wired and/or wireless telecommunications functionality, it also complies with the essential requirements of the following EU Directive:

- R&TTE Directive 1999/5/EC

Compliance with these directives implies conformity to applicable harmonized European standards (European Norms) that are listed in the EU Declaration of Conformity issued by HP for this product or product family and available (in English only) either within the product documentation or at the following website: www.hp.com/go/certificates (type the product number in the search field).

The compliance is indicated by one of the following conformity markings placed on the product:



For non-telecommunications products and for EU harmonized telecommunications products, such as Bluetooth® within power class below 10mW.



For EU non-harmonized telecommunications products (if applicable, a 4-digit notified body number is placed next to CE mark).

Please refer to the regulatory label provided on the product.

The telecommunications functionality of this product may be used in the following EU and EFTA countries: Austria, Belgium, Bulgaria, Cyprus, Czech Republic, Denmark, Estonia, Finland, France, Germany, Greece, Hungary, Iceland, Ireland, Italy, Latvia, Liechtenstein, Lithuania, Luxembourg, Malta, Netherlands, Norway, Poland, Portugal, Romania, Slovak Republic, Slovenia, Spain, Sweden, Switzerland, and United Kingdom.

The telephone connector (not available for all products) is intended for connection to analogue telephone networks.

Products with wireless LAN devices

- Some countries may have specific obligations or special requirements about the operation of Wireless LAN networks such as indoor use only or restrictions of the channels available. Please make sure that the country settings of the wireless network are correct.

France

- For 2.4-GHz Wireless LAN operation of this product, certain restrictions apply: This product may be used indoors for the entire 2400-MHz to 2483.5-MHz frequency band (channels 1 to 13). For outdoor use, only the 2400-MHz to 2454-MHz frequency band (channels 1 to 7) may be used. For the latest requirements, see www.arcep.fr.

The point of contact for regulatory matters is:

Hewlett-Packard GmbH, Dept./MS: HQ-TRE, Herrenberger Strasse 140, 71034 Boeblingen, GERMANY

Visual display workplaces statement for Germany

GS-Erklärung (Deutschland)

Das Gerät ist nicht für die Benutzung im unmittelbaren Gesichtsfeld am Bildschirmarbeitsplatz vorgesehen. Um störende Reflexionen am Bildschirmarbeitsplatz zu vermeiden, darf dieses Produkt nicht im unmittelbaren Gesichtsfeld platziert werden.

Declaration of conformity



DECLARATION OF CONFORMITY

according to ISO/IEC 17050-1 and EN 17050-1

DoC #: SNPRH-1201-R1

Supplier's Name: Hewlett-Packard Company
Supplier's Address: 20, Jia Feng Road Waigaoqiao Free Trade Zone Pudong, Shanghai, PRC 200131

declares, that the product
Product Name and Model: HP Officejet 4630 e-All-in-One Printer series
HP Deskjet Ink Advantage 4640 e-All-in-One Printer series

Regulatory Model Number: ¹⁾ SNPRH-1201

Radio Module: SDGOB-1292

Product Options: All

conforms to the following Product Specifications and Regulations:

EMC:

CISPR 22:2008 Class B
EN 55022:2010 Class B
EN 55024:2010
EN 61000-3-2:2006 +A1:2009 +A2:2009
EN 61000-3-3:2008
FCC CFR 47 Part 15 Class B
ICES-003, Issue 4 Class B Class B

Safety:

EN 60950-1:2006 +A11:2009 +A1:2010 +A12:2011
IEC 60950-1:2005 +A1:2009
EN 62479:2010

Telecom:

EN 300 328 V1.7.1
EN 301 489-1 V1.8.1
EN 301 489-17 V2.1.1
EN 62311:2008
FCC Rules and Regulations 47 CFR Part 68
TIA-968-B Telecommunications- Telephone Terminal Equipment Technical Requirements for Connection to the Telephone Network (Sep 2009)
ES 203 021-1, -2, -3
CS-03, Part 1, Issue 9, Amendment 4, December 2010

Energy Use:

Regulation (EC) No. 1275/2008
ENERGY STAR® Qualified Imaging Equipment Operational Mode (OM) Test Procedure

RoHS:

EN 50581:2012

The product herewith complies with the requirements of the Low Voltage Directive 2006/95/EC, the EMC Directive 2004/108/EC, the R&TTE Directive 1999/5/EC, the Ecodesign Directive 2009/125/EC, the RoHS Directive 2011/65/EU and carries the CE marking accordingly.

This device complies with part 15 of the FCC Rules. Operation is subject to the following two conditions:

(1) This device may not cause harmful interference, and (2) this device must accept any interference received, including interference that may cause undesired operation.

Additional information:

1) This product is assigned a Regulatory Model Number which stays with the regulatory aspects of the design. The Regulatory Model Number is the main product identifier in the regulatory documentation and test reports; this number should not be confused with the marketing name or the product numbers.

Shan HongBo

ICS Product Hardware Quality Engineering, Manager

Local contact for regulatory topics only:

EU: Hewlett-Packard GmbH, HQ-TRE, Hamenberger Strasse 140, 71034 Boblingen, Germany
U.S.: Hewlett-Packard, 3000 Hanover St., Palo Alto, CA 94304, U.S.A. 650.857.1501

www.hp.eu/certificates

Regulatory wireless statements

This section contains the following regulatory information pertaining to wireless products:

- [Exposure to radio frequency radiation](#)
- [Notice to users in Brazil](#)
- [Notice to users in Canada](#)
- [Notice to users in Mexico](#)
- [Notice to users in Taiwan](#)
- [Wireless notice to users in Japan](#)

Exposure to radio frequency radiation

Exposure to radio frequency radiation



Caution The radiated output power of this device is far below the FCC radio frequency exposure limits. Nevertheless, the device shall be used in such a manner that the potential for human contact during normal operation is minimized. This product and any attached external antenna, if supported, shall be placed in such a manner to minimize the potential for human contact during normal operation. In order to avoid the possibility of exceeding the FCC radio frequency exposure limits, human proximity to the antenna shall not be less than 20 cm (8 inches) during normal operation.

Notice to users in Brazil

Aviso aos usuários no Brasil

Este equipamento opera em caráter secundário, isto é, não tem direito à proteção contra interferência prejudicial, mesmo de estações do mesmo tipo, e não pode causar interferência a sistemas operando em caráter primário. (Res. ANATEL 282/2001).

Notice to users in Canada

Notice to users in Canada/Note à l'attention des utilisateurs canadiens

Under Industry Canada regulations, this radio transmitter may only operate using an antenna of a type and maximum (or lesser) gain approved for the transmitter by Industry Canada. To reduce potential radio interference to other users, the antenna type and its gain should be so chosen that the equivalent isotropically radiated power (e.i.r.p.) is not more than that necessary for successful communication.

This device complies with Industry Canada licence-exempt RSS standard(s). Operation is subject to the following two conditions: (1) this device may not cause interference, and (2) this device must accept any interference, including interference that may cause undesired operation of the device.

WARNING! Exposure to Radio Frequency Radiation The radiated output power of this device is below the Industry Canada radio frequency exposure limits. Nevertheless, the device should be used in such a manner that the potential for human contact is minimized during normal operation.

To avoid the possibility of exceeding the Industry Canada radio frequency exposure limits, human proximity to the antennas should not be less than 20 cm (8 inches).

Conformément au Règlement d'Industrie Canada, cet émetteur radioélectrique ne peut fonctionner qu'avec une antenne d'un type et d'un gain maximum (ou moindre) approuvé par Industrie Canada. Afin de réduire le brouillage radioélectrique potentiel pour d'autres utilisateurs, le type d'antenne et son gain doivent être choisis de manière à ce que la puissance isotrope rayonnée équivalente (p.i.r.e.) ne dépasse pas celle nécessaire à une communication réussie.

Cet appareil est conforme aux normes RSS exemptes de licence d'Industrie Canada. Son fonctionnement dépend des deux conditions suivantes : (1) cet appareil ne doit pas provoquer d'interférences nuisibles et (2) doit accepter toutes interférences reçues, y compris des interférences pouvant provoquer un fonctionnement non souhaité de l'appareil.

AVERTISSEMENT relatif à l'exposition aux radiofréquences. La puissance de rayonnement de cet appareil se trouve sous les limites d'exposition de radiofréquences d'Industrie Canada. Néanmoins, cet appareil doit être utilisé de telle sorte qu'il soit mis en contact le moins possible avec le corps humain.

Afin d'éviter le dépassement éventuel des limites d'exposition aux radiofréquences d'Industrie Canada, il est recommandé de maintenir une distance de plus de 20 cm entre les antennes et l'utilisateur.

Notice to users in Mexico

Aviso para los usuarios de México

La operación de este equipo está sujeta a las siguientes dos condiciones: (1) es posible que este equipo o dispositivo no cause interferencia perjudicial y (2) este equipo o dispositivo debe aceptar cualquier interferencia, incluyendo la que pueda causar su operación no deseada.

Para saber el modelo de la tarjeta inalámbrica utilizada, revise la etiqueta regulatoria de la impresora.

Notice to users in Taiwan

低功率電波輻射性電機管理辦法

第十二條

經型式認證合格之低功率射頻電機，非經許可，公司、商號或使用者均不得擅自變更頻率、加大功率或變更設計之特性及功能。

第十四條

低功率射頻電機之使用不得影響飛航安全及干擾合法通信；經發現有干擾現象時，應立即停用，並改善至無干擾時方得繼續使用。

前項合法通信，指依電信法規定作業之無線電通信。低功率射頻電機須忍受合法通信或工業、科學及醫藥用電波輻射性電機設備之干擾。

Wireless notice to users in Japan

この機器は技術基準適合証明又は工事設計認証を受けた無線設備を搭載しています。

Notice to users of the U.S. telephone network: FCC requirements

Notice to users of the U.S Telephone network: FCC requirements

This equipment complies with Part 68 of the FCC rules and the requirements adopted by the ACTA. On the rear (or bottom) of this equipment is a label that contains, among other information, a product identifier in the format US:AAAEQ##TXXXX. If requested, this number must be provided to the telephone company.

Applicable connector jack Universal Service Order Codes ("USOC") for the Equipment is: RJ-11C.

A plug and jack used to connect this equipment to the premises wiring and telephone network must comply with the applicable FCC Part 68 rules and requirements adopted by the ACTA. A compliant telephone cord and modular plug is provided with this product. It is designed to be connected to a compatible modular jack that is also compliant. See installation instructions for details.

The REN is used to determine the number of devices that may be connected to a telephone line. Excessive RENs on a telephone line may result in the devices not ringing in response to an incoming call. In most but not all areas, the sum of RENs should not exceed five (5.0). To be certain of the number of devices that may be connected to a line, as determined by the total RENs, contact the local telephone company. For products approved after July 23, 2001, the REN for this product is part of the product identifier that has the format US:AAAEQ##TXXXX. The digits represented by ## are the REN without a decimal point (e.g., 00 is a REN of 0.0).

If this equipment causes harm to the telephone network, the telephone company will notify you in advance that temporary discontinuance of service may be required. But if advance notice isn't practical, the telephone company will notify the customer as soon as possible. Also, you will be advised of your right to file a complaint with the FCC if you believe it is necessary.

The telephone company may make changes in its facilities, equipment, operations or procedures that could affect the operation of the equipment. If this happens the telephone company will provide advance notice in order for you to make necessary modifications to maintain uninterrupted service.

If trouble is experienced with this equipment, please contact the manufacturer, or look elsewhere in this manual, for repair or warranty information. If the equipment is causing harm to the telephone network, the telephone company may request that you disconnect the equipment until the problem is resolved.

Connection to party line service is subject to state tariffs. Contact the state public utility commission, public service commission or corporation commission for information.

If your home has specially wired alarm equipment connected to the telephone line, ensure the installation of this equipment does not disable your alarm equipment. If you have questions about what will disable alarm equipment, consult your telephone company or a qualified installer.

WHEN PROGRAMMING EMERGENCY NUMBERS AND/OR MAKING TEST CALLS TO EMERGENCY NUMBERS:

- 1) Remain on the line and briefly explain to the dispatcher the reason for the call.
- 2) Perform such activities in the off-peak hours, such as early morning or late evenings.



Note The FCC hearing aid compatibility rules for telephones are not applicable to this equipment.

The Telephone Consumer Protection Act of 1991 makes it unlawful for any person to use a computer or other electronic device, including FAX machines, to send any message unless such message clearly contains in a margin at the top or bottom of each transmitted page or on the first page of the transmission, the date and time it is sent and an identification of the business or other entity, or other individual sending the message and the telephone number of the sending machine or such business, other entity, or individual. (The telephone number provided may not be a 900 number or any other number for which charges exceed local or long-distance transmission charges.)

In order to program this information into your FAX machine, you should complete the steps described in the software.

Notice to users of the Canadian telephone network

Note à l'attention des utilisateurs du réseau téléphonique canadien/Notice to users of the Canadian telephone network

Cet appareil est conforme aux spécifications techniques des équipements terminaux d'Industrie Canada. Le numéro d'enregistrement atteste de la conformité de l'appareil. L'abréviation IC qui précède le numéro d'enregistrement indique que l'enregistrement a été effectué dans le cadre d'une Déclaration de conformité stipulant que les spécifications techniques d'Industrie Canada ont été respectées. Néanmoins, cette abréviation ne signifie en aucun cas que l'appareil a été validé par Industrie Canada.

Pour leur propre sécurité, les utilisateurs doivent s'assurer que les prises électriques reliées à la terre de la source d'alimentation, des lignes téléphoniques et du circuit métallique d'alimentation en eau sont, le cas échéant, branchées les unes aux autres. Cette précaution est particulièrement importante dans les zones rurales.



Remarque Le numéro REN (Ringer Equivalence Number) attribué à chaque appareil terminal fournit une indication sur le nombre maximal de terminaux qui peuvent être connectés à une interface téléphonique. La terminaison d'une interface peut se composer de n'importe quelle combinaison d'appareils, à condition que le total des numéros REN ne dépasse pas 5.

Basé sur les résultats de tests FCC Partie 68, le numéro REN de ce produit est 0.0B.

This equipment meets the applicable Industry Canada Terminal Equipment Technical Specifications. This is confirmed by the registration number. The abbreviation IC before the registration number signifies that registration was performed based on a Declaration of Conformity indicating that Industry Canada technical specifications were met. It does not imply that Industry Canada approved the equipment.

Users should ensure for their own protection that the electrical ground connections of the power utility, telephone lines and internal metallic water pipe system, if present, are connected together. This precaution might be particularly important in rural areas.



Note The REN (Ringer Equivalence Number) assigned to each terminal device provides an indication of the maximum number of terminals allowed to be connected to a telephone interface. The termination on an interface might consist of any combination of devices subject only to the requirement that the sum of the Ringer Equivalence Numbers of all the devices does not exceed 5.

The REN for this product is 0.0B, based on FCC Part 68 test results.

Notice to users in the European Economic Area

Notice to users in the European Economic Area

This product is designed to be connected to the analog Switched Telecommunication Networks (PSTN) of the European Economic Area (EEA) countries/regions.

Network compatibility depends on customer selected settings, which must be reset to use the equipment on a telephone network in a country/region other than where the product was purchased. Contact the vendor or Hewlett-Packard Company if additional product support is necessary.

This equipment has been certified by the manufacturer in accordance with Directive 1999/5/EC (annex II) for Pan-European single-terminal connection to the public switched telephone network (PSTN). However, due to differences between the individual PSTNs provided in different countries, the approval does not, of itself, give an unconditional assurance of successful operation on every PSTN network termination point.

In the event of problems, you should contact your equipment supplier in the first instance.

This equipment is designed for DTMF tone dialing and loop disconnect dialing. In the unlikely event of problems with loop disconnect dialing, it is recommended to use this equipment only with the DTMF tone dial setting.

Notice to users of the German telephone network

Hinweis für Benutzer des deutschen Telefonnetzes

Dieses HP-Fax ist nur für den Anschluss eines analogen Public Switched Telephone Network (PSTN) gedacht. Schließen Sie den TAE N-Telefonstecker, der im Lieferumfang des HP All-in-One enthalten ist, an die Wandsteckdose (TAE 6) Code N an. Dieses HP-Fax kann als einzelnes Gerät und/oder in Verbindung (mit serielltem Anschluss) mit anderen zugelassenen Endgeräten verwendet werden.

Australia wired fax statement

In Australia, the HP device must be connected to Telecommunication Network through a line cord which meets the requirements of the Technical Standard AS/ACIF S008.

B Additional fax setup

In this section, you learn how to set up the printer so that faxing works successfully with equipment and services you might already have on the same phone line.

 **TIP:** You can also use the Fax Setup Wizard (Windows) or HP Setup Assistant (Mac OS X) to help you quickly set up some important fax settings such as the answer mode and fax header information. You can access these tools through the HP software you installed with the printer. After you run these tools, follow the procedures in this section to complete your fax setup.

This section contains the following topics:

- [Set up faxing \(parallel phone systems\)](#)
- [Serial-type fax setup](#)
- [Test fax setup](#)

Set up faxing (parallel phone systems)

Before you begin setting up the printer for faxing, determine which kind of phone system your country/region uses. The instructions for fax setup differ depending on whether you have a serial- or parallel-type phone system.

Table B-1 Countries/regions with a parallel-type phone system

| | | |
|-----------|---------------|--------------|
| Argentina | Australia | Brazil |
| Canada | Chile | China |
| Colombia | Greece | India |
| Indonesia | Ireland | Japan |
| Korea | Latin America | Malaysia |
| Mexico | Philippines | Poland |
| Portugal | Russia | Saudi Arabia |
| Singapore | Spain | Taiwan |
| Thailand | USA | Venezuela |
| Vietnam | | |

- If you do not see your country/region listed, you probably have a serial-type phone system. In a serial-type phone system, the connector type on your shared telephone equipment (modems, phones, and answering machines) does not allow a physical connection to the "2-EXT" port on the printer. Instead, all equipment must be connected at the telephone wall jack.



NOTE: In some countries/regions that use serial-type phone systems, the phone cord that came with the printer might have an additional wall plug attached to it. This enables you to connect other telecom devices to the wall jack where you plug in the printer.

You might need to connect the supplied phone cord to the adapter provided for your country/region.

- If your country/region is listed, you probably have a parallel-type telephone system. In a parallel-type phone system, you are able to connect shared telephone equipment to the phone line by using the "2-EXT" port on the back of the printer.



NOTE: If you have a parallel-type phone system, HP recommends you use the 2-wire phone cord supplied with the printer to connect it to the telephone wall jack.

If you are unsure which kind of telephone system you have (serial or parallel), check with your telephone company.

This section contains the following topics:

- [Select the correct fax setup for your home or office](#)
- [Case A: Separate fax line \(no voice calls received\)](#)
- [Case B: Set up the printer with DSL](#)
- [Case C: Set up the printer with a PBX phone system or an ISDN line](#)
- [Case D: Fax with a distinctive ring service on the same line](#)

- [Case E: Shared voice/fax line](#)
- [Case F: Shared voice/fax line with voice mail](#)
- [Case G: Fax line shared with computer modem \(no voice calls received\)](#)
- [Case H: Shared voice/fax line with computer modem](#)
- [Case I: Shared voice/fax line with answering machine](#)
- [Case J: Shared voice/fax line with computer modem and answering machine](#)
- [Case K: Shared voice/fax line with computer dial-up modem and voice mail](#)

Select the correct fax setup for your home or office

To fax successfully, you need to know what types of equipment and services (if any) share the same phone line with the printer. This is important because you might need to connect some of your existing office equipment directly to the printer, and you might also need to change some fax settings before you can fax successfully.

1. Determine if your telephone system is serial or parallel. See [Set up faxing \(parallel phone systems\) on page 140](#).
 - a. Serial-type telephone system—See [Serial-type fax setup on page 162](#).
 - b. Parallel-type telephone system—Go to step 2.
2. Select the combination of equipment and services sharing your fax line.
 - DSL: A Digital subscriber line (DSL) service through your telephone company. (DSL might be called ADSL in your country/region.)
 - PBX: A private branch exchange (PBX) phone system or an integrated services digital network (ISDN) system.
 - Distinctive ring service: A distinctive ring service through your telephone company provides multiple telephone numbers with different ring patterns.
 - Voice calls: Voice calls are received at the same phone number you use for fax calls on the printer.
 - Computer dial-up modem: A computer dial-up modem is on the same phone line as the printer. If you answer Yes to any of the following questions, you are using a computer dial-up modem:
 - Do you send and receive faxes directly to and from your computer software applications through a dial-up connection?
 - Do you send and receive email messages on your computer through a dial-up connection?
 - Do you access the Internet from your computer through a dial-up connection?
 - Answering machine: An answering machine that answers voice calls at the same phone number you use for fax calls on the printer.
 - Voice mail service: A voice mail subscription through your telephone company at the same number you use for fax calls on the printer.
3. From the following table, select the combination of equipment and services applicable to your home or office setting. Then look up the recommended fax setup. Step-by-step instructions are included for each case in the sections that follow.



NOTE: If your home or office setup is not described in this section, set up the printer as you would a regular analog phone. Make sure you use the phone cord supplied in the box to connect one end to your telephone wall jack and the other end to the port labeled 1_LINE on the back of the printer. If you use another phone cord, you might experience problems sending and receiving faxes.

You might need to connect the supplied phone cord to the adapter provided for your country/region.

| Other equipment or services sharing your fax line | | | | | | | Recommended fax setup |
|---|-----|--------------------------|-------------|------------------------|-------------------|--------------------|--|
| DSL | PBX | Distinctive ring service | Voice calls | Computer dial-up modem | Answering machine | Voice mail service | |
| | | | | | | | Case A: Separate fax line (no voice calls received) on page 142 |
| ✓ | | | | | | | Case B: Set up the printer with DSL on page 143 |
| | ✓ | | | | | | Case C: Set up the printer with a PBX phone system or an ISDN line on page 144 |
| | | ✓ | | | | | Case D: Fax with a distinctive ring service on the same line on page 145 |
| | | | ✓ | | | | Case E: Shared voice/fax line on page 146 |
| | | | ✓ | | | ✓ | Case F: Shared voice/fax line with voice mail on page 147 |
| | | | | ✓ | | | Case G: Fax line shared with computer modem (no voice calls received) on page 148 |
| | | | ✓ | ✓ | | | Case H: Shared voice/fax line with computer modem on page 151 |
| | | | ✓ | | ✓ | | Case I: Shared voice/fax line with answering machine on page 154 |
| | | | ✓ | ✓ | ✓ | | Case J: Shared voice/fax line with computer modem and answering machine on page 156 |
| | | | ✓ | ✓ | | ✓ | Case K: Shared voice/fax line with computer dial-up modem and voice mail on page 159 |

Case A: Separate fax line (no voice calls received)

If you have a separate phone line on which you receive no voice calls, and you have no other equipment connected on this phone line, set up the printer as described in this section.

Figure B-1 Back view of the printer

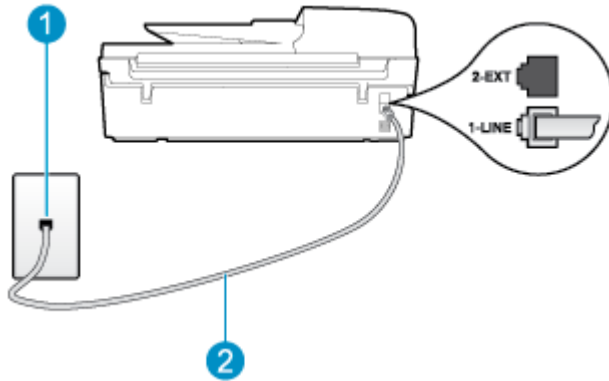

| | |
|---|--|
| 1 | Telephone wall jack |
| 2 | Use the phone cord supplied in the box with the printer to connect to the 1_LINE port. You might need to connect the supplied phone cord to the adapter provided for your country/region. |

To set up the printer with a separate fax line

1. Using the phone cord supplied in the box with the printer, connect one end to your telephone wall jack, then connect the other end to the port labeled 1_LINE on the back of the printer.

 **NOTE:** You might need to connect the supplied phone cord to the adapter provided for your country/region.

If you do not use the supplied cord to connect from the telephone wall jack to the printer, you might not be able to fax successfully. This special phone cord is different from the phone cords you might already have in your home or office.

2. Turn on the **Auto Answer** setting.
3. (Optional) Change the **Rings to Answer** setting to the lowest setting (two rings).
4. Run a fax test.

When the phone rings, the printer answers automatically after the number of rings you set in the **Rings to Answer** setting. The printer begins emitting fax reception tones to the sending fax machine and receives the fax.

Case B: Set up the printer with DSL

If you have a DSL service through your telephone company, and do not connect any equipment to the printer, use the instructions in this section to connect a DSL filter between the telephone wall jack and the printer. The DSL filter removes the digital signal that can interfere with the printer, so the printer can communicate correctly with the phone line. (DSL might be called ADSL in your country/region.)

 **NOTE:** If you have a DSL line and you do not connect the DSL filter, you cannot send and receive faxes with the printer.

Figure B-2 Back view of the printer



| | |
|---|--|
| 1 | Telephone wall jack |
| 2 | DSL (or ADSL) filter and cord supplied by your DSL provider |
| 3 | Use the phone cord supplied in the box with the printer to connect to the 1_LINE port. You might need to connect the supplied phone cord to the adapter provided for your country/region. |

To set up the printer with DSL

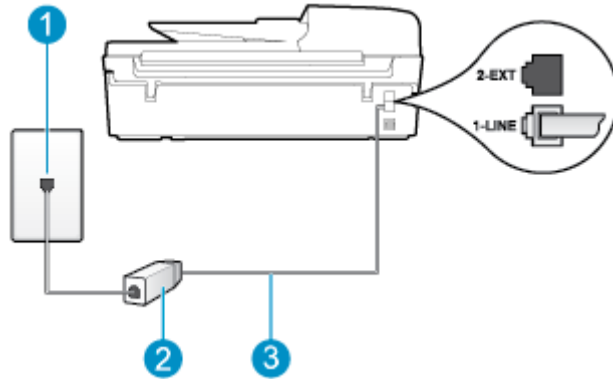
1. Obtain a DSL filter from your DSL provider.
2. Using the phone cord supplied in the box with the printer, connect one end to the open port on the DSL filter, and then connect the other end to the port labeled 1_LINE on the back of the printer.

 **NOTE:** You might need to connect the supplied phone cord to the adapter provided for your country/region.

If you do not use the supplied cord to connect from the DSL filter to the printer, you might not be able to fax successfully. This special phone cord is different from the phone cords you might already have in your home or office.

As only one phone cord is supplied, you might need to obtain additional phone cords for this setup.

3. Connect an additional phone cord from the DSL filter to the telephone wall jack.
4. Run a fax test.

If you encounter problems setting up the printer with optional equipment, contact your local service provider or vendor for further assistance.

Case C: Set up the printer with a PBX phone system or an ISDN line

If you are using either a PBX phone system or an ISDN converter/terminal adapter, make sure you do the following:

- If you are using either a PBX or an ISDN converter/terminal adaptor, connect the printer to the port that is designated for fax and phone use. Also, make sure that the terminal adapter is set to the correct switch type for your country/region, if possible.

NOTE: Some ISDN systems allow you to configure the ports for specific phone equipment. For example, you might have assigned one port for telephone and Group 3 fax and another port for multiple purposes. If you have problems when connected to the fax/phone port of your ISDN converter, try using the port designated for multiple purposes; it might be labeled "multi-combi" or something similar.

- If you are using a PBX phone system, set the call waiting tone to "off."

NOTE: Many digital PBX systems include a call-waiting tone that is set to "on" by default. The call-waiting tone interferes with any fax transmission, and you cannot send or receive faxes with the printer. Refer to the documentation that came with your PBX phone system for instructions on how to turn off the call-waiting tone.

- If you are using a PBX phone system, dial the number for an outside line before dialing the fax number.
- Make sure you use the supplied cord to connect from the telephone wall jack to the printer. If you do not, you might not be able to fax successfully. This special phone cord is different from the phone cords you might already have in your home or office. If the supplied phone cord is too short, you can purchase a coupler from your local electronics store and extend it.

You might need to connect the supplied phone cord to the adapter provided for your country/region.

If you encounter problems setting up the printer with optional equipment, contact your local service provider or vendor for further assistance.

Case D: Fax with a distinctive ring service on the same line

If you subscribe to a distinctive ring service (through your telephone company) that allows you to have multiple phone numbers on one phone line, each with a different ring pattern, set up the printer as described in this section.

Figure B-3 Back view of the printer

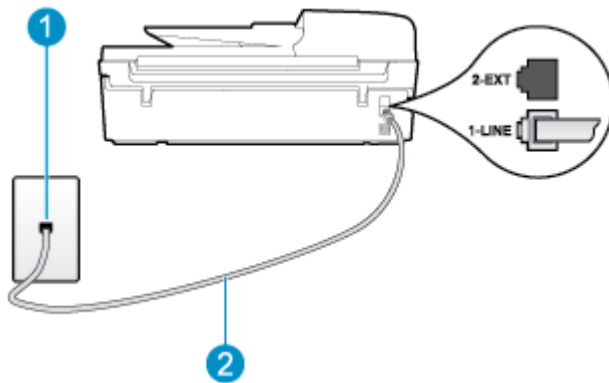

| | |
|---|--|
| 1 | Telephone wall jack |
| 2 | Use the phone cord supplied in the box with the printer to connect to the 1_LINE port. You might need to connect the supplied phone cord to the adapter provided for your country/region. |

To set up the printer with a distinctive ring service

1. Using the phone cord supplied in the box with the printer, connect one end to your telephone wall jack, then connect the other end to the port labeled 1_LINE on the back of the printer.

 **NOTE:** You might need to connect the supplied phone cord to the adapter provided for your country/region.

If you do not use the supplied cord to connect from the telephone wall jack to the printer, you might not be able to fax successfully. This special phone cord is different from the phone cords you might already have in your home or office.

2. Turn on the **Auto Answer** setting.
3. Change the **Distinctive Ring** setting to match the pattern that the telephone company assigned to your fax number.

 **NOTE:** By default, the printer is set to answer all ring patterns. If you do not set the **Distinctive Ring** to match the ring pattern assigned to your fax number, the printer might answer both voice calls and fax calls or it might not answer at all.

 **TIP:** You can also use the Ring Pattern Detection feature in the printer's control panel to set distinctive ring. With this feature, the printer recognizes and records the ring pattern of an incoming call and, based on this call, automatically determines the distinctive ring pattern assigned by your telephone company to fax calls. For more information, see [Set the dial type on page 57](#).

4. (Optional) Change the **Rings to Answer** setting to the lowest setting (two rings).
5. Run a fax test.

The printer automatically answers incoming calls that have the ring pattern you selected (**Distinctive Ring** setting) after the number of rings you selected (**Rings to Answer** setting). The printer begins emitting fax reception tones to the sending fax machine and receives the fax.

If you encounter problems setting up the printer with optional equipment, contact your local service provider or vendor for further assistance.

Case E: Shared voice/fax line

If you receive both voice calls and fax calls at the same phone number, and you have no other office equipment (or voice mail) on this phone line, set up the printer as described in this section.

Figure B-4 Back view of the printer

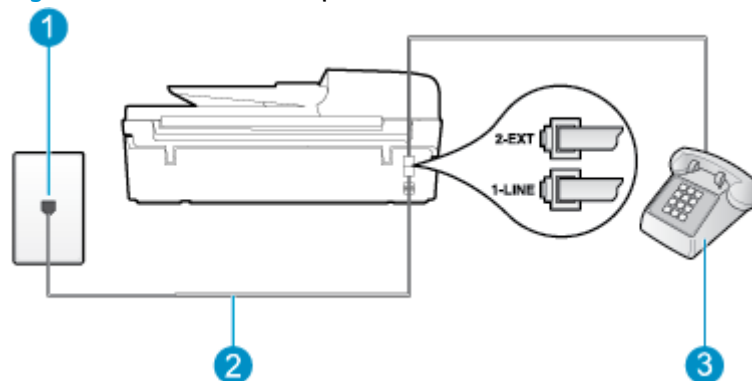

| | |
|---|--|
| 1 | Telephone wall jack |
| 2 | Use the phone cord supplied in the box with the printer to connect to the 1_LINE port. You might need to connect the supplied phone cord to the adapter provided for your country/region. |
| 3 | Telephone (optional) |

To set up the printer with a shared voice/fax line

1. Using the phone cord supplied in the box with the printer, connect one end to your telephone wall jack, then connect the other end to the port labeled 1_LINE on the back of the printer.



NOTE: You might need to connect the supplied phone cord to the adapter provided for your country/region.

If you do not use the supplied cord to connect from the telephone wall jack to the printer, you might not be able to fax successfully. This special phone cord is different from the phone cords you might already have in your home or office.

2. Do one of the following:
 - If you have a parallel-type phone system, remove the white plug from the port labeled 2_EXT on the back of the printer, and then connect a phone to this port.
 - If you have a serial-type phone system, you might plug your phone directly on top of the printer cable which has a wall plug attached to it.
3. Now you need to decide how you want the printer to answer calls, automatically or manually:
 - If you set up the printer to answer calls **automatically**, it answers all incoming calls and receives faxes. The printer cannot distinguish between fax and voice calls in this case; if you suspect the call is a voice call, you need to answer it before the printer answers the call. To set up the printer to answer calls automatically, turn on the **Auto Answer** setting.
 - If you set up the printer to answer faxes **manually**, you must be available to respond in person to incoming fax calls or the printer cannot receive faxes. To set up the printer to answer calls manually, turn off the **Auto Answer** setting.
4. Run a fax test.

If you pick up the phone before the printer answers the call and hear fax tones from a sending fax machine, you need to answer the fax call manually.

If you encounter problems setting up the printer with optional equipment, contact your local service provider or vendor for further assistance.

Case F: Shared voice/fax line with voice mail

If you receive both voice calls and fax calls at the same phone number, and you also subscribe to a voice mail service through your telephone company, set up the printer as described in this section.



NOTE: You cannot receive faxes automatically if you have a voice mail service at the same phone number you use for fax calls. You must receive faxes manually; this means you must be available to respond in person to incoming fax calls. If you want to receive faxes automatically instead, contact your telephone company to subscribe to a distinctive ring service, or to obtain a separate phone line for faxing.

Figure B-5 Back view of the printer

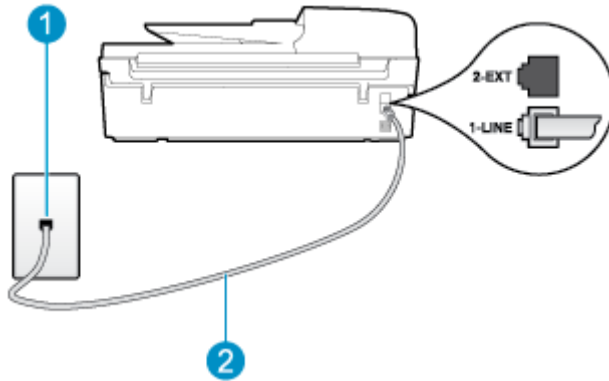

| | |
|---|--|
| 1 | Telephone wall jack |
| 2 | Use the phone cord supplied in the box with the printer to connect to the 1-LINE port. You might need to connect the supplied phone cord to the adapter provided for your country/region. |

To set up the printer with voice mail

1. Using the phone cord supplied in the box with the printer, connect one end to your telephone wall jack, then connect the other end to the port labeled 1_LINE on the back of the printer.

You might need to connect the supplied phone cord to the adapter provided for your country/region.

 **NOTE:** You might need to connect the supplied phone cord to the adapter provided for your country/region.

If you do not use the supplied cord to connect from the telephone wall jack to the printer, you might not be able to fax successfully. This special phone cord is different from the phone cords you might already have in your home or office.

2. Turn off the **Auto Answer** setting.
3. Run a fax test.

You must be available to respond in person to incoming fax calls, or the printer cannot receive faxes. You must initiate the manual fax before voicemail picks up the line.

If you encounter problems setting up the printer with optional equipment, contact your local service provider or vendor for further assistance.

Case G: Fax line shared with computer modem (no voice calls received)

If you have a fax line on which you receive no voice calls, and you also have a computer modem connected on this line, set up the printer as described in this section.

 **NOTE:** If you have a computer dial-up modem, your computer dial-up modem shares the phone line with the printer. You cannot use both your modem and the printer simultaneously. For example, you cannot use the printer for faxing while you are using your computer dial-up modem to send an email or access the Internet.

- [Set up the printer with a computer dial-up modem](#)

- [Set up the printer with a computer DSL/ADSL modem](#)

Set up the printer with a computer dial-up modem

If you are using the same phone line for sending faxes and for a computer dial-up modem, follow these directions for setting up the printer.

Figure B-6 Back view of the printer

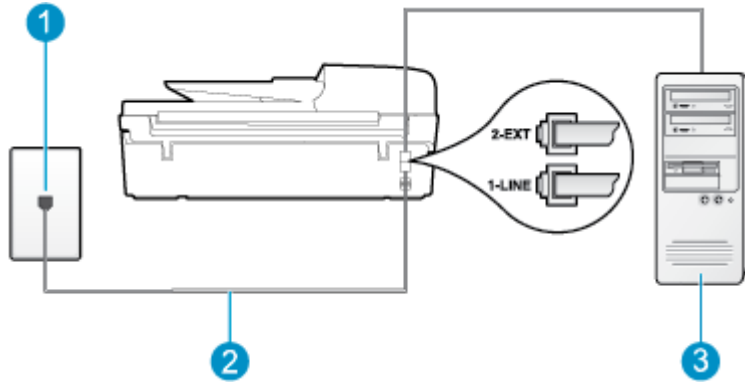

| | |
|---|--|
| 1 | Telephone wall jack |
| 2 | Use the phone cord supplied in the box with the printer to connect to the 1-LINE port. You might need to connect the supplied phone cord to the adapter provided for your country/region. |
| 3 | Computer with modem |

To set up the printer with a computer dial-up modem

1. Remove the white plug from the port labeled 2_EXT on the back of the printer.
2. Find the phone cord that connects from the back of your computer (your computer dial-up modem) to a telephone wall jack. Disconnect the cord from the telephone wall jack and plug it into the port labeled 2_EXT on the back of the printer.
3. Using the phone cord supplied in the box with the printer, connect one end to your telephone wall jack, then connect the other end to the port labeled 1_LINE on the back of the printer.

 **NOTE:** You might need to connect the supplied phone cord to the adapter provided for your country/region.

If you do not use the supplied cord to connect from the telephone wall jack to the printer, you might not be able to fax successfully. This special phone cord is different from the phone cords you might already have in your home or office.

4. If your modem software is set to receive faxes to your computer automatically, turn off that setting.

 **NOTE:** If you do not turn off the automatic fax reception setting in your modem software, the printer cannot receive faxes.

5. Turn on the **Auto Answer** setting.
6. (Optional) Change the **Rings to Answer** setting to the lowest setting (two rings).
7. Run a fax test.

When the phone rings, the printer automatically answers after the number of rings you set in the **Rings to Answer** setting. The printer begins emitting fax reception tones to the sending fax machine and receives the fax.

If you encounter problems setting up the printer with optional equipment, contact your local service provider or vendor for further assistance.

Set up the printer with a computer DSL/ADSL modem

If you have a DSL line and use that phone line to send faxes, follow these instructions to set up your fax.

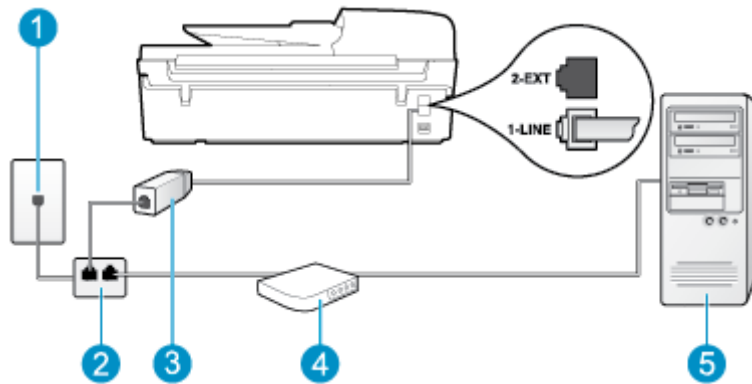

| | |
|---|---|
| 1 | Telephone wall jack |
| 2 | Parallel splitter |
| 3 | DSL/ADSL filter Connect one end of the phone jack that was supplied with the printer to connect to the 1_LINE port on the back of the printer. Connect the other end of the cord to the DSL/ADSL filter. You might need to connect the supplied phone cord to the adapter provided for your country/region. |
| 4 | Computer DSL/ADSL modem |
| 5 | Computer |

NOTE: You need to purchase a parallel splitter. A parallel splitter has one RJ-11 port on the front and two RJ-11 ports on the back. Do not use a 2-line phone splitter, a serial splitter, or a parallel splitter which has two RJ-11 ports on the front and a plug on the back.

Figure B-7 Example of a parallel splitter



To set up the printer with a computer DSL/ADSL modem

1. Obtain a DSL filter from your DSL provider.
2. Using the phone cord provided in the box with the printer, connect one end to the DSL filter, and then connect the other end to the port labeled 1_LINE on the back of the printer.



NOTE: You might need to connect the supplied phone cord to the adapter provided for your country/region.

If you do not use the supplied cord to connect from the DSL filter to the back of the printer, you might not be able to fax successfully. This special phone cord is different from the phone cords you might already have in your home or office.

3. Connect the DSL filter to the parallel splitter.
4. Connect the DSL modem to the parallel splitter.
5. Connect the parallel splitter to the wall jack.
6. Run a fax test.

When the phone rings, the printer automatically answers after the number of rings you set in the **Rings to Answer** setting. The printer begins emitting fax reception tones to the sending fax machine and receives the fax.

If you encounter problems setting up the printer with optional equipment, contact your local service provider or vendor for further assistance.

Case H: Shared voice/fax line with computer modem

There are two different ways to set up the printer with your computer based on the number of phone ports on your computer. Before you begin, check your computer to see if it has one or two phone ports.



NOTE: If your computer has only one phone port, you need to purchase a parallel splitter (also called a coupler), as shown in the illustration. (A parallel splitter has one RJ-11 port on the front and two RJ-11 ports on the back. Do not use a two-line phone splitter, a serial splitter, or a parallel splitter which has two RJ-11 ports on the front and a plug on the back.)

- [Shared voice/fax with computer dial-up modem](#)
- [Shared voice/fax with computer DSL/ADSL modem](#)

Shared voice/fax with computer dial-up modem

If you use your phone line for both fax and telephone calls, use these instructions to set up your fax.

There are two different ways to set up the printer with your computer based on the number of phone ports on your computer. Before you begin, check your computer to see if it has one or two phone ports.



NOTE: If your computer has only one phone port, you need to purchase a parallel splitter (also called a coupler), as shown in the illustration. (A parallel splitter has one RJ-11 port on the front and two RJ-11 ports on the back. Do not use a two-line phone splitter, a serial splitter, or a parallel splitter which has two RJ-11 ports on the front and a plug on the back.)

Figure B-8 Example of a parallel splitter



Figure B-9 Back view of the printer

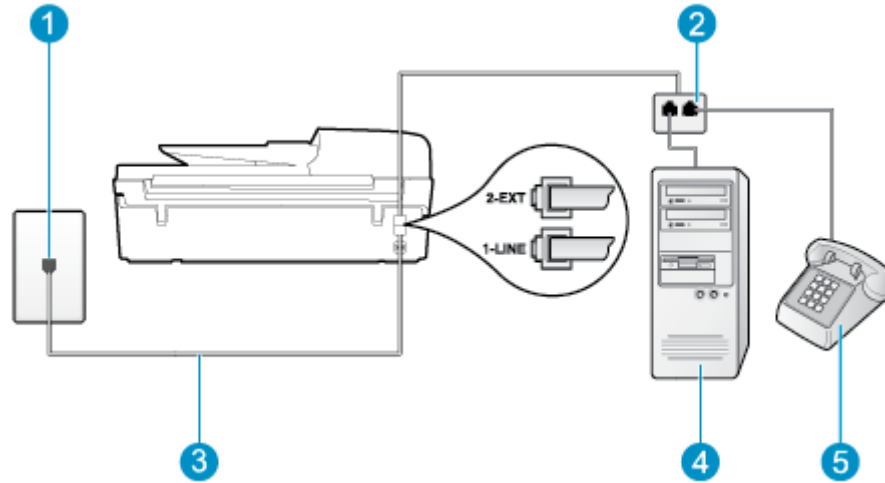

| | |
|---|--|
| 1 | Telephone wall jack |
| 2 | Parallel splitter |
| 3 | Use the phone cord supplied in the box with the printer to connect to the 1_LINE port. |
| 4 | Computer with modem |
| 5 | Telephone |

To set up the printer on the same phone line as a computer with two phone ports

1. Remove the white plug from the port labeled 2_EXT on the back of the printer.
2. Find the phone cord that connects from the back of your computer (your computer dial-up modem) to a telephone wall jack. Disconnect the cord from the telephone wall jack and plug it into the port labeled 2_EXT on the back of the printer.
3. Connect a phone to the "OUT" port on the back of your computer dial-up modem.
4. Using the phone cord supplied in the box with the printer, connect one end to your telephone wall jack, then connect the other end to the port labeled 1_LINE on the back of the printer.



NOTE: You might need to connect the supplied phone cord to the adapter provided for your country/region.

If you do not use the supplied cord to connect from the telephone wall jack to the printer, you might not be able to fax successfully. This special phone cord is different from the phone cords you might already have in your home or office.

5. If your modem software is set to receive faxes to your computer automatically, turn off that setting.



NOTE: If you do not turn off the automatic fax reception setting in your modem software, the printer cannot receive faxes.

6. Now you need to decide how you want the printer to answer calls, automatically or manually:

- If you set up the printer to answer calls **automatically**, it answers all incoming calls and receives faxes. The printer cannot distinguish between fax and voice calls in this case; if you suspect the call is a voice call, you need to answer it before the printer answers the call. To set up the printer to answer calls automatically, turn on the **Auto Answer** setting.
- If you set up the printer to answer faxes **manually**, you must be available to respond in person to incoming fax calls or the printer cannot receive faxes. To set up the printer to answer calls manually, turn off the **Auto Answer** setting.

7. Run a fax test.

If you pick up the phone before the printer answers the call and hear fax tones from a sending fax machine, you need to answer the fax call manually.

If you use your phone line for voice, fax, and your computer dial-up modem, follow these directions to set up your fax.

If you encounter problems setting up the printer with optional equipment, contact your local service provider or vendor for further assistance.

Shared voice/fax with computer DSL/ADSL modem

Use these instructions if your computer has a DSL/ADSL modem

Figure B-10 Back view of the printer

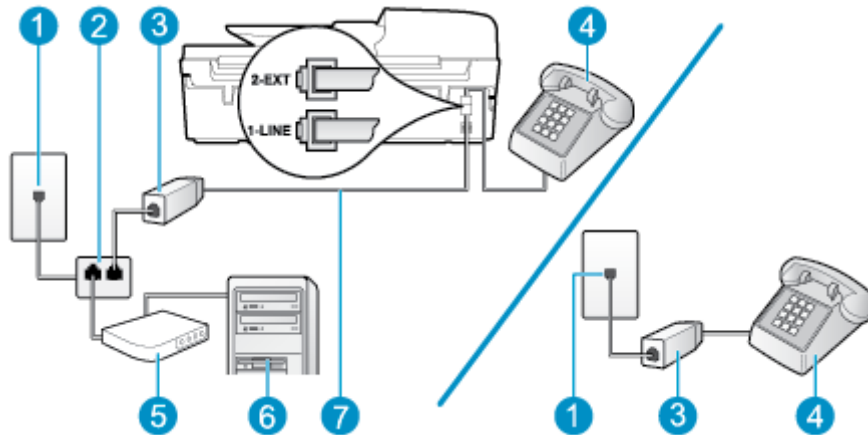

| | |
|---|---|
| 1 | Telephone wall jack |
| 2 | Parallel splitter |
| 3 | DSL/ADSL filter |
| 4 | Telephone |
| 5 | Computer DSL/ADSL modem |
| 6 | Computer |
| 7 | Use the phone cord provided to connect to the 1-LINE port on the back of the printer. You might need to connect the supplied phone cord to the adapter provided for your country/region. |



 **NOTE:** You need to purchase a parallel splitter. A parallel splitter has one RJ-11 port on the front and two RJ-11 ports on the back. Do not use a 2-line phone splitter, a serial splitter, or a parallel splitter which has two RJ-11 ports on the front and a plug on the back.

Figure B-11 Example of a parallel splitter



To set up the printer with a computer DSL/ADSL modem

1. Obtain a DSL filter from your DSL provider.

 **NOTE:** Phones in other parts of the home/office sharing the same phone number with DSL service need to be connected to additional DSL filters to avoid noise when making voice calls.

2. Using the phone cord supplied in the box with the printers, connect one end to the DSL filter, then connect the other end to the port labeled 1_LINE on the back of the printer.

 **NOTE:** You might need to connect the supplied phone cord to the adapter provided for your country/region.

If you do not use the supplied cord to connect from the DSL filter to the back of the printer, you might not be able to fax successfully. This special phone cord is different from the phone cords you might already have in your home or office.

3. If you have a parallel-type phone system, remove the white plug from the port labeled 2_EXT on the back of the printer, and then connect a phone to this port.
4. Connect the DSL filter to the parallel splitter.
5. Connect the DSL modem to the parallel splitter.
6. Connect the parallel splitter to the wall jack.
7. Run a fax test.

When the phone rings, the printer automatically answers after the number of rings you set in the **Rings to Answer** setting. The printer begins emitting fax reception tones to the sending fax machine and receives the fax.

If you encounter problems setting up the printer with optional equipment, contact your local service provider or vendor for further assistance.

Case I: Shared voice/fax line with answering machine

If you receive both voice calls and fax calls at the same phone number, and you also have an answering machine that answers voice calls at this phone number, set up the printer as described in this section.

Figure B-12 Back view of the printer

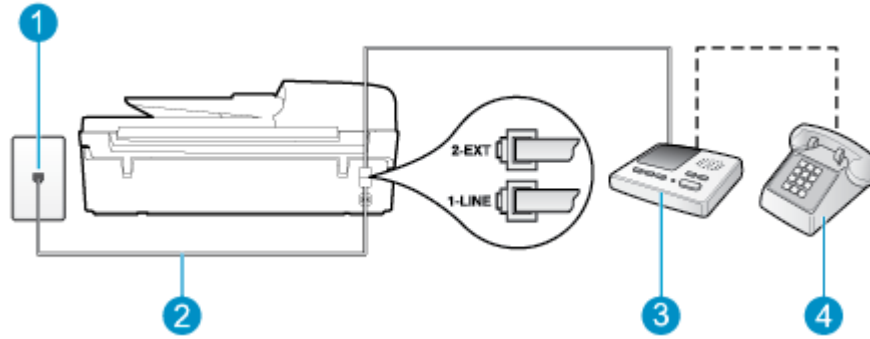

| | |
|---|---|
| 1 | Telephone wall jack |
| 2 | Use the phone cord provided to connect to the 1_LINE port on the back of the printer. You might need to connect the supplied phone cord to the adapter provided for your country/region. |
| 3 | Answering machine |
| 4 | Telephone (optional) |

To set up the printer with a shared voice/fax line with answering machine

1. Remove the white plug from the port labeled 2_EXT on the back of the printer.
2. Unplug your answering machine from the telephone wall jack, and connect it to the port labeled 2_EXT on the back of the printer.

NOTE: If you do not connect your answering machine directly to the printer, fax tones from a sending fax machine might be recorded on your answering machine, and you might not receive faxes with the printer.
3. Using the phone cord supplied in the box with the printer, connect one end to your telephone wall jack, then connect the other end to the port labeled 1_LINE on the back of the printer.

NOTE: You might need to connect the supplied phone cord to the adapter provided for your country/region.

If you do not use the supplied cord to connect from the telephone wall jack to the printer, you might not be able to fax successfully. This special phone cord is different from the phone cords you might already have in your home or office.
4. (Optional) If your answering machine does not have a built-in phone, for convenience you might want to connect a phone to the back of your answering machine at the "OUT" port.

NOTE: If your answering machine does not let you connect an external phone, you can purchase and use a parallel splitter (also known as a coupler) to connect both the answering machine and telephone to the printer. You can use standard phone cords for these connections.
5. Turn on the **Auto Answer** setting.
6. Set your answering machine to answer after a low number of rings.

7. Change the **Rings to Answer** setting on the printer to the maximum number of rings supported by your printer. (The maximum number of rings varies by country/region.)
8. Run a fax test.

When the phone rings, your answering machine answers after the number of rings you have set, and then plays your recorded greeting. The printer monitors the call during this time, "listening" for fax tones. If incoming fax tones are detected, the printer emits fax reception tones and receives the fax; if there are no fax tones, the printer stops monitoring the line and your answering machine can record a voice message.

If you encounter problems setting up the printer with optional equipment, contact your local service provider or vendor for further assistance.

Case J: Shared voice/fax line with computer modem and answering machine

If you receive both voice calls and fax calls at the same phone number, and you also have a computer modem and answering machine connected on this phone line, set up the printer as described in this section.

NOTE: Since your computer dial-up modem shares the phone line with the printer, you cannot use both your modem and the printer simultaneously. For example, you cannot use the printer for faxing while you are using your computer dial-up modem to send an email or access the Internet.

- [Shared voice/fax line with computer dial-up modem and answering machine](#)
- [Shared voice/fax line with computer DSL/ADSL modem and answering machine](#)

Shared voice/fax line with computer dial-up modem and answering machine

There are two different ways to set up the printer with your computer based on the number of phone ports on your computer. Before you begin, check your computer to see if it has one or two phone ports.

NOTE: If your computer has only one phone port, you need to purchase a parallel splitter (also called a coupler), as shown in the illustration. (A parallel splitter has one RJ-11 port on the front and two RJ-11 ports on the back. Do not use a two-line phone splitter, a serial splitter, or a parallel splitter which has two RJ-11 ports on the front and a plug on the back.)

Figure B-13 Example of a parallel splitter



Figure B-14 Back view of the printer

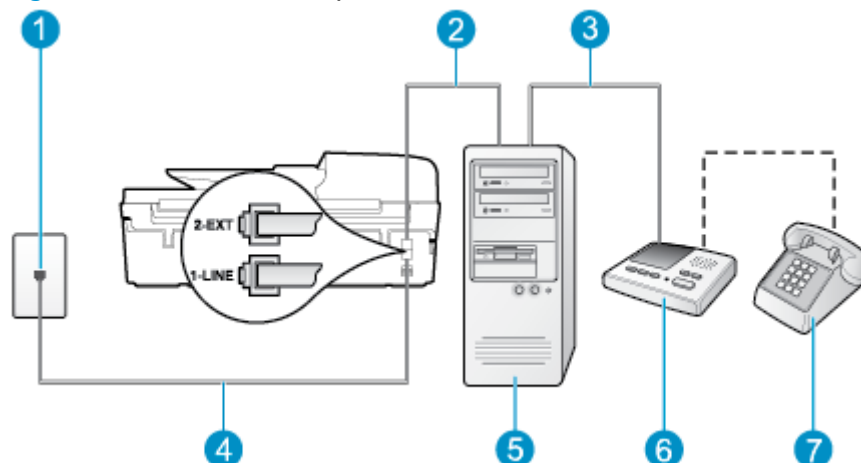

| | |
|---|--|
| 1 | Telephone wall jack |
| 2 | "IN" phone port on your computer |
| 3 | "OUT" phone port on your computer |
| 4 | Use the phone cord supplied in the box with the printer to connect to the 1_LINE port. You might need to connect the supplied phone cord to the adapter provided for your country/region. |
| 5 | Computer with modem |
| 6 | Answering machine |
| 7 | Telephone (optional) |

To set up the printer on the same phone line as a computer with two phone ports

1. Remove the white plug from the port labeled 2_EXT on the back of the printer.
2. Find the phone cord that connects from the back of your computer (your computer dial-up modem) to a telephone wall jack. Disconnect the cord from the telephone wall jack and plug it into the port labeled 2_EXT on the back of the printer.
3. Unplug your answering machine from the telephone wall jack, and connect it to the port labeled "OUT" on the back of the computer (the computer dial-up modem).
4. Using the phone cord supplied in the box with the printer, connect one end to your telephone wall jack, then connect the other end to the port labeled 1_LINE on the back of the printer.



NOTE: You might need to connect the supplied phone cord to the adapter provided for your country/region.

If you do not use the supplied cord to connect from the telephone wall jack to the printer, you might not be able to fax successfully. This special phone cord is different from the phone cords you might already have in your home or office.

5. (Optional) If your answering machine does not have a built-in phone, for convenience you might want to connect a phone to the back of your answering machine at the "OUT" port.



NOTE: If your answering machine does not let you connect an external phone, you can purchase and use a parallel splitter (also known as a coupler) to connect both the answering machine and telephone to the printer. You can use standard phone cords for these connections.

6. If your modem software is set to receive faxes to your computer automatically, turn off that setting.



NOTE: If you do not turn off the automatic fax reception setting in your modem software, the printer cannot receive faxes.

7. Turn on the **Auto Answer** setting.
8. Set your answering machine to answer after a low number of rings.
9. Change the **Rings to Answer** setting on the printer to the maximum number of rings supported by the product. (The maximum number of rings varies by country/region.)
10. Run a fax test.

When the phone rings, your answering machine answers after the number of rings you have set, and then plays your recorded greeting. The printer monitors the call during this time, "listening" for fax tones. If incoming fax tones are detected, the printer emits fax reception tones and receives the fax; if there are no fax tones, the printer stops monitoring the line and your answering machine can record a voice message.

If you encounter problems setting up the printer with optional equipment, contact your local service provider or vendor for further assistance.

Shared voice/fax line with computer DSL/ADSL modem and answering machine

Figure B-15 Back view of the printer

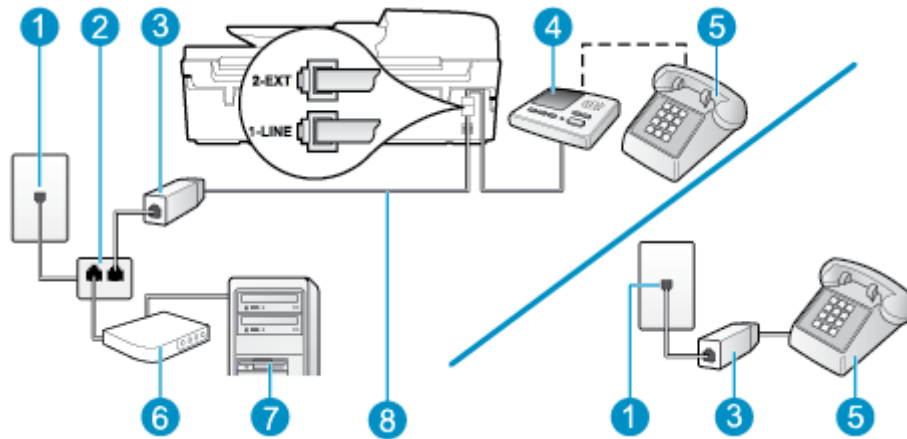

| | |
|---|--|
| 1 | Telephone wall jack |
| 2 | Parallel splitter |
| 3 | DSL/ADSL filter |
| 4 | Answering machine |
| 5 | Telephone (optional) |
| 6 | DSL/ADSL modem |
| 7 | Computer |
| 8 | Phone cord provided with the printer connected to the 1_LINE port on the back of the printer You might need to connect the supplied phone cord to the adapter provided for your country/region. |



NOTE: You need to purchase a parallel splitter. A parallel splitter has one RJ-11 port on the front and two RJ-11 ports on the back. Do not use a 2-line phone splitter, a serial splitter, or a parallel splitter which has two RJ-11 ports on the front and a plug on the back.

Figure B-16 Example of a parallel splitter



To set up the printer with a computer DSL/ADSL modem

1. Obtain a DSL/ADSL filter from your DSL/ADSL provider.

 **NOTE:** Phones in other parts of the home/office sharing the same phone number with DSL/ADSL service need to be connected to additional DSL/ADSL filters, to avoid noise when making voice calls.

2. Using the phone cord supplied in the box with the printer, connect one end to the DSL/ADSL filter, then connect the other end to the port labeled 1_LINE on the back of the printer.

 **NOTE:** You might need to connect the supplied phone cord to the adapter provided for your country/region.

If you do not use the supplied cord to connect from the DSL/ADSL filter to the printer, you might not be able to fax successfully. This special phone cord is different from the phone cords you might already have in your home or office.

3. Connect the DSL/ADSL filter to the splitter.
4. Unplug the answering machine from the telephone wall jack, and connect it to the port labeled 2_EXT on the back of the printer.

 **NOTE:** If you do not connect your answering machine directly to the printer, fax tones from a sending fax machine might be recorded on your answering machine, and you might not receive faxes with the printer.

5. Connect the DSL modem to the parallel splitter.
6. Connect the parallel splitter to the wall jack.
7. Set your answering machine to answer after a low number of rings.
8. Change your **Rings to Answer** setting on the printer to the maximum number of rings supported by the printer.

 **NOTE:** The maximum number of rings varies by country/region.

9. Run a fax test.

When the phone rings, your answering machine answers after the number of rings you have set, and then play your recorded greeting. The printer monitors the call during this time, “listening” for fax tones. If incoming fax tones are detected, the printer emits fax reception tones and receive the fax; if there are no fax tones, the printer stops monitoring the line and your answering machine can record a voice message.

If you use the same phone line for telephone, fax, and have a computer DSL modem, follow these instructions to set up your fax.

If you encounter problems setting up the printer with optional equipment, contact your local service provider or vendor for further assistance.

Case K: Shared voice/fax line with computer dial-up modem and voice mail

If you receive both voice calls and fax calls at the same phone number, use a computer dial-up modem on the same phone line, and subscribe to a voice mail service through your telephone company, set up the printer as described in this section.

 **NOTE:** You cannot receive faxes automatically if you have a voice mail service at the same phone number you use for fax calls. You must receive faxes manually; this means you must be available to respond in person to incoming fax calls. If you want to receive faxes automatically instead, contact your telephone company to subscribe to a distinctive ring service, or to obtain a separate phone line for faxing.

Since your computer dial-up modem shares the phone line with the printer, you cannot use both your modem and the printer simultaneously. For example, you cannot use the printer for faxing if you are using your computer dial-up modem to send an email or access the Internet.

There are two different ways to set up the printer with your computer based on the number of phone ports on your computer. Before you begin, check your computer to see if it has one or two phone ports.

- If your computer has only one phone port, you need to purchase a parallel splitter (also called a coupler), as shown in the illustration. (A parallel splitter has one RJ-11 port on the front and two RJ-11 ports on the back. Do not use a two-line phone splitter, a serial splitter, or a parallel splitter which has two RJ-11 ports on the front and a plug on the back.)

Figure B-17 Example of a parallel splitter



- If your country/region is listed in the table, you probably have a parallel-type telephone system. In a parallel-type phone system, you are able to connect shared telephone equipment to the phone line by using the "2-EXT" port on the back of the printer.

Figure B-18 Back view of the printer

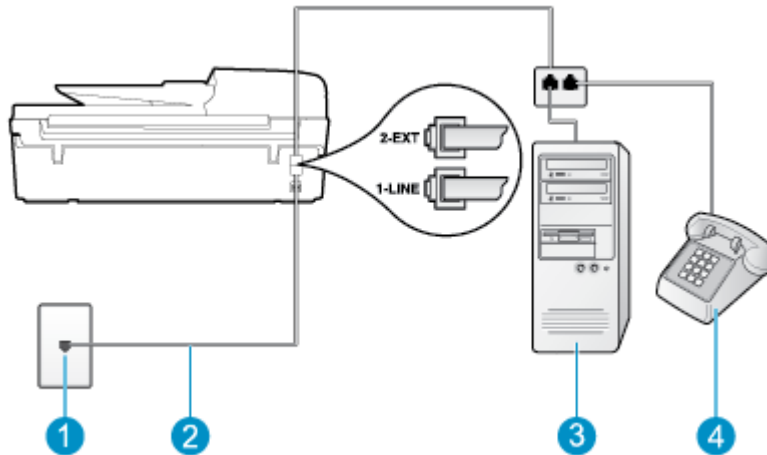

| | |
|---|--|
| 1 | Telephone wall jack |
| 2 | Use the phone cord supplied in the box with the printer to connect to the 1_LINE port. You might need to connect the supplied phone cord to the adapter provided for your country/region. |
| 3 | Computer with modem |
| 4 | Telephone |

To set up the printer on the same phone line as a computer with two phone ports

1. Remove the white plug from the port labeled 2_EXT on the back of the printer.
2. Find the phone cord that connects from the back of your computer (your computer dial-up modem) to a telephone wall jack. Disconnect the cord from the telephone wall jack and plug it into the port labeled 2_EXT on the back of the printer.
3. Connect a phone to the "OUT" port on the back of your computer dial-up modem.

4. Using the phone cord supplied in the box with the printer, connect one end to your telephone wall jack, then connect the other end to the port labeled 1_LINE on the back of the printer.



NOTE: You might need to connect the supplied phone cord to the adapter provided for your country/region.

If you do not use the supplied cord to connect from the telephone wall jack to the printer, you might not be able to fax successfully. This special phone cord is different from the phone cords you might already have in your home or office.

5. If your modem software is set to receive faxes to your computer automatically, turn off that setting.



NOTE: If you do not turn off the automatic fax reception setting in your modem software, the printer cannot receive faxes.

6. Turn off the **Auto Answer** setting.

7. Run a fax test.

You must be available to respond in person to incoming fax calls, or the printer cannot receive faxes.

If you encounter problems setting up the printer with optional equipment, contact your local service provider or vendor for further assistance.

Serial-type fax setup

For information on setting up the printer for faxing using a serial-type phone system, see the Fax Configuration web site for your country/region.

| | |
|----------------------|--|
| Austria | www.hp.com/at/faxconfig |
| Germany | www.hp.com/de/faxconfig |
| Switzerland (French) | www.hp.com/ch/fr/faxconfig |
| Switzerland (German) | www.hp.com/ch/de/faxconfig |
| United Kingdom | www.hp.com/uk/faxconfig |
| Finland | www.hp.fi/faxconfig |
| Denmark | www.hp.dk/faxconfig |
| Sweden | www.hp.se/faxconfig |
| Norway | www.hp.no/faxconfig |
| Netherlands | www.hp.nl/faxconfig |
| Belgium (Dutch) | www.hp.be/nl/faxconfig |
| Belgium (French) | www.hp.be/fr/faxconfig |
| Portugal | www.hp.pt/faxconfig |
| Spain | www.hp.es/faxconfig |
| France | www.hp.com/fr/faxconfig |
| Ireland | www.hp.com/ie/faxconfig |
| Italy | www.hp.com/it/faxconfig |

Test fax setup

You can test your fax setup to check the status of the printer and to make sure it is set up correctly for faxing. Perform this test after you have completed setting up the printer for faxing. The test does the following:

- Tests the fax hardware
- Verifies the correct type of phone cord is connected to the printer
- Checks that the phone cord is plugged into the correct port
- Checks for a dial tone
- Tests the status of your phone line connection
- Checks for an active phone line

The printer prints a report with the results of the test. If the test fails, review the report for information on how to fix the problem and rerun the test.

To test fax setup via the printer control panel

1. Set up the printer for faxing according to your particular home or office setup instructions.
2. Make sure the ink cartridges are installed, and that full-size paper is loaded in the input tray before starting the test.
3. From the Home screen on the printer display, press the **Up** and **Down** buttons to select **Fax**, and then press **OK**.
4. Select **Settings**, select **Advanced Settings**, select **Fax Setup Wizard**, and then follow on-screen instructions.

The printer displays the status of the test on the display and prints a report.

5. Review the report.
 - If the test passes and you are still having problems faxing, check the fax settings listed in the report to verify the settings are correct. A blank or incorrect fax setting can cause problems faxing.
 - If the test fails, review the report for more information on how to fix any problems found.

Index

A

ADSL, fax setup with
parallel phone systems 143
after the support period 112
answer ring pattern
parallel phone systems 145
answering machine
set up with fax (parallel phone
systems) 154
set up with fax and modem 156

B

buttons, control panel 6

C

computer modem
shared with fax (parallel phone
systems) 148
shared with fax and answering
machine (parallel phone
systems) 156
shared with fax and voice line
(parallel phone systems) 151
shared with fax and voice mail
(parallel phone systems) 159
control panel
buttons 6
features 6
copy
specifications 122
customer support
warranty 112

D

dial-up modem
shared with fax (parallel phone
systems) 148

shared with fax and answering
machine (parallel phone
systems) 156
shared with fax and voice line
(parallel phone systems) 151
shared with fax and voice mail
(parallel phone systems) 159
distinctive ringing
parallel phone systems 145
DSL, fax setup with
parallel phone systems 143

E

environment
Environmental product
stewardship program 125
environmental specifications
121

F

fax
answering machine and modem,
shared with (parallel phone
systems) 156
answering machine, set up
(parallel phone systems) 154
distinctive ringing setup (parallel
phone systems) 145
DSL, set up (parallel phone
systems) 143
fax specifications 123
Internet Protocol, over 60
ISDN line, set up (parallel phone
systems) 144
modem and answering machine,
shared with (parallel phone
systems) 156

modem and voice line, shared
with (parallel phone systems)
151
modem and voice mail, shared
with (parallel phone systems)
159
modem, shared with (parallel
phone systems) 148
PBX system, set up (parallel
phone systems) 144
separate line setup (parallel
phone systems) 142
shared phone line setup (parallel
phone systems) 146
test setup 163
voice mail, set up (parallel phone
systems) 147

I

interface card 82, 83
Internet Protocol
fax, using 60
ISDN line, set up with fax
parallel phone systems 144

M

modem
shared with fax (parallel phone
systems) 148
shared with fax and answering
machine (parallel phone
systems) 156
shared with fax and voice line
(parallel phone systems) 151
shared with fax and voice mail
(parallel phone systems) 159

N

network
interface card 82, 83

P

paper
recommended types 26

parallel phone systems
answering machine setup 154
distinctive ringing setup 145
DSL setup 143
ISDN setup 144
modem and answering machine setup 156
modem and voice mail setup 159
modem setup 148
modem shared with voice line setup 151
PBX setup 144
separate line setup 142
shared line setup 146

PBX system, set up with fax
parallel phone systems 144

phone support 111
phone support period
period for support 112

print
specifications 122

R

recycle
ink cartridges 126

regulatory notices 129
regulatory model identification number 129
wireless statements 133

S

scan
scan specifications 122

setup
answering machine (parallel phone systems) 154
answering machine and modem (parallel phone systems) 156
computer modem (parallel phone systems) 148
computer modem and answering machine (parallel phone systems) 156

computer modem and voice line (parallel phone systems) 151
computer modem and voice mail (parallel phone systems) 159
distinctive ringing (parallel phone systems) 145
DSL (parallel phone systems) 143
ISDN line (parallel phone systems) 144
PBX system (parallel phone systems) 144
separate fax line (parallel phone systems) 142
shared phone line (parallel phone systems) 146
test fax 163
voice mail (parallel phone systems) 147
voice mail and computer modem (parallel phone systems) 159

support process 111
system requirements 121

T

technical information
copy specifications 122
environmental specifications 121
fax specifications 123
print specifications 122
scan specifications 122
system requirements 121

tests, fax
setup 163

V

voice mail
set up with fax (parallel phone systems) 147
set up with fax and computer modem (parallel phone systems) 159

VoIP 60

W

warranty 112