

HP Photosmart 7400 series User's Guide

English



Copyright information

© Copyright 2004 Hewlett-Packard Development Company, L.P.

The information contained herein is subject to change without notice. Reproduction, adaptation, or translation without prior written permission is prohibited, except as allowed under the copyright laws.

Notice

The only warranties for HP products and services are set forth in the express warranty statements accompanying such products and services. Nothing herein should be construed as constituting an additional warranty. HP shall not be liable for technical or editorial errors or omissions contained herein.

The Hewlett-Packard Company shall not be liable for incidental or consequential damages in connection with, or arising out of the furnishing, performance, or use of this document and the program material which it describes.

Trademarks

HP, the HP logo, and Photosmart are property of Hewlett-Packard Development Company, L.P.

The Secure Digital logo is a trademark of the SD Association.

Microsoft and Windows are registered trademarks of Microsoft Corporation.

CompactFlash, CF, and the CF logo are trademarks of the CompactFlash Association (CFA).

Memory Stick, Memory Stick Duo, Memory Stick PRO, and Memory Stick PRO Duo are trademarks or registered trademarks of Sony Corporation.

MultiMediaCard is a trademark of Infineon Technologies AG of Germany, and is licensed to the MMCA (MultiMediaCard Association).

Microdrive is a trademark of Hitachi Global Storage Technologies.

SmartMedia is a trademark of Toshiba Corporation.

xD-Picture Card is a trademark of Fuji Photo Film Co., Ltd., Toshiba Corporation, and Olympus Optical Co., Ltd.

Mac, the Mac logo, and Macintosh are registered trademarks of Apple Computer, Inc.

Other brands and their products are trademarks or registered trademarks of their respective holders.

The embedded software in the printer is based in part on the work of the Independent JPEG Group.

The copyrights to certain photos within this document are retained by the original owners.

Regulatory model identification number SDGOA-0401

For regulatory identification purposes, your product is assigned a Regulatory Model Number. The Regulatory Model Number for your product is SDGOA-0401. This regulatory number should not be confused with the marketing name (HP Photosmart 7400 series printer) or product number (Q3409A).

Safety information

Always follow basic safety precautions when using this product to reduce risk of injury from fire or electric shock.



Warning To prevent fire or shock hazard, do not expose this product to rain or any type of moisture.

- Read and understand all instructions in the *HP Photosmart 7400 series Quick Start* booklet.
- Use only a grounded electrical outlet when connecting the unit to a power source. If you do not know whether the outlet is grounded, check with a qualified electrician.
- Observe all warnings and instructions marked on the product.
- Unplug this product from wall outlets before cleaning.
- Do not install or use this product near water or when you are wet.
- Install the product securely on a stable surface.
- Install the product in a protected location where no one can step on or trip over the power cord, and where the power cord will not be damaged.
- If the product does not operate normally, see the

troubleshooting information in the onscreen HP Photosmart Printer Help.

- There are no operator serviceable parts inside. Refer servicing to qualified service personnel.
- Use in a well-ventilated area.

Contents

1	Welcome	3
	Printer parts	4
2	Getting ready to print	7
	Loading paper	7
	Choosing the right paper	7
	Loading paper in the printer	8
	Using print cartridges	10
	Inserting memory cards	13
	Supported file formats	13
	Inserting a memory card	13
	Viewing photos on your computer screen	16
	Removing a memory card	16
3	Printing without a computer	17
	Getting your photos from camera to printer	17
	Deciding which photos to print	18
	Choosing a layout	19
	Selecting photos to print	19
	Printing your photos	20
4	Getting connected	21
	Connecting to a computer	21
	Saving your photos to a computer	21
	Connecting to other people through HP Instant Share	22
5	Printing from a computer	23
6	Care and maintenance	27
	Updating printer software	27
	Cleaning and maintaining the printer	27
	Cleaning the exterior of the printer	27
	Cleaning the print cartridges	27
	Cleaning the print cartridge contacts	28
	Aligning the print cartridges	28
	Maintaining the quality of photo paper	28
	Storing photo paper	28
	Handling photo paper	29
	Storing the printer and print cartridges	29
	Storing the printer	29
	Storing the print cartridges	30
7	Troubleshooting	31
	Printer hardware problems	31
	Printing problems	33
	Printer screen status indicators	36
8	HP Customer Care	37
	HP Customer Care by phone	37
	Placing a call	39
9	Specifications	41
	System requirements	41

Printer specifications	42
Environmental statements	46
Protecting the environment	46
Ozone production	46
Energy consumption	46
Paper use	46
Plastics	46
Material safety data sheets	46
Recycling program	46
Index	47

1 Welcome

Thank you for purchasing an HP Photosmart 7400 series printer! With your new photo printer you can print beautiful photos and save photos to your computer.

This guide primarily explains how to print without connecting a computer. To learn how to print from your computer, install the printer software and view the onscreen Help. For an overview of using a computer and the printer together, see [Printing from a computer](#).



Read this guide to learn how to quickly and easily print beautiful borderless photos [Choosing a layout](#).

Your new printer comes with the following documentation:

- **Quick Start** — The *HP Photosmart 7400 series Quick Start* booklet contains quick and easy instructions to help you set up the printer and print your first photo.
- **User's Guide** — The *HP Photosmart 7400 series User's Guide* is the book you are reading. This book describes the basic features of the printer, explains how to use the printer without connecting a computer, and contains hardware troubleshooting information.
- **HP Photosmart Printer Help** — The onscreen HP Photosmart Printer Help describes how to use the printer with a computer and contains software troubleshooting information.

After you have installed the printer software on your computer, you can view the onscreen Help:

- **Windows PC:** From the **Start** menu, select **Programs** (in Windows XP, select **All Programs**)> **HP** > **Photosmart 320, 370, 7400, 7800, 8100, 8400, 8700 Series** > **Photosmart Help**.
- **Macintosh:** Select **Help** > **Mac Help** in the Finder, then select **Library** > **HP Photosmart Printer Help for Macintosh**.

Printer parts

Front view

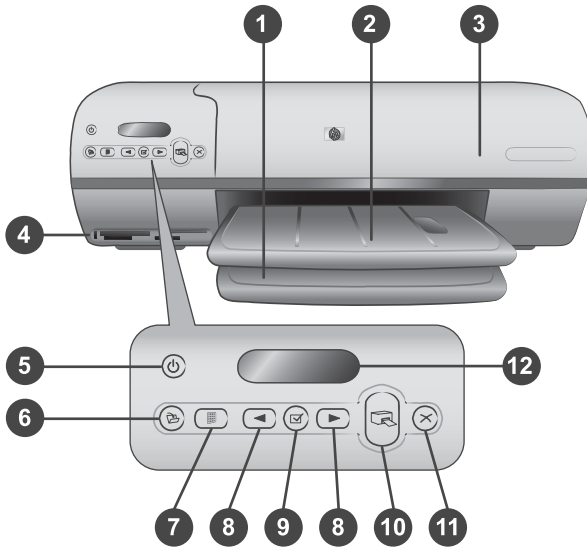

1. **In tray** Load paper here.
2. **Out tray** After printing, remove your photos and documents from this tray. Pull out the extender to hold larger-size paper.
3. **Top cover** Raise the top cover to access the Photo cassette, the print cartridges, and the paper-width guide.
4. **Memory card slots** Insert memory cards here. See [Inserting memory cards](#) for more information about the memory card slots.
5. **On light** Press to turn the printer on or off. The On light keeps you informed about the printer: Green (printer is on), green and flashing (printer is busy), red and flashing (printer requires attention).
6. **Save** Press to save your photos to a connected computer.
7. **Print index** Press to print a photo index of all photos on a memory card. See [Deciding which photos to print](#).
8. **Select Photos** ◀ **and** ▶ Use to scroll through photos on a memory card.
9. **Select Photos** ☑ Press this button to select or deselect the displayed photo index number for printing.
10. **Print** Print the selected photos.
11. **Cancel** Cancel the current print job.
- 12 **Printer screen** View the photo index numbers, photo selection status, paper status, and print cartridge status.

Inside view

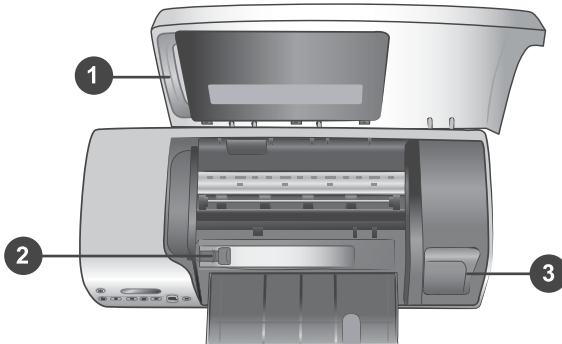

1. **Photo cassette** Load tabbed 4 x 6.5 inch with .5 inch tab (10 x 15 cm) photo paper, untabbed 4 x 6 inch (10 x 15 cm) photo paper, or other supported small media into this cassette, and insert the cassette into the In tray for printing.
2. **Paper-width guide** Adjust this guide for different paper widths.
3. **Print cartridge storage area** Insert any unused print cartridge in the print cartridge protector that came with the printer, then store it here to keep it from drying out.

Rear view

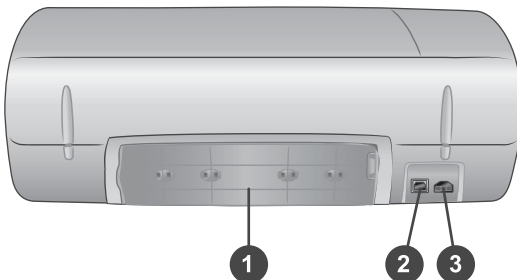

1. **Rear access door** Open this door to clear a paper jam.
2. **USB port** Connect a computer to the printer.
3. **Power port** Plug the power cord into the printer.

2 Getting ready to print

Before you begin, there are three easy procedures with which you should become familiar:

- Loading paper
- Using print cartridges
- Inserting a memory card

Loading paper

Learn how to choose the right paper for your print job and how to prepare and load the trays for printing.

Choosing the right paper

For a list of available HP-designed inkjet paper, or to purchase supplies, go to:

- www.hpshopping.com (U.S.)
- www.hp.com/go/supplies (Europe)
- www.hp.com/jp/supply_inkjet (Japan)
- www.hp.com/paper (Asia/Pacific)

To get the best results from the printer, choose from these high-quality HP photo papers.

To print	Use this paper
High-quality, long-lasting prints and enlargements	HP Premium Plus Photo Paper (also known as Colorfast Photo Paper in some countries/regions)
Medium-to-high-resolution images from scanners and digital cameras	HP Premium Photo Paper
Casual and business photos	HP Photo Paper HP Everyday Photo Paper
Text documents, draft versions, test and alignment pages	HP Premium Inkjet Paper

To keep your paper in good condition for printing:

- Store unused paper in its original packaging or in the resealable plastic bag that came with the printer.
- Keep the paper flat in a cool, dry place. If the corners curl, place the paper in a plastic bag and gently bend it in the opposite direction until it lies flat.
- Hold photo paper by the edges to avoid smears.

Loading paper in the printer



Paper loading tips:

- You can print photos and documents on a wide variety of paper sizes, from 3 x 5 inches (76 x 127 mm) up to 8.5 x 14 inches (216 x 356 mm), as well as on wide 8.5 inch (216 mm) banner paper.
- Before loading paper, slide out the paper-width guide to make room for the paper.
- Load only one type and size of paper at a time. Do not mix paper types or sizes in the In tray or the Photo cassette.
- Be careful not to load too much or too little paper, or it may be difficult for the printer to pick up a sheet of paper. For more information about the amount of paper to load in the In tray, see [Specifications](#).
- After loading paper, pull out the Out tray extender to hold larger-size printed pages.

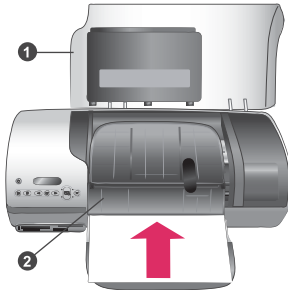
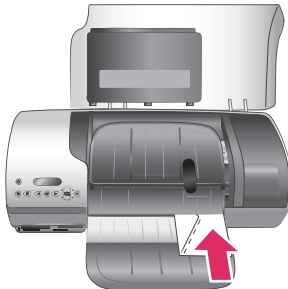
Use the directions in the following table to load the most commonly used paper sizes into the printer.

Paper type	How to load	Tray to load
<ul style="list-style-type: none"> • Letter or A4 paper • Transparencies • 8 x 10 inch (20 x 25 cm) photo paper • 5 x 7 inch (13 x 18 cm) photo paper • Envelopes 	<ol style="list-style-type: none"> 1. Raise the top cover. 2. Raise the Out tray all the way up. 3. Load plain paper, photo paper, or transparencies print side down in the In tray. Load envelopes with the front side down and with the flap on the left. Tuck the flaps inside the envelopes to avoid paper jams. 4. Lower the Out tray. 5. Adjust the paper-width guide to fit close to the edges of the paper without bending the paper. 6. Lower the top cover. 	<p>In tray – larger paper sizes</p>  <p>1) Top cover 2) Out tray</p> <p>In tray – envelopes</p> 

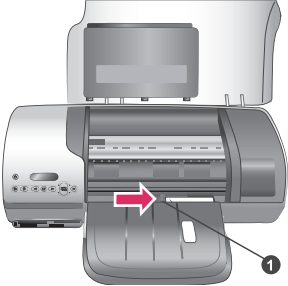
(continued)

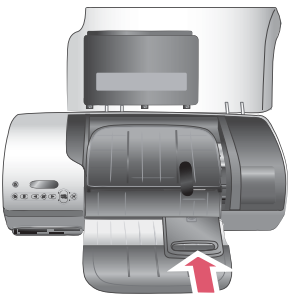
Paper type	How to load	Tray to load
		 <p>1) Paper-width guide</p>
<ul style="list-style-type: none">• 4 x 6 inch (10 x 15 cm) photo paper (with or without tab)• Index cards• Hagaki cards• L-size cards	<ol style="list-style-type: none">1. Remove any paper that's loaded in the In tray.2. Raise the top cover and remove the Photo cassette from its holder.3. Load up to 20 sheets of paper into the Photo cassette, print side down. If you are using tabbed paper, insert the tabbed end first.4. Raise the Out tray.5. Line up the Photo cassette on the right side of the In tray, then slide it into the printer until it snaps into place.6. Lower the Out tray.7. Lower the top cover.8. When you finish printing, remove the Photo cassette and store it in the holder inside the top cover.	<p>Photo cassette into the In tray</p>   

Using print cartridges

Your HP Photosmart 7400 series printer can print color and black-and-white photos. HP provides different types of print cartridges so you can choose the best cartridges for your project.



Tip See the back cover of this guide for the cartridge selection numbers you can use with this printer.

For optimum printing results, HP recommends using only HP print cartridges. Inserting a cartridge that is not in this table may invalidate your printer warranty.

Using the right print cartridges

To print...	Insert this print cartridge in the LEFT stall	Insert this print cartridge in the RIGHT stall
Full-color photos	Tri-color HP #57	Photo HP #58
Black-and-white photos	Tri-color HP #57	Photo HP #58
Sepia or antique photos	Tri-color HP #57	Photo HP #58
Text and colored line drawings	Tri-color HP #57	Black HP #56



Caution Check that you are using the correct print cartridges; see the back cover for the cartridge numbers you can use with this printer. Also note that HP does not recommend modifying or refilling HP cartridges. Damage that results from modifying or refilling HP cartridges is not covered by the HP warranty.

For the best print quality, HP recommends that you install retail print cartridges before the date stamped on the box.

Inserting and replacing the print cartridges

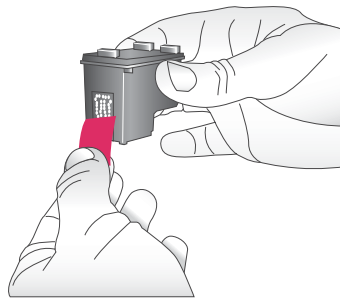

Preparing the printer and cartridges

1. Make sure the power is on and you have removed the cardboard from inside the device.
2. Raise the top cover of the printer.
3. Remove the bright pink tape from the cartridges.



Do not touch the ink nozzles or the copper-colored contacts, and do not re-tape the cartridges.

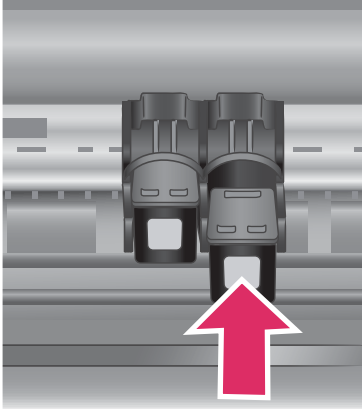

Inserting the cartridges

1. If you are replacing a Black or Photo cartridge, push down and pull outward on the cartridge in the **right** stall to remove it.
2. Hold the new Black or Photo cartridge with the label on top. Slide the cartridge at a slight upward angle into the **right** stall so the copper-colored contacts go in first. Push the cartridge until it snaps into place.

Caution To avoid print carriage jams, make sure the print cartridge snaps securely into place as you insert it.

3. Repeat the previous step to install the Tri-color cartridge in the **left** stall.
4. Lower the top cover.

You must install both cartridges in order for the printer to work normally.

Tip Ink-backup Printing Mode lets you keep printing even if one of the cartridges fails or runs out of ink. Remove the cartridge and close the top cover to enter Ink-backup Printing Mode. The printer continues to print, but at a slower speed and with inferior print quality. Replace the empty cartridge as soon as possible.

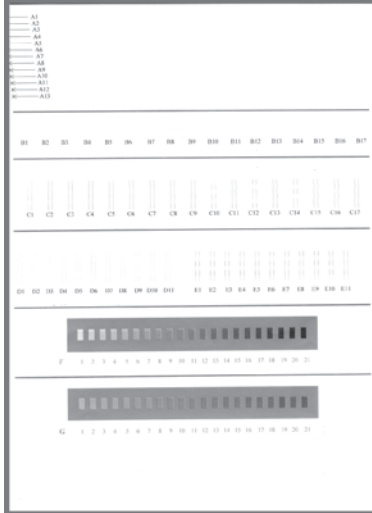

For optimal print quality and speed, align new print cartridges immediately after installing them. Make sure the printer is on and connected to a computer.

Aligning the cartridges

1. Load plain paper in the In tray.

If you are using a Windows computer:

- a. Right-click on the HP Photosmart printer icon in your Windows taskbar.
- b. Select **Open HP Photosmart 7400 Series Toolbox**.
- c. From the **Device Services** tab, click **Align the Printer**.

If you are using a Macintosh computer:

- a. Select **Calibrate** from the **HP Inkjet Utility** drop-down menu.
- b. Click **Align**.

2. Follow the onscreen instructions to complete the cartridge alignment.

See [Aligning the print cartridges](#).

When you are not using a print cartridge



Whenever you remove a filled (not empty) print cartridge from the printer, store it in the print cartridge protector. The cartridge protector keeps the ink from drying out when the cartridge is not being used. Failure to properly store your cartridge can cause the cartridge to malfunction.

- To insert a cartridge into the cartridge protector, slide the cartridge into the protector at a slight angle and snap it securely into place.

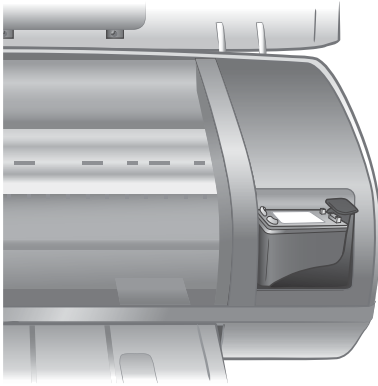

Once you have inserted a cartridge into the cartridge protector, place it in the storage area located in the printer.

Inserting memory cards

After you have taken pictures with a digital camera, you can remove the memory card from the camera and insert it into the printer to view and print your photos. The printer can read the following types of memory cards: CompactFlash™, Memory Sticks, Microdrive™, MultiMediaCard™, Secure Digital™, SmartMedia™, and xD-Picture Card™.



Caution Using any other type of memory card may damage the memory card and the printer.

Supported file formats

The printer can recognize and print JPEG and uncompressed TIFF files directly from the memory card. If your digital camera saves photos in other file formats, save the files to your computer and print them using a software application. For more information, see the onscreen HP Photosmart Printer Help.

Inserting a memory card

Find your memory card in the following table and use the instructions to insert the card into the printer.









Guidelines:

- Insert only one memory card at a time.
- Gently push the memory card into the printer until it stops. The memory card does not insert all the way into the printer; do not try to force it.
- When the memory card is inserted correctly, the Memory Card light flashes and then remains solid green.









Caution 1 Inserting the memory card any other way may damage the card and the printer.

Caution 2 Do not pull out a memory card while the Memory Card light is flashing green. For more information, see [Removing a memory card](#).

Memory card	Slot	How to insert the memory card
CompactFlash 	Top-left slot	<ul style="list-style-type: none"> • Front label faces up, and if the label has an arrow, the arrow points toward the printer • Edge with metal pinholes goes into the printer first 
Memory Stick 	Bottom-right slot	<ul style="list-style-type: none"> • Angled corner is on the left • Metal contacts face down • If you are using a Memory Stick Duo™ or Memory Stick PRO Duo™ card, attach the adapter that came with the card before you insert the card into the printer 
Microdrive 	Top-left slot	<ul style="list-style-type: none"> • Front label faces up, and if the label has an arrow, the arrow points toward the printer • Edge with metal pinholes goes into the printer first 
MultiMediaCard 	Bottom-left slot	<ul style="list-style-type: none"> • Angled corner is on the right • Metal contacts face down 

(continued)

Memory card	Slot	How to insert the memory card
Secure Digital 	Bottom-left slot	<ul style="list-style-type: none">• Angled corner is on the right• Metal contacts face down 
SmartMedia 	Upper portion of the top-right double slot	<ul style="list-style-type: none">• Angled corner is on the left• Metal contacts face down 
xD-Picture Card 	Lower right portion of the top-right double slot	<ul style="list-style-type: none">• Curved side of card points toward you• Metal contacts face down 

Viewing photos on your computer screen

When the printer is connected to a computer, you can insert a memory card in the printer and view the photos on your computer screen. This Photo Viewer feature is automatic, so you don't need to do anything except insert your memory card into the printer. For information about how to connect the printer to your computer, see the *Quick Start* booklet. For information about selecting photos to print, see *Selecting photos to print*.

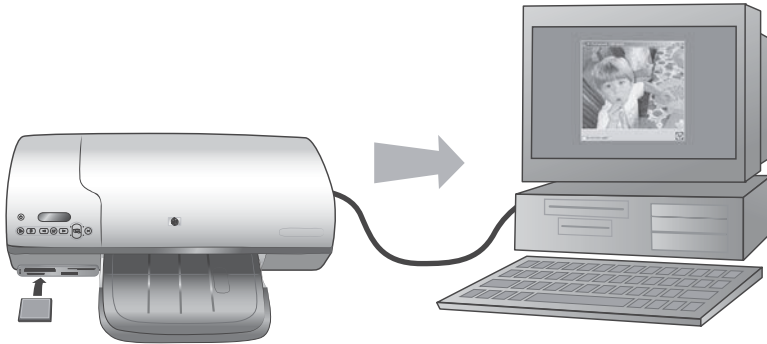

Photo Viewer lets you view memory card photos on your computer

Removing a memory card

Wait until the Memory Card light stops flashing and remains solid green, then gently pull the memory card to remove it from the printer.



Caution Do not pull out a memory card while the Memory Card light is flashing green. A flashing green light means that the printer is accessing the memory card. Removing a memory card while it is being accessed may damage the printer and the memory card or corrupt the information on the memory card.

3 Printing without a computer

The HP Photosmart 7400 series lets you print high-quality photos without even going near a computer. After setting up the printer using the instructions in the *HP Photosmart 7400 series Quick Start* booklet, refer to these steps for start-to-finish printing.

Getting your photos from camera to printer

Use these steps for start-to-finish printing in minutes!

Step 1

Insert a memory card
See Inserting memory cards.

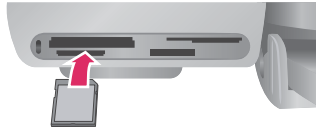

Step 2

Print an index page and
decide which photos to print
See Deciding which photos
to print.

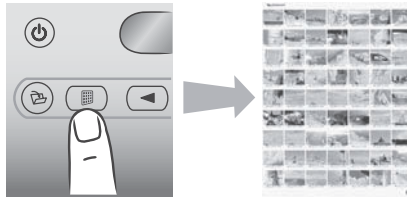

Step 3

Choose a layout and load
the right paper for the job
See Choosing a layout.

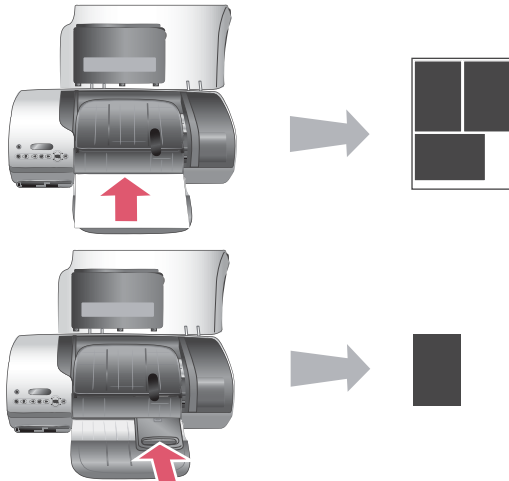

(continued)

Use these steps for start-to-finish printing in minutes!

Step 4

Insert the best print cartridges for the job.
See Inserting the cartridges.

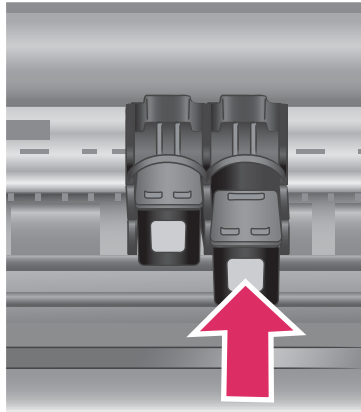
**Step 5**

Select photos to print.
See Selecting photos to print.

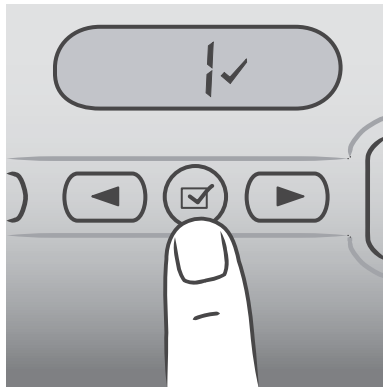
**Step 6**

Print your photos.
See Printing your photos.



Deciding which photos to print

Decide which photos to print by first printing a photo index. A photo index shows thumbnail views and index numbers for all the photos on a memory card (2000 maximum). You will use the index numbers on the printout to indicate which photos you want to print.

To print a photo index:

1. Insert a memory card.
2. Press **Print Index**.

Choosing a layout

You can choose from two different layout options each time you print. Your layout is determined by the type of paper that's loaded in the printer.

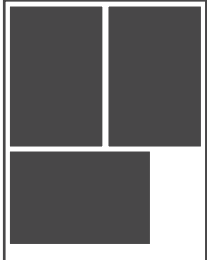
For this layout	Do this
<p>One 4 x 6 inch (10 x 15 cm) photo per sheet</p> 	<p>Load tabbed 4 x 6.5 inch with .5 inch tab (10 x 15 cm) photo paper or untabbed 4 x 6 inch (10 x 15 cm) photo paper into the Photo cassette. Whenever tabbed paper is loaded, the printer will automatically print a 4 x 6 inch (10 x 15 cm) borderless photo — just tear off the tab. When untabbed paper is loaded, the photo will have a border on one edge.</p>
<p>Three 4 x 6 inch (10 x 15 cm) photos per sheet</p> 	<p>Load letter or A4 paper into the In tray. Whenever this paper size (or a larger paper size) is loaded, the printer automatically prints three 4 x 6 inch (10 x 15 cm) photos per sheet.</p>

Selecting photos to print

If you want to...	Do this
<p>Select one or more photos</p>	<ol style="list-style-type: none"> 1. Make sure your memory card is still inserted in the printer. 2. Refer to the photo index you printed and decide which photo(s) to select for printing. Note their corresponding index numbers. 3. Press Select Photos ◀ or ▶ until the index number of the first photo you want to print appears on the printer screen. Press and hold the button to view the photo numbers rapidly. 4. Press Select Photos ☑ to select the photo for printing. A check mark appears next to the number on the printer screen to indicate your selection. 5. Repeat steps 2 and 3 until you have selected all the photos you want to print.

(continued)

If you want to...	Do this
	<p>Note To deselect a photo, press Select Photos <input checked="" type="checkbox"/> again to remove the check mark.</p>
<p>Select all photos on the memory card</p>	<ol style="list-style-type: none"> 1. Make sure your memory card is still inserted in the printer. 2. Press and hold Select Photos <input checked="" type="checkbox"/> for three seconds. The printer screen will briefly display nine dashes, and then check marks will appear next to each index number on the screen. <p>Note To deselect all photos, press and hold Select Photos <input checked="" type="checkbox"/> for three seconds.</p>

Printing your photos

To print photos from a memory card:

1. Insert a memory card.
2. Select one or more photos as described earlier in this section.
3. Press **Print**.



Note Some digital cameras have a menu feature that allows you to select photos on a memory card to be printed. These camera-selected photos are also called Digital Print Order Format (DPOF). If you have selected photos using the DPOF feature, **dPF** appears on the printer screen when you insert the memory card. Press **Print** to print these camera-selected photos, or press **Cancel** to deselect them.

4 Getting connected

Use your printer to stay connected to other devices and people.

Connecting to a computer

To do this...	You will need...
Print from your computer to the printer.	A Universal Serial Bus (USB) 2.0 full-speed compliant cable 10 feet (3 meters) or less in length. For instructions about connecting the printer with a USB cable, see the <i>Quick Start</i> booklet.
Save photos from a memory card (inserted in the printer) to your computer. (You can enhance and organize your photos in the HP Image Zone software. See <i>Saving your photos to a computer.</i>)	A USB cable as described above.
Share photos through HP Instant Share.	<ul style="list-style-type: none">• A USB cable as described above.• A computer with Internet access.

Saving your photos to a computer

When the printer is connected to a computer, you can save your photos to your Windows PC or Macintosh computer using the Save button on the printer's control panel.

1. Make sure the printer is connected to a computer at the USB port on the back of the printer, and that you have installed the software from the HP Photosmart 7400 series CD.
2. Insert a memory card into the printer.
3. Press **Save**.
4. Follow the onscreen instructions to save photos to the appropriate folder on your computer.



Note To stop saving photos to your computer, press **Cancel**.

Connecting to other people through HP Instant Share

Use HP Instant Share to share photos with friends and relatives using e-mail, online albums, or an online photo finishing service. The printer must be connected through a USB cable to a computer with Internet access and have all the HP software installed. If you try to use HP Instant Share and do not have all the required software installed or configured, a message prompts you through the required steps.

To use HP Instant Share to send photos:

1. Insert a memory card and select some photos.
2. Press **Save** to save the photos to your computer.
3. Use the HP Instant Share features of the HP Image Zone software to share your photos with others.



See the HP Image Zone onscreen Help for information about using HP Instant Share.

5 Printing from a computer



All HP photo printers come with the HP Image Zone software, which helps you do more with your photos than ever before. Use it to get creative with your pictures: edit them, share them, and create fun projects such as album pages.

You should also get to know the printer driver software. That's the interface that pops up whenever you print. It controls the resolution and color, and it usually chooses those settings automatically (which is fine when you're printing on plain paper). But if you're printing a digital photo, you'll want to get in there and fiddle around to produce the best-quality print.

For information on installing the HP Image Zone and printer driver software, see the *Quick Start* booklet. HP Image Zone is only installed if you choose the **Typical** installation option.

Software feature	Where to find information
<p data-bbox="221 656 417 682">HP Instant Share</p>  <p data-bbox="221 847 631 930">Use HP Instant Share to share photos with family and friends. HP Instant Share lets you easily:</p> <ul data-bbox="221 944 656 1150" style="list-style-type: none">• E-mail images using HP Instant Share without large file attachments• Create online albums to share, organize, and store photos• Order professionally processed prints online (availability varies by country/region)	<p data-bbox="687 656 1103 739">For more information about using HP Instant Share with your specific printer model, see Getting connected.</p> <p data-bbox="687 753 1110 836">In the onscreen Help, click Use the HP Image Zone, then click Share your images using HP Instant Share.</p>
<p data-bbox="221 1171 419 1197">Creative projects</p>  <p data-bbox="221 1385 643 1468">Think outside the photo album. The HP Image Zone lets you use your digital photos for creative projects such as:</p> <ul data-bbox="221 1482 448 1565" style="list-style-type: none">• Iron-on transfers• Banners• Calendars	<p data-bbox="687 1171 1128 1227">In the onscreen Help, click Use the HP Image Zone, then click Create projects.</p>

(continued)

Software feature	Where to find information
<p>Organize your photos</p>  <p>The HP Image Zone helps you keep on top of your digital photos and video clips by letting you:</p> <ul style="list-style-type: none"> • Organize your photos in albums • Search through your photos by date, keywords, and more • Index images automatically 	<p>In the onscreen Help, click Use the HP Image Zone, then click Manage your images.</p>
<p>Edit and enhance your photos</p>  <p>The HP Image Zone lets you:</p> <ul style="list-style-type: none"> • Do manual color correction and make other adjustments to improve your photos before you print them • Add text and other graphics • Resize your digital photos 	<p>In the onscreen Help, click Use the HP Image Zone, then click Edit your images.</p>
<p>Take control of printing</p> <p>Harness the power of the HP Photosmart printer driver. This software gives you full control over how your photos print. You can:</p> <ul style="list-style-type: none"> • Use advanced color settings to produce the highest-quality prints • Produce draft-quality prints to save on ink and photo media • Learn how to get the most out of your printer and your digital photos 	<p>In the onscreen Help, click HP Photosmart Printer Help. In the print dialog box itself, right-click any option and click the What's This? box to learn more about that option.</p>

Be sure to download the latest printer software update every couple of months to ensure you have the latest features and improvements.

To update the printer software

1. Make sure your computer is connected to the Internet.

2. From the Windows **Start** menu, select **Programs (All Programs** in Windows XP) > **HP > HP Software Update**.
3. Click **Next**. HP Software Update searches the HP website for printer software updates.
 - If your computer has the most recent version of the printer software installed, **No updates are available for your system at this time** appears in the HP Software Update window.
 - If your computer does not have the most recent version of the printer software installed, a software update appears in the HP Software Update window.
4. If a software update is available, check the box beside the update to select it.
5. Click **Install**.
6. Follow the onscreen instructions.



Note This process does not update the HP Image Zone software. The HP Image Zone software is available only on CD. Contact HP directly to order software updates on CD, including the HP Image Zone software. For contact information, see the website: www.hp.com/support.

6 Care and maintenance

The printer requires very little maintenance. Follow the guidelines in this chapter to extend the life span of the printer and printing supplies, and to ensure that the photos you print are always of the highest quality.

Updating printer software

Download the latest printer software updates every couple of months to ensure you have the latest features and improvements. For more information, see the onscreen HP Photosmart Printer Help.

Cleaning and maintaining the printer

Keep the printer and print cartridges clean and well-maintained using the simple procedures in this section.

Cleaning the exterior of the printer

1. Turn off the printer, then disconnect the power cord from the back of the printer.
2. Wipe the outside of the printer with a soft cloth that has been lightly moistened with water.



Caution 1 Do not use any type of cleaning solution. Household cleaners and detergents may damage the printer finish.

Caution 2 Do not clean the interior of the printer. Keep all fluids away from the interior.

Caution 3 Do not lubricate the metal rod on which the print cartridge cradle slides. Noise is normal when the print cartridge cradle moves back and forth.

Cleaning the print cartridges

If you notice white lines or single-color streaks on the photos you print, the print cartridges might need to be cleaned. You can run an automatic cartridge cleaning procedure using the software that came with the printer. For more information, see the HP Photosmart Printer Help.

If you complete all three levels of the automatic cartridge cleaning procedure and still see white streaks or missing colors on the test page, you may need to manually clean the print cartridge contacts. For more information, see the following section.



Note If the cartridge or printer has been recently dropped, you may also see white streaks or missing colors in your prints. This problem is temporary and clears up within 24 hours.

Cleaning the print cartridge contacts

If the printer is used in a dusty environment, debris may accumulate on the print cartridge contacts and cause printing problems.

To clean the print cartridge copper-colored contacts:

1. Gather the following items to clean the print cartridge contacts:
 - Distilled water (tap water may contain contaminants that can damage the print cartridge)
 - Cotton swabs or other soft, lint-free material that will not stick to the print cartridge
2. Open the top cover of the printer.
3. Remove the print cartridges and place them on a piece of paper with the ink nozzle plate facing up, being careful not to touch the copper-colored contacts or the ink nozzle plate with your fingers.



Caution Do not leave the print cartridges outside the printer for more than 30 minutes. Ink nozzles exposed to the air longer than this may dry out and cause printing problems.

4. Lightly moisten a cotton swab with distilled water and squeeze any excess water from the swab.
5. Gently wipe the print cartridge contacts with the cotton swab.



Caution Do not touch the print cartridge ink nozzle. Touching the ink nozzle will result in clogs, ink failure, and bad electrical connections.

6. Repeat steps 4 - 5 until no ink residue or dust appears on a clean swab.
7. Insert the print cartridges in the printer, then close the top cover.

Aligning the print cartridges

When you first install a print cartridge in the printer, you must use the software that came with the printer to align the print cartridges. You should also align the print cartridges if the colors in your printed pages are misaligned. For more information, see [Aligning the cartridges](#).

Maintaining the quality of photo paper

For best results with photo paper, follow the guidelines in this section.

Storing photo paper

- Store the photo paper in its original packaging or in the resealable plastic bag that came with the printer.
- Store the packaged photo paper on a flat, cool, and dry surface.
- Return unused photo paper to the plastic bag. Paper left in the printer or exposed to the elements may curl.

Handling photo paper

- Always hold photo paper by the edges to avoid fingerprints.
- If the photo paper has curled edges, place it in its plastic storage bag and gently bend it in the opposite direction of the curl until the paper lies flat.

Storing the printer and print cartridges

Protect the printer and print cartridges by storing them properly when you are not using them.

Storing the printer

For safe and convenient storage of the printer, the In and Out trays fold up into the printer. You can store the paper trays by following these steps:

1. Turn off the printer.
2. Remove all paper from the paper trays.
3. Raise the top cover.



4. Lift and fold back the Out tray. (If the Out tray extender is extended, be sure to push it in before folding.)



5. Lift and fold up the In tray so that it lies over the Out tray. The tray snaps into place when positioned correctly.



6. Lower the top cover.

The printer is built to withstand long or short periods of inactivity.

- Store the printer indoors out of direct sunlight in a place without temperature extremes.
- If the printer and print cartridges have not been used for one month or more, use the software that came with the printer to run the automatic cartridge cleaning procedure before printing. For more information, see the HP Photosmart Printer Help.

Storing the print cartridges

The following tips will help maintain HP print cartridges and ensure consistent print quality:

- When you remove a print cartridge from the printer, store the cartridge in a print cartridge protector. Slide the cartridge into the protector at a slight angle and snap it securely in place. This prevents the ink from drying out. For a graphic illustration of how and where to store the print cartridge, see [Using print cartridges](#).
- Keep all unused print cartridges in their original sealed packages until they are needed. Print cartridges should be stored at room temperature (59 to 95 degrees F or 15 to 35 degrees C).
- Do not remove the plastic tape covering the ink nozzles until you are ready to install the print cartridge in the printer. If the plastic tape has been removed from the print cartridge, do not attempt to reattach it. Reattaching the tape damages the print cartridge.



Note For best print quality, HP recommends that you install retail print cartridges before the date stamped on the box.

7 Troubleshooting

The HP Photosmart 7400 series printer is designed to be reliable and easy to use. This chapter answers frequently asked questions about using the printer and printing without a computer. It contains information about the following topics:

- Printer hardware problems
- Printing problems
- Printer screen status indicators

For troubleshooting information about software installation, see the *Quick Start* booklet that came with the printer. For troubleshooting information about using the printer software and printing from a computer, see the HP Photosmart Printer Help. For information about viewing the Printer Help, see [Welcome](#).

Printer hardware problems

Before contacting Customer Care, read this section for troubleshooting tips or go to the online support services at www.hp.com/support.



Note When connecting the printer to a computer, HP recommends using a USB cable of less than 10 feet (3 meters) in length to minimize injected noise due to potential high electromagnetic fields.

The On light is flashing green, but the printer is not printing.

The printer is busy processing information. Wait for it to finish.

The On light is flashing red.

The printer requires attention. Try the following:

- If the printer is connected to a computer, check the computer screen for instructions. If the printer is not connected to a computer, check for the following problems:
 - Top cover open
 - Out of paper
 - Paper jam
 - Print carriage jammed or stuck
 - Print cartridge inserted incorrectly
 - Incorrect print cartridge installed
- If you are unable to solve the problem by using the instructions above, turn off the printer and unplug the printer's power cord. Wait one minute, then plug it in again. Turn on the printer.

The On light flashed amber briefly after I turned off the printer.

This is a normal part of the power-down process. It does not indicate a problem with the printer.

The On light is flashing amber.

A serious printing error has occurred. Try the following:

- If the printer is connected to a computer, check the computer screen for instructions.
- If the printer is not connected to a computer, turn off the printer and unplug the printer's power cord. Wait one minute, then plug it in again. Turn on the printer.
- If you are unable to solve the problem, go to www.hp.com/support or contact HP support. For contact information, see [HP Customer Care](#).

The printer does not find and display the photo numbers from my memory card.

Try the following:

- Remove and reinsert the memory card.
- Turn off the printer, then unplug its power cord. Wait about 10 seconds, then plug it in again. Turn on the printer.
- The memory card may contain file types the printer cannot read directly from the memory card.
 - Save the photos to a computer, then print them from the computer. For more information, see the documentation that came with the camera and the onscreen HP Photosmart Printer Help.
 - The next time you take photos, set the digital camera to save them in a file format the printer can read directly from the memory card. For a list of supported file formats, see [Specifications](#). For instructions on setting the digital camera to save photos in specific file formats, see the documentation that came with the camera.

The printer is plugged in, but it will not turn on.

- The printer may have drawn too much power. Unplug the printer's power cord. Wait about 10 seconds, then plug the power cord back in. Turn on the printer.
- The printer may be plugged into a power strip that is turned off. Turn on the power strip, then turn on the printer.

The printer makes noises when I turn it on, or starts making noises on its own after it has been sitting unused for a while.

The printer may make noises after long periods of inactivity (approximately 2 weeks), or when its power supply has been interrupted and then restored. This is normal

operation—the printer is performing an automatic maintenance procedure to ensure that it produces the best quality output.

Printing problems

Before contacting Customer Care, read this section for troubleshooting tips or go to the online support services at www.hp.com/support.

The printer does not print 4 x 6 inch (10 X 15 cm) borderless photos.

You might not be using the right paper type. Be sure you are using tabbed 4 x 6.5 inch with .5 inch tab (10 x 15 cm) paper. Untabbed paper will result in a border on one edge of the paper.

Printing is very slow.

You could have one of the following problems.

- You may need to calibrate the print cartridges. If you replace a print cartridge and don't calibrate it, print quality and speed will be less than optimal. See [Aligning the cartridges](#).
- You may be printing a project containing graphics or photos, or a high resolution photo or a PDF. Large, complex projects containing graphics or photos print slower than text documents.
- The printer may be in Ink-backup Printing Mode. The printer enters this mode when one of the print cartridges has been removed. Replace the missing print cartridge.

Photo paper does not feed into the printer correctly.

You may have one of these problems.

- If you are using the Photo cassette for printing, there may be paper loaded in the In tray. Remove any paper from the In tray before inserting the Photo cassette for printing.
- The Photo cassette may not be engaged. Insert the Photo cassette until it snaps into place. For more information about loading the Photo cassette, see [Loading paper in the printer](#).
- The printer may be in an extremely high or low humidity environment. Load one sheet of photo paper at a time.
- The photo paper may be curled. If the photo paper is curled, place the paper in a plastic bag and gently bend it the opposite direction of the curl until the paper lies flat. If the problem persists, then use photo paper that is not curled.

Paper does not feed into the printer correctly. —OR— Paper does not come out of the printer correctly.

- There may be too much paper loaded in the In tray. Remove some paper from the In tray and try printing again. For paper loading instructions, see [Loading paper in the printer](#).
- The paper may be too thin or too thick. Use HP-designed inkjet paper for best results. For more information, see [Choosing the right paper](#).
- Two or more pieces of paper may be stuck together. Remove the paper from the paper tray and shuffle the paper so it does not stick together. Reload the paper into the paper tray and try printing again.

No page came out of the printer. —OR— The paper jammed while printing.

There may be a printer jam. Try the following:

- Remove the paper from the In tray and the Out tray.
- If you were printing labels, make sure a label didn't become unglued from the label sheet while going through the printer.

If the paper is still jammed, try the following:

1. Turn off the printer.
2. Remove the rear access door.
3. Unplug the printer.
4. Gently remove the jammed paper from the printer.
5. Replace the rear access door.
6. Plug in the printer and turn it on.
7. When you have cleared the paper jam, print your document again.

If you experience paper jams when printing on photo paper, try the following:

- Insert the photo paper as far as it will go into the Photo cassette.
- Load one sheet of photo paper at a time.

A blank page came out of the printer.

- Check the printer screen to see if the print cartridge status indicator  appears. If the indicator is on, the ink level is low. If the indicator is flashing, the ink level may be too low to print. Replace any print cartridges that are out of ink. For more information about checking ink levels, see the [HP Photosmart Printer Help](#).
- You may have begun printing and then cancelled the process. If you cancelled the process before printing started, the printer may have already loaded paper in preparation for printing. The next time you print, the printer will eject the blank page before starting the new printing project.
- You may be printing in Ink-backup Printing Mode with only the black print cartridge installed. Replace the missing print cartridge with a new one. For more information about printing in Ink-backup Printing Mode, see [Inserting the cartridges](#).

The document printed at an angle or is off-center.

- The paper-width guide may not be set properly. Make sure that the paper-width guide is close to the edge of the paper without bending it.
- The paper may not be loaded correctly. Make sure the paper is correctly oriented in the In tray. For paper loading instructions, see [Loading paper in the printer](#).
- The print cartridges may not be aligned properly. For information about how to align the print cartridges, see [Aligning the cartridges](#).

The printed output is not properly aligned.

- The paper-width guide may not be set properly. Make sure that the paper-width guide is close to the edge of the paper without bending it.
- Try performing a print cartridge alignment. For information about how to align the print cartridges, see [Aligning the cartridges](#). For optimal speed and quality when printing, you should perform a print cartridge alignment immediately after installing a new cartridge.

My photos do not print when I press the Print button.

You may not have selected your photos by pressing **Select Photos** . For instructions on how to select your photos, see [Selecting photos to print](#).

The printer is displaying the out of ink indicator, but I don't know which cartridge to replace.

Connect the printer to your computer and read the instructions on the computer screen. The instructions will tell you which one to replace.

Print quality is poor.

- You may be printing in Ink-backup Printing Mode. The printer enters Ink-backup Printing Mode when one of the print cartridges is missing. Replace the missing print cartridge with a new one.
- One of the print cartridges may be running out of ink. Check to see if the print cartridge status indicator  appears on the printer screen. If a print cartridge is running low on ink, replace it. For more information, see [Inserting the cartridges](#).
- Use photo paper designed for the printer. For best results, use HP-designed inkjet paper.
- You may be printing on the wrong side of the paper. Make sure the paper is loaded with the side to be printed facing down.
- You may have selected a low-resolution setting on the digital camera. Reduce the size of the image and try printing again. For better results in the future, set the digital camera to a higher photo resolution.
- There may be a problem with a print cartridge. Try the following:
 - Remove and then reinsert the print cartridges.
 - Run an automatic print cartridge cleaning procedure from the printer's control panel. For more information, see the HP Photosmart Printer Help.
 - Align the print cartridges from the printer control panel. For more information, see [Aligning the print cartridges](#).





- If this does not solve the problem, try cleaning the copper-colored contacts on the print cartridges. For more information, see [Cleaning the print cartridge contacts](#).
- If these solutions do not work, replace the print cartridge(s).

Photos are not printing correctly.

- You may have loaded the photo paper incorrectly. Load the photo paper with the side to be printed facing down.
- The photo paper may not have fed into the printer correctly. Try the following:
 - If you have a paper jam, see [No page came out of the printer](#). —OR— [The paper jammed while printing](#).
 - Load one sheet of photo paper at a time.

Printer screen status indicators

The printer screen has two status indicators: one for print cartridge status, and another for paper status.

This indicator...	Has this meaning...
	<ul style="list-style-type: none"> • When the print cartridge status indicator  is on solid (not flashing), the ink level is low. • When the print cartridge status indicator  is flashing, either the ink level is too low to print, or there is a problem with the print cartridge that needs attention. For more information about which problem has occurred, connect the printer to your computer and read the instructions on the computer screen. If the ink is out on one of the print cartridges, the instructions will tell you which one to replace.
	<p>When the paper status indicator  is flashing, either there's a paper jam or the printer is out of paper.</p>

8 HP Customer Care

If you have a problem, follow these steps:

1. Check the documentation that came with the printer.
 - The *User's Guide* contains detailed information on the printer and its operation.
 - The onscreen Help contains detailed information about how to use the software that came with the printer. For information about viewing the onscreen Help, [Welcome](#).
2. If you are unable to solve the problem using the information in the onscreen Help or the *User's Guide*, visit www.hp.com/support to do the following:
 - Access online support pages
 - Send HP an e-mail message for answers to your questions
 - Connect with an HP technician by using online chat
 - Check for software updatesSupport options and availability vary by product, country/region, and language.
3. In Europe only, contact your local point of purchase. If the printer has a hardware failure, you will be asked to bring the printer to where you purchased it. Service is free during the printer limited warranty period. After the warranty period, you will be quoted a service charge.
4. If you are unable to solve the problem using the onscreen Help or HP web sites, call HP Customer Care using the number for your country/region. For a list of country/region phone numbers, see the following section.

HP Customer Care by phone

While the printer is under warranty, you can obtain free phone support. For more information, see the warranty included in the box, or go to www.hp.com/support to check the duration of your free support.

After the free phone support period, you can obtain help from HP at an additional cost. Contact your HP dealer or call the support phone number for your country/region for support options.

To receive HP support by phone, call the appropriate support phone number for your location. Standard phone company charges apply.

North America: Call 1-800-HP-INVENT (1-800-474-6836). U.S. phone support is available in both English and Spanish languages 24 hours a day, 7 days a week (days and hours of support may change without notice). This service is free during the warranty period. A fee may apply outside the warranty period.

Western Europe: Customers in Austria, Belgium, Denmark, Spain, France, Germany, Ireland, Italy, Netherlands, Norway, Portugal, Finland, Sweden, Switzerland, and the United Kingdom should go to www.hp.com/support to access phone support numbers in their country/region.



www.hp.com/support

Support for the following countries/regions is available at www.hp.com/support: Austria, Belgium, Central America & The Caribbean, Denmark, Spain, France, Germany, Ireland, Italy, Luxembourg, Netherlands, Norway, Portugal, Finland, Sweden, Switzerland, and the United Kingdom.

61 56 45 43	الجزائر
Argentina (Buenos Aires)	54-11-4708-1600
Argentina	0-800-555-5000
Australia	1300 721 147
Australia (out-of-warranty)	1902 910 910
800 171	البحرين
Brasil (Sao Paulo)	55-11-4004-7751
Brasil	0-800-709-7751
Canada (Mississauga Area)	(905) 206-4663
Canada	1-(800)-474-6836
Chile	800-360-999
中国	021-3881-4518 800-810-3888 服务编码: 3001
Colombia (Bogota)	571-606-9191
Colombia	01-8000-51-4746-8368
Costa Rica	0-800-011-1046
Česká republika	261 307 310
Ecuador (Andinatel)	1-999-119 ☎ 800-711-2884
Ecuador (Pacifitel)	1-800-225-528 ☎ 800-711-2884
2 532 5222	مصر
El Salvador	800-6160
Ελλάδα (από το εξωτερικό)	+ 30 210 6073603
Ελλάδα (εντός Ελλάδας)	801 11 22 55 47
Ελλάδα (από Κύπρο)	800 9 2649
Guatemala	1-800-711-2884
香港特別行政區	2802 4098
Magyarország	1 382 1111
India	1 600 44 7737
Indonesia	+62 (21) 350 3408
(0) 9 830 4848	ישראל
Jamaica	1-800-711-2884
日本	0570-000511
日本 (携帯電話の場合)	03-3335-9800

한국	1588-3003
Malaysia	1800 805 405
Mexico (Mexico City)	55-5258-9922
Mexico	01-800-472-68368
22 404747	المغرب
New Zealand	0800 441 147
Nigeria	1 3204 999
Panama	1-800-711-2884
Paraguay	009 800 54 1 0006
Perú	0-800-10111
Philippines	2 867 3551
Polska	22 5666 000
Puerto Rico	1-877-232-0589
República Dominicana	1-800-711-2884
România	(21) 315 4442
Россия (Москва)	095 7973520
Россия (Санкт-Петербург)	812 3467997
800 897 1444	السعودية
Singapore	6 272 5300
Slovakia	2 50222444
South Africa (International)	+ 27 11 2589301
South Africa (RSA)	086 0001030
Rest Of West Africa	+ 351 213 17 63 80
臺灣	02-8722-8000
ໄທ	+66 (2) 353 9000
71 89 12 22	تونس
Trinidad & Tobago	1-800-711-2884
Türkiye	90 216 444 71 71
Україна	(380 44) 4903520
800 4520	الإمارات العربية المتحدة
United States	1-(800)-474-6836
Uruguay	0004-054-177
Venezuela (Caracas)	58-212-278-8666
Venezuela	0-800-474-68368
Việt Nam	+84 88234530

Placing a call

Call HP Customer Care while you are near the computer and printer. Be prepared to provide the following information:

- Printer model number (located on the front of the printer).
- Printer serial number (located on the bottom of the printer).
- Computer operating system.
- Version of printer driver:
 - **Windows PC:** To see the printer driver version, right-click the memory card icon in the Windows taskbar and select **About**.
 - **Macintosh:** To see the printer driver version, use the Print dialog box.
- Messages displayed on the printer screen or on the computer monitor.
- Answers to the following questions:
 - Has the situation you are calling about happened before? Can you recreate the situation?
 - Did you install any new hardware or software on your computer around the time that the situation occurred?

9 Specifications

This section lists the minimum system requirements for installing the printer software, and provides selected printer specifications.

For a complete list of printer specifications and system requirements, see the onscreen HP Photosmart Printer Help. For information about viewing the onscreen Help, see [Welcome](#).

System requirements

Component	Windows PC minimum	Macintosh minimum
Operating system	Microsoft® Windows 98, 2000 Professional, ME, XP Home, and XP Professional	Mac® OS X 10.1 through 10.3
Processor	Intel® Pentium® II (or equivalent) or higher	G3 or greater
RAM	128 MB recommended	Mac OS 10.1 through 10.3: 128 MB
Free disk space	500 MB	500 MB
Video display	800 x 600, 16-bit or higher	800 x 600, 16-bit or higher
CD-ROM drive	4x	4x
Connectivity	USB: Microsoft Windows 98, 2000 Professional, ME, XP Home, and XP Professional	USB: Mac OS X 10.1 through 10.3
Browser	Microsoft Internet Explorer 5.5 or later	—

Printer specifications

Category	Specifications
Connectivity	USB: Microsoft Windows 98, 2000 Professional, ME, XP Home, and XP Professional; Mac OS X 10.1 through 10.3
Image file formats	JPEG Baseline TIFF 24-bit RGB uncompressed interleaved TIFF 24-bit YCbCr uncompressed interleaved TIFF 24-bit RGB packbits interleaved TIFF 8-bit gray uncompressed/packbits TIFF 8-bit palette color uncompressed/packbits TIFF 1-bit uncompressed/packbits/1D Huffman
Media sizes	Photo paper, 4 x 6 inches (10 x 15 cm) Photo paper with tab, 4 x 6 inches with 0.5 inch tab (10 x 15 cm with 1.25 cm tab) Index cards, 4 x 6 inches (10 x 15 cm) Hagaki cards, 3.9 x 5.8 inches (100 x 148 mm) A6 cards, 4.1 x 5.8 inches (105 x 148 mm) L-size cards, 3.5 x 5 inches (90 x 127 mm) L-size cards with tab, 3.5 x 5 inches with 0.5 inch tab (90 x 127 mm with 12.5 mm tab)
Media specifications	Recommended maximum length: 14 inches (356 mm) Recommended maximum thickness: 11.5 mil (292 µm)
Media sizes, standard	Photo paper 3 x 3 inches to 8.5 x 14 inches (76 x 76 mm to 216 x 356 mm) Plain paper Letter, 8.5 x 11 inches (216 x 280 mm) Legal, 8.5 x 14 inches (216 x 356 mm) Executive, 7.5 x 10 inches (190 x 254 mm) A4, 8.27 x 11.7 inches (210 x 297 mm) A5, 5.8 x 8.3 inches (148 x 210 mm) B5, 6.9 x 9.8 inches (176 x 250 mm) Cards

(continued)

Category	Specifications
	<p>Hagaki, 3.94 x 5.83 inches (100 x 148 mm) L-size, 3.5 x 5 inches (90 x 127 mm) L-size with tab, 3.5 x 5 inches with 0.5 inch tab (90 x 127 mm with 12.5 mm tab) Index, 3 x 5 inches, 4 x 6 inches, and 5 x 8 inches (76 x 127 mm, 10 x 15 cm, and 127 x 203 mm) A6, 4.13 x 5.85 inches (105 x 148.5 mm)</p> <p>Envelopes</p> <p>No. 9, 3.875 x 8.875 inches (98.4 x 225.4 mm) No. 10, 4.125 x 9.5 inches (105 x 240 mm) A2 Invitation, 4.375 x 5.75 inches (110 x 146 mm) DL, 4.33 x 8.66 inches (110 x 220 mm) C6, 4.5 x 6.4 inches (114 x 162 mm)</p> <p>Custom</p> <p>3 x 5 inches to 8.5 x 14 inches (76 x 127 mm to 216 x 356 mm)</p> <p>Transparencies and label sheets</p> <p>Letter, 8.5 x 11 inches (216 x 280 mm) A4, 8.27 x 11.7 inches (210 x 297 mm)</p>
Media types	<p>Paper (plain, inkjet, photo, and banner) Envelopes Transparencies Labels Cards (index, greeting, Hagaki, A6, L-size) Iron-on transfers</p>
Memory cards	<p>CompactFlash Type I and II Microdrive MultiMediaCard Secure Digital SmartMedia Sony Memory Sticks xD-Picture Card</p>
Memory card-supported file formats	<p>Printing: See Memory card-supported file formats Saving: All file formats</p>

(continued)

Category	Specifications
Paper trays	<p>In tray 3 x 5 inches to 8.5 x 14 inches (76 x 127 mm to 216 x 356 mm)</p> <p>Photo cassette 4 x 6 inch (10 x 15 cm) and Hagaki</p> <p>Out tray All supported sizes</p>
Paper tray capacity	<p>In tray 100 sheets of plain paper 15 envelopes 20–40 cards (depending on thickness) 20 sheets of banner paper or labels 25 transparencies, iron-on transfers, or photo paper</p> <p>Photo cassette 24 sheets of photo paper</p> <p>Out tray 50 sheets of plain paper 20 sheets of photo paper, banner paper or transparencies 10 cards or envelopes 25 sheets of labels or iron-on transfers</p>
Power consumption	<p>Printing: 6.604 W AC Idle: 2.28 W AC Off: 2.13 W AC</p>
Print cartridges	<p>1 Black HP (C6656A) 1 Tri-color HP (C6657A) 1 Photo HP (C6658A)</p>
USB support	<p>Microsoft Windows 98, 2000 Professional, ME, XP Home, and XP Professional Mac OS X 10.1 through 10.3 HP recommends that the USB cable be less than 10 feet (3 meters) in length</p>
Power adapter	<p>HP Part # 0950-4404 (US) HP Part # 0950-4400 (India) HP Part # 0950-4401 (All other regions)</p>

(continued)

Category	Specifications
Environmental specifications	Recommended during operation: 15 -30 °C (59 - 86 °F), 20 - 80% relative humidity Maximum during operation: 10 - 35 °C (50 - 95 °F), 15 - 80% relative humidity Storage temperature ranges: -30 - 65 °C (22 - 149 °F)

Environmental statements

Hewlett-Packard Company is committed to providing quality products in an environmentally sound manner.

Protecting the environment

This printer has been designed with several attributes to minimize impact on our environment. For more information, go to HP's Commitment to the Environment website at www.hp.com/hpinfo/globalcitizenship/environment/.

Ozone production

This product generates no appreciable ozone gas (O₃).

Energy consumption

Energy usage drops significantly while in ENERGY STAR® mode, which saves natural resources and saves money without affecting the high performance of this product. This product qualifies for ENERGY STAR, which is a voluntary program established to encourage the development of energy-efficient office products.



ENERGY STAR is a U.S. registered mark of the U.S. EPA. As an ENERGY STAR partner, Hewlett-Packard Company has determined that this product meets the ENERGY STAR guidelines for energy efficiency. For more information, go to www.energystar.gov.

Paper use

This product is suited for the use of recycled paper according to DIN 19309.

Plastics

Plastic parts over 0.88 ounces (24 grams) are marked according to international standards that enhance the ability to identify plastics for recycling purposes at the end of the printer life.

Material safety data sheets

Material Safety Data Sheets (MSDS) can be obtained from the HP website at www.hp.com/go/msds. Customers without Internet access should contact Customer Care.

Recycling program

HP offers an increasing number of product return and recycling programs in many countries, and partners with some of the largest electronics recycling centers throughout the world. HP conserves resources by reselling some of its most popular products.

This HP product contains lead in the solder, which may require special handling at the end of its life.

Index

- A**
 - aligning print cartridges 10, 28
- B**
 - black-and-white photos 10
 - borderless photos
 - do not print 33
 - selecting layout 19
 - buttons 4
- C**
 - camera-selected photos 20
 - cartridges. *See* print cartridges
 - cleaning
 - print cartridge contacts 28
 - print cartridges 27
 - printer 27
 - CompactFlash 13
 - computer
 - connecting to printer 21
 - printing from 23
 - printing without 17
 - saving photos to 21
 - system requirements 41
 - updating software 24
 - control panel 4
 - Customer Care 37
- D**
 - documentation, printer 3
 - DPOF files 20
- E**
 - e-mailing photos 22
- F**
 - file formats, supported 13
- H**
 - help. *See* troubleshooting
 - help, onscreen 3
 - HP Image Zone 23
 - HP Instant Share 22
- I**
 - ink cartridges. *See* print cartridges
 - inserting
 - memory cards 13
 - print cartridges 10
- J**
 - JPEG file format 13
- L**
 - layout, selecting 19
 - loading paper 8
- M**
 - memory cards
 - inserting 13
 - printing photo index 18
 - removing 16
 - supported file formats 13
 - supported types 13
 - Memory Sticks 13
 - Microdrive 13
 - MultiMediaCard 13
- O**
 - onscreen help 3
- P**
 - paper
 - buying and choosing 7
 - loading 8
 - maintaining 7, 28
 - sizes 42
 - status indicator 36
 - trays 4
 - troubleshooting 33
 - photo cassette 4
 - photos
 - do not print 35
 - e-mailing 22
 - editing 23
 - index 18
 - numbers do not appear 32
 - print cartridges, choosing 10
 - printing 20
 - saving to computer 21
 - selecting for print 19
 - selecting layout 19
 - supported file formats 13
 - print cartridges
 - aligning 10, 28
 - choosing 10
 - cleaning 27
 - cleaning contacts 28
 - inserting 10
 - out of ink 35
 - replacing 10
 - status indicator 36
 - storage area 4
 - storing 12, 30
 - printer
 - cleaning 27
 - connecting to computer 21
 - documentation 3
 - parts 4
 - power problems 32
 - specifications 42
 - status indicators 36
 - storing 29
 - warnings 2
 - printing
 - creative projects 23
 - from computer 21, 23
 - from memory cards 20
 - photo index 18
 - selecting layout 19
 - without computer 17
- Q**
 - quality
 - photo paper 28
 - troubleshooting 35
- R**
 - regulatory notices 49
 - removing memory cards 16
 - replacing print cartridges 10
- S**
 - saving photos to computer 21

- Secure Digital 13
- SmartMedia 13
- software, updating 24
- specifications 41
- storing
 - photo paper 28
 - print cartridges 12, 30
 - printer 29
- system requirements 41

T

- TIFF file format 13
- trays, paper 4
- troubleshooting
 - borderless photos 33
 - Customer Care 37
 - flashing lights 31
 - low ink 35
 - paper problems 33
 - photo numbers do not appear 32
 - power problems 32
 - print quality 35
 - printer noises 32

U

- updating software 24
- USB
 - port 4
 - specifications 41

X

- xD-Picture Card 13

Regulatory notices

Hewlett-Packard Company

This device complies with part 15 of the FCC Rules. Operation is subject to the following two conditions:

- This device may not cause harmful interference, and
- This device must accept any interference received, including interference that may cause undesired operation.

Pursuant to Part 15.21 of the FCC Rules, any changes or modifications to this equipment not expressly approved by Hewlett-Packard Company may cause harmful interference, and void your authority to operate this equipment. Use of a shielded data cable is required to comply with the Class B limits of Part 15 of the FCC Rules.

For further information, contact: Hewlett-Packard Company, Manager of Corporate Product Regulations, 3000 Hanover Street, Palo Alto, CA 94304, (650) 857-1501.

Note

This equipment has been tested and found to comply with the limits for a Class B digital device, pursuant to part 15 of the FCC rules. These limits are designed to provide reasonable protection against harmful interference in a residential installation. This equipment generates, uses, and can radiate radio frequency energy and, if not installed and used in accordance with the instructions, can cause harmful interference to radio communications. However, there is no guarantee that interference will not occur in a particular installation. If this equipment does cause harmful interference to radio or television reception, which can be determined by turning the equipment off and on, the user is encouraged to try to correct the interference by one or more of the following measures:

- Reorient or relocate the receiving antenna.
- Increase the separation between the equipment and the receiver.
- Connect the equipment into an outlet on a circuit different from that to which the receiver is connected.
- Consult the dealer or an experienced radio/TV technician for help.

LED indicator statement

The display LEDs meet the requirements of EN 60825-1.

사용자 안내문 (한국 기기)

이 기기는 비업무용으로 전자파장애검정을 받은 기기여서, 주거지역에서는 다른 모든 지역에서 사용될 수 있습니다.

この装置は、情報処理装置等電波障害自主規制協議会（VCCI）の基準に基づくクラスB情報技術装置です。この装置は、家庭環境で使用することを目的としていますが、この装置がラジオやテレビジョン受信機に近接して使用されると受信障害を引き起こすことがあります。
取り扱い説明書に従って正しい取り扱いをして下さい。