



McIntosh Laboratory, Inc. 2 Chambers Street Binghamton, New York 13903-2699 Phone: 607-723-3512 www.mcintoshlabs.com

HR078
Remote Control
Programming Guide





Introduction

The McIntosh HR078 Remote Control supplied with the McIntosh A/V Control Center controls a McIntosh Component System, but also have the ability of controlling non McIntosh Components in your system. Refer to figure 1.

The HR078 Remote Control has stored in permanent memory the necessary information to send the correct IR (Infra Red) command codes for the component to be controlled. This is accomplished by either entering a four digit numeric code or by searching for the numeric code.

The HR078 also has the ability to learn IR codes for components without the built-in four digit numeric code commands.

Battery Information

Use only fresh batteries of the required size and recommended type. When the battery voltage is low, the LCD Display will start to fade. Do not mix old and new batteries, different types of batteries (standard, alkaline, or rechargeable), or rechargeable batteries of different capacities.

If the Remote Control will not be used for an extended period, remove the batteries. They can leak chemicals and destroy the Remote Control.

When discarding the Remote Control, comply with local rules or regulations. Batteries should never be thrown away or incinerated but disposed of in accordance with the local regulations concerning battery disposal.

For additional information please visit the McIntosh Web Site at www.mcintoshlabs.com.

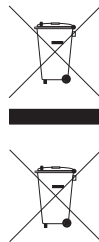

Installing Batteries

1. Open the battery compartment cover (located on the back of the remote).
2. Place the AAA Batteries in the compartment and match the + and - polarity symbols inside.
3. Replace the cover.

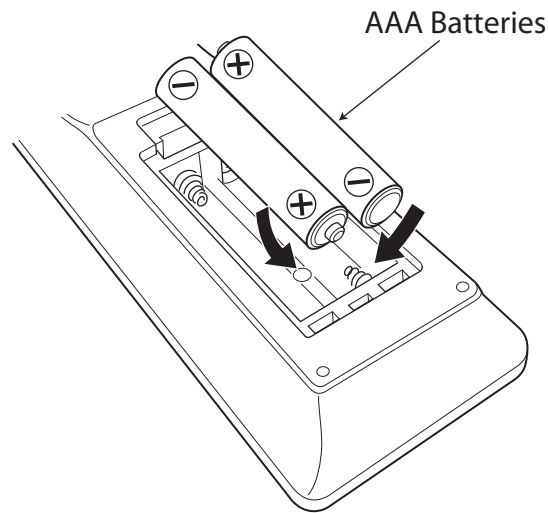
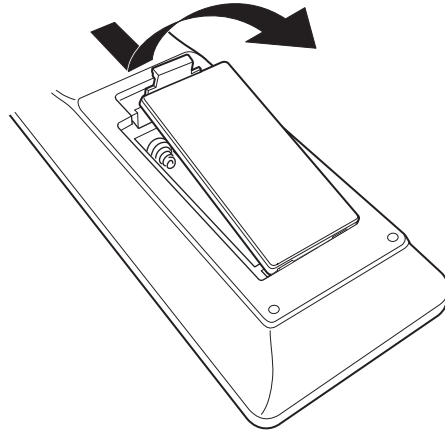

Table of Contents

Introduction.....	2
Battery Information	2
Installing Batteries.....	2
Table of Contents	2
Programming by entering Component Code Numbers.....	4
Component Code Numbers.....	4-6
Programming by Searching Codes	7
Programming by Learning Codes	8

Programming by Entering Component Code Numbers

To Program this Remote Control, first find the codes for the component(s) you want to program (starting on page 4) and then follow the steps below:

1. Turn on the component (in this example, the TV).
2. Press and hold in the Assigned Input Source (TV) Push-button along with the SET Push-button until the IR Send Indicator flashes twice on the LCD Display. Refer to figures 4 and 1.
3. Release both Push-buttons. The LCD Window should now be illuminated and the rear lighting of the Push-buttons should now be flashing.
4. Enter the four-digit code (using the numeric push-buttons) for the brand of TV component you wish to program. The just entered component code number will appear on the LCD Display followed by "OK". Refer to figure 2.



Figure 1



Figure 2

Note: If the LCD Display does not indicate OK or indicates

NG (not a valid code) check the number and try entering the code again.

5. Referring to figure 4, aim the IR Emitter end of the McIntosh Remote Control at the component and press Power Off. The TV should turn Off. If it does not, repeat steps 2–5, trying each code for your brand until you find one that works. If you cannot find a working TV code refer to “Searching Codes” on page 7.

Note: There might be more than one Program Code Number capable of switching power Off to the TV. Choose the Code Number with

the greatest number of desired active commands for the TV to be controlled.

6. Repeat steps 1 to 5 for the other components you want to control. For future reference, write down each working component code number(s) below:

HR078 Remote Control Programming		
Assigned Push-button (and Initial Code)	Component	Programmed Code
CD (3000)		
SAT (4000)		
TV (1000)		
BD (5000)		
DVD (2000)		

Checking the entered Component Code Numbers

After a Component Code Number has been assigned the number may be recalled at any time by performing the following steps:

1. Press and hold in the Assigned Input Source (TV) Push-button along with the SET Push-button until the IR Send Indicator flashes twice on the LCD Display. Refer to figures 4 and 1.
2. Press the SEARCH/INFO Push-button, the IR Send Indicator flashes twice on the LCD Display followed by the Component Code Number.

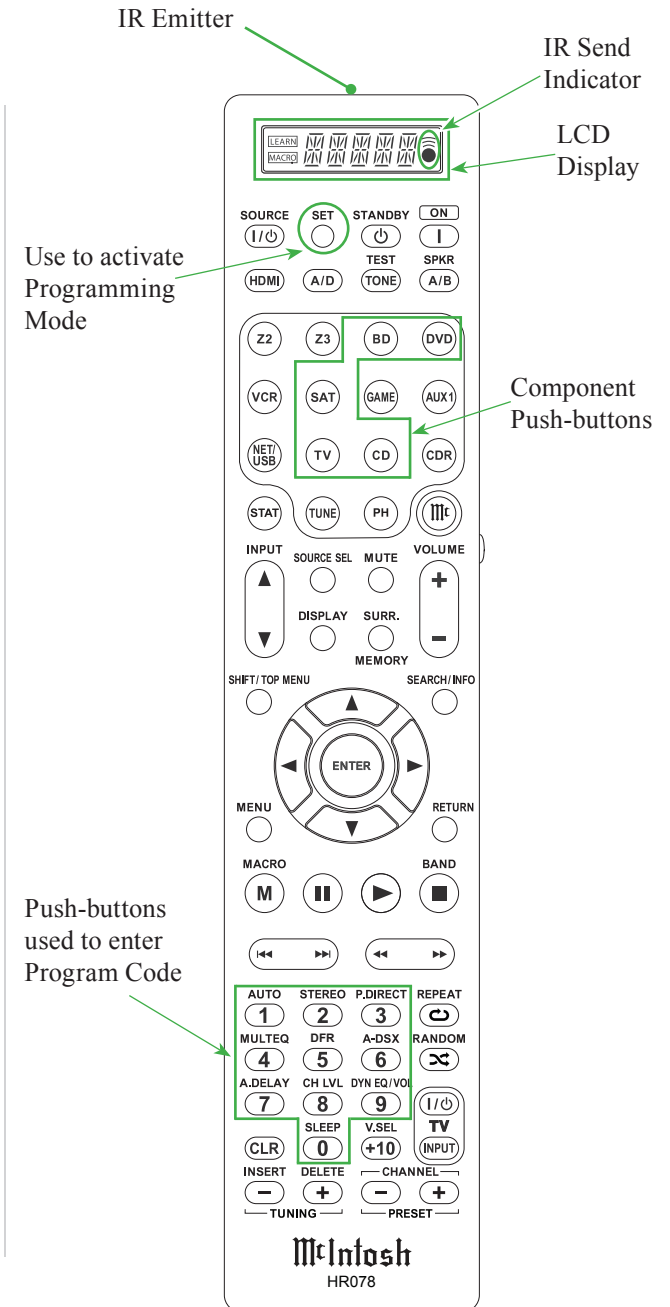

Figure 4



Component Code Numbers

CD Player

Aiwa.....	3001, 3002, 3003
Akai.....	3004, 3005, 3006
Audio.....	3007
Audio.....	Labs 3008
California.....	3008
Carver.....	3010, 3011, 3009
Casio.....	3012, 3020
Curtis.....	3020, 3012
Denon.....	3013
Emerson.....	3014
Fisher.....	3011, 3015, 3016, 3017, 3018
GE.....	3019
Genexxa.....	3014, 3021, 3020
Harmon.....	3022, 3023, 3051
Hitachi.....	3020
Inkel.....	3024
JC Penney.....	3012, 3020, 3025
JVC.....	3026, 3027
Kardon.....	3022, 3051, 3023
Krell.....	3010
Luxman.....	3035, 3036, 3037, 3038
LXI.....	3012, 3020, 3014
Magnavox.....	3010, 3039, 3040
Marantz.....	3010, 3041, 3042, 3043
Mathes.....	3012, 3020
MCS.....	3012, 3020
MGA.....	3023
Mission.....	3010
Mitsubishi.....	3023, 3044
Nad.....	3034, 3045
Nakamichi.....	3046, 3047, 3048
NEC MCS.....	3025
Nikko.....	3007, 3016
Onkyo.....	3049, 3050, 3051, 3052, 3055, 3102, 3103
Optimus.....	3011, 3014, 3020, 3028, 3053, 3054,
.....	3056, 3057, 3058, 3059

Panasonic.....	3008, 3060, 3061
Philips.....	3009, 3010, 3010, 3040
Pioneer.....	3020, 3021, 3062, 3063, 3064
Quasar.....	3008
RCA.....	3011, 3014, 3065, 3066, 3067, 3068, 3069
Realistic.....	3011, 3014, 3020, 3042, 3054, 3057
Rotel.....	3010
RS Original.....	3070
SAE.....	3010, 3083
Samsung.....	3071
Sansui.....	3014, 3068, 3072, 3073
Sanyo.....	3011, 3018, 3074, 3075, 3076
Scott.....	3014
Sears.....	3012, 3014, 3020, 3028, 3042
Sharp.....	3028, 3042, 3077
Sherwood.....	3042, 3056, 3070, 3078, 3024
Shure.....	3025
Sony.....	3039, 3079, 3080, 3081, 3082, 3097, 3098,
.....	3099, 3100, 3101
Sylvania.....	3010
Symphonic.....	3083
Teac.....	3016, 3042, 3057, 3083, 3084, 3085, 3086
Technica.....	3007, 3008, 3061, 3087, 3088
Theta Digital.....	3040
Toshiba.....	3045
Victor.....	3026
Yamaha.....	3007, 3089, 3090, 3091, 3092
Zenith.....	3016, 3093, 3094, 3095, 3096

Satellite Receiver

Alphastar.....	4027
Amstrad.....	4046, 4047, 4050
Atsky.....	4048
B Sky B.....	4021, 4045, 4046
Chaparral.....	4039
DIRECTV.....	4001, 4016, 4044

DISH Network.....	4030
Drake.....	4026
Echostar... 4007, 4017, 4018, 4019, 4020, 4062, 4063,	4064
.....	4064
Eurosky.....	4047, 4056
Express Vu.....	4017
Foxtel.....	4051
Freesat.....	4056
Fujitsu.....	4025
GE.....	4002, 4008, 4009
General Instruments.....	4036, 4037
Gradiente.....	4044, 4057
Hitachi.....	4001, 4015
Hughes.....	4001, 4016
Humax.....	4049, 4050, 4051, 4052, 4053
Janeil.....	4025
JVC.....	4017
Mitsubishi.....	4001
Nokia.....	4058, 4059, 4060, 4061
Optima.....	4048
Panasonic.....	4004, 4010
Philips.....	4031, 4035, 4044, 4057
Proscan.....	4002, 4008, 4009, 4011
Radio Shack.....	4036, 4037
RCA.....	4002, 4008, 4009, 4029
Realistic.....	4040
Rural Cable.....	4036
Samsung... 4022, 4027, 4042, 4043, 4050, 4054, 4055	
Schneider.....	4041, 4043
SKY.....	4044, 4045, 4057
Skyplus.....	4048
Skysat.....	4041, 4047, 4056
Sony.....	4003, 4012, 4014, 4065, 4066, 4067
Star Choice.....	4032
Star Trak.....	4024
STS.....	4038

Satellite Receiver, con't

SuperDish.....	4028
Teac.....	4049
Thomson.....	4046, 4056
Toshiba.....	4001, 4034
U Uniden.....	4005, 4006, 4013
Universum.....	4056
Video Pall.....	4025
Zenith.....	4023, 4025, 4033

Television

Acer.....	1141
Admiral.....	1002, 1009, 1089
Aiko.....	1059
Aiwa.....	1117, 1118
Akai.....	1001
Amtron.....	1023
Anam.....	1113
Anam National.....	1023, 1069, 1092
AOC.....	1003, 1024, 1049, 1127
Audiovox.....	1023
Bell & Howell.....	1009, 1025
Benq.....	1104, 1142
Broksonic.....	1003, 1097, 1098, 1113
Celebrity.....	1001
Citizen.....	1003, 1013, 1023, 1026, 1059, 1063
Colortyme.....	1003, 1043
Contec.....	1113
Contec/Cony.....	1023, 1045, 1047
Craig.....	1020, 1022, 1023, 1113
Crown.....	1023, 1067
Curtis Mathes.....	1003, 1013, 1025, 1026, 1062,1103, 1110
Daewoo.....	1003, 1013, 1024, 1035, 1036, 1059,1084, 1101

Daytron.....	1003, 1013, 1016
Dimensia.....	1103, 1110
Dumont.....	1003, 1010, 1153
Electroband.....	1001
Electrohome.....	1001, 1003, 1069, 1133
Emerson.....	1003, 1013, 1015, 1020, 1021, 1022,1023, 1025, 1038, 1044, 1045, 1048,1055, 1061, 1094, 1096, 1099, 1101, 1113
Envision.....	1003
Fisher.....	1025, 1051, 1091, 1160
Fujitsu.....	1038, 1124, 1125, 1155
Funai.....	1023, 1038, 1113
Gateway.....	1150
GE.....	1003, 1018, 1022, 1046, 1054, 1069, 1085,1103, 1110, 1113, 1133, 1136, 1153
Goldstar.....	1003, 1013, 1024, 1030, 1045, 1080,1100 1112, 1154
Hallmark.....	1003
Hisense.....	1116
Hitachi.....	1003, 1012, 1031, 1032, 1037,1041, 1045, 1047, 1065, 1068, 1082,1088, 1094, 1139, 1140, 1145, 1159
Infinity.....	1067
Janeil.....	1134
JBL.....	1067
JC Penney.....	1003, 1013, 1018, 1019, 10241026, 1046, 1047, 1054, 1063, 1083,1085, 1100, 1103, 1110, 1112, 1133, 1154
Jensen.....	1003
JVC.....	1028, 1029, 1045, 1047, 1050, 1060, 1065
Kawasho.....	1001, 1003
Kenwood.....	1003
Kloss Novabeam.....	1023, 1056, 1057, 1134
KTV.....	1013, 1023, 1033, 1034, 1073, 1099, 1113
LG.....	1024, 1030
M.Wards.....	1002, 1009, 1038

Magnavox.....	1003, 1052, 1053, 1056, 1057,1063, 1067, 1081, 1106
Marantz.....	1003, 1031, 1067, 1122
Mitsubishi.....	1003, 1024, 1051, 1115, 1122, 1133
Motorola.....	1014, 1069
NEC.....	1003, 1012, 1024, 1043, 1069
NET-TV.....	1137, 1150
Orion.....	1020, 1096
Panasonic.....	1017, 1067, 1069, 1095, 1111
Philips.....	1003, 1011, 1045, 1052, 1054, 1056,1057, 1058, 1063, 1067, 1069, 1106
Pioneer.....	1003, 1018, 1037, 1070, 1071,1094, 1145, 1147, 1149
Plasmsync.....	1135
Portland.....	1003, 1013, 1024, 1059
Price Club.....	1026
Prism.....	1018
Proscan.....	1004, 1005, 1006, 1007,1008, 1085, 1103, 1110
Proton.....	1003, 1045
Quasar.....	1010, 1069, 1073, 1111, 1153
Radio Shack.....	1003, 1013, 1015, 1023, 1024,1025, 1045, 1100, 1103, 1110, 1113
RCA.....	1003, 1004, 1005, 1006, 119
Sanyo.....	1003, 1025, 1051, 1072, 1077, 1091,1156, 1157, 1158
Sharp.....	1003, 1013, 1014, 1015, 1045, 1055,1064, 1066, 1076, 1089, 1123
Signature.....	1009
Sony.....	1001, 1102, 1108
Soundesign.....	1003, 1023, 1038, 1063, 1113
Starlite.....	1023
Supre-Macy.....	1134
Sylvania.....	1003, 1039, 1042, 1052, 1053,1056, 1057, 1063, 1067, 1089, 1151
Symphonic.....	1023, 1039, 1044

Programming by Searching Codes

If your component (TV) in the example on page 3 does not respond to the McIntosh Remote Control, after trying all codes listed for your (TV) brand, or if your TV brand is not listed, try by searching through the McIntosh Remote Control internally stored codes:

1. Switch Power On the component (TV) you wish to control.
2. Press and hold in the Assigned Input Source (TV) Push-button, then press the SET Push-button until the IR Send Indicator flashes twice on the LCD Display. Refer to figures 5 and 7.

Note: It is important to use the same Input Source Push-button as the desired component device to be controlled (eg. TV Push-button for controlling the TV).



Figure 5

3. Point the McIntosh Remote Control at the component (TV).
4. Press the INPUT ▲ Up Push-button just once and the first four digit component (TV) code number will appear on the LCD Display. Refer to the example illustrated in figure 6.



Figure 6

5. Press the SOURCE (I/O) ON/OFF (Power) Push-button. If the component (TV) switches OFF a working code has been found.

Note: If the component (TV) does not switch OFF, repeat steps 4 and 5 until a working code number is found.

6. Now press the ENTER Push-button to store the component (TV) code. Check to see how many desired Remote Control Functions work. For future reference, write down each working component code number(s) below:

Note: There may be another component code number available offering more controllable commands.

HR078 Remote Control Programming		
Assigned Push-button (and Initial Code)	Component	Programmed Code
CD (3000)		
SAT (4000)		
TV (1000)		
BD (5000)		
DVD (2000)		

Checking the entered Component Code Numbers

After a Component Code Number has been assigned the number may be recalled at any time by performing the following steps:

1. Press and hold in the Assigned Input Source (TV) Push-button along with the SET Push-button until the IR Send Indicator flashes twice on the LCD Display. Refer to figures 4 and 1.
2. Press the SEARCH/INFO Push-button, the IR Send Indicator flashes twice on the LCD Display followed by the Component Code Number.

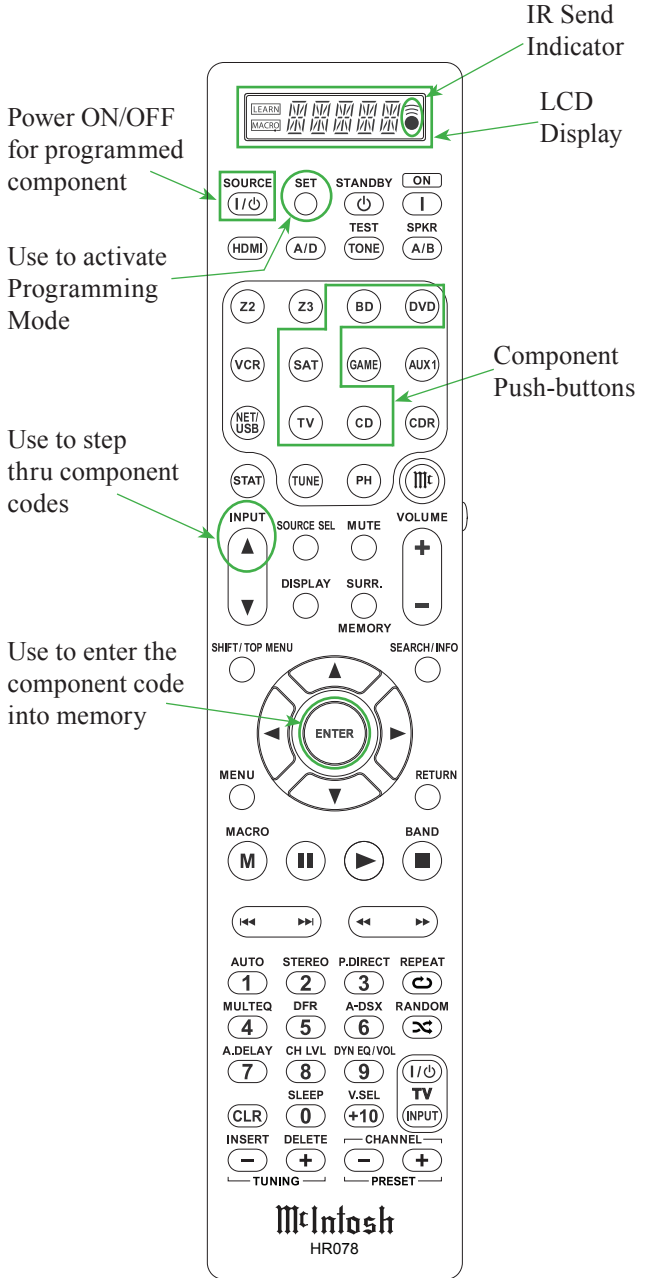

Figure 7



Programming by Learning Commands

A successful learning process requires an adequate IR signal from both the McIntosh and other brand(s) Remote Control(s). Please make sure the remote controls used in the learning process have fresh batteries installed in them before performing the following learning process:

1. Place the McIntosh Remote Control and the first component (TV) Remote Control on a flat surface with the IR Emitter Window pointed towards each other and about 2 inches (5cm) apart. Refer to figures 8 and 10.

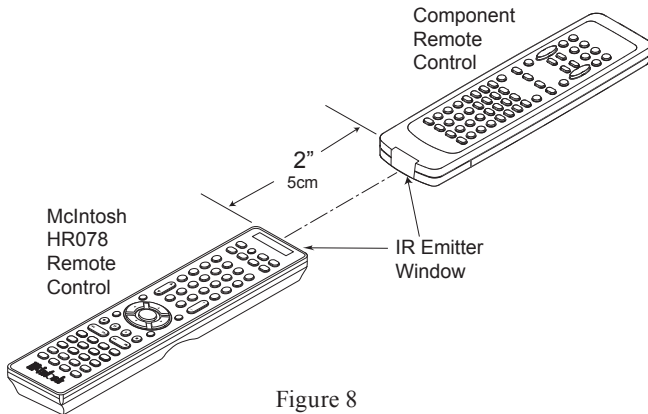

Figure 8

2. Press and hold in the SET Push-button and the SOURCE SEL Push-button until the LEARN Indicator flashes on the LCD Display. Refer to figure 10.

Notes: 1. For easier operation, use the same Input Source Push-button as the desired component device to be controlled (eg. TV Push-button for controlling the TV).

2. The McIntosh Remote Control is capable of storing in memory up to approximately 160 learned commands.
3. The following McIntosh Remote Control Push-buttons may not be assigned to store/

issue remote control component commands:

SOURCE ON/OFF, MACRO, SET, HDMI, Mc, ZONE 2, ZONE 3, BD, DVD, VCR, SAT, GAME, AUX 1, NET/USB, TV, CD, CDR, TUNE and PH

4. If a Source Input like CD is selected and transport functions such as PLAY ►, STOP ■, etc. are used to learn commands to control a non-McIntosh CD Player, the default McIntosh equivalent Control Commands will be deleted.

3. Press the Assigned Input Source (TV) Push-button. The source name will now appear on the LCD Display.
4. Press the Push-button (CHANNEL +) to learn the Component Remote Control function. The LEARN indicator will stop flashing.
5. Press the Channel Up Push-button on the (TV) Component Remote Control. The McIntosh Remote Control LCD Display



Figure 9

- will momentarily indicate OK. Refer to figure 9.
6. Press the SET Push-button to store the change.
7. Repeat steps 2 through 6 for each additional remote control commands to be learned. For future reference, record the learned commands on the next page for future reference.

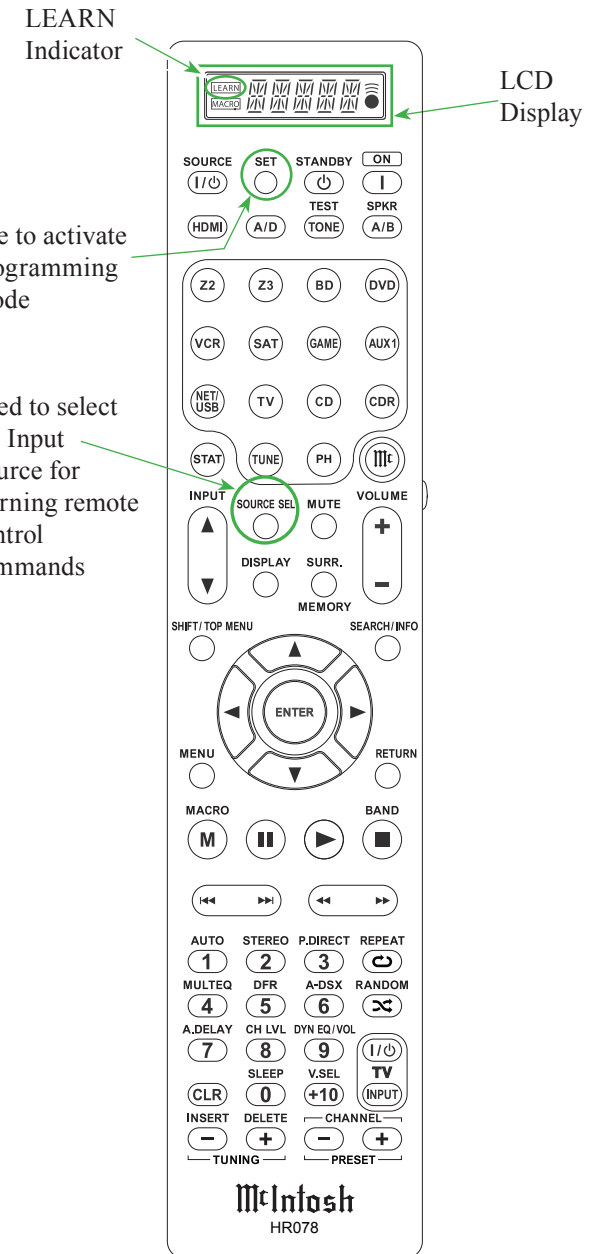

Figure 10

HR078 Input Source	HR078 Remote Push-button	Component Remote Push-button	HR078 Remote Push-button	Component Remote Push-button	HR078 Remote Push-button	Component Remote Push-button	HR078 Remote Push-button	Component Remote Push-button
BD								
DVD								
SAT								
GAME								
AUX 1								
TV								
CD								
CDR								
TUNE								
PH								



McIntosh Laboratory, Inc.
2 Chambers Street
Binghamton, NY 13903
www.mcintoshlabs.com

The continuous improvement of its products is the policy of McIntosh Laboratory Incorporated who reserve the right to improve design without notice.
Printed in the U.S.A.