

## Operating Instructions

### DVD Home Theater Sound System

Model No. **SC-HT930**

*Advanced progressive scan* page **7**  
Provides a smoother and sharper image.

*Compatible with a variety of media formats* page **11**  
DVD-RAM, DVD-Audio, DVD-Video and more.

*High performance sound effects* page **26**  
Sound field control (SFC), Bass sound enhancement and more.

#### Region number

The player plays DVD-Video marked with labels containing the region number or "ALL".

Region	Number
The Middle East, South Africa, Saudi Arabia and Kuwait	2
Southeast Asia and Thailand	3

#### Example:

Southeast Asia and Thailand



Before connecting, operating or adjusting this product, please read the instructions completely. Please keep this manual for future reference.

# Dear customer

Thank you for purchasing this product. For optimum performance and safety, please read these instructions carefully.

Operations in these instructions are described mainly with the remote control, but you can perform the operations on the main unit if the controls are the same.

<b>System</b>	SC-HT930
<b>Main unit</b>	SA-HT930
<b>Front speakers</b>	SB-FS930
<b>Center speaker</b>	SB-PC930
<b>Surround speakers</b>	SB-FS880
<b>Active subwoofer</b>	SB-WA930

## CAUTION!

**THIS PRODUCT UTILIZES A LASER. USE OF CONTROLS OR ADJUSTMENTS OR PERFORMANCE OF PROCEDURES OTHER THAN THOSE SPECIFIED HEREIN MAY RESULT IN HAZARDOUS RADIATION EXPOSURE. DO NOT OPEN COVERS AND DO NOT REPAIR YOURSELF. REFER SERVICING TO QUALIFIED PERSONNEL.**

## WARNING:

**TO REDUCE THE RISK OF FIRE, ELECTRIC SHOCK OR PRODUCT DAMAGE, DO NOT EXPOSE THIS APPARATUS TO RAIN, MOISTURE, DRIPPING OR SPLASHING AND THAT NO OBJECTS FILLED WITH LIQUIDS, SUCH AS VASES, SHALL BE PLACED ON THE APPARATUS.**

## CAUTION!

- DO NOT INSTALL OR PLACE THIS UNIT IN A BOOKCASE, BUILT-IN CABINET OR IN ANOTHER CONFINED SPACE. ENSURE THE UNIT IS WELL VENTILATED. TO PREVENT RISK OF ELECTRIC SHOCK OR FIRE HAZARD DUE TO OVERHEATING, ENSURE THAT CURTAINS AND ANY OTHER MATERIALS DO NOT OBSTRUCT THE VENTILATION VENTS.
- DO NOT OBSTRUCT THE UNIT'S VENTILATION OPENINGS WITH NEWSPAPERS, TABLECLOTHS, CURTAINS, AND SIMILAR ITEMS.
- DO NOT PLACE SOURCES OF NAKED FLAMES, SUCH AS LIGHTED CANDLES, ON THE UNIT.
- DISPOSE OF BATTERIES IN AN ENVIRONMENTALLY FRIENDLY MANNER.

This product may receive radio interference caused by mobile telephones during use. If such interference is apparent, please increase separation between the product and the mobile telephone.

The socket outlet shall be installed near the equipment and easily accessible or the mains plug or an appliance coupler shall remain readily operable.

THIS UNIT IS INTENDED FOR USE IN TROPICAL CLIMATES.

## CAUTION:

**The AC voltage is different according to the area. Be sure to set the proper voltage in your area before use. (For details, please refer to page 8.)**

<b>CAUTION</b>	- LASER RADIATION WHEN OPEN. DO NOT STARE INTO BEAM. FDA 21 CFR / Class II
<b>CAUTION</b>	- VISIBLE AND INVISIBLE LASER RADIATION WHEN OPEN. AVOID EXPOSURE TO BEAM. IEC60825-1 / Class 3b
<b>VARNING</b>	- SYNLLIG OCH OSYNLLIG LASERSTRÅLNING NÄR DENNA DEL ÄR ÖPPNAD. BETRÄKTA EJ STRÅLEN.
<b>ADVARSEL</b>	- SYNLLIG OG OSYNLLIG LASERSTRÅLING VED ÅBNING. UNDGÅ UDSETELSE FOR STRÅLING.
<b>ADVARSEL</b>	- SYNLLIG OG OSYNLLIG LASERSTRÅLING NÄR DEKSEL ÅPNET. UNNGÅ EKSPONERING FOR STRÅLEN.
<b>VARO!</b>	- AVATTAESSA OLET ALTIINNA NÄKYVÄÄ JA NÄKYMÄTÖN LASERSÄTELYLLE. ÄLÄ KATSO SÄTEESSEEN.
<b>VORSICHT</b>	- SICHTBARE UND UNSICHTBARE LASERSTRÄHLUNG. WENN ABDECKUNG GEÖFFNET NICHT DEM STRAHLEN AUSSETZEN.
<b>ATTENTION</b>	- RAYONNEMENT LASER VISIBLE ET INVISIBLE EN CAS D'OUVERTURE. EXPOSITION DANGEREUSE AU FAISCEAU.
<b>注意</b>	- 打开时有可见及不可见激光辐射。避免激光照射。
<b>注意</b>	- ここを開くと可視及び不可視レーザー光が出ます。ビームを覗いたり、触れたりしないで下さい。 ROLV80054

(Inside of product)

### Southeast Asia and Thailand

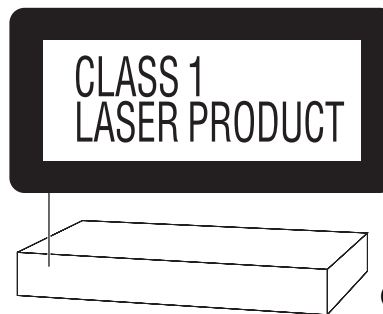

(Back of product)

### The Middle East, South Africa, Saudi Arabia and Kuwait

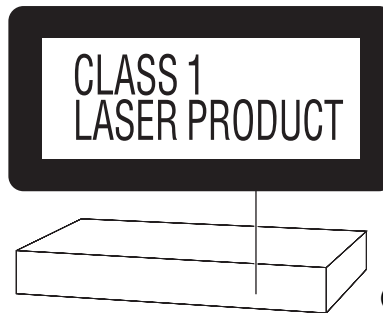

(Back of product)

# Caution for AC Mains Lead

## (For Saudi Arabia and Kuwait)



### ("GS" area code model only)

For your safety, please read the following text carefully.

This appliance is supplied with a moulded three pin mains plug for your safety and convenience.

A 5-ampere fuse is fitted in this plug.

Should the fuse need to be replaced please ensure that the replacement fuse has a rating of 5-ampere and that it is approved by ASTA or BSI to BS1362.

Check for the ASTA mark  or the BSI mark  on the body of the fuse.

If the plug contains a removable fuse cover you must ensure that it is refitted when the fuse is replaced.

If you lose the fuse cover the plug must not be used until a replacement cover is obtained.

A replacement fuse cover can be purchased from your local dealer.

#### CAUTION!

IF THE FITTED MOULDED PLUG IS UNSUITABLE FOR THE SOCKET OUTLET IN YOUR HOME THEN THE FUSE SHOULD BE REMOVED AND THE PLUG CUT OFF AND DISPOSED OF SAFELY.

THERE IS A DANGER OF SEVERE ELECTRICAL SHOCK IF THE CUT OFF PLUG IS INSERTED INTO ANY 13-AMPERE SOCKET.

If a new plug is to be fitted please observe the wiring code as stated below.

If in any doubt please consult a qualified electrician.

#### IMPORTANT

The wires in this mains lead are coloured in accordance with the following code:

Blue: Neutral, Brown: Live.

As these colours may not correspond with the coloured markings identifying the terminals in your plug, proceed as follows:

The wire which is coloured Blue must be connected to the terminal which is marked with the letter N or coloured Black or Blue.

The wire which is coloured Brown must be connected to the terminal which is marked with the letter L or coloured Brown or Red.

**WARNING: DO NOT CONNECT EITHER WIRE TO THE EARTH TERMINAL WHICH IS MARKED WITH THE LETTER E, BY THE EARTH SYMBOL  $\perp$  OR COLOURED GREEN OR GREEN/YELLOW.**

**THIS PLUG IS NOT WATERPROOF—KEEP DRY.**

#### Before use

Remove the connector cover.

#### How to replace the fuse

The location of the fuse differ according to the type of AC mains plug (figures A and B). Confirm the AC mains plug fitted and follow the instructions below.

Illustrations may differ from actual AC mains plug.

1. Open the fuse cover with a screwdriver.

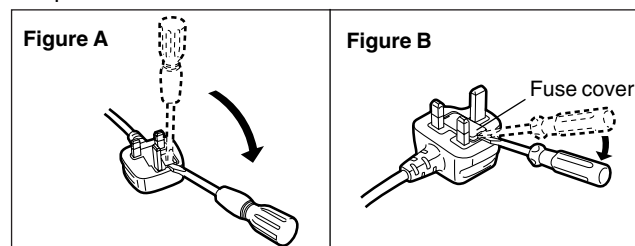

2. Replace the fuse and close or attach the fuse cover.

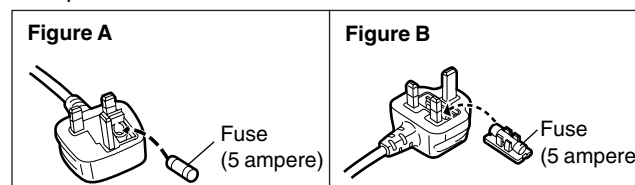

## Table of contents

### Getting started

Caution for AC Mains Lead ..... 3

#### Simple setup

STEP 1 *Speaker assembly* ..... 4

Other speaker setup options

STEP 2 *Positioning* ..... 6

STEP 3 *Connecting speakers with the subwoofer*... 7

STEP 4 *Video connections* ..... 7

STEP 5 *Radio and system connections* ..... 8

STEP 6 *The remote control* ..... 9

STEP 7 *QUICK SETUP* ..... 9

Control reference guide ..... 10

Discs that can be played ..... 11

Main unit and disc caution ..... 11

### Disc operations

*Basic play* ..... 12

Using the main unit/Using the remote control

Convenient functions ..... 14–17

Disc information/Displaying current playback condition (QUICK OSD)/Reviewing titles to play (ADVANCED DISC REVIEW)/

CD sequential play (CD MODE)/Quick replay/

Skipping 30 seconds forward/

Changing the zoom ratio/Changing play speed/

Angle selection and Still picture rotation/advance/

Changing soundtracks/Changing subtitles/Repeat play/

Program/Random play

Using navigation menus ..... 18

Playing data discs/Playing from the selected track in the CD/

Playing HighMAT™ discs/Playing RAM discs

Using on-screen menus ..... 20

Main menu/Other Settings

Changing the player settings ..... 22

Changing the delay time (Speaker Settings)

### Other operations

The radio ..... 24

Automatic presetting/Selecting the preset channels/

Manual tuning/Optional antenna connections

Sound field and sound quality ..... 26

Sound Field Control/Super Surround/Center Focus/

Dolby Pro Logic II/Down-mixing/Enhancing the bass sound/

Subwoofer level/Speaker level adjustments

Other useful functions ..... 27

Sleep timer/Muting/Using headphones

Operating other equipment ..... 28

Operating the television and the video cassette recorder/

Operating the tape deck

### Reference

Specifications ..... 30

Troubleshooting guide ..... 32

Safety precautions/Maintenance/Glossary ..... 34

Accessories ..... Back cover

# Simple setup

## STEP 1 Speaker assembly

The supplied stands are specially designed for attachment to Panasonic SB-FS930 front speakers or SB-FS880 surround speakers. Use only as indicated in this setup.

### Preparation

- To prevent damage or scratches, lay down a soft cloth and perform assembly on it.
- For assembly, use a Phillips-head screwdriver.
- Make sure you have all the indicated components before starting assembly, setup, and connection.
- There is no difference between the right and left speakers and pipes.

### Note

- To prevent the speaker cables from being pulled out of the pipes, leave the plastic wrap on the pipes while assembling the speaker stands.
- The front and surround speaker pairs as well as the pipe pairs are different.
  - Check the label on the rear of the speaker before attaching the pipe (→ page 6).
  - The pipe with the shorter cable is for the front speaker.

2 Front and  
2 Surround speakers



4 Pipes

- 2×pipes with short cable: For front speakers
- 2×pipes with long cable: For surround speakers



4 Bases

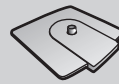

8 Long screws



8 Short screws



## 1 Assemble the speaker stands.

### 1 Thread the speaker cable through the base.

For quicker threading, loosely fold the cable in half (do not crease), pass the folded portion through the hole, and then pull the rest of the cable through the base.

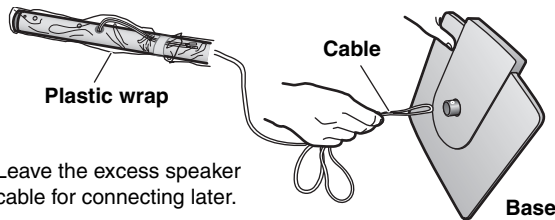

Leave the excess speaker cable for connecting later.

### 2 Insert the pipe.

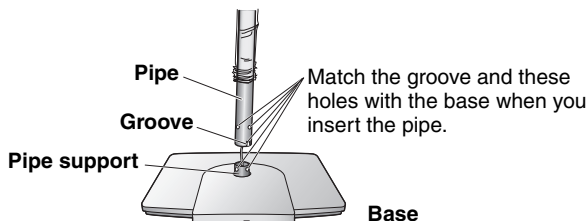

Insert the pipe while gently pulling on the speaker cable.

### 3 Secure the pipe to the base.

Ensure the screws are securely fastened.

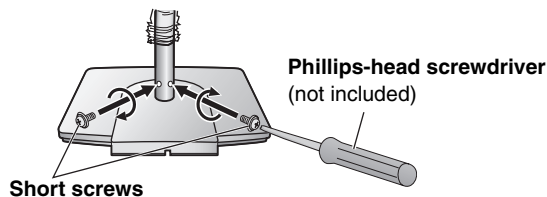

Before proceeding to the next step, please remove the plastic wrap from the pipe.

## 2 Attach the stands to the speakers.

Ensure the stand is fastened on straight by gradually tightening the top and bottom screws alternately until fully tightened.

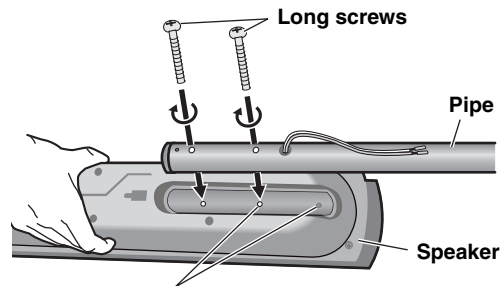

You can also attach to the lower rear of the speaker.

The height of the speaker can be changed when attaching the stand to the upper rear or lower rear of the speaker.

## 3 Connect the speaker cables.

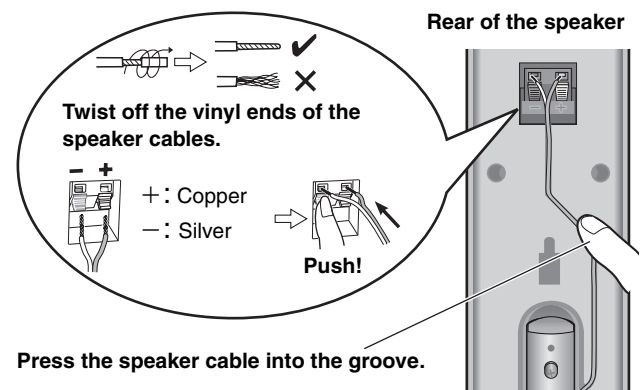

Press the speaker cable into the groove.

If there is any excess speaker cable, thread the speaker cable into the opening near the top of the pipe while pulling the speaker cable from the bottom of the base.

## 4 Secure the speaker cables to the bases.

Press the speaker cable into the base cover groove as far as possible.

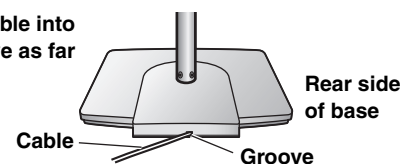

## ■ Preventing the speakers from falling over

### Preparation

Attach screw eyes (not included) to secure the speakers to the wall (→ diagram right).

- You will need to obtain the appropriate screw eyes to match the walls or pillars to which they are going to be fastened.
- Consult a qualified housing contractor concerning the appropriate procedure when attaching to a concrete wall or a surface that may not have strong enough support. Improper attachment may result in damage to the wall or speakers.

- 1 Thread the string (not included) through the slot on the rear of the speaker to prevent it from falling over.
- 2 Loop the string through the screw eye and tie tightly.

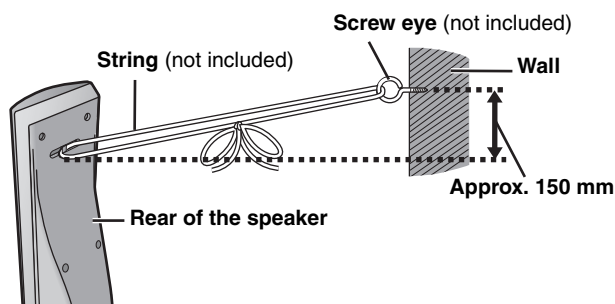

## Other speaker setup options

### ■ Attaching to a wall

You can attach all of the speakers to a wall.

- 1 Drive a screw (not included) into the wall.
- 2 Fit the speaker securely onto the screw(s) with the hole(s).

- The wall or pillar on which the speakers are to be attached should be capable of supporting 10 kg per screw. Consult a qualified building contractor when attaching the speakers to a wall. Improper attachment may result in damage to the wall and speakers.

#### (Front and surround speakers)

- When mounting the front or surround speakers to a wall, we recommend using a string (not included) to prevent it from falling (→ above).
- Use of optional speaker cables is recommended for wall-mounted front or surround speakers. (You can also remove the speaker cables from the pipes supplied with this system).

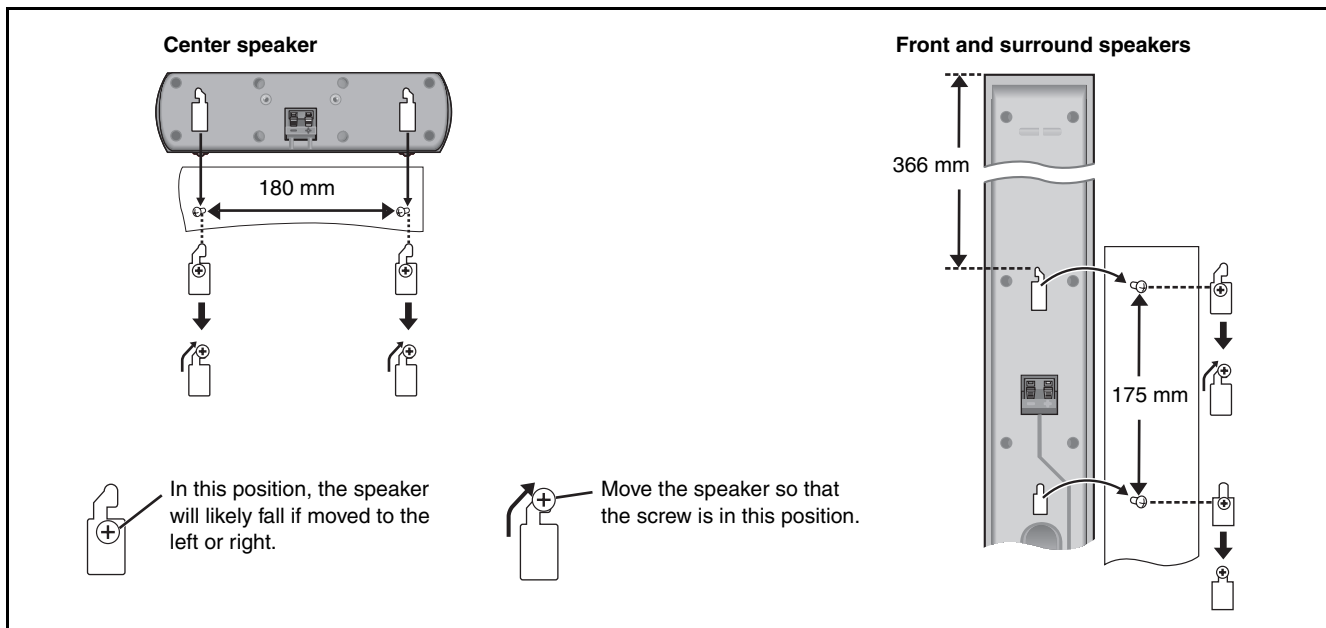
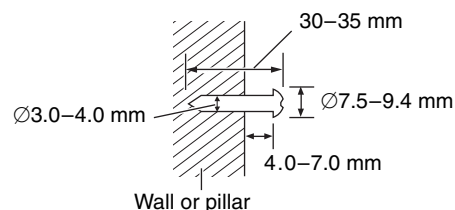

### ■ Fitting speaker stands (not included)

#### (Center speaker only)

Ensure the stands meet these conditions before purchasing them. Note the diameter and length of the screws and the distance between screws as shown in the diagram.

- The stands must be able to support over 10 kg.
- The stands must be stable even if the speakers are in a high position.

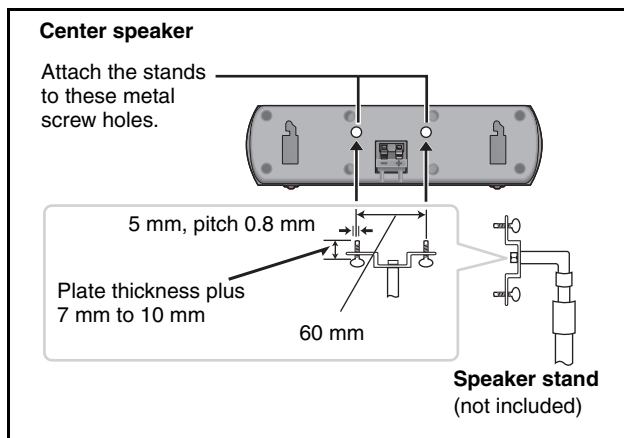

## STEP 2 Positioning

How you set up your speakers can affect the bass and the sound field. Note the following points:

- Place speakers on flat secure bases.
- Placing speakers too close to floors, walls, and corners can result in excessive bass. Cover walls and windows with thick curtains.
- The left and right speakers are the same with respect to the front and surround speaker pairs.

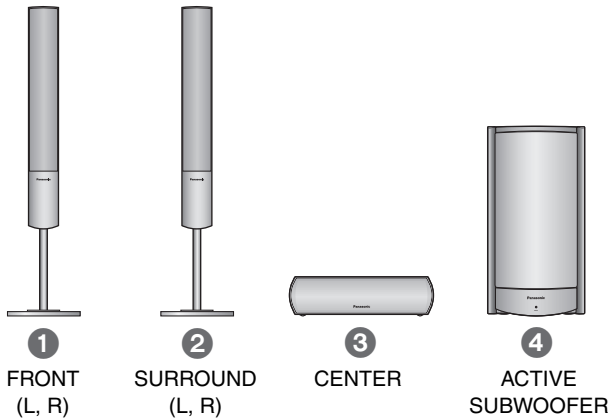

Setup example

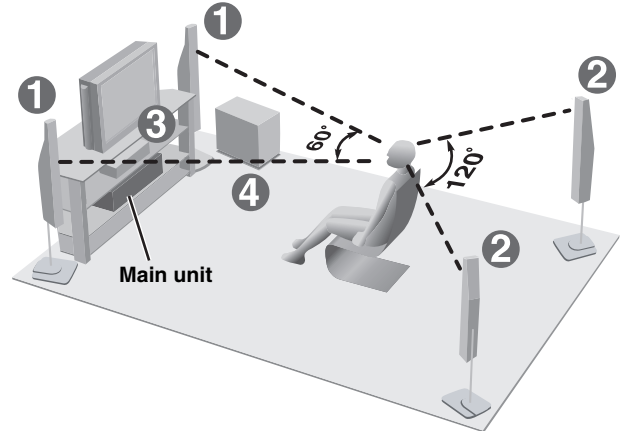

- Place the front, center, and surround speakers at approximately the same distance from the seating position. The angles in the diagram are approximate.

**Do not use a front speaker as a surround speaker or vice versa. Verify the type of speaker with the label on the rear of the front speaker.**

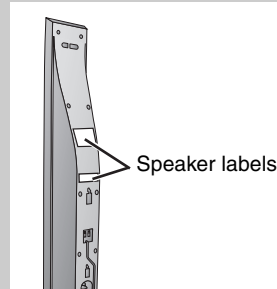

### Use only supplied speakers

Using other speakers can damage the unit, and sound quality will be negatively affected.

- Set the speakers up on an even surface to prevent them from falling. Take proper precautions to prevent the speakers from falling if you cannot set them up on an even surface.

### Main unit

#### Note

Keep your speakers at least 10 mm away from the system for proper ventilation.

### Center speaker

- Vibration caused by the center speaker can disrupt the picture if it is placed directly on the television. Put the center speaker on a rack or shelf.
- To prevent the speakers from falling, do not place directly on top of the television.

### Active subwoofer

Place to the right or left of the television, on the floor or a sturdy shelf so that it won't cause vibration. Leave 10 cm at the rear for ventilation.

### Caution

Do not stand on the base and shake the speaker.

Be cautious when children are near.

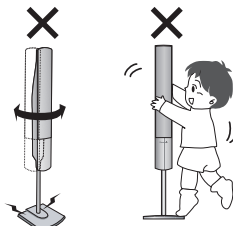

### Notes on speaker use

- You can damage your speakers and shorten their useful life if you play sound at high levels over extended periods.
- Reduce the volume in the following cases to avoid damage:
  - When playing distorted sound.
  - When the speakers are reverberating due to a record player, noise from FM broadcasts, or continuous signals from an oscillator, test disc, or electronic instrument.
  - When adjusting the sound quality.
  - When turning the unit on or off.

### If irregular coloring occurs on your television

The supplied speakers are designed to be used close to a television, but the picture may be affected with some televisions and setup combinations.

**If this occurs, turn the television off for about 30 minutes.**

The television's demagnetizing function should correct the problem. If it persists, move the speakers farther away from the television.

### Caution

- The active subwoofer and supplied speakers are to be used only as indicated in this setup. Failure to do so may lead to damage to the amplifier and/or the speakers, and may result in the risk of fire. Consult a qualified service person if damage has occurred or if you experience a sudden change in performance.
- Do not attempt to attach these speakers to walls using methods other than those described in this manual.



# STEP 3 Connecting speakers with the subwoofer

- Attach the speaker-cable stickers to make connection easier.
- The terminals of the subwoofer have high output power. Carefully connect the speaker wires.

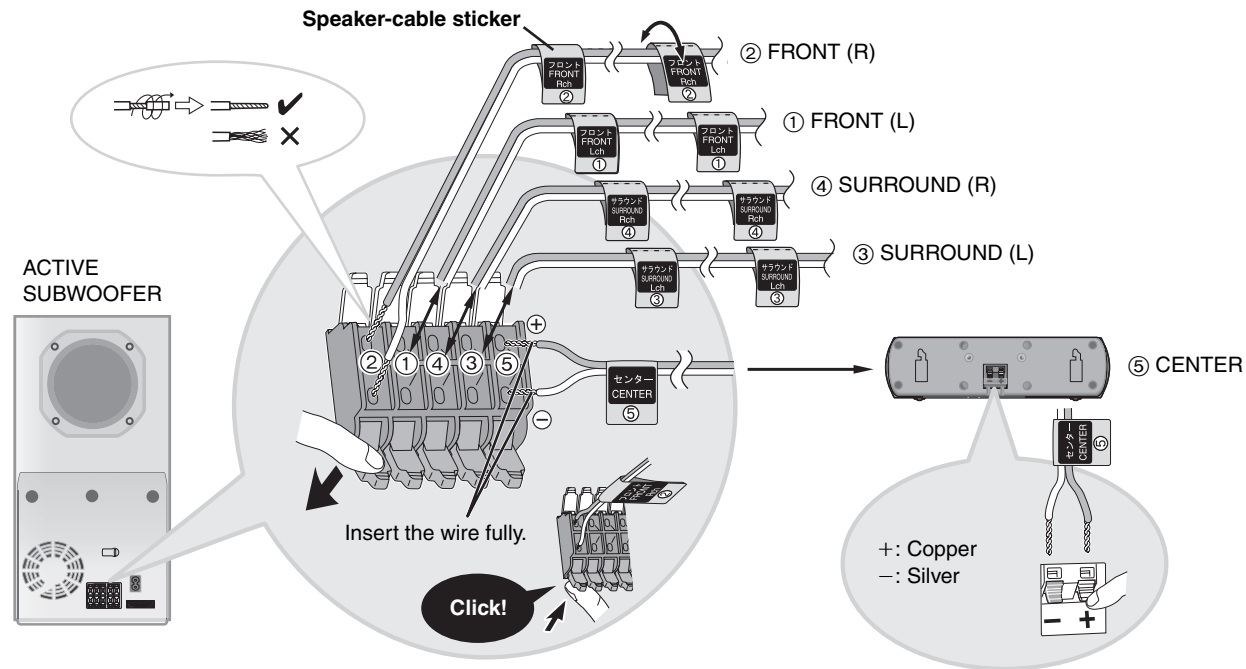

- Note**
- Never short-circuit positive (+) and negative (-) speaker wires.
  - Be sure to connect only positive (copper) wires to positive (+) terminals and negative (silver) wires to negative (-) terminals. Incorrect connection can damage the speakers.

# STEP 4 Video connections



- Do not connect through the video cassette recorder. Due to copy guard protection, the picture may not be displayed properly.
- Turn the television off before connecting, and refer to the television's operating instructions.

## Television with a VIDEO IN terminal

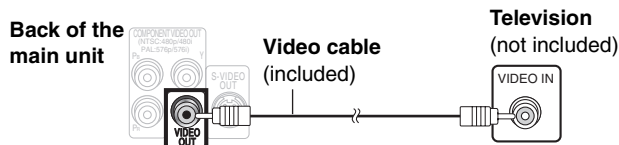

## Television with COMPONENT VIDEO IN terminals

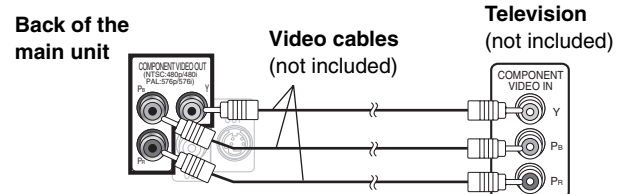

## Television with an S-VIDEO IN terminal

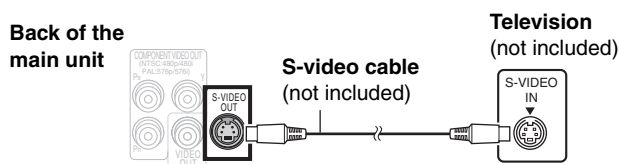

### S-VIDEO OUT terminal

The S-VIDEO OUT terminal achieves a more vivid picture than the VIDEO OUT terminal by separating the chrominance (C) and luminance (Y) signals. (Actual results depend on the television.)

### COMPONENT VIDEO OUT terminals

These terminals can be used for either interlace or progressive output and provide a purer picture than the S-VIDEO OUT terminal. Connection using these terminals outputs the color difference signals (P<sub>B</sub>/P<sub>R</sub>) and luminance signal (Y) separately in order to achieve high fidelity in reproducing colors.

- The description of the component video input terminals depends on the television or monitor (e.g. Y/P<sub>B</sub>/P<sub>R</sub>, Y/B-Y/R-Y, Y/C<sub>B</sub>/C<sub>R</sub>). Connect to terminals of the same color.

### To enjoy progressive video

Connect to the component video input terminals on a 480p (or 525p) or 576p (or 625p) compatible television. (Video will not be displayed correctly if connected to an incompatible television.)

# STEP 5 Radio and system connections



- Connect the AC mains lead after all other connections are complete.
- Optional antenna connections (→ page 25).

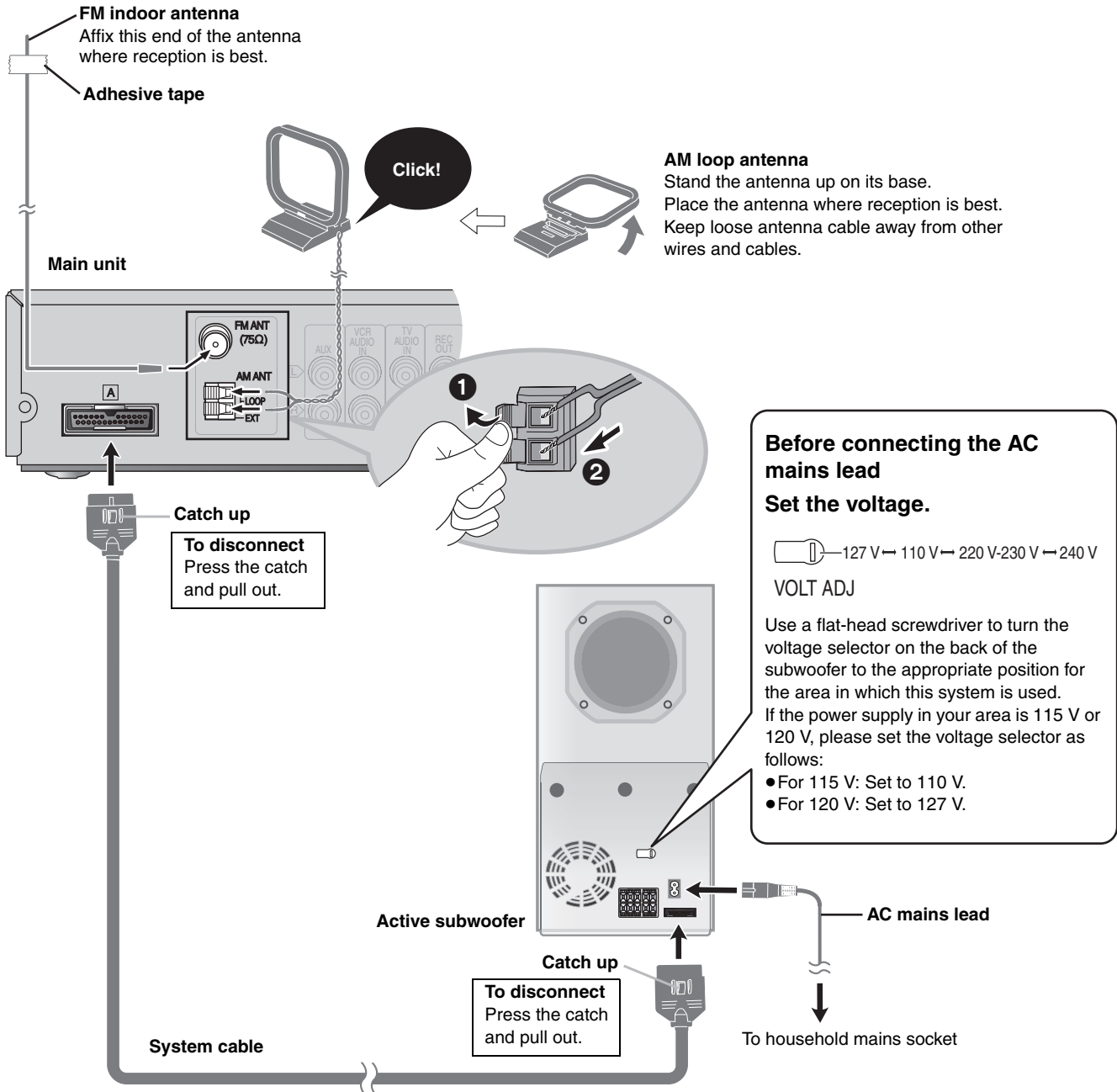

**Conserving power**

The main unit consumes a small amount of power, even when it is turned off (approx. 0.9 W). To save power when the unit is not to be used for a long time, unplug it from the household mains socket. You will need to reset some memory items after plugging in the unit.

**Note**

The included AC mains lead is for use with this unit only. Do not use it with other equipment.



## STEP 6 The remote control

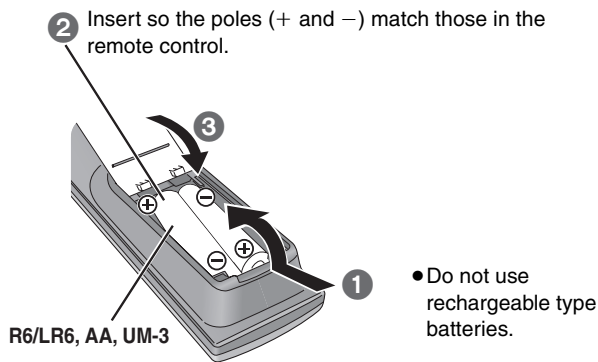
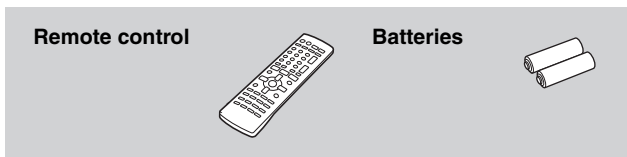

### Do not:

- mix old and new batteries.
  - use different types at the same time.
  - heat or expose to flame.
  - take apart or short circuit.
  - attempt to recharge alkaline or manganese batteries.
  - use batteries if the covering has been peeled off.
- Mishandling of batteries can cause electrolyte leakage which can damage items the fluid contacts and may cause a fire.

Remove if the remote control is not going to be used for a long period of time. Store in a cool, dark place.

### Use

Aim at the remote control signal sensor (→ page 10), avoiding obstacles, at a maximum range of 7 m directly in front of the unit.

## STEP 7 QUICK SETUP

The QUICK SETUP screen assists you to make necessary settings. Turn on the television and select the appropriate video input on the television.

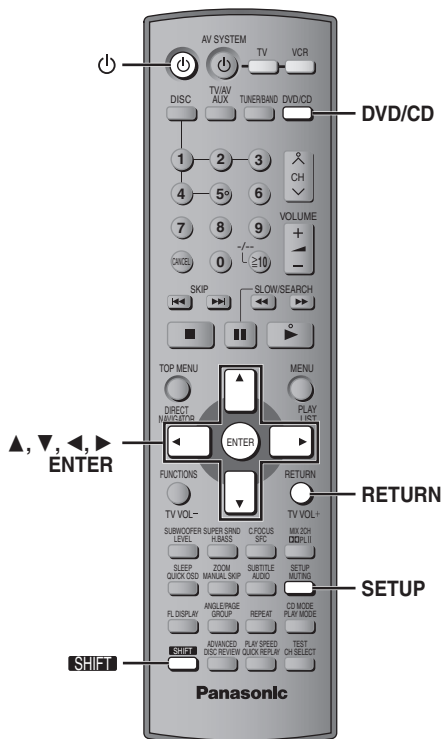

1		Turn on the unit.
2		Select "DVD/CD".
3		Show the QUICK SETUP screen.
4		Follow the messages and make the settings.
5		Press to finish QUICK SETUP.
6		Press to exit.

### To change these settings later

Select "QUICK SETUP" in the "Others" tab (→ page 23).

# Control reference guide

See reference pages in brackets.

Turn the unit on/off (9)

Select the disc or show disc information (14)  
Switch the television's video input mode (28)

Select television channels and disc's title numbers etc./Enter numbers (13)

Cancel (13)

Show a disc top menu (18) or program list (19)

Select or register menu items on the television screen, Frame-by-frame (13)

Show on-screen menu (20) or television volume down (28)

Television and Video cassette recorder operations (28)

Select the source AUX (29), TUNER/BAND (24), DVD/CD (9)

Channel select (24, 28)

Adjust the volume (13)

Basic operations for play (12, 13)

Show a disc menu (18) or play list (19)

Return to previous screen (13) or television volume up (28)

To use functions labeled in orange: While pressing [SHIFT], press the corresponding button.

SUBWOOFER LEVEL (27)	SUPER SRND H.BASS (26)	C.FOCUS SFC (26)	MIX 2CH CD PL II (26)
SLEEP QUICK OSD (14, 27)	ZOOM MANUAL SKIP (14, 15)	SUBTITLE AUDIO (15)	SETUP MUTING (22, 27)
FL DISPLAY (13)	ANGLEPAGE GROUP (13, 15)	REPEAT (15)	CD MODE PLAY MODE (14, 16)
ADVANCED DISC REVIEW (14)	PLAY SPEED QUICK REPLAY (14, 15)	TEST CH SELECT (27)	

## Standby/on indicator

When the unit is connected to the AC mains supply, this indicator lights up in standby mode and goes out when the unit is turned on.

## H.BASS

Turn the bass sound enhancement on/off (26)

## H.BASS indicator

## PROGRESSIVE

Enjoy progressive video (12)

## CD MODE

Play several music CD's sequentially (14)

⏪/⏩/⏮/⏭/⏪/⏩/⏮/⏭/⏪/⏩/⏮/⏭ TUNING ▲  
Skipping or slow-search play (12)/  
Select the radio stations (24)

## ▲ OPEN/CLOSE

Open/Close the disc drawer (12)

## DISC EXCHANGE

Open the disc drawer to exchange the disc in the play position (12)

## DISC SKIP

Skip to the next disc tray (12)

## INPUT SELECTOR (24)

DVD/CD → FM → AM → TV → VCR →  
AUX → Return to DVD/CD

## Direct select buttons/indicators

Select the disc tray (12)

## Standby/on switch [⏻/⏻]

Press to switch the unit from on to standby mode or vice versa. In standby mode, the unit is still consuming a small amount of power. (12)

## ■/TUNE MODE

Stop playing (12)/  
Select the tuning mode (24)

## ■/FM MODE

Pause (12)/Adjust the FM reception condition (24)

## ▶/MEMORY

Play discs (12)/Memorize the receiving radio stations (24)

## Jog LED

## PHONES

Connect headphones (27)

## VOLUME







Turn up/down the volume (12)

Remote control signal sensor

## AC supply indicator [AC IN]

This indicator lights when the unit is connected to the AC mains supply.

# Discs that can be played

Disc	Logo	Indication in these operating instructions	Remarks
DVD-RAM		<b>RAM</b>	Recorded with devices using Version 1.1 of the Video Recording Format (a unified video recording standard), such as DVD video recorders, DVD video cameras, personal computers, etc.
		<b>JPEG</b>	Recorded using the DCF (Design rule for Camera File system) standard Version 1.0. ● To play JPEG files, select "Play as Data Disc" in Other Menu (→ page 21).
DVD-Audio		<b>DVD-A</b>	—
		<b>DVD-V</b>	Some DVD-Audio discs contain DVD-Video content. To play DVD-Video content, select "Play as DVD-Video" in Other Menu (→ page 21).
DVD-Video			—
DVD-R (DVD-Video)/ DVD-RW (DVD-Video)		<b>DVD-V</b>	Discs recorded and finalized* on DVD video recorders or DVD video cameras.
+R (Video)/ +RW (Video)	—		Discs recorded and finalized* on DVD video recorders or DVD video cameras.
Video CD		<b>VCD</b>	—
SVCD			Conforming to IEC62107
CD		<b>CD</b>	This unit is compatible with HDCD, but does not support the Peak Extend function (a function which expands the dynamic range of high level signals). HDCD-encoded CD's sound better because they are encoded with 20 bits, as compared with 16 bits for all other CD's.
CD-R CD-RW	—	<b>WMA</b> <b>MP3</b> <b>JPEG</b> <b>CD</b> <b>VCD</b>	<ul style="list-style-type: none"> <li>● This unit can play CD-R/RW (audio recording disc) recorded with the formats on the left. Close the sessions or finalize* the disc after recording.</li> <li>● <b>HighMAT discs</b> WMA, MP3 or JPEG files only. To play without using the HighMAT function, select "Play as Data Disc" in Other Menu (→ page 21).</li> <li>● <b>WMA</b> This unit does not support Multiple Bit Rate (MBR: a file that contains the same content encoded at several different bit rates).</li> </ul>

\* A process that allows play on compatible equipment.

● It may not be possible to play the above discs in all cases due to the type of disc or condition of the recording.

## Discs that cannot be played

DVD-ROM, CD-ROM, CDV, CD-G, SACD, DivX Video Discs and Photo CD, DVD-RAM that cannot be removed from their cartridge, 2.6-GB and 5.2-GB DVD-RAM, and "Chaoji VCD" available on the market including CVD, DVCD and SVCD that do not conform to IEC62107.

## Video systems

- This unit can play PAL and NTSC, but your television must match the system used on the disc.
- PAL discs cannot be correctly viewed on an NTSC television.
- This unit can convert NTSC signals to PAL 60 for viewing on a PAL television (→ page 23, "NTSC Disc Output" in "Video" tab).

## Audio format of DVD's

This unit automatically recognizes and decodes discs with these symbols.



# Main unit and disc caution

## To prevent damage

Do not:

- load more than one disc per tray.
- touch the drawer or the carousel while they are in motion.
- rotate the carousel by hand.
- close the drawer by hand.

## To clean discs

Wipe with a damp cloth and then wipe dry.



## Disc handling precautions

- Do not attach labels or stickers to discs (This may cause disc warping, rendering it unusable).
- Do not write on the label side with a ball-point pen or other writing instrument.
- Do not use record cleaning sprays, benzine, thinner, static electricity prevention liquids or any other solvent.
- Do not use scratch-proof protectors or covers.
- Do not use the following discs:
  - Discs with exposed adhesive from removed stickers or labels (rented discs, etc).
  - Discs that are badly warped or cracked.
  - Irregularly shaped discs, such as heart shapes.

Discs that can be played/Main unit and disc caution

# Basic play

**1** Turn the unit on.



**3** Open the drawer and place the disc(s).

- Load double-sided discs so the label for the side you want to play is facing up.
- To load discs on the other trays, press [DISC SKIP] on the main unit.
- Play will start from the disc in the front-left position of the tray.
- **RAM** Remove the disc from its cartridge before use.



**2** Select "DVD/CD".



**4** Close the drawer.

A disc indicator lights if a disc is detected or a tray is unchecked (→ page 14, Disc information).

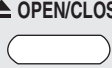

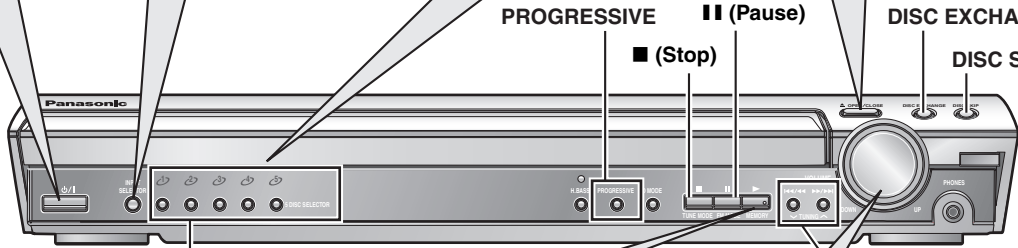



**5** Start play.

When the disc finishes playing:  
If the next disc doesn't start playing, select it with the 5 DISC SELECTOR buttons.

- You can also select the disc using the remote control (→ page 14, Disc information).



**6** Adjust the volume.



Press to skip.  
Press and hold to

- search (during play)
- slow-motion (during pause) (Motion picture part)



• Press [▶] (play) to start normal play.



## Using the main unit

**Progressive video**

PROGRESSIVE

**Skipping to the next disc tray**

DISC SKIP

- While the drawer is closed  
Each time you press the button, the carousel moves counter-clockwise by one tray.

**Exchanging the disc in the play position**

DISC EXCHANGE

- The drawer opens and the disc in the play position comes to the front-left position.
- Press the button again to play the disc after changing the disc in the front-left position.

**Changing the other discs without interrupting play**

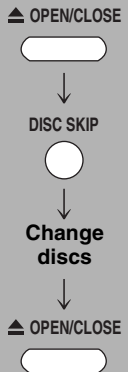

- The carousel moves one tray clockwise and each subsequent press moves it two trays in alternate directions.

**Note**

- Discs continue to rotate while menus are displayed. Press [■] when you finish to preserve the unit's motor and your television screen.
- Total title number may not be displayed properly on +R/+RW.

## Using the remote control

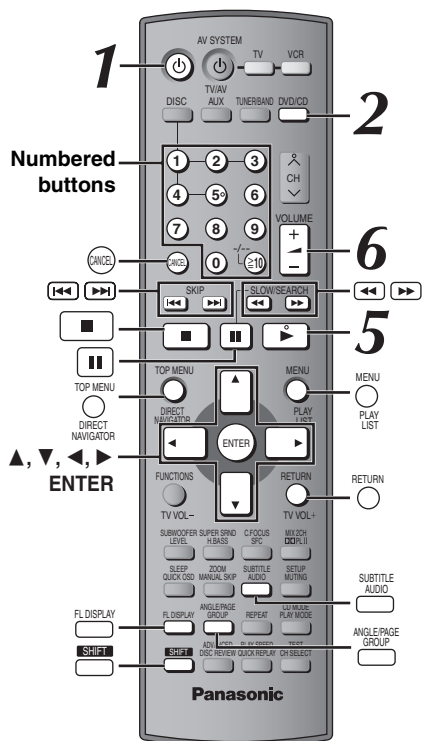

**Enter number**

RAM DVD-A DVD-V VCD CD  
e.g. To select 12:  
[≥10] → [1] → [2]

VCD with playback control  
Press [■] to cancel the PBC function, and then press the numbered buttons.

WMA MP3 JPEG  
e.g. To select 123:  
[1] → [2] → [3] → [ENTER]

• Press [CANCEL] to cancel the number(s).

**Disc menu**

DVD-A DVD-V  
Shows a disc top menu

RAM  
Shows the programs (→ page 19)

DVD-V  
Shows a disc menu

RAM  
Shows a play list (→ page 19)

VCD with playback control  
Shows a disc menu

**Return to previous screen**

RETURN

**Main unit display**

RAM DVD-A DVD-V VCD CD  
WMA MP3  
Time display  
↔ Information display

JPEG  
When Slideshow (→ page 20) is on:  
SLIDE ↔ Information display  
When Slideshow is off:  
PLAY ↔ Information display

**Subtitles/Information screen**

RAM  
Turns subtitle on/off (→ page 15)

DVD-V VCD (SVCD only)  
Selects the subtitle languages (→ page 15)

JPEG  
Date → Details of the picture  
← No information ←

**Starting play from a selected group**

DVD-A WMA MP3 JPEG  
A folder on WMA/MP3 and JPEG discs is treated as a "Group".

**Stop**

The position is memorized while "RESUME" is on the display.  
• Press [▶] (play) to resume.  
• Press [■] again to clear the position.

**Pause**

• Press [▶] (play) to restart play.

**Skip**

• WMA MP3 JPEG  
[▲, ▼]: Group skip during play  
[◀, ▶]: Content skip during play

**Search (during play)**

• Up to 5 steps.  
• Press [▶] (play) to start normal play.

**Slow-motion (during pause)**

• VCD Slow-motion: forward direction only.

**Frame-by-frame (during pause)**

DVD-A (Motion picture part)  
RAM DVD-V VCD  
• VCD Forward direction only.

**On-screen item select**

Select  
Register

Basic play

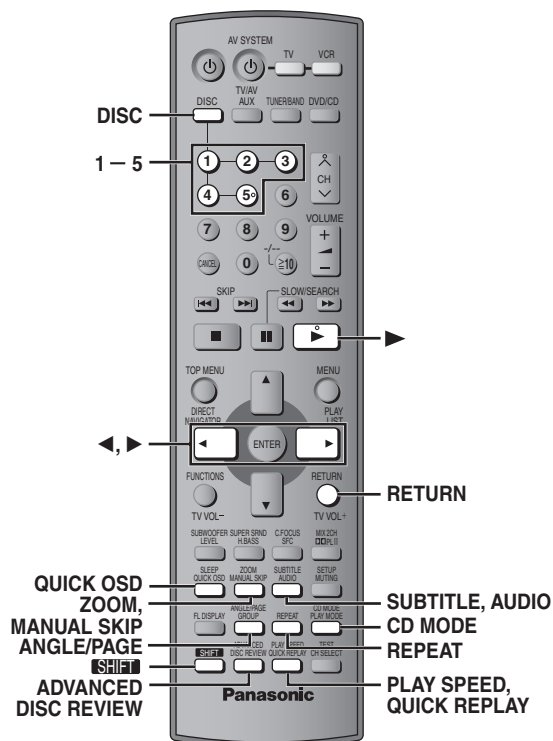

## Disc information

You can select the disc after checking the discs loaded with the Disc information screen.

- You can also select the disc directly with the 5 DISC SELECTOR buttons on the main unit.

### 1 Press [DISC] to show the Disc information screen.

e.g.

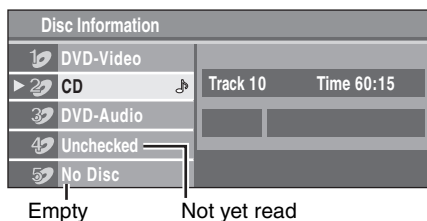

Empty Not yet read

### 2 Press the numbered buttons ([1] – [5]) to select the disc.

To clear the screen

Press [DISC].

## Displaying current playback condition (QUICK OSD)

The current playback condition is displayed.

Press [QUICK OSD].

e.g. DVD-V

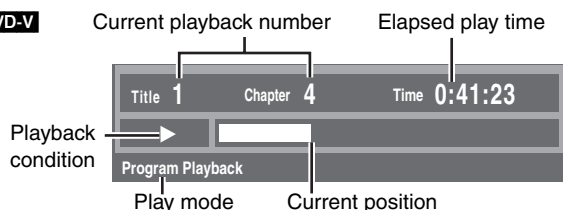

To exit the screen

Press [QUICK OSD].

- CD MP3 WMA The QUICK OSD screen will appear automatically.

## Reviewing titles to play (ADVANCED DISC REVIEW)

RAM DVD-V (Except +R/+RW)

Allows you to browse the disc contents and start playing from the selected position. You can select either "Intro Mode" or "Interval Mode" in "Advanced Disc Review" in the "Disc" tab (→ page 22).

### 1 Press [ADVANCED DISC REVIEW].

The QUICK OSD screen is displayed.

e.g. RAM

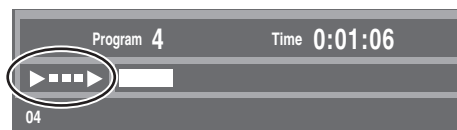

### 2 Press [▶] (play) when you find a title/program to play.

This may not work depending on the disc and the play position.

## CD sequential play (CD MODE)

VCD CD WMA MP3

This feature is very convenient if you want to play several music CD's sequentially. Make sure that applicable disc is in the play position before playing (→ Disc information, left).

DVD and JPEG are skipped without being played.

While stopped

### 1 Press [SHIFT]+[CD MODE].



### 2 Press [▶] (play).

- If all loaded discs are DVD or unchecked, CD Mode does not work and "CD MODE" flashes.
- HighMAT menus and Video CD playback control are disabled.
- You cannot change the mode during program or random play.
- If you want to play a DVD, press [SHIFT]+[CD MODE] again to cancel CD Mode. (CD Mode is also canceled when you switch the unit to standby or select another source.)

## Quick replay

(Only when the elapsed play time can be displayed.)

(Except +R/+RW)

Press [QUICK REPLAY] to skip back a few seconds.

## Skipping 30 seconds forward

(Only when the elapsed play time can be displayed.)

RAM DVD-V (Except +R/+RW)

Play restarts from approximately 30 seconds later. Convenient when you want to skip commercials etc.

During play

Press [MANUAL SKIP].

RAM It is not possible to skip through the current program if the start of the next program is within about 30 seconds of the point you are skipping from.



**Changing the zoom ratio**

**DVD-A** (Motion picture part) **RAM** **DVD-V** **VCD**  
 This feature expands the letterbox picture to fit the screen.  
**During play**  
 Press **[SHIFT]+[ZOOM]** several times to select the preset aspect ratio (Just Fit Zoom) or "Auto".

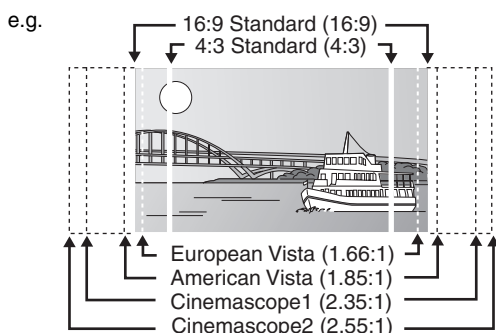
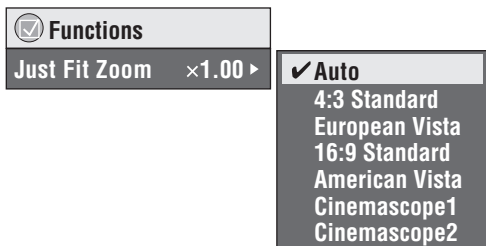

**Fine adjustments (Manual Zoom)**  
 After selecting the preset aspect ratio or "Auto", press [**◀**, **▶**].  
 –from "×1.00" to "×1.60" (in 0.01 units)  
 –from "×1.60" to "×2.00" (in 0.02 units)  
 • Press and hold [**◀**, **▶**] to alter faster.

**Changing play speed**

**DVD-A** (Motion picture part) **RAM** **DVD-V**  
**During play**  
 Press **[SHIFT]+[PLAY SPEED]** several times to select "Normal", "Fast" or "Slow".



**Changing play speed between the range of "×0.6" to "×1.4" (in 0.1 units)**  
 Press [**◀**, **▶**] while the above message is displayed.

- Press [**▶**] (play) to return to normal play.
- After you change the speed
  - Dolby Pro Logic II and Sound Enhancement do not work.
  - Audio output switches to 2ch.
  - Sampling frequency of 96 kHz is converted to 48 kHz.
  - Multi Re-master does not work.
- This function may not work depending on the disc's recording.

**Angle selection and Still picture rotation/advance**

Press **[SHIFT]+[ANGLE/PAGE]** several times to select the angle or rotate/advance the still picture.

- DVD-V** (with multiple angles)–Angle selection
- JPEG** –Still picture rotation
- DVD-A** –Still picture advance  
 (Press **[RETURN]** to go back to page 1.)

**Changing soundtracks**

**DVD-A** **DVD-V** (with multiple soundtracks) **RAM** **VCD**  
 Press **[AUDIO]** several times to select the soundtrack.

**RAM** **VCD**  
 You can use this button to select "L", "R" or "LR".



**DVD-V** (Karaoke discs)  
 Press [**◀**, **▶**] to select "On" or "Off" for vocals.  
 Read the disc's instructions for details.

**Signal type/data**

LPCM/PPCM/□□Digital/DTS/MPEG: Signal type  
 kHz (Sampling frequency)/bit/ch (Number of channels)  
 Example: 3/2, 1ch

.1: Low frequency effect (not displayed if there is no signal)
0: No surround
1: Mono surround
2: Stereo surround (left/right)
1: Center
2: Front left+ Front right
3: Front left+ Front right+ Center

**Changing subtitles**

**DVD-V** (with multiple subtitles) **VCD** (SVCD only)  
 Press **[SHIFT]+[SUBTITLE]** several times to select the subtitle language.

- On +R/+RW, a subtitle number may be shown for subtitles that are not displayed.

**To display/clear the subtitles**  
 Press [**◀**, **▶**] to select "On" or "Off".



**RAM** (On/Off only with discs that contain subtitle on/off information)

Press **[SHIFT]+[SUBTITLE]** to select "On" or "Off".

- Subtitle on/off information cannot be recorded using Panasonic DVD Recorders.

**Repeat play**

(Only when the elapsed play time can be displayed.  
**JPEG**: Works with all JPEG content.)

**During play**  
 Press **[REPEAT]** several times to select an item to be repeated.

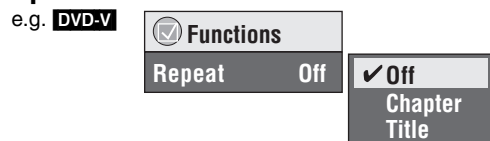

**RAM**: Program→Disc→Off

- During play list play: Scene→Playlist→Off

**DVD-A**: Track→Group\*→Off

**DVD-V**: Chapter→Title\*→Off

**VCD** **CD**: Track→Disc\*→Off

- When CD Mode is on: Track→Disc→All CD's→Off
- When CD Mode is on, during program and random play:  
 Track→All CD's→Off

**WMA** **MP3**: Content→Group\*→Off

- When CD Mode is on: Content→Group→All CD's→Off
- When CD Mode is on, during program and random play:  
 Content→All CD's→Off

**JPEG**: Group\*→Off

\* "All" is displayed during program and random play.



## Program/Random play

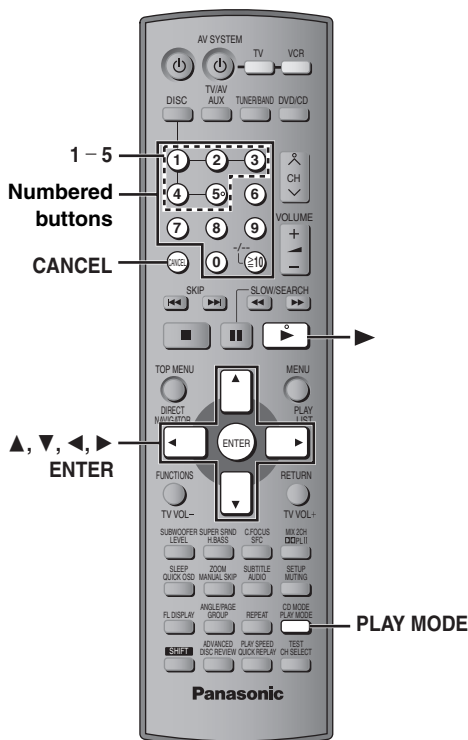

### Press [PLAY MODE] while stopped.

Program and random playback screens appear sequentially.

Program → Random\*

\* "RANDOM 1" and "RANDOM 2" (→ page 17) are displayed on the main unit's display when CD Mode is on (→ page 14).

### To exit the program and random mode

Press [PLAY MODE] several times while stopped.

- Disable HighMAT disc play to use program and random play. Select "Play as Data Disc" in Other Menu (→ page 21).
- **DVD-A**  
Some discs contain bonus groups. If a password screen appears after selecting a group, enter the password with the numbered buttons to play the bonus group. Refer also to the disc's jacket.

### Program play (up to 32 items)

#### ■ When CD Mode is off

**DVD-A** **DVD-V** **VCD** **CD** **WMA** **MP3** **JPEG**

You can program all the items on a disc in the play position.

- 1** **DVD-A** **DVD-V** Press the numbered buttons to select a group (**WMA** **MP3** **JPEG**) then press [ENTER] or title.

e.g. **DVD-V**

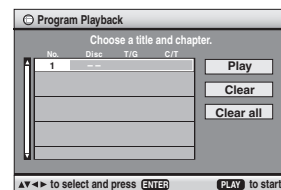

#### • To select a 2-digit number

e.g. To select 25: [≥10] → [2] → [5]

**WMA** **MP3** **JPEG** [2] → [5] → [ENTER]

- 2** Press the numbered buttons to select a chapter or track (**WMA** **MP3** **JPEG**) then press [ENTER].

• Repeat steps 1 and 2 to program other items.

• **VCD** **CD** Step 1 is unnecessary.

- 3** Press [▶] (play).

#### ■ When CD Mode is on (→ page 14)

**VCD** **CD** **WMA** **MP3**

You can program all the items on all the discs.

- 1** Press the numbered buttons ([1] – [5]) to select a disc.

- 2** Press the numbered buttons to select the items (**WMA** **MP3**) then press [ENTER].

#### • To select a 2-digit number

e.g. To select 25: [≥10] → [2] → [5]

**WMA** **MP3** [2] → [5] → [ENTER]

• Repeat steps 1 and 2 to program other items.

- 3** Press [▶] (play).

#### To select an item using the cursor buttons

Press [ENTER] and [▲, ▼] to select an item, then press [ENTER] again to register.

#### To change the selected program

- 1 Press [▲, ▼] to select an item.
- 2 Repeat above steps 1 and 2.

#### To clear the selected program

- 1 Press [▲, ▼] to select an item.
- 2 Press [CANCEL] (or press [▲, ▼, ◀, ▶] to select "Clear" and press [ENTER]).

#### To clear the whole program

Select "Clear all" with [▲, ▼, ◀, ▶] and press [ENTER].

The whole program is also cleared when the disc is moved out of the play position, the unit is turned off or another source is selected.

## Random play

### ■ When CD Mode is off

VCD CD

You can play all the items on a disc in the play position in random order.

DVD-A DVD-V WMA MP3 JPEG

You can play selected item(s) on a disc in the play position in random order.

1

DVD-A DVD-V WMA MP3 JPEG

Press the numbered buttons to select a group or a title.

e.g. DVD-V

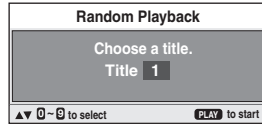

DVD-A

- To enter all groups, press [◀, ▶] to select "All" and press [ENTER].
- To deselect a group, press numbered buttons corresponding to the group you want to clear.

2 Press [▶] (play).

## Random 1 play

### ■ When CD Mode is on (→ page 14)

VCD CD WMA MP3

You can play all the items on all the discs in random order.

Press [▶] (play).

e.g. CD



## Random 2 play

### ■ When CD Mode is on (→ page 14)

VCD CD WMA MP3

You can play all the discs in sequence, but all the items on each disc are played in random order.

Press [▶] (play).

e.g. CD



Manufactured under license from Dolby Laboratories.

"Dolby", "Pro Logic" and the double-D symbol are trademarks of Dolby Laboratories.

"DTS" and "DTS Digital Surround" are registered trademarks of Digital Theater Systems, Inc.

This product incorporates copyright protection technology that is protected by method claims of certain U.S. patents and other intellectual property rights owned by Macrovision Corporation and other rights owners. Use of this copyright protection technology must be authorized by Macrovision Corporation, and is intended for home and other limited viewing uses only unless otherwise authorized by Macrovision Corporation. Reverse engineering or disassembly is prohibited.

MPEG Layer-3 audio decoding technology licensed from Fraunhofer IIS and Thomson multimedia.

Windows Media, and the Windows logo are trademarks, or registered trademarks of Microsoft Corporation in the United States and/or other countries.



WMA is a compression format developed by Microsoft Corporation. It achieves the same sound quality as MP3 with a file size that is smaller than that of MP3.



HighMAT™ and the HighMAT logo are either trademarks or registered trademarks of Microsoft Corporation in the United States and/or other countries.

HDCD®, HDCD®, High Definition Compatible Digital® and Pacific Microsonics™ are either registered trademarks or trademarks of Pacific Microsonics, Inc. in the United States and/or other countries.

HDCD system manufactured under license from Pacific Microsonics, Inc. This product is covered by one or more of the following: In the USA: 5,479,168, 5,638,074, 5,640,161, 5,808,574, 5,838,274, 5,854,600, 5,864,311, 5,872,531, and in Australia: 669114, with other patents pending.

# Using navigation menus

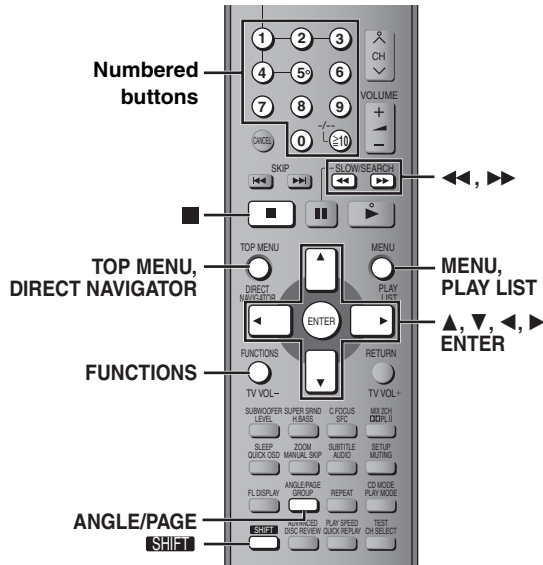

## Playing data discs

**WMA MP3 JPEG**  
 You can play JPEG files on DVD-RAM or play HighMAT discs without using the HighMAT function (→ page 21, "Play as Data Disc" in Other Menu).  
 •Playing HighMAT™ discs (→ page 19)

## Playing items in order (Playback Menu)

**1 Press [TOP MENU].**  
 e.g.

•To exit the screen  
 Press [TOP MENU].

**2 Press [▲, ▼] to select "All", "Audio" or "Picture" and press [ENTER].**

## Playing from the selected item (Navigation Menu)

**1 Press [MENU].**  
**2 Press [▲, ▼, ◀, ▶] to select the group and press [ENTER].**  
**3 To play content in the group in order Press [ENTER].**  
 To start play from the selected content  
 Press [▲, ▼] to select and [ENTER].

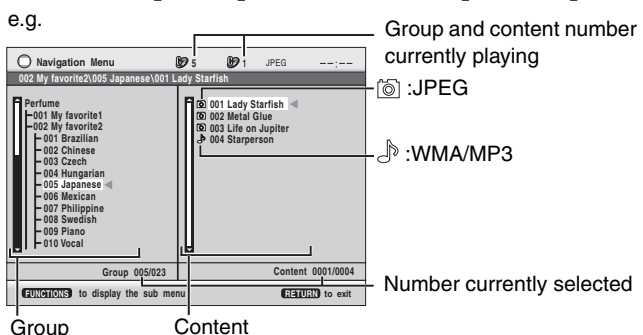

- Press [SHIFT]+[ANGLE/PAGE] to skip page by page in the group or content field.
- To enjoy listening to WMA/MP3 contents while showing a JPEG image on the screen  
 Select a JPEG file first, and then select audio contents. (The opposite order is not effective.)
- To exit the screen  
 Press [MENU].

## Using the submenu

- While the menu is displayed  
 Press [FUNCTIONS].
- Press [▲, ▼] to select an item and press [ENTER].  
 Items shown differ depending on the type of disc.

Multi	Groups and contents are displayed.
List	Contents only
Tree	Groups only
Thumbnail	Thumbnail images <b>JPEG</b>
Next group	To go to next group <b>WMA MP3</b>
Previous group	To go to previous group <b>WMA MP3</b>
All	WMA/MP3 and JPEG
Audio	WMA/MP3 only
Picture	JPEG only
Help display	To switch between guide messages and the elapsed play time indicator
Find	To search by content or group title (→ below)

## Searching by a content or group title

Highlight a group title to search the group, or a content title to search its content.

- While the submenu is displayed (→ above)  
 Press [▲, ▼] to select "Find" and press [ENTER].
- Press [▲, ▼] to select a character and press [ENTER].
  - Repeat to enter another character.
  - Lower case is also searched.
  - Press [◀, ▶] to skip between A, E, I, O and U.
  - Press [◀] to erase a character.
  - Leave the asterisk (\*) when you search for the titles including the character you enter.
  - Erase the asterisk (\*) to search for the titles starting with the character you enter. To add the asterisk (\*) again, display the submenu again and select "Find".
- Press [▶] to select "Find" and press [ENTER].  
 The search result screen appears.
- Press [▲, ▼] to select the content or group and press [ENTER].

## Playing from the selected track in the CD

**CD**  
 Titles appear with CD Text disc playback.

- Press [TOP MENU] or [MENU].  
 e.g. CD text
- Press [▲, ▼] to select the track and press [ENTER].
  - Press [SHIFT]+[ANGLE/PAGE] to skip page by page.
  - Press [FUNCTIONS] to show the playback condition and current position.

**To exit the screen**  
 Press [TOP MENU] or [MENU].

## Playing HighMAT™ discs

WMA MP3 JPEG

1 Press [TOP MENU].

2 Press [▲, ▼, ◀, ▶] to select the item, then press [ENTER].

- Repeat this step if necessary.

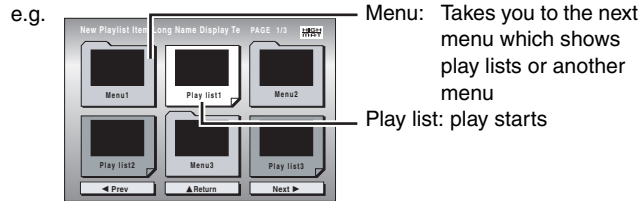

• To change the menu background

Press [FUNCTIONS].  
The background changes to the one recorded on the disc.

• To exit the screen  
Press [■].

## Selecting from the list

1 During play  
Press [MENU].

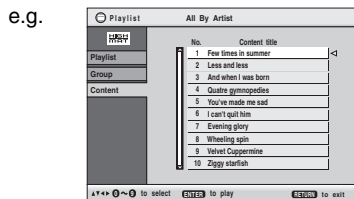

2 Press [◀] then [▲, ▼] to switch among “Playlist”, “Group” and “Content” lists.

3 Press [▶] then [▲, ▼] to select an item and press [ENTER].

- Press [SHIFT]+[ANGLE/PAGE] to skip page by page.

• To exit the screen  
Press [MENU].

## Tips for making WMA/MP3 and JPEG discs (For CD-R, CD-RW)

- Discs must conform to ISO9660 level 1 or 2 (except for extended formats).
- This unit supports multi-session but if there are a lot of sessions it takes more time for play to start. Keep the number of sessions to a minimum to avoid this.
- When there are more than 8 groups, the eighth group onwards will be displayed on one vertical line in the menu screen.
- There may be differences in the display order on the menu screen and computer screen.
- This unit cannot play files recorded using packet write.

## Naming folders and files

(Files are treated as content and folders are treated as groups on this unit.)

At the time of recording, prefix folder and file names with 3-digit numbers in the order you want to play them (this may not work at times).

Files must have the extension:

“.WMA” or “.wma”

“.MP3” or “.mp3”

“.JPG”, “.jpg”, “.JPEG” or “.jpeg”

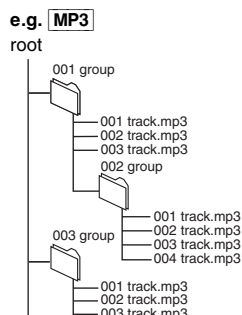

## Playing RAM discs

DIRECT NAVIGATOR PLAY LIST

RAM

- Titles appear only if the titles are recorded on the disc.
- You cannot edit programs, play lists and disc titles.

## Playing the programs

1 Press [DIRECT NAVIGATOR].

e.g.

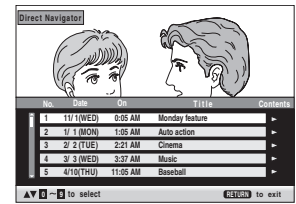

• To exit the screen

Press [DIRECT NAVIGATOR].

2 Press [▲, ▼] or the numbered buttons to select the program.

- Press [SHIFT]+[ANGLE/PAGE] to skip page by page.

• To select a 2-digit number

e.g. 23: [≥10] → [2] → [3]

- Press [▶] to show the contents of the program and the disc.

3 Press [ENTER].

## Playing a play list

(Only when the disc contains a play list)

1 Press [PLAY LIST].

e.g.



• To exit the screen

Press [PLAY LIST].

2 Press [▲, ▼] or the numbered buttons to select the play list.

- Press [SHIFT]+[ANGLE/PAGE] to skip page by page.

• To select a 2-digit number

e.g. 23: [≥10] → [2] → [3]

3 Press [ENTER].

## WMA

- You cannot play WMA files that are copy protected.
- This unit does not support Multiple Bit Rate (MBR).

## MP3

- This unit does not support ID3 tags.
- Compatible sampling rates: 8, 11.02, 12, 16, 22.05, 24, 32, 44.1 and 48 kHz.

## JPEG

- To view JPEG files on this unit:
  - Take them on a digital camera that meets the DCF Standard (Design rule for Camera File system) Version 1.0. Some digital cameras have functions that are not supported by the DCF Standard Version 1.0 like automatic picture rotation which may render a picture unviewable.
  - Do not alter the files in any way or save them under a different name.
- This unit cannot display moving pictures, MOTION JPEG and other such formats, still pictures other than JPEG (e.g. TIFF) or play pictures with attached audio.

# Using on-screen menus

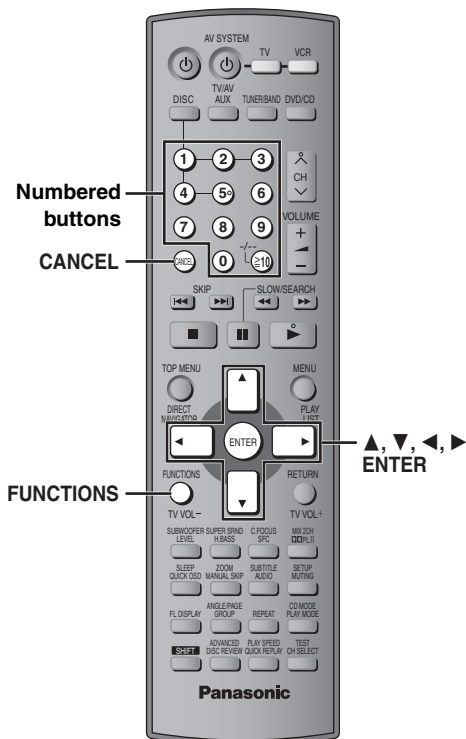

Items shown differ depending on the type of disc.

## Main menu

<b>Program Group</b>	To start from a specific item
<b>Title</b>	
<b>Chapter</b>	
<b>Track</b>	
<b>Playlist</b>	
<b>Content</b>	
<b>Time</b>	To skip incrementally or decrementally* (Time Slip for play only) 1 Press [ENTER] twice to show the Time Slip indicator. 2 Press [▲, ▼] to select the time and press [ENTER]. ● Press and hold [▲, ▼] to alter faster. To start from a specific time* (Time Search) To change remaining/elapsed time display
<b>Audio</b>	(→ page 15, Changing soundtracks) [WMA] [MP3] To display the current disc type
<b>Still Picture</b>	To switch still pictures
<b>Thumbnail</b>	To show thumbnail images
<b>Subtitle</b>	(→ page 15, Changing subtitles)
<b>Marker (VR)</b>	[RAM] To recall a marker recorded on DVD-Video recorders To recall a marker: Press [▲, ▼] → Press [ENTER]
<b>Angle</b>	(with multiple angles) To select the angle
<b>Rotate Picture</b>	To rotate picture
<b>Slideshow</b>	To turn on/off slideshow To change the slideshow timing (0–30 sec)
<b>Other Settings</b>	(→ page 21)

<b>1</b>	<b>FUNCTIONS</b> 	<b>Press once.</b>
<b>2</b>	Select  Go to the next menu [ENTER] Register  Return to the previous menu	<b>Select the menu.</b>
<b>3</b>	Select  [ENTER] Register   1 2 3 4 5 6 7 8 9 0 [E10]	<b>Make the settings.</b>
<b>4</b>	<b>FUNCTIONS</b> 	<b>Press to exit.</b>





# Changing the player settings

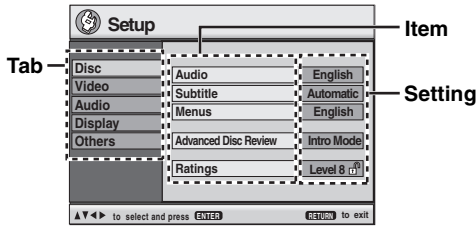
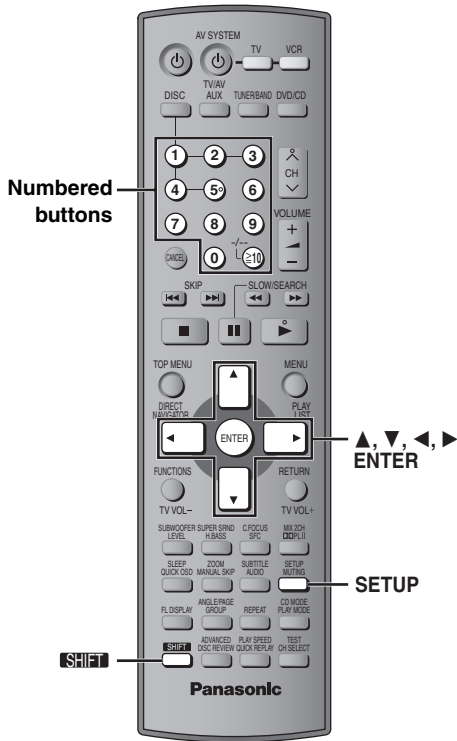

- The settings remain intact even if you switch the unit to standby.
- Underlined items are the factory preset in the following diagram.

<b>1</b>		<b>Show the Setup menu.</b> If you have not set QUICK SETUP (→ page 9), the QUICK SETUP screen appears.
<b>2</b>	Select 	<b>Select the tab.</b>
<b>3</b>	Select 	<b>Select the item.</b>
<b>4</b>	Select 	<b>Make the settings.</b>
<b>5</b>		<b>Press to exit.</b>

**QUICK SETUP enables successive settings of the items in the shaded area.**

## ■ “Disc” tab

<b>Audio</b> Choose the audio language.	• <u>English</u> • (Language options)*1    • Original*2    • Other*****#3
<b>Subtitle</b> Choose the subtitle language.	• <u>Automatic</u> *4    • English    • (Language options)*1    • Other*****#3
<b>Menus</b> Choose the language for disc menus. Changing the menu language in QUICK SETUP also changes this setting.	• <u>English</u> • (Language options)*1    • Other*****#3
<b>Advanced Disc Review</b> (→ page 14)	• <u>Intro Mode</u> : Reviews each title/program. • Interval Mode: Reviews not only each title/program but also each 10 minute interval within a title/program.
<b>Ratings</b> Set a ratings level to limit DVD-Video play.	Setting ratings (When level 8 is selected) • <u>8 No Limit</u> • 1 to 7    • 0 Lock All: To prevent play of discs without ratings levels. When you select your ratings level, a password screen is shown. Follow the on-screen instructions. <b>Do not forget your password.</b> A message screen will be shown if a DVD-Video exceeding the ratings level is inserted in the unit. Enter your password and then follow the on-screen instructions.

\*1 Language options

**Southeast Asia and Thailand:** Chinese

**The Middle East, South Africa, Saudi Arabia and Kuwait:**

French, German, Italian, Spanish, Portuguese, Russian and Dutch

\*2 The original language designated on the disc is selected.

\*3 Input a code number referring to the table on page 34.

\*4 If the language selected for “Audio” is not available, subtitles appear in that language (if available on the disc).

## ■ “Video” tab

<b>TV Aspect</b> Choose the setting to suit your television and preference.	• <b>4:3 Pan&amp;Scan:</b> Regular aspect television (4:3) The sides of the widescreen picture are cut off so it fills the screen (unless prohibited by the disc).	
	• <b>4:3 Letterbox:</b> Regular aspect television (4:3) Widescreen picture is shown in the letterbox style.	
	• <b>16:9:</b> Widescreen television (16:9)	

<b>TV Type</b> Select to suit the type of television.	<ul style="list-style-type: none"> <li>Standard (Direct View TV)</li> <li>Projection TV</li> </ul>	<ul style="list-style-type: none"> <li>CRT Projector</li> <li>Plasma TV</li> </ul>	<ul style="list-style-type: none"> <li>LCD TV/Projector</li> </ul>
<b>Time Delay</b> When connected with a Plasma display, adjust if you notice the audio is out of sync with the video.	<ul style="list-style-type: none"> <li>0ms</li> <li>20ms</li> <li>40ms</li> <li>60ms</li> <li>80ms</li> <li>100ms</li> </ul>		
<b>Still Mode</b> Specify the type of picture shown when paused.	<ul style="list-style-type: none"> <li>Automatic</li> <li>Field: The picture is not blurred, but picture quality is lower.</li> <li>Frame: Overall quality is high, but the picture may appear blurred.</li> </ul>		
<b>NTSC Disc Output</b> Choose PAL 60 or NTSC output when playing NTSC discs (→ page 11, Video systems)	<ul style="list-style-type: none"> <li>PAL60: When connected to a PAL television.</li> <li>NTSC: When connected to an NTSC television. (The Middle East, South Africa, Saudi Arabia and Kuwait: "PAL60" is the factory preset.)</li> </ul>		

■ **"Audio" tab**

<b>Dynamic Range Compression</b>	<ul style="list-style-type: none"> <li>Off</li> <li>On: Adjusts for clarity even when the volume is low by compressing the range of the lowest sound level and the highest sound level. Convenient for late night viewing. (Only works with Dolby Digital)</li> </ul>
<b>Speaker Settings (→ below)</b> Set the delay time for your center and surround speakers.	<ul style="list-style-type: none"> <li>Center: 0.0/1.0/2.0/3.0/4.0/5.0 ms</li> <li>Surround (L/R): 0.0/5.0/10.0/15.0 ms</li> </ul>

■ **"Display" tab**

<b>Menu Language</b>	<ul style="list-style-type: none"> <li>*5 English • 中文</li> <li>*6 English • Français • Deutsch • Italiano • Español • Português • Русский • Nederlands</li> </ul>
<b>On-Screen Messages</b>	<ul style="list-style-type: none"> <li>On</li> <li>Off</li> </ul>

\*5 Southeast Asia and Thailand

\*6 The Middle East, South Africa, Saudi Arabia and Kuwait

■ **"Others" tab**

<b>FL Dimmer</b> Changes the brightness of the unit's display and Jog LED.	<ul style="list-style-type: none"> <li>Bright</li> <li>Dim (Jog LED turns off.)</li> <li>Auto: The display is dimmed, but brightens when you perform some operations. Jog LED turns on when you perform some operations.</li> </ul>
<b>QUICK SETUP</b>	<ul style="list-style-type: none"> <li>Yes</li> <li>No</li> </ul>
<b>Re-initialize Setting (or Re-initialise Setting)</b> This returns all values in the Setup menus to the default settings.	<ul style="list-style-type: none"> <li>Yes: The password screen is shown if "Ratings" (→ page 22) is set. Please enter the same password. After "INIT" on the display disappears, turn the unit off and on again.</li> <li>No</li> </ul>

## Changing the delay time (Speaker Settings)

(Effective when playing multi-channel audio)

(Center and surround speakers only)

For optimum listening with 5.1-channel sound, all the speakers, except for the subwoofer, should be the same distance from the seating position. If you have to place the center or surround speakers closer to the seating position, adjust the delay time to make up for the difference.

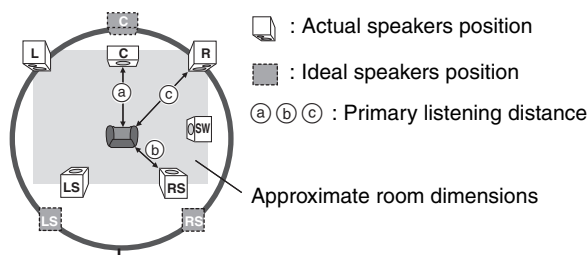

Circle of constant primary listening distance

If either distance (a) or (b) is less than (c), find the difference in the table and change to the recommended setting.

a) Center speaker		b) Surround speaker	
Difference (Approx.)	Setting	Difference (Approx.)	Setting
30 cm	1.0 ms	150 cm	5.0 ms
60 cm	2.0 ms	300 cm	10.0 ms
90 cm	3.0 ms	450 cm	15.0 ms
120 cm	4.0 ms		
150 cm	5.0 ms		

- 1 Press [▲, ▼] to select the delay time box and press [ENTER].
- 2 Press [▲, ▼] to adjust the delay time and press [ENTER].

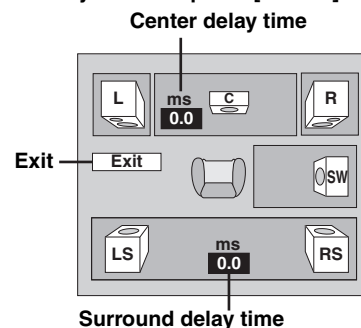

**To finish the speaker setting**

Press [◀] to select "Exit" and press [ENTER].

When you change the surround speaker setting for Dolby Digital, the setting also changes for Dolby Pro Logic II.

e.g., the settings for MUSIC are the same as those for Dolby Digital.

Dolby Digital	Dolby Pro Logic II	
	MUSIC	MOVIE
0 ms	0 ms	10 ms
5 ms	5 ms	15 ms
10 ms	10 ms	20 ms
15 ms	15 ms	25 ms

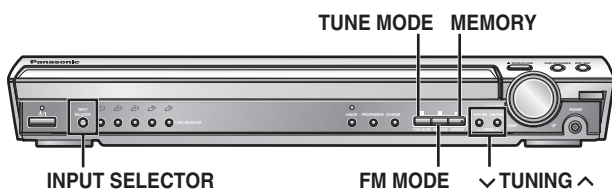
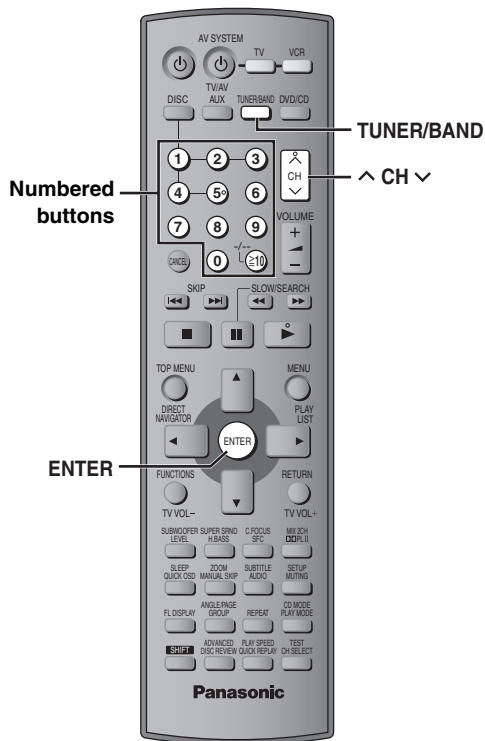

## Selecting the preset channels

- 1 Press [TUNER/BAND] to select “FM” or “AM”.
- 2 Press the numbered buttons to select the channel.  
Alternatively, press [ ^ CH v ].  
To select a 2-digit number  
e.g. 12: [ ≥ 10 ] → [ 1 ] → [ 2 ]



When a stereo FM broadcast is being received.



### ■ If noise is excessive in FM

*Main unit only*

Press [FM MODE] to display “MONO”.



Press [FM MODE] again to cancel the mode.  
The mode is also canceled when you change the frequency.

## Automatic presetting

*Main unit only*

Up to 15 stations can be set in each band, FM and AM.

- 1 Press [INPUT SELECTOR] to select “FM” or “AM”.
- 2 Press [TUNE MODE] to select “MANUAL”.  
Each time you press the button: MANUAL ↔ PRESET
- 3 Press [ v TUNING ^ ] to tune to the lowest frequency (FM: 87.50, AM: 522 or 520).
- 4 Press and hold [MEMORY].

Release the button when “FM AUTO” or “AM AUTO” is displayed.

The tuner presets all the stations it can receive into the channels in ascending order.

- “SET OK” is displayed when the stations are set, and the radio tunes to the last preset station.
- “ERROR” is displayed when automatic presetting is unsuccessful. Preset the channels manually (→ right).

## Manual tuning

*Main unit only*

- 1 Press [INPUT SELECTOR] to select “FM” or “AM”.
- 2 Press [TUNE MODE] to select “MANUAL”.
- 3 Press [ v TUNING ^ ] to select the frequency.  
Press and hold [ v TUNING ^ ] until the frequency starts scrolling to start automatic tuning. Tuning stops when a station is found.

### ■ Presetting the channel

Up to 15 stations can be set in each band, FM and AM.

- 1 While listening to the radio broadcast  
Press [ENTER].
- 2 While the frequency and “PGM” are flashing on the display  
Press the numbered buttons to select a channel.  
Alternatively, press [ ^ CH v ], then press [ENTER].  
• To select a 2-digit number  
e.g. 12: [ ≥ 10 ] → [ 1 ] → [ 2 ].



The station occupying a channel is erased if another station is preset to that channel.

## ■ AM frequency step

### Main unit only

The step is factory-set to 9 kHz, but you can change it to receive broadcasts allocated in 10-kHz steps.

- 1 Press [INPUT SELECTOR] to select "FM".
- 2 Press and hold [INPUT SELECTOR].  
After a few seconds the display changes to show the current minimum frequency. Continue to hold the button down. The minimum frequency changes and the step is changed.  
To return to the original step, repeat the above steps.

### Note

After changing the setting, previously preset frequency will be cleared. Preset it again.

## Optional antenna connections

Use outdoor antennas if radio reception is poor.

- Disconnect the antenna when the unit is not in use.
- Do not use the outdoor antenna during an electrical storm.

### FM outdoor antenna (Using a television antenna)

- Disconnect the FM indoor antenna.
- The antenna should be installed by a competent technician.

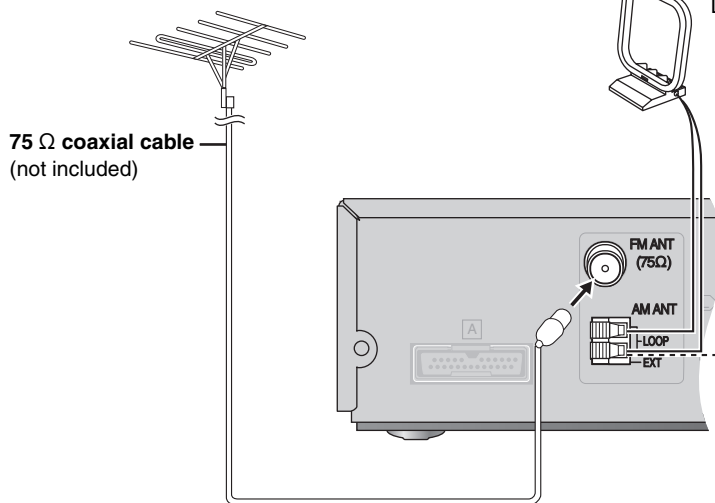

Leave the AM loop antenna connected.

### AM outdoor antenna (Using a vinyl wire)

Run a piece of vinyl wire horizontally across a window or other convenient location.

5–12 m

# Sound field and sound quality

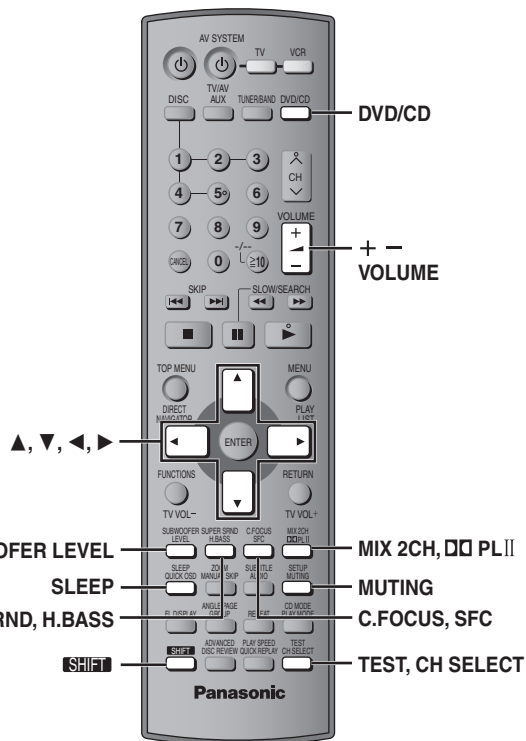

## Note

- When connected with headphones, the following sound field systems have no effect. (Excluding Sound Field Control)
- You may experience a reduction in sound quality when these sound field systems are used with some sources. If this occurs, turn the sound field system off.
- If you turn on Super Surround, Dolby Pro Logic II is canceled and vice versa.

## C.FOCUS SFC Sound Field Control

Changes the sound quality.

### Press [SFC].

Each time you press the button:

- FLAT:** Cancel (no effect is added) (factory preset).
- HEAVY:** Adds punch to rock.
- CLEAR:** Clarifies higher sounds.
- SOFT:** For background music.
- DISCO:** Reverberates sound to make you feel like you are in a disco.
- LIVE:** Makes vocals more alive.
- HALL:** Expands sound to make you feel like you are in a hall.

### To check the current setting

Press [SFC].

## SHIFT SUPER SRND H.BASS Super Surround

Adds surround effects to stereo sound.

### Press [SHIFT]+[SUPER SRND].

Each time you press the button:

- MUSIC:** Adds surround effects to stereo sources.
- MOVIE:** Use this mode when playing movie software.
- PARTY:** Sound is in stereo regardless of the direction you are facing.
- OFF:** Cancel

- You can adjust the volume of the surround speakers to get the best surround effect (→ page 27, Speaker level adjustments).
- Super Surround does not work when playing a DVD recorded with a multi-channel source.

## SHIFT + C.FOCUS SFC Center Focus

(Discs where the dialogue is recorded in the center channel)

You can make the sound of the center speaker seem like it is coming from within the television.

### Press [SHIFT]+[C.FOCUS].

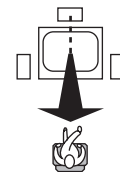

Each time you press the button:  
C FOCUS ON ↔ C FOCUS OFF

- This does not work when Super Surround is turned on.
- This also works when Dolby Pro Logic II is turned on.

## MIX 2CH DD PLII Dolby Pro Logic II

Dolby Pro Logic II is an advanced decoder that derives 5-channel surround (Left and Right Front, Center, Left and Right Surround) from any stereo program material, whether or not it has been specifically Dolby Surround encoded.

### Press [DDPLII].

Each time you press the button:

- MOVIE:** Movie software, recorded in Dolby Surround.
- MUSIC:** Stereo sources
- OFF:** Cancel



- This works only in DVD/CD mode.
- "DDPLII" lights when there is effect.

## SHIFT + MIX 2CH DD PLII Down-mixing

You can output the down-mixed 2 channel signals when necessary.

### Press [SHIFT]+[MIX 2CH].



Each time you press the button:  
MIX 2CH ON ↔ MIX 2CH OFF

- When "D.MIX" flashes on the display, the disc contains multiple-channel signals that cannot be down-mixed. **DVD-A**

## SUPER SRND H.BASS Enhancing the bass sound

You can enhance low-frequency sound so that heavy bass sound can be heard clearly, even if the acoustics of your room are not optimal. The unit automatically selects the most suitable setting according to the type of playing source.

### Press [H.BASS].

H.BASS indicator lights on the main unit.

- When DVD-Video or DVD-RAM is selected  
H.BASS ON (factory preset) ↔ H.BASS OFF
- When another source is selected  
H.BASS OFF (factory preset) ↔ H.BASS ON



The setting you make is retained, and recalled every time you play the same type of source.



## SUBWOOFER LEVEL Subwoofer level

You can adjust the amount of bass. The unit automatically selects the most suitable setting according to the type of playing source.

Press [SUBWOOFER LEVEL].

●When DVD-Video or DVD-RAM is selected

SUB W 4 (factory preset) → SUB W 1 → SUB W 2 → SUB W 3

●When another source is selected

SUB W 2 (factory preset) → SUB W 3 → SUB W 4 → SUB W 1



The setting you make is retained, and recalled every time you play the same type of source.

## SHIFT + TEST CH SELECT Speaker level adjustments

This is one of the ways to get appropriate surround effects.

**Preparation**

Press [DVD/CD].

- 1** While stopped and no on-screen display is shown  
Press [SHIFT]+[TEST] to output a test signal.  
L: Front left                      C: Center                      R: Front right  
RS: Right surround      LS: Left surround  
●There is no output from SW (subwoofer) channel.
- 2** Press [VOLUME, +] or [-] to set the volume level normally used for listening.
- 3** Press [▲] (increase) or [▼] (decrease) to adjust the speaker level for each speaker.  
C, RS, LS: -6 dB to +6 dB  
(L, R: Only the balance is adjustable.)  
●To adjust the balance of the front speakers  
While outputting the test signal, press [◀, ▶].  
●Adjust the speaker level to the same level as the front speakers.

**To stop the test signal**  
Press [SHIFT]+[TEST] again.

■ **To adjust speaker level during play**  
(Effective when playing multi-channel audio or when Dolby Pro Logic II or Super Surround is on.)

- 1** Press [CH SELECT] to select the speaker.  
L → C → R → RS → LS → SW  
↑  
SW: Subwoofer  
●You can adjust SW only if the disc includes a subwoofer channel.  
●“SW” does not appear on the display and is not adjustable when Dolby Pro Logic II is turned on.  
●“S” appears on the display when “MUSIC” or “MOVIE” is selected with Super Surround (→ page 26). In this case, you can adjust both surround speaker levels at the same time using [▲, ▼].  
S: -6 dB to +6 dB
- 2** Press [▲] (increase) or [▼] (decrease) to adjust the speaker level for each speaker.  
C, RS, LS, SW: -6 dB to +6 dB  
(L, R: Only the balance is adjustable.)  
●To adjust the balance of the front speakers  
While “L” or “R” is selected, press [◀, ▶].

## SHIFT + SLEEP QUICK OSD Sleep timer

Press [SHIFT]+[SLEEP] to select the time (in minutes).

SLEEP 30 → SLEEP 60 → SLEEP 90  
↑                      OFF                      SLEEP 120 ←

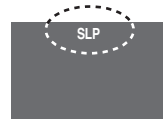

**To cancel the timer**  
Press [SHIFT]+[SLEEP] to select “OFF”.

**To confirm the remaining time**  
Press [SHIFT]+[SLEEP] again.

**To change the setting**  
Repeat the procedure from the beginning.

## SETUP MUTING Muting

Press [MUTING].

“MUTING” flashes on the unit’s display.



- To cancel**
- Press [MUTING] again or reduce the volume to minimum (— dB), then raise it to the required level.
  - Muting is canceled when you switch the unit to standby.

## Using headphones

Main unit only

- 1** Reduce the volume and connect the headphones (not included).  
Headphone plug type: 3.5 mm stereo

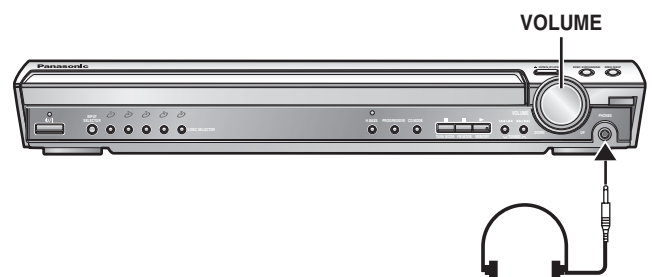

- 2** Adjust headphone volume with [VOLUME].  
●Audio is automatically switched to stereo (2-channel).

**Note**  
Avoid listening for prolonged periods of time to prevent hearing damage.

# Operating other equipment

## ■ Connection example

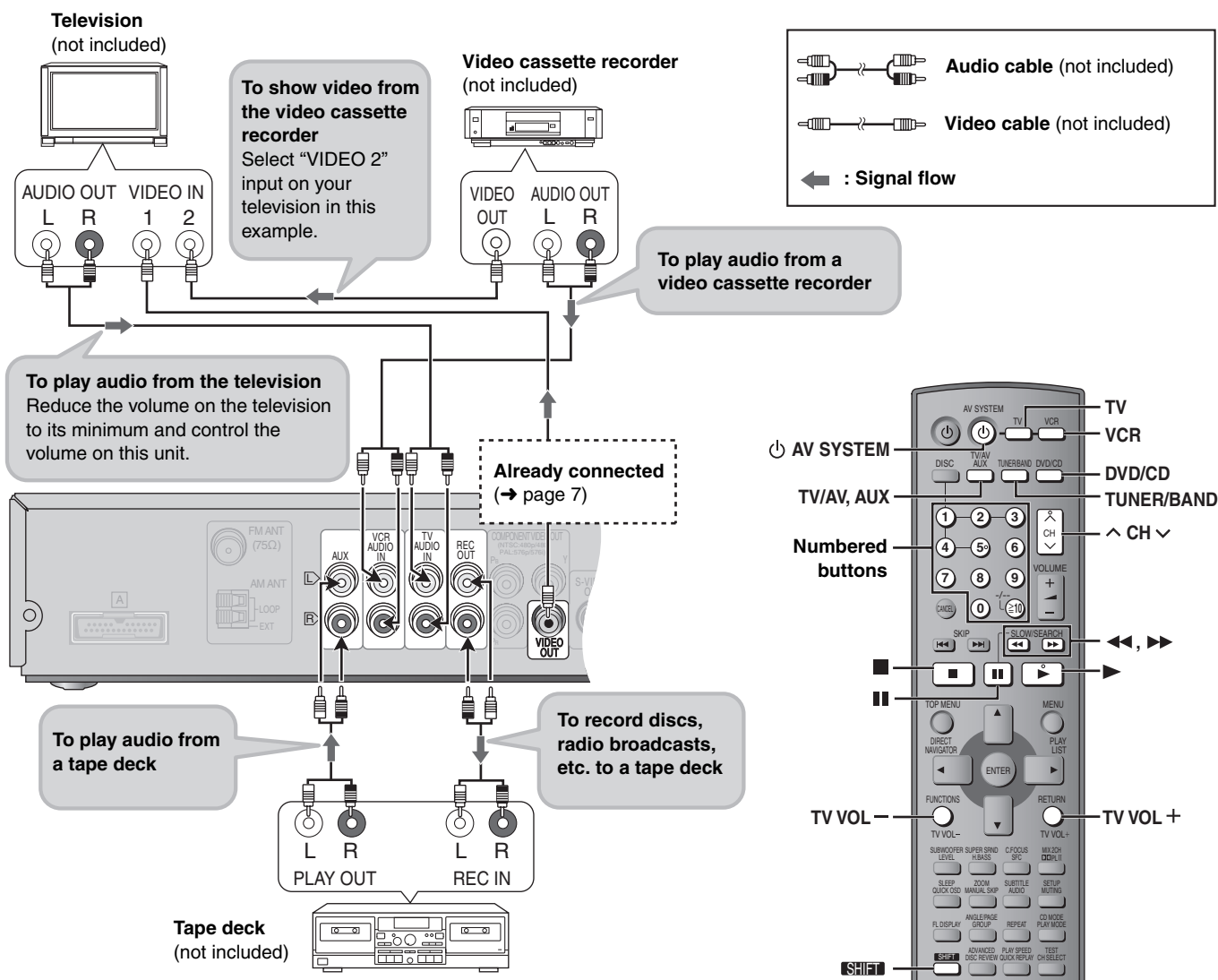

Operating other equipment

## Operating the television and the video cassette recorder

You can use the remote control to operate a Panasonic television or a video cassette recorder. Connect your equipment referring to "Connection example" (→ above).

### Note

The remote control may not work properly with some models.

### Television

#### Preparation

Aim the remote control at the unit and press [TV] to light up the button, and then aim it at the television for the following operations:

#### Turning the television on/off

Press [⏻ AV SYSTEM].

#### Switching the television's video input mode

Press [SHIFT]+[TV/AV].

#### Changing channels

Press [^ CH v].

#### Adjusting the volume

Press [TV VOL-] or [TV VOL+].

### Video cassette recorder

#### Preparation

- Change the video input mode on the television ("VIDEO 2" in the example).

- Aim the remote control at the unit and press [VCR] to light up the button, and then aim it at the video cassette recorder for the following operations:

#### Turning the video cassette recorder on/off

Press [⏻ AV SYSTEM].

#### Play, pause and stop

Press [▶] (play), [⏸] or [■].

#### Fast forward and rewind

Press [◀◀] or [▶▶].

#### Connecting a laser disc or record player

Connect instead of a video cassette recorder (→ above) and select "VCR" as the source.

We recommend using a record player with a built-in phono equalizer. If your player doesn't have a built-in equalizer, connect it first to a separate equalizer and then to the unit.

## Changing the remote control code

This remote control can also operate some other brands of televisions and video cassette recorders. Change the code to operate such equipment (→ right).

**Aim the remote control at the equipment.**

**While pressing [TV] or [VCR]**

**Press a numbered button to enter the first digit, and then the second digit.**

The remote control outputs the on/off signal. If the code is correct, the equipment turns on or off. If it doesn't, try entering another code.

### Note

Reenter the codes after you change the batteries.

## Operating the tape deck

### Recording to the tape deck

- 1** Press [DVD/CD] to select "DVD/CD".  
or  
Press [TUNER/BAND] to select "FM" or "AM".
- 2** Start recording and play.

### Listening to the tape deck

Press [AUX] to select "AUX" as the source.

## Television code list

PANASONIC:	01, 29, 30, 31	MITSUBISHI:	14, 19, 28, 36
AKAI:	07, 11, 28, 36, 37	NOKIA:	05, 07, 37
ALBA:	05, 11, 12	NORDMENDE:	26, 41
BAUR:	32	OCEANIC:	27, 35
BLAUPUNKT:	28, 36	ORION:	02, 03, 05, 10, 11, 12, 38
BRANDT:	26, 41	PHILIPS:	11, 12, 13, 15
BUSH:	02, 05, 10, 11, 12, 32, 38	PHONOLA	11, 12
DAEWOO:	11, 12, 32	RADIOLA:	11, 12
DUAL:	32	ROADSTAR:	39
FERGUSON:	11, 12	SABA:	26, 41
FINLUX:	11, 12, 22, 23, 24, 25, 40	SALORA:	07, 37
FISHER:	37	SAMSUNG:	11, 12, 15, 21, 25, 34, 39
FUNAI:	02, 38	SANYO:	07, 17, 25, 37
GOLDSTAR:	11, 12	SCHNEIDER:	11, 12
GOODMANS:	11, 12, 25, 32	SEG:	39, 40
GRUNDIG:	28, 36	SELECO:	11, 24
HITACHI:	01, 09, 26, 41	SHARP:	17, 20
ICE:	21, 39	SIEMENS:	11, 12, 17, 28, 36
INNO HIT:	34	SINUDYNE:	02, 05, 11, 12, 22, 24, 38, 40
ITT/NOKIA:	05, 07, 37	SONY:	16
JVC:	18	THOMSON:	05, 26, 41
KENDO:	40	THORN:	06, 08, 11, 12, 14, 16, 25, 32
LOEWE:	14, 33	TOSHIBA:	03, 04, 06, 08
LOEWE OPTA:	32	UNIVERSUM:	39
LUXOR:	37	WHITE WESTING HOUSE:	11, 12, 22, 40
MATSUI:	02, 05, 06, 07, 10, 11, 12, 25, 37, 38		

## Video cassette recorder code list

PANASONIC:	01, 29, 30	NEC:	04, 21, 36, 37
AKAI:	06, 08, 16, 17, 19, 37	NOKIA:	08, 10, 11, 18, 22, 27, 37
ALBA:	02, 06, 23	NORDMENDE:	20, 21
BAIRD:	08, 10, 37	OKANO:	06
BLAUPUNKT:	01, 26, 29, 30, 33	ORION:	05, 09
BUSH:	02, 09, 23	PHILIPS:	22, 32, 33, 34, 35
DAEWOO:	15	PHONOLA:	32
FERGUSON:	31	RFT:	33
FISHER:	05, 07, 10, 11, 12	ROADSTAR:	02, 03, 18, 23, 27
GOLDSTAR/LG:	03, 04, 36, 37	SABA:	21
GOODMANS:	02, 03, 18, 23, 27, 33	SALORA:	08, 11, 17, 19, 37
GRUNDIG:	02, 23, 26, 28, 32, 33	SAMSUNG:	15, 16, 18, 27
HCM:	02, 23	SANYO:	07, 10, 11
HITACHI:	13, 14	SCHAUB LORENZ:	10
ITT:	08, 10, 11, 37	SCHNEIDER:	02, 03, 18, 23, 27, 32
ITT/NOKIA:	18, 27, 37	SEG:	02, 18, 23, 27
JVC:	20, 21	SHARP:	22
KENDO:	08, 09, 37	SIEMENS:	03, 10, 11, 32
LOEWE:	03, 32	SONY:	24, 25, 26
LUXOR:	08, 10, 11, 17, 19, 37	THOMSON:	21
MATSUI:	03, 05, 09	THORN:	10
METZ:	01	TOSHIBA:	15, 17, 19, 32
MITSUBISHI:	17, 19, 21, 32	UNIVERSUM:	03, 08, 32, 37

## AMPLIFIER SECTION

### RMS Output Power: Dolby Digital Mode

Front Ch	170 W per channel (6 Ω), 1 kHz, 10 % THD
Surround Ch	70 W per channel (4 Ω), 1 kHz, 10 % THD
Center Ch	260 W per channel (4 Ω), 1 kHz, 10 % THD
Subwoofer Ch	260 W per channel (4 Ω), 100 Hz, 10 % THD
Total RMS Dolby Digital mode power	1000 W

### PMPO output power:

7300 W

### DIN Output Power: Dolby Digital Mode

Front Ch	145 W per channel (6 Ω), 1 kHz, 1 % THD
Surround Ch	45 W per channel (4 Ω), 1 kHz, 1 % THD
Center Ch	150 W per channel (4 Ω), 1 kHz, 1 % THD
Subwoofer Ch	150 W per channel (4 Ω), 100 Hz, 1 % THD
Total DIN Dolby Digital mode power	680 W

## FM/AM TUNER, TERMINALS SECTION

### Preset station

FM 15 stations  
AM/MW 15 stations

### Frequency Modulation (FM)

Frequency range	87.50–108.00 MHz (50-kHz step)
Sensitivity	2.5 μV (IHF)
S/N 26 dB	2.2 μV
Antenna terminals	75 Ω (unbalanced)

### Amplitude Modulation (AM/MW)

Frequency range	522–1629 kHz (9-kHz step) 520–1630 kHz (10-kHz step)
AM Sensitivity S/N 20 dB at 999 kHz	560 μV/m

### Phone jack

Terminal	Stereo, 3.5 mm jack
----------	---------------------

## DISC SECTION

### Discs played (8 cm or 12 cm)

- (1) DVD-RAM (DVD-VR compatible, JPEG formatted discs)
- (2) DVD-Audio
- (3) DVD-Video
- (4) DVD-R, DVD-RW (DVD-Video compatible)  
+ R, + RW (Video compatible)
- (5) CD-Audio (CD-DA)
- (6) Video CD
- (7) SVCD (Conforming to IEC62107)
- (8) CD-R/RW (CD-DA, Video-CD, SVCD, MP3, WMA, JPEG formatted disc)
- (9) MP3/WMA\*<sup>1</sup>
  - Compatible compression rate:  
MP3: between 32 kbps and 320 kbps  
WMA: between 48 kbps and 320 kbps
- (10) JPEG\*<sup>1</sup>
  - Exif Ver 2.1 JPEG Baseline files
  - Picture resolution: between 320×240 and 6144×4096 pixels (sub sampling is 4:2:2 or 4:2:0)
- (11) HighMAT Level 2 (Audio and Image)

\*<sup>1</sup> The total combined maximum number of recognizable audio and picture contents and groups: 4000 audio and picture contents and 400 groups.

### Pick up

Wavelength	CD 785 nm DVD 662 nm
Laser power	CLASS 2/CLASS 3A

### Audio output (Disc)

Number of channels	5.1ch (FL, FR, C, SL, SR, SW)
--------------------	-------------------------------

### Audio performance

- (1) Frequency response
  - DVD (linear audio) 4 Hz–22 kHz (48 kHz sampling)  
4 Hz–44 kHz (96 kHz sampling)
  - DVD-Audio 4 Hz–88 kHz (192 kHz sampling)
  - CD-Audio 4 Hz–20 kHz
- (2) S/N ratio
  - CD-Audio 95 dB
- (3) Dynamic range
  - DVD (linear audio) 95 dB
  - CD-Audio 93 dB
- (4) Total harmonic distortion
  - CD-Audio 0.005 %

## VIDEO SECTION

### Video system

Signal system	<b>Southeast Asia and Thailand</b> NTSC, PAL525/60, PAL625/50 <b>Others</b> PAL625/50, PAL525/60, NTSC
---------------	---

### Composite video output

Output level	1 Vp-p (75 Ω)
Terminal	Pin jack (1 system)

### S-video output

Y output level	1 Vp-p (75 Ω)
C output level	PAL; 0.3 Vp-p (75 Ω) NTSC; 0.286 Vp-p (75 Ω)
Terminal	S terminal (1 system)

### Component video output

<b>[NTSC: 525 (480) p/525 (480) i, PAL: 625 (576) p/625 (576) i]</b>	
Y output level	1 Vp-p (75 Ω)
P <sub>B</sub> output level	0.7 Vp-p (75 Ω)
P <sub>R</sub> output level	0.7 Vp-p (75 Ω)
Terminal	Pin jack (Y: green, P <sub>B</sub> : blue, P <sub>R</sub> : red) (1 system)

## SUBWOOFER SECTION

### Active subwoofer SB-WA930

<b>Type</b>	1 way, 2 speaker system (Bass reflex)
<b>Speaker unit(s)</b>	
1. Woofer	15 cm Cone type
2. Woofer	15 cm Cone type
<b>Output sound pressure</b>	84 dB/W (1.0 m)
<b>Frequency range</b>	34 Hz–220 Hz (–16 dB) 38 Hz–190 Hz (–10 dB)
<b>Dimensions (W×H×D)</b>	202 mm×410 mm×500 mm
<b>Mass</b>	13.7 kg

## SPEAKER SECTION

### Front speakers SB-FS930

<b>Type</b>	2 way, 3 speaker system (Bass reflex)
<b>Speaker unit(s)</b>	Impedance 6 Ω
1. Woofer	8 cm Cone type
2. Woofer	8 cm Cone type
3. Tweeter	6 cm Ring shaped dome type
<b>Input power (IEC)</b>	170 W*2 (Max)
<b>Output sound pressure</b>	84 dB/W (1.0 m)
Cross over frequency	7 kHz
<b>Frequency range</b>	75 Hz–50 kHz (–16 dB) 90 Hz–45 kHz (–10 dB)
<b>Dimensions (W×H×D)</b>	260 mm×1234 mm×270 mm
<b>Mass</b>	4.35 kg

### Surround speakers SB-FS880

<b>Type</b>	2 way, 2 speaker system (Bass reflex)
<b>Speaker unit(s)</b>	Impedance 4 Ω
1. Woofer	8 cm Cone type
2. Tweeter	6 cm Ring shaped dome type
<b>Input power (IEC)</b>	70 W (Max)
<b>Output sound pressure</b>	81 dB/W (1.0 m)
Cross over frequency	7 kHz
<b>Frequency range</b>	78 Hz–50 kHz (–16 dB) 90 Hz–45 kHz (–10 dB)
<b>Dimensions (W×H×D)</b>	260 mm×1234 mm×270 mm
<b>Mass</b>	3.92 kg

### Center speaker SB-PC930

<b>Type</b>	2 way, 3 speaker system (Bass reflex)
<b>Speaker unit(s)</b>	Impedance 4 Ω
1. Woofer	6.5 cm Cone type
2. Woofer	6.5 cm Cone type
3. Tweeter	6 cm Ring shaped dome type
<b>Input power (IEC)</b>	260 W*2 (Max)
<b>Output sound pressure</b>	82 dB/W (1.0 m)
Cross over frequency	5 kHz
<b>Frequency range</b>	110 Hz–50 kHz (–16 dB) 140 Hz–45 kHz (–10 dB)
<b>Dimensions (W×H×D)</b>	320 mm×88 mm×96 mm
<b>Mass</b>	1.36 kg

## GENERAL

<b>Power supply</b>	AC 110 V/127 V/220–230 V/240 V, 50/60 Hz
<b>Power consumption</b>	Main unit 25 W Subwoofer 390 W
<b>Dimensions (W×H×D)</b>	430 mm×68 mm×423 mm
<b>Mass</b>	Main unit 4 kg
<b>Operating temperature range</b>	+5 °C to +35 °C
<b>Operating humidity range</b>	5 % to 90 % RH (no condensation)

<b>Power consumption in standby mode</b>	approx. 0.9 W
--	---------------

\*2 Rating with low cut filter equipped amplifier

### Note

- Specifications are subject to change without notice. Mass and dimensions are approximate.
- Total harmonic distortion is measured by a digital spectrum analyzer.

# Troubleshooting guide

Before requesting service, make the following checks. If you are in doubt about some of the check points, or if the solutions indicated in the chart do not solve the problem, consult your dealer.

## Power

Page

No power.	● Insert the AC mains lead and system cable securely.	8
The unit is automatically switched to the standby mode.	● The Sleep timer was working and had reached the set time limit.	27

## Unresponsive or inoperable function

No response when any buttons are pressed.	<ul style="list-style-type: none"> <li>● This unit cannot play discs other than the ones listed in these operating instructions.</li> <li>● The unit may not be operating properly due to lightning, static electricity or some other external factor. Turn the unit off and then back to ON. Alternatively, turn the unit off, disconnect the AC mains lead, and then reconnect it.</li> <li>● Condensation has formed: Wait 1 to 2 hours for it to evaporate.</li> </ul>	11 —
No response when remote control buttons are pressed.	<ul style="list-style-type: none"> <li>● Check that the batteries are installed correctly.</li> <li>● The batteries are depleted. Replace them with new ones.</li> <li>● Aim the remote control at the remote control signal sensor and operate.</li> </ul>	9 9 10
Cannot play DVD's.	● CD Mode is on. Press [SHIFT]+[CD MODE] to turn CD Mode off.	14
No picture or sound.	<ul style="list-style-type: none"> <li>● Check the video or audio connection.</li> <li>● Check the power or input setting of the connected equipment.</li> <li>● Check that the DVD-RAM has something recorded on it.</li> </ul>	4, 7, 28 — —
You have forgotten your ratings password. Reset all the settings to Factory Preset.	● While stopped and "DVD/CD" is the source, press and hold [■] on the main unit and [≥10] on the remote control until "Initialized" (or "Initialised") disappears from the television. Turn the unit off and on again. All settings will return to the default values.	—

## Specific operation undesirable or unexpected

It takes time before play starts. <b>MP3</b>	● Play may take time to begin when an MP3 track has still picture data. Even after the track starts, the correct play time will not be displayed. This is normal.	—
Folders deeper than the eighth layer on a data CD are not displayed correctly. <b>WMA MP3 JPEG</b>	● Folders deeper than the eighth layer are displayed as the eighth layer.	—
A menu screen appears during skip or search. <b>VCD</b>	● This is normal for Video CD's.	—
Playback control menu doesn't appear. <b>VCD</b> with playback control	● Press [■] twice and then press [▶] (play).	—
The program and random play functions do not work. <b>DVD-V</b>	● These functions do not work with some DVD-Videos.	—
Programmed items are not played. <b>DVD-V</b>	● Some items cannot be played even if you have programmed them.	—
The on-screen menu shows "2" as a soundtrack option when [AUDIO] is pressed, but the audio does not change. <b>DVD-A</b>	● Even if a second soundtrack isn't recorded, two numbers will normally be shown.	—
Play restarts from the beginning of the track when soundtrack is changed. <b>DVD-A</b>	● This is normal on DVD-Audio.	—
Scenes are skipped intermittently. <b>RAM DVD-V</b>	● If you change the volume or sound field/quality setting during ADVANCED DISC REVIEW, the function continues without the on-screen display. Press [ADVANCED DISC REVIEW] again to cancel the function.	14

## Subtitle

Subtitle position is wrong.	● Adjust the position. ("Subtitle Position" in Display Menu)	21
No subtitles.	● Display the subtitles.	15

## Marker

Cannot add markers.	<ul style="list-style-type: none"> <li>● You cannot add markers with DVD-RAM.</li> <li>● If the disc's elapsed play time doesn't appear on the unit's display, you cannot add markers.</li> </ul>	— —
---------------------	---	--------

## A-B repeat

Point B is automatically set.	● The end of an item becomes point B when it is reached.	—
A-B repeat is automatically canceled.	● A-B repeat is canceled when you press [QUICK REPLAY].	—

## Sound abnormal or improper

Sound distorted.	● Noise may occur when playing WMA.	—
Effects do not work.	<ul style="list-style-type: none"> <li>● Some audio effects do not work or have less effect with some discs.</li> <li>● Multi Re-master and Dolby Pro Logic II do not work if you have changed the play speed.</li> </ul>	— —
Humming is heard during play.	● An AC mains lead or fluorescent light is near the subwoofer. Keep other appliances and cables away from the subwoofer.	—
No sound	● There may be a pause in sound when you change the play speed.	—



## Menus

Page

The Setup menu cannot be accessed.	<ul style="list-style-type: none"> <li>Select "DVD/CD" as the source.</li> <li>Cancel program and random play.</li> </ul>	— 16
------------------------------------	---	---------

## Picture abnormal or unviewable

Picture distorted.	<ul style="list-style-type: none"> <li>Ensure that the unit is connected directly to the television, and is not connected through a video cassette recorder.</li> </ul>	7
Picture size doesn't fit the screen.	<ul style="list-style-type: none"> <li>Change "TV Aspect" in the "Video" tab.</li> <li>Change the Zoom setting.</li> </ul>	22 15
The television may display incorrectly or colors appear faded.	<ul style="list-style-type: none"> <li>The unit and television are using different video systems.                             <ul style="list-style-type: none"> <li><b>Southeast Asia and Thailand</b> Use a multi-system or NTSC television.</li> <li><b>Others</b> Use a multi-system or PAL television.</li> </ul> </li> <li>The system used on the disc does not match your television.                             <ul style="list-style-type: none"> <li>– PAL discs cannot be correctly viewed on an NTSC television.</li> <li>– This unit can convert NTSC signals to PAL 60 for viewing on a PAL television ("NTSC Disc Output" in "Video" tab).</li> </ul> </li> </ul>	— — 23
Menu is not displayed correctly.	<ul style="list-style-type: none"> <li>Restore the zoom ratio to "×1.00".</li> <li>Set "Subtitle Position" in Display Menu to "0".</li> </ul>	15 21
Auto zoom function does not work well.	<ul style="list-style-type: none"> <li>Turn off TV's zoom function.</li> <li>Use the other preset aspect ratios or manual adjustment.</li> <li>Zoom function may not work well, especially in dark scenes and may not work depending on the type of disc.</li> </ul>	— 15 —
The picture on the television disappears or stripes appear on the screen.	<ul style="list-style-type: none"> <li>Mobile telephone chargers can cause some disturbance.</li> <li>If you are using a TV indoor antenna, change to an outdoor antenna.</li> <li>The television antenna wire is too close to the unit. Separate the antenna wire of the television from the unit.</li> </ul>	— — —

## Progressive video

There is ghosting when progressive output is on.	<ul style="list-style-type: none"> <li>This problem is caused by the editing method or material used on DVD-Video, but should be corrected if you use interlace output. Change "Video Output Mode" in Picture Menu to "480i (or 525i)" or "576i (or 625i)".</li> </ul>	21
Pictures not in progressive output.	<ul style="list-style-type: none"> <li>Press [PROGRESSIVE] on the main unit so "PRG" is displayed. Or select "480p (or 525p)" or "576p (or 625p)" in "Video Output Mode" in Picture Menu.</li> <li>If the unit is connected to the television through VIDEO OUT or S-VIDEO OUT terminal, output will be interlace even if "PRG" is displayed.</li> </ul>	12, 21 7

## Listening to the radio

Noise is heard. "ST" flickers or doesn't light. Sound is distorted.	<ul style="list-style-type: none"> <li>Adjust the position of the FM or AM antenna.</li> <li>Use an outdoor antenna.</li> </ul>	— 25
A beat sound is heard.	<ul style="list-style-type: none"> <li>Turn the television off or move it away from the unit.</li> </ul>	—
A low hum is heard during AM broadcasts.	<ul style="list-style-type: none"> <li>Separate the antenna from other cables.</li> </ul>	—

## Television operation

Cannot operate the TV.	<ul style="list-style-type: none"> <li>Press [TV] first to operate the television.</li> <li>Check the remote control code for the TV manufacturer.</li> </ul>	— 29
------------------------	---	---------

## Unit displays

The display is dark.	<ul style="list-style-type: none"> <li>Select "Bright" in "FL Dimmer" in the "Others" tab.</li> </ul>	23
"NOPLAY"	<ul style="list-style-type: none"> <li>You inserted a disc the unit cannot play; insert one it can.</li> <li>You inserted a blank disc.</li> </ul>	11 —
"NODISC"	<ul style="list-style-type: none"> <li>You haven't inserted a disc; insert one.</li> <li>You haven't inserted the disc correctly; insert it correctly.</li> </ul>	— 12
"F61"	<ul style="list-style-type: none"> <li>Check and correct the speaker cord connections. If this does not fix the problem, there is a power supply problem. Consult the dealer.</li> </ul>	4, 7
"DVD U11"	<ul style="list-style-type: none"> <li>Disc is dirty. Wipe it clean.</li> </ul>	11
"ERROR"	<ul style="list-style-type: none"> <li>Incorrect operation performed. Read the instructions and try again.</li> </ul>	—
"DVD H□□" □□ stands for a number.	<ul style="list-style-type: none"> <li>Trouble may have occurred. The number following "H" depends on the status of the unit. Turn the unit off and then back to ON. Alternatively, turn the unit off, disconnect the AC mains lead, and then reconnect it.</li> <li>If the service numbers fail to clear, note the service number and contact a qualified service person.</li> </ul>	— —

## Television displays

"⊘"	<ul style="list-style-type: none"> <li>The operation is prohibited by the unit or disc.</li> </ul>	—
"Cannot display group xx, content xx"	<ul style="list-style-type: none"> <li>You are trying to display incompatible contents.</li> </ul>	—
"This disc may not be played in your region"	<ul style="list-style-type: none"> <li>You can only play DVD-Video if their region number is the same or includes the same region number as the unit or if the DVD-Video is marked "ALL". Confirm the region number for the unit on the rear panel.</li> </ul>	Cover page
No on-screen display.	<ul style="list-style-type: none"> <li>Select "On" in "On-Screen Messages" in the "Display" tab.</li> </ul>	23

# Safety precautions

## Placement

Set the unit up on an even surface away from direct sunlight, high temperatures, high humidity, and excessive vibration. These conditions can damage the cabinet and other components, thereby shortening the unit's service life.

Do not place heavy items on the unit.

## Voltage

Do not use high voltage power sources. This can overload the unit and cause a fire.

Do not use a DC power source. Check the source carefully when setting the unit up on a ship or other places where DC is used.

## AC mains lead protection

Ensure the AC mains lead is connected correctly and not damaged. Poor connection and lead damage can cause fire or electric shock. Do not pull, bend, or place heavy items on the lead.

Grasp the plug firmly when unplugging the lead. Pulling the AC mains lead can cause electric shock.

Do not handle the plug with wet hands. This can cause electric shock.

## Foreign matter

Do not let metal objects fall inside the unit. This can cause electric shock or malfunction.

Do not let liquids get into the unit. This can cause electric shock or malfunction. If this occurs, immediately disconnect the unit from the power supply and contact your dealer.

Do not spray insecticides onto or into the unit. They contain flammable gases which can ignite if sprayed into the unit.

## Service

Do not attempt to repair this unit by yourself. If sound is interrupted, indicators fail to light, smoke appears, or any other problem that is not covered in these instructions occurs, disconnect the AC mains lead and contact your dealer or an authorized service center. Electric shock or damage to the unit can occur if the unit is repaired, disassembled or reconstructed by unqualified persons.

Extend operating life by disconnecting the unit from the power source if it is not to be used for a long time.

# Maintenance

**Clean this unit with a soft, dry cloth.**

- Never use alcohol, paint thinner or benzene to clean this unit.
- Before using chemically treated cloth, carefully read the instructions that came with the cloth.

**Do not use commercially available lens cleaners as they may cause malfunction.** (Cleaning of the lens is generally not necessary although this depends on the operating environment.)

**Before moving the unit, ensure the disc trays are empty.**

Failure to do so will risk severely damaging the discs and the unit.

## Language code list

Abkhazian: 6566	Chinese: 9072	Hausa: 7265	Lithuanian: 7684	Romanian: 8279	Telugu: 8469
Afar: 6565	Corsican: 6779	Hebrew: 7387	Macedonian: 7775	Russian: 8285	Thai: 8472
Afrikaans: 6570	Croatian: 7282	Hindi: 7273	Malagasy: 7771	Samoa: 8377	Tibetan: 6679
Albanian: 8381	Czech: 6783	Hungarian: 7285	Malay: 7783	Sanskrit: 8365	Tigrinya: 8473
Ameharic: 6577	Danish: 6865	Icelandic: 7383	Malayalam: 7776	Scots Gaelic: 7168	Tonga: 8479
Arabic: 6582	Dutch: 7876	Indonesian: 7378	Maltese: 7784	Serbian: 8382	Turkish: 8482
Armenian: 7289	English: 6978	Interlingua: 7365	Maori: 7773	Serbo-Croatian: 8372	Turkmen: 8475
Assamese: 6583	Esperanto: 6979	Irish: 7165	Marathi: 7782	Shona: 8378	Twi: 8487
Aymara: 6588	Estonian: 6984	Italian: 7384	Moldavian: 7779	Sindhi: 8368	Ukrainian: 8575
Azerbaijani: 6590	Faroe: 7079	Japanese: 7465	Mongolian: 7778	Singhalese: 8373	Urdu: 8582
Bashkir: 6665	Fiji: 7074	Javanese: 7487	Nauru: 7865	Slovak: 8375	Uzbek: 8590
Basque: 6985	Finnish: 7073	Kannada: 7578	Nepali: 7869	Slovenian: 8376	Vietnamese: 8673
Bengali; Bangla: 6678	French: 7082	Kashmiri: 7583	Norwegian: 7879	Somali: 8379	Volapük: 8679
Bhutani: 6890	Frisian: 7089	Kazakh: 7575	Oriya: 7982	Spanish: 6983	Welsh: 6789
Bihari: 6672	Galician: 7176	Kirghiz: 7589	Pashto, Pushto: 8083	Sundanese: 8385	Wolof: 8779
Breton: 6682	Georgian: 7565	Korean: 7579	Persian: 7065	Swahili: 8387	Xhosa: 8872
Bulgarian: 6671	German: 6869	Kurdish: 7585	Polish: 8076	Swedish: 8386	Yiddish: 7473
Burmese: 7789	Greek: 6976	Laotian: 7679	Portuguese: 8084	Tagalog: 8476	Yoruba: 8979
Byelorussian: 6669	Greenlandic: 7576	Latin: 7665	Punjabi: 8065	Tajik: 8471	Zulu: 9085
Cambodian: 7577	Guarani: 7178	Latvian, Lettish: 7686	Quechua: 8185	Tamil: 8465	
Catalan: 6765	Gujarati: 7185	Lingala: 7678	Rhaeto-Romance: 8277	Tatar: 8484	

# Glossary

## Decoder

A decoder restores the coded audio signals on DVD's to normal. This is called decoding.

## Dolby Digital

This is a method of coding digital signals developed by Dolby Laboratories. Apart from stereo (2-channel) audio, these signals can also be multi-channel audio. A large amount of audio information can be recorded on one disc using this method.

## DTS (Digital Theater Systems)

This surround system is used in many movie theaters around the world. There is good separation between the channels, so realistic sound effects are possible.

## Dynamic range

Dynamic range is the difference between the lowest level of sound that can be heard above the noise of the equipment and the highest level of sound before distortion occurs.

## Frame still and field still

Frames are the still pictures that go together to make a moving picture. There are about 30 frames shown each second.

One frame is made up of two fields. A regular television shows these fields one after the other to create frames.

A still is shown when you pause a moving picture. A frame still is made up of two alternating fields, so the picture may appear blurred, but overall quality is high.

A field still is not blurred, but it has only half the information of a frame still so picture quality is lower.

## I/P/B

MPEG 2, the video compression standard adopted for use with DVD-Video, codes frames using these 3 picture types.

**I:** Intra coded picture

This picture has the best quality and is the best to use when adjusting the picture.

**P:** Predictive coded picture

This picture is calculated based on past I or P-pictures.

**B:** Bidirectionally-predictive coded picture

This picture is calculated by comparing past and future I and P-pictures so it has the lowest volume of information.

## Linear PCM (pulse code modulation)

These are uncompressed digital signals, similar to those found on CDs.

## Playback control (PBC)

If a Video CD has playback control, you can select scenes and information with menus.

## Sampling frequency

Sampling is the process of converting the heights of sound wave (analog signal) samples taken at set periods into digits (digital encoding). Sampling frequency is the number of samples taken per second, so larger numbers mean more faithful reproduction of the original sound.

# MEMO

# Accessories

Please check and identify the supplied accessories.



- 1 Remote control (EUR7722XE0)

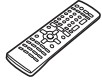

- 2 Remote control batteries



- 1 Video cable



- 1 System cable



- 1 AM loop antenna



- 1 FM indoor antenna



- AC mains lead  
Southeast Asia, Thailand, the Middle East,  
South Africa, Saudi Arabia and Kuwait



Saudi Arabia and Kuwait



- 1 Speaker cable



- 1 Sheet of speaker-cable stickers



- 4 Pipes  
2×pipes with short cable



- 2×pipes with long cable



- 4 Bases



- 8 Long screws



- 8 Short screws

