

EDH3887GDE

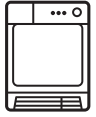

EN Tumble Dryer

User Manual

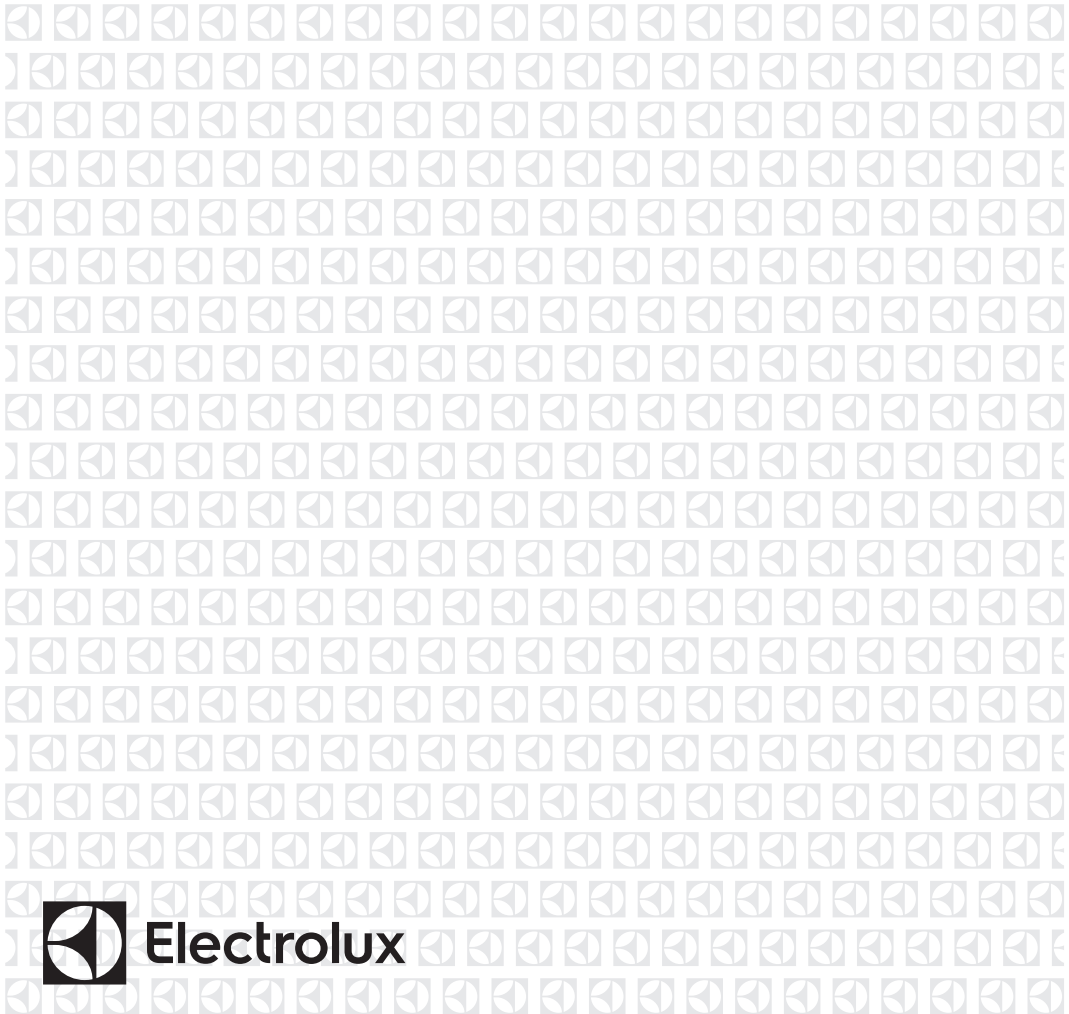

CONTENTS

1. SAFETY INFORMATION.....	3
2. SAFETY INSTRUCTIONS.....	5
3. PRODUCT DESCRIPTION.....	7
4. CONTROL PANEL.....	7
5. PROGRAMME TABLE.....	8
6. OPTIONS.....	10
7. SETTINGS.....	11
8. BEFORE FIRST USE.....	11
9. DAILY USE.....	12
10. HINTS AND TIPS.....	13
11. CARE AND CLEANING.....	14
12. TROUBLESHOOTING.....	16
13. TECHNICAL DATA.....	17

WE'RE THINKING OF YOU

Thank you for purchasing an Electrolux appliance. You've chosen a product that brings with it decades of professional experience and innovation. Ingenious and stylish, it has been designed with you in mind. So whenever you use it, you can be safe in the knowledge that you'll get great results every time.

Welcome to Electrolux.

Visit our website for:



Get usage advice, brochures, trouble shooter, service information:
www.electrolux.com/webselfservice



Register your product for better service:
www.registerelectrolux.com



Buy Accessories, Consumables and Original spare parts for your appliance:
www.electrolux.com/shop

CUSTOMER CARE AND SERVICE

Always use original spare parts.

When contacting our Authorised Service Centre, ensure that you have the following data available: Model, PNC, Serial Number.

The information can be found on the rating plate.



Warning / Caution-Safety information



General information and tips



Environmental information

Subject to change without notice.

1. SAFETY INFORMATION

Before the installation and use of the appliance, carefully read the supplied instructions. The manufacturer is not responsible if an incorrect installation and use causes injuries and damages. Always keep the instructions with the appliance for future reference.



- Read the supplied instructions.

1.1 Children and vulnerable people safety



WARNING!

Risk of suffocation, injury or permanent disability.

- This appliance can be used by children aged from 8 years and above and persons with reduced physical, sensory or mental capabilities or lack of experience and knowledge if they have been given supervision or instruction concerning use of the appliance in a safe way and understand the hazards involved.
- Do not let children play with the appliance.
- Children of less than 3 years should be kept away unless continuously supervised.
- Keep all packaging away from children.
- Keep all detergents away from children.
- Keep children and pets away from the appliance door when it is open.
- If the appliance has a child safety device, we recommend you activate it.
- Cleaning and user maintenance shall not be made by children without supervision.

1.2 General Safety

- Do not change the specification of this appliance.
- If the tumble dryer is put on top of a washing machine, use the stacking kit. The stacking kit, available from your authorized vendor, can be used only with the

appliance specified in the instructions, supplied with the accessory. Read it carefully before installation (Refer to the Installation leaflet).

- The appliance can be installed as freestanding or below the kitchen counter with correct space (Refer to the Installation leaflet).
- Do not install the appliance behind a lockable door, a sliding door or a door with a hinge on the opposite side, where the appliance door can not be fully opened.
- The ventilation openings in the base (if applicable) must not be obstructed by a carpet.
- Connect the mains plug to the mains socket only at the end of the installation. Make sure that there is access to the mains plug after the installation.
- Ensure you have good ventilation in the installation room to avoid the back flow of gases into the room from appliances burning other fuels, including open fires.
- Exhaust air must not be discharged into a flue which is used for exhausting fumes from appliances burning gas or other fuels. (if applicable)
- If the supply cord is damaged, it must be replaced by the manufacturer, its Authorised Service Centre or similarly qualified persons in order to avoid a hazard.
- Obey the maximum load volume of 8kg (refer to the “Programme chart” chapter).
- Do not use the appliance if industrial chemicals have been used for cleaning.
- Wipe away lint that has accumulated around the appliance.
- Do not run the appliance without a filter. Clean the lint filter before or after each use.
- Do not dry unwashed items in the tumble dryer.
- Items that have been soiled with substances such as cooking oil, acetone, alcohol, petrol, kerosene, spot removers, turpentine, waxes and wax removers

- should be washed in hot water with an extra amount of detergent before being dried in the tumble dryer.
- Items such as foam rubber (latex foam), shower caps, waterproof textiles, rubber backed articles and clothes or pillows fitted with foam rubber pads should not be dried in the tumble dryer.
 - Fabric softeners, or similar products, should be used as specified by the fabric softener instructions.
 - Remove all objects from pockets such as lighters and matches.
 - Never stop a tumble dryer before the end of the drying cycle unless all items are quickly removed and spread out so that the heat is dissipated.
 - The final part of a tumble dryer cycle occurs without heat (cool down cycle) to ensure that the items are left at a temperature that ensures that the items will not be damaged.
 - Before maintenance, deactivate the appliance and disconnect the mains plug from the mains socket.

2. SAFETY INSTRUCTIONS

2.1 Installation

- Remove all the packaging.
- Do not install or use a damaged appliance.
- Obey the installation instruction supplied with the appliance.
- Always be careful when you move the appliance because it is heavy. Always wear safety gloves.
- Do not install or use the appliance where the temperature is less than 5°C or higher than 35°C.
- Make sure that the floor where you install the appliance is flat, stable, heat resistant and clean.
- Make sure that there is air circulation between the appliance and the floor.
- Always move the appliance vertically.
- The rear surface of the appliance must be put against the wall.
- When the appliance is put in its permanent position, check if it is fully

level with the aid of a spirit level. If it is not, adjust the feet until it is.

2.2 Electrical connection



WARNING!

Risk of fire and electrical shock.

- The appliance must be earthed.
- Make sure that the electrical information on the rating plate agrees with the power supply. If not, contact an electrician.
- Always use a correctly installed shockproof socket.
- Do not use multi-plug adapters and extension cables.
- Do not pull the mains cable to disconnect the appliance. Always pull the mains plug.
- Do not touch the mains cable or the mains plug with wet hands.

- Only for UK and Ireland. The appliance has a 13 A mains plug. If it is necessary to change the fuse in the mains plug, use a 13 A ASTA (BS 1362) fuse.
- This appliance complies with the E.E.C. Directives.

2.3 Use



WARNING!

Risk of injury, electrical shock, fire, burns or damage to the appliance.

- Use this appliance in a household only.
- Do not dry the damaged items which contain padding or fillings.
- Only dry fabrics which are applicable to dry in the tumble dryer. Follow the instructions on the fabric label.
- If you have washed your laundry with a stain remover start an extra rinse cycle before you start the dryer.
- Do not drink or prepare food with the condensed water/distilled water. It can cause health problems to people and pets.
- Do not sit or stand on the open door.
- Do not dry dripping wet clothes in the tumble dryer.

2.4 Internal light



WARNING!

Risk of injury.

- Visible LED radiation, do not look directly into the beam.
- The type of light bulb or halogen lamp used for this appliance is only for

household appliances. Do not use it for house lighting.

- To replace the internal light, contact the Authorised Service Centre.

2.5 Care and cleaning



WARNING!

Risk of injury or damage to the appliance.

- Do not use water spray and steam to clean the appliance.
- Clean the appliance with a moist soft cloth. Only use neutral detergents. Do not use abrasive products, abrasive cleaning pads, solvents or metal objects.

2.6 Compressor



WARNING!

Risk of damage to the appliance.

- The compressor and its system in the tumble dryer is filled with the special agent which is free from fluoro-chloro-hydrocarbons. This system must stay tight. The damage of the system can cause a leakage.

2.7 Disposal



WARNING!

Risk of injury or suffocation.

- Disconnect the appliance from the mains supply.
- Cut off the mains cable and discard it.
- Remove the door catch to prevent children and pets to get closed in the appliance.

3. PRODUCT DESCRIPTION

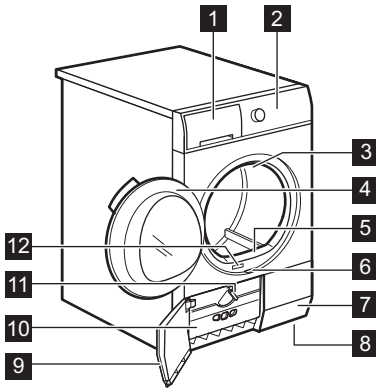

- 1** Water container
- 2** Control panel
- 3** Internal light
- 4** Appliance door
- 5** Primary Filter
- 6** The button to open the heat exchanger door
- 7** Airflow slots
- 8** Adjustable feet
- 9** Heat exchanger door
- 10** Heat exchanger cover
- 11** The knob to lock the heat exchanger cover
- 12** Rating plate

i The load door can be installed by the user in the opposite side. It can help to easily put and remove the laundry or if there is a limit to install the appliance (see separate leaflet).

4. CONTROL PANEL

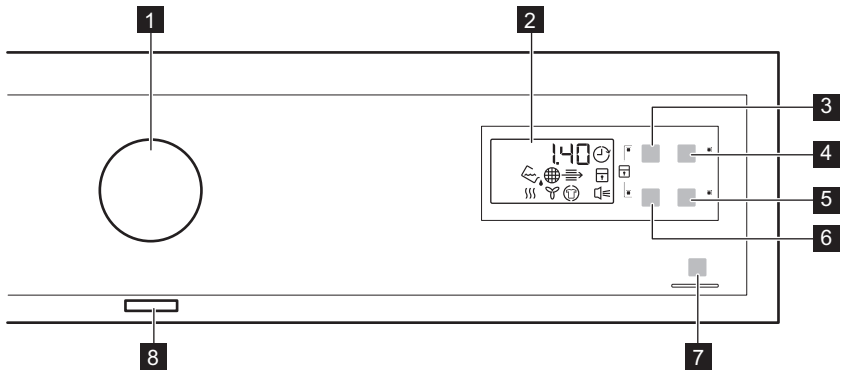

- 1** Programme knob
- 2** Display
- 3** Time touchpad
- 4** Delay touchpad
- 5** Buzzer touchpad
- 6** Wool Load touchpad
- 7** Start/Pause touchpad
- 8** On/Off button



















Touch the touchpads with your finger in the area with the symbol or name of the option. Do not wear gloves when you operate with the control panel. Make sure that the control panel is always clean and dry.





4.1 Indicators

Indicators	Description
	Drying phase
	Cooling phase
	Crease guard phase
	Condenser
	Water container
	Filter
	Delay start
	Child lock
	Acoustic signals
2.00	Programme duration
10' - 2.00	Time Drying duration
30' - 20 h	Delay start duration

5. PROGRAMME TABLE

Programmes	Type of load	Load (max.) ¹⁾ / Fabric mark
Cotton		
Extra Dry	Drying level: extra dry.	8kg/
Cupboard Dry +	Drying level: strong dry.	8kg/
Cupboard Dry ^{2) 3)}	Drying level: cupboard dry.	8kg/

Programmes	Type of load	Load (max.) ¹⁾ / Fabric mark
 Iron Dry ²⁾	Drying level: applicable for iron.	8kg/ 
 Synthetic		
 Extra Dry	Drying level: extra dry.	3,5kg/ 
 Cupboard Dry ²⁾	Drying level: cupboard dry.	3,5kg/ 
 Iron Dry	Drying level: applicable for iron.	3,5kg/ 
 Rapid	To dry cotton and synthetic fabrics.	2kg/ 
 Time Drying	With this programme you can use the option Time and set the programme duration.	5kg/ 
 Refresh	Refreshing a textiles that were in storage.	1kg
<p>Wool fabrics. Gentle drying for hand-washable woollens. Remove immediately the items when the programme is completed.</p> <div style="text-align: center;">  <p>WOOL HAND WASH SAFE 1kg</p> </div> <p>The wool drying cycle of this machine has been approved by The Woolmark Company for the drying of wool garments labelled as "hand wash" provided that the garments are dried according to the instructions issued by the manufacturer of this machine. Follow the garment care label for other laundry instructions. M1525 In UK, Eire, Hong Kong and India the Woolmark trade mark is a Certification trade mark."</p>		
 Silk	To dry silk with warm air and gentle movement.	1kg/ 

Programmes	Type of load	Load (max.) ¹⁾ / Fabric mark
 Duvet	To dry single or double duvet and pillows (with feather, down or synthetic fillings).	3kg/ 
 Easy Iron	Easy care fabrics for which a minimum of ironing is necessary. The drying results can be different from one type of fabric to the other. Shake the items before you put them in the appliance. When the programme is completed, Immediately remove the items and put them on a hanger.	1kg (or 5 shirts)/ 

1) The maximum weight refers to dry items.

2) **For test institutes only:** Standard programmes for tests are specified in the EN 61121 document. Clean the primary filter and heat exchanger filter after each cycle.

3) The  Cotton Cupboard Dry programme is the “Standard cotton programme” and it is suitable to dry normal wet cotton laundry and it is the most efficient programme in terms of energy consumption for drying wet cotton laundry.

6. OPTIONS

6.1 Time

This option is applicable only to the Time Drying programme. You can set the programme duration, from a minimum of 10 minutes to a maximum of 2 hours. The setting of the duration is related to the quantity of laundry in the appliance.



We recommend that you set a short duration for small quantities of laundry or for only one item.

6.2 Wool Load

This option is applicable only to the Wool programme. To get laundry more dried

press the Wool Load  touchpad again and again to increase the programme duration.

6.3 Buzzer

you can hear the buzzer at the:

- cycle end
- start and end of crease guard phase
- cycle interruption

The buzzer function is by default always on. You can use this function to activate or deactivate the sound.



You can activate the Buzzer option with all programmes.

6.4 Options table

Programmes ¹⁾		
 Time Drying	■	

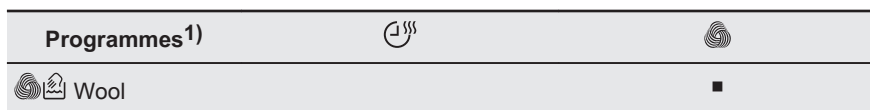

1) Together with the programme you can set 1 or more options. To activate or deactivate them, press the related touchpad.

7. SETTINGS

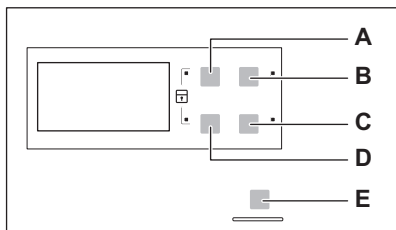

- A) Time touchpad
 B) Delay touchpad
 C) Buzzer touchpad
 D) Wool Load touchpad
 E) Start/Pause touchpad

7.1 Child lock function

This option prevents children to play with the appliance while a programme operates. The programme knob and the touchpads are locked.

Only the on/off button is unlocked.

Activating the child lock option:

1. Press the on/off button to activate the appliance.
2. Wait approximately 8 seconds.
3. Press and hold touchpads (A) and (D) at the same time. The child lock indicator comes on.

The child lock indicator comes on.



It is possible to deactivate the child lock option while a programme operates. Press and hold the same touchpads until the child lock indicator goes off.

7.2 Adjustment of the remaining laundry moisture degree

To change the default degree of the remaining moisture of the laundry:

1. Press the on/off button to activate the appliance.
2. Wait approximately 8 seconds.
3. Press and hold buttons (A) and (B) at the same time.

One of these indicators comes on:

- the maximum dry laundry
 - the more dry laundry
 - the standard dry laundry
4. Press the button (E) again and again until the indicator of the correct level comes on.
 5. To confirm the adjustment, press and hold buttons (A) and (B) at the same time for approximately 2 seconds.

8. BEFORE FIRST USE



Rear drum packaging is removed automatically when dryer is activated for the first time. Possible to hear some noise.

- Clean the tumble dryer drum with a moist cloth.
- Start a short programme (e.g. 30 minutes) with moist laundry.

Before you use the appliance for the first time do these operations:



At the beginning of drying cycle (3-5 min.) there could be a slightly higher sound level. It is because of start of the compressor that is normal for compressor powered appliances such: refrigerators, freezers.

9. DAILY USE

9.1 Start a programme without delay start

1. Prepare the laundry and load the appliance.



CAUTION!

Make sure that when you close the door, the laundry does not catch between the appliance door and the rubber seal.

2. Press the on/off button to activate the appliance.
3. Set the correct programme and options for the type of load.

The display shows the programme duration.



The drying time you see is related to the load of 5 kg for cotton and jeans programmes. For the other programmes the drying time is related to the recommended loads. The drying time of the cotton and jeans programmes with the load more than 5 kg is longer.

4. Press the Start/Pause touchpad. The programme starts.

9.2 Starting the programme with delay start

1. Set the correct programme and options for the type of load.
2. Press the delay start button again and again until the display shows the delay time you want to set.



You can delay the start of a programme from a minimum of 30 minutes to a maximum of 20 hours.

3. Press the Start/Pause touchpad. The display shows the countdown of the delay start.



When the countdown is completed, the programme starts.

9.3 Change a programme

1. Press the on/off button to deactivate appliance
2. Press the on/off button to activate the appliance.
3. Set the programme.

9.4 At the end of the programme

When the programme is completed:



- An intermittent acoustic signal operates.
- The indicator  flashes.
- The indicator  flashes.
- The Start/Pause indicator is on.

The appliance continues to operate with the crease guard phase for approximately other 30 minutes.

The crease guard phase prevents creases from your laundry.

You can remove the laundry before the crease guard phase is completed. We recommend, for better results, that you remove the laundry when the phase is almost completed.

When the crease guard phase is completed:

- The indicator  is on but does not flash.
 - The indicator  is on but does not flash.
 - Start/Pause indicator goes off.
1. Press the on/off button to deactivate the appliance.
 2. Open the appliance door.
 3. Remove the laundry.
 4. Close the appliance door.



Always clean the filter and empty the water container when a programme is completed.

9.5 Stand-by function





To decrease the energy consumption, this function automatically deactivates the appliance:

- After 5 minutes if you do not start the programme.
- After 5 minutes from the end of the programme.

10. HINTS AND TIPS

10.1 Preparing the laundry

- Close the zippers.
 - Close the fasteners of the duvet covers.
 - Do not keep ties or ribbons loose (e.g. apron ribbons). Tie them before you start a programme.
 - Remove all items from the pockets.
 - If an item has the internal layer made of cotton, turn it inside out. Make sure that the cotton layer is always external
 - We recommend that you set the correct programme applicable for the type of fabrics that are in the appliance.
- Do not put fabrics with strong colours together with fabrics with light colours. Strong colours can bleed.
 - Use an applicable programme for cotton jersey and knitwear to prevent the items to shrink.
 - Make sure that the laundry weight is not more than the maximum weight that is in the programme table.
 - Dry only the laundry that is applicable for tumble dryer. Refer to the fabric label on the items.
 - Do not dry large and small items together. Small items can be trapped inside the large and remain not dried.

Fabric label	Description
	Laundry that is applicable for tumble drying.
	Laundry that is applicable for tumble drying and resists higher drying temperature.
	Laundry that is applicable for tumble drying but only with low drying temperature.
	Laundry that is not applicable for tumble drying.

11. CARE AND CLEANING

11.1 Cleaning the filter

1.

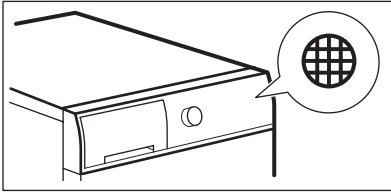

2.

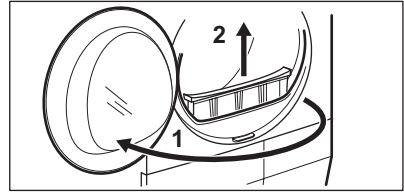

3.

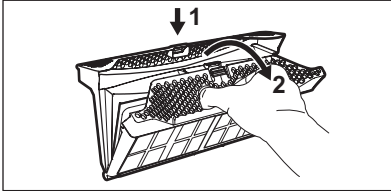

4.

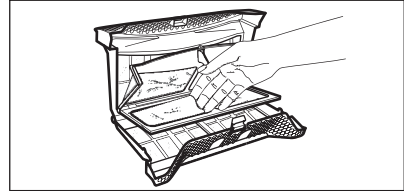

5. 1)

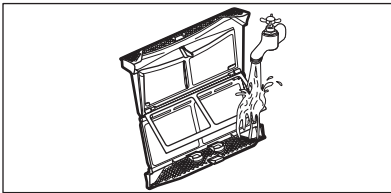

6.

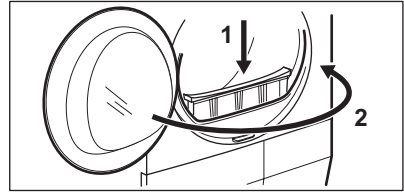

1) If necessary clean the filter with tap warm water using a brush and/or a vacuum cleaner.

11.2 Emptying the water container

1.

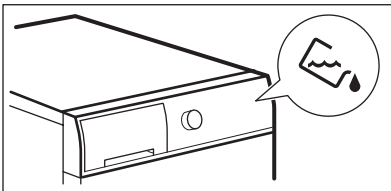

2.

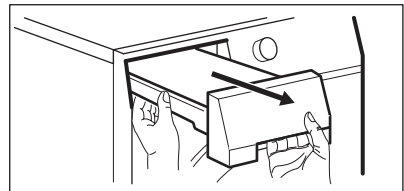

3.

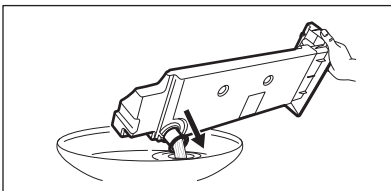

4.

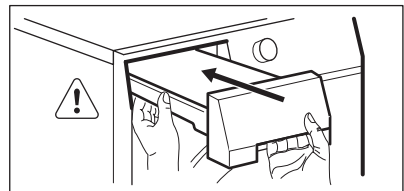

- i** You can use the water from the water container as an alternative to distilled water (e.g. for steam ironing). Before you use the water, remove dirt residues with a filter.

11.3 Cleaning the condenser

1.

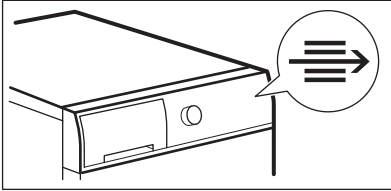

2.

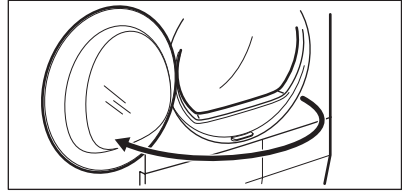

3.

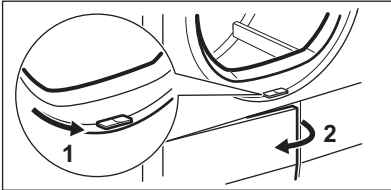

4.

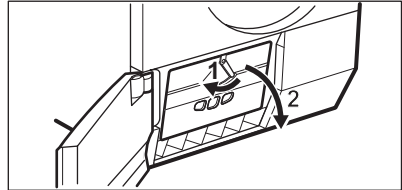

5.

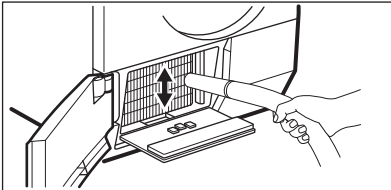

6.

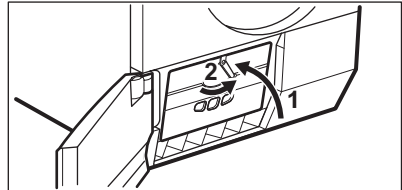

8.

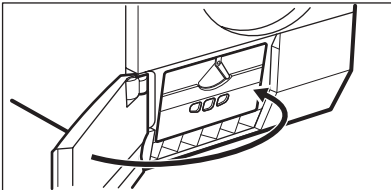

CAUTION!
Do not touch the metal surface with bare hands. Risk of injury. Wear protective gloves. Clean carefully to do not damage the metal surface.

11.4 Cleaning the drum



WARNING!
Disconnect the appliance before you clean it.

Use a standard neutral soap detergent to clean the inner surface of the drum and

drum ribs. Dry the cleaned surfaces with a soft cloth.



CAUTION!

Do not use abrasive materials or steel wool to clean the drum.

11.5 Cleaning the control panel and housing

Use a standard neutral soap detergent to clean the control panel and housing.

Use a moist cloth to clean. Dry the cleaned surfaces with a soft cloth.



CAUTION!

Do not use furniture cleaning agents or cleaning agents which can cause corrosion to clean the appliance.

11.6 Cleaning the airflow slots

Use a vacuum cleaner to remove the fluff from the airflow slots.

12. TROUBLESHOOTING

Problem	Possible solution
You cannot activate the appliance.	Make sure that the mains plug is connected to the mains socket.
	Check fuse in fuse box (domestic installation).
The programme does not start.	Press Start/Pause.
	Make sure that the appliance door is closed.
The appliance door does not close.	Make sure that the installation of the filter is correct.
	Make sure that the laundry does not catch between the appliance door and the rubber seal.
The appliance stops during operation.	Make sure that the water container is empty. Press Start/Pause to start the programme again.
The cycle time is too long or unsatisfactory drying result. ¹⁾	Make sure that the weight of the laundry is applicable to the duration of the programme.
	Make sure that the filter is clean.
	The laundry is too wet. Spin the laundry in the washing machine again.
	Ensure that the room temperature is higher than +5°C and lower than +35°C. Optimal room temperature is 19°C to 24°C.
	Set the Time Drying or the Extra Dry programme. ²⁾

Problem	Possible solution
The display shows Err.	If you want to set a new programme, deactivate and activate the appliance.
	Make sure that the options are applicable to the programme.
The display shows (e.g. E51).	Deactivate and activate the appliance. Start a new programme. If the problem occurs again, contact the Service.

1) After maximum 6 hours, the programme ends automatically.

2) It can happen that some area remains humid when drying big items (e.g. bed sheets).

If the drying results are not satisfactory

- The set programme was incorrect.
- The filter is clogged.
- The condenser is clogged.
- There was too much laundry in the appliance.
- The drum is dirty.
- Incorrect setting of the conductivity sensor (See chapter "*Settings - Adjustment of the remaining laundry moisture degree*" for better setting).
- The airflow slots are clogged.
- Room temperature is too low or too high (optimal room temperature 19°C to 24°C)

13. TECHNICAL DATA

Height x Width x Depth	850 x 600 x 600 mm (maximal 640 mm)
Max. depth with the appliance door open	1090 mm
Max. width with the appliance door open	950 mm
Adjustable height	850 mm (+ 15 mm - feet regulation)
Drum volume	118 l
Maximum load volume	8 kg
Voltage	230-240 V
Frequency	50 Hz
Necessary fuse	13 A
Total power	900 W
Energy efficiency class	A++
Energy consumption ¹⁾	1,99 kWh
Annual energy consumption ²⁾	235 kWh
Left—on mode power absorption	0,13 W
Off mode power absorption	0,13 W
Type of use	Household

Permitted ambient temperature	+ 5°C to + 35°C
Level of protection against ingress of solid particles and moisture ensured by the protective cover, except where the low voltage equipment has no protection against moisture	IPX4
This product contains fluorinated gas hermetically sealed	
Gas designation	R134a
Weight	300 g
Global-warming potential (GWP)	1430

1) With reference to EN 61121. 8kg of cotton centrifuged at 1000 rpm.

2) Energy consumption per year in kWh, based on 160 drying cycles of the standard cotton programme at full and partial load, and the consumption of the low-power modes. Actual energy consumption per cycle will depend on how the appliance is used (REGULATION (EU) No 392/2012).

13.1 Consumption Data

Programme	Spun at / residual humidity	Drying time	Energy consumption
Cotton 8 kg			
Cupboard Dry	1400 rpm / 50%	130 min.	1,76 kWh
	1000 rpm / 60%	154 min.	1,99 kWh
Iron Dry	1400 rpm / 50%	97 min.	1,21 kWh
	1000 rpm / 60%	118 min.	1,51 kWh
Synthetic 3,5 kg			
Cupboard Dry	1200 rpm / 40%	55 min.	0,60 kWh
	800 rpm / 50%	67 min.	0,75 kWh

14. ENVIRONMENT CONCERNS

Recycle the materials with the symbol . Put the packaging in applicable containers to recycle it. Help protect the environment and human health and to recycle waste of electrical and electronic appliances. Do not dispose appliances

marked with the symbol  with the household waste. Return the product to your local recycling facility or contact your municipal office.

www.electrolux.com/shop



136940420-A-282015

