

# HUBBELL

## Marine Products

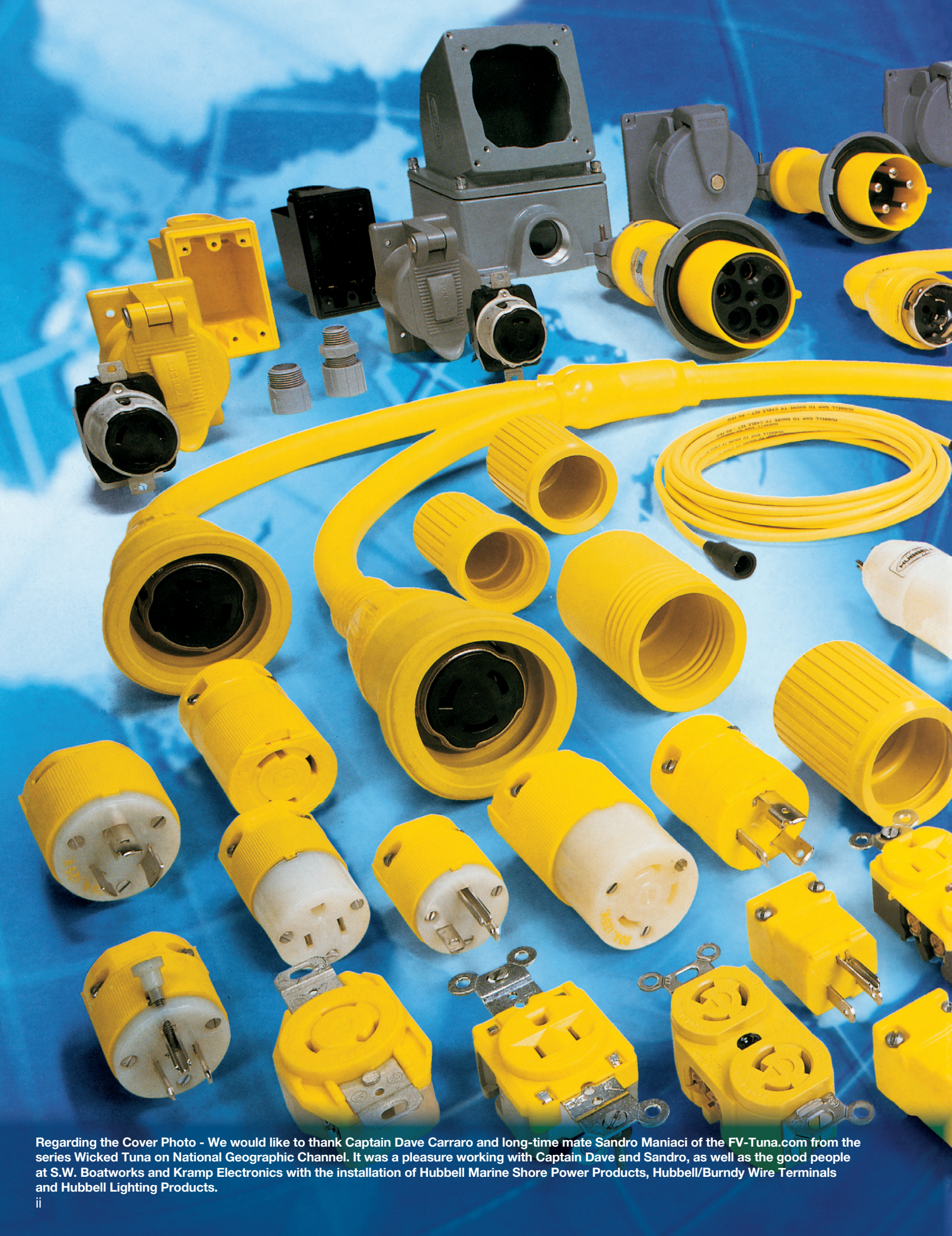



Regarding the Cover Photo - We would like to thank Captain Dave Carraro and long-time mate Sandro Maniaci of the FV-Tuna.com from the series Wicked Tuna on National Geographic Channel. It was a pleasure working with Captain Dave and Sandro, as well as the good people at S.W. Boatworks and Kramp Electronics with the installation of Hubbell Marine Shore Power Products, Hubbell/Burndy Wire Terminals and Hubbell Lighting Products.



# NEC® Receptacle Code Compliance and General Information



## Tamper-Resistant Duplex Receptacles

Comply with NEC® 406.12  
Comply with NEC® 210.52

All 125V, 15A and 20A receptacles shall be listed tamper-resistant receptacles per NEC® Article 406.12, "Tamper-Resistant Receptacles in Dwelling Units".

### Tamper-Resistant



## Weather Resistant Duplex Receptacles

Comply with NEC® 406.9

All 125V and 250V, 15A and 20A receptacles shall be listed as weather resistant type per NEC® Article 406.9, "Receptacles in Damp and Wet Locations".



### Weather Resistant



These symbols appear in this catalog for easy identification.



Interior



Exterior

## What Do These Code Requirements Mean?

**Tamper-Resistant (TR)** receptacles incorporate internal mechanisms to limit access to energized internal components.

This new TR requirement is mandatory for use in dwelling unit outlets. There are also many other applications where the use of TR receptacles can provide an additional level of electrical safety.

**Weather Resistant (WR)** receptacles installed outdoors and in other wet and damp locations are subject to more demanding temperature variations, direct sunlight and unusual mechanical abuse than those in a typical dry environment. Hubbell's WR receptacles are designed to withstand these environments and conditions.



Washdown Areas



Marinas/Docks

NEC® is a registered trademark of the The National Electrical Code.

## Industrial and Commercial Wiring Devices and Systems

### Residential Products

### Kellems Wire Management Products

### Marine Products



### National Electrical Manufacturers Association

NEMA promotes the competitiveness of its member companies by providing a forum for the development of technical standards that are in the best interests of the industry and the users of its products.



### National Association of Electrical Distributors

Since 1908, NAED has served as the trade association for the electrical distribution industry. To be an NAED associate member, your company must be a manufacturer or value-added reseller.



### Restriction of Hazardous Substances

The RoHS Directive stands for "the restriction of the use of certain hazardous substances in electrical and electronic equipment".



### International Organization for Standardization

ISO (International Organization for Standardization) is the world's largest developer and publisher of International Standards.



Product	Page
New Marine Products	2
Ship-to-Shore Selection Guide	4
ELCI Interface Solutions	7
Ship-to-Shore Cable Sets and Devices	
30A Twist-Lock®	9
50A Twist-Lock®	14
100A Pin and Sleeve	19
200A Pin and Sleeve	23
Internationally Rated	
Pin and Sleeve Devices	24
Twist-Lock® Devices	25
Adapters	
Intelligent Y Adapters	26
Adapter Selection Guide	28
Molded Straight and Y Adapters	29
Marine Isolation Transformers	
Features and Benefits	30
Isolation Transformers	31
Product Dimensions	31
Telephone and Cable TV Devices	32

Product	Page
30A 28V DC Rated	34
12V DC Rated Switches	35
15A Twist-Lock® and Straight Blade Devices	36
20A Twist-Lock® and Straight Blade Devices	38
Circuit Testers	40
USB Charger Receptacles	41
GFCI and Portable Ground Fault Circuit Interrupters	42
Inside the Boat	
Receptacles	43
Switches and Weatherproof Switch Plates	44
Wallplates	45
Communication Frames and Connectors	46
Boatyard Accessory Items	
Non-Metallic While-In-Use Weatherproof Covers	47
Stainless Steel Lift Covers	48
Marine Grade Lift Covers	49
Marine Grade Dockside Boxes and Covers	50
Lighting Fixtures and Cord Connectors	51
Codes and Specifications	52
Catalog Number Index	53



## Hubbell Marine 100 Amp Pin & Sleeve

The Best Just Got Better.....Page 20

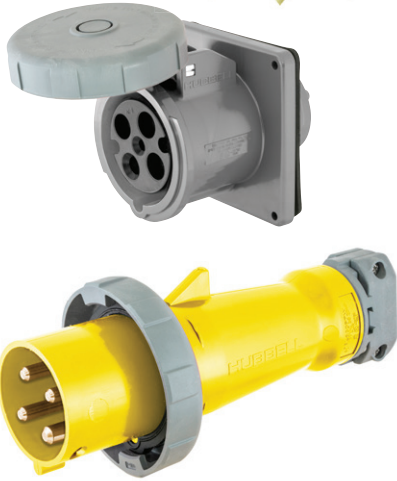

Hubbell Marine was the first to offer 100 amp marine grade devices that are considered second to none. Hubbell developed the standard for 100 amp pin and sleeve devices with the National Electric Code and the American Boat and Yacht Council.

### 100 Amp Pin and Sleeve Devices

#### Improved Features:

- UL Type 4X and IP69k Rated
- Compact and durable cap hinge is fully shrouded and protected
- VO flammability rating
- UV stabilized, impact resistant and chemical resistant housing to withstand the harshest environments

## Hubbell Marine Isolation Transformers

Constant Clean Safe Power.....Page 30



#316 Stainless Steel Housing with Auto-Boost



Standard White Powder Coated Steel Housing

- Protects sensitive equipment on board from fluctuating or low voltage
- Converts various dockside power, such as 208 volt systems to the 120/240 volts needed on board
- Greatly reduces the possibility of stray current from your boat from leaking into the water, known as Electrical Shock Drowning (ESD)

#### Available Options:

- 15 kVA and 25 kVA Models
- 60 Hz and 50/60 Hz Models
- 12.5% Auto-Boost
- White Powder Coated Steel Housing (Non-Boost Only)
- #316 Stainless Steel Housing (with and without Auto-Boost)

#### Additional Features

- Compact Size and Weight
- Two Full Current-Carrying Shields
- Vibration Resistant
- Exceeds ABYC's 4000 Volt HIPOT Test
- Full Capacity Taps = 1:1 Voltage Ratio

**USB Charger Receptacles with Type-C**

**Charge Faster with Hubbell** .....Page 41

The smaller size USB Type-C connection will replace the traditional larger Type A connection

Now, with 5 amps of fast charging power  
 Available in standard tamper-resistant version and in weather resistant versions

USB Type-C connection is:

- Smaller, 24 pin configuration
- More robust for reliable connection
- Quicker, simply plug in your cord



Type-C



Type A&C



Type A

**New Hubbell Weather Resistant and Extra Heavy Duty Corrosion Resistant Ground Fault Receptacles** .....Page 42

**Ground Fault Receptacle Features:**

Hubbell's Weather Resistant offering:

- Meets NEC requirements for weather resistant, UV and corrosion resistance for harsh and damp locations
- Protects against line and load reversal

Extra heavy duty ground fault receptacles are designed to withstand the most demanding environments and applications:

- Nickel plated face contacts, mounting strap and terminals
- Stainless steel hardware
- Tamper and weather resistant make this the only corrosion resistant ground fault receptacle available



Weather Resistant



Extra Heavy Duty Corrosion Resistant

**Stainless Steel Weatherproof and Watertight Flip Covers**

**Flip Cover Features** .....Page 48

- Heavy duty #316 stainless steel covers provide superior corrosion resistance while maintaining their smooth, polished finish
- Available in rain-tight or watertight, duplex and GFCI versions
- Horizontal or vertical mounting positions
- UL and cUL listed



# Ship-to-Shore Selection Chart - Boatside

## Ship-to-Shore Selection Chart - Boatside

**30A  
125V AC  
2 Pole  
3 Wire**

Pages 8 to 12



HBL303NM



HBL303SS



HBL26CM13



HBL60CM33  
HBL60CM33W

**50A  
125V AC  
2 Pole  
3 Wire**

Pages 13 to 15



HBL503NM



HBL503SS



HBL63CM60



HBL77CM15  
HBL77CM15W

**50A  
125/250V AC  
3 Pole  
4 Wire**

Pages 16 and 17



HBL504NM



HBL504SS



HBL63CM64



HBL77CM15  
HBL77CM15W

**100A  
125/250V AC  
3 Pole  
4 Wire**

Pages 18 to 20



M4100B12R



M4100C12R

**100A  
3ØY  
4 Pole  
5 Wire**

Page 21  
120/208V AC  
277/480V AC



M5100B9R  
M5100B7R



M5100C9R  
M5100C7R

**200A  
600V AC/250V DC  
50-400 Hertz  
4 Pole  
5 Wire**

Pages 22 and 23



M5200BS1R



M5200CS1R

**Portable  
Telephone and  
Cable TV  
Devices**

Pages 32 and 33



HBLPHTVNM



HBLPHTVSS



HBLTVSS



PH6624



PH7440



# Ship-to-Shore Selection Chart - Dockside

## Ship-to-Shore Selection Chart - Dockside

	<p><b>YC310250</b> - 280' (85.3m) Yellow cable only.  <b>WC310280</b> - 280' (85.3m) White cable only.</p>				
<p><b>HBL61CM08 &amp; HBL61CM08LED</b> - 50' (15.2m)  <b>HBL61CM05 &amp; HBL61CM05LED</b> - 35' (10.7m)  <b>HBL61CM03 &amp; HBL61CM03LED</b> - 25' (7.6m)  <b>HBL61CM08W &amp; HBL61CM08WLED</b> - 50' (15.2m)  <b>HBL61CM03W &amp; HBL61CM03WLED</b> - 25' (7.6m)</p>		<p><b>HBL60CM31</b>  <b>HBL60CM31W</b></p>	<p><b>HBL26CM11</b></p>	<p><b>HBL26CM10</b></p>	<p><b>HBL74CM25WOA</b>  <b>HBL74CM25WOAW</b></p>
	<p><b>YC306250</b> - 250' (76.2m) Yellow cable only.</p>				
<p><b>HBL61CM53 &amp; HBL61CM53LED</b> - 50' (15.2m)  <b>HBL61CM43 &amp; HBL61CM43LED</b> - 25' (7.6m)</p>		<p><b>HBL77CM16</b>  <b>HBL77CM16W</b></p>	<p><b>HBL63CM61</b></p>	<p><b>HBL63CM70</b></p>	<p><b>HBL77CM74WO</b></p>
	<p><b>YC406250</b> - 250' (76.2m) Yellow cable only.</p>				
<p><b>HBL61CM52 &amp; HBL61CM52LED</b> - 50' (15.2m)  <b>HBL61CM42 &amp; HBL61CM42LED</b> - 25' (7.6m)  <b>HBL61CM52W &amp; HBL61CM52WLED</b> - 50' (15.2m)  <b>HBL61CM42W &amp; HBL61CM42WLED</b> - 25' (7.6m)</p>		<p><b>HBL77CM16</b>  <b>HBL77CM16W</b></p>	<p><b>HBL63CM65</b></p>	<p><b>HBL63CM69</b></p>	<p><b>HBL77CM74WO</b></p>
	<p><b>CS1004</b> - 100' (30.4m) 4-Wire  <b>CS754</b> - 75' (22.8m) 4-Wire  <b>CS100IT4</b> - 100' (30.4m) 3-Wire  <b>CS75IT4</b> - 75' (22.8m) 3-Wire</p>				
<p><b>CW125IT4</b> - 125' (38.0m) One-ended cable set for winches.  <b>CW100IT4</b> - 100' (30.4m) One-ended cable set for winches.  <b>CW754</b> - 75' (22.8m) One-ended cable set for winches.  <b>CS50EXT4</b> - 50' (15.2m) Extension cord.</p>		<p><b>M4100P12</b></p>	<p><b>M4100C12</b></p>	<p><b>M4100R12</b></p>	
	<p><b>CS100IT5</b> - 100' (30.4m) 4-Wire  <b>CS75IT5</b> - 75' (22.8m) 4-Wire</p>				
<p><b>CW125IT5</b> - 125' (38.0m) One-ended cable set for winches.  <b>CW100IT5</b> - 100' (30.4m) One-ended cable set for winches.  <b>CS50EXT5</b> - 50' (15.2m) Extension cord.</p>		<p><b>M5100P9</b>  <b>M5100P7</b></p>	<p><b>M5100C9</b>  <b>M5100C7</b></p>	<p><b>M5100R9</b>  <b>M5100R7</b></p>	
					
<p><b>M5200PS1</b></p>		<p><b>M5200CS1</b></p>	<p><b>M5200RS1</b></p>		
	<p><b>PH6630</b> - 250' (76.2m) Yellow cable only.  <b>PH6599</b> - 50' (15.2m)  <b>PH6598</b> - 25' (7.6m)</p>				
<p><b>75 Ohm TV Cable</b>  <b>TV99</b> - 50' (15.2m)  <b>TV98</b> - 25' (7.6m)  <b>TV99W</b> - 50' (15.2m)  <b>TV98W</b> - 25' (7.6m)</p>		<p><b>PH7440</b></p>	<p><b>PH6625</b></p>	<p><b>PH6596</b></p>	<p><b>TV97</b>  <b>PH6597TV</b></p>

# Marine Products

## ELCI Interface Solutions

30 Amp and 50 Amp

### ELCI Interface Solutions

#### ABYC Code Requirements

Hubbell Marine Electrical continues its tradition of innovation by developing a simple, flexible method of adapting a variety of ELCI Sensors and Breakers to our traditional Stainless Steel and Non-Metallic Shore Power Inlet Housings.

Effective July 31, 2012, ABYC, E-11.11.1 requires that "An Equipment Leakage Circuit Interrupter (ELCI) shall be installed with or in addition to the main shore power disconnect circuit breaker(s) or at the additional over current protection as required by E-11.10.2.8.3, whichever is closer to the shore power connection".

*Note: A faulty electrical connection at the dock or on a boat could result in stray electrical current in the water. Such stray current in Electrical Shock Drowning (ESD).*

**Hubbell's family of ELCI adaptive Shore Power Inlet Kits provide a simple, flexible, low-cost solution.**

#### Kits Contain:

- Hubbell Shore Power Inlet
- Matching Shore Power Inlet Housing(s)
- Mounting Adapter Plate(s) for use with various ELCI Sensors and ELCI Breakers (not provided)
- Stainless Steel Hardware



An Equipment Leakage Circuit Interrupter (ELCI) provides 30mA ground fault protection for the entire AC shore power system beyond the ELCI



# Marine Products ELCI Interface Solutions

30 Amp and 50 Amp

## ELCI Interface Solutions

### Hubbell ELCI Adapter Kits for North Shore Safety, Ltd® PGFM Series (ELCI Marine) Sensing Module and Sensata Technologies® ELCI Breakers

Description	Breaker	Sensor	Power Inlet	Catalog Number
30 Amp, 125 Volt Non-Metallic Inlet (HBL303NM) and (2) Non-Metallic Inlet Housings, Adapter Plates and Hardware.				<b>HBL303NMELCI</b>
30 Amp, 125 Volt Non-Metallic Inlet (HBL303NM) and (1) Non-Metallic Inlet Housing that adapts to North Shore Safety's Sensor only (no circuit breaker inlet housing), Adapter Plate and Hardware.				<b>HBL303NMELCIS</b>
30 Amp, 125 Volt Stainless Steel Inlet (HBL303SS) and (2) Stainless Steel Inlet Housings, Adapter Plates and Hardware.				<b>HBL303SSELCI</b>
30 Amp, 125 Volt Stainless Steel Inlet (HBL303SS) and (1) Stainless Steel Inlet Housing that adapts to North Shore Safety's Sensor only (no circuit breaker inlet housing), Adapter Plate and Hardware.				<b>HBL303SSELCIS</b>
50 Amp, 125/250 Volt Stainless Steel Inlet (HBL504SS) and (2) Stainless Steel Inlet Housings, Adapter Plates and Hardware.				<b>HBL504SSELCI</b>
50 Amp, 125/250 Volt Stainless Steel Inlet (HBL504SS) and (2) Stainless Steel Inlet Housing that adapts to a standard overcurrent-type circuit breaker.				<b>HBL504SSELCIH</b>
Blank Non-Metallic Inlet Housing and Hardware for mounting North Shore Safety ELCI Sensor only.				<b>HBLRRELCI</b>

Note: North Shore Safety's Sensor and Sensata Technologies Circuit Breakers (not provided) are separate devices each requiring their own blank shore power inlet interface.

# Marine Products

## 30 Amp, 125 Volt Cable Set

2 Pole, 3 Wire



Cable sets only.

### 30A Ship-to-Shore Devices

#### 30 Amp Cable Sets

- Bright, durable, LED (green) indicates “Power-ON”
- High intensity LED is visible—even in bright sunlight
- Totally molded design for superior waterproofing and durability
- Exclusive copper crimp barrel terminations for tighter connections and longer life
- Marine UL and cUL Listed



Note: Cable sets must be fully extended before using.

#### Features and Benefits



##### Housing Design

- New improved ergonomic styling
- Line-up notches to indicate: Locked - Unlocked
- Arrow indicating lock or unlock position
- Available in yellow or white colors



##### Interior Design

- Molded design totally encased in solid PVC material, for superior waterproofing and durability
- Locking ring assures proper alignment of connector to inlet for complete contact and waterproofing; prevents accidental disengagement



##### Safety

- Bright green LED indicates “Power-ON”

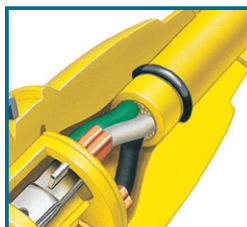

##### Interior Design

- Strain relief bull ring protects against stress and strain on the conductors caused by boat movement, crew traffic and rough handling
- Exclusive copper crimp barrel termination provides protection against internal overheating as well as additional strain relief

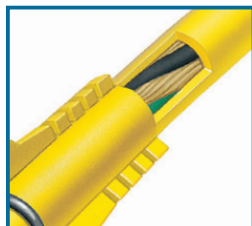

##### Cord Flexibility

- Molded flexneck adds life to cable set by helping to prevent right-angle cable damage and pullout
- Jute fillers inside jacket for maximum cable flexibility; Hubbell cable coils neater, lighter and lays flatter; particularly in colder climates



##### Cable Set Options

- Available in 50, 35 and 25 foot lengths
- Available with or without LED
- Available in UV resistant yellow or white
- Marine UL and cUL Listed

## 30A Ship-to-Shore Devices

### 30 Amp Cable Sets and Bulk Cable

Our 30A 125V cable set is packed with high performance details from end to end that make a real difference. Completely factory pre-wired with molded-on devices. Designed to coil easily and lay flat.

**IP55**  
SUITABILITY  
(Boatside)



### 30A 125V Cable Sets and Bulk Cable

Description	Catalog Number
Yellow 50 ft. (15.2m) vinyl jacketed shore power cable set. #10 AWG is factory pre-wired with molded-on devices. Connector end has non-metallic threaded sealing ring which makes inlet/connector interface watertight.	<b>HBL61CM08</b>
Same as HBL61CM08 except 35 ft. (10.7m) in length.	<b>HBL61CM05</b>
Same as HBL61CM08 except 25 ft. (7.6m) in length.	<b>HBL61CM03</b>
Same as HBL61CM08 except in white in color.	<b>HBL61CM08W</b>
Same as HBL61CM05 except in white in color.	<b>HBL61CM05W</b>
Same as HBL61CM03 except in white in color.	<b>HBL61CM03W</b>

Note: See page 8 for features and benefits.



**HBL61CM08  
HBL61CM05  
HBL61CM03**



**HBL61CM08W  
HBL61CM05W  
HBL61CM03W**

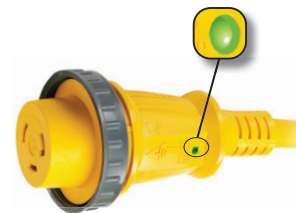

### 30A Cable Sets with LED “Power-ON” Indicator

Description	Catalog Number
Yellow 50 ft. (15.2m) vinyl jacketed shore power cable set. #10 AWG is factory pre-wired with molded-on devices. Connector end has non-metallic threaded sealing ring which makes inlet/connector interface watertight.	<b>HBL61CM08LED</b>
Same as HBL61CM08LED except 35 ft. (10.7m) in length.	<b>HBL61CM05LED</b>
Same as HBL61CM08LED except 25 ft. (7.6m) in length.	<b>HBL61CM03LED</b>
Same as HBL61CM08LED except in white in color.	<b>HBL61CM08WLED</b>
Same as HBL61CM05LED except in white in color.	<b>HBL61CM05WLED</b>
Same as HBL61CM03LED except in white in color.	<b>HBL61CM03WLED</b>

Note: See page 8 for features and benefits.



**HBL61CM08LED  
HBL61CM05LED  
HBL61CM03LED**

### Accessories

Description	Catalog Number
Yellow 250 ft. (76.2m) three conductor, #10 AWG type STW, PVC jacketed portable cord with jute fillers for added flexibility. Ideal for making cable sets, extension cord, and adapters that will not mark boat’s deck. 250 ft. (76.2m) lengths only.	<b>YC310250</b>
White 280 ft. (85.3m) three conductor, #10 AWG type STW, PVC jacketed portable cord with jute fillers for added flexibility. Ideal for making cable sets, extension cord, and adapters that will not mark boat’s deck. 280 ft. (85.3m) lengths only.	<b>WC310280</b>
Replacement non-metallic sealing ring for 30A cable sets and boots.	<b>RPL30P*</b>

Note: \*Not UL Listed.

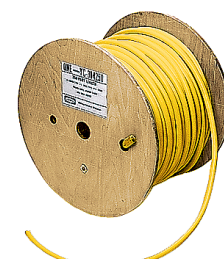

**YC310250**



**RPL30P**



## 30A Ship-to-Shore Devices

### 30 Amp 125 Volt Shore Power Inlets and Outlet

Traditional, stainless steel shore power inlet has easy-to-wire terminations. Interior is transparent for quick and easy visual inspection. Interior is shielded from the elements by a gasketed, self-closing cover, watertight when cover is screwed in place. Mounting holes are 2.38 in. (60.3) on centers. Mounting screws and gasket included. Protective rear enclosure/strain relief also included.

- Friction tight self-closing cover assures the interior is shielded from the elements when the inlet is not in use
- Neoprene gasket on underside of cover. For sealing when the cover is closed
- Mirror stainless steel finish for superior appearance



### Features and Benefits



#### Housing Design

- Base and cover are #316 type stainless steel for strength and corrosion resistance
- Threaded base for making a watertight seal; when in use, it mates to the threaded ring of the weatherproof cover on the connector body; when not in use, it mates to the threaded cover

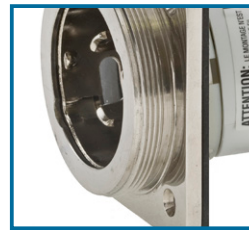

#### Interior Design

- Contact blades are nickel plated brass for corrosion resistance
- Mounting holes are 2.38 in. (60.3) on center
- Polycarbonate interior has superior heat resistance



HBL303NM



#### Terminations

- Easy-to-wire interior is transparent for quick, visual inspection of terminations
- #SR3050 protective rear enclosure cap attaches to contact carrier with 3 screws



HBLCBISS



HBLCBINM



HBL303SSO

### 30A 125V Twist-Lock® Devices

Description	Catalog Number
Stylized UV resistant non-metallic shore power inlet has white Centrex® cover which makes unit weatherproof when completely closed. Interior has easy-to-wire terminations and is transparent for quick and easy visual inspection. Mounting holes are 2.38 in. (60.3) on centers and match existing mounting patterns. Mounting screws and gasket included. Protective rear enclosure/strain relief also included. <b>IP55 SUITABILITY.</b>	<b>HBL303NM</b>
Traditional, stainless steel shore power inlet has easy-to-wire terminations. Interior is transparent for quick and easy visual inspection. Interior is shielded from the elements by a gasketed, self-closing cover, watertight when cover is screwed in place. Mounting holes are 2.38 in. (60.3) on centers. Mounting screws and gasket included. Protective rear enclosure/strain relief also included. <b>IP56 SUITABILITY.</b>	<b>HBL303SS</b>
Traditional stainless steel inlet housing; blank for attaching a circuit breaker (not included). Mounting hardware for Carling series breakers included. <b>IP56 SUITABILITY.</b>	<b>HBLCBISS</b>
Stylized non-metallic inlet housing; blank for attaching a circuit breaker (not included). Mounting hardware for Carling series breakers included. <b>IP55 SUITABILITY.</b>	<b>HBLCBINM</b>
Protective rear cover. Fits all 30A shore power inlets. Secures to back of inlets with three screws which are provided.	<b>SR3050*</b>
Replacement interior for HBL303SS and 60CM61 shore power inlets.	<b>HBL303INT</b>
Traditional stainless steel power outlet has gasketed, self-closing cover, watertight when cover is screwed in place. Mounting holes are 2.38 in. (60.3) on centers. Mounting screws and gasket included. <b>IP56 SUITABILITY.</b>	<b>HBL303SSO</b>
Nickel plated brass adapter plate for mounting 30A traditional style shore power inlets and outlets to FS/FD box.	<b>HBL60CM75</b>

Note: \*Not UL Listed or CSA Certified.

Centrex® is a registered trademark of LANXESS Corporation.

## 30A Ship-to-Shore Devices



### 30A 125V Twist-Lock® Devices

Description	Catalog Number
Yellow Insulgrip® plug has rugged nylon housing and cord grip with range of .36-.93 in. (9-24) that utilizes a unique offset jaws arrangement to provide secure strain relief. <b>IP20 SUITABILITY.</b>	<b>HBL26CM11</b>
Yellow Insulgrip connector body has rugged nylon housing and cord grip with range of .36-.93 in. (9-24) that utilizes a unique offset jaws arrangement to provide secure strain relief.	<b>HBL26CM13</b>
Yellow single receptacle has Rynite® body and abuse resistant nylon face. <b>IP20 SUITABILITY.</b>	<b>HBL26CM10</b>



HBL26CM11



HBL26CM13

### Boots and Weatherproof Plates

Description	Catalog Number
Yellow Seal-Tite® cover for weatherproofing HBL26CM11 plugs. <b>IP44 SUITABILITY.</b> Note: Fits Insulgrip devices only.	<b>HBL60CM31+</b>
White Seal-Tite cover for weatherproofing HBL26CM11 plugs. <b>IP44 SUITABILITY.</b> Note: Fits Insulgrip devices only.	<b>HBL60CM31W+</b>
Yellow Seal-Tite cover for weatherproofing HBL26CM13 connector bodies when used with shore power inlets. Threaded sealing ring makes connection watertight. Also for weatherproofing HBL26CM11 plug when used with HBL303SSO power outlet. <b>IP56 SUITABILITY.</b> Note: Fits Insulgrip devices only.	<b>HBL60CM33+</b>
White Seal-Tite cover for weatherproofing HBL26CM13 connector body when used with shore power inlets. Threaded sealing ring makes connection watertight. Also for weatherproofing HBL26CM11 plug when used with HBL303SSO power outlet. <b>IP56 SUITABILITY.</b> Note: Fits Insulgrip devices only.	<b>HBL60CM33W+</b>
Yellow Seal-Tite cover for weatherproofing HBL26CM13 connector bodies when used on extension cords or adapters. <b>IP44 SUITABILITY.</b> Note: Fits Insulgrip devices only.	<b>HBL60CM32+</b>
Yellow polycarbonate spring-loaded lift cover for weather-proofing old style 26CM10 receptacle. Meets the most stringent requirements of UL's three listing categories for weatherproof plates. Stainless steel screws and neoprene gasket included for mounting to FS/FD type weatherproof boxes. <b>IP44 SUITABILITY.</b>	<b>HBL74CM24WO**</b>
Same as HBL74CM24WO except gray in color. <b>IP44 SUITABILITY.</b>	<b>HBL7424WO**</b>
Yellow polycarbonate spring-loaded lift cover for weather-proofing HBL26CM10 receptacle. Meets the most stringent requirements of UL's three listing categories for weatherproof plates. Stainless steel screws and neoprene gasket included for mounting to FS/FD type weatherproof boxes. <b>IP44 SUITABILITY.</b>	<b>HBL74CM25WOA**</b>
Same as HBL74CM25WOA except white in color. <b>IP44 SUITABILITY.</b>	<b>HBL74CM25WOAW</b>
Same as HBL74CM25WOA except gray in color. <b>IP44 SUITABILITY.</b>	<b>HBL7425WOA**</b>
Stainless steel wall plate for old 26CM10.	<b>SS725</b>
Stainless steel wall plate for new HBL26CM10.	<b>SS720</b>



HBL26CM10



HBL60CM31



HBL60CM33



HBL74CM25WOA



HBL74CM25WOAW



SS725



HBL60CM32

Note: \*Boots are not UL Listed or CSA Certified.  
\*\*See page 49 for additional weatherproof plates.

Rynite® is a registered trademark of E. I. DuPont.

## 30 Amp Valise® Devices

A unique system of special locking lugs interlock the blade holder and sides as the plug is closed. These load bearing lugs provide strength and security and keep the Valise intact.

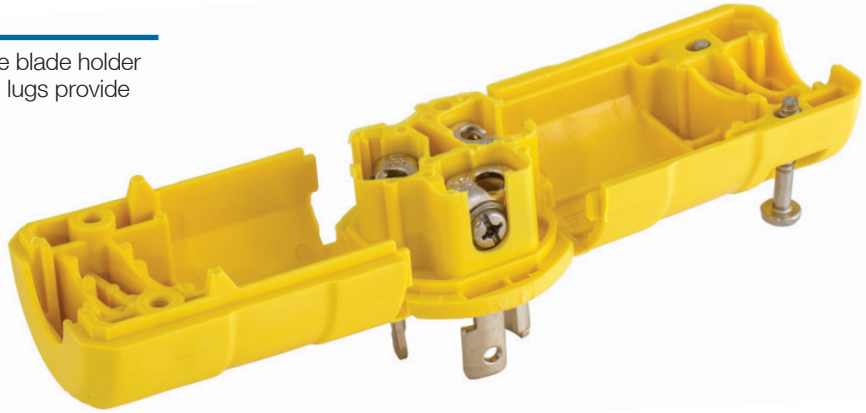

## Features and Benefits

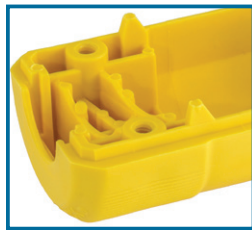

### Housing Design

- Nylon body
- Wiring time is reduced. Large easy to wire clamp type terminals eliminate the need to wrap conductors around a screw

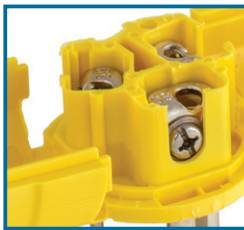

### Interior Design

- Exclusive nylon webs are provided to make wiring quick and easy by joining the three sections together during assembly
- Powerful cord grips resist conductor slip and strain on wiring terminals
- Nickel plated brass contacts for corrosion resistance

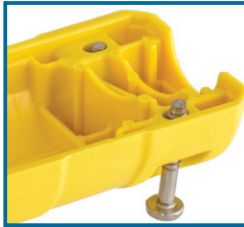

### Terminations

- Terminals provide a superior electrical connection by "bundling" the conductors when the clamps are tightened
- Two captive stainless steel assembly screws



HBL26CM11V



HBL26CM11VB



HBL26CM13V



HBL60CM31V

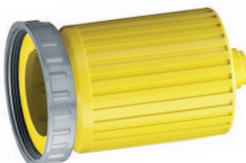

HBL60CM33V



## 30A 125V Twist-Lock® Devices

Description	Catalog Number
Yellow Valise® plug has one-piece nylon housing and assembles easily with two screws. Built-in cord grip has range of .59-.93 in. (15.0-23.6). <b>IP20 SUITABILITY.</b>	<b>HBL26CM11V</b>
Black Valise plug for use on bass boats with trolling motor. One-piece nylon housing assembles easily with two screws. Built-in cord grip has a range of .59-.93 in. (15.0-23.6). <b>IP20 SUITABILITY.</b>	<b>HBL26CM11VB</b>
Yellow Valise connector body has a one-piece nylon housing and assembles easily with two screws. Built-in cord grip has range of .59-.93 in. (15.0-23.6). <b>IP20 SUITABILITY.</b>	<b>HBL26CM13V</b>

## Boots and Replacement Parts

Description	Catalog Number
Yellow Seal-Tite® cover for weatherproofing HBL26CM11V plugs. <b>IP44 SUITABILITY.</b> Note: Fits Valise devices only.	<b>HBL60CM31V**</b>
Yellow Seal-Tite cover for HBL26CM13V connector body when used with shore power inlets. Threaded sealing ring makes connection watertight. <b>IP56 SUITABILITY.</b> Note: Fits Valise devices only.	<b>HBL60CM33V**</b>
Yellow Seal-Tite cover for weatherproofing HBL26CM13V connector bodies when used on extension cords or adapters. <b>IP44 SUITABILITY.</b> Note: Fits Valise devices only.	<b>HBL60CM32V**</b>
Replacement non-metallic sealing ring for 30A cable sets and boots. Not UL listed.	<b>RPL30P*</b>

Note: \*\*Not UL Listed or CSA Certified.  
\*Not UL Listed.



## 50 Amp Cable Sets

- Two bright and durable LEDs. GREEN indicates “Power-ON” and RED indicates “Incorrect Wiring” at the power source
- High intensity LEDs are visible—even in bright sunlight
- Totally molded design for superior waterproofing and durability
- Exclusive copper crimp barrel terminations for tighter connections and longer life
- Marine UL and cUL Listed



Note: Cable sets must be fully extended before using.

## Features and Benefits



### Housing Design

- New improved ergonomic styling
- Line-up notches to indicate: Locked - Unlocked
- Stainless steel threaded sealing ring to provide a watertight seal when mated with the shore power inlet
- Nickel plated brass shell for positive alignment of keying and corrosion-resistance

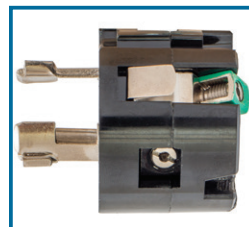

### Interior Design

- Thermoset contact carrier is arcing and heat resistant
- Nickel plated brass contact blades for corrosion-resistance



### Safety

- Arrow with ground symbol allows lining up with ground of receptacle
- Bright green LED indicates “Power-ON”; Bright red LED indicates “Incorrect Wiring” at the power source



### Superior Termination

- Bull ring for strain relief on the terminals
- Exclusive copper crimp barrel termination provides protection against internal overheating and burnout compared to brass crimps

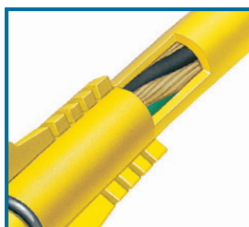

### Cord Flexibility

- Molded-in flex feature controls the angle of cord entry and keeps water out
- Jute fillers inside jacket for maximum cable flexibility; Hubbell cable coils neater, lighter and lays flatter



### Cable Set Options

- Available in 50 and 25 foot lengths
- Available in yellow or white
- Cords for winch systems available upon request
- Marine UL and cUL Listed

## 50A Ship-to-Shore Devices

### 50 Amp 125 Volt Traditional Stainless Steel Inlets

Traditional stainless steel shore power inlet has gasketed, self-closing cover so interior is shielded from the elements when not in use. Watertight when cover is securely fastened. Mounting holes are 2.38 in. (60.3) on centers and rear portion has 2.17 in. (55.1) diameter. Mounting screws and gasket included.

- Self-closing cover is friction tight to remain open while engaging cable set and shields the interior from the elements when the inlet is not in use
- Neoprene gasket on underside of cover, for sealing when the cover is closed



## Features and Benefits



### Housing Design

- Base and cover are #316 type stainless steel for strength and corrosion resistance
- Threaded base for making a watertight seal; when in use, it mates to the threaded ring of the weatherproof cover on the connector body; when not in use, it mates to the threaded cover

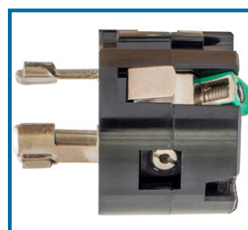

### Interior Design

- Contact blades are nickel plated brass for corrosion resistance
- Pressure screw terminals for secure terminations clearly marked for easy identification
- Thermoset contact carrier is arcing and heat resistant



HBL503NM



### Terminations

- Three screws "lock-in" the interior once it is in place
- Rear enclosure is nickel plated for corrosion resistance



50A 125V

## 50A 125V Twist-Lock® Devices

### Description

Stylized non-metallic shore power inlet has UV resistant white Centrex® cover which makes unit weatherproof when completely closed. Interior has easy to wire terminals. Mounting holes are 2.38 in. (60.3) on centers and match existing mounting patterns. Mounting screws and gasket included. **IP55 SUITABILITY.**

Traditional stainless steel shore power inlet has gasketed, self-closing cover so interior is shielded from the elements when not in use. Watertight when cover is securely fastened. Mounting holes are 2.38 in. (60.3) on centers and rear portion has 2.17 in. (55.1) diameter. Mounting screws and gasket included. **IP56 SUITABILITY.**

Nickel plated brass connector body has heat resistant thermoset interior and combination metal and rubber cord grip provides superior strain relief capability. Cord grip range is .44-1.14 in. (11.1-29.0). **IP20 SUITABILITY.**

### Catalog Number

**HBL503NM**

**HBL503SS**

**HBL63CM60**



HBL63CM60



HBL77CM15



HBL77CM17

## Boots and Replacement Parts

### Description

Protective rear cover. Fits all inlets except HBL503SS. Secures to back of inlets with three screws which are provided.

Replacement interior for HBL503SS and 63CM72 shore power inlets.

Yellow Seal-Tite® cover for connector bodies when used with 50A shore power inlets. Threaded sealing ring makes connections watertight. **IP56 SUITABILITY.**

White Seal-Tite cover for connector bodies when used with 50A shore power inlets. Threaded sealing ring makes connections watertight. **IP56 SUITABILITY.**

Nickel plated brass cord clamp assembly with clamp range of .44-1.14 in. (11.1-29.0) provides strain relief for terminations on shore power inlets.

Yellow Seal-Tite cover for weatherproofing 50A connector bodies on extension cords or adapters. **IP56 SUITABILITY.**

### Catalog Number

**SR3050\*\***

**CR16277**

**HBL77CM15\*\***

**HBL77CM15W\*\***

**HBL77CM67**

**HBL77CM17\*\***

Note: \*\*Not UL Listed or CSA Certified.

Centrex® is a registered trademark of LANXESS Corporation.

## 50A Ship-to-Shore Devices

### 50 Amp 125 Volt Cable Sets and Bulk Cable

Our 50A 125V cable set is packed with high performance details from end to end that make a real difference. Completely factory pre-wired with molded-on devices. Designed to coil easily and lay flat.

**IP56**  
SUITABILITY  
(Boatside)



**HBL61CM53**  
**HBL61CM43**

### 50A 125V Cable Sets and Twist-Lock® Devices

Description	Catalog Number
Yellow 50 ft. (15.2m) vinyl jacketed shore power cable set. #6 AWG type STOW is completely factory pre-wired with molded-on devices. Connector end has threaded metallic sealing ring to make inlet/connector interface watertight. <b>IP54 SUITABILITY (BOATSIDE).</b>	<b>HBL61CM53</b>
Same as HBL61CM53 except with two high intensity LEDs.	<b>HBL61CM53LED</b>
Same as HBL61CM53 except 25 ft. (7.6m) in length.	<b>HBL61CM43</b>
Same as HBL61CM43 except with two high intensity LEDs.	<b>HBL61CM43LED</b>
Three conductor, #6 AWG type STOW, yellow PVC jacketed portable cord with jute fillers for added flexibility. Ideal for making cable sets, extension cords and adapters will not mark boat's deck. 250 ft. (75.2m) lengths only.	<b>YC306250</b>
Nickel plated brass plug has heat resistant thermoset interior and combination metal and rubber cord grip, provides superior strain relief capability. Cord grip range is .44–1.14 in. (11.1–29.0). <b>IP20 SUITABILITY.</b>	<b>HBL63CM61*</b>
Single receptacle has a heat-resistant thermoset base. <b>IP20 SUITABILITY.</b>	<b>HBL63CM70*</b>



**HBL61CM53LED**  
**HBL61CM43LED**



**HBL63CM61**

Note: \*UL Listed and CSA Certified.  
See page 13 for features and benefits.

### Boots and Weatherproof Plates

Description	Catalog Number
Yellow Seal-Tite® cover for weatherproofing 50A plugs. <b>IP55 SUITABILITY.</b>	<b>HBL77CM16**</b>
White Seal-Tite cover for weatherproofing 50A plugs. <b>IP55 SUITABILITY.</b>	<b>HBL77CM16W**</b>
Yellow Valox® lift cover for weatherproofing 50A receptacles. Meets requirements of the most stringent of UL's three listing categories for weatherproof plates. Stainless steel screws and a neoprene gasket included. For mounting to FS/FD type weatherproof boxes. <b>IP44 SUITABILITY.</b>	<b>HBL77CM74WO</b>
Same as HBL77CM74WO except gray in color. <b>IP44 SUITABILITY.</b>	<b>HBL774WO</b>
Stainless steel wall plate for 50A receptacle.	<b>SS750</b>

Note: \*\*Not UL Listed or CSA Certified.



**HBL63CM70**



**HBL77CM16**



**HBL77CM74WO**



**HBL774WO**



**SS750**



**HBL77CM16W**

Valox® is a trademark of SABIC Innovative Plastics, acquired from General Electric Company.

## 50A Ship-to-Shore Devices

### 50 Amp 125/250 Volt Traditional Stainless Steel Inlets

Traditional stainless steel shore power inlet has gasketed, self-closing cover so interior is shielded from the elements when not in use. Watertight when cover is securely fastened. Mounting holes are 2.38 in. (60.3) on centers and rear portion has 2.17 in. (55.1) diameter. Mounting screws and gasket included.

- Self-closing cover is friction tight to remain open while engaging cable set and shields the interior from the elements when the inlet is not in use
- Neoprene gasket on underside of cover; for sealing when the cover is closed



## Features and Benefits



### Housing Design

- Base and cover are #316 type stainless steel for strength and corrosion resistance
- Threaded base for making a watertight seal; when in use, it mates to the threaded ring of the weatherproof cover on the connector body; when not in use, it mates to the threaded cover

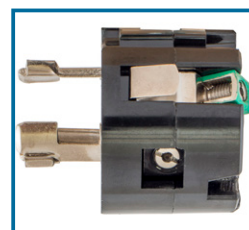

### Interior Design

- Contact blades are nickel plated brass for corrosion resistance
- Pressure screw terminals for secure terminations clearly marked for easy identification
- Thermoset contact carrier is arcing and heat resistant



HBL504NM



### Terminations

- Three screws "lock-in" the interior once it is in place
- Rear enclosure is nickel plated for corrosion resistance



50A  
125/250V  
UL/CSA

## 50A 125/250V Twist-Lock® Devices

### Description

Stylized non-metallic shore power inlet has UV resistant white Centrex® cover which makes unit weatherproof when completely closed. Interior is heat resistant thermoset material and has box lug terminals. Mounting holes are 2.38 in. (60.3) on centers and match existing mounting patterns. Mounting screws and gasket included. **IP55 SUITABILITY.**

### Catalog Number

HBL504NM



HBL63CM64

Traditional stainless shore power inlet has gasketed, self-closing cover so that the interior is shielded from the elements when not in use. It is watertight when the cover is securely fastened. The mounting holes are 2.38 in. (60.3) on centers and the rear portion has a 2.17 in. (55.1) diameter. Mounting screws and gasket are included. **IP56 SUITABILITY.**

HBL504SS

Nickel plated brass connector body has a heat resistant thermoset interior and combination metal and rubber cord grip, which provides superior strain relief capability. Cord grip range is .44-1.14 in. (11.1-29.0). **IP20 SUITABILITY.**

HBL63CM64



HBL77CM15

## Boots and Weatherproof Plates

### Description

Protective rear cover. Fits all inlets except HBL504SS. Secures to back of inlets with three screws which are provided.

### Catalog Number

SR3050\*\*

Replacement interior for 63CM74 and HBL504SS power inlets.

CR16279\*\*

Yellow Seal-Tite® cover for connector bodies when used with 50A shore power inlets. Threaded sealing ring makes connections watertight. **IP56 SUITABILITY.**

HBL77CM15\*\*

White Seal-Tite cover for connector bodies when used with 50A shore power inlets. Threaded sealing ring makes connections watertight. **IP56 SUITABILITY.**

HBL77CM15W\*\*

Yellow Seal-Tite cover for weatherproofing 50A connector bodies on extension cords or adapters. **IP55 SUITABILITY.**

HBL77CM17\*\*



HBL77CM17

Nickel plated brass cord clamp assembly with clamp range of .44-1.14 in. (11.1-29.0) provides strain relief for terminations on shore power inlets.

HBL77CM67

Note: \*\*Not UL Listed or CSA Certified.

Centrex® is a registered trademark of LANXESS Corporation.

## 50A Ship-to-Shore Devices

### 50 Amp 125/250 Volt AC Cable Sets and Bulk Cable

Our 50A 125/250V AC cable set is packed with high performance details from end to end that make a real difference. Completely factory pre-wired with molded-on devices. Designed to coil easily and lay flat.



**HBL61CM52**  
**HBL61CM52W**  
**HBL61CM42**  
**HBL61CM42W**

### 50A 125/250V Cable Sets and Twist-Lock® Devices

Description	Catalog Number
Yellow 50 ft. (15.2m) vinyl jacketed shore power cable set, #6 AWG type STOW is completely factory pre-wired with molded-on devices. The connector end has a metallic threaded sealing ring for making the inlet/connector interface watertight. <b>IP56 SUITABILITY (BOATSIDE).</b>	<b>HBL61CM52</b>
Same as HBL61CM52 except with two high intensity LEDs	<b>HBL61CM52LED</b>
Same as HBL61CM52 except white in color.	<b>HBL61CM52W</b>
Same as HBL61CM52LED except white in color.	<b>HBL61CM52WLED</b>
Yellow 25 ft. (15.2m) vinyl jacketed shore power cable set, #6 AWG type STOW is completely factory pre-wired with molded-on devices. The connector end has a metallic threaded sealing ring for making the inlet/connector interface watertight. <b>IP56 SUITABILITY (BOATSIDE).</b>	<b>HBL61CM42</b>
Same as HBL61CM52LED except 25 ft. (7.6m) in length.	<b>HBL61CM42LED</b>
Same as HBL61CM42 except white in color.	<b>HBL61CM42W</b>
Same as HBL61CM42LED except white in color.	<b>HBL61CM42WLED</b>
Four conductor, #6 AWG type STOW, yellow PVC jacketed portable cord with jute fillers for added flexibility is ideal for making cable sets, extension cords and adapters that will not mark the boats deck. Available in 250 ft. (76.2m) lengths only.	<b>YC406250</b>
Nickel plated brass plug has a heat resistant thermoset interior and combination metal and rubber cord grip, which provides superior strain relief capability. Cord grip range is .44-1.14 in. (11.1-29.0). <b>IP20 SUITABILITY.</b>	<b>HBL63CM65*</b>
Single receptacle has a heat resistant thermoset base. <b>IP20 SUITABILITY.</b>	<b>HBL63CM69*</b>



**HBL61CM52LED**  
**HBL61CM42LED**



**HBL63CM65**

Note: \*UL Listed and CSA Certified.  
See page 13 for features and benefits.

### Boots and Weatherproof Plates

Description	Catalog Number
Yellow Seal-Tite® cover for weatherproofing 50A plugs. <b>IP55 SUITABILITY.</b>	<b>HBL77CM16**</b>
White Seal-Tite® cover for weatherproofing 50A plugs. <b>IP55 SUITABILITY.</b>	<b>HBL77CM16W**</b>
Yellow Valox® lift cover for weatherproofing 50A receptacles. Meets requirements of the most stringent of UL's three listing categories for weatherproof plates. Stainless steel screws and a neoprene gasket included. For mounting to FS/FD type weatherproof boxes. <b>IP44 SUITABILITY.</b>	<b>HBL77CM74WO</b>
Same as HBL77CM74WO except gray in color. <b>IP44 SUITABILITY.</b>	<b>HBL7774WO</b>
Stainless steel wall plate for 50A receptacle.	<b>SS750</b>

Note: \*\*Not UL Listed or CSA Certified.



**HBL63CM69**



**HBL77CM16**



**HBL77CM74WO**



**HBL7774WO**

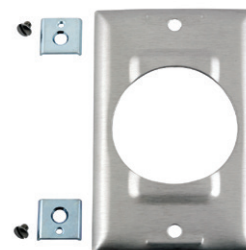

**SS750**



**HBL77CM16W**

Valox® is a trademark of SABIC Innovative Plastics, acquired from General Electric Company.

## 100A Ship-to-Shore Devices

### 100 Amp Pin and Sleeve Devices

- Hubbell Marine was the first to offer 100 amp marine grade devices that are considered second to none
- Hubbell developed the standard for 100 amp Pin and Sleeve devices with the National Electric Code and the American Boat and Yacht Council



## Features and Benefits



### Housing Design

- Supertough nylon housing provides increased safety and abuse resistance
- High visibility yellow, STOW cable, 105°C rated and UL listed
- The gasketed locking ring engages the mating device and when rotated and locked makes the interface between the devices watertight

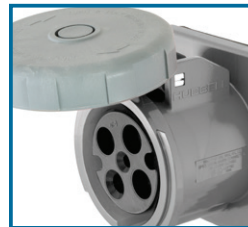

### Housing Design

- Nylon housing provides increased safety and resistance
- The gasketed, self-closing cover is keyed to normally seat in a position that provides a weatherproof seal; simply rotating the cover and locking it makes it watertight
- The device is marked with its catalog number and rating for easy identification



### Interior Design

- High impact thermoset contact carrier is arcing and heat resistant
- Two screw pressure terminals provide reliable terminations
- Nickel plated solid brass pins provide for long life and reliable electrical contact in corrosive environments
- Special keying makes proper alignment of mating devices quick and easy



### Interior Design

- High impact thermoset contact carrier is arcing and heat resistant
- The terminals are clearly identified with large markings for easy recognition
- Nickel plated solid brass contacts provide for long life and reliable electrical contact in corrosive environments
- Special keying makes proper alignment of mating devices quick and easy



### Exterior Design

- Massive external cable grips protect the wiring from conductor movement which can cause strain on the terminals
- All screws are stainless steel for corrosion resistance
- The device is marked with its catalog number and rating for easy identification

## 100A Ship-to-Shore Devices

### 100 Amp Cable Sets

- Only Hubbell offers 3, 4 and 5 wire 100 amp cable sets for your shore power requirements
- Cable sets manufactured in factory-controlled conditions using specially compounded cable to accommodate a full 100 amperes



Note: Cable sets must be fully extended before using.

**IP56**  
SUITABILITY



100A  
125/250V AC



100A 3ØY  
120/208V AC

### 100A Pin and Sleeve Cable Sets

Description	Catalog Number	
Yellow 75 ft. (22.8m) corrosion-resistant shore power cable set, 105°C rated, #2 AWG, (no neutral), STOW cable with plug and connector body for use with boats with isolation transformer on board.	<b>CS75IT4*</b>	<b>CS75IT5</b>
Same as above except 100 ft. (30.4m) in length.	<b>CS100IT4</b>	<b>CS100IT5</b>
Yellow 75 ft. (22.8m) corrosion-resistant shore power cable set, 105°C rated, #2 AWG, STOW cable.	<b>CS754</b>	—
Same as CS754/5 except 100 ft. (30.4m) in length.	<b>CS1004</b>	—
Yellow 50 ft. (15.2m) corrosion-resistant extension cord, 105°C rated, #2 AWG, STOW cable. For mating with existing shore power cable set.	<b>CS50EXT4</b>	<b>CS50EXT5</b>
Yellow 75 ft. (22.8m) corrosion-resistant one-ended (male only) power supply cable, 105°C rated, #2 AWG, STOW cable with 3 pole 4 wire male plug only; for use with boats using a cable winch system.	<b>CW754</b>	—
Yellow 100 ft. (30.4m) corrosion-resistant one-ended (male only) power supply cable, 105°C rated, #2 AWG, (no neutral) STOW cable with male plug only; for use with boats with isolation transformer on board and a cable winch system.	<b>CW100IT4</b>	<b>CW100IT5</b>
Same as CW100IT4/5 except 125 ft. (38.0m) in length.	<b>CW125IT4</b>	<b>CW125IT5</b>
Same as CW100IT4/5 except white in color.	<b>CW100IT4W</b>	—



**CS75IT4  
CS100IT4**



**CS100IT4W**

Note: Periodic cleaning and lubrication (such as LPS-1® made by Holt Lloyd Corp.) of the pins and sleeves of these devices is necessary to enjoy years of optimal use.

\*Also available in white, consult factory.



## 100A Ship-to-Shore Devices



100A  
125/250V AC



M4100P12

### 100A 125/250V Pin and Sleeve Devices

Description	Catalog Number
Yellow Zytel® super tough nylon watertight plug has gasketed locking ring to make plug/receptacle interface watertight. Cord grip range is 1.06–1.94 in. (26.9–49.3). <b>IP56 SUITABILITY.</b>	<b>M4100P12</b>
Gray nylon dockside receptacle has gasketed, spring-loaded cover. Closes automatically when not in use and is watertight when securely fastened. Mounting holes are 4.88 in. (123.8) on centers. Mounting screws and gasket included. <b>IP56 SUITABILITY.</b>	<b>M4100R12</b>
Yellow Zytel® super tough nylon watertight connector body for mating plug to connector interface on extension cords or adapters. Cord grip range is 1.06–1.94 in. (26.9–49.3). Note: It cannot be mated to the shore power inlet. <b>IP56 SUITABILITY.</b>	<b>M4100C12</b>
Gray nylon shore power inlet has gasketed, spring-loaded cover which closes automatically when not in use and is watertight when securely fastened. Mounting holes are 4.88 in. (123.8) on centers and rear portion has 3.94 in. (100.0) diameter. Mounting screws and gasket included. <b>IP56 SUITABILITY.</b>	<b>M4100B12R</b>
Yellow Zytel® super tough nylon watertight connector body has gasketed locking ring to make inlet/connector interface watertight. Cord grip range is 1.06–1.94 in. (26.9–49.3). Note: This device mates with shore power inlet only. <b>IP56 SUITABILITY.</b>	<b>M4100C12R</b>



M4100R12



M4100C12



M4100B12R



M4100C12R

### 100A Back Boxes and Accessories

Description	Catalog Number
Back box for inlets and receptacles has 15° angle section which can be installed in any of 4 positions. Box is cast aluminum with corrosion-resistant gray alkyd-based enamel finish and 1½ in. NPT hub which can be mounted for either top or bottom feed. <b>IP56 SUITABILITY.</b>	<b>FW60100</b>
15° angle cast aluminum back box has corrosion-resistant gray finish and top hub with 1½ in. NPT 100A receptacles can be mounted directly to it.	<b>BB1001W</b>
Same as BB1001W except threaded top hub is 2 in. NPT.	<b>BB1002W</b>
15° angle non-metallic back box, made of high-grade engineered thermoplastic Valox® to resist chemicals, abuse and U.V. rays. Has integral grounding plate, 1½ in. NPT hub size and 120 cu. in. capacity (hub is not included - Raco part number 1706 is recommended). <b>IP57 SUITABILITY.</b>	<b>BB100N</b>
Closure Cap for 100A plugs and connector bodies that (do not have a cap attached) have locking rings.	<b>PC100</b>
Replacement lift cover assembly; includes cover, arm and assembly tool.	<b>CA100</b>
Replacement locking ring and cord clamp.	<b>CC100</b>
Replacement locking ring only.	<b>LR100</b>

Note: Periodic cleaning and lubrication (such as LPS-1® made by Holt Lloyd Corp.) of the pins and sleeves of these devices is necessary to enjoy years of optimal use.



FW60100



BB1001W  
BB1002W

### Product Dimensions Inches (mm)

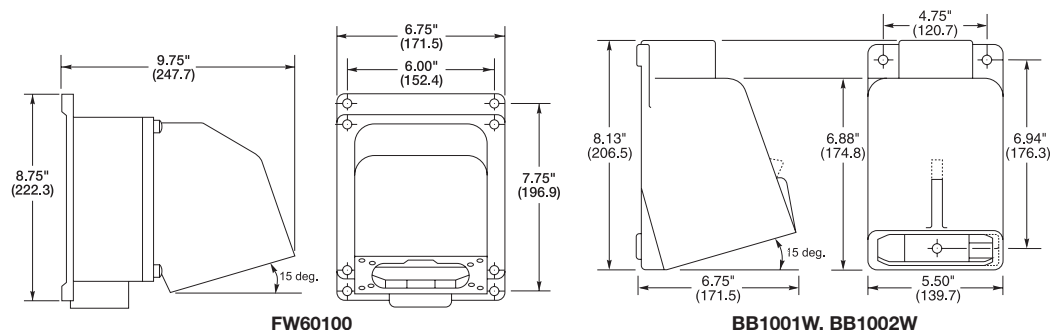

Zytel® is a registered trademark of E.I. DuPont.

Valox® is a trademark of SABIC Innovative Plastics, acquired from General Electric Company.

Dimensions in Inches (mm)



## 100A Ship-to-Shore Devices



100A 3ØY  
120/208V AC



100A 3ØY  
277/480V AC

### 100A 3ØY 120/208V and 3ØY 277/480V Devices

Description	Catalog Number	
Yellow Zytel® super tough nylon watertight plug has gasketed locking ring to make plug/receptacle interface watertight. Cord grip range is 1.06–1.94 in. (26.9–49.3). <b>IP56 SUITABILITY.</b>	<b>M5100P9</b>	<b>M5100P7</b>
Gray nylon dockside receptacle has gasketed, spring-loaded cover. Closes automatically when not in use and is watertight when securely fastened. Mounting holes are 4.88 in. (123.8) on centers. Mounting screws and gasket included. <b>IP56 SUITABILITY.</b>	<b>M5100R9</b>	<b>M5100R7</b>
Yellow Zytel® super tough nylon watertight connector body for making plug to connector interface on extension cords or adapters. Cord grip range is 1.06–1.94 in. (26.9–49.3). Note: It cannot be mated to the shore power inlet. <b>IP56 SUITABILITY.</b>	<b>M5100C9</b>	<b>M5100C7</b>
Gray nylon shore power inlet has gasketed, spring-loaded cover which closes automatically when not in use and is watertight when securely fastened. Mounting holes are 4.88 in. (123.8) on centers and rear portion has 3.94 in. (100.0) diameter. Mounting screws and gasket included. <b>IP56 SUITABILITY.</b>	<b>M5100B9R</b>	<b>M5100B7R</b>
Yellow Zytel® super tough nylon watertight connector body has gasketed locking ring to make inlet/connector interface watertight. Cord grip range is 1.06–1.94 in. (26.9–49.3). Note: This device mates with shore power inlet only. <b>IP56 SUITABILITY.</b>	<b>M5100C9R</b>	<b>M5100C7R</b>



M5100P9



M5100R9



M5100C9



M5100B9R



M5100C9R

### 100A Back Boxes and Accessories

Description	Catalog Number
Back box for inlets and receptacles has 15° angle section which can be installed in any of 4 positions. Box is cast aluminum with corrosion-resistant gray alkyd-based enamel finish and 1½ in. NPT hub which can be mounted for either top or bottom feed. <b>IP56 SUITABILITY.</b>	<b>FW60100</b>
15° angle cast aluminum back box has corrosion-resistant gray finish and top hub with 1½ in. NPT 100A receptacles can be mounted directly to it.	<b>BB1001W</b>
Same as BB1001W except threaded top hub is 2 in. NPT.	<b>BB1002W</b>
15° angle non-metallic back box, made of high-grade engineered thermoplastic Valox® to resist chemicals, abuse and U.V. rays. Has integral grounding plate, 1½ in. NPT hub size and 120 cu. in. capacity (hub is not included - Raco part number 1706 is recommended). <b>IP57 SUITABILITY.</b>	<b>BB100N</b>
Closure Cap for 100A plugs and connector bodies that (do not have a cap attached) have locking rings.	<b>PC100</b>
Replacement lift cover assembly; includes cover, arm and assembly tool.	<b>CA100</b>
Replacement locking ring and cord clamp.	<b>CC100</b>
Replacement locking ring only.	<b>LR100</b>

Note: Periodic cleaning and lubrication (such as LPS-1® made by Holt Lloyd Corp.) of the pins and sleeves of these devices is necessary to enjoy years of optimal use.

### Product Dimensions Inches (mm)

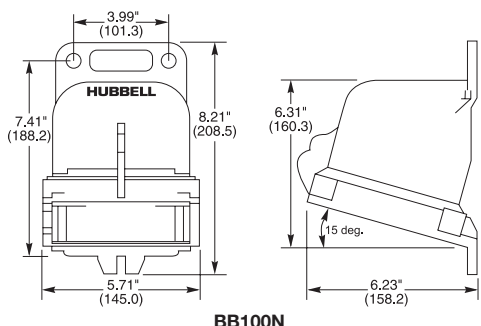

BB100N

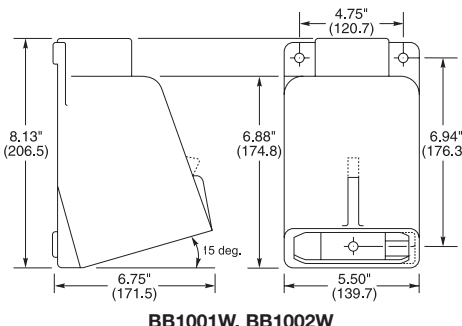

BB1001W, BB1002W



BB100N



PC100

Zytel® is a registered trademark of E.I. DuPont.  
Valox® is a trademark of SABIC Innovative Plastics, acquired from General Electric Company.

Dimensions in Inches (mm)

## 200A Ship-to-Shore Devices

### 200 Amp Pin and Sleeve Devices

Hubbell was the first to offer a UL listed 100 amp Marine Ship-To-Shore System... and now, we are the first to offer a UL listed 200 amp Marine Ship-To-Shore System.

The only 200 amp rated Ship-to-Shore System - built specifically for Mega-Yachts.

Hubbell 200 amp devices are listed to UL1682 and UL Classified for the mating and operation of 200 amp devices. Mates with Cooper® Crouse-Hinds® Arktite® or Appleton® Powertite® (when installed in accordance with instructions furnished with device).

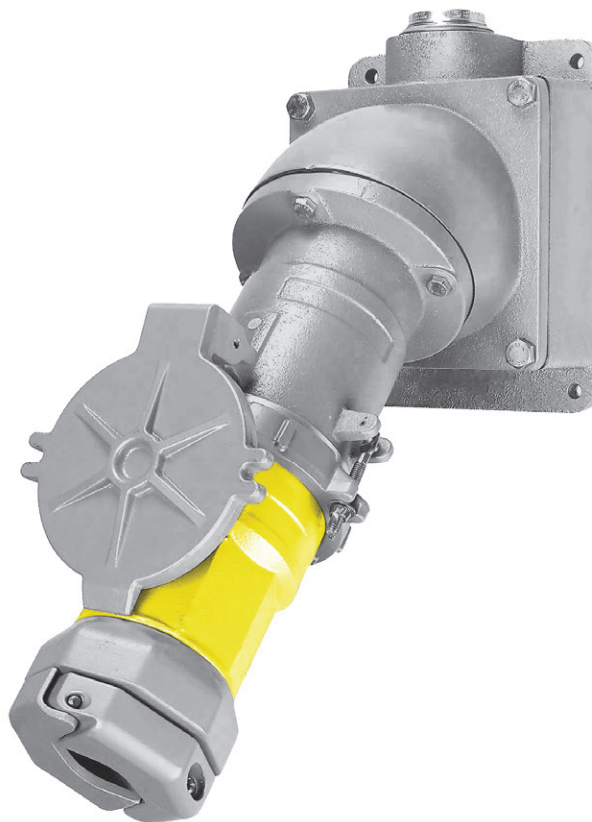

## Features and Benefits



### Housing Design

- Pins and Sleeves are made of nickel-plated Tellurium copper for superior corrosion and heat resistance
- UL Listed and CSA Certified



### Housing Design

- Housing is made of copper-free aluminum with an electrostatically applied epoxy/polyester finish
- Type 3, 4, 4X Rated per UL50 standard for superior water resistance



### Interior Design

- Interchangeable with other "UL1686 Series C1" Listed devices
- Terminal screws feature swivel/pressure pads to secure and prevent damage to conductors strands



### Interior Design

- Interchangeable with other "UL1686 Series C1" Listed devices
- Terminal screws feature swivel/pressure pads to secure and prevent damage to conductors strands



### Exterior Design

- Cable clamp captures cable at four points, provides superior retention
- Accepts a cord range of #1 AWG – 250 MCM

*Appleton® and Powertite® are registered trademarks of Appleton Electric Company. Cooper Crouse-Hinds® and Arktite® are registered trademarks of Cooper Industries, Inc.*

## 200A Ship-to-Shore Devices



200A  
600V AC/250V DC

### 200A 600V AC/250V DC, 50-400 Hertz Pin and Sleeve Devices

Description	Catalog Number
Gray metallic, watertight boatside power inlet with wingnut-secured lid for water tightness when not in use.	<b>M5200BS1R</b>
Gray/yellow metallic, watertight boatside connector body with locking ring to make inlet/connector body interface watertight. Cord grip range is #1 AWG-250 MCM 1.00-2.5 in. (25.4-6.35).	<b>M5200CS1R</b>
Gray/yellow metallic, watertight dockside plug with locking ring to make plug/receptacle interface watertight. Cord grip range is #1 AWG-250 MCM 1.00-2.5 in. (25.4-6.35).	<b>M5200PS1</b>
Gray metallic, watertight dockside receptacle with wing nut-secured lid for water tightness when not in use.	<b>M5200RS1</b>
Gray/yellow metallic, watertight dockside connector body with wing nut-secured lid for water tightness when not in use. For making plug/connector body interface on extension cords or adapters.	<b>M5200CS1</b>



**M5200BS1R**



**M5200CS1R**



**M5200PS1**



**M5200RS1**



**M5200CS1**



**MB2003W**

### 200A Back Boxes

Description	Catalog Number
Gray metallic back box for inlets and receptacles has 45° angle section which can be installed in any of 4 positions, 2 in. NPT hub.	<b>MB2003W</b>
Gray metallic back box – same as above but 2½ in. NPT hub.	<b>MB2004W</b>

### Product Dimensions Inches (mm)

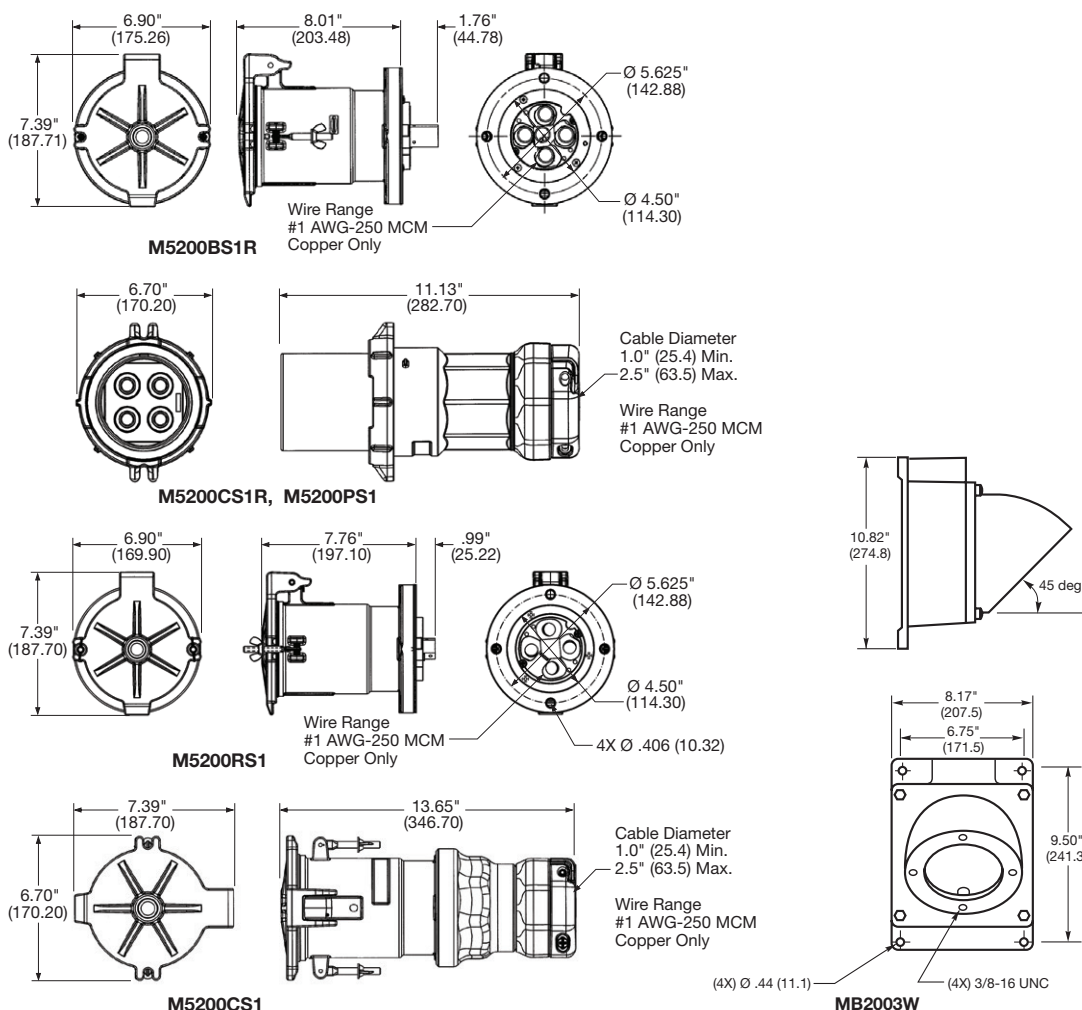

Dimensions in Inches (mm)

**Internationally Rated Conventional-Styled Devices**

Hubbell offers the only CE certified electrical shore power systems truly dedicated for boats destined for Europe and the International community. Hubbell's offering of international shore power inlets are available in traditional #316 stainless steel and attractive white non-metallic types resembling our domestic offering in style and appearance but are not interchangeable with the domestic shore power system.

Utilizing standard NEMA (National Electrical Manufacturer's Association) configurations not typically used in the marine market, Hubbell can offer a safe and non-interchangeable 16 amp 230 volt system and 32 amp 230 volt system for use with 50 cycle systems. The system includes white power supply cables (one-end, female only) in both the 16 amp and 32 amp categories.

Hubbell also offers a series of Internationally Rated Pin and Sleeve Devices, available in 16A, 32A and 63A 240V, these devices are interchangeable with other manufactures of UL1686 C1 devices.



**Features and Benefits**



**Housing Design**

- Base and cover are #316 type stainless steel for strength and corrosion resistance
- Self-closing cover is friction tight to remain open while engaging cable set and shields the interior from the elements when the inlet is not in use

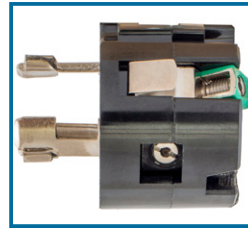

**Interior Design**

- Contact blades are nickel plated brass for corrosion resistance
- Watertight seal when in use, threaded base mates to the threaded ring of the watertight cover on the connector body; when not in use, it mates to the threaded cover



**Housing Design**

- White Centrex® cover and PBT base, weatherproof when closed
- Easy to wire polycarbonate interior is heat resistant and clear for visual inspection (16 amp and 32 amp)

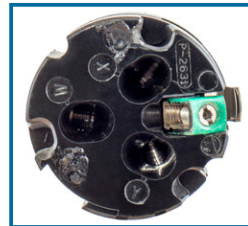

**Terminations (63 Amp)**

- Thermoset contact carrier is arcing and heat resistant
- Three screws "lock-in" the interior once it is in place
- Rear enclosure is nickel plated for corrosion resistance

**IP66**  
 SUITABILITY

**Internationally Rated\* Pin and Sleeve Devices, 2 Pole Plus Earth (≡)**

**\*Now Dual-Rated to match North American Configurations as well as International**

Description	16A / 20A	30A / 32A	60A / 63A
	220-240V / 250V		
Shore power inlet with mounting holes 3.13 in. (79.3) on centers and 2.72 in. (69.1) diameter on rear portion.	<b>HBL320B6W</b>	<b>HBL330B6W</b>	<b>HBL360B6W</b>
Connector body with cord grip range of .36-.83 in. (9.1-21.1).	<b>HBL320C6W</b>	<b>HBL330C6W</b>	<b>HBL360C6W</b>
Shore power receptacle with mounting holes 3.13 in. (79.3) on centers and 2.72 in. (69.1) diameter on rear portion.	<b>HBL320R6W</b>	<b>HBL330R6W</b>	<b>HBL360R6W</b>
Plug with cord grip range of .36-.83 in. (9.1-21.1).	<b>HBL320P6W</b>	<b>HBL330P6W</b>	<b>HBL360P6W</b>
Closure plug for inlets.	<b>PC320**</b>	<b>PC3430**</b>	<b>PC60**</b>
Back box for inlets and receptacles is cast aluminum with corrosion-resistant alkyd-based enamel finish and two ¼ in. NPT hubs.	<b>BB201W</b>	<b>BB301W</b>	<b>BB601W</b>
Feed-thru box for inlets and receptacles is cast aluminum with corrosion-resistant alkyd-based enamel finish and one ¼ in. NPT hubs.	<b>FT202W</b>	<b>FT202W</b>	<b>FW60100</b>

Note: \*\*Not CSA Certified.

Centrex® is a registered trademark of LANXESS Corporation.



# Internationally Rated Twist-Lock® Devices

16, 32 Ampere, 230 Volt

## Twist-Lock® Devices, Ship-To-Shore Power System

Description	16A 230V	32A 230V, 50 Cycle
Non-metallic, white, stylized, UV resistant shore power inlet. White Centrex® cover makes the inlet weatherproof when closed. Mounting holes are 2.38 in. (60.3) on centers and match most existing mounting patterns. Rear enclosure strain/relief cap is provided. <b>IP55 SUITABILITY.</b>	<b>HBL316NM</b>	<b>HBL332NM</b>
Traditional, stainless steel shore power inlet has easy-to-wire terminations. Interior is transparent for quick and easy visual inspection. Interior is shielded from the elements by a gasketed, self-closing cover, watertight when cover is screwed in place. Mounting holes are 2.38 in. (60.3) on centers. Mounting screws and gasket included. Protective rear enclosure/strain relief also included. <b>IP56 SUITABILITY.</b>	<b>HBL316SSX</b>	<b>HBL332SSX</b>
25 ft. (7.6m) yellow, vinyl jacketed power supply cord with female (boat side) end only; other end blunt cut. <b>IP56 SUITABILITY.</b>	<b>HBL316CS25</b>	—
50 ft. (15.2m) yellow, vinyl jacketed power supply cord with female (boat side) end only; other end blunt cut.	<b>HBL316CS</b>	<b>HBL332CS</b>
Yellow locking connector replacement end for HBL316CS25 and HBL316CS. <b>IP20 SUITABILITY.</b>	<b>HBL316CRCX</b>	<b>HBL332CRCX</b>
White Seal-Tite® cover with threaded sealing ring for use with HBL316CRC and HBL332CRC connector bodies. <b>IP56 SUITABILITY.</b>	<b>HBL60CM33W</b>	<b>HBL60CM33W</b>
White Seal-Tite® cover with threaded sealing ring for use with HBL316CRC and HBL332CRC connector bodies. <b>IP56 SUITABILITY.</b>	<b>HBL60CM33</b>	<b>HBL60CM33</b>



**HBL316NM  
HBL332NM**



**HBL316SSX  
HBL332SSX**



**HBL316CRCX  
HBL332CRCX**



**HBL363SSX**



**HBL316CS25  
HBL316CS  
HBL332CS**



**HBL60CM33  
HBL60CM33W**



**63A  
230V**

## 63A 230V Ship-To-Shore Power Systems

Description	Catalog Number
Traditional, stainless steel shore power inlet, including higher-quality metal threads, heat-resistant thermoset interior and box lug terminals. <b>IP56 SUITABILITY.</b>	<b>HBL363SSX</b>
Nickel plated brass plug with heat-resistant thermoset interior and box lug terminals cord grip range is .44 – 1.14 in. (11.1 - 29.0). <b>IP55 SUITABILITY.</b>	<b>HBL363CRP</b>
Nickel plated brass connector body with heat-resistant thermoset interior and box lug terminals. Cord grip range is .44 – 1.14 in. (11.1 - 29.0). <b>IP55 SUITABILITY.</b>	<b>HBL363CRC</b>
Single receptacle with heat-resistant thermoset base. <b>IP20 SUITABILITY.</b>	<b>HBL363CRR</b>
Yellow Seal-Tite® cover for connector bodies when used with 63A shore power inlets. Stainless steel threaded sealing ring makes connections watertight. <b>IP56 SUITABILITY.</b>	<b>HBL77CM15</b>
Same as HBL77CM15 except white in color.	<b>HBL77CM15W</b>
Yellow Seal-Tite® cover for 63A plugs. <b>IP55 SUITABILITY.</b>	<b>HBL77CM16</b>
Same as HBL77CM16 except white in color.	<b>HBL77CM16W</b>



**HBL363CRP**



**HBL363CRC**

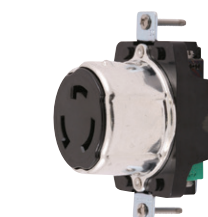

**HBL363CRR**



**HBL77CM15**



**HBL77CM16W**

Centrex® is a registered trademark of LANXESS Corporation.

# Marine Products Intelligent Y Adapters

## Intelligent Y Adapters

**YQ230** - Safely powers a 50A 125/250V AC boat from two 30A 125V AC receptacles at dockside.\*

**Problem:** A boat owner with one electrical system on board docks in a marina that can only provide a different electrical system.

**Solution:** Use of the Hubbell YQ series of Intelligent Adapters can correct many electrical system mismatches.

*Note: \*The two 30 amp receptacles must be on separate phases to function.*



## Features and Benefits



### Housing Design

- Rugged UV resistant high-impact housing
- Environmentally sealed against humidity, fog and rain
- Cord clamps prevent strain on terminals
- Sealing grommets keep moisture out



### Safety

- Safety indicator light, (when ON, safe operation is indicated)
- 3 pole contactor breaks both hots and neutrals to prevent possibility of "live" plug when not engaged

## Intelligent Y Adapters

Description	Catalog Number
Adapter that permits use of 50A 125/250V AC cable set. (HBL61CM52), with two 30A 125V AC receptacles, HBL26CM10.	<b>YQ230</b>
Adapter that permits use of 100A 125/250V AC cable set. (CS754, CS1004) with one or two 50A 125/250V AC receptacles, HBL63CM69.	<b>YQ100PLUS</b>

*Note: The YQ230 Adapter will only work with two 30A receptacles that are on different phases.*

*The YQ100PLUS Adapter must be plugged into two 50A 125/250V AC receptacles that are on the same phase to achieve 100 amp, 125/250 volts power —or the "A" leg 50A male can be plugged into a single 50A 125/250V AC receptacle to achieve 50 amp, 125/250 volts power.*

## Intelligent Y Adapters

**YQ100PLUS** - Safely powers a 100A 125/250V AC boat from two 50A 125/250V AC receptacles at dockside -or- from a single 50A 125/250V AC receptacle acting as a single adapter.

### Internal Logic Senses That:

- Both plugs are fully engaged (i.e., one is not dangling loose while the other is plugged in) -or- the "A" leg plug is engaged to access a single 50A 125/250V receptacle
- The polarity of the receptacle on the dock is correct (i.e., no mis-wiring of the hot and neutral wires)
- The two receptacles are from correct phases

**CAUTION: This adapter must be connected to an onboard, center-tapped isolation transformer or shore power converter. DO NOT USE this adapter if such a transformer or converter is not available.**

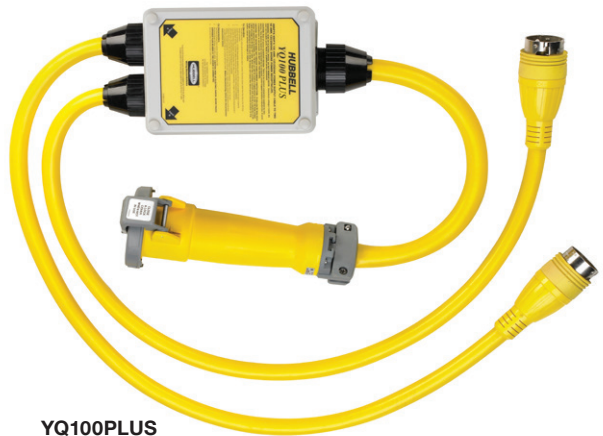

### Housing Design

- Rugged, smaller, lighter-weight enclosure
- Environmentally sealed against humidity, fog and rain
- Sealing grommets keep moisture out



### Safety

- Indicator lights indicate correct polarity and safe operation
- "A" leg for accessing a single 50A 125/250V receptacle

### Hubbell Molded Adapters

Hubbell Straight Adapters (pigtailes) and “Y” Adapters are built to the same standards as all Hubbell Shore Power Cords.

Filled with end-to-end features and weathertight when mated with Hubbell shore cords without the need for extra collars, etc.

Hubbell Marine Adapters deliver the power you need.

- Available in a variety of configurations
- Now CSA Compliant



### Features and Benefits



#### Housing Design

- Fully molded fittings (except 100A) for superior waterproofing and durability
- Hubbell adapters are weatherproof when mated with Hubbell cable sets

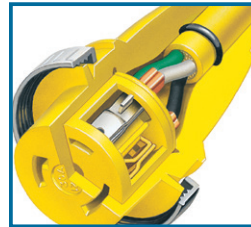

#### Interior Design

- Terminations utilize exclusive copper crimp barrel terminations, holds over 300% more securely
- Bull ring for strain relief on the terminals
- Nickel plated brass contact blades for corrosion-resistance



#### Safety

- Provides 15 amp convenience power with GFCI protection
- Manual reset button
- High impact PVC housing, UV stabilized
- Sealed GFCI housing and keypad
- Large LED power “ON” light

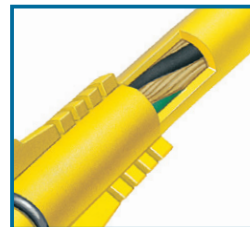

#### Cord Flexibility

- Molded-in flex feature controls the angle of cord entry and keeps water out
- Jute fillers inside jacket for maximum cable flexibility; Hubbell cable coils neater, lighter and lays flatter



Boat/Cable Set Side Connector Body (Female End)	Molded Straight Adapters		Power Center/Dock Side Plug (Male End)
15A 125V, 2P 3W Straight Blade with GFCI protection		<b>HBL105GF</b>	30A 125V, 2P 3W Twist-Lock®
30A 125V, 2P 3W Twist-Lock		<b>HBL61CM22</b> <b>HBL61CM22W</b>	15A 125V, 2P 3W Straight Blade (lock type)
30A 125V, 2P 3W Twist-Lock		<b>HBL61CM25</b>	20A 125V, 2P 3W Twist-Lock
50A 125V, 2P 3W Twist-Lock		<b>HBL61CM54</b>	15A 125V, 2P 3W Straight Blade
30A 125V, 2P 3W Twist-Lock		<b>HBL61CM55</b>	50A 125V, 2P 3W Twist-Lock
50A 125V, 2P 3W Twist-Lock		<b>HBL61CM56</b>	30A 125V, 2P 3W Twist-Lock
30A 125V, 2P 3W Twist-Lock		<b>HBL61CM71</b>	50A 125/250V, 3P 4W Twist-Lock
50A 125V, 2P 3W Twist-Lock		<b>HBL61CM72</b>	50A 125/250V, 3P 4W Twist-Lock
100A 125/250V, 3P 4W Pin and Sleeve		<b>HBL61CM100</b>	50A 125/250V, 3P 4W Twist-Lock

**Molded Y Adapters**

(2) 30A 125V, 2P 3W Twist-Lock		<b>HBL64CM54</b>	50A 125/250V, 3P 4W Twist-Lock
(2) 50A 125V, 2P 3W Twist-Lock		<b>HBL64CM55</b>	50A 125/250V, 3P 4W Twist-Lock
(2) 30A 125V, 2P 3W Twist-Lock		<b>HBL64CM56</b>	30A 125V, 2P 3W Twist-Lock
(2) 30A 125V, 2P 3W Twist-Lock		<b>HBL64CM57</b>	50A 125V, 2P 3W Twist-Lock

**One Piece Adapters**

30A 125V, 2P 3W Twist-Lock		<b>HBL31CM28</b>	15A 125V, 2P 3W Straight Blade
15 or 20A 125V, 2P 3W Straight Blade		<b>HBL31CM29</b>	30A 125V, 2P 3W Twist-Lock
20A 125V, 2P 3W Twist-Lock		<b>HBL21CM28</b>	15A 125V, 2P 3W Straight Blade
15 or 20A 125V, 2P 3W Straight Blade		<b>HBL21CM29</b>	20A 125V, 2P 3W Twist-Lock

Note: See page 27 for features and benefits.  
 See page 29 for photographs and descriptions.



### Molded Straight Adapters – Now CSA Compliant

Description	Catalog Number
Permits use of 20A 125V Twist-Lock® locking type plug with 15 or 20A 125V straight blade receptacle. <b>IP20 SUITABILITY.</b>	<b>HBL21CM28*</b>
Permits use of 15A or 20A 125V straight blade plug with 20A 125V Twist-Lock locking type receptacle. <b>IP20 SUITABILITY.</b>	<b>HBL21CM29*</b>
Permits use of 30A 125V Twist-Lock locking type plug with 15 or 20A 125V straight blade receptacle. <b>IP20 SUITABILITY.</b>	<b>HBL31CM28</b>
Permits use of 15A or 20A 125V straight blade plug with 30A 125V Twist-Lock locking type receptacle. <b>IP20 SUITABILITY.</b>	<b>HBL31CM29</b>
Permits use of 30A 125V cable set, HBL61CM08 with 15 or 20A 125V straight blade receptacle. Anchor locking screw on plug when screwed down resists pullout of the cable set. <b>IP55 SUITABILITY (CONNECTOR).</b>	<b>HBL61CM22</b>
Same as HBL61CM22, except white.	<b>HBL61CM22W</b>
Permits use of 30A 125V cable set, HBL61CM08 with 20A 125V Twist-Lock receptacle, HBL23CM10. <b>IP55 SUITABILITY (CONNECTOR).</b>	<b>HBL61CM25</b>
Permits use of 50A 125V cable set, HBL61CM53 with 15 or 20A 125V straight blade receptacle. <b>IP55 SUITABILITY (CONNECTOR).</b>	<b>HBL61CM54</b>
Permits use of 30A 125V cable set, HBL61CM08 with 50A 125V Twist-Lock receptacle, HBL63CM70. <b>IP55 SUITABILITY (CONNECTOR).</b>	<b>HBL61CM55</b>
Permits use of 50A 125V cable set, HBL61CM53 with 30A 125V Twist-Lock receptacle, HBL26CM10. <b>IP55 SUITABILITY (CONNECTOR).</b>	<b>HBL61CM56</b>
Permits use of 30A 125V cable set, HBL61CM08 with 50A 125/250V Twist-Lock receptacle, HBL63CM69. <b>IP55 SUITABILITY (CONNECTOR).</b>	<b>HBL61CM71^</b>
Permits use of 50A 125V cable set, HBL61CM53 with 50A 125/250V Twist-Lock receptacle, HBL63CM69. <b>IP55 SUITABILITY (CONNECTOR).</b>	<b>HBL61CM72^</b>
Permits use of 15A 125V 3 wire straight blade plug with 15 or 20A 125V 2 wire straight blade receptacle. <b>IP55 SUITABILITY (CONNECTOR).</b>	<b>HBL5273L*</b>
Permits a 100A 125/250V cable set to plug into a single 50A 125/250V outlet. <b>IP55 SUITABILITY (CONNECTOR).</b>	<b>HBL61CM100**</b>
Permits use of 15A straight blade plug with 30A 125V Twist-Lock receptacle; with GFCI protection. <b>IP55 SUITABILITY (PLUG).</b>	<b>HBL105GF**</b>



HBL31CM28



HBL21CM29



HBL61CM22



HBL61CM25



HBL61CM56



HBL61CM100



HBL105GF

### Molded Y Adapters – Now CSA Compliant

Description	Catalog Number
Permits use of two 30A 125V cable sets, HBL61CM08, with one 50A 125/250V receptacle, HBL63CM69. <b>IP55 SUITABILITY (CONNECTORS).</b>	<b>HBL64CM54</b>
Permits use of two 50A 125V cables sets, HBL61CM53, with one 50A 125/250V receptacle, HBL63CM69. <b>IP55 SUITABILITY (CONNECTORS).</b>	<b>HBL64CM55</b>
Permits use of two 30A 125V cable sets, HBL61CM08, with one 30A 125V receptacle, HBL26CM10. <b>IP55 SUITABILITY (CONNECTORS).</b>	<b>HBL64CM56</b>
Permits use of two 30A 125V cable sets, HBL61CM08, with one 50A 125V receptacle, HBL63CM70. <b>IP55 SUITABILITY (CONNECTORS).</b>	<b>HBL64CM57**</b>

Note: \*UL Listed.

\*\*Not CSA Certified.

^ The male plug end (50A 125/250V) has a blade removed and the blade slot filled with epoxy. Omitting the blade ensures achieving 125V safety.

Adapters do not provide overcurrent protection and do not provide GFCI protection except HBL105GF.



HBL64CM54



HBL64CM55



HBL64CM56



HBL64CM57

# Hubbell Marine Isolation Transformers

## Hubbell Marine Isolation Transformers

Hubbell Isolation Transformers can protect your vessel's sensitive electronic equipment from damaging electrical spikes or surges. These transformers will also convert various dockside power systems to the 120/240 volt power required to operate all of the equipment on board.

And most importantly, Hubbell Isolation Transformers greatly reduce the possibility of stray current leaking from your boat's electrical system into the water, which could otherwise result in Electrical Shock Drowning (ESD) or electrocution.

### Available Options:

- Available in White Powder Coated Steel or #316 Stainless Steel Housing
- 15 kVA and 25 kVA Models
- 60 Hz and 50/60 Hz Models
- 12.5% Taps

## Constant Clean Safe Power



#316 Stainless Steel Housing

Standard White Powder Coated Steel Housing

## Features and Benefits



### Housing Design

- Available in #316 stainless steel or white powder coated steel finish
- Compact size and weight



### Exterior Design

- 1 Easy access wiring chamber/drip lid
- 2 Auto boost connector
- 3 1" and 1½" knockouts
- 4 Weep holes



### Neatly Routed Wiring Chamber (Top view with cover removed)

- Easy access wiring chamber
- Pre-wired for 120/240 volt applications



### Safety/Installation

- Mounting brackets
- Vibration resistant

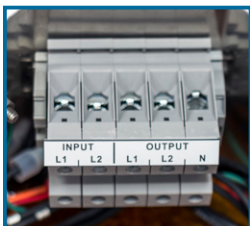

### Interior Design

- Main module cleanly mounted in easy access wiring chamber
- High-quality terminal block for wire management
- Sand-filled and epoxy topped
- Auto-boost/remote cable receptacle



### Auto-Boost Unit

- Factory programmed module automatically boosts voltage up to 12.5% if the reading at the dock falls between 195–220 volts

# Hubbell Marine Isolation Transformers

**Constant Clean Safe Power**

## Hubbell Marine Isolation Transformers

15 kVA and 25 kVA Models

- Protects Sensitive Equipment on Board
- Virtually Eliminates Potential for In-Water Stray Current
- Can be wired per ABYC E-11 for either a Polarization or Isolation Transformer system



### Isolation Transformers

Description	Weight (Lbs.)	Color	60 Hz	50/60 Hz
			Catalog Number	Catalog Number
15 kVA isolation transformer.	170	White powder coated steel	<b>HBL50AITW</b>	<b>HBL32AITW</b>
15 kVA isolation transformer.	170	#316 Stainless steel	<b>HBL50AITSS</b>	<b>HBL32AITSS</b>
15 kVA isolation transformer with auto-boost.	175	#316 Stainless steel	<b>HBL50AITSSB</b>	<b>HBL32AITSSB</b>
25 kVA isolation transformer.	250	White powder coated steel	<b>HBL100AITW</b>	<b>HBL63AITW</b>
25 kVA isolation transformer.	250	#316 Stainless steel	<b>HBL100AITSS</b>	<b>HBL63AITSS</b>
25 kVA isolation transformer with auto-boost.	255	#316 Stainless steel	<b>HBL100AITSSB</b>	<b>HBL63AITSSB</b>

### Product Dimensions Inches (mm)

Description	Weight (Lbs.)	A - Height	B - Width	C - Depth
15 kVA Models	170	16.94" (43.0)	14.12" (35.9)	11.59" (29.4)
25 kVA Models	250	18.44" (46.8)	16.13" (41.0)	13.34" (33.9)



### Recommended Seal-tite Cord Connectors

- For input and output cables
- Straight connectors for 1 and 1 1/2 inch KOs

### Cord Connectors

Description	NPT Hub Size	Cord Diameter Inches (mm)	Form Size	Cast Aluminum Catalog Number
Straight male connectors	1	1.13"-1.25" (28.6-31.7)	F5	<b>SHC1048*</b>
	1 1/2	1.25"-1.38" (31.7-34.9)	F5	<b>SHC1059</b>
	1 1/2	1.38"-1.50" (34.9-38.1)	F6	<b>SHC1061</b>

Note: \*Cable jacket may have to be stripped to pass through connector body.



Dimensions in Inches (mm)

## Ship-to-Shore Devices



**HBLPHTVNM**



**HBLPHTVSS**



**HBLTVSS**



**PH6625**



**PH6624**



**PH7440**

### Telephone and Cable TV Ship-to-Shore Devices

Description	Catalog Number
Stylized non-metallic inlet provides telephone and cable TV connections in one unit. UV resistant white Centrex® cover makes unit weatherproof when completely closed. Mounting holes are 2.38 in. (60.3) on centers and match existing mounting patterns. Mounting screws and gasket provided. <b>IP55 SUITABILITY.</b>	<b>HBLPHTVNM</b>
Traditional stainless steel inlet provides connections for telephone and cable TV in one unit. Connections can be used individually or together. Gasketed cover is self-closing so interior is shielded from the elements when not in use. Watertight when cover is screwed in place. Mounting holes are 2.38 in. (60.3) on centers. Mounting screws and gasket included. <b>IP56 SUITABILITY.</b>	<b>HBLPHTVSS</b>
Same as HBLPHTVSS above except no phone.	<b>HBLTVSS</b>
Replacement int. for PH6594TV and HBLPHTVSS series inlets.	<b>CR16914</b>
Black locking type plug for telephone cable sets or adapters.	<b>PH6625</b>
Black locking type connector body used on telephone cable sets or adapters.	<b>PH6624</b>
Yellow Seal-Tite® cover for weatherproofing PH6624 connector body on cable sets when connecting to an inlet and for weather-proofing PH6625 plug. <b>IP20 SUITABILITY.</b>	<b>PH7440</b>
Yellow Seal-Tite cover for weatherproofing PH6624 connector body when used on extension cords or adapters. <b>IP55 SUITABILITY.</b>	<b>PH7499</b>
Factory pre-wired 50 ft. (15.2m) telephone cable set. Uses 3 conductor, #16 AWG type SJTO, yellow vinyl cord for marine and recreational vehicle applications. <b>IP20 SUITABILITY.</b>	<b>PH6599</b>
Same as PH6599 except white in color.	<b>PH6599W*</b>
Same as PH6599 except 25 ft. (7.6m) in length.	<b>PH6598</b>
Same as PH6598 except white in color.	<b>PH6598W*</b>

Note: \*Discontinued.

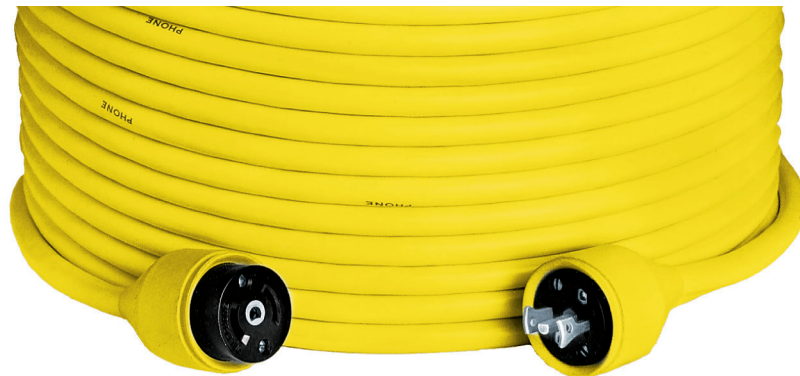

**PH6599**  
**PH6598**

Centrex® is a registered trademark of LANXESS Corporation.

### Ship-to-Shore Devices

#### Telephone and Cable TV Ship-to-Shore Devices

Description	Catalog Number
Black polycarbonate combination telephone/TV outlet with spring-loaded weatherproof lift cover. Can be wired for telephone service only or for telephone and MATV/CATV services in one FS/FD box in both marinas and RV parks. Can be padlocked to prevent unauthorized use. <b>IP44 SUITABILITY.</b>	<b>PH6597TV</b>
Black polycarbonate cable TV outlet has coax connector and gasketed, spring-loaded lift cover for weatherproofing. Designed for mounting to FS/FD type weatherproof boxes (like PH6619) in both marinas and RV parks. <b>IP20 SUITABILITY.</b>	<b>TV97</b>
Black polycarbonate telephone outlet has gasketed, spring-loaded lift cover for weatherproofing. Designed for mounting to FS/FD type weatherproof boxes (like PH6619) in both marinas and RV parks. <b>IP20 SUITABILITY.</b>	<b>PH6597</b>
Black polycarbonate telephone outlet has gasketed, spring-loaded lift cover for weatherproofing. Can be used to retrofit old style telephone outlets of Pauluhn Manufacturing Company (2833 and 2843) in both marinas and RV parks. <b>IP20 SUITABILITY.</b>	<b>PH6596</b>
Black polycarbonate RV inlet for telephone connection only. Has spring-loaded, gasketed weatherproof lift cover designed for mounting to FS/FD type weatherproof boxes. <b>IP20 SUITABILITY.</b>	<b>PH6595</b>
Black non-metallic FS box with 3/4 in. threaded hubs used for mounting phone and TV outlets and PH6595 recreational vehicle inlet. Cord connector included for strain relief and to maintain watertight integrity of box when cable is used. PVC adapter also included for connection of PVC conduit to box.	<b>PH6619</b>
50 ft. (15.2m) yellow jacketed ship-to-shore TV cable set is the industry standard 75 Ohm, RG59-U with male plugs on both ends. Adapter included for a quick, slip-on connection to inlet on boat.	<b>TV99</b>
Same as TV99 except white in color.	<b>TV99W</b>
Same as TV99 except 25 ft. (7.6m) in length.	<b>TV98</b>
Same as TV98 except white in color.	<b>TV98W</b>



**PH6597TV**



**TV97**



**PH6597**



**PH6596**



**PH6595**



**PH6619**



**TV99  
TV99W  
TV98  
TV98W**

## Electric Fishing Reel Devices

Hubbell has a DC rated electrical system designed specifically for larger electric fishing reel systems. Up until now, larger electric fishing reel systems typically utilized conventional 30 Amp AC rated devices since an appropriately rated DC system was not available.

The system features a corrosion-resistant plug, connector body and receptacle and can be used along with a Hubbell outlet box and weatherproof cover plate to complete the installation. These devices are all rated at 28 Volt DC and applicable for all 12, 24 and 32 Volt DC fishing reel systems. The devices are UL listed and CSA certified. All devices are made of high-visibility yellow nylon that is impact resistant and UV stabilized for longer life. Also, the contacts are nickel plated for corrosion resistance.



HBL328DCR



HBL328DCP



HBL328DCC



HBL60CM83A



HBL60800S



HBL74CM25WOA



HBL74CM25WOAW

### 30A 28V DC Rated Devices

Description	Catalog Number
Yellow locking single receptacle with abuse-resistant face. Can be mounted in Hubbell box HBL6083 and used with HBL74CM25WOA weatherproof plate.	<b>HBL328DCR</b>
Same as HBL328DCR except white in color.	<b>HBL328DCRW</b>
Yellow locking plug has rugged nylon housing and rear dust seal to keep dust and foreign matter out.	<b>HBL328DCP</b>
Same as HBL328DCP except white in color.	<b>HBL328DCPW</b>
Yellow locking connector body has rugged, nylon housing and rear dust seal to keep dust and foreign matter out.	<b>HBL328DCC</b>

### Accessories

Description	Catalog Number
Gray, high-impact thermoplastic FD (deep) weatherproof box with ¼ in. (19.1) NPT threaded hub, with 30 cubic inch capacity.	<b>HBL6083</b>
Same as HBL6083 except yellow in color.	<b>HBL60CM83A</b>
Same as HBL6083 except white in color.	<b>HBL60CM83WA</b>
Black phenolic type FS (shallow) weatherproof box has two ¼ in. (19.1) I.P.S. molded-in knockouts. 4.56 in. H x 2.94 in. W x 2.19 in. D (115.9H x 74.6W x 55.6D) and has 16 cubic inch capacity.	<b>HBL60800S</b>
Spring-loaded lift cover, for weatherproofing HBL328DCR outlet. Yellow in color.	<b>HBL74CM25WOA</b>
Same as HBL74CM25WOAW except white in color.	<b>HBL74CM25WOAW</b>
Same as HBL74CM25WOAW except gray in color.	<b>HBL7425WOA</b>

Note: See page 50 for 55° angle adapters and additional accessories.

# Marine Products 12 Volt DC Rated Switches

Panel Mount Toggle and Rocker Switches

## KEY CHART



**M11SP**

### 1. Toggle switch

Fits panels up to 1/4 in. thick when not using the back-up nut provided; fits panels up to 3/16 in. thick when using the back-up nut. Requires a 1/2 in. mounting hole.

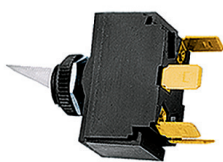

**M11LRGSP**

### 2. Lighted toggle switch

Built-in pilot light (R=red, G=green) for night vision. Same panel specs as 1.



**M11LTR**

### 3. Lighted-tip toggle switch

Red pilot light visible in tip of toggle only. Same panel specs as 1.



**MR11SP**

### 4. Rocker switch

Requires a 1 1/2 in. high x 7/8 in. wide rectangular opening.

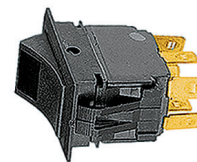

**MR123LRSP**

### 5. Lighted rocker switch

Built-in pilot light for night vision. Same panel specs as 4.

## Panel Mount Toggle and Rocker Switches

Description	Typical Applications	Key	Catalog Number
Single pole, single throw, ON/OFF.	Lights, bilge blower, bilge pump(s), accessories	1	<b>M11SP</b>
		2	<b>M11LRSP</b>
		2	<b>M11LRGSP</b>
		3	<b>M11LTR</b>
		4	<b>MR11SP</b>
Single pole, single throw, ON/OFF/ON.	Horn, starter, winches, gauges		<b>M11MSP</b>
			<b>MR11MSP</b>
Single pole, double throw, ON/OFF/ON.	Bilge pumps, speed selector, lights, navigation lights		<b>M123SP</b>
			<b>M123LTR</b>
			<b>MR123SP</b>
			<b>MR123LRSP</b>
Single pole, double throw, Momentary ON/OFF/ON.	Bilge pumps	1	<b>M123MSP</b>
		4	<b>MR123MSP</b>
Single pole, double throw, Momentary ON/OFF/Momentary ON.	Trim Tabs	1	<b>M123MMSP</b>
		4	<b>MR123MMSP</b>
Double pole, single throw, ON/OFF.	Lights, accessories	1	<b>M21SP</b>
		4	<b>MR21SP</b>
Double pole, double throw, ON/OFF/ON.	Navigation lights, wipers, dual fuel tanks	1	<b>M223SP</b>
		4	<b>MR223SP</b>
Double pole, double throw, ON/OFF/ON (with jumper).	Navigation lights, windlass	1	<b>M223JSP</b>
Double pole, double throw, Momentary ON/OFF/Momentary ON.	Winches, trim tabs, dual fuel tanks	1	<b>M223MMSP</b>
		4	<b>MR223MMSP</b>
Black silicone rubber boot bonded to brass nut.	Provides positive seal against moisture, oil, etc. Fits any non-lighted toggle switch.		<b>MSB1</b>
Push-button horn switch with 15/32 in. long nickel plated brass mounting stem. Terminals are .25 in. spade.	For remote operation of horn.		<b>MH11</b>
Black push-button (horn) boot.	Fits MH11 horn switch.		<b>MHB11</b>



**M11SP**



**MR11SP**

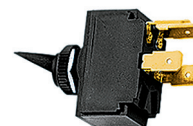

**M21SP**

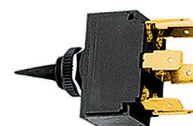

**M223SP**



**MSB1**



**MH11**



**MHB11**

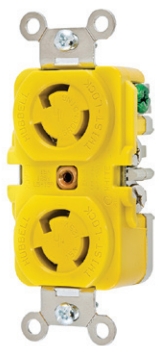

HBL47CM00



HBL47CM20C



HBL47CM29C



HBL47CM15



HBL47CM16



HBL60CM23

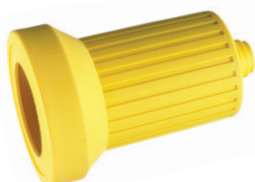

HBL60CM24



HBL52CM21W

## 15A 125V AC Twist-Lock® Devices

Description	Catalog Number
Yellow duplex receptacle has heat resistant body. <b>IP20 SUITABILITY.</b>	<b>HBL47CM00</b>
Yellow Insulgrip® plug has rugged nylon housing and detachable cord grip with range of .30-.69 in. (7.5-17.4) that utilizes a unique offset jaws arrangement to provide secure strain relief. <b>IP20 SUITABILITY.</b>	<b>HBL47CM20C</b>
Yellow Insulgrip connector body has rugged nylon housing and detachable cord grip with range of .30-.69 in. (7.5-17.4) that utilizes a unique offset jaws arrangement to provide secure strain relief. <b>IP20 SUITABILITY.</b>	<b>HBL47CM29C</b>
Panel mount flanged outlet has heat resistant melamine interior and stainless steel casing. <b>IP20 SUITABILITY.</b>	<b>HBL47CM15</b>
Panel mount flanged inlet has heat resistant melamine interior and stainless steel casing. <b>IP20 SUITABILITY.</b>	<b>HBL47CM16</b>

## Accessories

Description	Catalog Number
Yellow Valox® spring-loaded lift cover for weatherproofing duplex receptacles. Stainless steel screws and neoprene gasket included for mounting to FS/FD type weatherproof boxes. <b>IP20 SUITABILITY.</b>	<b>HBL52CM21</b>
Same as HBL52CM21 except white in color	<b>HBL52CM21W</b>
Same as HBL52CM21 except gray in color.	<b>HBL5221</b>
Same as HBL52CM21 except for mounting to standard boxes.	<b>HBL52CM22</b>
Same as HBL52CM22 except gray in color.	<b>HBL5222</b>
Short yellow Seal-Tite® cover for weatherproofing HBL47CM20C Insulgrip plug when used with receptacles or connector bodies. Also can be used to weatherproof HBL47CM29C Insulgrip connector body when used with HBL47CM16 flanged inlet. <b>IP44 SUITABILITY.</b>	<b>HBL60CM23**</b>
Yellow Seal-Tite cover for weatherproofing HBL47CM29C Insulgrip connector body when used on extension cords and adapters. <b>IP20 SUITABILITY.</b>	<b>HBL60CM24**</b>

Note: \*\*Not UL Listed or CSA Certified.

Valox® is a trademark of SABIC Innovative Plastics, acquired from General Electric Company.





15A 125V  
NEMA 5-15R  
UL/CSA

## 15A 125V AC Straight Blade Devices

Description	Catalog Number
Yellow corrosion-resistant/weather resistant duplex receptacle. Use outdoors or where salt and other corrosive materials are a problem. Accepts 15A 125V, 2 pole 3 wire straight blade plugs. <b>IP20 SUITABILITY.</b>	<b>HBL52CM62</b>
Same as HBL52CM62 except ivory in color.	<b>HBL52CM62I</b>
Single version of HBL52CM62 duplex yellow receptacle. <b>IP20 SUITABILITY.</b>	<b>HBL52CM61</b>
Yellow Insulgrip® plug has rugged nylon housing and detachable cord grip with range of .23-.72 in. (5.8-18.3) that utilizes a unique offset jaws arrangement for secure strain relief. <b>IP20 SUITABILITY.</b>	<b>HBL52CM66C</b>
Yellow Insulgrip connector body has rugged nylon housing and detachable cord grip with range of .23-.72 in. (5.8-18.3) that utilizes a unique offset jaws arrangement for secure strain relief. <b>IP20 SUITABILITY.</b>	<b>HBL52CM69C</b>
Yellow Valise® plug has one-piece nylon housing that assembles easily with two screws. Built-in cord grip has range of .22-.66 in. (5.6-16.8). <b>IP20 SUITABILITY.</b>	<b>HBL52CM66V</b>
Yellow Valise connector body has one-piece nylon housing that assembles easily with two screws. Built-in cord grip has range of .22-.66 in. (5.6-16.8). <b>IP20 SUITABILITY.</b>	<b>HBL52CM69V</b>
Yellow Insulgrip plug with anchor locking screw to prevent accidental pull-out. The plug is "locked" into the receptacle when the screw is turned down so the head is flush with the plug surface. The cord grip range is .30-.69 in. (7.5-17.4). UL Recognized Component. <b>IP20 SUITABILITY.</b>	<b>HBL52CM80C</b>
Compact gray nylon panel mount inlet ideal for bass boat battery charging connection. Has gasketed spring-loaded lift cover for weatherproofing front and neoprene boot for weatherproofing rear. Will accept both 15A 125V and 20A 125V, 2 pole 3 wire straight blade connector bodies. <b>IP44 SUITABILITY.</b>	<b>HBL61CM64</b>
Same as HBL61CM64 except black in color.	<b>HBL61CM64BK</b>

Note: See page iv for Weather Resistant description.

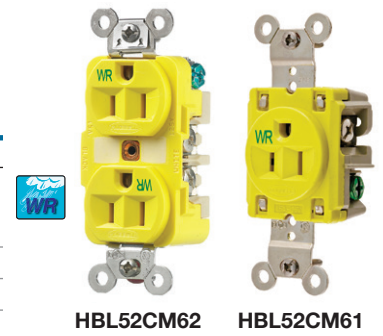

HBL52CM62 HBL52CM61

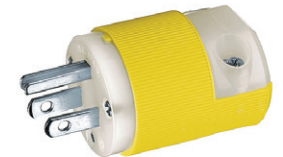

HBL52CM66C



HBL52CM69C



HBL52CM80C



HBL52CM66V



HBL52CM69V

## Accessories

Description	Catalog Number
Yellow Seal-Tite® cover for weatherproofing straight blade Insulgrip plugs, HBL52CM66C and HBL53CM66C, when used with receptacles and connector bodies. Can also be used to weatherproof Insulgrip connector bodies when mating with flanged inlets. <b>IP44 SUITABILITY.</b> Note: For Insulgrip devices only.	<b>HBL60CM17**</b>
Yellow Seal-Tite cover for weatherproofing straight blade Insulgrip connector bodies, HBL52CM69C and HBL53CM69C, on extension cords and adapters. <b>IP55 SUITABILITY.</b> Note: For Insulgrip devices only.	<b>HBL60CM18**</b>
Yellow Valox® spring-loaded lift cover for weatherproofing duplex receptacles. Stainless steel screws and neoprene gasket included for mounting to FS/FD type weatherproof boxes. <b>IP20 SUITABILITY.</b>	<b>HBL52CM21</b>
Same as HBL52CM21 except gray in color.	<b>HBL5221</b>
Same as HBL52CM21 except for mounting to standard boxes.	<b>HBL52CM22</b>
Same as HBL52CM22 except gray in color.	<b>HBL5222</b>
Yellow Valox spring-loaded lift cover for weatherproofing single straight blade receptacles. Stainless steel screws and neoprene gasket included. For mounting to FS/FD type weatherproof boxes. <b>IP44 SUITABILITY.</b>	<b>HBL74CM23WO</b>
Same as HBL74CM23WO except gray in color.	<b>HBL7423WO</b>

Note: \*\*Not UL Listed or CSA Certified.



HBL60CM17

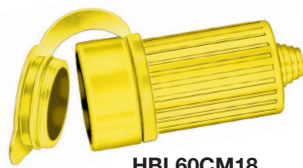

HBL60CM18  
HBL60CM19



HBL52CM21



HBL74CM23WO



HBL61CM64

Rynite® is a registered trademark of E. I. DuPont.

Valox® is a trademark of SABIC Innovative Plastics, acquired from General Electric Company.



Plugs, receptacles and connectors only.



20A 125V  
NEMA L5-20R  
UL/CSA



HBL23CM10



HBL23CM11



HBL23CM13



HBL23CM11V



HBL60CM31

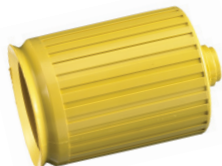

HBL60CM31V



HBL60CM32

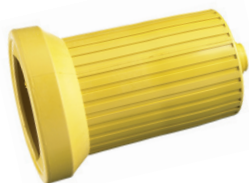

HBL60CM32V



HBL74CM25WOA

## 20A 125V Twist-Lock® Devices

Description	Catalog Number
Yellow single receptacle has Rynite® body and abuse resistant nylon face. <b>IP20 SUITABILITY.</b>	<b>HBL23CM10</b>
Yellow Insulgrip® plug has rugged nylon housing and cord grip with range of .36-.93 in. (9-24) that utilizes a unique offset jaws arrangement to provide secure strain relief. <b>IP20 SUITABILITY.</b>	<b>HBL23CM11</b>
Yellow Insulgrip connector body has rugged nylon housing and cord with range of .36-.93 in. (9-24) that utilizes a unique offset jaws arrangement to provide secure strain relief. <b>IP20 SUITABILITY.</b>	<b>HBL23CM13</b>
Yellow Valise plug has one-piece nylon housing, assembles easily with two screws. Built-in cord grip has range of .33-.72 in. (8.3-18.2). <b>IP20 SUITABILITY.</b>	<b>HBL23CM11V</b>

## Accessories

Description	Catalog Number
Yellow polycarbonate spring-loaded lift cover for weather-proofing HBL23CM10 receptacle. Meets the most stringent requirements of UL's three listing categories for weatherproof plates. Stainless steel screws and neoprene gasket included for mounting to FS/FD type weatherproof boxes. <b>IP44 SUITABILITY.</b>	<b>HBL74CM25WOA</b>
Same as HBL74CM25WOA except gray in color.	<b>HBL7425WOA</b>
Same as HBL74CM25WOA except white in color.	<b>HBL74CM25WOAW</b>
Yellow Seal-Tite® cover for weatherproofing HBL26CM11 or HBL23CM11 plugs. <b>IP44 SUITABILITY.</b> Note: Fits Insulgrip devices only.	<b>HBL60CM31**</b>
Same as HBL60CM31 except white in color.	<b>HBL60CM31W**</b>
Yellow Seal-Tite cover for weatherproofing HBL26CM13 or HBL23CM13 connector bodies when used on extension cords or adapters. <b>IP44 SUITABILITY.</b> Note: Fits Insulgrip devices only.	<b>HBL60CM32**</b>
Yellow vinyl Seal-Tite cover for weatherproofing HBL23CM13V or HBL26CM13V connector bodies. <b>IP44 SUITABILITY.</b> Note: Fits Valise® devices only.	<b>HBL60CM32V**</b>
Yellow Seal-Tite cover for weatherproofing HBL23CM11V or HBL26CM11V plugs. <b>IP44 SUITABILITY.</b> Note: Fits Valise devices only.	<b>HBL60CM31V**</b>

Note: \*\*Not UL Listed or CSA Certified.

Rynite® is a registered trademark of E. I. DuPont.

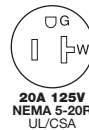

## 20A 125V AC Straight Blade Devices

Description	Catalog Number
Yellow corrosion-resistant/weather resistant duplex receptacle. Use outdoors or where salt and other corrosive materials are a problem. Accepts both 20A 125V and 15A 125V, 2 pole 3 wire straight blade plugs. <b>IP20 SUITABILITY.</b>	<b>HBL53CM62</b>
Single version of HBL53CM62 duplex yellow receptacle. <b>IP20 SUITABILITY.</b>	<b>HBL53CM61</b>
Yellow Insulgr <sup>®</sup> plug has rugged nylon housing and detachable cord grip with range of .23-.72 in. (5.8-18.3) that utilizes unique offset jaws arrangement to provide secure strain relief. <b>IP20 SUITABILITY.</b>	<b>HBL53CM66C</b>
Yellow Insulgr <sup>®</sup> connector body has rugged nylon housing and cord grip with range of .23-.72 in. (5.8-18.3) that utilizes unique offset jaws arrangement for secure strain relief. <b>IP20 SUITABILITY.</b>	<b>HBL53CM69C</b>
Compact gray nylon panel mount outlet ideal for electric trolling motors and reel applications. Features gasketed spring-loaded lift cover for weatherproofing front and neoprene boot for weatherproofing rear. Accepts both 20A 125V and 15A 125V, 2 pole 3 wire straight blade plugs. <b>IP44 SUITABILITY.</b>	<b>HBL61CM65</b>

Note: See page iv for Weather Resistant description.

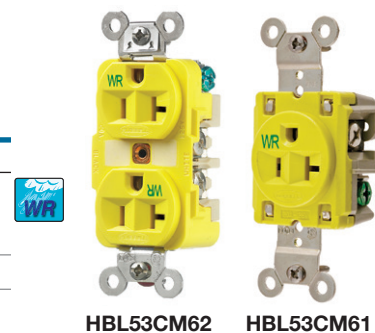

HBL53CM62 HBL53CM61

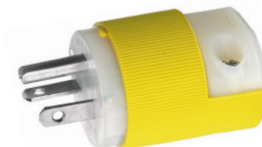

HBL53CM66C



HBL53CM69C



HBL52CM66V

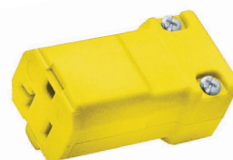

HBL52CM69V



HBL61CM65

## Accessories

Description	Catalog Number
Yellow Seal-Tite <sup>®</sup> cover for weatherproofing straight blade Insulgr <sup>®</sup> plugs, HBL52CM66C and HBL53CM66C, when used to mate receptacles and connector bodies. Can also be used with Insulgr <sup>®</sup> connector bodies when mating with flanged inlets. <b>IP44 SUITABILITY.</b> Note: For Insulgr <sup>®</sup> devices only.	<b>HBL60CM17**</b>
Yellow Seal-Tite cover for weatherproofing straight blade Insulgr <sup>®</sup> connector bodies, HBL52CM69C and HBL53CM69C, on extension cords and adapters. <b>IP55 SUITABILITY.</b> Note: For Insulgr <sup>®</sup> devices only.	<b>HBL60CM18**</b>
Yellow closure plug used with HBL60CM18 long Seal-Tite cover to prevent water from entering front of device when not in use. <b>IP55 SUITABILITY.</b>	<b>HBL60CM19**</b>
Yellow polycarbonate spring-loaded lift cover for weatherproofing duplex receptacles. Stainless steel screws and neoprene gasket included for mounting to FS/FD type weatherproof boxes. <b>IP20 SUITABILITY.</b> Not CSA certified.	<b>HBL52CM21</b>
Same as HBL52CM21 except white in color.	<b>HBL52CM21W</b>
Same as HBL52CM21 except gray in color.	<b>HBL5221</b>
Same as HBL52CM21 except for mounting to standard boxes.	<b>HBL52CM22</b>
Same as HBL52CM22 except gray in color.	<b>HBL5222</b>
Yellow polycarbonate spring-loaded lift cover for weatherproofing single straight blade receptacles. Stainless steel screws and neoprene gasket included. For mounting to FS/FD type weatherproof boxes. <b>IP44 SUITABILITY.</b> Not CSA certified.	<b>HBL74CM23WO</b>
Same as HBL74CM23WO except gray in color.	<b>HBL7423WO</b>

Note: \*\*Not UL Listed or CSA Certified.



HBL60CM17



HBL52CM21



HBL52CM21W



HBL74CM23WO



HBL7423WO

Rynite<sup>®</sup> is a registered trademark of E. I. DuPont.

## Hubbell Twist-Lock® Circuit Tester

The Hubbell Twist-Lock® Tester is an exclusive patented design that easily tests the circuit condition without the need for traditional measurement techniques. Whether it is a boater, marina operator or electrician, knowing that power is present at any receptacle or connector is critical. By plugging the tester into an outlet, an LED output will immediately provide the state of the circuit.

An easy to read card is provided with the tester, to help determine if the connections are made properly and in the correct position. This unique NEMA configuration ensures that the proper connection was made through an easy to read output display. It also easily attaches to a tool belt so it is available when needed.



For Testing the Wiring Condition of Receptacles and Connectors

- Quickly diagnose mis-wiring situation or application
- Great for dark, difficult to reach spaces
- No measurement readings to interpret
- Easy to read LED output and condition tables
- Insulgrip® nylon housing for secure gripping
- Carabiner style clip to secure to work belt
- UL 1436 listed



**HBLT26CM11**

### Hubbell Twist-Lock® Circuit Tester

Description	Catalog Number
Styled and sized like a standard Hubbell Twist-Lock® Plug. Simply plug it in and the LED back panel immediately identifies if the connections are made correctly and are in the correct position, ensuring the device is wired properly. An easy to read card is provided with the tester, to help determine if the connections are correct. This tester is compact and can easily clip onto your tool belt. The Hubbell Circuit Tester is UL and C-UL Listed.	<b>HBLT26CM11</b>



**GFT2G**

### Additional Testers

Description	Catalog Number
This unit is designed to measure the trip level of GFCI portables, receptacles, or breakers within any range from 2 to 7 milliamperes, or the leakage in portable tools or appliances within a leakage range of 1 to 7 milliamperes. It can be used on any AC circuit of 110 to 130V.	<b>GFT2G*</b>



**HBL5200**

This outlet circuit tester has a simple arrangement of neon lights which visually indicate correct wiring, reversed polarity, open ground wire, open neutral wire, open hot wire, hot and ground reversed and hot wire on neutral terminal and hot terminal unwired. Simply plug the HBL5200 into a single phase 125V 2 pole 3 wire outlet and the combination of lighted and/or unlighted lamps will immediately indicate the condition of the circuit. The instructions and symbol identification are printed on durable polyester labels permanently attached to the tester. To test other 2 pole 3 wire single phase 125V outlets, use one of the proper adapters shown on page 29.	<b>HBL5200**</b>
---	------------------

Note: \*Not UL Listed or CSA Certified.  
 \*\*Not CSA Certified.

## USB Charger Receptacles

More Ways to Charge Faster with Hubbell's line of USB Chargers, available in Type-C, Combination Type A&C or the legacy Type A, all with a USB high power output of 5 Amp 5 Volt DC. Hubbell's USB Charger Duplex Receptacle provides both USB and electrical power in a standard single gang opening. Designed to provide maximum charging for portable electronics, the USB ports are capable of charging two tablets simultaneously.

Hubbell's new weather resistant USB charger receptacle offers a safe and reliable solution, conveniently expanding way to charge portable electronics. Now, being outdoors no longer means worrying about finding a charging source. Weather resistant receptacles comply with Section 406.9 of the National Electrical Code when used with covers.

### Common Features

- LED ON to indicate USB and line voltage power available
- USB stainless steel ports rated for minimum 10,000 insertions and removals
- Complies with battery charging specification BC1.2
- Designed for commercial, industrial and home use
- Compatible with USB 1.1/2.0/3.0 devices, including Apple® products

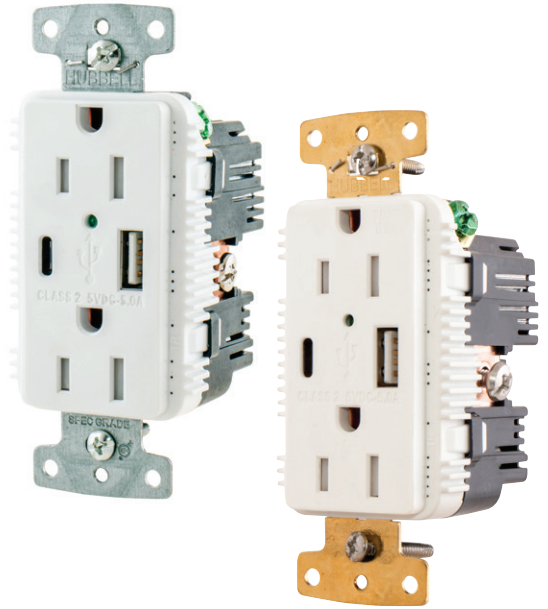

## Features and Benefits

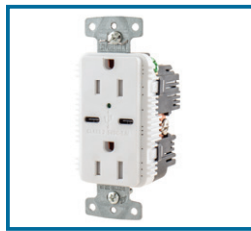

### USB Chargers

- Two Type-C port configurations
- One Type A and one Type-C port
- Two Type A port configurations
- High power 5 Amp, 5 Volt DC USB output
- Tamper-Resistant decorator duplex receptacle



### Weather Resistant Type A&C USB Charger

- One Type A and one Type-C port configurations
- Meets Section 406.9 of NEC® with cover
- 5 Amp, 5 Volt USB output
- Power indicating green LED light

## Weather Resistant USB Charger Duplex Receptacles



Description	Color	15A 125V AC	20A 125V
<b>Type A&amp;C USB Charger Receptacle</b> , one Type A and one Type-C port configurations, high power 5 Amp, 5 Volt USB output, Tamper-Resistant USB ports rated 10,000 cycles; Commercial Grade.	Ivory	<b>USB15AC51WR</b>	<b>USB20AC51WR</b>
	Light Almond	<b>USB15AC5LAWR</b>	<b>USB20AC5LAWR</b>
	White	<b>USB15AC5WWR</b>	<b>USB20AC5WWR</b>

*Note: Outdoor circuits should be GFCI protected per national and local electric codes. Also available in black, brown and gray. See page iv for Weather and Tamper-Resistant descriptions.*

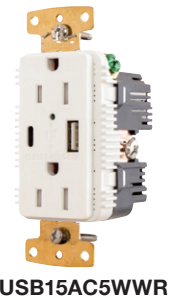

USB15AC5WWR

## Standard USB Charger Tamper-Resistant Duplex Receptacles



Description	Color	15A 125V AC
<b>Type-C USB Charger Receptacle</b> , two Type-C port configurations, high power 5 Amp, 5 Volt USB output.	Ivory	<b>USB15C5I</b>
	Light Almond	<b>USB15C5LA</b>
	White	<b>USB15C5W</b>
<b>Type A&amp;C USB Charger Receptacle</b> , one Type A and one Type-C port configuration, high power 5 Amp, 5 Volt USB output.	Ivory	<b>USB15AC5I</b>
	Light Almond	<b>USB15AC5LA</b>
	White	<b>USB15AC5W</b>
<b>Type A USB Charger Receptacle</b> , two Type A port configurations, high power 5 Amp, 5 Volt USB output.	Ivory	<b>USB15A5I</b>
	Light Almond	<b>USB15A5LA</b>
	White	<b>USB15A5W</b>

*Note: Also available in black, brown and gray. See page iv for Tamper-Resistant description.*



USB15AC5W

Apple® is a registered trademark of Apple Inc.  
 NEC® is a registered trademark of the The National Electrical Code.



The American Boat and Yacht Council recommends the use of ground fault protected receptacles in a head, galley, machinery space or on a weather deck. Refer to ABYC "Ground Fault Protection" on page 52.

## New Hubbell Weather Resistant and Extra Heavy Duty Corrosion Resistant Weather and Tamper-Resistant Ground Fault Receptacles

Hubbell now offers a Ground Fault Receptacle for every application.

Hubbell's GFCI offering, with patented self-test technology, continually tests and monitors itself to insure proper functioning.

Hubbell's GFCI Receptacle line-up now includes:

- Standard Commercial Series; for typical standard use
- Weather Resistant Series; meets NEC® requirements for weather resistance, UV and corrosion resistance for harsh and damp applications.
- Extra Heavy Duty Corrosion Resistant Series; has high-impact and UV stabilized housing, nickel-plated face contacts, mounting strap and terminals to withstand the most demanding environments and applications.



GF5262SGYEL



CWP26CRW



GFP15M



GFP315A



GFP6C15M  
GFP25C15M

### Ground Fault Receptacles



Description	Color	OEM Version Standard Series	Marine Packaging Weather Resistant Series	Extra Heavy Duty Series
15A 125V GFCI receptacle.	Ivory	<b>GFRST15I</b>	<b>GFRST52MI</b>	<b>GF5262SGI</b>
	Light Almond	<b>GFRST15LA</b>	<b>GFRST52MLA</b>	-
	White	<b>GFRST15W</b>	<b>GFRST52MW</b>	<b>GF5262SGW</b>
	Yellow	-	-	<b>GF5262SGYEL</b>

Note: Also available in black, brown and gray. See page iv for Weather and Tamper-Resistant descriptions.

Hubbell's GFCI receptacles can be mounted on any standard 2.50 inch (63.5) deep box. A feed-through feature provides protection not only at that receptacle but also at any other receptacle located downstream from it on the same circuit. These devices meet the requirements of The National Electric Code (NEC®) and American Boat and Yacht Council Standard and will accept locking fork terminals.

**Caution: Ground Fault Receptacles should not be mounted in locations exposed to salt spray nor in the engine room. For GFCI protection of such locations, downstream feeding from an internally located Ground Fault Receptacle is recommended.**

Description	Color	Catalog Number
PVC weatherproof lift cover for ground fault receptacles (such as GFRST52M series) and Style Line® receptacles. For vertical mounting in standard or FS/FD type boxes.	Gray White	<b>CWP26CR</b> <b>CWP26CRW</b>

### Portable Ground Fault Circuit Interrupters (GFCI)

Ideal for providing safety in applications requiring multiple outlets, features gasketed cover to protect outlets not in use. Ensures safety by interrupting power when leakage to ground is 4 to 6 milliamperes. A test button allows the user to test that the GFCI is in working order. This portable solution provides open neutral protection.

Description	Catalog Number
The housing is high-impact yellow polycarbonate as are the liftcovers which protect the receptacles from dirt and damage. Incorporates a 20 Amp GFCI module that can be replaced in the field. The module provides not only ground fault protection, but also contains the no voltage release feature.	<b>GFP15M</b>
3-outlet plug-in unit. Plugs into boat convenience receptacles to provide ground fault protection.	<b>GFP315A</b>

Note: GFCI devices will not protect against overloads or short circuits.

### 15A 125V GFCI Line Cord Devices

Description	Line Cord Length	Catalog Number
Ideal for personal plug-in protection at marinas and onboard boats when used with pumps, drills, sanders and all portable electrical equipment. GFCI mechanism is watertight and approved for outdoor use. High visibility yellow SJTW-A power cord resists moisture, chemicals and sunlight.	6 ft. (1.8m)	<b>GFP6C15M</b>
	25 ft. (7.6m)	<b>GFP25C15M</b>

NEC® is a registered trademark of the The National Electrical Code.

### Style Line® Decorator Receptacles

- High-impact nylon face resists breaking, chipping and cracking
- Will accept locking fork terminal to comply with ABYC standards
- Available in 4 colors for any decor with matching wall plates
- Smooth, high-gloss finish for rich appearance

#### Commercial Style Line® Decorator Series



Description	Color	Standard Duplex	Duplex, Tamper-Resistant	Duplex, Weather and Tamper-Resistant
15A 125V duplex receptacle.	Almond	<b>DR15AL</b>	<b>DR15ALTR</b>	-
	Black	<b>DR15BLK</b>	<b>DR15BLKTR</b>	<b>DR15BLKWTR</b>
	Brown	<b>DR15</b>	<b>DR15TR</b>	<b>DR15WRTR</b>
	Gray	<b>DR15GRY</b>	<b>DR15GRYTR</b>	<b>DR15GRYWTR</b>
	Ivory	<b>DR15I</b>	<b>DR15ITR</b>	<b>DR15IWTR</b>
	Light Almond	<b>DR15LA</b>	<b>DR15LATR</b>	<b>DR15LAWTR</b>
White	<b>DR15WHI</b>	<b>DR15WHITR</b>	<b>DR15WHIWTR</b>	



DR15ITR



DR15GRYWTR

#### Commercial Series



Description	Color	Standard Duplex, Spec. Grade, Side Wired	Duplex, Tamper-Resistant	Duplex, Weather and Tamper-Resistant, Back and Side Wired
15A 125V duplex receptacle.	Almond	<b>CR15AL</b>	<b>CR15ALTR</b>	-
	Black	<b>CR15BLK</b>	<b>CR15BLKTR</b>	<b>BR15BLKWTR</b>
	Brown	<b>CR15</b>	<b>CR15TR</b>	<b>BR15WRTR</b>
	Gray	<b>CR15GRY</b>	<b>CR15GRYTR</b>	<b>BR15GRYWTR</b>
	Ivory	<b>CR15I</b>	<b>CR15ITR</b>	<b>BR15IWTR</b>
	Light Almond	<b>CR15LA</b>	<b>CR15LATR</b>	<b>BR15LAWTR</b>
White	<b>CR15WHI</b>	<b>CR15WHITR</b>	<b>BR15WHIWTR</b>	



CR15TR



BR15IWTR

Note: All devices above will accept locking fork terminal to comply with ABYC standards. See page iv for Tamper and Weather Resistant descriptions.

### Extra Heavy Duty Single Receptacles

Description	Color	Catalog Number
15A 125V single receptacle.	Brown	<b>HBL5251</b>
	Ivory	<b>HBL5251I</b>
20A 125V single receptacle.	Brown	<b>HBL5361</b>
	Ivory	<b>HBL5361I</b>



HBL5251



HBL5361I

### Corrosion Resistant Receptacles



Description	Color	Catalog Number
15A 125V yellow corrosion resistant duplex receptacle. Use where salt or other corrosive elements are a problem.	Yellow	<b>HBL52CM62</b>
Same as HBL52CM62 except ivory in color.	Ivory	<b>HBL52CM62I</b>



HBL52CM62I



HBL8200ILI

### Special Application Illuminated Receptacle

Description	Color	Catalog Number
Illuminated receptacle 15A 125V grounding. A high quality receptacle with an illuminated face. Ideal for use in halls or as a gentle night light.	Ivory	<b>HBL8200ILI</b>

Note: See page iv for Weather Resistant description.



CS1151

## Commercial Series

Description	Toggle Color	Catalog Number
15A single-pole toggle switch for controlling AC load from one point.	Black	<b>CS115BK</b>
	Brown	<b>CS115</b>
	Gray	<b>CS115GY</b>
	Ivory	<b>CS115I</b>
	Light Almond	<b>CS115LA</b>
	White	<b>CS115W</b>
15A three-way toggle switch for controlling AC load from two points.	Black	<b>CS315BK</b>
	Brown	<b>CS315</b>
	Gray	<b>CS315GY</b>
	Ivory	<b>CS315I</b>
	Light Almond	<b>CS315LA</b>
	White	<b>CS315W</b>

Note: All devices above will accept locking fork terminal to comply with ABYC standards.



HBL1221IL



HBL1221PL

## Special Application Series

Description	Catalog Number
20A 120V toggle switch with LED lamp set in ivory handle. Handle illuminates when switch is in "OFF" position.	<b>HBL1221IL</b>
20A 120V three-way toggle switch with LED illuminated ivory handle for controlling AC load from two points. Handle illuminates when "OFF".	<b>HBL1223IL</b>
20A 120V single-pole toggle switch with LED lamp set in clear red handle. Handle illuminates when switch is "ON". Serves as instant reminder that current is flowing to an appliance.	<b>HBL1221PL</b>
20A 120V three-way toggle switch with LED for controlling AC load from two points. Red handle illuminates when "ON".	<b>HBL1223PL</b>
Single-pole PresSwitch® for controlling AC load from one point. Switch activated brown button.	<b>HBL1281</b>
Same as HBL1281 except ivory button.	<b>HBL1281I</b>
Three-way PresSwitch for controlling AC load from two points. Switch activated brown button.	<b>HBL1283*</b>
Same as HBL1283 except ivory button.	<b>HBL1283I*</b>



HBL1281



HBL1283



HBL17CM50



HBL1795

## Accessories

Description	Catalog Number
Yellow neoprene weatherproof plate for use only with PresSwitches. PresSwitch button is activated when bubble is pressed. Not CSA certified.	<b>HBL17CM50*</b>
Clear silicone rubber weatherproof bubble plate for use with all AC toggle switches and PresSwitches. Also ideal for use with lighted handle toggle switches. Not CSA certified.	<b>HBL1795</b>
Plastic switch/receptacle box. Measures 3.281" x 2.188" x 2.50" (83.3 x 55.6 x 63.5) deep. For mounting in walls without studs. A support strap is provided which pulls box tightly against back side of wall.	<b>HBL6079**</b>

Note: \*Not UL Listed.  
\*\*Not CSA Certified.



HBL6079













### Wallplate Features

#### Nylon plates—virtually unbreakable

- Rounded corners for stylish look
- Reinforced ribs for extra strength
- Screws are factory-inserted for fumble-free installation

#### Stainless Steel plates

- Type 302/304
- Non-magnetic
- Ideal for highly corrosive environments

Description	Color	Smooth Nylon		Material	Smooth Metal Catalog Number
		Standard	Mid-Size		
	Black	<b>NP1BK</b>	<b>NPJ1BK</b>	Brass Stainless Steel	<b>SB1</b> <b>SS1</b>
	Brown	<b>NP1</b>	<b>NPJ1</b>		
	Gray	<b>NP1GY</b>	<b>NPJ1GY</b>		
	Ivory	<b>NP1I</b>	<b>NPJ1I</b>		
	White	<b>NP1W</b>	<b>NPJ1W</b>		
	Black	<b>NP8BK</b>	<b>NPJ8BK</b>	Brass Stainless Steel	<b>SB8</b> <b>SS8</b>
	Brown	<b>NP8</b>	<b>NPJ8</b>		
	Gray	<b>NP8GY</b>	<b>NPJ8GY</b>		
	Ivory	<b>NP8I</b>	<b>NPJ8I</b>		
	White	<b>NP8W</b>	<b>NPJ8W</b>		
	Black	<b>NP26BK</b>	<b>NPJ26BK</b>	Brass Stainless Steel	<b>SB26</b> <b>SS26</b>
	Brown	<b>NP26</b>	<b>NPJ26</b>		
	Gray	<b>NP26GY</b>	<b>NPJ26GY</b>		
	Ivory	<b>NP26I</b>	<b>NPJ26I</b>		
	White	<b>NP26W</b>	<b>NPJ26W</b>		
	Black	<b>NP2BK</b>	<b>NPJ2BK</b>	Brass Stainless Steel	<b>SB2</b> <b>SS2</b>
	Brown	<b>NP2</b>	<b>NPJ2</b>		
	Gray	<b>NP2GY</b>	<b>NPJ2GY</b>		
	Ivory	<b>NP2I</b>	<b>NPJ2I</b>		
	White	<b>NP2W</b>	<b>NPJ2W</b>		
	Black	<b>NP82BK</b>	<b>NPJ82BK</b>	Brass Stainless Steel	<b>SB82</b> <b>SS82</b>
	Brown	<b>NP82</b>	<b>NPJ82</b>		
	Gray	<b>NP82GY</b>	<b>NPJ82GY</b>		
	Ivory	<b>NP82I</b>	<b>NPJ82I</b>		
	White	<b>NP82W</b>	<b>NPJ82W</b>		
	Black	<b>NP262BK</b>	<b>NPJ262BK</b>	Brass Stainless Steel	<b>SB262</b> <b>SS262</b>
	Brown	<b>NP262</b>	<b>NPJ262</b>		
	Gray	<b>NP262GY</b>	<b>NPJ262GY</b>		
	Ivory	<b>NP262I</b>	<b>NPJ262I</b>		
	White	<b>NP262W</b>	<b>NPJ262W</b>		
	Black	<b>NP18BK</b>	<b>NPJ18BK</b>	Brass Stainless Steel	<b>SB18</b> <b>SS18</b>
	Brown	<b>NP18</b>	<b>NPJ18</b>		
	Gray	<b>NP18GY</b>	<b>NPJ18GY</b>		
	Ivory	<b>NP18I</b>	<b>NPJ18I</b>		
	White	<b>NP18W</b>	<b>NPJ18W</b>		
	Black	<b>NP126BK</b>	<b>NPJ126BK</b>	Brass Stainless Steel	<b>SB126</b> <b>SS126</b>
	Brown	<b>NP126</b>	<b>NPJ126</b>		
	Gray	<b>NP126GY</b>	<b>NPJ126GY</b>		
	Ivory	<b>NP126I</b>	<b>NPJ126I</b>		
	White	<b>NP126W</b>	<b>NPJ126W</b>		
	Black	<b>NP7BK</b>	<b>NPJ7BK</b>	Brass Stainless Steel	<b>SB7</b> <b>SS7</b>
	Brown	<b>NP7</b>	<b>NPJ7</b>		
	Gray	<b>NP7GY</b>	<b>NPJ7GY</b>		
	Ivory	<b>NP7I</b>	<b>NPJ7I</b>		
	White	<b>NP7W</b>	<b>NPJ7W</b>		
	Black	<b>NP13BK</b>	<b>NPJ13BK</b>	Brass Stainless Steel	<b>SB13</b> <b>SS13</b>
	Brown	<b>NP13</b>	<b>NPJ13</b>		
	Gray	<b>NP13GY</b>	<b>NPJ13GY</b>		
	Ivory	<b>NP13I</b>	<b>NPJ13I</b>		
	White	<b>NP13W</b>	<b>NPJ13W</b>		

**Hubbell Now Offers The Ability To Put 2 or 3 Communication Devices In a Single, Style Line® Plate**

Any combination of phone (6-position jack), cable TV (F-type connector) and Category 5e modular data jacks can be assembled onto a 2-port or 3-port frame—each sold individually so you can customize them as needed. Or the highly popular phone and cable TV combination is available with the frame and matching wallplate under a single catalog number, in all the popular colors.

Finally—a single communications plate that can take the place of 2 or 3 plates—available from a company you can trust for superior quality.

Hubbell's Marine communication frames and connectors deliver high quality data and multimedia transmission to the point of connection. Hubbell's 2 and 3 port Style Line® frames and leading edge connections allow for customized configurations. Install Hubbell's Marine communication offering and be assured a reliable connection.

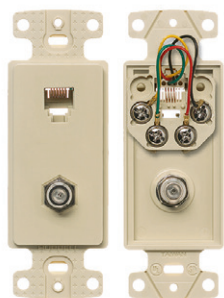

NS783I

**2 Port Communication Frame, Fully Loaded (6-Position Phone Jack, F-Type Cable TV Jack and Style Line® Plate Included)**

Color	No. of Ports	Connection Type	Catalog Number
Ivory	2	USOC, F-Type	<b>NS783I</b>
White	2	USOC, F-Type	<b>NS783W</b>

**Style Line® Frames, 2 Port and 3 Port Unloaded**

Color	No. of Ports	Connection Type	Catalog Number
Black	2	–	<b>NS612BK</b>
Gray	2	–	<b>NS612GY</b>
Ivory	2	–	<b>NS612I</b>
White	2	–	<b>NS612W</b>
Black	3	–	<b>NS613BK</b>
Gray	3	–	<b>NS613GY</b>
Ivory	3	–	<b>NS613I</b>
White	3	–	<b>NS613W</b>

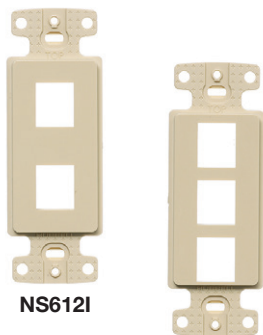

NS612I

NS613I

**Category 6 Modular Keystone Jacks**

Color	Wiring	No. Positions	Catalog Number
Black	T568A/T568B	8-Positions	<b>NSJ6BK</b>
Gray	T568A/T568B	8-Positions	<b>NSJ6GY</b>
Ivory	T568A/T568B	8-Positions	<b>NSJ6I</b>
White	T568A/T568B	8-Positions	<b>NSJ6W</b>

**Category 5e Modular Keystone Jacks**

Color	Wiring	No. Positions	Catalog Number
Black	T568A/T568B	8-Positions	<b>NSJ5EBK</b>
Gray	T568A/T568B	8-Positions	<b>NSJ5EGY</b>
Ivory	T568A/T568B	8-Positions	<b>NSJ5EI</b>
White	T568A/T568B	8-Positions	<b>NSJ5EW</b>

**USOC Modular Keystone Jacks**

Color	Wiring	No. Positions	Catalog Number
Black	USOC	6-Positions	<b>NSJUBK</b>
Gray	USOC	6-Positions	<b>NSJUGY</b>
Ivory	USOC	6-Positions	<b>NSJUI</b>
White	USOC	6-Positions	<b>NSJUW</b>

**F-Type Connector Keystone**

Color	Catalog Number
Black	<b>SFFGBK</b>
Gray	<b>SFFGGY</b>
Ivory	<b>SFFGEI</b>
White	<b>SFFGW</b>



NSJ6W



NSJ5EW



NSJUW



SFFGEI

## Non-Metallic While-In-Use Weatherproof Covers

- High-impact polycarbonate construction provides maximum durability
- Patented keyhole mounting system allows installation in under a minute
- Includes attached gasket and mounting hardware
- Pre-configured for GFCI with patented knockout technology for alternate devices
- Lockable tab
- NEMA 3R rated
- EXTRA DUTY® 5800 Series covers meet or exceed the extra duty rating per UL 514D and are NEMA 3R rated
- 2017 NEC® Compliant (Article 406.9A & B)
- cULus Listed



## 1-Gang Weatherproof Covers for Vertical or Horizontal Mounting

Description	Standard	EXTRA DUTY®
Non-metallic, black (standard) or gray (extra duty) with clear tinted cover, while-in-use, 16-in-1 configurations below.	<b>RW57300</b>	<b>RW58300</b>
Jumbo, non-metallic, black (standard) or gray (extra duty) with clear tinted cover, while-in-use, 16-in-1 configurations below.	<b>RW57350</b>	<b>RW58350</b>

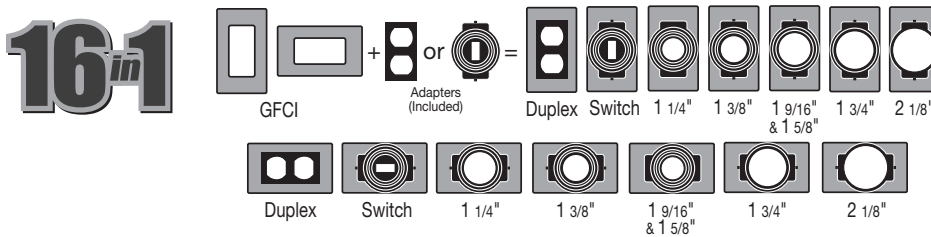

## 2-Gang Weatherproof Covers for Vertical Mounting Only

Description	Standard	EXTRA DUTY®
Non-metallic, black (standard) or gray (extra duty) with clear tinted cover, while-in-use, 55-in-1 configurations below	<b>RW57750</b>	<b>RW58750</b>

Note: Required by the NEC® for while-in-use outdoor power distribution. Thermoplastic covers provide protection for use in wet locations with the cover closed, NEMA® 3R rated. Meets 2017 NEC 406.9 – receptacles in damp or wet locations. Holes for padlocks are .40 inch.

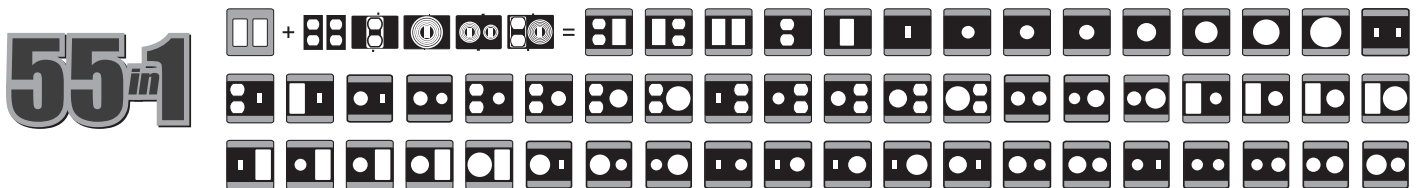

Multiple combinations of duplex, GFCI, switch, and rounds: 1 1/4", 1 3/8", 1 9/16", 1 5/8", 1 11/16", 2 1/8", 2 1/4", 2 7/16"



## Product Dimensions Inches (mm)

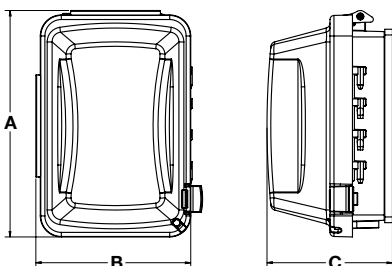

	1-Gang		Jumbo, 1-Gang		2-Gang	
	Standard	EXTRA DUTY®	Standard	EXTRA DUTY®	Standard	EXTRA DUTY®
A	5.54" (140.7)	5.90" (149.9)	5.54" (140.7)	5.92" (150.4)	5.54" (140.7)	5.54" (140.7)
B	3.79" (96.3)	4.18" (106.2)	3.79" (96.3)	4.20" (106.7)	5.43" (137.9)	5.43" (137.9)
C	3.07" (78.0)	3.00" (76.2)	5.08" (129.0)	5.10" (129.5)	3.07" (78.0)	3.07" (78.0)

NEC® is a registered trademark of the The National Electrical Code.  
NEMA® is a registered trademark of The National Electrical Manufacturers Association.

Dimensions in Inches (mm)

## Stainless Steel Weatherproof and Watertight Flip Covers

Stainless steel weatherproof flip covers are suitable for use in applications where corrosion and sanitation are vital concerns. Heavy duty #316 stainless steel provides an excellent finish and superior corrosion resistance in all applications. Models listed are typically used in indoor/outdoor applications such as, food/chemical processing, pharmaceutical and water treatment facilities. Meets Section 406.9 of NEC®.

- UL Type 3R:
  - Rain-tight and sleet (Ice) resistant
  - Self-closing lid
- UL Type 4X:
  - Watertight, dust-tight and corrosion resistant for wash-down application
  - Latching cover



## Features and Benefits



### Flip Cover Design

- Manufactured in heavy duty #316 stainless steel for increased corrosion resistance
- Polished finish for a clean aesthetic appearance
- Smooth surfaces to allow ease of cleaning
- Horizontal and vertical mounting positions
- Duplex and GFCI versions

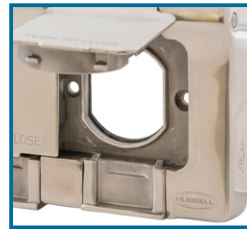

### Self-Closing Design

- Self-closing cover
- Neoprene gasket on underside of cover; for sealing when the cover is closed



HBLSS83R



HBLSS263R



HBLSS84X



HBLSS264X

## Stainless Steel Weatherproof Flip Covers

Description	Catalog Number
1-Gang, stainless steel duplex, 3R, self-closing cover.	<b>HBLSS83R</b>
1-Gang, stainless steel GFCI, 3R, self-closing cover.	<b>HBLSS263R</b>
1-Gang, stainless steel duplex, 4X, latching cover.	<b>HBLSS84X</b>
1-Gang, stainless steel GFCI, 4X, latching cover.	<b>HBLSS264X</b>

## Product Dimensions Inches (mm)

Catalog Number	Height	Width	Depth	Opening
HBLSS83R	3.04" (77.2)	4.85" (123.2)	.88" (22.4)	2.62" (66.5)
HBLSS263R	3.04" (77.2)	4.85" (123.2)	.88" (22.4)	2.76" (70.0)
HBLSS84X	3.04" (77.2)	4.85" (123.2)	.88" (22.4)	2.62" (66.5)
HBLSS264X	3.04" (77.2)	4.85" (123.2)	.88" (22.4)	2.76" (70.0)

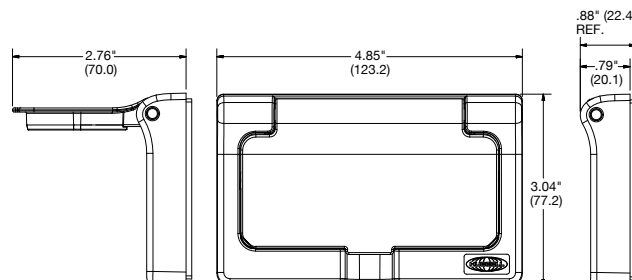

## Specifications

Base & Cover	Stainless Steel
Hinge Pin & Spring	Stainless Steel
Base & Cover Gasket	Elastomer
Back Gasket	Eva Form
Ground Screw	Steel, Zinc Plated
Mounting Screw	Stainless Steel

Dimensions in Inches (mm)

NEC® is a registered trademark of the The National Electrical Code.

**Marine Grade Weatherproof Plates**

Description	Color	Catalog Number
Thermoplastic vertical spring-loaded lift cover plate for weatherproofing ground fault receptacles and decorator-type devices. Marine drip-proof rated with stainless steel hardware. <b>IP44 SUITABILITY.</b>	Gray Yellow	<b>HBL5226</b> <b>HBL52CM26</b>
Same as above except for horizontal mounting.	Gray Yellow	<b>HBL5226H</b> <b>HBL52CM26H</b>
Valox® spring-loaded lift cover for weatherproofing duplex receptacles. Stainless steel screws and neoprene gasket included for mounting to FS/FD type weatherproof boxes. <b>IP20 SUITABILITY.</b>	Gray Yellow White	<b>HBL5221</b> <b>HBL52CM21</b> <b>HBL52CM21W</b>
Same as HBL52CM21 except for mounting to standard boxes.	Gray Yellow	<b>HBL5222</b> <b>HBL52CM22</b>
Valox spring-loaded lift cover for weatherproofing single straight blade receptacles. Stainless steel screws and neoprene gasket included. For mounting to FS/FD type weatherproof boxes. <b>IP44 SUITABILITY.</b>	Gray Yellow	<b>HBL7423WO</b> <b>HBL74CM23WO</b>
Valox spring-loaded lift cover for weatherproofing old style 26CM10 receptacle. Meets the most stringent requirements of UL's three listing categories for weatherproof plates. Stainless steel screws and neoprene gasket included for mounting to FS/FD type weatherproof boxes. <b>IP44 SUITABILITY.</b>	Gray Yellow	<b>HBL7424WO</b> <b>HBL74CM24WO</b>
Valox spring-loaded lift cover for weatherproofing HBL26CM10 receptacle. Meets the most stringent requirements of UL's three listing categories for weatherproof plates. Stainless steel screws and neoprene gasket included for mounting to FS/FD type weatherproof boxes. <b>IP44 SUITABILITY.</b>	Gray Yellow White	<b>HBL7425WOA</b> <b>HBL74CM25WOA</b> <b>HBL74CM25WOAW</b>
Valox lift cover for weatherproofing 50A receptacles. Meets requirements of the most stringent of UL's three listing categories for weatherproof plates. Stainless steel screws and a neoprene gasket included. For mounting to FS/FD type weatherproof boxes. <b>IP44 SUITABILITY.</b>	Gray Yellow	<b>HBL7774WO</b> <b>HBL77CM74WO</b>



**HBL52CM26**



**HBL52CM21W**



**HBL52CM26H**

**Commercial Grade Weatherproof Plates**

Available in a host of configurations—Twist-Lock® and straight blade receptacles in single or duplex as well as switches—these plates are perfect for marine use. The PVC resists deterioration over time and has high tensile and impact strength. Each plate comes with a tightly sealing, rubberized gasket and a super strong lift cover spring.

Description	Catalog Number
Gray thermoplastic weatherproof lift cover for toggle switches (such as CS115). For vertical mounting in standard or FS/FD type boxes.	<b>HBL5201</b>
Gray PVC weatherproof lift cover for duplex receptacles (such as HBL52CM62). For vertical mounting in standard or FS/FD type boxes.	<b>CWP8CR</b>
Gray PVC weatherproof lift cover for ground fault receptacles (such as GF5252MGYA) and Style Line® receptacles. For vertical mounting in standard or FS/FD type boxes.	<b>CWP26CR</b>
Same as CWP26CR except white in color.	<b>CWP26CRW</b>



**HBL52CM21**



**HBL74CM23WO**



**CWP8CR**



**CWP26CR**



**HBL5201**



**HBL77CM74WO**

Valox® is a trademark of SABIC Innovative Plastics, acquired from General Electric Company.

## Marine Grade Dockside Boxes and Covers

30 cu. in. FD box made of high impact thermoplastic material. Accepts duplex and single receptacles up to 50A Twist-Lock®.



## Features and Benefits



### Housing Design

- ¾" NPT and 1" NPT threaded hub options
- 30 cu. in. FD box made of high impact thermoplastic material
- External mounting feet, accepts #10 screw
- Stainless steel mounting/grounding bracket



### Housing Design

- 55° angle adapter (15 cu. in.)
- External mounting feet, accepts #8 screw
- Stainless steel mounting/grounding bracket



HBL60CM83A



HBL60CM88



HBLP14FS



PH6619



HBL6081

HBL6082

## FD Boxes, Angled Adapters, Kits and Covers

Boxes	Gray	White	Yellow
(2) ¾" NPT Hubs, FD Boxes	<b>HBL6083</b>	<b>HBL60CM83WA</b>	<b>HBL60CM83A</b>
(2) 1" NPT Hubs, FD Boxes	<b>HBL6084</b>	<b>HBL60CM84WA</b>	<b>HBL60CM84A</b>
Adapters*			
55° Angle Adapters	<b>HBL6055*</b>	<b>HBL60CM55W*</b>	<b>HBL60CM55*</b>
Kits			
(2) ¾" NPT Hubs, Box/Adapter Kits	<b>HBL6083AK</b>	<b>HBL60CM83WAK</b>	<b>HBL60CM83AK</b>
(2) 1" NPT Hubs, Box/Adapter Kits	<b>HBL6084AK</b>	<b>HBL60CM84WAK</b>	<b>HBL60CM84AK</b>
Covers			
Blank Cover Plates	<b>HBLP14FS</b>	<b>HBL60CM88W</b>	<b>HBL60CM88</b>

Note: \*Adapters are not UL Listed, nor UL Type 4X. For UL Type 4X rating, use receptacles in a FD box.

## Marine Grade Dockside Boxes and Covers

Description	Catalog Number
Black phenolic type FS (shallow) weatherproof box has two ¾ in. (19.1) I.P.S. molded-in knockouts. 4.56 in. H x 2.94 in. W x 2.19 in. D (115.9H x 74.6W x 55.6D) and has 16 cubic inch capacity.	<b>HBL6080OS</b>
Black non-metallic FS box with ¾ in. threaded hubs used for mounting phone and TV outlets and PH6595 recreational vehicle inlet. Cord connector included for strain relief and to maintain watertight integrity of box when cable is used. PVC adapter also included for connection of PVC conduit to box.	<b>PH6619</b>
Black phenolic junction box with four ¾ in. (19.1) I.P.S. molded-in knock-outs. Has 4.13 in. (104.8) diameter and is 1.88 in. (47.6) deep.	<b>HBL6081</b>
Phenolic blank cover, ¼ in. (6.4) thick, for HBL6081 box.	<b>HBL6082</b>
Black phenolic blank cover plate for HBL6080OS.	<b>HBL6087</b>
Yellow Valox® blank cover plate for use with FS and FD type boxes.	<b>HBL60CM88</b>

Valox® is a trademark of SABIC Innovative Plastics, acquired from General Electric Company.

## Non-Metallic Vapor-tight Incandescent Fixtures

These non-metallic, vapor-tight incandescent fixtures offer long life and trouble-free lighting in wet locations in marinas and on boats. Some features of these new units are:

- UV resistant, gray, glass filled thermoplastic polyester box, mounting adapters and globe guards resists abuse and harmful effects of the elements
- Excellent temperature operating range of -40°F (-40°C) to +302°F (150°) for use in areas with wide temperature variations or extreme ambient temperatures
- High temperature silicone gasketing maintains integrity and molded threads for ease of installation/removal
- Heat resistant glass globe withstands thermal shock in wet locations and has thread type mounting to assure weathertight sealing
- High strength protective globe guard helps prevent accidental globe and lamp breakage
- Accommodates Type A incandescent lamps up to 150 watts
- UL 1598 Standard for luminaries
- UL 1598A Marine type luminaries



NVX15GHGA



NVA15GHGA



NVBA



VCGP100



HBL6085



HBL10CM22S

## Lighting and Lighting Fixtures

Description	Catalog Number
Ceiling mount non-metallic, vapor-tight incandescent luminaries including the fixture, mounting box, guard and heat resistant glass globe. Accepts up to 150 watt Type A incandescent lamp (not included).	<b>NVX15GHGA</b>
Pendant mount non-metallic, vapor-tight incandescent luminaries including fixture, mounting cap, guard and heat resistant glass globe. Accepts up to 150 watt Type A incandescent lamp (not included).	<b>NVA15GHGA</b>
Wall mount bracket only to adapt NVX15GHGA ceiling mount fixture to a wall mount fixture. Order NVBA and NVX15GHGA to get wall mount fixture.	<b>NVBA</b>
Replacement guard to NVX15GHGA and NVA15GHGA.	<b>NVGA</b>
Heat resistant replacement globe for NVX15GHGA and NVA15GHGA. Made of tempered glass.	<b>VCGP100</b>

## Nylon Watertight Strain Relief Cord Connectors

These Hubbell nylon cord connectors provide strain relief and a watertight seal where cable enters a piece of equipment, panel, or box. A patented GOTCHA® ring, with a split and hinge design, allows for better adjustment to the cord as the connector nut is tightened, providing superior cord gripping compared to other types. A soft neoprene bushing compresses to keep liquids out and allows the nut to be easily tightened.

Description			Catalog Number
A gray male PVC adapter with ¼ in. NPT pipe thread for adapting PVC conduit to FS and FD boxes with ¼ in. NPT hub (HBL6080, HBL6080OS, HBL60CM83). Not UL Listed.			<b>HBL6085</b>
Description	NPT Hub Size	Diameter Range	Catalog Number
Straight nylon cord connector	½ in.	.25–.38 in. (6.4–9.5)	<b>HBL10CM22S</b>
	½ in.	.38–.50 in. (9.5–12.7)	<b>HBL10CM23S</b>
	¾ in.	.38–.50 in. (9.5–12.7)	<b>HBL10CM35S</b>
	¾ in.	.50–.63 in. (12.7–15.9)	<b>HBL10CM36S</b>
	¾ in.	.63–.75 in. (15.9–19.1)	<b>HBL10CM37S</b>
	1.0 in.	.63–.75 in. (15.9–19.1)	<b>HBL10CM41S</b>

### Codes and Specifications

#### ABYC Standard, July 2015, E-11 Excerpts.

**11.4 DEFINITIONS** – For the purposes of this standard, the following definitions apply.

**11.4.11 Equipment Leakage Circuit Interrupter (ELCI)** - A residual current device which detects equipment ground fault leakage current and disconnects all current carrying conductors from the supply source at a preset trip threshold.

**11.4.14 Ground fault circuit interrupter (GFCI)** - A device intended for the protection of personnel that functions to de-energize a circuit, or portion thereof, within an established period of time when a current to ground exceeds some predetermined value that is less than that required to operate the overcurrent protective device of the supply circuit.

**11.4.34 Watertight** - Constructed so that water will not enter the enclosure under the test conditions specified in NEMA Standard 250, Type 6P or IEC Standard 60529 Type IP67.

**11.4.35 Weatherproof** - Constructed or protected so that exposure to the weather will not interfere with successful operation under the test conditions specified in NEMA Standard 250, Type 3 or IEC Standard 60529 Type IP54.

#### 11.11 GROUND FAULT PROTECTION – AC SYSTEMS

**11.11.1** An Equipment Leakage Circuit Interrupter (ELCI) or Type A Residual Current Device (RCD) shall be installed with or in addition to the main shore power disconnect circuit breaker(s) or at the additional overcurrent protection as required by E-11.10.2.8.3 whichever is closer to the shore power connection.

**11.11.1.1** Trip level shall be a maximum of 30mA. The trip time shall be a maximum of 100ms.

**11.11.1.4** The ELCI shall be readily accessible.

*Note: A ground fault circuit interrupter (GFCI) may be used on single phase AC circuits to provide additional protection for personnel and equipment.*

**11.11.5** GFCI receptacle devices shall meet the requirements of Underwriters Laboratories' standard UL 943, Ground Fault Circuit Interrupters and the requirements of UL 498, Electrical Attachment Plugs and Receptacles.

*Note: GFCI receptacle devices may be installed as part of a convenience outlet installation either in single outlet applications or in multiple feed through installations. (See E-11.13.3.5)*

#### 11.12 SWITCHES

**11.12.1.1** Switches shall have voltage ratings not less than the system voltage, current ratings not less than the connected load and shall be rated for the type of load, i.e., inductive or resistive.

**11.12.3.1** Switches used in branch circuits shall simultaneously open all ungrounded conductor(s) of the branch circuit.

#### 11.13 PLUGS AND RECEPTACLES

**11.13.1.1 Receptacles shall be installed in locations not normally subject to rain, spray, or flooding but if receptacles are used in such areas the following shall apply:**

**11.13.1.1.1 Receptacles installed in locations subject to rain, spray, or splash shall be weatherproof when not in use.**

*Note: Weatherproofing may be provided by means such as spring-loaded, self-closing, or snap type receptacle covers.*

**11.13.1.1.2** Receptacles installed in areas subject to flooding or momentary submersion shall be of a watertight design as may be provided by a threaded, gasketed cover.

**11.13.1.3** Receptacles and matching plugs used on AC systems shall not be interchangeable with receptacles and matching plugs used on DC systems.

**11.13.3.1** Receptacles shall be installed in boxes that meet the requirements of UL 514A, Metallic Outlet Boxes, or 514C, Non-metallic Outlet Boxes, Flush Device Boxes And Covers.

**11.13.3.2** Receptacles shall be of the grounding type with a terminal provided for the grounding (green) conductor as shown in Figure 11, Figure 12 and Figure 13 of ABYC E-11.

**11.13.3.3** Power wiring for receptacles shall be connected so that the grounded (white) conductor attaches to the terminal identified by the word "white" or a light color (normally white or silver). The ungrounded conductor(s) shall be attached to the terminal(s) identified by a dark color (normally brass or copper) and, optionally, the letters X, Y and Z or L1, L2 and L3.

**11.13.3.4** A branch circuit supplying a combination of receptacle loads and permanently connected loads shall not supply permanently connected loads in excess of the following:

**11.13.3.4.1** 600 watts for a 15 ampere circuit.

**11.13.3.4.2** 1000 watts for a 20 ampere circuit.

**11.13.3.5** If installed in a head, galley, machinery space, or on a weather deck, the receptacle shall be protected by a Type A (nominal 5 milliamperes) Ground Fault Circuit Interrupter (GFCI). (See E-11.11.)

*Note: GFCI receptacle devices are not necessarily ignition protected per E-11.5.1.4.*

#### 11.6.2.2 SHORE POWER

**11.6.2.2.1** Power Inlet - The receptacle, or receptacles, installed to receive a connecting cable to carry AC shore power aboard shall be a male type connector.

**11.6.2.2.2** Power inlets installed in locations subject to rain, spray, or splash shall be weatherproof whether or not in use.

**11.6.2.2.2.1** Power inlets installed in areas subject to flooding or momentary submersion shall be watertight whether or not in use.

**11.6.2.2.2.3** Metallic power inlets installed on metallic or carbon fiber reinforced boats using an isolation transformer or a galvanic isolator shall be insulated from metallic structure and components. On non-metallic boats using an isolation transformer or a galvanic isolator the power inlet shall be insulated from metallic components connected to the boat's ground.

**11.6.2.2.1.1** Shore Power Cable – On each boat equipped with an AC shore power system, a shore power cable that contains the conductors for the power circuit and a grounding (green) conductor shall be provided.

**11.6.2.2.1.2** Except where the shore power cable is permanently connected to the boat, the boat end of this cable shall be terminated with a locking and grounding female type connector to match the boat power inlet. (See Figure 12 and Figure 13 of ABYC E-11).

**11.6.2.2.1.3** The shore power cable shall be flexible cord with the minimum properties of Type SOW, STW, STOW, SEOW, or STOOW and shall be suitable for outdoor use. The shore connection end of this cable shall be fitted with a locking and grounding type plug with the required number of poles and shall comply with Article 555 of the National Electrical Code. (See Figure 13 and Table VII-A of ABYC E-11).

*EXCEPTION: Pin and sleeve devices in accordance with Figure 14 of ABYC E-11.*



# Marine Products Catalog Number Index

Catalog Number	Page	Catalog Number	Page	Catalog Number	Page	Catalog Number	Page
BB100N	20, 21	CWP8CR	49	HBL26CM13V	12	HBL61CM03	9
BB201W	24	CWP26CR	42, 49	HBL31CM28	29	HBL61CM03LED	9
BB301W	24	CWP26CRW	42, 49	HBL31CM29	29	HBL61CM03W	9
BB601W	24	DR15	43	HBL32AITSS	31	HBL61CM03WLED	9
BB1001W	20, 21	DR15AL	43	HBL32AITSSB	31	HBL61CM05	9
BB1002W	20, 21	DR15ALTR	43	HBL32AITW	31	HBL61CM05LED	9
BR15BLKWRTR	43	DR15BLK	43	HBL47CM00	36	HBL61CM05W	9
BR15GRYWRTR	43	DR15BLKTR	43	HBL47CM15	36	HBL61CM05WLED	9
BR15WRTR	43	DR15BLKWRTR	43	HBL47CM16	36	HBL61CM08	9
BR15LAWRTR	43	DR15GRY	43	HBL47CM20C	36	HBL61CM08LED	9
BR15WHIWRTR	43	DR15GRYTR	43	HBL47CM29C	36	HBL61CM08W	9
BR15WRTR	43	DR15GRYWRTR	43	HBL50AITSS	31	HBL61CM08WLED	9
CA100	20, 21	DR15I	43	HBL50AITSSB	31	HBL61CM22	29
CC100	20, 21	DR15ITR	43	HBL50AITW	31	HBL61CM22W	29
CR15	43	DR15WRTR	43	HBL52CM21	36, 37, 39, 49	HBL61CM25	29
CR15AL	43	DR15LA	43	HBL52CM21W	36, 39, 49	HBL61CM42	17
CR15ALTR	43	DR15LATR	43	HBL52CM22	36, 37, 39, 49	HBL61CM42LED	17
CR15BLK	43	DR15LAWRTR	43	HBL52CM26	49	HBL61CM42W	17
CR15BLKTR	43	DR15TR	43	HBL52CM26H	49	HBL61CM42WLED	17
CR15GRY	43	DR15WHI	43	HBL52CM61	37	HBL61CM43	15
CR15GRYTR	43	DR15WHITR	43	HBL52CM62	37, 43	HBL61CM43LED	15
CR15I	43	DR15WHIWRTR	43	HBL52CM62I	37, 43	HBL61CM52	17
CR15ITR	43	DR15WRTR	43	HBL52CM66C	37	HBL61CM52LED	17
CR15LA	43	FT202W	24	HBL52CM66V	37	HBL61CM52W	17
CR15LATR	43	FW60100	20, 21, 24	HBL52CM69C	37	HBL61CM52WLED	17
CR15TR	43	GF5262SGI	42	HBL52CM69V	37	HBL61CM53	15
CR15WHI	43	GF5262SGW	42	HBL52CM80C	37	HBL61CM53LED	15
CR15WHITR	43	GF5262SGYEL	42	HBL53CM61	39	HBL61CM54	29
CR16277	14	GFP6C15M	42	HBL53CM62	39	HBL61CM55	29
CR16279	16	GFP15M	42	HBL53CM66C	39	HBL61CM56	29
CR16914	32	GFP25C15M	42	HBL53CM69C	39	HBL61CM64	37
CS50EXT4	19	GFP315A	42	HBL60CM17	37, 39	HBL61CM64BK	37
CS50EXT5	19	GFRST15I	42	HBL60CM18	37, 39	HBL61CM65	39
CS75IT4	19	GFRST15LA	42	HBL60CM19	39	HBL61CM71	29
CS75IT5	19	GFRST15W	42	HBL60CM23	36	HBL61CM72	29
CS100IT4	19	GFT2G	40	HBL60CM24	36	HBL61CM100	29
CS100IT5	19	GFWRST15I	42	HBL60CM31	11, 38	HBL63AITSS	31
CS115	44	GFWRST15LA	42	HBL60CM31V	12, 38	HBL63AITSSB	31
CS115BK	44	GFWRST15W	42	HBL60CM31W	11, 38	HBL63AITW	31
CS115GY	44	HBL10CM22S	51	HBL60CM32	11, 38	HBL63CM60	14
CS115I	44	HBL10CM23S	51	HBL60CM32V	12, 38	HBL63CM61	15
CS115LA	44	HBL10CM35S	51	HBL60CM33	11, 25	HBL63CM64	16
CS115W	44	HBL10CM36S	51	HBL60CM33V	12	HBL63CM65	17
CS315	44	HBL10CM37S	51	HBL60CM33W	11, 25	HBL63CM69	17
CS315BK	44	HBL10CM41S	51	HBL60CM55	50	HBL63CM70	15
CS315GY	44	HBL17CM50	44	HBL60CM55W	50	HBL64CM54	29
CS315I	44	HBL21CM28	29	HBL60CM75	10	HBL64CM55	29
CS315LA	44	HBL21CM29	29	HBL60CM83A	34, 50	HBL64CM56	29
CS315W	44	HBL23CM10	38	HBL60CM83AK	50	HBL64CM57	29
CS754	19	HBL23CM11	38	HBL60CM83WA	34, 50	HBL74CM23WO	37, 39, 49
CS1004	19	HBL23CM11V	38	HBL60CM83WAK	50	HBL74CM24WO	11, 49
CW100IT4	19	HBL23CM13	38	HBL60CM84A	50	HBL74CM25WOA	34, 38, 49
CW100IT4W	19	HBL26CM10	11	HBL60CM84AK	50	HBL74CM25WOAW	34, 38, 49
CW100IT5	19	HBL26CM11	11	HBL60CM84WA	50	HBL77CM15	14, 16, 25
CW125IT4	19	HBL26CM11V	12	HBL60CM84WAK	50	HBL77CM15W	14, 16, 25
CW125IT5	19	HBL26CM11VB	12	HBL60CM88	50	HBL77CM16	15, 17, 25
CW754	19	HBL26CM13	11	HBL60CM88W	50	HBL77CM16W	15, 17, 25

# Catalog Number Index

Catalog Number	Page	Catalog Number	Page	Catalog Number	Page	Catalog Number	Page
HBL77CM17	14, 16	HBL1283	44	M4100C12	20	NP13I	45
HBL77CM67	14, 16	HBL1283I	44	M4100C12R	20	NP13W	45
HBL77CM74WO	15, 17, 49	HBL1795	44	M4100P12	20	NP18	45
HBL100AITSS	31	HBL5200	40	M4100R12	20	NP18BK	45
HBL100AITSSB	31	HBL5201	49	M5100B7R	21	NP18GY	45
HBL100AITW	31	HBL5221	36, 37, 39, 49	M5100B9R	21	NP18I	45
HBL105GF	29	HBL5222	36, 37, 39, 49	M5100C7	21	NP18W	45
HBL303INT	10	HBL5226	49	M5100C7R	21	NP26	45
HBL303NM	10	HBL5226H	49	M5100C9	21	NP26BK	45
HBL303NMELCI	7	HBL5251	43	M5100C9R	21	NP26GY	45
HBL303NMELCIS	7	HBL5251I	43	M5100P7	21	NP26I	45
HBL303SS	10	HBL5273L	29	M5100P9	21	NP26W	45
HBL303SSELCI	7	HBL5361	43	M5100R7	21	NP82	45
HBL303SSELCIS	7	HBL5361I	43	M5100R9	21	NP82BK	45
HBL303SSO	10	HBL6055	50	M5200BS1R	23	NP82GY	45
HBL316CRCX	25	HBL6079	44	M5200CS1	23	NP82I	45
HBL316CS	25	HBL6080OS	34, 50	M5200CS1R	23	NP82W	45
HBL316CS25	25	HBL6081	50	M5200PS1	23	NP126	45
HBL316NM	25	HBL6082	50	M5200RS1	23	NP126BK	45
HBL316SSX	25	HBL6083	34, 50	MB2003W	23	NP126GY	45
HBL320B6W	24	HBL6083AK	50	MB2004W	23	NP126I	45
HBL320C6W	24	HBL6084	50	MH11	35	NP126W	45
HBL320P6W	24	HBL6084AK	50	MHB11	35	NP262	45
HBL320R6W	24	HBL6085	51	MR11LRSP	35	NP262BK	45
HBL328DCC	34	HBL6087	50	MR11MSP	35	NP262GY	45
HBL328DCP	34	HBL7423WO	37, 39, 49	MR11SP	35	NP262I	45
HBL328DCPW	34	HBL7424WO	11, 49	MR21SP	35	NP262W	45
HBL328DCR	34	HBL7425WOA	11, 34, 38, 49	MR123LRSP	35	NPJ1	45
HBL328DCRW	34	HBL7774WO	15, 17, 49	MR123MMSP	35	NPJ1BK	45
HBL330B6W	24	HBL8200ILI	43	MR123MSP	35	NPJ1GY	45
HBL330C6W	24	HBLCBINM	10	MR123SP	35	NPJ1I	45
HBL330P6W	24	HBLCBISS	10	MR223MMSP	35	NPJ1W	45
HBL330R6W	24	HBLP14FS	50	MR223SP	35	NPJ2	45
HBL332CRCX	25	HBLPHTVNM	32	MSB1	35	NPJ2BK	45
HBL332CS	25	HBLPHTVSS	32	NP1	45	NPJ2GY	45
HBL332NM	25	HBLRRELCI	7	NP1BK	45	NPJ2I	45
HBL332SSX	25	HBLSS83R	48	NP1GY	45	NPJ2W	45
HBL360B6W	24	HBLSS84X	48	NP1I	45	NPJ7	45
HBL360C6W	24	HBLSS263R	48	NP1W	45	NPJ7BK	45
HBL360P6W	24	HBLSS264X	48	NP2	45	NPJ7GY	45
HBL360R6W	24	HBLT26CM11	40	NP2BK	45	NPJ7I	45
HBL363CRC	25	HBLTVSS	32	NP2GY	45	NPJ7W	45
HBL363CRP	25	LR100	20, 21	NP2I	45	NPJ8	45
HBL363CRR	25	M11LRGSP	35	NP2W	45	NPJ8BK	45
HBL363SSX	25	M11LRSP	35	NP7	45	NPJ8GY	45
HBL503NM	14	M11LTR	35	NP7BK	45	NPJ8I	45
HBL503SS	14	M11MSP	35	NP7GY	45	NPJ8W	45
HBL504NM	16	M11SP	35	NP7I	45	NPJ13	45
HBL504SS	16	M21SP	35	NP7W	45	NPJ13BK	45
HBL504SSELCI	7	M123LTR	35	NP8	45	NPJ13GY	45
HBL504SSELCIH	7	M123MMSP	35	NP8BK	45	NPJ13I	45
HBL1221IL	44	M123MSP	35	NP8GY	45	NPJ13W	45
HBL1221PL	44	M123SP	35	NP8I	45	NPJ18	45
HBL1223IL	44	M223JSP	35	NP8W	45	NPJ18BK	45
HBL1223PL	44	M223MMSP	35	NP13	45	NPJ18GY	45
HBL1281	44	M223SP	35	NP13BK	45	NPJ18I	45
HBL1281I	44	M4100B12R	20	NP13GY	45	NPJ18W	45

# Catalog Number Index

Catalog Number	Page	Catalog Number	Page	Catalog Number	Page	Catalog Number	Page
NPJ26	45	PH6599W	32	USB15C5W	41		
NPJ26BK	45	PH6619	33, 50	USB20AC5I	41		
NPJ26GY	45	PH6624	32	USB20AC5LA	41		
NPJ26I	45	PH6625	32	USB20AC5W	41		
NPJ26W	45	PH7440	32	VCGP100	51		
NPJ82	45	PH7499	32	WC310280	9		
NPJ82BK	45	RPL30P	9, 12	YC306250	15		
NPJ82GY	45	RW57300	47	YC310250	9		
NPJ82I	45	RW57350	47	YC406250	17		
NPJ82W	45	RW57750	47	YQ100PLUS	26		
NPJ126	45	RW58300	47	YQ230	26		
NPJ126BK	45	RW58350	47				
NPJ126GY	45	RW58750	47				
NPJ126I	45	SB1	45				
NPJ126W	45	SB2	45				
NPJ262	45	SB7	45				
NPJ262BK	45	SB8	45				
NPJ262GY	45	SB13	45				
NPJ262I	45	SB18	45				
NPJ262W	45	SB26	45				
NS612BK	46	SB82	45				
NS612GY	46	SB126	45				
NS612I	46	SB262	45				
NS612W	46	SFFGBK	46				
NS613BK	46	SFFGEI	46				
NS613GY	46	SFFGGY	46				
NS613I	46	SFFGW	46				
NS613W	46	SHC1048	31				
NS783I	46	SHC1059	31				
NS783W	46	SHC1061	31				
NSJ5EBK	46	SR3050	10, 14, 16				
NSJ5EGY	46	SS1	45				
NSJ5EI	46	SS2	45				
NSJ5EW	46	SS7	45				
NSJ6BK	46	SS8	45				
NSJ6GY	46	SS13	45				
NSJ6I	46	SS18	45				
NSJ6W	46	SS26	45				
NSJUBK	46	SS82	45				
NSJUGY	46	SS126	45				
NSJUI	46	SS262	45				
NSJUW	46	SS720	11				
NVA15GHGA	51	SS725	11				
NVBA	51	SS750	15, 17				
NVGA	51	TV97	33				
NVX15GHGA	51	TV98	33				
PC60	24	TV98W	33				
PC100	20, 21	TV99	33				
PC320	24	TV99W	33				
PC3430	24	USB15A5I	41				
PH6595	33	USB15A5LA	41				
PH6596	33	USB15A5W	41				
PH6597	33	USB15AC5I	41				
PH6597TV	33	USB15AC5LA	41				
PH6598	32	USB15AC5W	41				
PH6598W	32	USB15C5I	41				
PH6599	32	USB15C5LA	41				

# HUBBELL

## Marine Products



**HUBBELL**<sup>®</sup>  
Wiring Device-Kellems

[www.hubbell.com/wiringdevice-kellems/en/hubbell-marine](http://www.hubbell.com/wiringdevice-kellems/en/hubbell-marine)

