



Universal H-Series Diagnostics Manual



HxxxFD(N/P)

HxxxFD(N/P)ASME



Table of Contents

Important Safety Instructions	Page 1	EE and CE Codes	Page 35
Sequence of Operation	Pages 2-3	IO and SB Codes	Page 36
Electric and Gas Connections	Pages 4-5	SF and HS Codes	Page 37
Control Hookup	Pages 6-7	HS and PF Codes	Page 38
Gas Pressure Testing	Pages 8-9	HF Code	Page 39
Control Board Connections	Page 10	LO Code	Pages 40-43
Fuse Board Connections	Page 11	IF Code	Pages 44-46
Fuses	Page 12-13	AC Code	Page 47
Heater will not power up	Pages 14-22	AO Code	Page 48-50
Open FC1 and/or FC2 Fuse	Pages 23-24	Temperature Lock Out	Page 51
Open FC3 and/or F1 Fuse	Pages 25-28	Heat Exchanger	Page 52-53
Open FC4 Fuse	Pages 29-31	Flow Charts	Pages 54-59
Diagnostic Codes	Page 32	Wiring Schematic	Page 60
BD Code	Pages 33-34	Wiring Diagram	Page 61

Safety

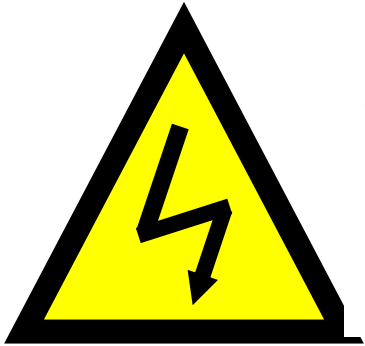

Warning



High Voltage Electrocutation Hazard

Read and follow all instructions in the service and installation manual and on the equipment. Failure to follow instructions can cause severe injury and/or death.

Hazardous voltage can shock, burn, cause serious injury and or death. To reduce the risk of electrocution and or electric shock hazards:

- Only qualified technicians should attempt repairs.
 - Replace damaged wiring immediately.
- Insure Heater is properly grounded and bonded.

UHS Sequence Of Operation

The control continually compares the Set Temp to the actual water temp. When the water temp is 1° below the set point the sequence starts.

1. The control checks for open Blower Vacuum Switch
2. Blower starts pre-purge cycle as the igniter heats up (20 Sec).
3. The Control checks for a closed Blower Vacuum Switch.
4. At proper Igniter temp a 4 second trial begins. Gas valve opens and monitors flame sense. The blower will turn off for one second. The Igniter is de-energized at flame sense or at completion of 4 sec trial. If the flame is sensed, The Blower Vacuum Switch, Control Loop, Temp Sensor & Flame Sensor are constantly monitored during call for heat.
5. When set temp is reached, the control ends the call for heat. The gas valve is de-energized, and the flame is extinguished.
6. The blower will operate for a 30 second post purge.

UHS Sequence Of Operation

Failure to Light – Retry Sequence

1. Gas Valve de-energizes, 30 second blower post purge.
2. Starts over at #2 of heating mode sequence.
3. Retries 3 times until lockout (IF Code).
4. Waits 60 minutes then retries 3 more times.
5. Will continue to retry every 60 minutes, until demand for heat is stopped.

Note: When making keypad entries of any type there may be a 5-10 sec delay for certain situations.

UHS Electrical and Gas Connections

(Beginning Sept 08)

Located on both the left and right side of the heater cabinet.

Gas
Supply

High
Voltage

Bonding
Lug

Low
Voltage

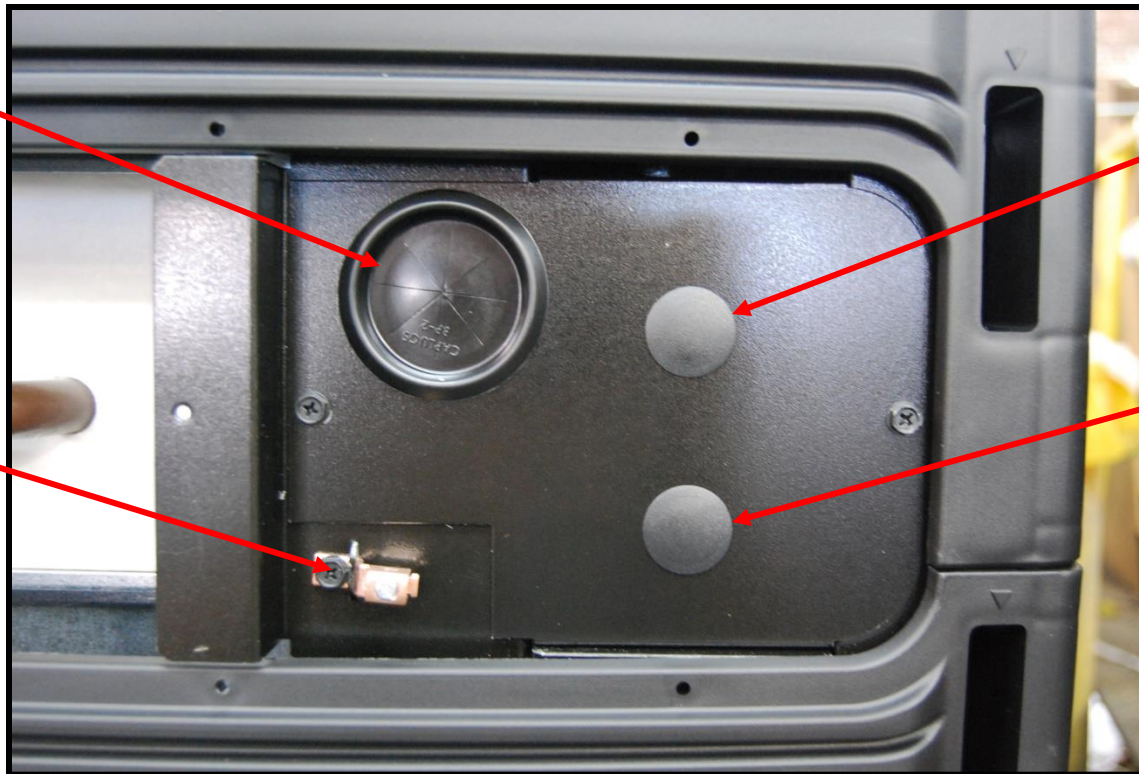

Electrical & Control Connections

(Beginning Sept 08)

120 VAC or 240 VAC Connection			
240V FACTORY WIRED	L1	L2	G
120V SEE MANUAL	L	N	G

1303277301

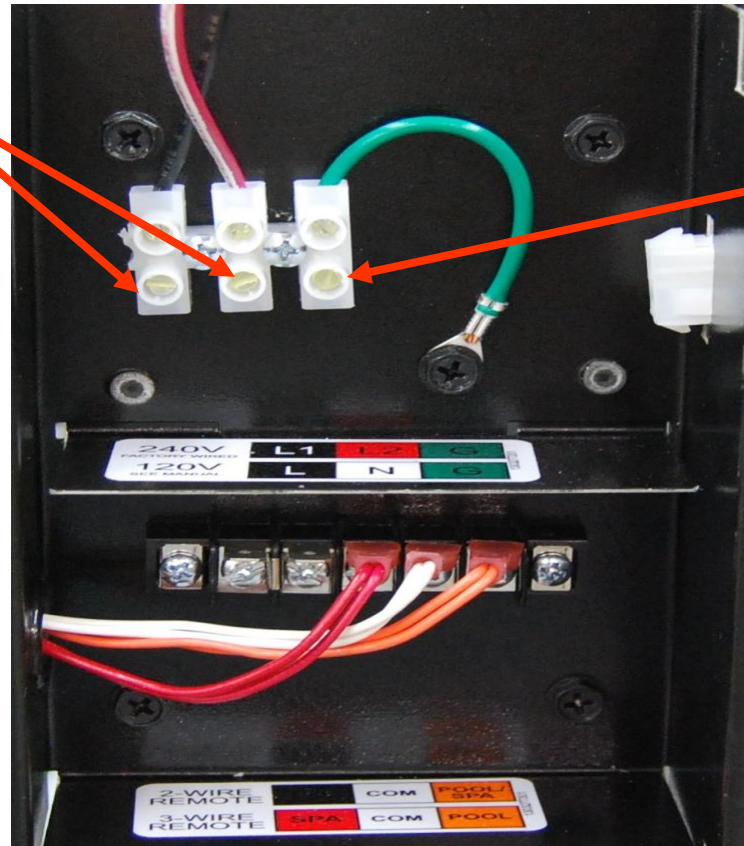

Ground

Three Wire Remote Connection:
Orange (Pool),
White (24V), and
Red (Spa).

Two Wire Remote Connection:
Orange (Pool) and
White (Common)

2-WIRE REMOTE	COM	POOL/ SPA	
3-WIRE REMOTE	SPA	COM	POOL

1303277301

Control Hookup (Through August 08)

Control hookup located outside control box.

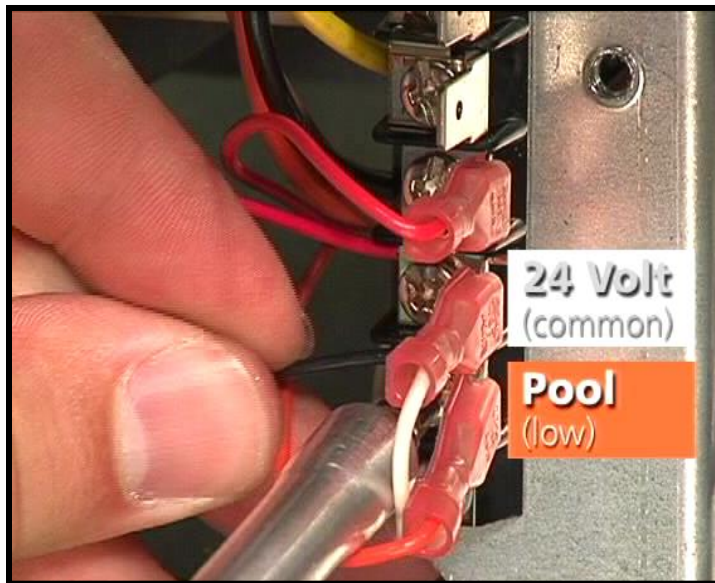

Two Wire Hook up:
Orange (Pool) and White (24v)

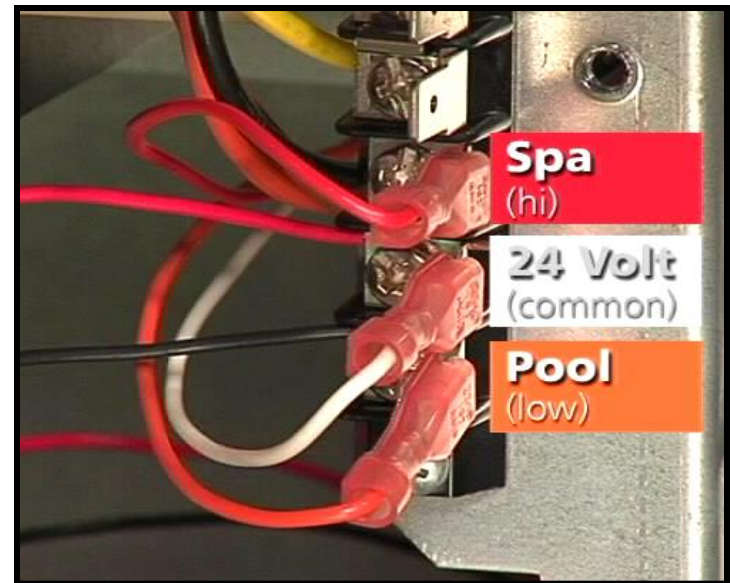

Three Wire Hook up:
Orange (Pool), White (24v), and
Red (Spa)

Control Configuration– Two wire

Step 1: Press the Mode button to place the heater in Standby Mode.

Step 2: Hold the Down Arrow and Mode buttons simultaneously for 3 seconds for Bypass operation. “bo” will be displayed on the screen.

Step 3: Heater must then be in Spa or Pool Mode for operation. The heater will fire when instructed by the external control.



Note: 104° maximum temperature.

Gas Pressure Testing

Step 1:

Measure the inlet Static Pressure (valve off) and Load Pressure (valve on / energized).



The Static & Load values should be within the levels listed on the Data Plate, example on **Page 9**.

Step 2:

Measure the outlet Manifold Pressure (valve on / energized).



Manifold reading should be between 1.8" - 2.0" w.c for Natural or 6.8" - 7.0" w.c for Propane.

Refer to Installation Manual for proper gas line sizing.

Gas Pressure Testing

Step 3:

If inlet pressures are correct and the Manifold Pressure is low or high, adjust the Manifold Pressure at the Gas Valve.

Remove plug



Turn clockwise to increase pressure.

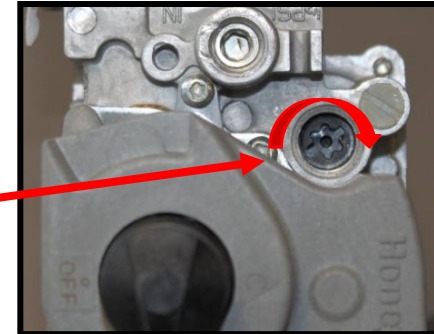

Heater Data Plate located on bottom front inside heater

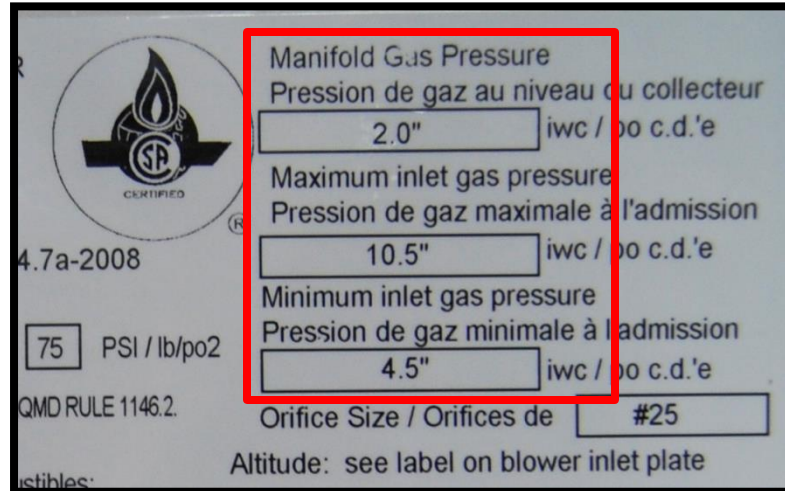

Note: Never adjust valve if incoming pressure is not correct.

Integrated Control Board (ICB) Connections

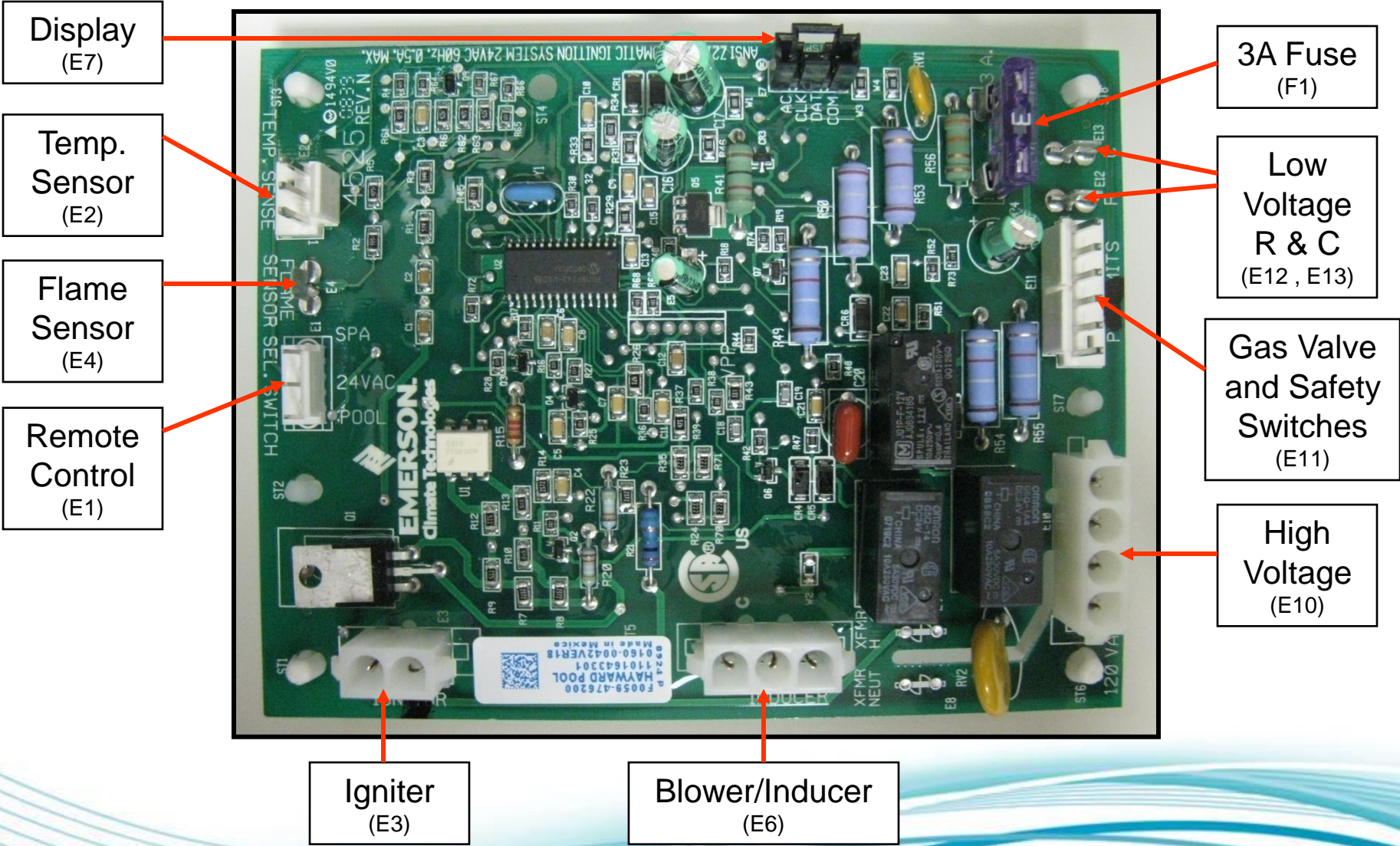

Fuse Circuit Board Connections

Fuse board configuration up to Oct 2010

Power Connection for junction boxes. (after Aug 08) (P1)

Transformer Primary (P3)

Low Voltage (P5)

High Voltage (P6)

Terminal block for field wiring connections. (TB1) (before Aug 08)

Transformer Secondary (P4)

Configure heater for 240 VAC or 120 VAC by installing correct plug. (P2). 240 VAC plug factory installed

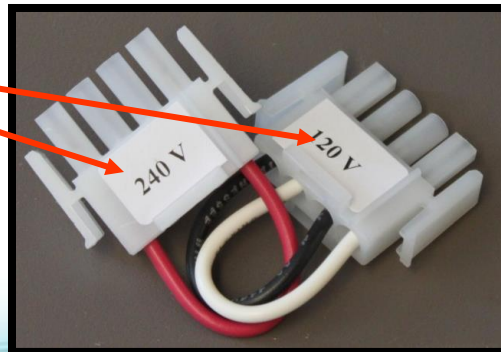
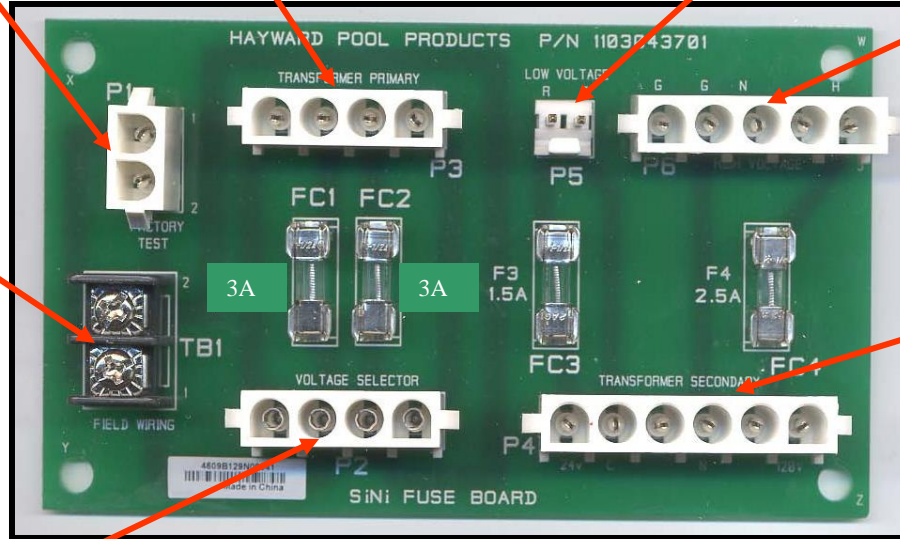

Fuses

Fuse board configuration through Oct 2010

The fuses are
250v SLO-BLO
5 x 15 mm.

FC1 and **FC2** fuses (3 amp) protect the primary input voltage. These fuses blow due to a shorted Fuse Board, shorted Transformer, improper or excessive voltage.

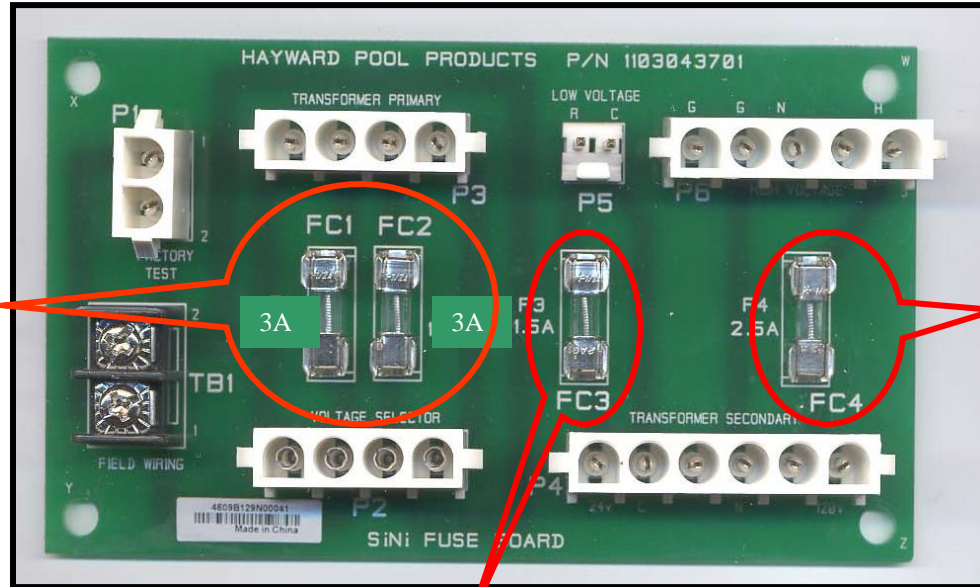

The **FC4** fuse (2.5 amp) protects the transformer (120VAC secondary output voltage) from a failed Blower, Igniter, or ICB.

The **FC3** fuse (1.5 amp) protects the transformer 24VAC secondary output voltage.

Situations that will cause this fuse to blow include:

- Short between FC3 to R & C on the ICB.
- Any short to ground at the E1 connector (external remote terminal) on the ICB or 24 VAC circuit.

Fuses

Fuse board configuration Nov 2010 forward

Remaining 3 fuses are now all 3amp. Different fuse kits will reflect the change



The fuses are 250v SLO-BLO 5 x 20 mm. Hayward Part # FDXLFSKF30 (Qty. 10)

Beginning Nov 2010 the F3 fuse has been removed from the Fuse Circuit Board. Since the F1 Fuse (automotive style fuse on the ICB) protects the same circuit it will be the only fuse going forward.

ICB F1 fuse

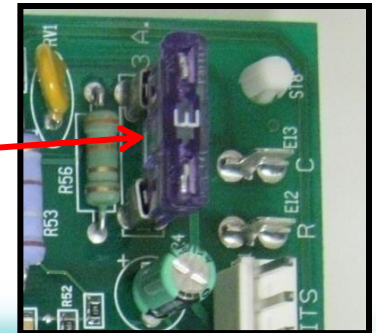

Troubleshooting: Heater will not power up

Step 1:

Verify incoming voltage to heater is present (110-125 or 220-245 VAC), if voltage is present, proceed to **Step 2**. Otherwise, correct incoming line power to heater.

Models Prior to August 2008

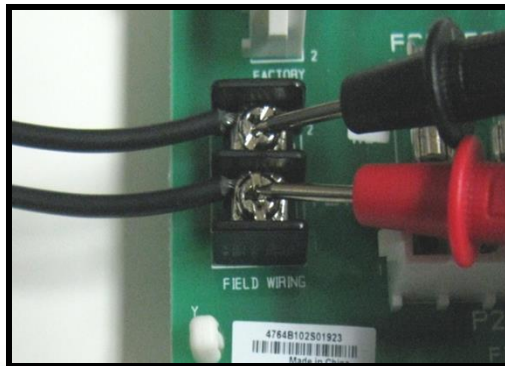

Models After August 2008

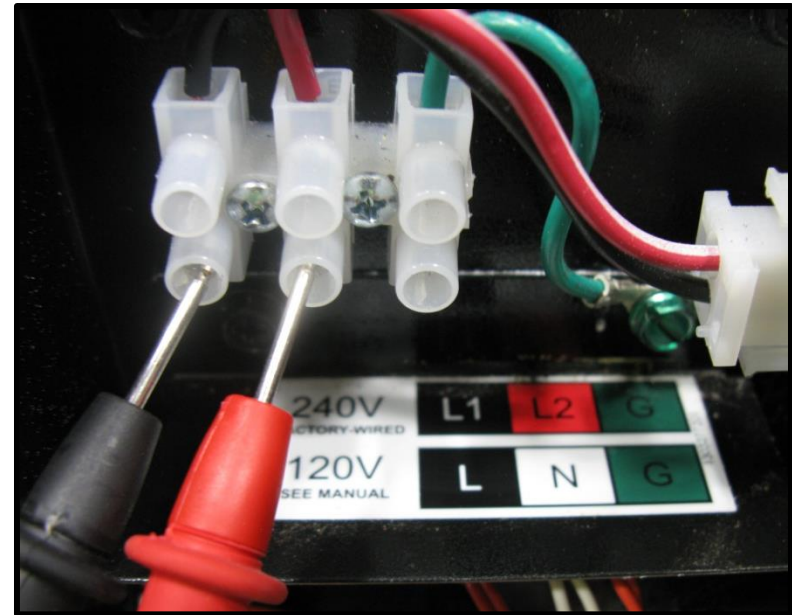

Troubleshooting: Heater will not power up

Step 2: Verify Voltage Selector Plug matches incoming line power.

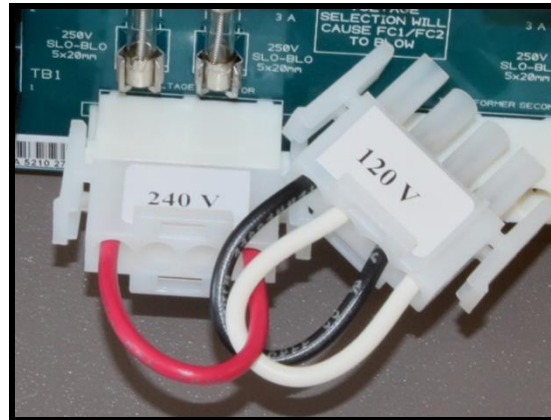

Step 3: Inspect Fuse Board wiring and ensure all plugs are securely fastened to board.

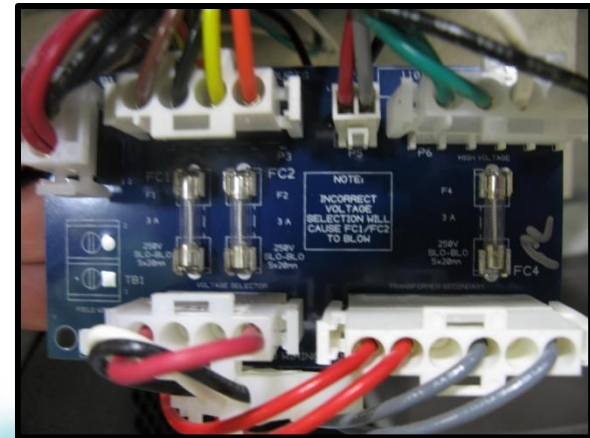
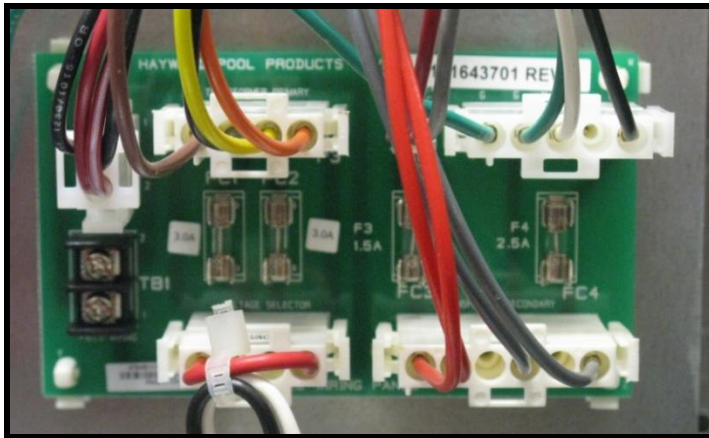

Troubleshooting: Heater will not power up

Step 4:

Verify that FC1 and FC2 Fuses are not open. Check incoming voltage at bottom of both fuses (Fig. A) and out going voltage at top of both fuses (Fig. B), if no voltage is present at the top of both fuses, remove fuses from the Fuse Holders and measure continuity across each Fuse (Fig. C).

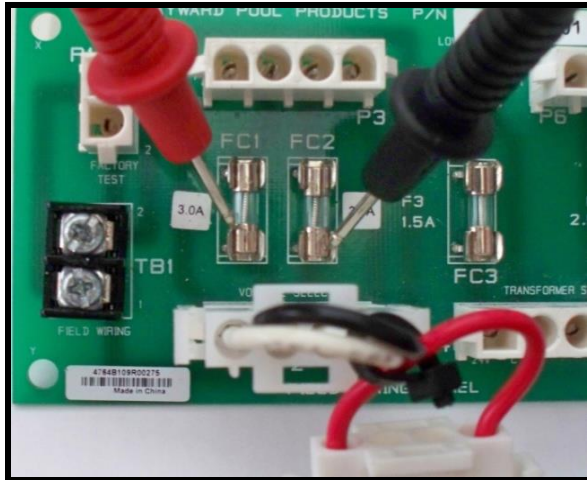

Fig. A

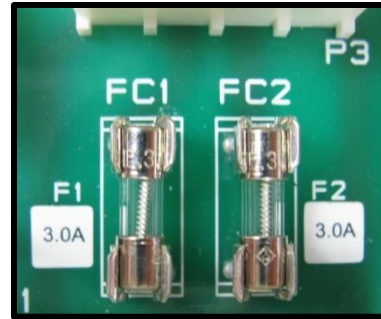

Fig. C

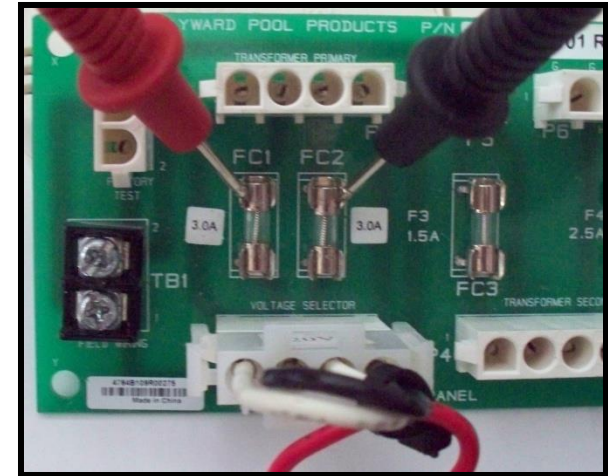
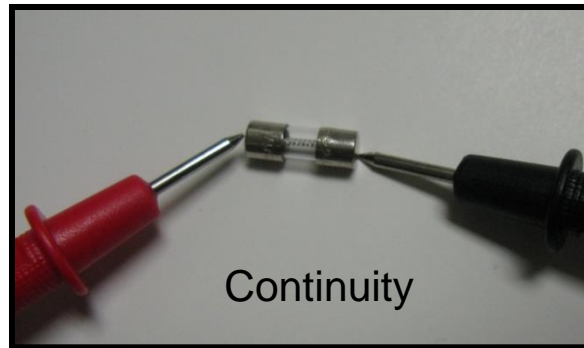

Fig. B

If Fuses are open, proceed to **Page 23**. Otherwise, reinstall the Fuses and continue to **Step 5**.

Troubleshooting: Heater will not power up

Step 5:

Disconnect plug from P4 connector from Fuse Board. Measure for 22-28 VAC between pins 1 & 2 of plug from Transformer (red wires) and 110-125 VAC between pins 4 & 6 (grey wires).

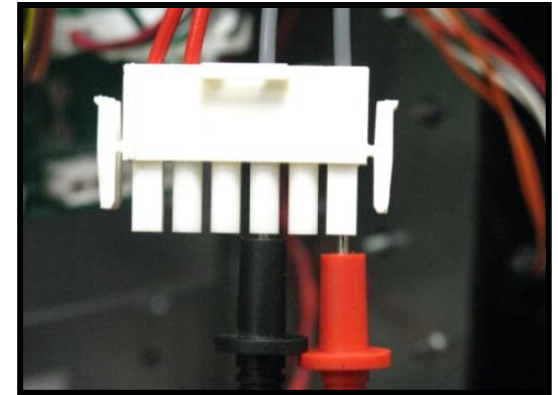
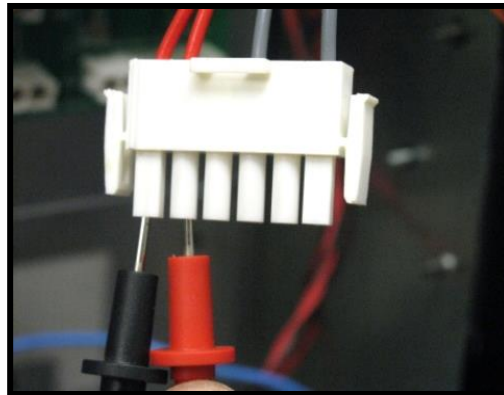
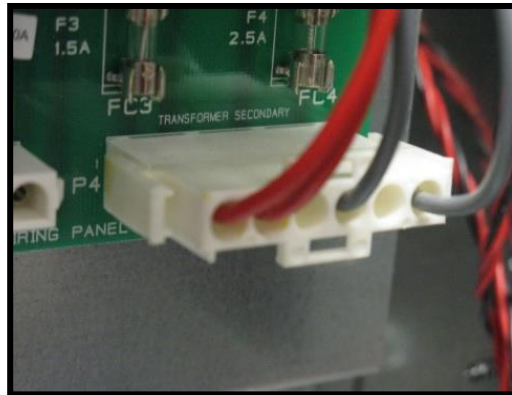

If either voltage is incorrect, proceed to **Page 23**. Otherwise, proceed to **Step 6**.

Troubleshooting: Heater will not power up

Step 6:

For Fuse board Older than Nov 2010: Disconnect plug from P5 connector on Fuse Board and measure for low voltage (22-28 VAC) between R & C pins of P5 receptacle on Fuse Board. If voltage is not present, proceed to **Step 7**. **For boards from Nov. 2010 forward,** replace the fuse board. Otherwise, proceed to **Step 8**

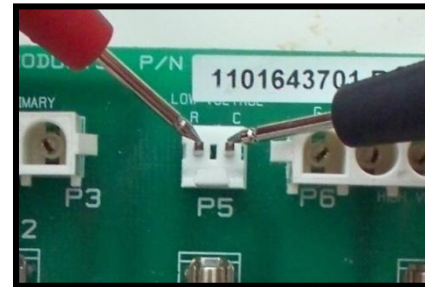
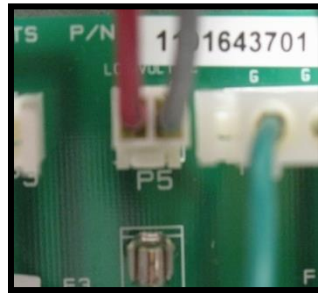

Step 7:

For Fuse board Older than Nov 2010: Measure for low voltage (22-28 VAC) between P5 C pin and bottom of FC3 fuse. If voltage is not present, replace Fuse Board. Otherwise, measure for low voltage between P5 C pin and top of FC3 fuse. If voltage is not present check for blown fuse. If fuse is blown proceed to **Page 12**, if voltage is present proceed to **Step 8**.

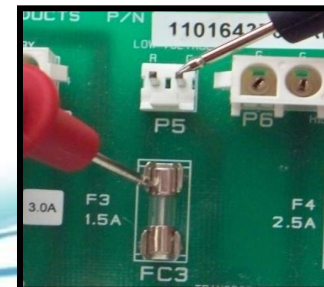
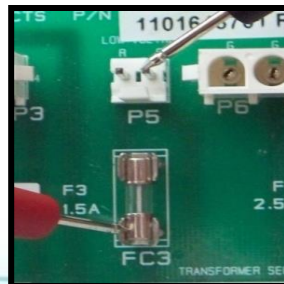

Troubleshooting: Heater will not power up

Step 8: Inspect ICB wiring and ensure all plugs are securely fastened.

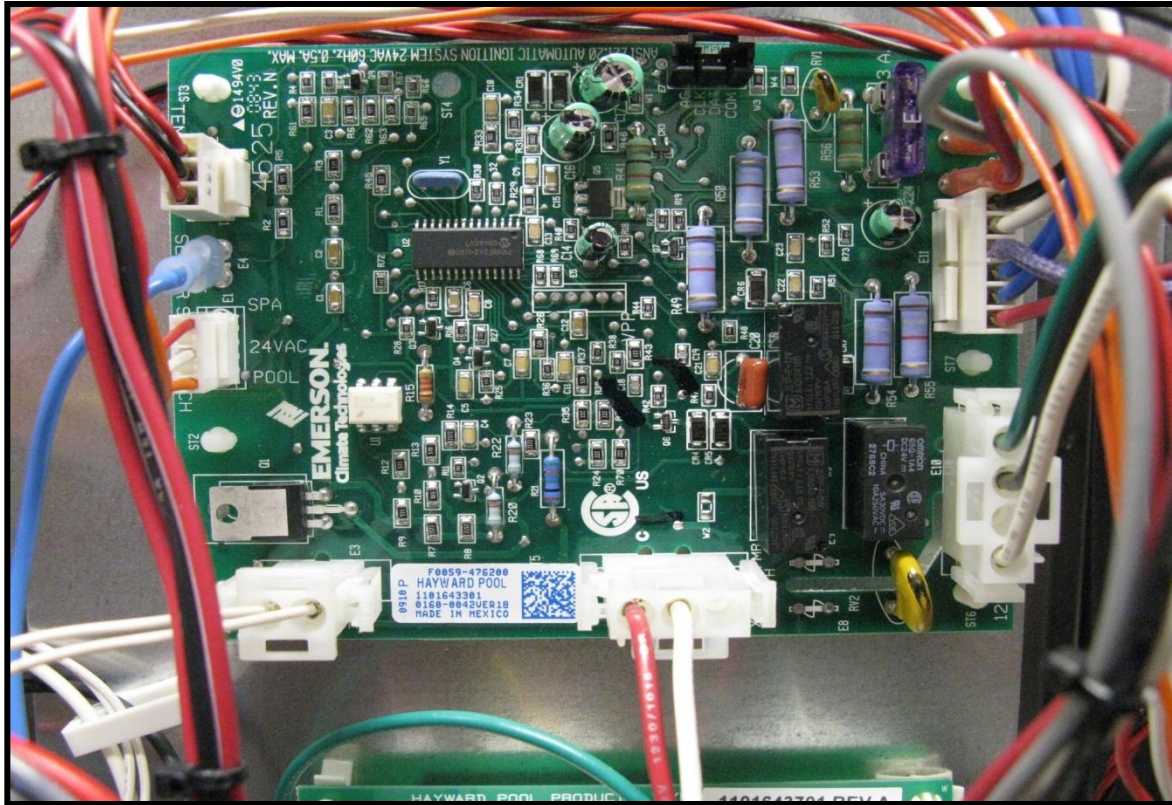

If wiring is OK and plugs are securely fastened, proceed to **Step 9**.

Troubleshooting: Heater will not power up

Step 10:

Verify that F1 Fuse (3 AMP) on ICB is not open by measuring continuity across the Fuse. If fuse is OK, proceed to **Step 11**. If fuse is blown, proceed to **Page 25**.

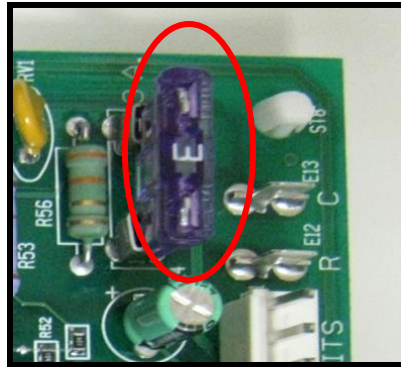

Step 11:

Verify 22 – 28 VAC is present between COM and AC terminals on ICB board. If voltage is present and display is blank, proceed to **Step 12**. If voltage is not present, replace the ICB.

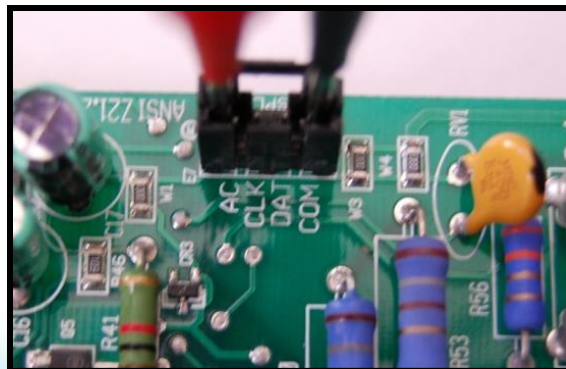

Troubleshooting: Heater will not power up

Step 12:

Ensure display board is not wet and no debris is present.

Take ohm reading of keypad. The membrane switch has a 4-pin connector on the end of the ribbon cable. Measure using holes in top of connector.

To test the MODE button, measure resistance across pins 1 and 4.

To test the UP button, measure resistance across pins 2 and 4.

To test the DOWN button, measure resistance across pins 3 and 4.

Step 13:

With the button not pressed, you should measure an open circuit (resistance greater than 100 Mohms). When pressed, resistance should be less than 100 ohms. If readings are not correct, replace the keypad. Otherwise, replace the display board.

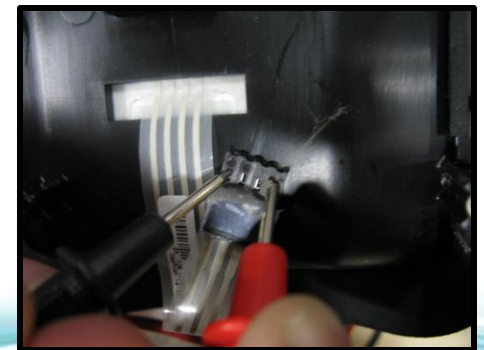
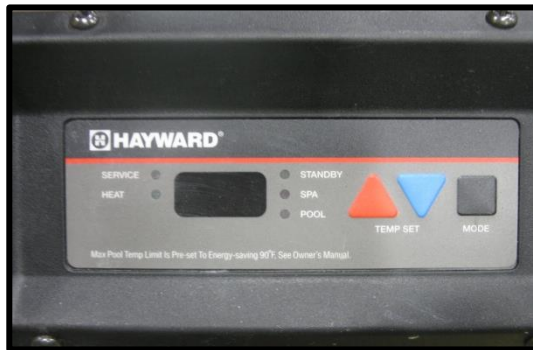

Troubleshooting: Open FC1 and/or FC2 Fuse

Step 1:

Verify that 120 VAC Voltage Selector Plug is NOT installed with a 240 VAC field power supply.

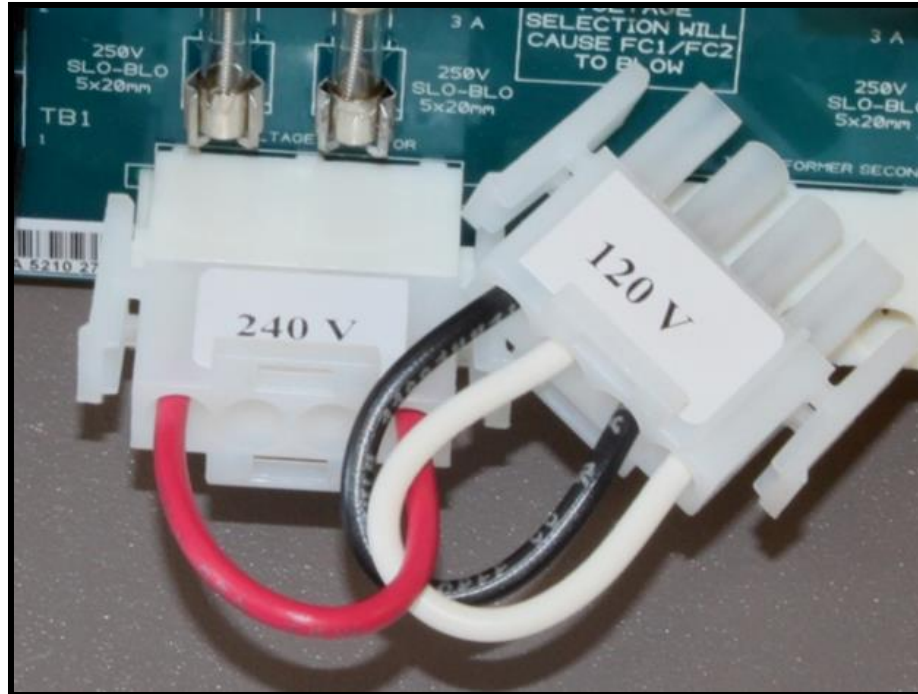

If correct plug is installed, proceed to **Step 2**. If incorrect, turn the power off and install the 240 VAC plug. Then replace FC1 and FC2 Fuses.

Troubleshooting: Open FC1 and/or FC2 Fuse

Note: Make sure to disconnect power prior to performing the steps below.

Step 2:

Check for faulty Transformer wiring and ensure the insulation on the wiring is not worn.

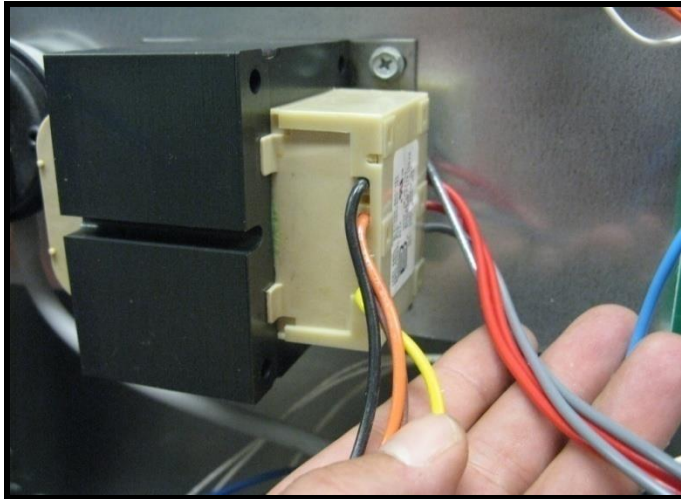

Step 3:

Remove P4 and P3 plugs. Measure Transformer for resistance of 1.9 - 2.9 ohms between Black to Brown wires and between Orange to Yellow wires of P3.

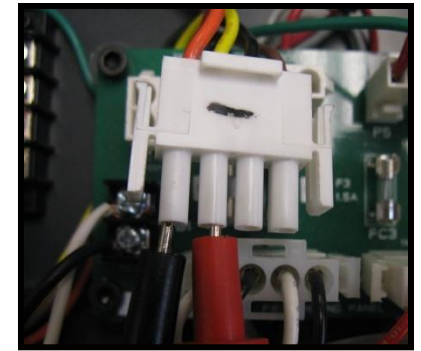
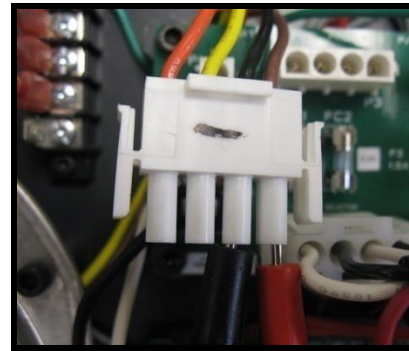

If resistance is out of range, replace the Transformer.

Troubleshooting: Open FC3 and/or F1 Fuse

Step 1: Check low voltage wiring / connections for worn insulation or pinched wiring.

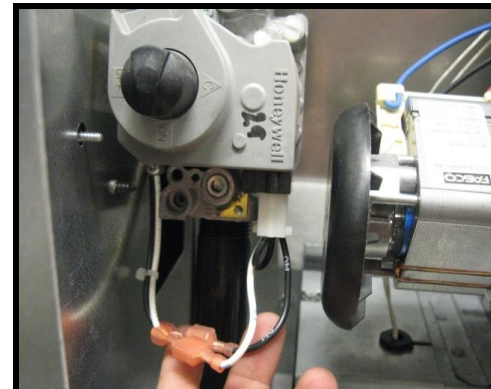
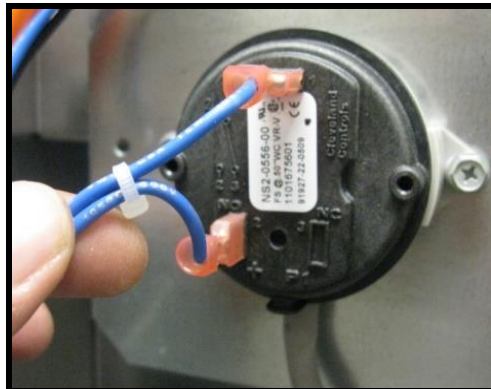
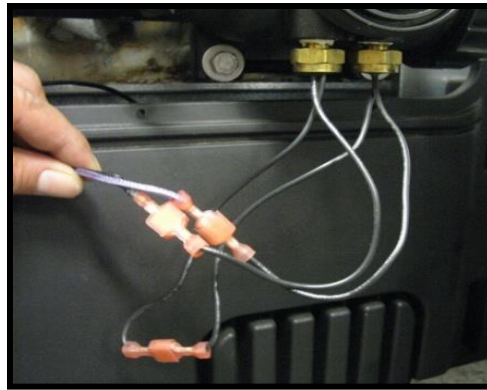
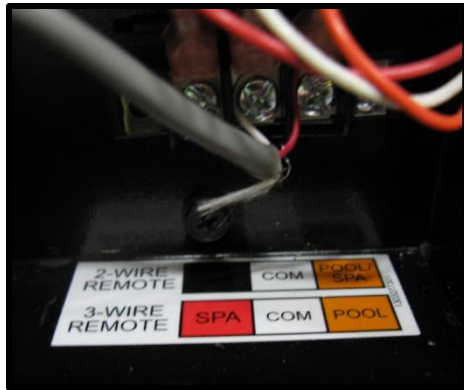

Troubleshooting: Open FC3 and/or F1 Fuse

Step 2: Inspect Gas Valve wiring and ensure insulation is not worn.

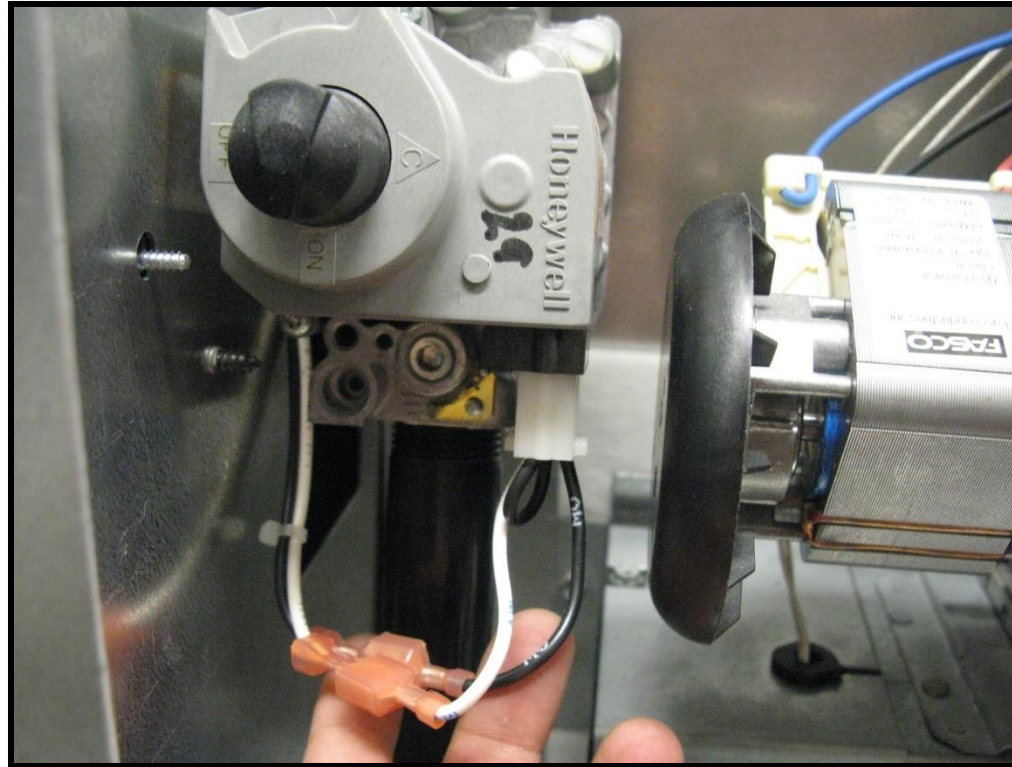

If wiring is OK, proceed to **Step 3**.

Troubleshooting: Open FC3 and/or F1 Fuse

Step 3:

Measure resistance across Gas Valve terminals (greater than .5 ohms) and between each terminal to Ground for short (there should be no continuity between either terminal to ground).

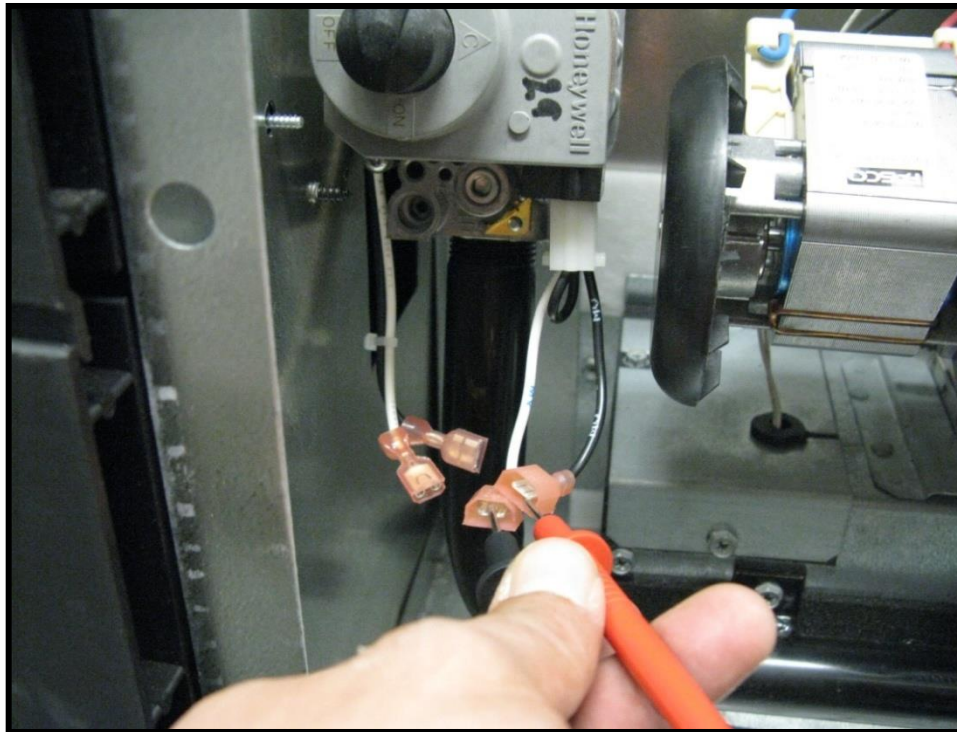

If a short exists (less than .5 ohms), replace the Gas Valve. Otherwise, proceed to **Step 4**.

Troubleshooting: Open FC3 and/or F1 Fuse

Step 4: Check for faulty ICB wiring and ensure insulation on wiring is not worn.

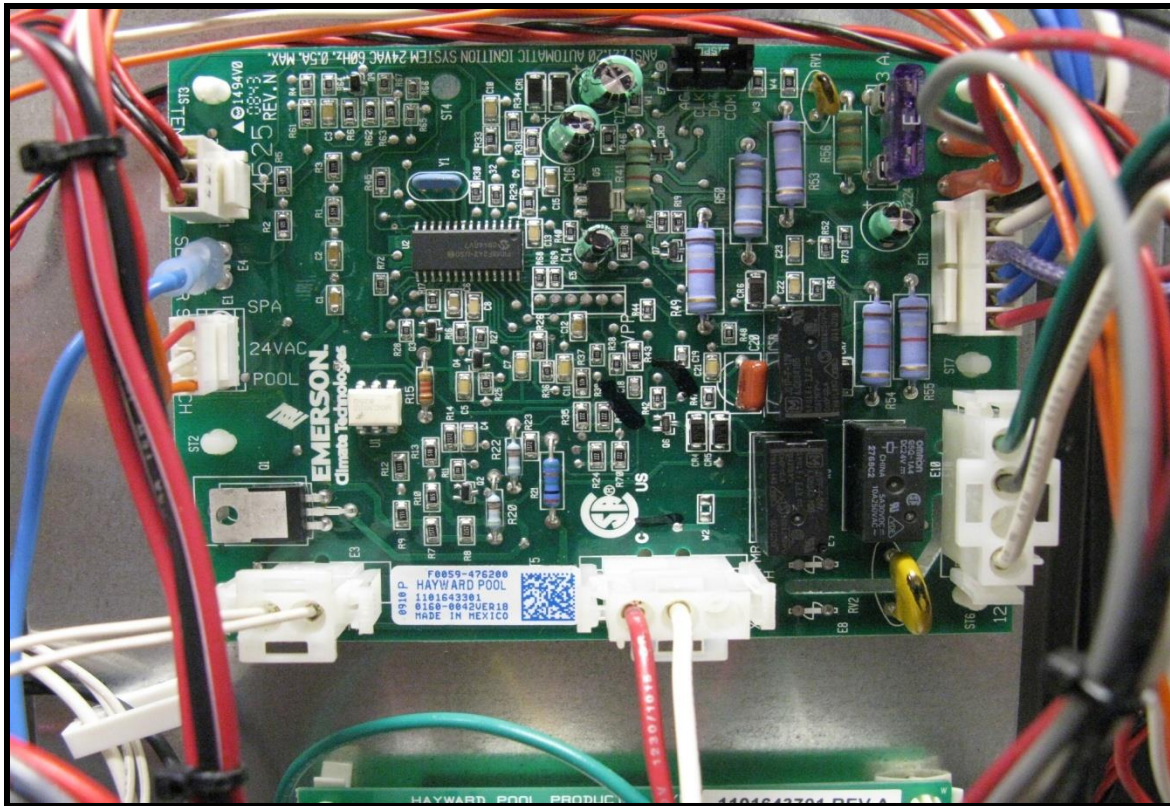

If wiring is OK, replace the ICB.

Troubleshooting: **Open FC4 Fuse**

Step 1:

Inspect the Igniter and Blower Wiring and ensure the insulation is not worn.

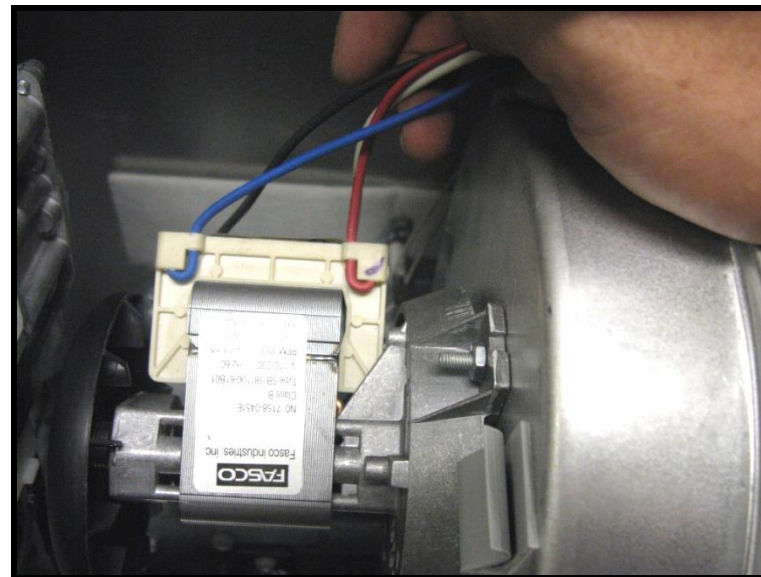
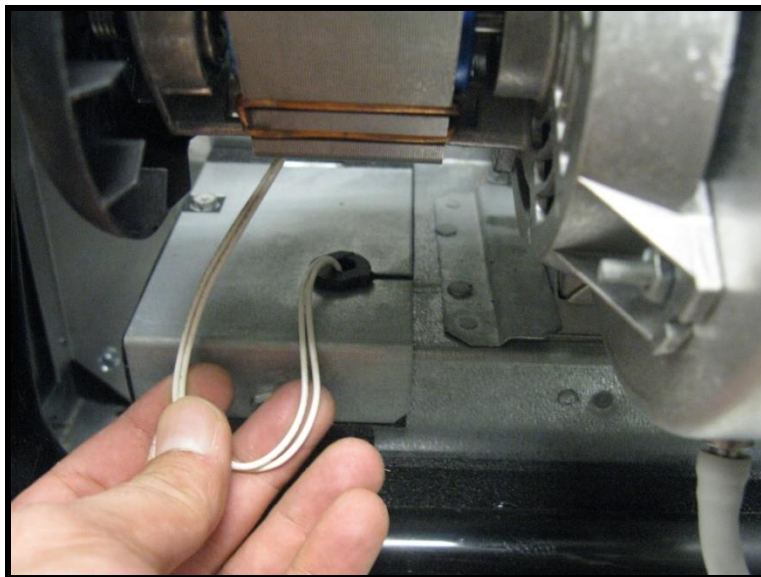

If wiring is OK, proceed to **Step 2**. Otherwise, replace the defective component(s).

Troubleshooting: Open FC4 Fuse

Step 2:

Disconnect the Igniter Plug from the ICB and measure resistance across the Igniter. Resistance should be 8-25 ohms between 20°-140° F.

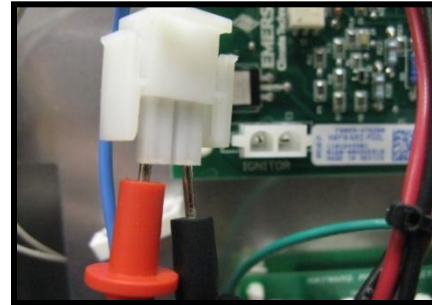

If resistance is out of range, replace the Igniter. If OK, proceed to **Step 3**.

Step 3:

For Models Manufactured Before September 2010: Disconnect the Blower Plug from ICB and measure the Blower resistance. Resistance should be 8-9 ohms from Black to Red wires and White to Blue wires.

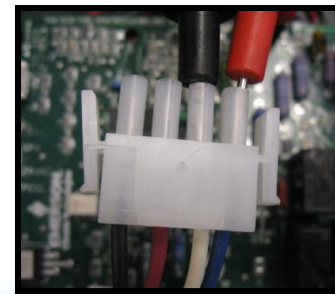
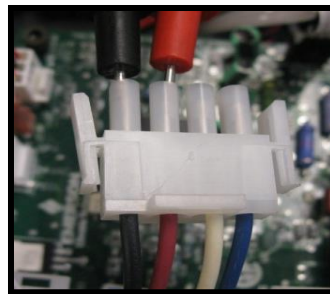
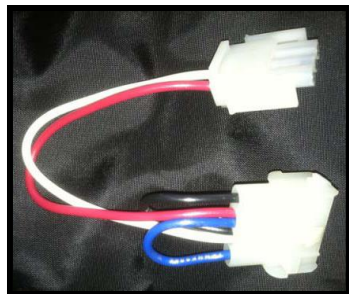

If resistance is out of range, replace the Blower.

Troubleshooting: Open FC4 Fuse

Step 3:

For Models Manufactured After September 2010: Disconnect Blower Plug from ICB and measure resistance between the RED/BLU wires together and the BLK/WHT wires together. This resistance should be 4-5 ohms.

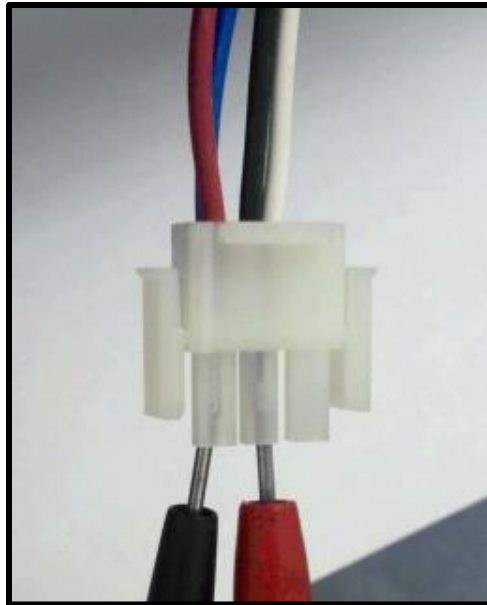

If resistance is out of range, replace the Blower.

Diagnostic Codes

Below is a list of all Diagnostic Codes for the UHS Heater. Troubleshooting Steps for each Code are covered on the following pages.

Diagnostic Code	Description
AC	Blower Vacuum Switch closed
AO	Blower Vacuum Switch open
BD	Bad board or secondary high voltage fault
CE	Communication Error Between Control Module and Display Interface Assembly
EE	Bad board
HF	Flame present with Gas Valve not energized.
HS	Maximum return water temperature exceeded and / or rapid water temperature rise.
IF	Ignition Failure
IO	Igniter Circuit Open
LO	Water Pressure Switch, Vent Pressure Switch, or Temperature Limit Switch Fault
PF	Voltage polarity reversed, low voltage detected
SB	Keypad failure
SF	Temperature Sensor (thermistor) input failure

Service Light On: **BD Code**

Step 1: **BD Code: Bad Board or Secondary High Voltage Fault. Remove FC4 Fuse and measure continuity.**

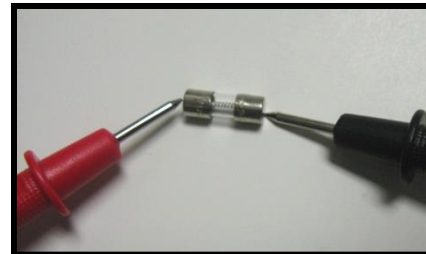
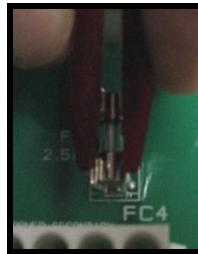
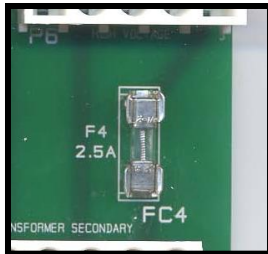

If Fuse is blown, go to **Page 29 (Open FC4 Fuse)**. If OK, proceed to **Step 2**.

Step 2: Disconnect plug from P6 connector of Fuse Board and measure for 110-125 VAC across Pins 3 and 5 of P6 receptacle on Fuse Board.

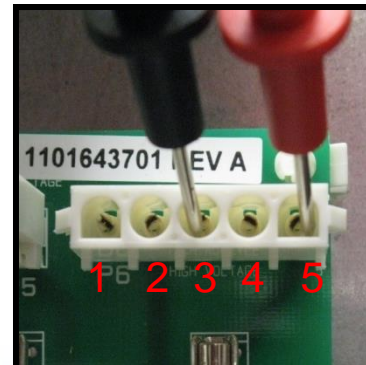
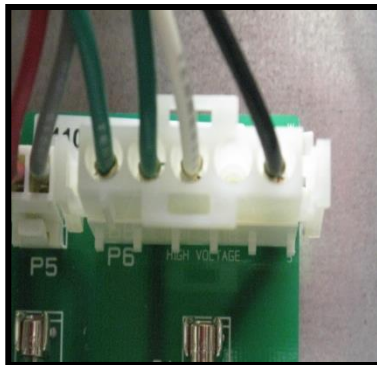

If OK, proceed to **Step 3**. Otherwise, go to **Step 4**.

Service Light On: **BD Code**

Step 3: Disconnect plug from E10 connector of ICB and measure for 110 -125 VAC across pins 1 and 3 of plug on Wire Harness (white and black wires).

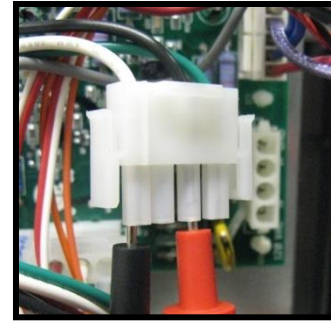
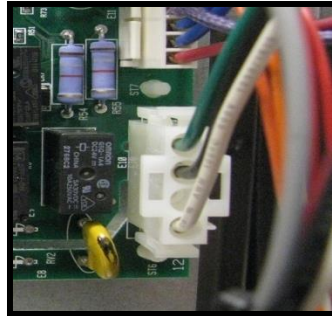

If 110-125 VAC is present, replace the ICB. Otherwise, replace the Wire Harness.

Step 4: Disconnect plug from P4 connector of Fuse Board and measure for 110 -125 VAC between pins 4 and 6 of plug from Transformer (grey wires).

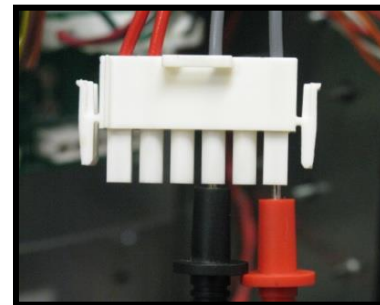
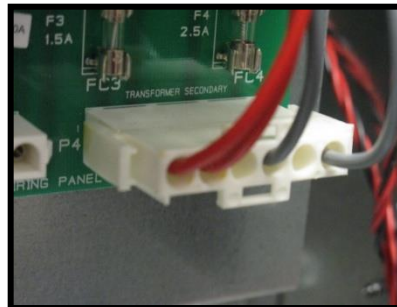

If 110-125 VAC is present, replace the Fuse Board. Otherwise, replace the Transformer.

Service Light On: **EE** and **CE** Codes

EE Code: “EEPROM Error” Defective ICB board. Replace ICB.



CE Code: “Communication Error” between ICB and display board. Error may be cleared by cycling line power off and on. Otherwise, inspect Display Interface ribbon cable and ensure plug is securely attached to ICB.

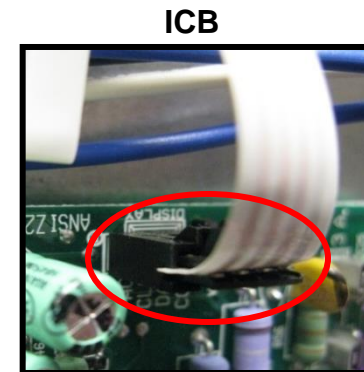
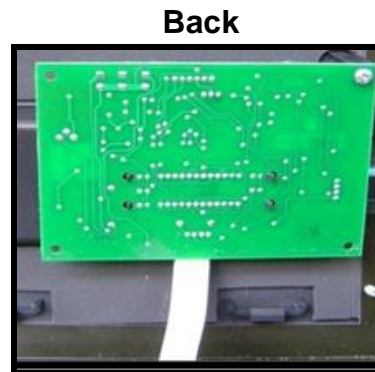
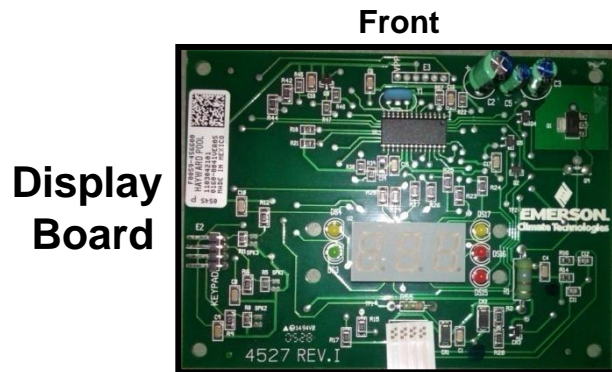

If Display Interface ribbon cable and connector plug is OK, replace the Display Interface Assembly and/or Key Pad. If code is still present, replace the ICB.

Service Light On: IO and SB Codes

IO Code: “Igniter Open” Inspect Igniter wiring, ensure Igniter plug is securely attached to the ICB. Verify Igniter ohm resistance (8-25 ohms between 20°- 140° F).

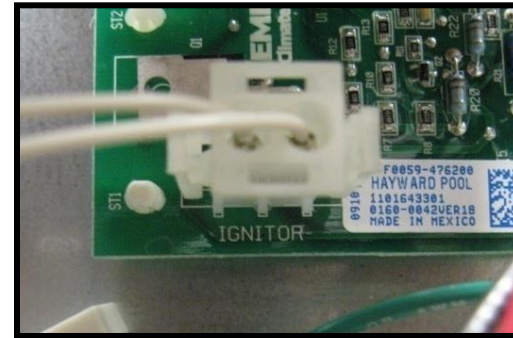
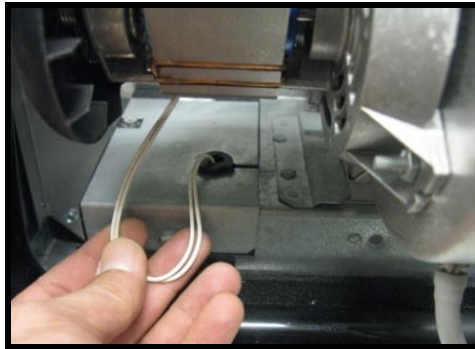

If wiring damaged and/or ohms resistance is out of range, replace the Igniter.

SB Code: “Stuck Button” Indicates the display board is receiving a continuous closed circuit on one of the buttons for more than 30 seconds.

Refer to Step 13, on Page 22.

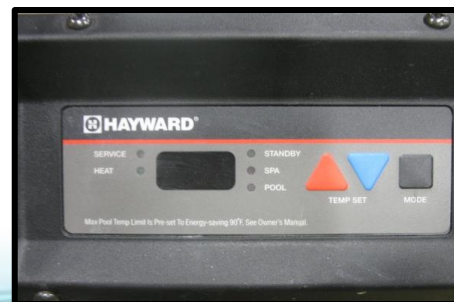

Service Light On: **SF** and **HS** Codes

Step 1: **SF Code: “Sensor Failure”** Inspect Temperature Sensor (thermistor) wire, make sure sensor is plugged into ICB securely.

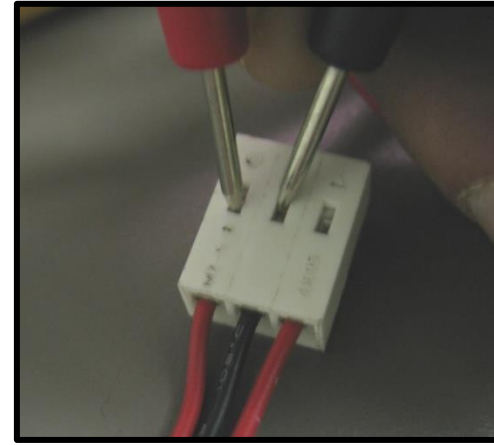
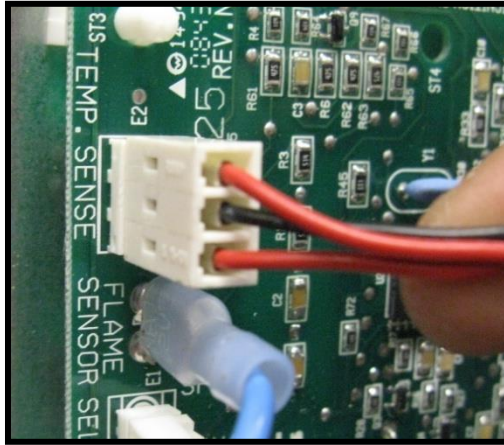

Step 2: Measure resistance between black wire and each red wire, the Temperature Sensor resistance should be the same (10k ohms at 77° F). If readings are significantly different from each other, replace the temperature sensor. Otherwise replace the ICB.

HS Code: **“High Temperature Sense”** If water temperature exceeds 105° F the heater will shut down and go into lockout. Automatic restart is 2 minutes after water temp drops below 105° F. Code could also mean rapid water temperature rise (6° rise in 60 seconds. **Continued on next page.**

Service Light On: HS and PF Codes

HS Code Cont'd:

This code could be in conjunction with a SF code and replacing the Temperature sensor could cure the problem. Make sure the water connections are not reversed. Otherwise, replace the ICB.

PF Code:

“Polarity Failure” This code will display if 120VAC polarity is reversed, low voltage is detected, if the ground path is not sufficient, or the ICB is defective. Reset is immediate after error is corrected.

Step 1:

Ensure voltage is within 10% + or – of required voltage.

Step 2:

If 120 VAC, make sure polarity is correct by measuring voltage between neutral and ground. If voltage present, polarity is reversed and needs to be corrected. If configured for 240 VAC, proceed to **Step 3**.

Step 3:

Make sure grounding is correct. Otherwise, the ICB is defective and needs to be replaced.

Service Light On: HF Code

HF Code:

“Heat or Flame Sensed” Heat sensed when gas valve should be “OFF”. If flame is sensed with the gas valve off, the control will go into lockout. The blower will continuously run until error condition is corrected. When corrected, control will run blower for 5 seconds then automatically restart heater after 2 minutes.

Step 1: Reset heater, cycle line power off and on.

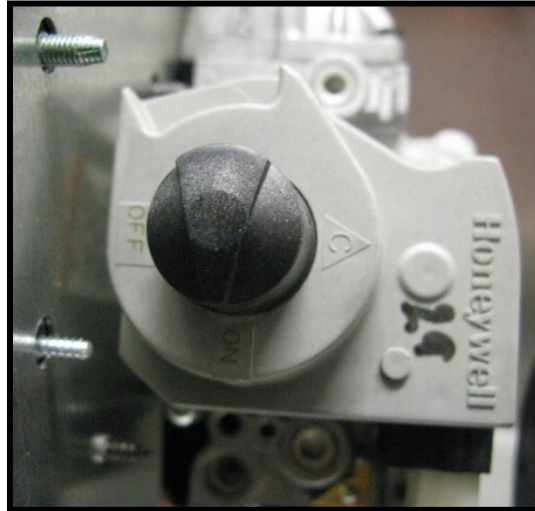

Step 2:

If the HF code is still present, the Gas Valve may be defective. If 24VAC is not present at gas valve **and** manifold pressure is present, valve is defective. Otherwise, replace the ICB.

Service Light On: LO Code

Step 1: **LO Code: “Limit Open”** Verify pump is running and adequate water is flowing through heater. LO Code is normal when the pump is turned off.

Step 2: Inspect Water Pressure Switch wiring and ensure Wire Harness terminals are securely fastened to the spade terminals on the Water Pressure Switch.



Step 3: Remove wires from Water Pressure Switch and measure continuity across the terminals while pump is running. If open, replace Pressure Switch. Otherwise, go to **Step 4**.



Service Light On: LO Code

Step 4:

Certain applications will require the adjustment of the Pressure Switch, refer to section of the installation/service manual titled: **Water Pressure Switch Test / Adjustment Procedures.**



Step 5:

Inspect Temperature Limit Switch Wiring and ensure wire harness terminals are securely fastened.

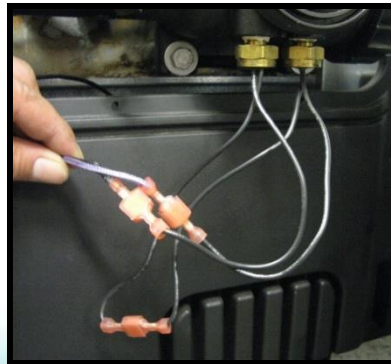

Service Light On: LO Code

Step 6: Measure continuity across the Temperature Limit Switches.

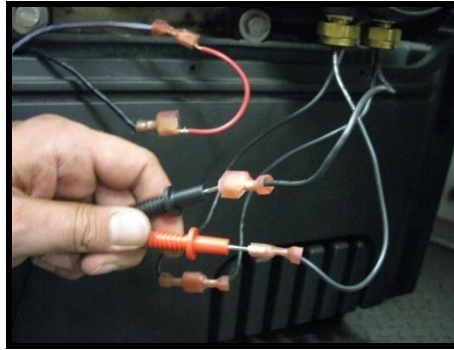

If open, replace the Temperature Limit Switch(s).

Applies Only To Indoor Installations

Step 7: Inspect the Vent Pressure Switch Wiring and Hose connections. Ensure Wire Harness is securely fastened and tubing is attached to Blower and Vent Pressure Switch.



If OK, proceed to **Step 8**.

Service Light On: LO Code

Applies Only To Indoor Installations

Step 8: Ensure that flue is not blocked or restricted. See indoor vent sizing requirements in Installation Manual.

Step 9: Remove wires from Vent Pressure Switch and measure continuity between terminals. While heater is running, measure continuity across the Vent Pressure Switch.



If open, replace Vent Pressure Switch.

Service Light On: IF Code

Step 1: IF “Ignition Failure” Ensure main gas shutoff outside the heater is open and that the Gas Valve inside the heater is in the “ON” position.

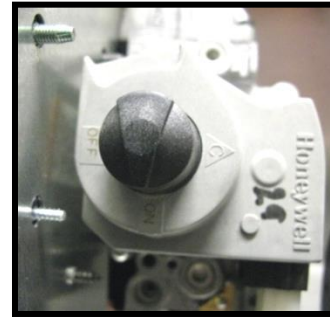

Step 2: Inspect Flame Sensor and Gas Valve wiring and ensure wire harness is securely fastened to the terminals.

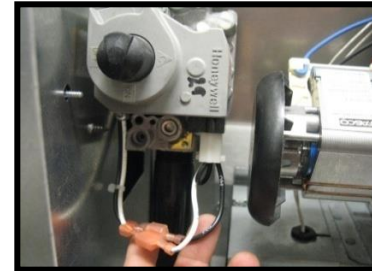
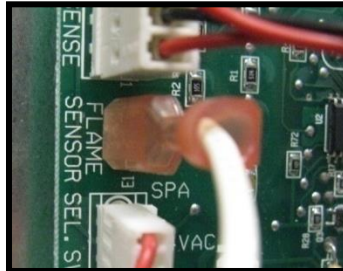

Step 3: Ensure Gas Static, Load and Manifold pressures are correct. See **Page 8**.

If OK, proceed to **Step 5**, Otherwise proceed to **Step 4**

Service Light On: IF Code

Step 4: Measure for 22-28 VAC across Gas Valve during trial for ignition.

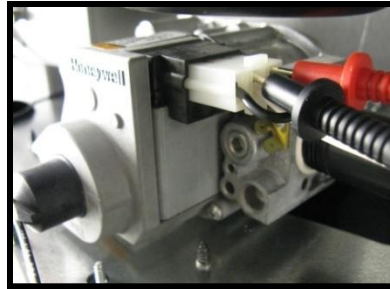

If 22-28 VAC is present and Gas Valve does not open with manometer connected to valve, replace Gas Valve. See **Page 8** for reference. If 22-28 VAC is not present, replace the ICB.

For models manufactured prior to 4/14/2009

Step 5: Verify which flame sensor is installed. If 3" flame sensor installed, replace with 5" flame sensor.



Service Light On: IF Code

Step 6: Check for damaged or wrong blower air inlet plate.

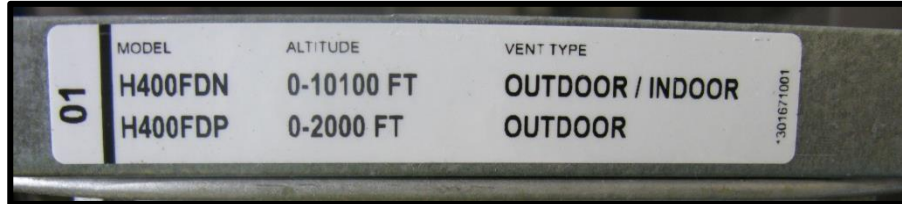

Step 7: Remove and inspect Gas Orifices and Burners for blockage (Spider webs).



NOTE: Check for excessive moisture in combustion chamber.

Determine possible causes; roof run-off, sprinklers, etc.

Service Light On: **AC Code**

Step 1:

AC Code: “Air Switch Closed” Blower vacuum switch closed when expected open. Disconnect wires and tubing from switch, measure continuity between terminals on switch. If continuity exist, replace switch.

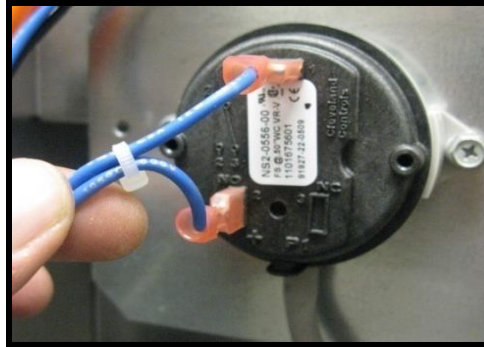

Step 2: With heater off, If blower continues to run, replace ICB.

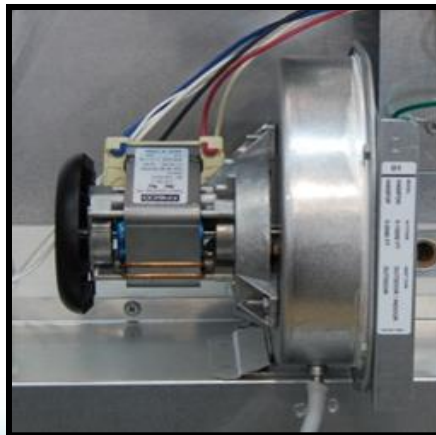

Service Light On: **AO Code**

Step 1: Check for faulty Blower and Blower Vacuum Switch Wiring, Tubing, Hose Barb on Blower, and Connections.

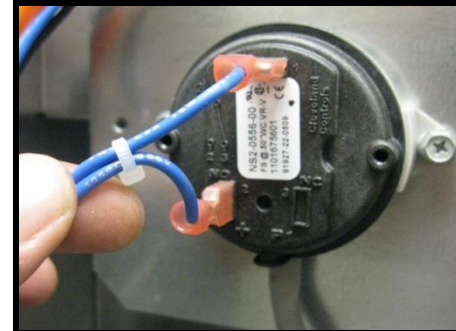
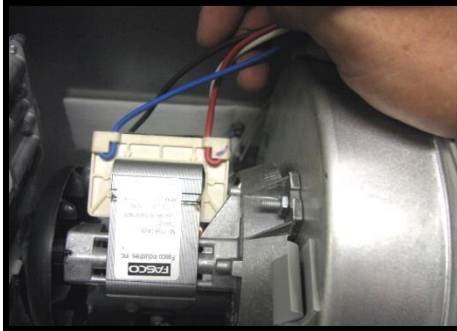

Step 2: Ensure Voltage Selector Plug is configured for correct field supplied voltage.



Service Light On: **AO Code**

Note: Resistance values are for heater that has not been running in the last 10-15 minutes.

Step 3 : **For Models Manufactured Before September 2010:** Disconnect the Blower Plug from ICB and measure the Blower resistance. Resistance should be 8-9 ohms from Black to Red wires and White to Blue wires.

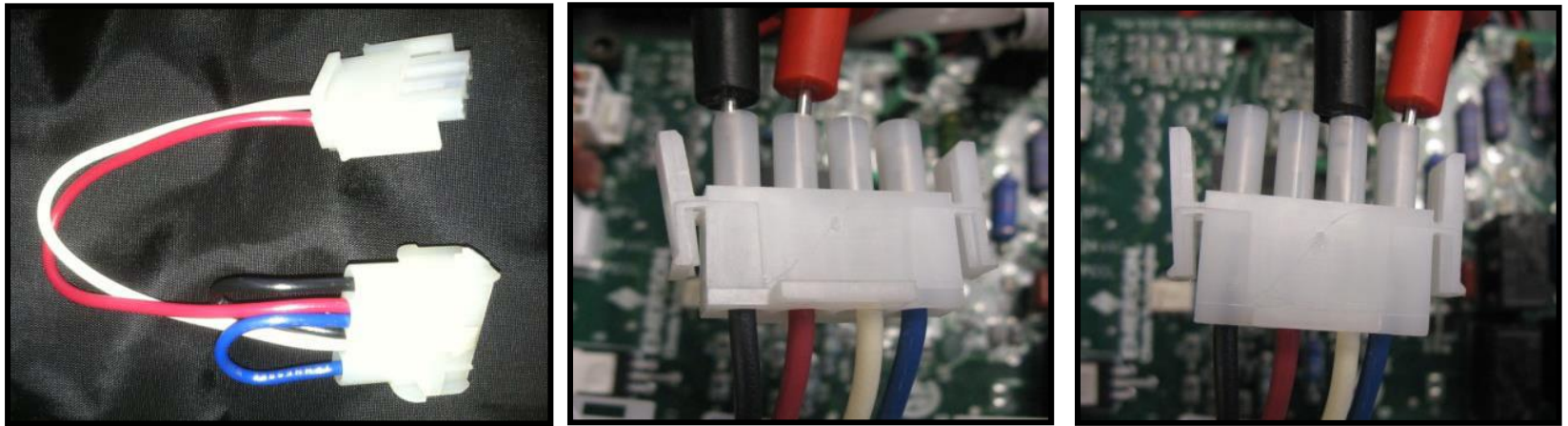

If resistance is out of range, replace the Blower. If OK, proceed to **Step 4**.

Service Light On: **AO Code**

Step 3 : For Models Manufactured After September 2010: Disconnect Blower Plug from ICB and measure resistance between the RED/BLU wires together and the BLK/WHT wires together. This resistance should be 4-5 ohms.

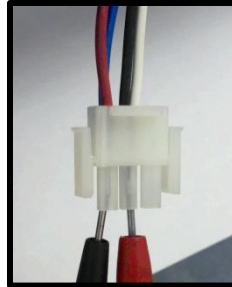

Step 4: Disconnect Blower Plug from ICB and generate a call for heat. While in pre-purge, measure for 110-125 VAC across Pins 1 & 2 of Inducer on ICB.

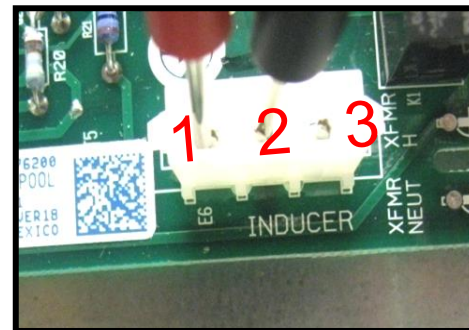
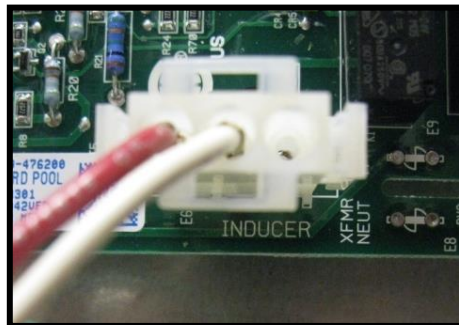

If 110-125 VAC is not present, replace the ICB. If 110-125 VAC is present and Blower is running, replace the Blower Vacuum Switch.

Temperature Lock-Out Sequence

Heaters made after
2/25/2011, serial #
21131102103896001.



The default
Max temp
lock-out
settings are
90° for the
Pool and 104°
for the Spa

1. Use the MODE button and place the heater in STANDBY mode.
2. Press and hold the UP and Down buttons at the same time. Wait three seconds.
3. The SPA indicator light illuminates and the display shows the current Max Temp Lock-out setting.
4. Use the up and down buttons to set the desired Max Temp Lock-out setting.
5. Press the mode button and the POOL indicator light illuminates.
6. Follow the same sequence as with the SPA settings above.
7. Press the mode button again to return to STANDBY.

When setting the max temp lock-out setting, the lights and display will flash rapidly.

Heat Exchanger – Flow requirements

Flow requirements should be checked to insure proper operation.

Never allow heater to operate below minimum flow requirements or damage may occur.

- Flow less than minimum could cause issues such as the heater dry firing or water to boil causing high limits to trip and possible damage to heat exchanger.
- Flow exceeding maximum flow could cause issues such as damage to the heat exchanger by thinning the tube walls.

Internal By-Pass

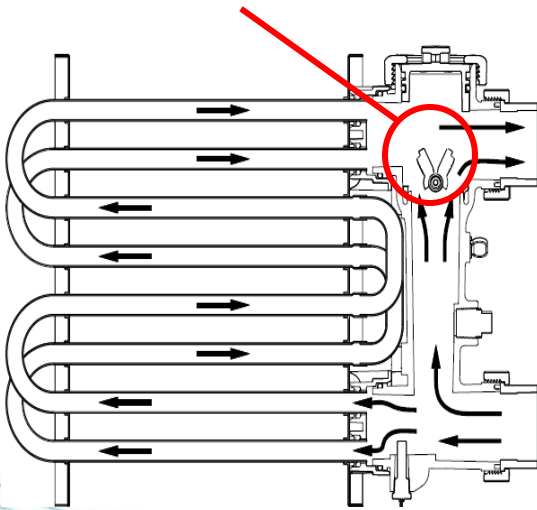

Internal by-pass should be inspected periodically as it could be the cause of low or high water flow through the exchanger

Flow Requirements

Model	Min GPM
H150FD H200FD	20
H250FD H300FD	25
H350FD H400FD	30

Maximum water flow 125 GPM

Heat Exchanger – Failure Modes

New, Clean Exchanger



Low pH or High Water Flow

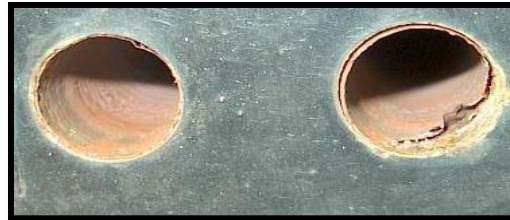

High Sanitizer Levels



Annealed fins – Low Water Flow



Low pH



High Sanitizer Levels

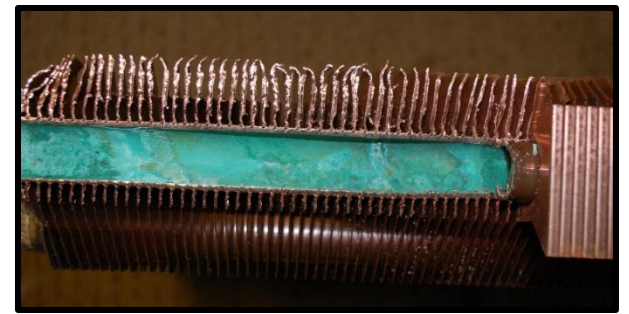

Hi pH, Alkalinity or Calcium Hardness



Sooted – Improper Fuel and Air Mixture.

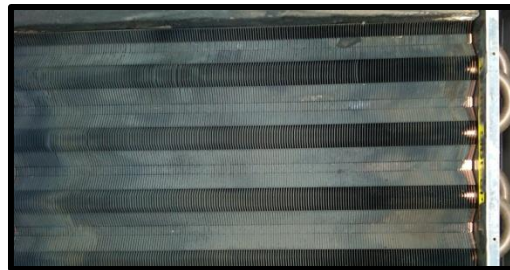

Freeze Damage



Flow Chart – Heater will not power up

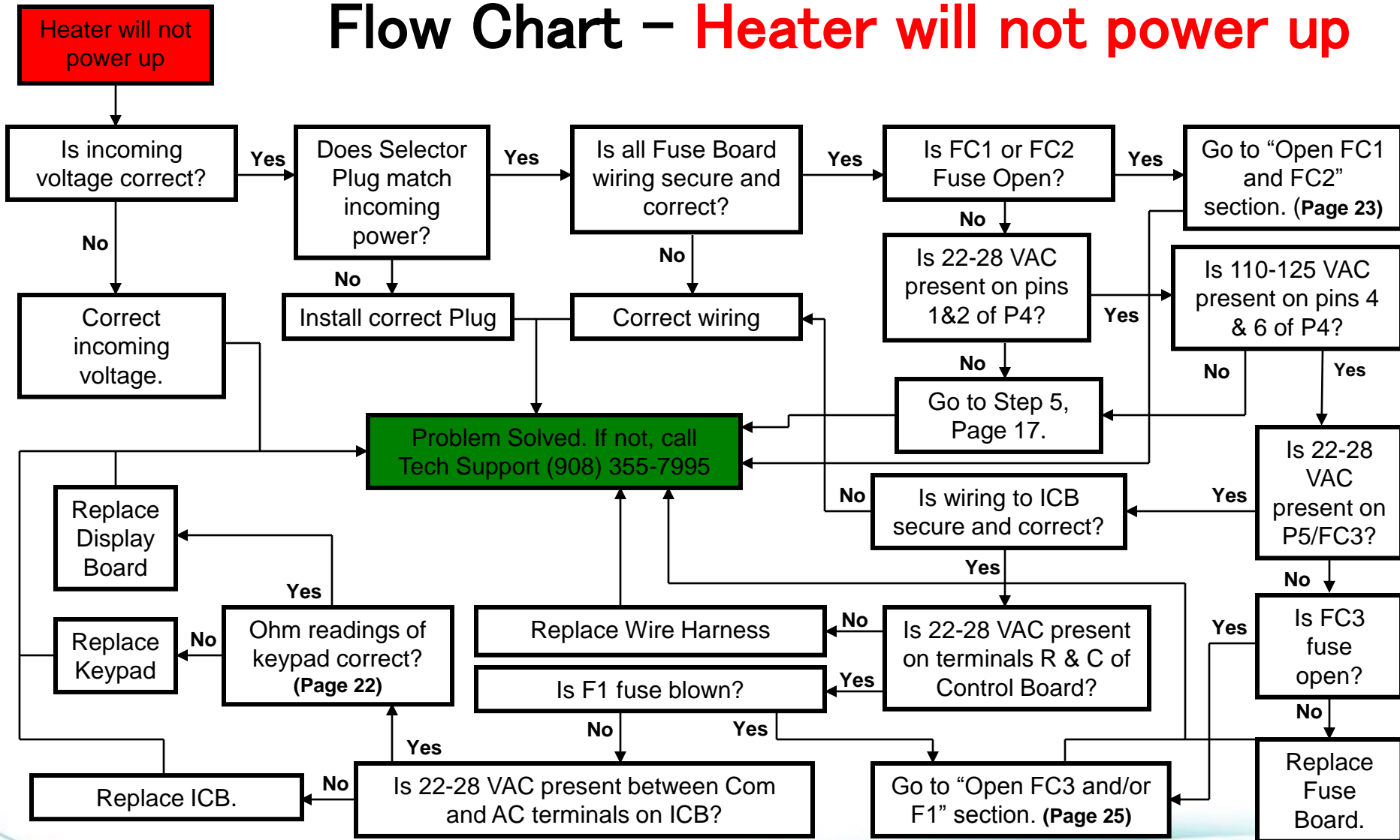

Flow Chart- Open FC1 &/or FC2 Fuse

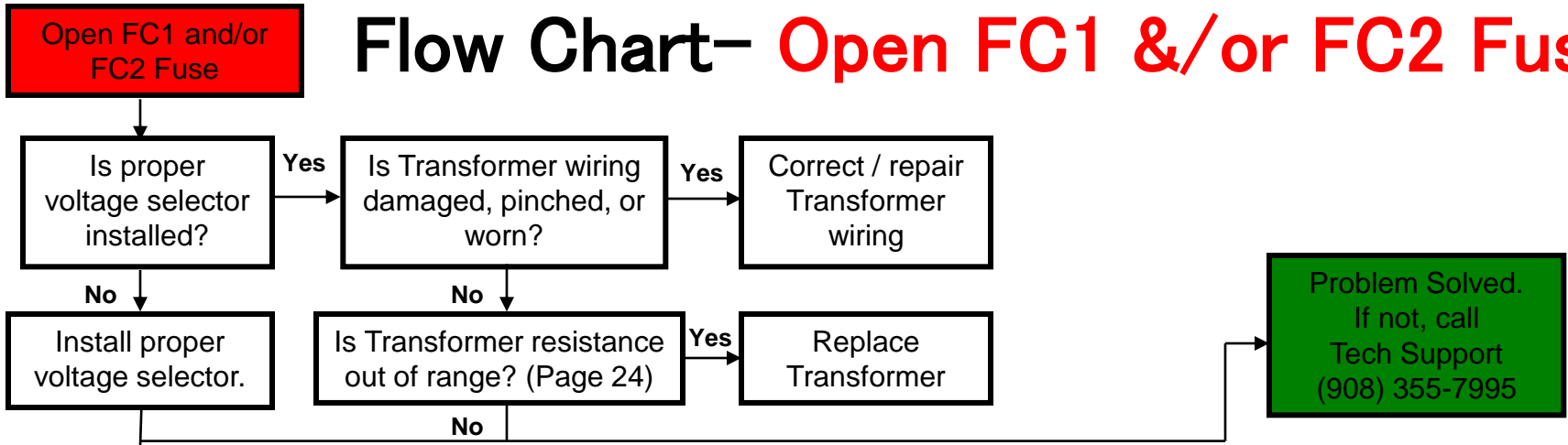

Flow Chart- Open FC3 &/or F1 Fuse

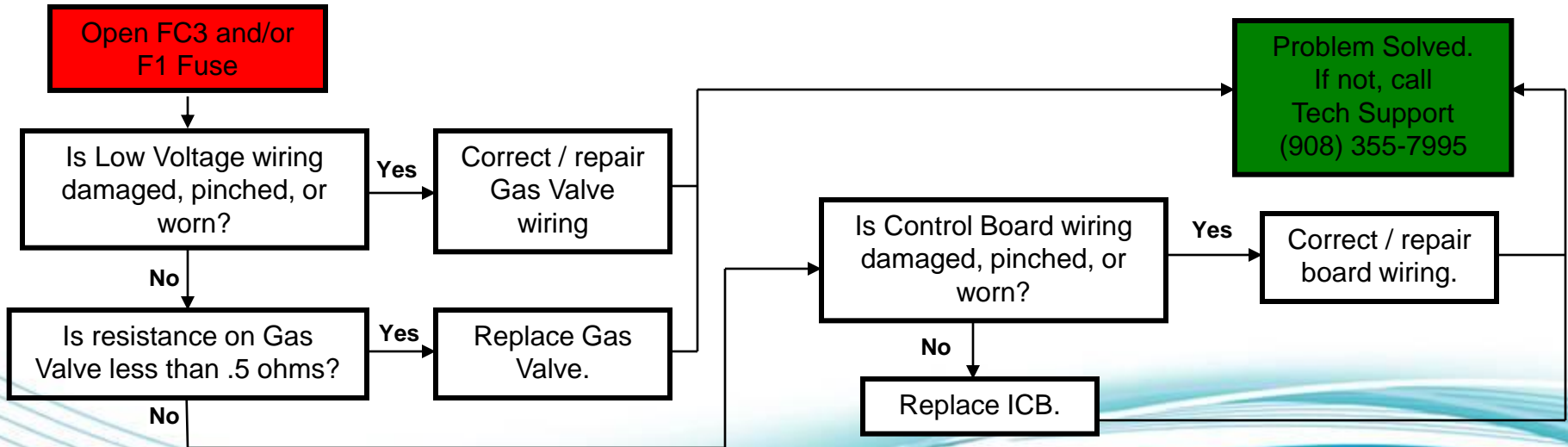

Flow Chart– Open FC4 Fuse and BD Code

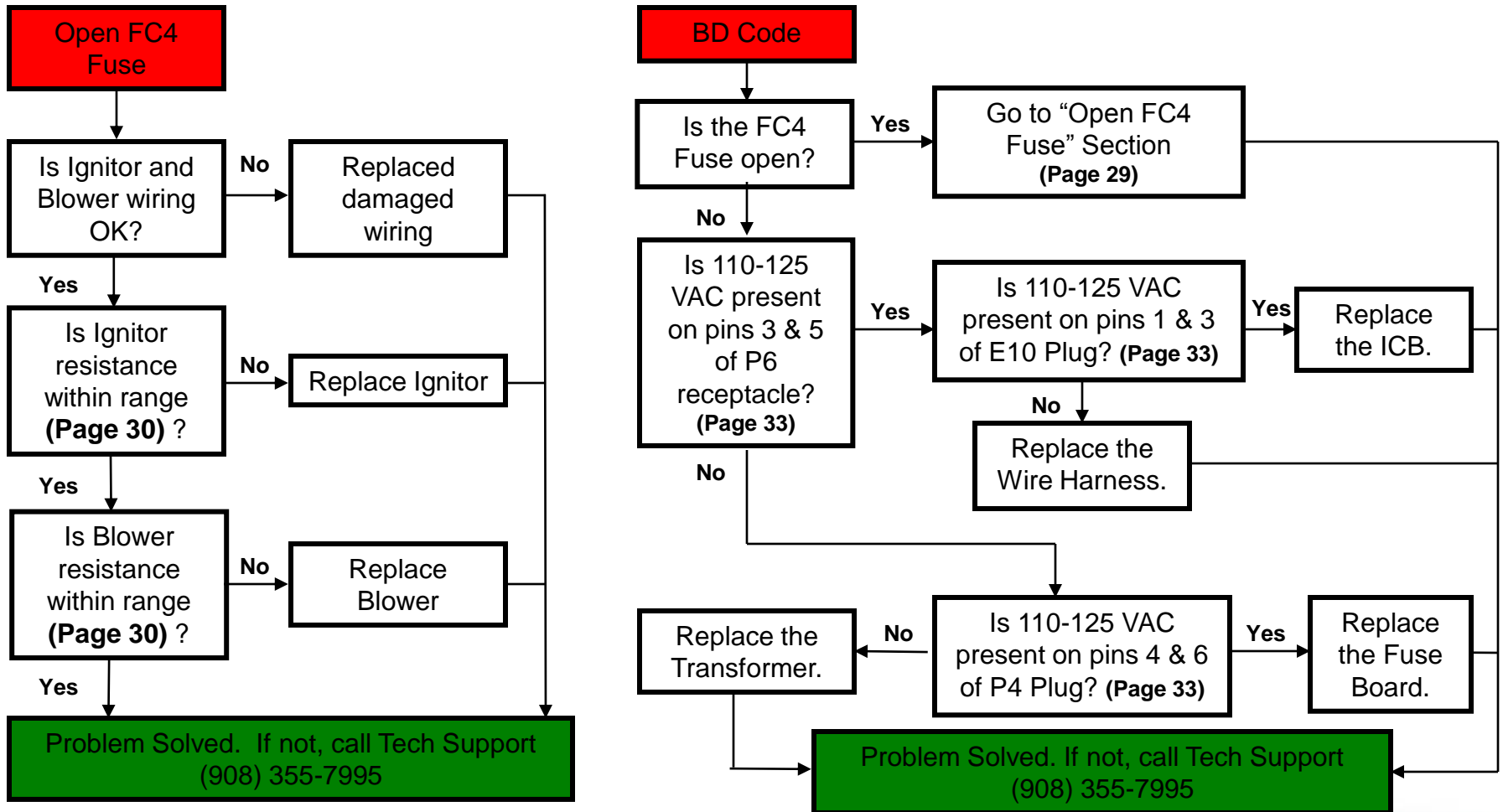

Flow Chart- LO Code

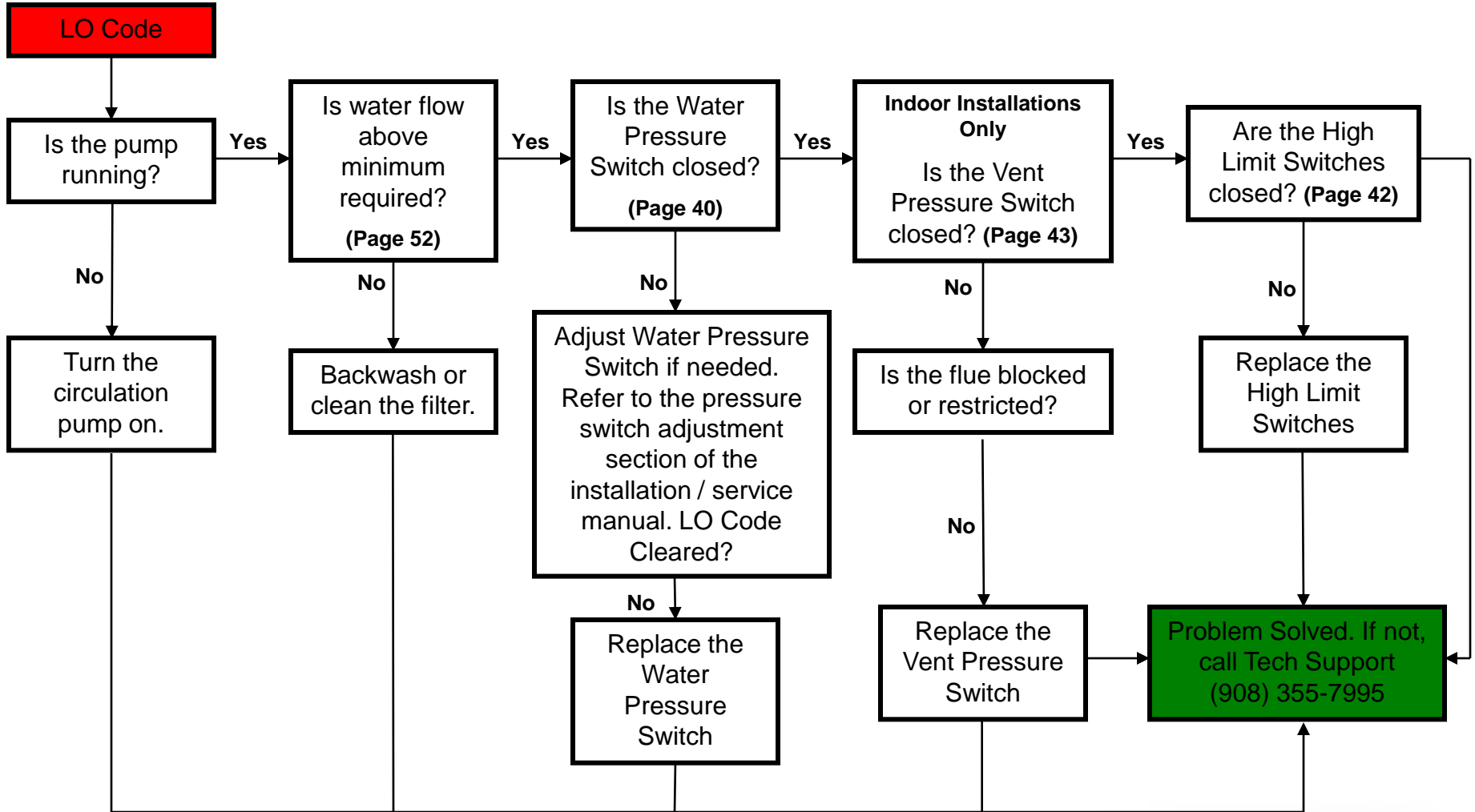

Flow Chart – IF Code

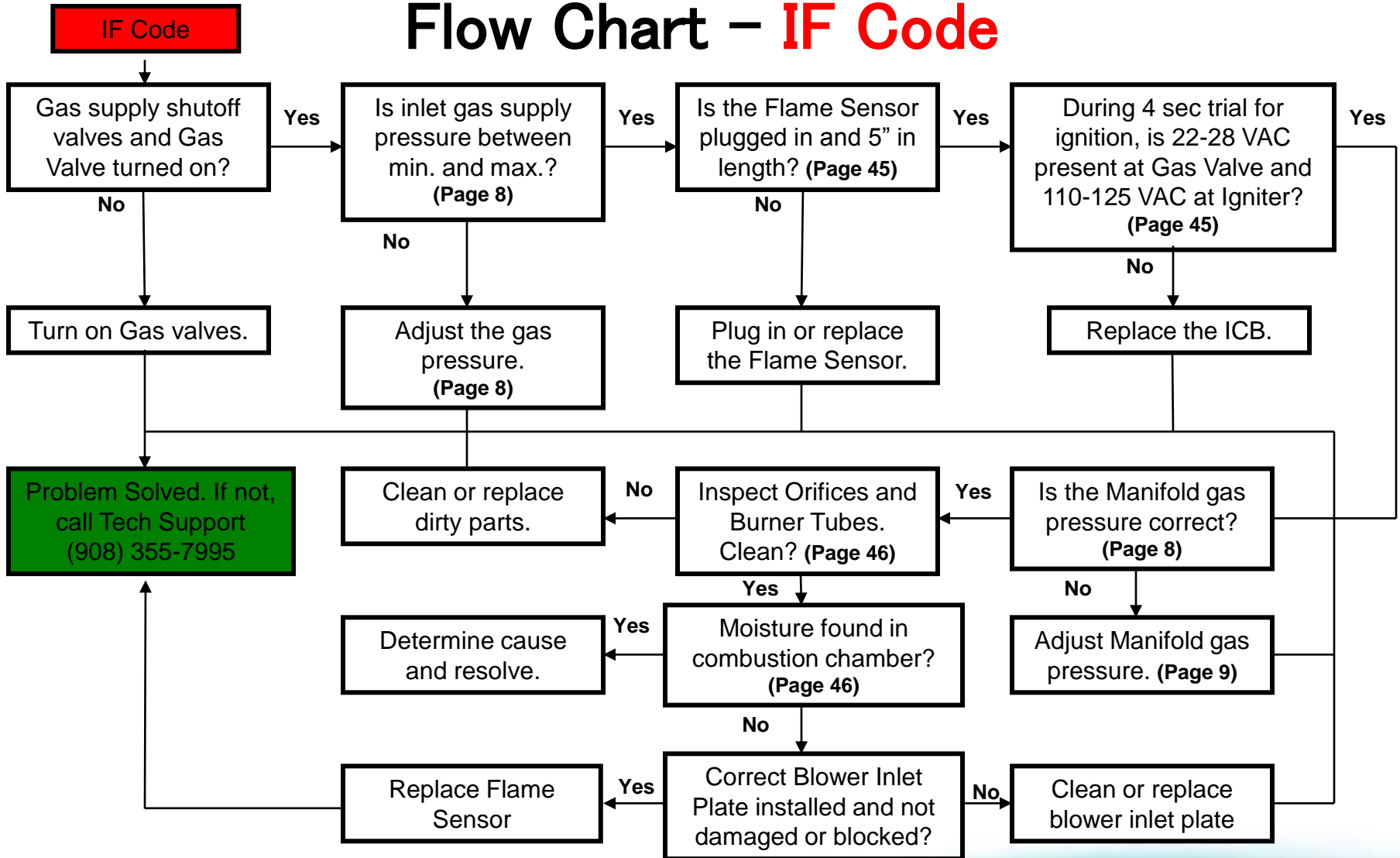

Flow Chart – AO & AC Code

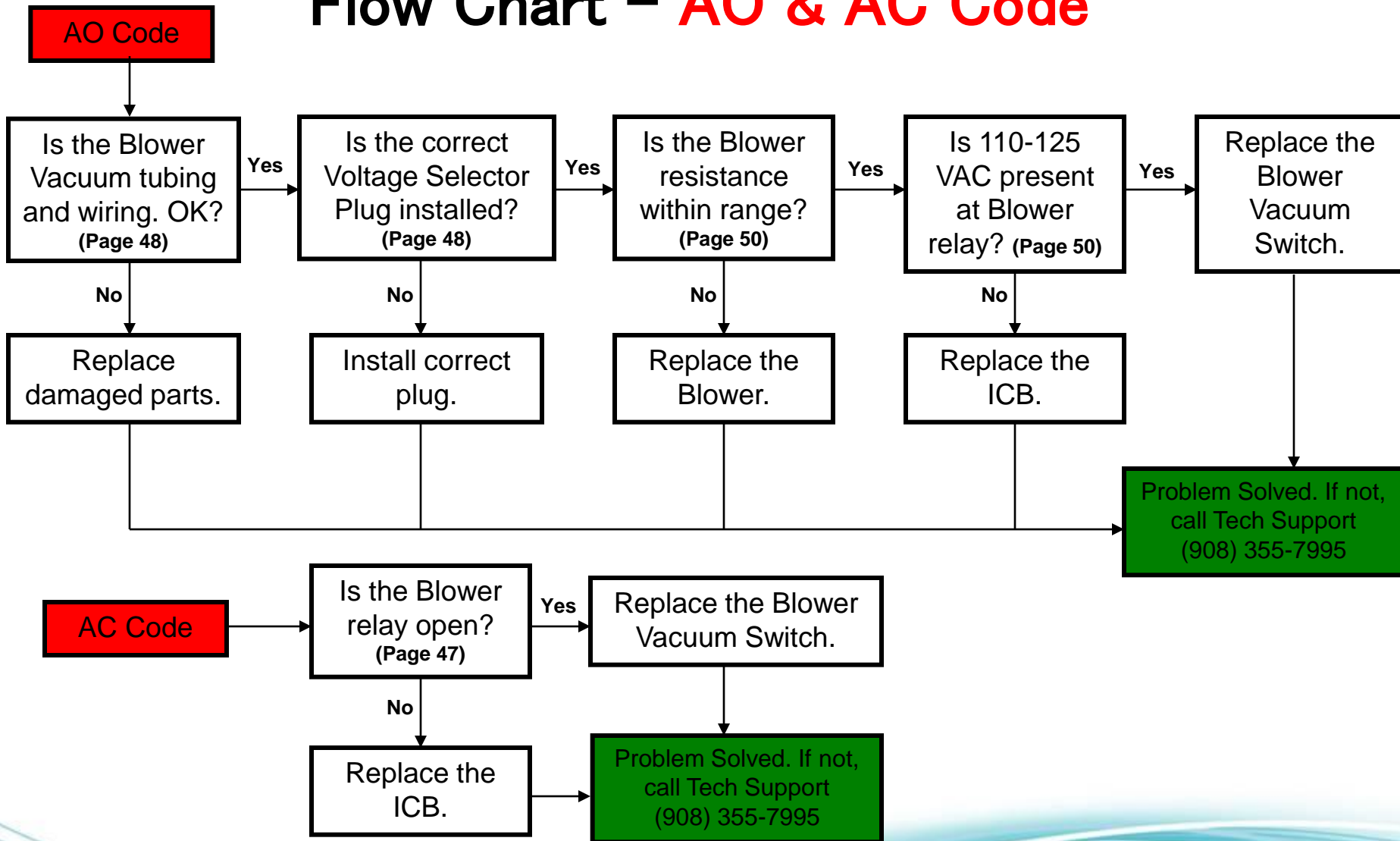

Schematic

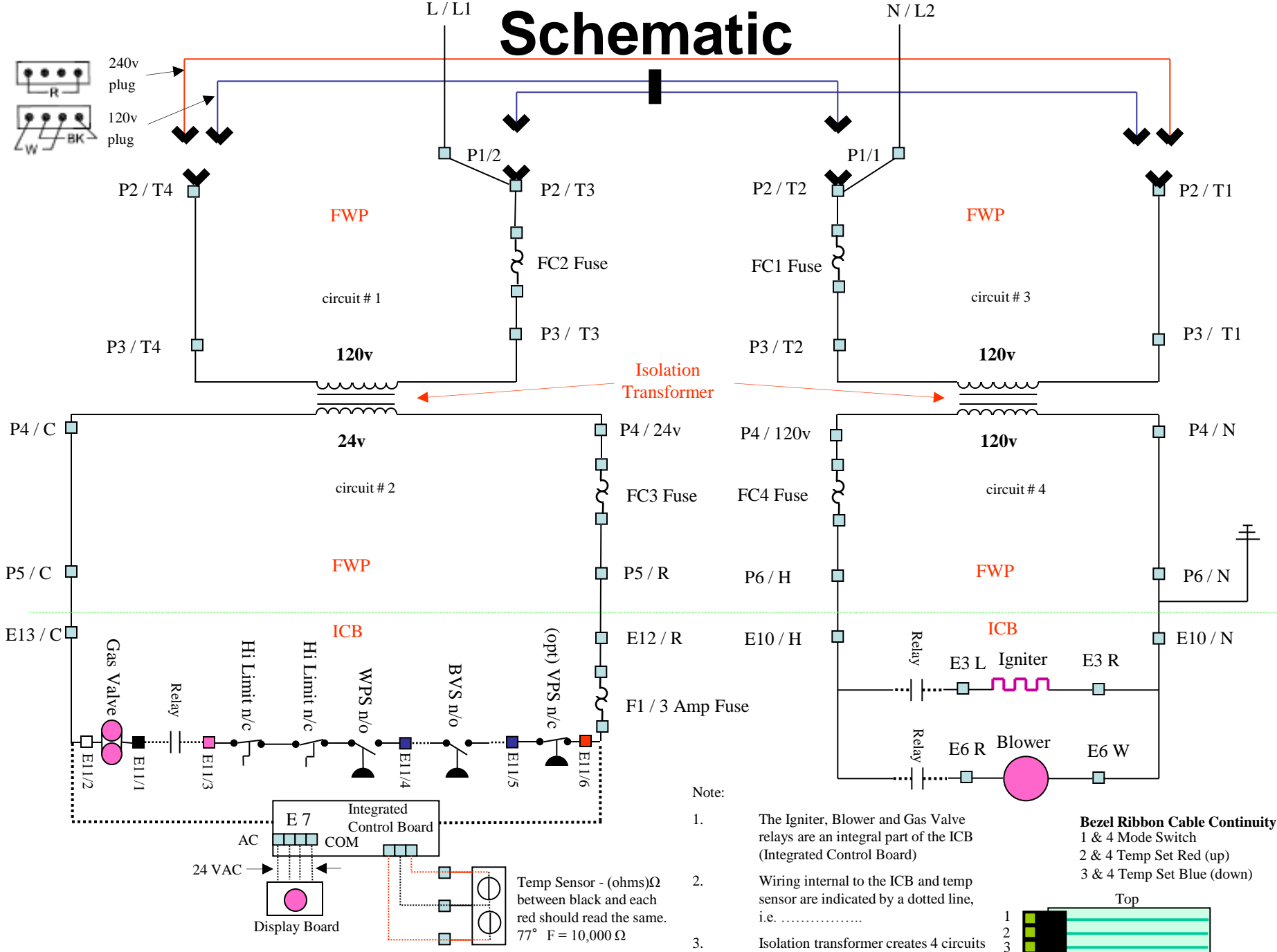

Note:

1. The Igniter, Blower and Gas Valve relays are an integral part of the ICB (Integrated Control Board)
2. Wiring internal to the ICB and temp sensor are indicated by a dotted line, i.e.
3. Isolation transformer creates 4 circuits as shown for troubleshooting.

Bezel Ribbon Cable Continuity

- 1 & 4 Mode Switch
- 2 & 4 Temp Set Red (up)
- 3 & 4 Temp Set Blue (down)

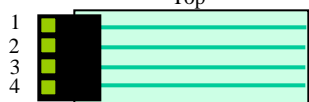

Wiring Connection Diagram

