

ZAXIS200



HYDRAULIC EXCAVATOR

Model Code : ZX200-5G / ZX200LC-5G / ZX210H-5G / ZX210LCH-5G
ZX210K-5G / ZX210LCK-5G

Engine Rated Power : 125 kW (168 HP)

Operating Weight : ZX200-5G : 19 800 kg / ZX200LC-5G : 20 400 kg
ZX210H-5G : 21 100 kg / ZX210LCH-5G : 21 500 kg
ZX210K-5G : 21 100 kg / ZX210LCK-5G : 21 500 kg

Backhoe Bucket : ISO Heaped : 0.51 - 1.20 m³

ZAXIS Empower your Vision.

A ZAXIS hallmark – industry-leading hydraulic technologies, and performance no other can beat. New ZAXIS provides reliable solutions: impressive fuel economy, swift front movements, and easy operation. You'll also find Hitachi technological prowess and expertise, such as the optimized hydraulic system and engine.

New ZAXIS features the key benefits of high quality, low fuel consumption, and high durability, all of which serve to ensure low running costs.

New ZAXIS, which is empowered by comprehensive evolution, will realize customers' visions and dreams, and pioneer your colorful future.

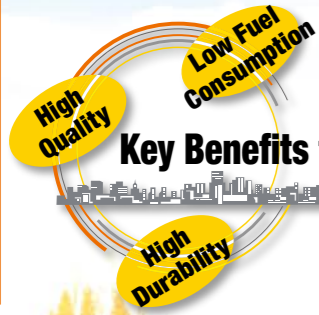

More Production with Less Fuel

Page 4-5

- 9% reduction in fuel consumption
- More fuel reduction in the ECO mode
- Swift front movements with HIOS III hydraulics
- Powerful lifting operation
- Boosted swing torque
- Enhanced power digging



No Compromise on Operator Comfort

Page 8-9

- Comfortable operating environment
- Comfort-designed operator seat
- Robust cab
- New, easy-to-use multifunctional monitor

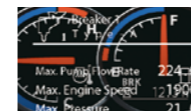

Reliable Solutions, with Various Options

Page 12-13

- Varied jobs, varied options
- Recommended options



Various Versions

Page 16-17

- Heavy-duty version: H-series
- Demolition version: K-series



Pursuits of Performance and Durability

Page 6-7

- Prestige R&D and quality control
- Durable, reliable engine
- Rock-solid, durable front attachment
- Strengthened undercarriage
- Proven upperstructure



Simplified Maintenance

Page 10-11

- Dust-proof indoor net
- Grouped remote inspection points
- Attractive, robust body
- Low life cycle costs



Hitachi Support Chain

Page 14-15

- Remote fleet management with Global e-Service
- Parts and service



Note: The photos in this brochure show excavators with optional equipments such as rear view camera.

More Production with Less Fuel

9% Reduction in Fuel Consumption

New ZAXIS is a fuel-thrifty excavator that can reduce fuel consumption by 9%*, compared to the conventional ZX200-3/ZX200-3F family, thanks to the HIOS III hydraulic system and engine control system, thereby reducing CO₂ emissions.

*5%, compared to the ZX200/ZX200-3G.

More Fuel Reduction in the ECO mode

The ECO mode, a new economical mode, can further cut fuel consumption by 9% compared to the PWR mode, without sacrificing digging speed by optimal matching of operations.



Swift Front Movements with HIOS* III Hydraulics

Operating speed increases with less fuel consumption thanks to the HIOS III hydraulic system, developed by industry-leading hydraulic technologies and a wealth of experience. Actuators work quickly by boom weight, without needing a regenerative circuit and pressure oil.

*Human & Intelligent Operation System

Rapid Arm Roll-in

Arm roll-in speed increases by combined flow from arm and boom cylinders through regenerative valves for productive excavation.

Fast Arm Speed During Boom Lowering

Arm speed increases by boom weight during boom lowering, without needing pressure oil from a pump. That is, arm circuit flow is increased for higher arm speed, allowing for quick loading of a dump truck and positioning of the front.

Powerful Lifting Operation

The Auto Power Lift mode, which automatically surge lifting force by 10% when needed, allows for powerful lifting of buried concrete pipes or sheathing sheets.

Boosted Swing Torque

Allows for powerful wall cutting with the bucket, and smooth swing operation on slope.

Enhanced Power Boost

The Power Boost mode allows the operator to surge 10% more digging force for powerful excavation by pressing its button on the control lever.



Pursuits of Performance and Durability

Prestige R&D and Quality Control

Hitachi has earned praise for technological prowess and product performance around the world. R&D Division has a track record – including excellent design, stress analysis expertise using CAE system, and abundant production data base. What's more, a large-scale durability test field (427 hm²) allows for a series of stringent testing of new machines.

Production Division strives to automatize production processes, including robotic welding, machining, painting, assembling and transferring.



Computer-Aided Engineering

Main pump testing area

Mid-sized excavator assembly line

Main frame welding line

Simulation testing from operator seat



Durable, Reliable Engine

This engine has a track record showing impressive durability at countless tough job sites around the world.

The engine — associated with a rugged design, a direct fuel injection system and an elaborate governor — goes green, and complies with EU Stage II and US EPA Tier 2 emissions regulations.

The cooling system well keeps the engine cool. The engine cover has a wider air suction area, and radiators are arranged in parallel for efficient cooling. This parallel arrangement also facilitates their cleaning.

The ample-capacity intercooler and turbocharger help yield a whopping 125 kW (168 HP) output for higher production in shorter job schedule.

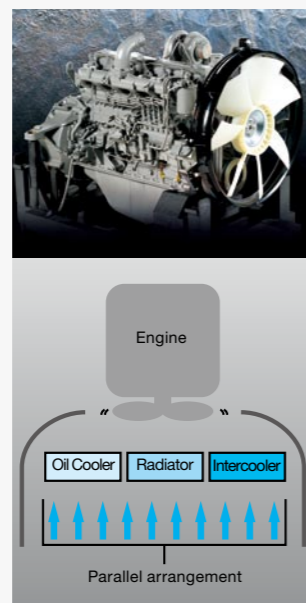

Engine

Oil Cooler Radiator Intercooler

Parallel arrangement

Rock-Solid, Durable Front Attachment

The boom top and foot are reinforced with thickened high-tensile steel brackets, which incorporate steel bushings to enhance durability. Arm cylinder and boom cylinders (rod extend ends) cushion shocks at stroke ends to cut noise and extend service life.

Joint pins at the front attachment are tightly fit to reduce jolt and sound. The arm-bucket joint is protected by WC thermal spraying on its contact surfaces to reduce wear and jolt. New-type HN bushings, utilized on joint pins, retain grease inside for longer greasing intervals. A reinforced resin thrust plate, mounted on the bucket pin, helps reduce wearing noise.

Strengthened Undercarriage

The X-beam frame is made monolithically with fewer welds for higher rigidity and durability. Track adjusters absorb impacts to crawlers. Front idlers and adjuster cylinders are integrated to increase durability. Idler brackets and travel motor brackets are both thickened for added durability.

Proven Upperstructure

The upperstructure frame is reinforced with the proven D-section skirt to increase rigidity against damage by obstacles. A large door catch is added to reduce shocks and jolts of the cab and upperstructure.



X-beam frame

Track adjuster

HN bushing

Reinforced resin thrust plates

WC thermal spraying

Boom foot

No Compromise on Operator Comfort

Comfortable Operating Environment

You'll feel comfortable and confident, with plenty of leg space and excellent visibility when operating the cab. The new compact console gives more leg space. The new door pillar is shifted rearward by 70 mm to widen an entry space for easy access. A new LED room light, interlocked with the door, turns on when the door opens. The front window is easily removed and stored overhead using slide rails. The overhead window is openable for ventilation. Ample air conditioner vents are located strategically for uniform air circulation inside the cab. The control panel and control levers are arranged within easy reach of the operator. AM/FM radio and AUX port (optional) for a mobile music player are available for a long work day with less fatigue. All these designs focus on operator comfort.

Comfort-Designed Operator Seat

The luxury cloth seat is fitted with a headrest and arm rests for operator comfort. The seat can be adjusted in multiple ways, sliding and reclining, to suit operator's size and preferences. The seat can slide rearward by 40 mm more for added leg space. An air suspension with a heat pad is optional.

Robust Cab

The robust cab, meeting the OPG (Top Guard Level 1), protects the operator from falling objects. The pilot control shut-off lever is provided with a neutral engine start system that permits engine starting only when the pilot control shut-off lever is in Lock position. The engine is lockable by entering a password through the 10-key panel.



Control panel



Large storage space



New, Easy-to-Use Multifunction Monitor

The new multi-language, multifunction monitoring system comprises a 7-inch high-resolution color monitor and a multifunction controller. The monitor allows the operator to check varying operating variables: oil temperature, fuel level, work mode, full-auto air conditioner, AM/FM radio, rear view monitor camera (optional), maintenance support, and attachment flow adjustment. Menu items can be selected and adjusted by a multifunction controller on the control panel. A new rear view monitor camera always displays the view behind the machine.



Simplified Maintenance



The photo shows an excavator with an optional front glass lower guard.



Dust-Proof Indoor Net

A dust-proof indoor net, provided at the front of radiator, can be easily removed and cleaned with compressed air. At the rear of the radiator, air blowing can be done through a one-touch open cover. The air condenser is openable for easy cleaning at its rear.

Attractive, Robust Body

Side frame tops of the undercarriage are sloped to let muck slide away. Track adjuster greasing ports are repositioned for easier lubrication, and well protected from muck packing.

Grouped Remote Inspection Points

Service points are concentrated inside left and right covers that are readily accessible from ground level for convenient servicing and inspection, including water draining from the fuel tank, replenishment of coolant, and replacement of filters. The fuel tank is anti-corrosion coated on its inside, and has a large cleaning port at the bottom. These wise designs effectively keep fuel clean, and ease servicing. Handrails are provided at convenient locations for easy riding on the upperstructure. Plenty slip-resistant plates are located for safe maintenance.

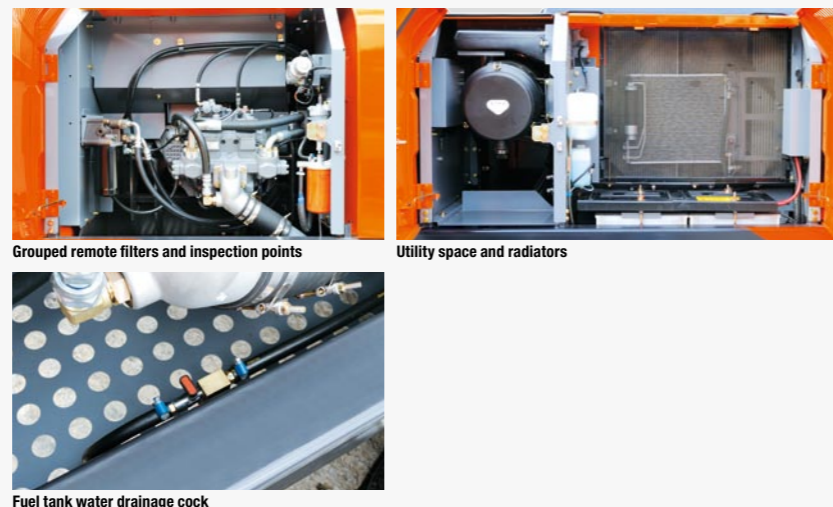

Low Life Cycle Costs

Service intervals are long enough to slash maintenance costs.

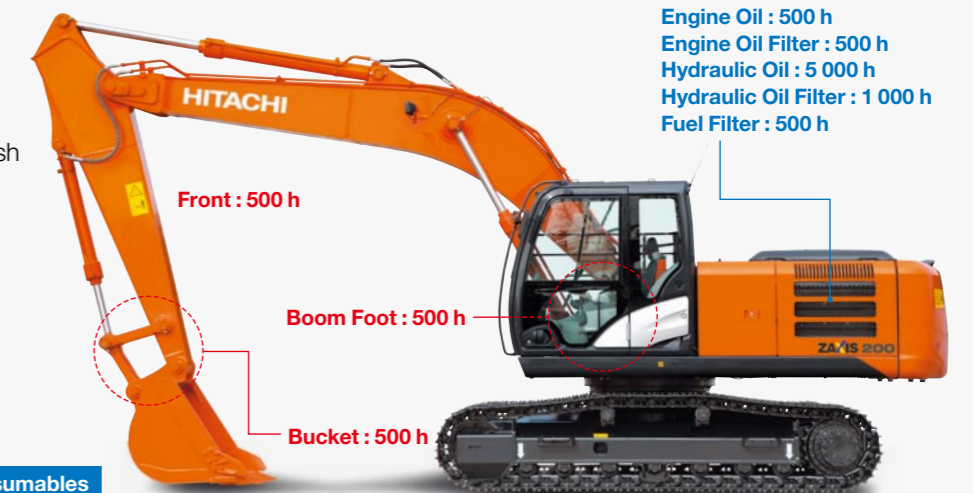

Note: Periodic inspection is required to check oil contamination and such.

Reliable Solutions, with Various Options

Easy-to-Use Attachments

The operator can change over valves, adjust extra circuit flow, and check settings from the multifunctional monitor next to the operator seat. What's more, 11 jobs, including flow rate setting, can easily be selected by their identified names.

Easy-to-Operate Breaker

When using a breaker that requires frequent change of hydraulic oil and filters, an extra hour meter on the multifunctional monitor displays operating hours of the breaker, suggesting adequate replacement timing of oil and filters. The Breaker Alarm (optional) displays an alert mark on the monitor screen, and sounds when the breaker works continuously over one minute.

Varied Jobs, Varied Options

Lower cab front guard is provided for protection against debris during demolition and breaker operation. The hose rupture valve is added to reduce oil leaks, and prevent the attachment from lowering, especially when a grapple or cutter is used, or when a front hose is punctured. High-performance filters and in-line filters are available at tough job sites.

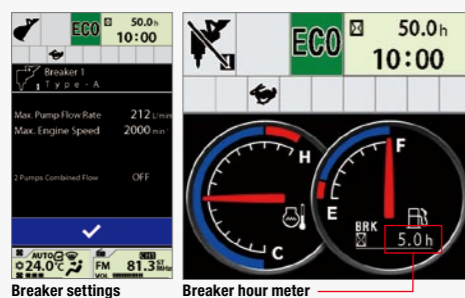

Recommended Options

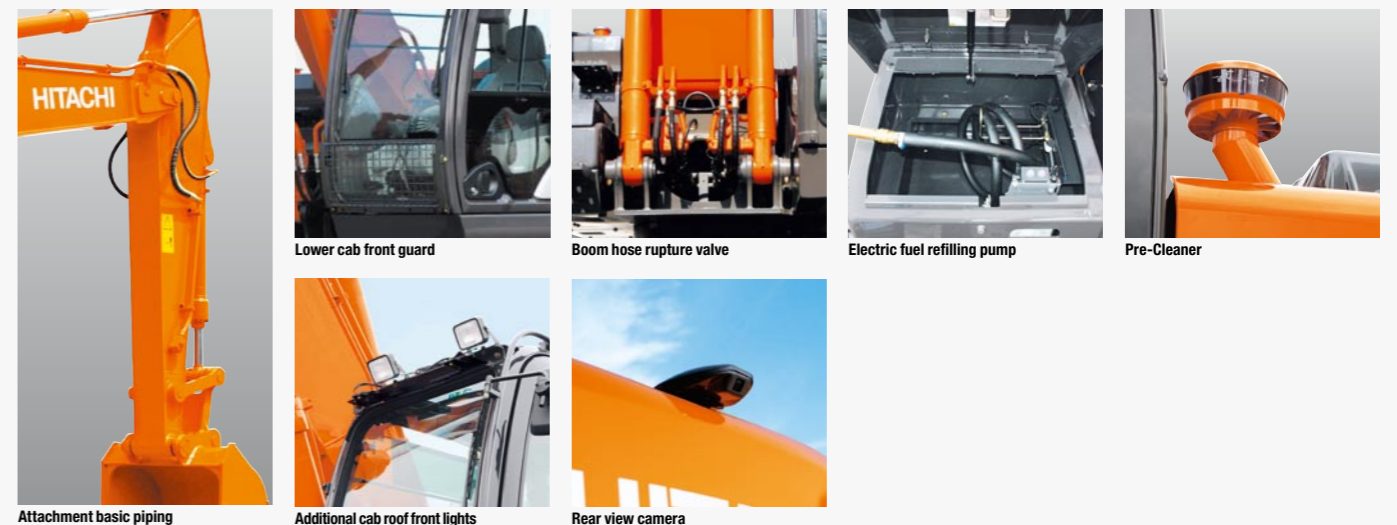

Hitachi Support Chain

Hitachi Support Chain is a full customer support system offered after buying a Hitachi machine.

Remote Fleet Management with Global e-Service

Easy Access to On-Site Machines through the Internet

This on-line fleet management system allows you to access each on-site machine from a PC in your office. You can get its operating information and location to increase productivity of the fleet and reduce downtime. Operating data and log are sent to a Hitachi server for processing, and then to customer and dealers around the world. This system is available 24 hours a day, all the year around.

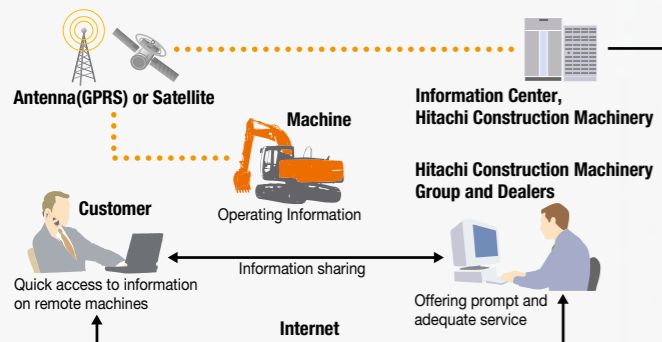

Note: In Some Regions, Global e-Service Is Not Available by Local Regulations.

Main Features of Global e-Service

Functions

Global e-Service provides easy access to a machine on site, conveying operating information and log, including daily operating hours, fuel level, temperatures, pressures, and likes.

Maintenance

Maintenance data and log are displayed on a easy-to-read monitor screen, suggesting recommended maintenance for efficient fleet management.

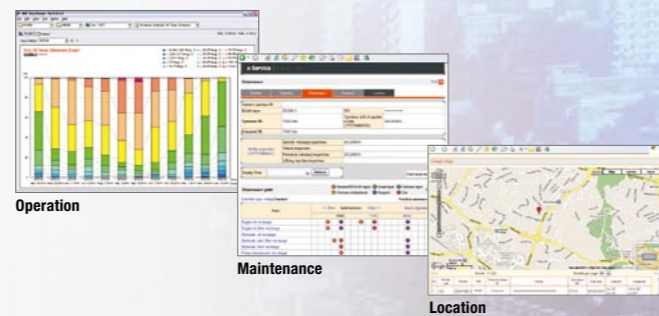

Parts and Service

Hitachi full customer support is available every area on the globe for full customer satisfaction through Hitachi local dealers.

Parts

Hitachi Global Online Network, a parts supply system, is linked with Japan Parts Center, overseas depots and over 150 dealers abroad to deliver on-line parts information, including in-stock parts, order receptions, shipments and delivery period of over one million parts and components.

Genuine Hitachi Parts

Genuine Hitachi parts, meeting Hitachi stringent quality standards, are guaranteed according to Hitachi warranty standards. The use of genuine Hitachi parts, including engine, fuel, hydraulic oil and filters, may slash running costs, and extend machine life.

Ground Engaging Tools (GETs)

Hitachi provides an array of Hitachi Ground Engaging Tools developed and built for a variety of applications.

Using high-quality, well-maintained GETs will help you get customers' trust.

Note: Some dealers do not handle Hitachi GETs.

Remanufactured Components

Hitachi components are remanufactured according to the stringent remanufacturing standards at four factories around the world. They have high quality equivalent to new ones, and backed up by Hitachi warranty system.

Note: Some dealers do not handle Hitachi Remanufactured Components.

Service

Extended Warranty — HELP

Hitachi Standard Warranty System is available on all new Hitachi machines. In addition, Hitachi offers Hitachi Extended Life Programs (HELPS) to suit customer expectations –

protecting machines under tough operating conditions, avoiding unexpected downtime, and reducing repair costs.

Note: Warranty conditions vary by equipment.

Diagnostic Tools — Maintenance Pro

Electronic control system needs quick on-site solutions, apart from mechanical repairs. Hitachi's Maintenance Pro can diagnose machine failures in a short time by plugging a PC into a failed machine.

Technical Training

On-site servicing matters despite locations to keep the machine at peak performance and reduce downtime. Technical Training Center (TTC), located in Japan, educates and trains service technicians and service support personnel coming from Hitachi dealers and factories on the globe according to the international training programs.



The photos above show machine images at work, which include machines other than ZAXIS 200 series.

Various Versions

Heavy-Duty Version: H-Series ZAXIS 210H

Reinforced Front Attachment (H-Boom / H-Arm)

Thickened steel plates, damage prevention plates and square bars

Thickened steel plates
Reinforcement

*Reinforced portions not available on standard ZAXIS 200 are shown.

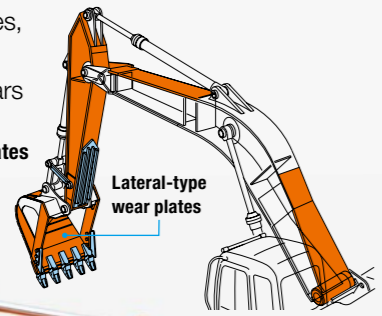

Demolition Version: K-Series ZAXIS 210k

Reinforced Front Attachment (K-Boom / K-Arm)

Thickened steel plates, and damage prevention plates

Attachment basic piping

Reinforced link B for demolition

Reinforced lower flange

0.80 m³ reinforced bucket

Twin wipers

Breaker and crusher piping

High-performance full-flow filters with restriction indicators

9 mm reinforced track undercover

600 mm reinforced triple grouser shoes

K-cab (Cab with overhead window & guard)

Lower cab front guard

400 kg heavier counterweight

6.0 mm reinforced undercover

Reinforced side step (bolted)

Reinforced idler bracket

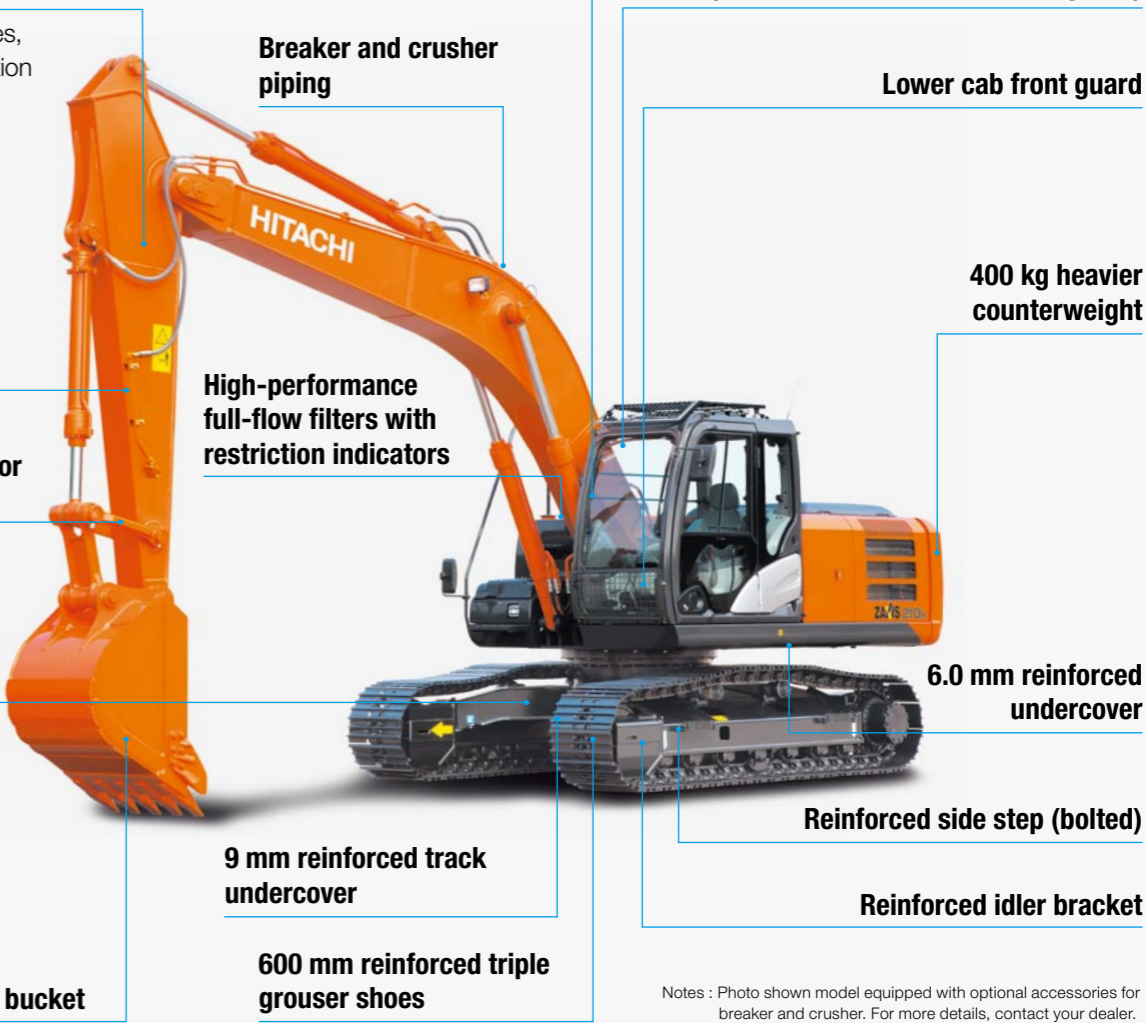

Notes : Photo shown model equipped with optional accessories for breaker and crusher. For more details, contact your dealer.

SPECIFICATIONS

ENGINE

Model	Isuzu CC-6BG1T
Type	4-cycle water-cooled, direct injection
Aspiration	Turbocharged, intercooled
No. of cylinders	6
Rated power	
ISO 9249, net	125 kW (168 HP) at 2 100 min ⁻¹ (rpm)
SAE J1349, net	125 kW (168 HP) at 2 100 min ⁻¹ (rpm)
Maximum torque	637 Nm (65 kgfm) at 1 800 min ⁻¹ (rpm)
Piston displacement ..	6.494 L
Bore and stroke	105 mm x 125 mm
Batteries	2 x 12 V / 88 Ah

HYDRAULIC SYSTEM

Hydraulic Pumps

Main pumps	2 variable displacement axial piston pumps
Maximum oil flow ..	2 x 212 L/min
Pilot pump	1 gear pump
Maximum oil flow ..	33.6 L/min

Hydraulic Motors

Travel	2 variable displacement swash plate piston motors
Swing	1 swash plate piston motor

Relief Valve Settings

Implement circuit	34.3 MPa (350 kgf/cm ²)
Swing circuit	34.3 MPa (350 kgf/cm ²)
Travel circuit	34.3 MPa (350 kgf/cm ²)
Pilot circuit	3.9 MPa (40 kgf/cm ²)
Power boost	38.0 MPa (388 kgf/cm ²)

Hydraulic Cylinders

	Quantity	Bore	Rod diameter
Boom	2	120 mm	85 mm
Arm	1	135 mm	95 mm
Bucket	1	115 mm	80 mm

UPPERSTRUCTURE

Revolving Frame

D-section frame skirt for resistance to deformation.

Swing Device

Swash plate piston motor with planetary reduction gear is bathed in oil. Swing circle is single-row. Swing parking brake is spring-set/hydraulic-released disc type.

Swing speed	13.5 min ⁻¹ (rpm)
Swing torque	68 kNm (6 900 kgfm)

Operator's Cab

Independent spacious cab, 1 005 mm wide by 1 675 mm high, conforming to ISO* Standards.

* International Standardization for Organization

UNDERCARRIAGE

Tracks

Heat-treated connecting pins with dirt seals. Hydraulic (grease) track adjusters with shock-absorbing recoil springs.

Numbers of Rollers and Shoes on Each Side

Upper rollers	2
Lower rollers	7 : ZX200-5G/ZX210H-5G/ZX210K-5G 8 : ZX200LC-5G/ZX210LCH-5G/ ZX210LCK-5G
Track shoes	46 : ZX200-5G/ZX210H-5G/ZX210K-5G 49 : ZX200LC-5G/ZX210LCH-5G/ZX210LCK-5G
Track guard	1 : ZX200-5G/ZX200LC-5G/ZX210K-5G/ ZX210LCK-5G 2 : ZX210H-5G/ZX210LCH-5G

Travel Device

Each track driven by 2-speed axial piston motor. Parking brake is spring-set/hydraulic-released disc type. Automatic transmission system: High-Low.

Travel speeds	High : 0 to 5.5 km/h Low : 0 to 3.5 km/h
---------------------	---

Maximum traction force .. 203 kN (20 700 kgf)

Gradeability

SERVICE REFILL CAPACITIES

Fuel tank	400.0 L
Engine coolant	23.0 L
Engine oil	25.0 L
Swing device	6.2 L
Travel device (each side).....	6.8 L
Hydraulic system	240.0 L
Hydraulic oil tank	135.0 L

WEIGHTS AND GROUND PRESSURE

Operating weight and Ground pressure

Shoe type	Shoe width	Arm length	ZX200-5G ^{*1}		ZX200LC-5G ^{*1}	
			kg	kPa(kgf/cm ²)	kg	kPa(kgf/cm ²)
Triple grouser	600 mm	2.42 m	19 700	44 (0.45)	20 300	42 (0.43)
		2.91 m	19 800	44 (0.45)	20 400	42 (0.43)
	700 mm	2.42 m	20 100	38 (0.39)	20 700	37 (0.38)
		2.91 m	20 200	39 (0.40)	20 700	37 (0.38)
	800 mm	2.42 m	20 400	34 (0.35)	21 000	32 (0.33)
		2.91 m	20 500	34 (0.35)	21 000	32 (0.33)
Reinforced Triple grouser	600 mm	2.42 m	—	—	—	—
		2.91 m	—	—	—	—
Triangular	760 mm	2.42 m	20 800	36 (0.37)	21 400	34 (0.35)
		2.91 m	20 800	36 (0.37)	21 400	34 (0.35)
Flat	600 mm	2.42 m	20 600	46 (0.47)	21 200	44 (0.45)
		2.91 m	20 600	46 (0.47)	21 200	44 (0.45)
Pad crawler	600 mm	2.42 m	20 000	44 (0.45)	21 000	43 (0.44)
		2.91 m	20 100	45 (0.46)	21 100	43 (0.44)

Shoe type	Shoe width	Arm length	ZX210H-5G ^{*2}		ZX210LCH-5G ^{*2}		ZX210K-5G ^{*3}		ZX210LCK-5G ^{*3}	
			kg	kPa(kgf/cm ²)	kg	kPa(kgf/cm ²)	kg	kPa(kgf/cm ²)	kg	kPa(kgf/cm ²)
Reinforced Triple grouser	600 mm	2.91 m	21 100	47 (0.48)	21 500	44 (0.45)	21 100	47 (0.48)	21 500	44 (0.45)

*1 :Including 0.80 m³ (ISO heaped) bucket weight (660 kg) and counterweight (4 200kg).

*2 :Including 0.80 m³ (ISO heaped) H-bucket weight (760 kg) and counterweight (4 600kg).

*3 :Including 0.80 m³ (ISO heaped) reinforced bucket weight (750 kg) and counterweight (4 600kg).

SPECIFICATIONS

WEIGHT: BASIC MACHINE and COMPONENTS

Basic Machine Weight and Overall width

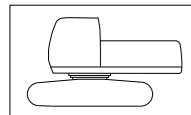

Excluding front-end attachment, fuel, hydraulic oil, coolant, etc., and including counterweight.

ZX200-5G

Shoe width	Weight	Overall width
600 mm	15 400 kg	2 860 mm
700 mm	15 800 kg	2 910 mm
800 mm	16 000 kg	3 000 mm

ZX210H-5G

Shoe width	Weight	Overall width
600 mm	16 300 kg	2 860 mm

ZX210K-5G

Shoe width	Weight	Overall width
600 mm	16 300 kg	2 860 mm

ZX200LC-5G

Shoe width	Weight	Overall width
600 mm	15 900 kg	2 990 mm
700 mm	16 300 kg	3 090 mm
800 mm	16 600 kg	3 190 mm

ZX210LCH-5G

Shoe width	Weight	Overall width
600 mm	16 800 kg	2 990 mm

ZX210LCK-5G

Shoe width	Weight	Overall width
600 mm	16 800 kg	2 990 mm

Component weights

	ZX200-5G / ZX200LC-5G	ZX210H-5G / ZX210LCH-5G	ZX210K-5G / ZX210LCK-5G
Counterweight	4 200 kg	4 600 kg	4 600 kg
Boom (with boom and arm cylinder)	2 180 kg	2 280 kg	2 230 kg
2.42 m arm (with bucket cylinder)	850 kg	—	—
2.91 m arm (with bucket cylinder)	920 kg	1 120 kg	1 140 kg
0.80 m ³ bucket	660 kg	760 kg	750 kg

BUCKET AND ARM DIGGING FORCES

Arm length	2.42 m	2.91 m
Bucket digging force* ISO	158 kN (16 200 kgf)	158 kN (16 200 kgf)
Bucket digging force* SAE : PCSA	141 kN (14 400 kgf)	141 kN (14 400 kgf)
Arm crowd force* ISO	140 kN (14 200 kgf)	114 kN (11 600 kgf)
Arm crowd force* SAE : PCSA	133 kN (13 600 kgf)	110 kN (11 200 kgf)

* At power boost

BACKHOE ATTACHMENTS

Boom and arms are of welded, box-section design. 5.68 m boom, and 2.42 m and 2.91 m arms are available. Bucket is of welded steel structure. Side clearance adjust mechanism provided on the bucket joint bracket.

Buckets

Capacity	Width		No. Of teeth	Weight	Recommendation						
					ZX200-5G		ZX200LC-5G		ZX210H-5G ZX210LCH-5G	ZX210K-5G ZX210LCK-5G	
					2.42 m arm	2.91 m arm	2.42 m arm	2.91 m arm	2.91 m H-arm	2.91 m K-arm	
ISO heaped	Without side cutters	With side cutters									
0.51 m ³	720 mm	830 mm	3	530 kg	⊙	⊙	⊙	⊙	⊙	⊙	⊙
0.80 m ³	1 030 mm	1 140 mm	5	660 kg	⊙	⊙	⊙	⊙	⊙	⊙	⊙
0.91 m ³	1 150 mm	1 260 mm	5	700 kg	⊙	○	⊙	⊙	○	⊙	○
1.10 m ³	1 330 mm	1 440 mm	6	770 kg	□	—	○	○	—	○	—
1.20 m ³	1 450 mm	—	6	690 kg	□	—	□	—	—	—	—
*1 0.80 m ³	1 030 mm	1 140 mm	5	750 kg	⊙	⊙	⊙	⊙	⊙	⊙	⊙
*1 0.91 m ³	1 150 mm	1 260 mm	5	800 kg	⊙	○	⊙	⊙	○	⊙	○
*2 0.80 m ³	1 040 mm	1 150 mm	5	760 kg	⊙	⊙	⊙	⊙	⊙	⊙	⊙
*3 0.80 m ³	1 030 mm	1 140 mm	5	660 kg	⊙	⊙	⊙	⊙	⊙	⊙	⊙
*4 0.80 m ³	1 040 mm	1 150 mm	5	760 kg	⊙	⊙	⊙	⊙	⊙	⊙	⊙
*5 0.60 m ³	800 mm	—	3	950 kg	●	—	●	—	—	—	—
One-point ripper			1	540 kg	●	—	●	—	—	—	—
Slope-finishing blade: Width 1 100 mm, length 1 800 mm			—	590 kg	◇	◇	◇	◇	◇	◇	—
V shape Bucket:			3	520 kg	○	○	○	○	○	○	—
Center-pull type clamshell bucket: 0.60 m ³ (CECE heaped), Width 940 mm			8	1 130 kg	⊙	⊙	⊙	⊙	⊙	⊙	⊙
Shell-push type clamshell bucket: 0.60 m ³ (CECE heaped), Width 870 mm			7	960 kg	⊙	⊙	⊙	⊙	⊙	⊙	⊙

*1 H-bucket

*2 Reinforced bucket

*3 Level-pin-type bucket

*4 Super V teeth type bucket

*5 Ripper bucket

⊙ Suitable for materials with density of 2 000 kg/m³ or less

○ Suitable for materials with density of 1 600 kg/m³ or less

□ Suitable for materials with density of 1 100 kg/m³ or less

● Heavy-duty service

◇ Slope-finishing service

— Not applicable

SPECIFICATIONS

WORKING RANGES

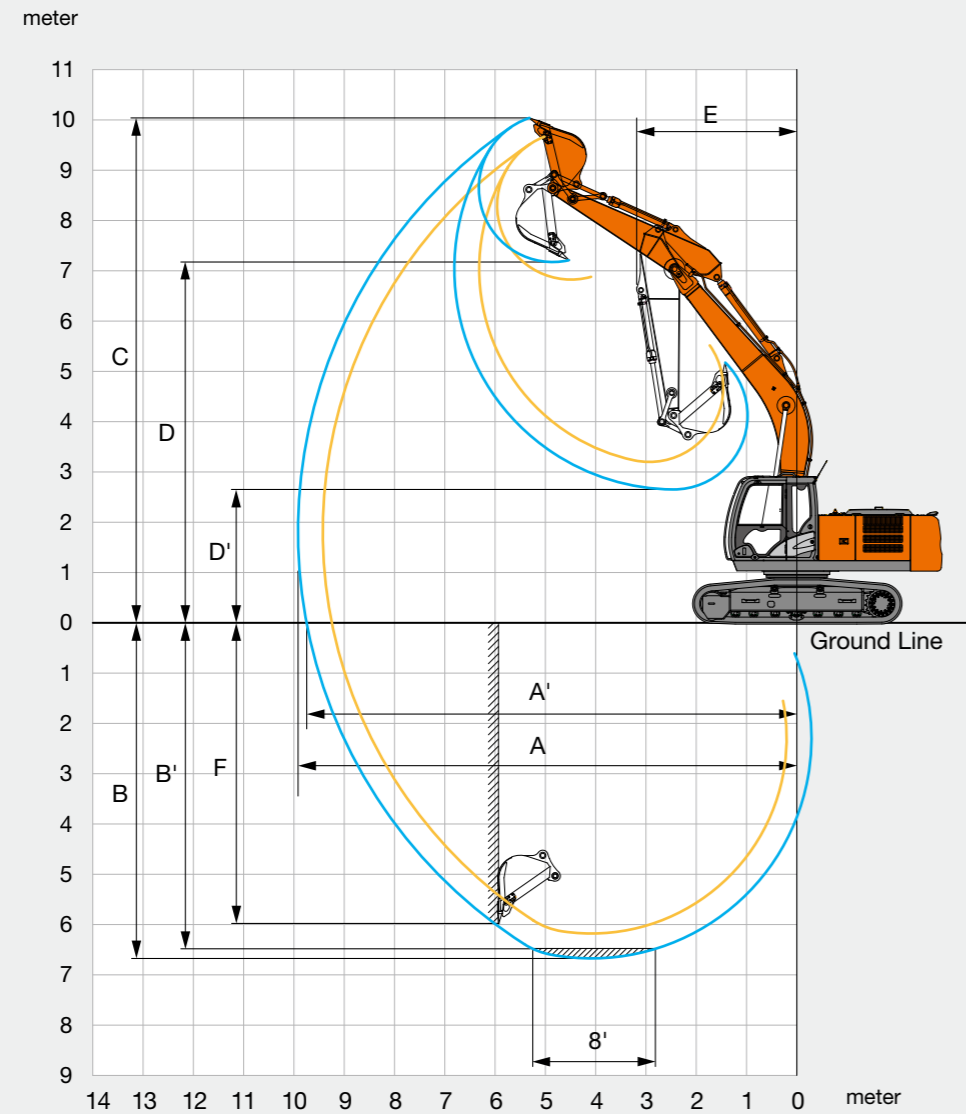

Unit: mm

Arm length	2.42 m	2.91 m
A Max. digging reach	9 430	9 920
A' Max. digging reach (on ground)	9 250	9 750
B Max. digging depth	6 180	6 670
B' Max. digging depth (8' level)	5 950	6 490
C Max. cutting height	9 670	10 040
D Max. dumping height	6 830	7 180
D' Min. dumping height	3 200	2 650
E Min. swing radius	3 280	3 180
F Max. vertical wall digging depth	5 300	5 990

Excluding track shoe lug

DIMENSIONS

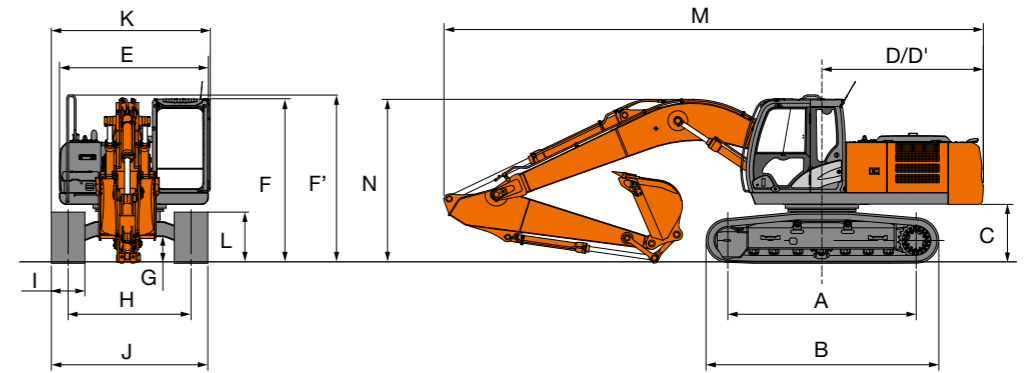

Unit: mm

	ZX200-5G	ZX200LC-5G	ZX210H-5G	ZX210LCH-5G	ZX210K-5G	ZX210LCK-5G
A Distance between tumblers	3 370	3 660	3 370	3 660	3 370	3 660
B Undercarriage length	4 170	4 470	4 170	4 470	4 170	4 470
* C Counterweight clearance	1 030	1 030	1 030	1 030	1 030	1 030
D Rear-end swing radius	2 890	2 890	2 890	2 890	2 890	2 890
D' Rear-end length	2 890	2 890	2 890	2 890	2 890	2 890
E Overall width of upperstructure	2 710	2 710	2 710	2 710	2 710	2 710
F Overall height of cab	2 950	2 950	2 950	2 950	2 950	2 950
F' Overall height of upperstructure	3 010	3 010	3 010	3 010	3 010	3 010
* G Min. ground clearance	450	450	450	450	450	450
H Track gauge	2 200	2 390	2 200	2 390	2 200	2 390
I Track shoe width	G 600	G 600	G 600	G 600	G 600	G 600
J Undercarriage width	2 800	2 990	2 800	2 990	2 800	2 990
K Overall width	2 860	2 990	2 860	2 990	2 860	2 990
* L Track height with triple grouser shoes	920	920	920	920	920	920
M Overall length						
With 2.42 m arm	9 750	9 750	—	—	—	—
With 2.91 m arm	9 660	9 660	9 660	9 660	9 660	9 660
N Overall height of boom						
With 2.42 m arm	3 180	3 180	—	—	—	—
With 2.91 m arm	2 940	2 940	2 940	2 940	2 940	2 940

* Excluding track shoe lug G: Triple grouser shoe

Standard and optional equipment may vary by country, so please consult your Hitachi dealer for details.

● : Standard equipment ○ : Optional equipment

	ZX200-5G / ZX200LC-5G	ZX210H-5G / ZX210LCH-5G	ZX210K-5G / ZX210LCK-5G
ENGINE			
Air cleaner double filters	●	●	●
Auto idle system	●	●	●
Cartridge-type engine oil filter	●	●	●
Cartridge-type fuel pre-filter	●	●	●
Cartridge-type fuel main filter	●	●	●
Dry-type air filter with evacuator valve (with air filter restriction indicator)	●	●	●
ECO/PWR mode control	●	●	●
Engine warm-up device	●	●	●
Fan guard	●	●	●
Water separator	●	●	●
Pre-cleaner	○	○	○
Dust-Proof indoor net	●	●	●
Radiator reserve tank	●	●	●
50 A alternator	●	●	●

HYDRAULIC SYSTEM			
Auto power lift	●	●	●
Control valve with main relief valve	●	●	●
Full-flow filter	●	●	●
High mesh full flow filter with restriction indicator	○	○	●
Hose rupture valve	○	○	○
Pilot filter	●	●	●
Power boost	●	●	●
Suction filter	●	●	●
One extra port for control valve	●	●	●
Work mode selector	●	●	●

	ZX200-5G / ZX200LC-5G	ZX210H-5G / ZX210LCH-5G	ZX210K-5G / ZX210LCK-5G
CAB			
All-weather sound suppressed steel cab	●	●	●
AM-FM radio with 2 speaker	●	●	●
Ashtray	●	●	●
Auto control air conditioner	●	●	●
AUX. terminal and storage	○	○	○
Cab (Center pillar reinforced structure)	●	●	●
Drink holder	●	●	●
Drink holder with hot & cool	●	●	●
Electric double horn	●	●	●
Engine shut-off lever	●	●	●
Evacuation hammer	●	●	●
Fire extinguisher bracket	○	○	○
Floor mat	●	●	●
Footrest	●	●	●
Front window washer	●	●	●
Front windows on upper, lower and left side can be opened	●	●	●
Lower cab front guard	○	●	●
Upper cab front guard	○	○	○
Glove compartment	●	●	●
Hot & cool box	●	●	●
Intermittent windshield wipers	●	●	●
Key cylinder light	●	●	●
K-cab. (CRES III cab with overhead window & guard)	—	—	●
LED room light with door courtesy	●	●	●
OPG top guard Level I (ISO10262) compliant cab	●	●	●
Pilot control shut-off lever	●	●	●
Rear tray	●	●	●
Retractable seat belt	●	●	●
Rubber radio antenna	●	●	●
Seat : Fabric seat	●	—	—
Seat : mechanical suspension seat	○	●	●
Seat : air suspension seat with heater	○	○	○
Seat adjustment part : backrest, armrest, height and angle, slide forward / back	●	●	●
Short wrist control levers	●	●	●
Twin wiper	—	—	●
4 fluid-filled elastic mounts	●	●	●
24V cigarette lighter	●	●	●

	ZX200-5G / ZX200LC-5G	ZX210H-5G / ZX210LCH-5G	ZX210K-5G / ZX210LCK-5G
MONITOR SYSTEM			
Alarm buzzers: overhear, engine oil pressure, overload	●	●	●
Alarms: overhear, engine warning, engine oil pressure, alternator, minimum fuel level, hydraulic filter restriction, air filter restriction, work mode, overload, etc	●	●	●
Display of meters: water temperature, hour, fuel rate, clock	●	●	●
Other displays: work mode, auto-idle, glow, rearview monitor, operating conditions, etc	●	●	●
32 languages selection	●	●	●

LIGHTS			
Additional cab roof front lights	○	○	○
Additional boom light with cover	○	○	○
2 working lights	●	●	●

UPPER STRUCTURE			
Electric fuel refilling pump	○	○	○
Fuel level float	●	●	●
Hydraulic oil level gauge	●	●	●
Rear view camera	○	○	○
Rear view mirror (right & left side)	●	●	●
Swing parking brake	●	●	●
Tool box	●	●	●
Undercover	●	●	●
6.0 mm reinforced undercover	○	●	●
Utility space	●	●	●
4 200 kg counterweight	●	—	—
4 600 kg counterweight	○	●	●
2 x 88 Ah batteries	●	●	●

	ZX200-5G / ZX200LC-5G	ZX210H-5G / ZX210LCH-5G	ZX210K-5G / ZX210LCK-5G
UNDERCARRIAGE			
Bolt-on sprocket	●	●	●
Reinforced track links with pin seals	●	●	●
Reinforced lower flange	—	●	●
Reinforced idler bracket	—	●	●
Travel motor covers	●	●	●
Travel parking brake	●	●	●
6.0 mm reinforced track undercover	○	○	●
Track guard (each side) and hydraulic track adjuster	●	●	●
Upper and lower rollers	●	●	●
2 track guards	○	●	○
4 tie down hooks	●	●	●
600 mm triple grouser shoes	●	● Reinforced	● Reinforced
Reinforced side step	—	●	●

FRONT ATTACHMENTS			
Centralized lubrication system	●	●	●
Dirt seal on all bucket pins	●	●	●
Flanged pin	●	●	●
HN bushing	●	●	●
Reinforced resin thrust plate	●	●	●
Reinforced link B	—	●	● for demolition
WC (tungsten-carbide) thermal spraying	●	●	●
0.80 m ³ bucket (ISO heaped)	●	● H-bucket	● Reinforced bucket
2.91 m arm	●	● H-arm	● K-arm
5.68 m boom	●	● H-boom	● K-boom

ATTACHMENTS			
Attachment basic piping	○	○	●
Breaker and crusher piping	○	○	●
High mesh full flow filter with restriction indicator	○	○	●
Parts for breaker and crusher	○	○	○
Welded bucket link A with welded hook	○	○	●
2 pump combined flow for attachment basic piping	○	○	○
Line filter	○	○	○

MISCELLANEOUS			
Lockable fuel refilling cap	●	●	●
Lockable machine covers	●	●	●
Onboard information controller	●	●	●
Skid-resistant tapes, plates and handrails	●	●	●
Standard tool kit	●	●	●
Travel direction mark on track frame	●	●	●
Global e-Service	●	●	●



Built on the foundation of superb technological capabilities, Hitachi Construction Machinery is committed to providing leading-edge solutions and services to contribute as a reliable partner to the business of customers worldwide.

Hitachi Environmental Vision 2025

The Hitachi Group released the Environmental Vision 2025 to curb annual carbon dioxide emissions. The Group is committed to global production while reducing environmental impact in life cycles of all products, and realizing a sustainable society by tackling three goals — prevention of global warming, conservation of resources, and preservation of ecosystem.

Reducing Environmental Impact by New ZAXIS

Hitachi makes a green way to cut carbon emissions for global warming prevention according to LCA*. New ZAXIS utilizes lots of technological advances, including the new ECO mode, and Isochronous Control. Hitachi has long been committed to recycling of components, such as aluminum parts in radiators and oil cooler. Resin parts are marked for recycling.

*Life Cycle Assessment – ISO 14040

Before using a machine with a satellite communication system, please make sure that the satellite communication system complies with local regulations, safety standards and legal requirements. If not so, please make modifications accordingly.

These specifications are subject to change without notice. Illustrations and photos show the standard models, and may or may not include optional equipment, accessories, and all standard equipment with some differences in color and features. Before use, read and understand the Operator's Manual for proper operation.