

HYDRAULIC ROTARY ACTUATORS  
FOR INDUSTRIAL APPLICATIONS  
**I-DA-H**

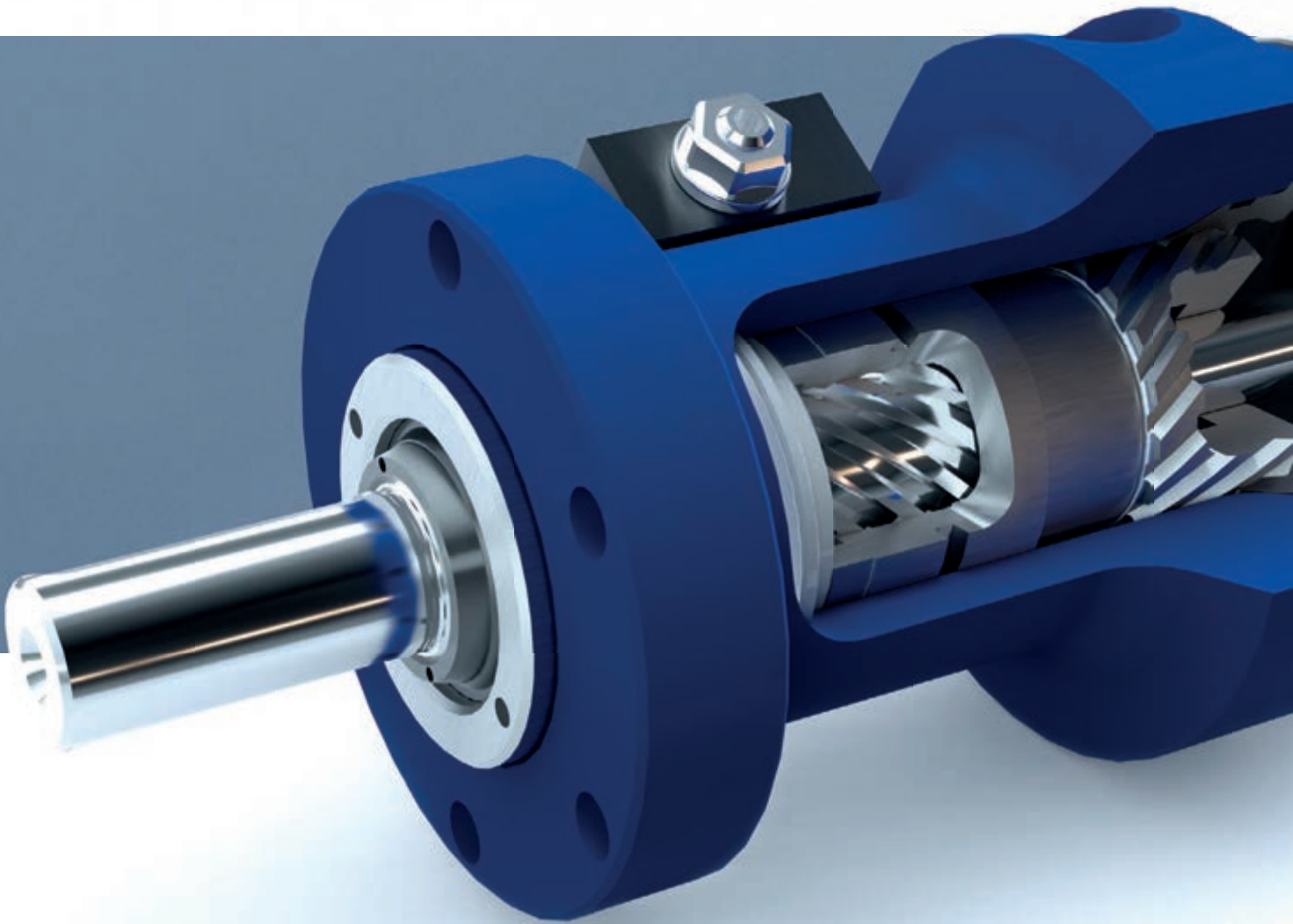



- 4** Moving solutions
- 6** Everything's included – series benefits
- 8** Functional principle
- 10** Your ideas are unlimited
- 12** Options for individuality
- 14** Tips for operating a rotary actuator
- 16** Technical data
- 18** Our locations
- 19** Application questionnaire



Video on multiple helical gear principle:  
[www.hks-partner.com](http://www.hks-partner.com)

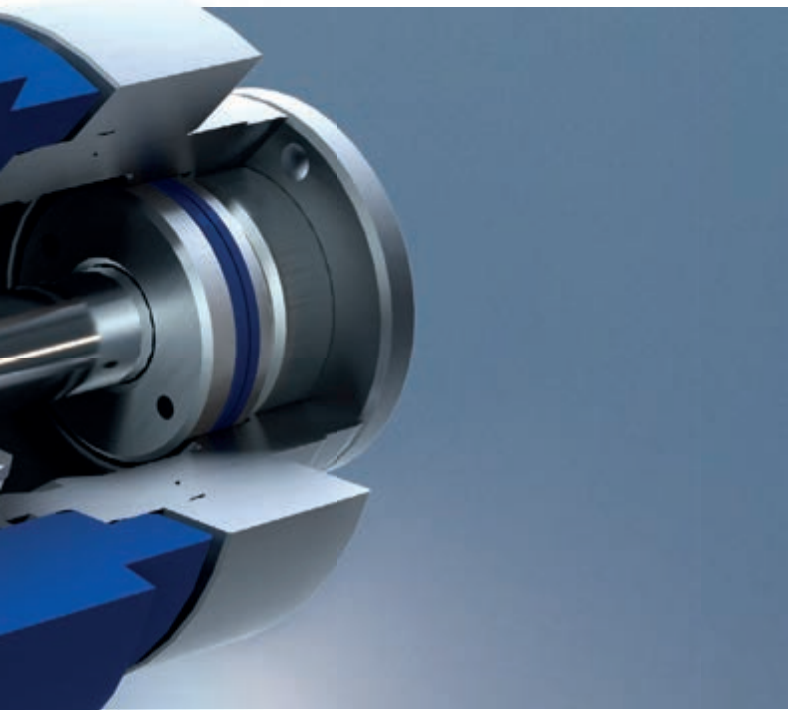

# HKS – we turn the world for you

## We put you in the best position

Wherever materials need to be rotated and tilted, precisely accelerated, braked, positioned and held, HKS products are there to help you get the job done – **with great precision and endurance**. We see “Made in Germany” as the highest standard and the yardstick for the quality of our products at the same time. Innovation is an integral part of everything we do, which is an advantage for you because with HKS products you can always be sure of working with state-of-the-art technology. HKS has its own development department and **manufactures practically every part in-house**, enabling us to provide you with everything you need in outstanding quality. That applies equally to all HKS rotary actuators, rotary-lift combinations or rack-and-pinion actuators, whether series equipment or purpose-built to suit your needs.

The outstanding quality of our rotary actuators is acknowledged internationally. It is based on our innovative developments, the use of the best material quality, and high precision production.

### I-DA-H highlights:

- › Interleaved gears are hardened
- › Operating pressure of up to 250 bar
- › Angular adjustments
- › Improved end position cushioning

## The multiple helical gear principle

The basis for this design principle is a **system of multiple helical gears**. The helical gears enable the linear movement of the piston to be converted into a total rotational movement. No extensive kinematics necessary.

### Maximum torque – minimum space required

Multiple helical gear actuators make it possible to produce and hold any intermediate angle of rotation. The outer dimensions can be flexibly designed to take limited construction space requirements into account.

Numerous series-related functions, such as angular adjustment, cushioning and the use of sensor technology, make it possible to meet a broad range of requirements in terms of rotational movements with high torque.

In order to give the rotary actuator its functional efficiency and reliability, the greatest manufacturing precision is required. In this way, the mechanical tolerance in the angle of rotation can be reduced to a minimum. These rotary actuators are used in all industrial applications: for example, in machine tools, elevated working platforms, automotive engineering, waste collection vehicles, side and rear loaders, tunneling machinery and construction machinery.



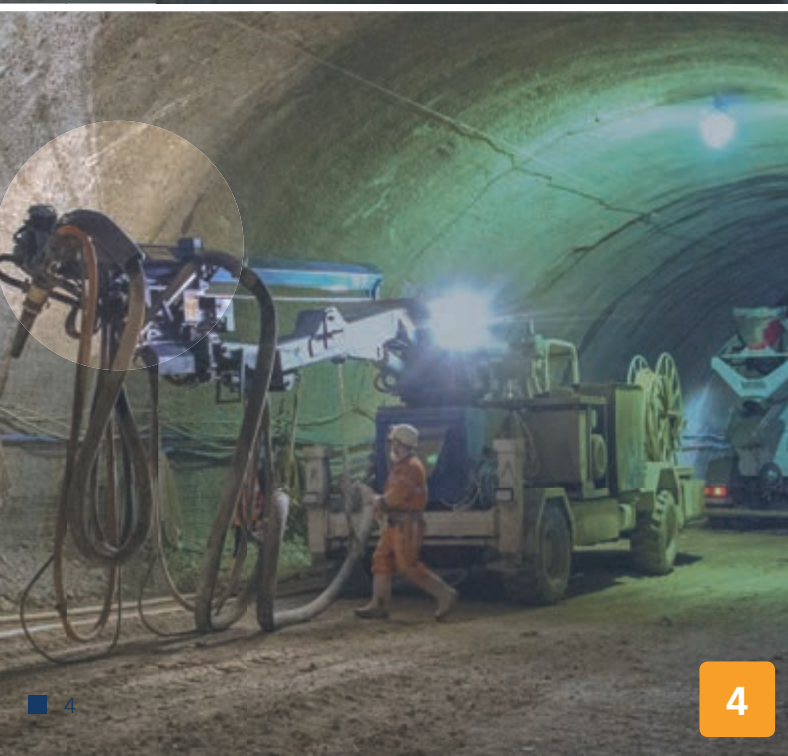
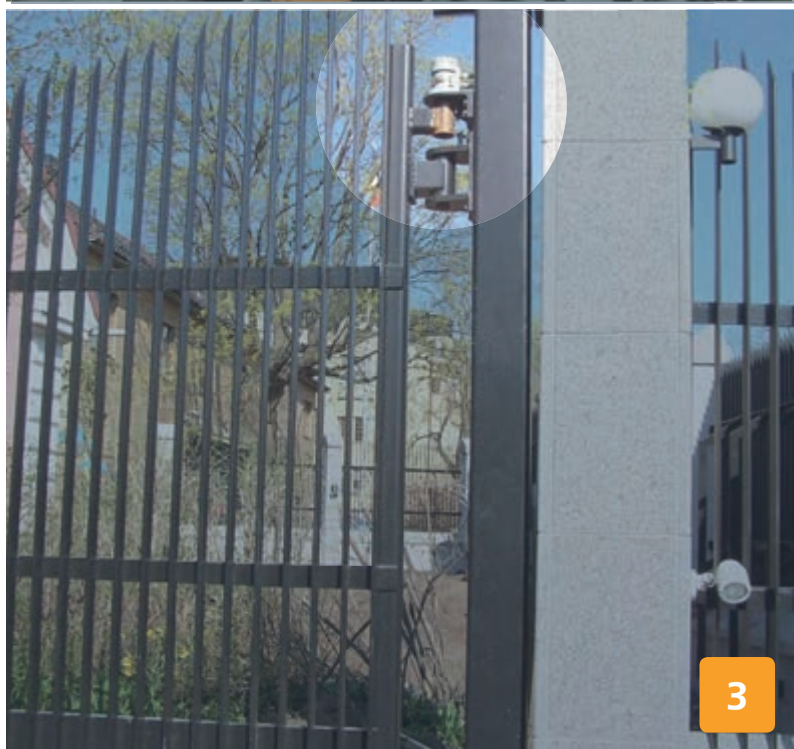

# Moving solutions

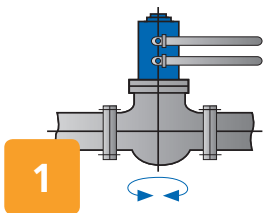

1

Ballcocks, armatures

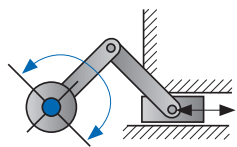

Crank drive

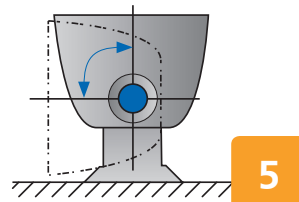

5

Container-tilting appliances



3

Doors, gates

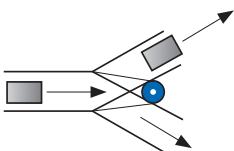

Transportation systems

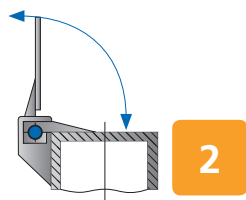

2

Cover activation

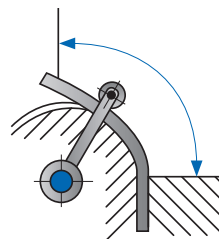

Pipe and sheet metal bending machines



Mixers

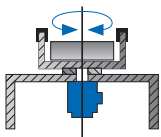

Tilting table

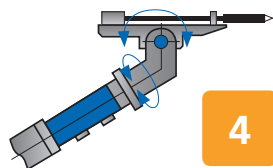

4

Drills

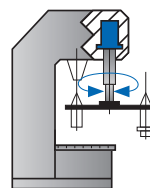

Tool changers

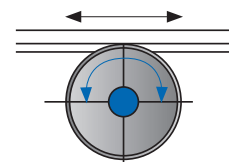

Linear transport

# Everything's included – series benefits

## Interleaved gears are surface-hardened

- › Nearly maintenance-free
- › Increases effectiveness

## Rotary pistons can be run to their end stop positions and loaded

- › No external end stops required

## Rotation angle or end stop query possible via camshaft

- › Precise positioning of rotation angle
- › Standard rotation angles 90°, 180°, 270° and 360°

## Greater working pressure

- › Up to 20% more power

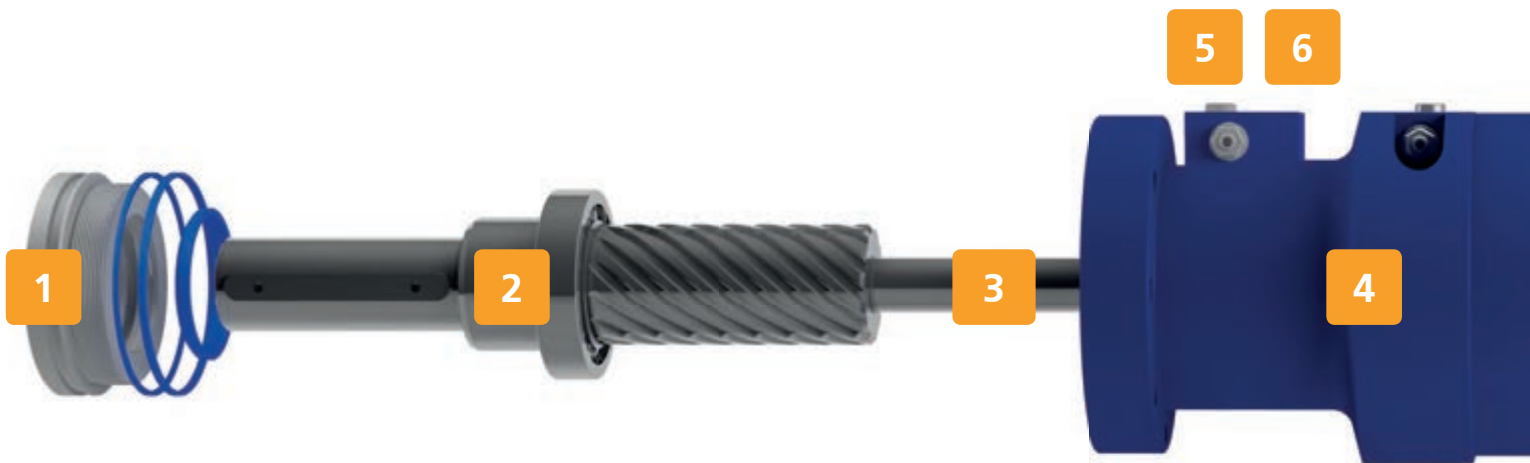

1 Sealing ring

2 Shaft with bearing

3 Camshaft

4 Housing

5 Cushioning

6 Bleed screws

7 Piston

8 Regulating screw

9 Annular gear

10 Base

11 Load holding valve  
(optional, not shown)



**Improved bearing efficiency  
with four-point bearing**

- › For handling strong radial and axial forces
- › For greater longevity

**Any intermediate rotation angle possible**

- › Customer-specific adaptation and integration into existing systems

**Improved end position cushioning**

- › Soft braking of mass moments of inertia
- › Results in greater longevity for the entire system

**Angular adjustments**

- › Precise travel to rear end position
- ›  $\pm 4^\circ$  angular adjustment

**State-of-the-art sealing technology**

- › Ensures less wear
- › Longer service life for the entire system
- › No internal leakage
- › Increases safety

**Infinite adjustment of the shaft position**

- › Shaft position can be adjusted at any time
- › Overall angle can be shifted

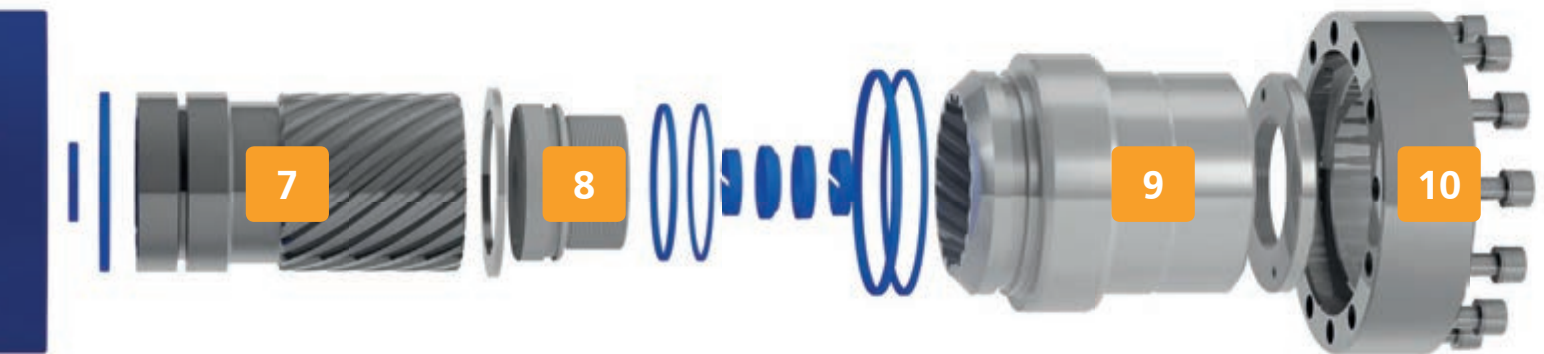

**Further options – based precisely on what you want**

- › Drive shaft with various spline shaft profiles
- › Drive shaft with second drive cog
- › Drive shaft and mounting flange can be designed to customer specifications
- › Angular adjustment across the entire rotation area
- › Limit switch facility
- › Rotation angle query
- › Any intermediate rotation angle can be supplied
- › Rotation range over 360°
- › Resistant to freshwater and seawater
- › Outboard bearing for high radial forces
- › Direction of rotation changeable
- › Compressed air version
- › Aluminum housing
- › According to ATEX product guidelines
- › Optional connections for servo interfaces
- › Optional version for use with organic lubricants or other pressurized fluids
- › Other special-purpose designs available

# Direction of rotation

When pressure is applied at P1, the drive shaft turns from its basic position towards the left (counterclockwise). If pressure is then applied at P2 once the drive shaft has reached its final position, the drive shaft then turns back to its starting position (clockwise). The direction of rotation can be changed in a special-purpose model if required.

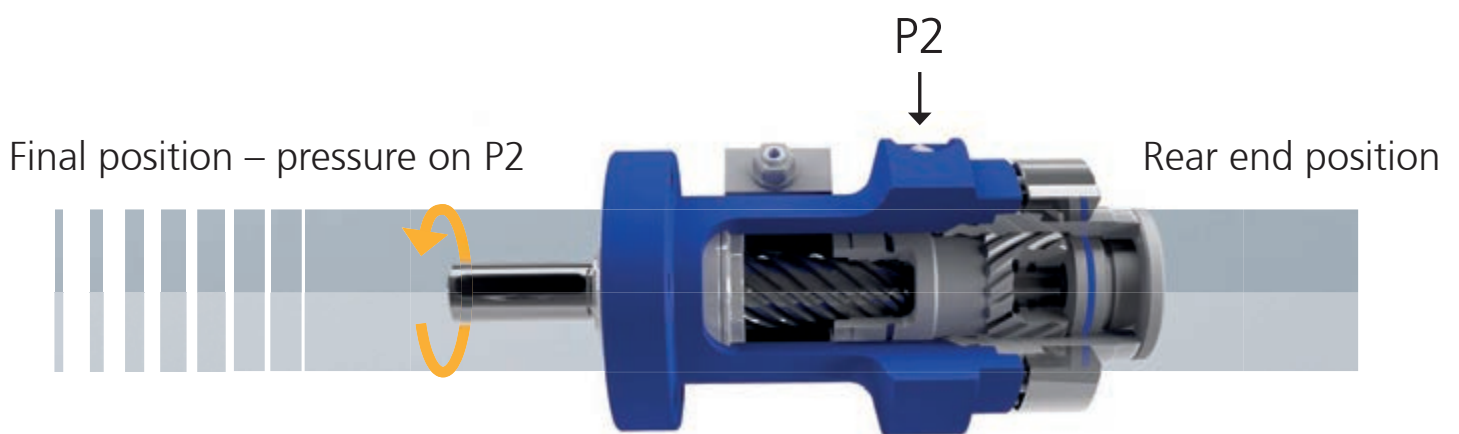
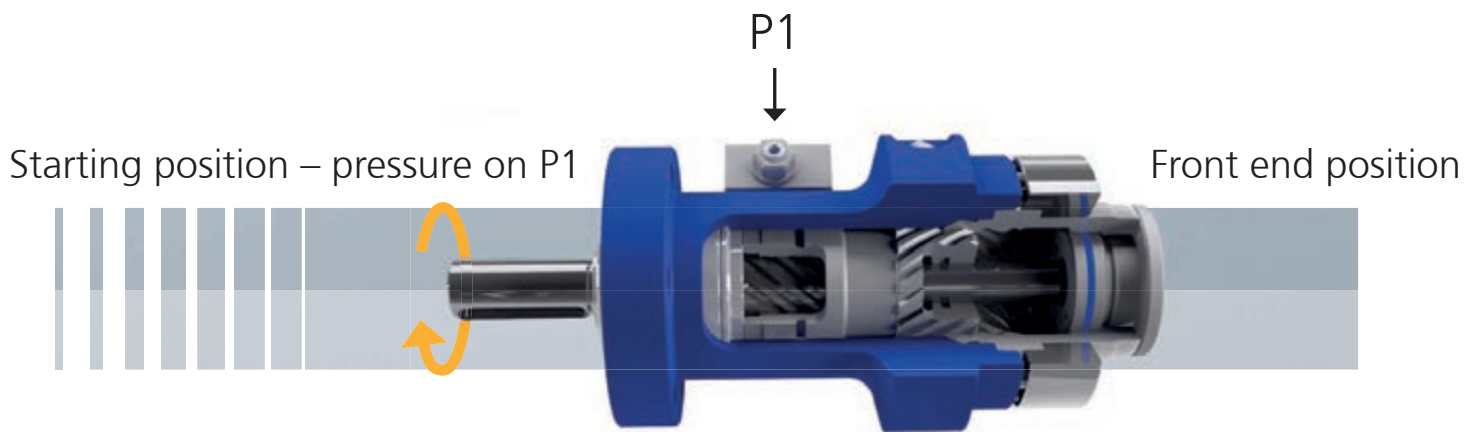



$$M_t \geq M_L + M_B$$

$M_t$  = Total moment

$M_L$  = Loading moment

$M_B$  = Accelerating/braking moment

Take a moment  
to find the  
right moment

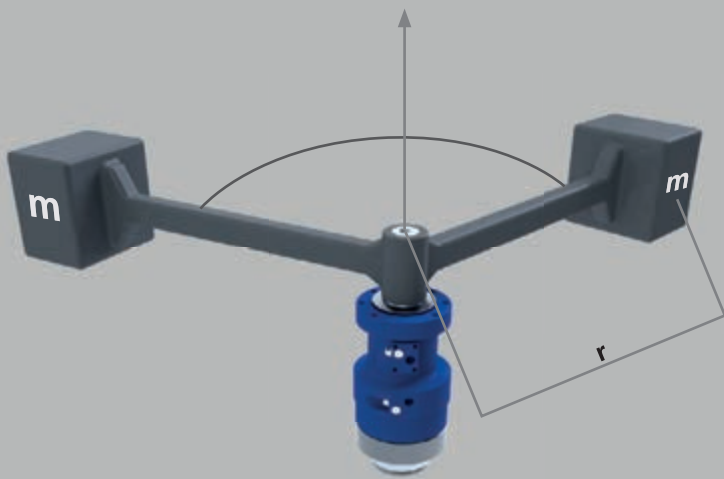

### Details regarding calculation

If a mass is subjected to a rotating movement with the angle  $\varphi$  in the time  $t_{ges}$ , from a standstill, external losses (frictional forces) need to be overcome, masses accelerated and subsequently delayed. The total sum of the resulting moments gives the required driving torque for the rotary actuator.

When calculating, make sure that the following requirement is met in every possible rotating position:

Depending on the position (horizontal, vertical) of the transfer of forces for the rotating process, the respective calculations must be performed for the loading moment  $M_t$  and the accelerating moment  $M_B$ . The need for fast cycle times can be met by enlarging the connection cross-sections.

! The total torque consists of the torque that results from the rotating of the load and the braking and/or accelerating of the load.

# Your ideas are unlimited



## Shaft versions (with center bore and according to various DIN standards)



Shaft with feather key



Keyed shaft

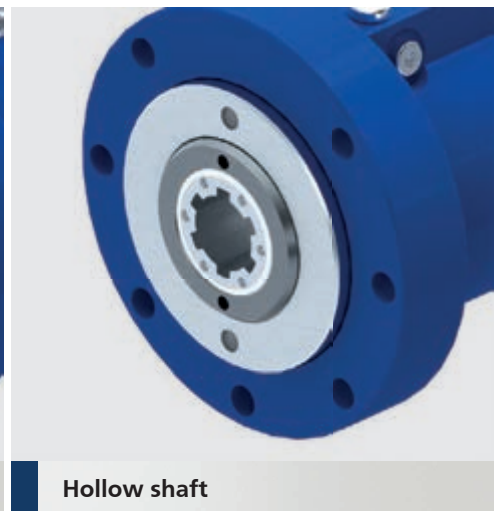

Hollow shaft

## Base

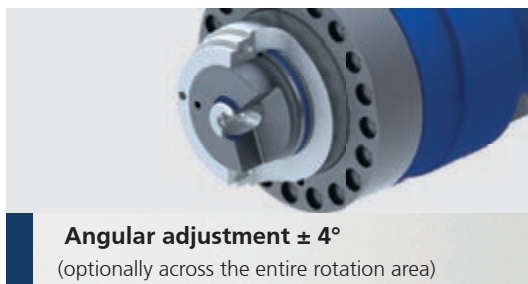

Angular adjustment  $\pm 4^\circ$   
(optionally across the entire rotation area)

Camshaft with internal thread

Angle sensor, potentiometer with coupling and attachment housing

## Options



Load holding valve

Pressure-proof proximity switch

Measurement connection

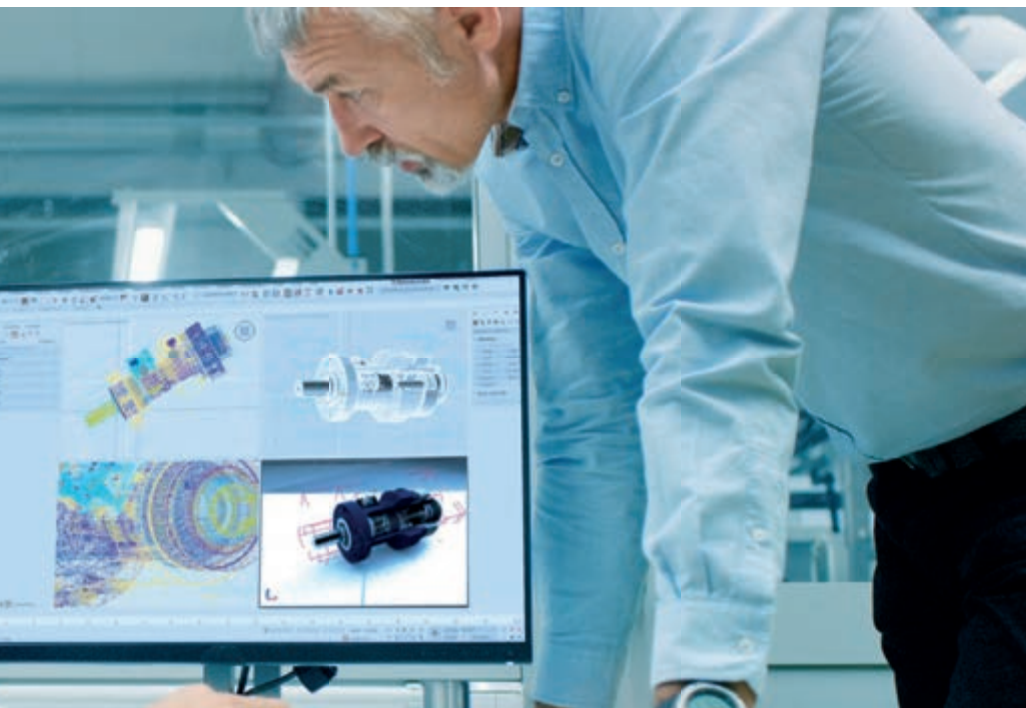

## Tips for applications engineering

Whatever your project, the rotary actuator can be optimally adjusted to handle it. A great many installation and connection options are available as standard, **but customer-specific, special-purpose solutions can also be implemented.**

Our technical customer support team will be happy to assist you with any questions you may have regarding special-purpose solutions using a comprehensive approach.

Phone: +49-6053-61630

E-mail: [info@hks-partner.com](mailto:info@hks-partner.com)



Hollow shaft with feather key slot

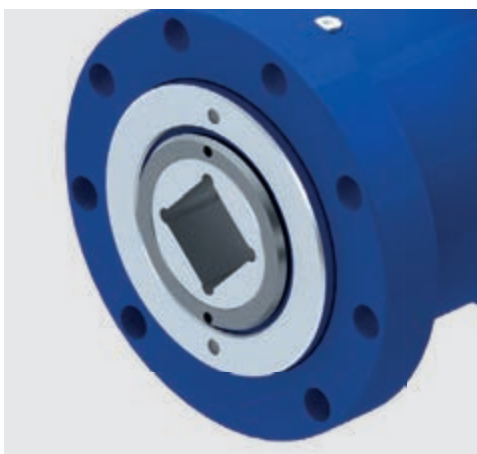

Hollow shaft with square

## Connection options

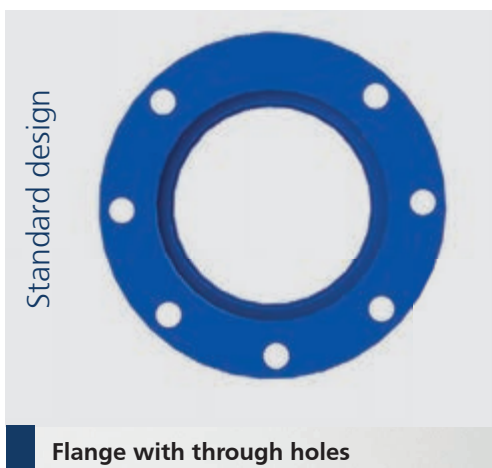

Flange with through holes

Flattened flange

Flange with fixing slots

Foot mounting

Flange with threaded bores

Standard design

# Options for individuality

The versions illustrated here are only a few of the numerous options with which HKS rotary actuators can be individually equipped.

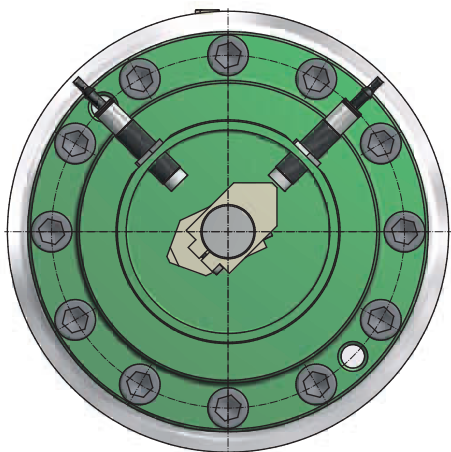

Proximity switch inductive (PI)

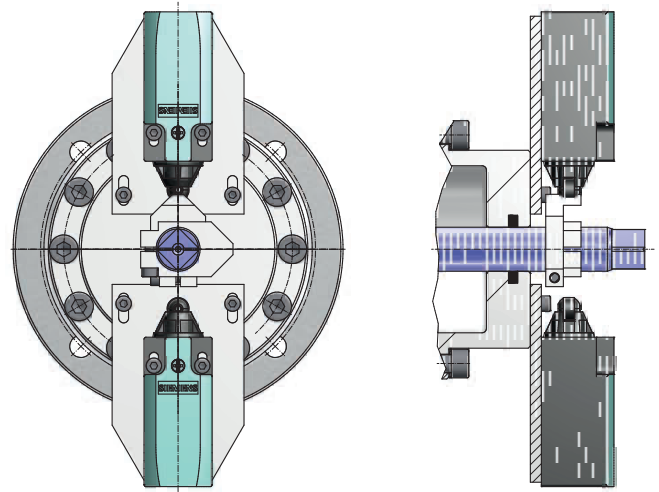

Limit switch mechanical (LM)

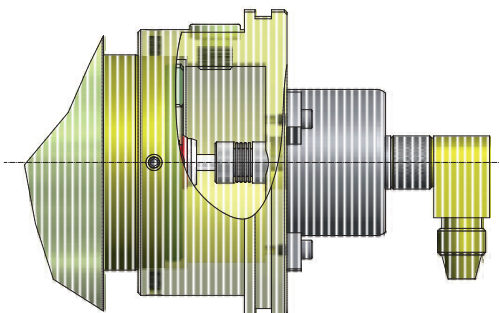

Encoder

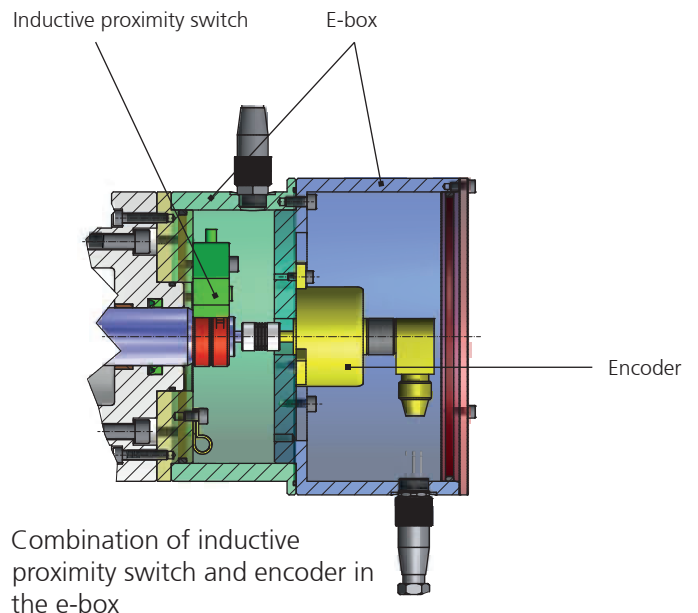





# Product code

Angle of rotation  
(90°, 180°, 270°, 360°) optional special angle of rotation

Size

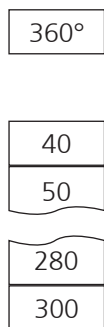

Example:



Cushioning  
(standard)



Angular adjustment  
(standard)



Camshaft with  
internal thread  
M10 (standard)



KW	Spline shaft//bore DIN 5480
HW	Hollow spline shaft// bore ISO 14
HWP	Hollow shaft feather key DIN 6885
NI	Proximity switch inductive
ND	Pressure-proof proximity switch
EM	Limit switch mechanical
Poti	Potentiometer/rotary encoder
E-box	Protective box for limit switch/rotary encoder
LHV	Load holding valve
ZU	Bearing for absorbing high FR

Using the product code, we design the rotary actuator together with you.

# Tips for operating a rotary actuator

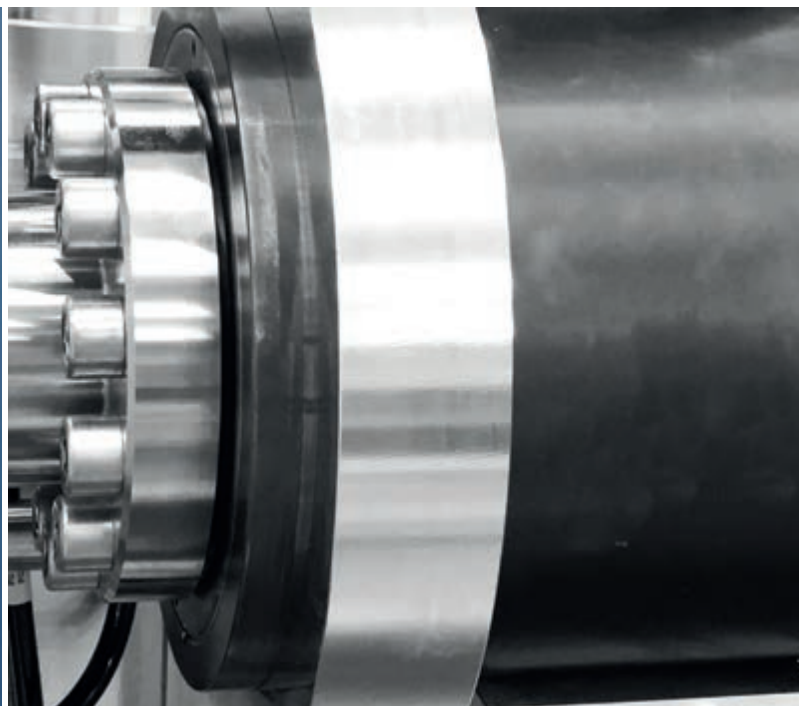

## Tips for continuous operation

The values specified are effective values and may not be exceeded. When operating in multiple shifts with fast cycle times and very high continuous loads, we recommend taking a safety factor of 70% of the maximum permitted torque into account.

## Cushioning

Cushioning and rotating times depend on the particular application and the mass moment of inertia. Their technical specifications may be neither exceeded nor fallen short of (based on the calculation formula on page 9).

## Adjusting the cushioning

After loosening a self-sealing lock nut, the throttle cross-section can be adjusted with an Allen key. Fully tighten the cone butterfly valve screw and then loosen it by one full turn. The cushioning can now be finely adjusted by tightening the screw to increase the cushioning effect and loosening it to reduce the cushioning effect. We will be happy to help you with the calculations.

## Oil interchange

If the oil lines are long, make sure that 50% of the absorption volume is exchanged during a complete rotation.

## Oil change

It is sometimes necessary to change the hydraulic oil, depending on the size of the system. The smaller the system, the more often the oil needs to be changed. If the hydraulic fluid becomes contaminated in any way, it must be changed without delay. Purity class recommendation: ISO 4406 : 1999 (22/18/14).

## Filtering

We recommend filtering the pressure fluid between the pump and the rotary actuator (pressure line). The hydraulic unit must supply the rotary actuator with a guaranteed oil purity in accordance with NAS 1638 – NAS class 7. Recommended filter: 16 VG.

## Application tip

Observe the rules set out by German technical monitoring system (TÜV), professional unions, or similar bodies. Equipment that operates using a rotary actuator must be designed such that in case of a human or technological error there is no risk to life and limb.

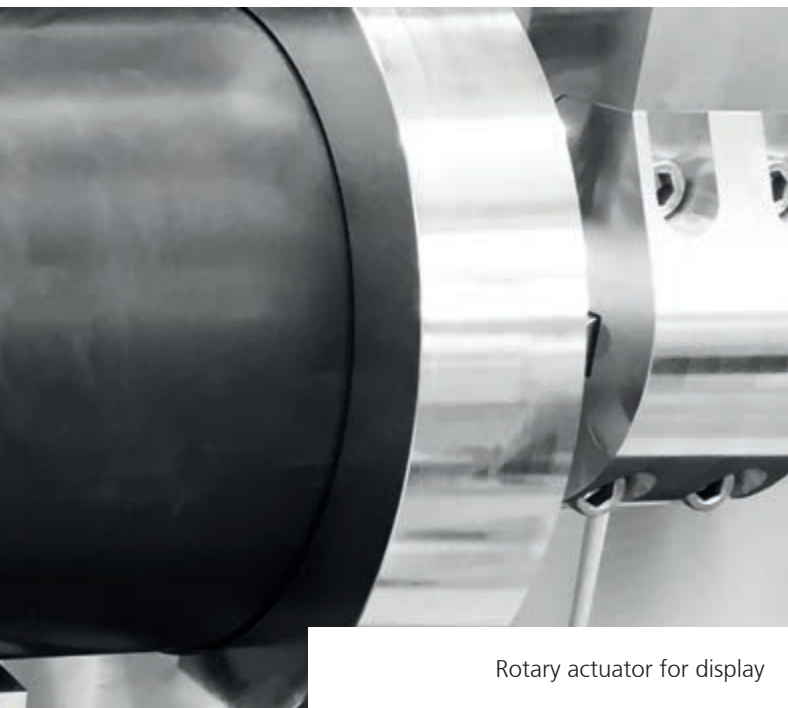

Rotary actuator for display

## Screw connection

Use the correct tightening torque to assemble the screw connections. Otherwise, the load capacity of the connection is reduced. In the worst case, the connection could even become loose.

Tightening torque in Nm for cylinder screws in accordance with DIN EN ISO 4762 (12.9)

## Pressure fluid

Only mineral oils in accordance with Group HLP DIN 51524/ part 2 and VDMA sheet 24318 may be used. Their viscosity must be between 15 mm<sup>2</sup>/s (cSt.) and 250 mm<sup>2</sup>/s (cSt.). These conditions are equivalent to the hydraulic oils HLP 16 to HLP 46, depending on temperature. If the required viscosity for the particular temperature range is not adhered to, it can result in increased wear. When using organic lubricants or other pressurized fluids, please contact us first.

## Noise emissions

The noise emission of the actuator is low. However, the actuator is only one part of the machine. Higher noise emissions can occur due to the interaction of the actuator with the machine and depending on the working location. The machine manufacturer is therefore required to measure the noise emission level, specify it in the operating manual and taking respective precautions, such as stipulating the use of ear protectors and installing cushioning elements between the machine and the foundation. Use hoses instead of pipes. Install noise barriers and/or sound-insulating enclosures

## Temperature range

The temperature range is -18 °C to +75 °C. If the temperature exceeds the lower or upper end of this range, please contact us.

## Maintenance

Please use original spare parts only when carrying out maintenance or repair work. HKS Dreh-Antriebe GmbH® does not accept liability for damage caused through the use of non-original spare parts.

## Hollow shaft

With the hollow shaft version it is required that the shaft design includes high strength material so that the entire torque is transferred. It is highly recommended that a calculation of the shaft torsional strength be carried out.

## Assembly

To avoid exceeding the maximum axial and radial forces, the coupling and actuator must be installed in alignment. The flange mating surface of the actuator must be at least  $\perp 0.05$  to the symmetry axis of the housing.

# Technical data

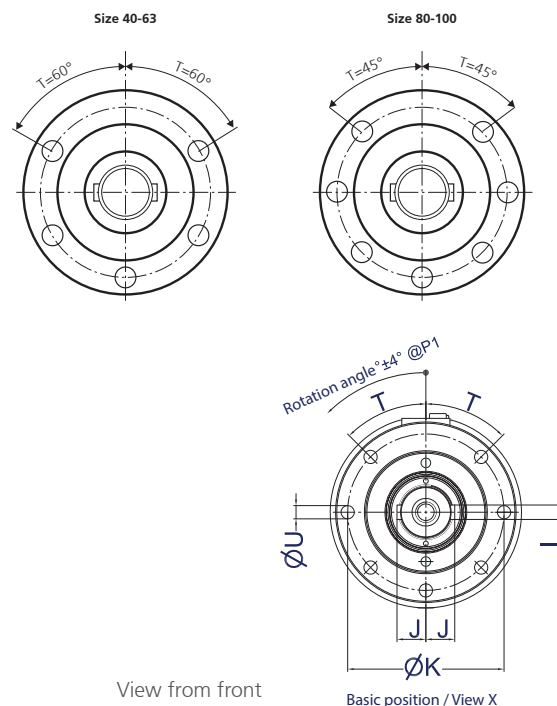

I-DA-H size		40	50	63	80	100	125
Max. torque [Nm] @ 250 bar		240	410	770	1,550	3,000	6,000
Max. nominal torque [Nm] @ 210 bar		200	340	650	1,300	2,500	5,107
Max. working pressure [bar]		250	250	250	250	250	250
Max. radial load [N]		1,567	2,976	4,364	7,875	11,250	17,552
Max. axial load [N]		8,000	10,000	14,000	19,050	24,900	34,100
Absorption volume [dm <sup>3</sup> ]	Angle 90°	0.023	0.041	0.071	0.13	0.28	0.53
	Angle 180°	0.047	0.08	0.14	0.27	0.55	1.06
	Angle 270°	0.070	0.12	0.21	0.40	0.63	1.59
	Angle 360°	0.093	0.16	0.28	0.53	1.10	2.22
Weight [kg]	Angle 90°	6.84	9.67	14.8	28.87	43.74	76.63
	Angle 180°	7.9	10.19	16.21	31.88	48.66	85.85
	Angle 270°	8.85	11.81	17.44	34.83	53.52	95.92
	Angle 360°	9.28	13.43	19.75	37.05	60.55	111.57
P 90° [mm]		158	179	184.5	239	282.5	330
P 180° [mm]		192	217.5	223.5	296.5	355	422
P 270° [mm]		222.9	256.5	261	355	430	517
P 360° [mm]		261.5	295.5	300	413.5	505	611
A [mm]		22 k6	28 k6	35 k6	42 k6	55 m6	70 m6
L [mm]		50	60	80	110	115	140
H [mm]		45	56	70	100	100	125
B [mm]		98	110	134	150	178	222
C [mm]		55 f7	68 f7	80 f7	100 f7	115 f7	150 f7
G [mm]		2.5	2	5	5	5	7
I [mm]		8	8	10	12	16	20
J [mm]		13	17	20.5	24	31.5	39.5
K [mm]		84	90	115	130	155	195
M [mm]		3	3	4	3	4	4
N [mm]		4	4	5	6	6	8
O [mm]		21	18	25	30	31	37
T [°]		60	60	60	45	45	40
U [mm]		9	9	11	11	14	18
Special version HW – B [mm]							
		H1 [mm]					
		J1 [mm]					
Special version HWP*		ØC <sup>H7</sup> [mm]					
		I1 [mm]					
						By request	

\*) NOTE: For the HWP/HW version, the maximum working pressure is 210 bar.



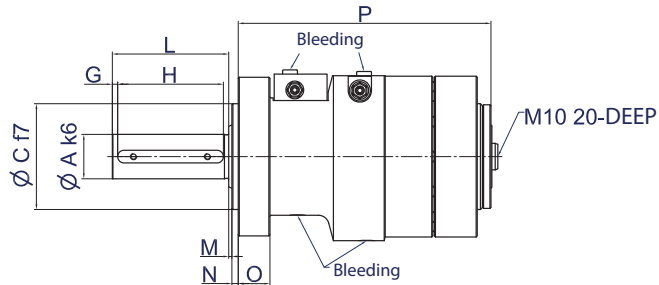
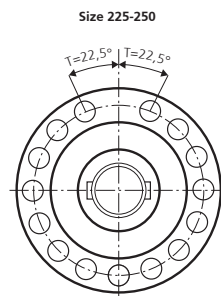
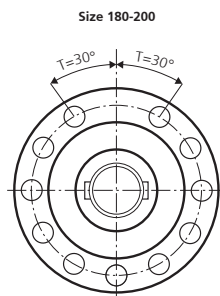
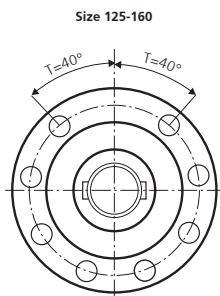

Side view

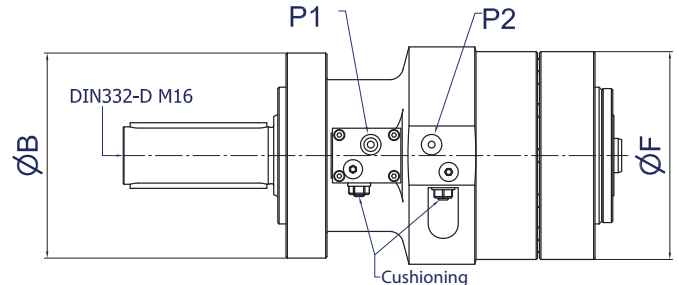

View from above

140	160	180	200	225	225S	250	280	300
8,400	13,450	19,000	26,600	38,500				
7,100	11,300	16,200	22,300	32,000				
250	250	250	250	250				
17,800	36,300	37,600	67,210	69,000				
34,800	46,200	47,400	62,000	63,100				
0.77	1.20	1.76	2.51	3.42				
1.53	2.40	3.51	5.03	6.82				
2.30	3.95	5.27	7.54	10.26				
3.07	4.79	7.03	10.06	13.67				
100.69	181.7	241.75	270.67	364.93				
119.69	204.01	267.01	309.64	423.29				
134.17	227.93	297.59	349.01	481.77				
149.36	250.25	327.8	389.22	540.62				
360	409.5	463	517	483				
468	473	535	671	571.5				
576	536.5	608	837.5	660	By request	By request	By request	By request
684.5	809.5	680	1,004	748.5				
80 m6	100 m6	105 m6	120 m6	140 m6				
150	210	210	210	260				
140	200	200	200	250				
250	295	308	325	385				
160 f7	200 f7	210 f7	235 f7	280 f7				
5	5	5	5	5				
22	28	28	32	36				
45	56	58.5	67	78				
220	255	275	290	345				
7	5	5	5	6				
10	12	12	12	15				
40	43	57	54	64				
40	40	30	30	22.5				
18	22	22	32	36				

By request

# Our locations

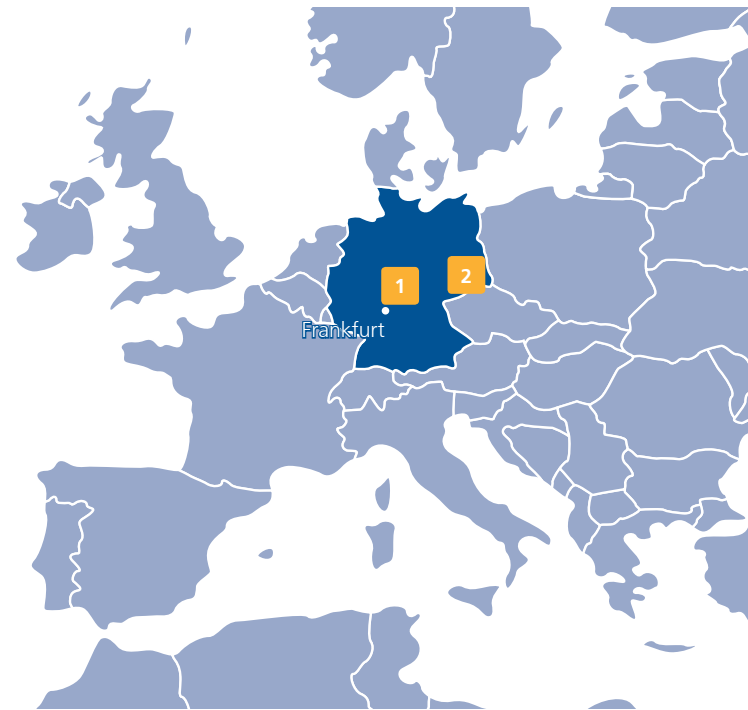

1

Locations in  
Wächtersbach-Aufenau



2

Location in  
Neukirch/Lausitz



## HKS Dreh-Antriebe GmbH®

HKS Dreh-Antriebe GmbH® is among the leading international manufacturers of rotary actuators, part-turn actuators, TiltRotators, rotary-lift combinations, and rack-and-pinion actuators. In addition to linear cylinders, HKS Dreh-Antriebe GmbH® also sells medical training devices. The family-run company, founded in 1970, currently employs nearly 250 people at three locations in Germany.

With sales partners in over 20 countries, HKS Dreh-Antriebe GmbH® has an international presence. More than 50% of the revenue comes from outside of the country.

As a family-run company, HKS Dreh-Antriebe GmbH® particularly values acting in ways that are responsible and sustainable over the long term. Sustainability, social commitment, and promoting the health of our employees are some of the core items in our company principles.









[www.hks-partner.com](http://www.hks-partner.com)



Scan me! 

-  [facebook.com/HKSDrehAntriebe](https://facebook.com/HKSDrehAntriebe)
-  [twitter.com/HKSDrehAntriebe](https://twitter.com/HKSDrehAntriebe)
-  [youtube.com/HKSDrehAntriebe](https://youtube.com/HKSDrehAntriebe)
-  [issuu.com/hks\\_](https://issuu.com/hks_)

© 2019 **HKS Dreh-Antriebe GmbH**® • Leipziger Straße 53-55 • 63607 Wächtersbach-Aufenau • Germany  
Phone: +49-6053-6163-0 • Fax: +49-6053-6163-639

DIN EN ISO 9001:2015 BSI-certified

Illustrations are approximations • No guarantee for the information provided • Subject to change  
Version dated: 04/2019

