

Navigation Lites
Steering/ Controls
Hardware/ Fasteners
Covers/ Windshield
Pumps/ Int. Lites
Electric/ Battery
Trolling Motor
Gauges
Electronics/ Radios
Fuel
Lube/ Motor Care
Aux. Brkts/ Tilt/Trim
Spark Plug/ Starters
Props
Seats/ Pedestals
Anchors/ Rod Holder
Winches/ Jacks
Lites/ Tie Downs
Tires/ Couplers
Boat Care
Misc./ Flooring
Ski's/Tubes
Floatation
Ladders
Water Front
Fenders/ Dock Lines



SEASTAR

Pro Series

Hydraulic Steering

The ultimate steering system for high speed single outboards. Ideal for high-performance boats with single non-power assisted O/B's up to 300 HP and capable of speeds over 70 MPH. 4.25 turns lock to lock. 2.0 cubic inches per revolution. ***Hoses NOT included***



HK-7400A Hydraulic Steering Kit

HK-7300A Hyd. Steering Kit w/Tilt Helm

Order Part No's. \$1310.45
1-60098, 2-60099, 1-60096, 1-60072

Order Part No's. \$1523.45
1-60098, 2-60099, 1-60097, 1-60072

*John/Evin 65-300 HP 1977-'90 or Honda 115-130 HP 1998 to date: requires different cylinder.



Hydraulic Steering

NFB Steering system for boats up to 60 MPH.

The most popular outboard hydraulic steering system offering smooth, super efficient No Feed Back Steering for todays hulls. It's the #1 system available today for runabouts, center console, cruisers, offshore fishing and many more. Fast, easy installation. 5 turns lock to lock. 1.7 cubic inches per revolution. ***Hoses NOT included***

HK-6400A Hydraulic Steering Kit

Mfg #HK-6400A
Order No. 60048_{TF} \$1209.99

SEASTAR



Teleflex Hydraulic Hose Kits

• Measure Hose Path or Existing Cable and ADD 24".

Mfg #	Size	Order No.	Retail
HO5114	14' Hose Set	60054_{TF}	\$110.99
HO5116	16' Hose Set	60056_{TF}	120.99
HO5118	18' Hose Set	60058_{TF}	131.99
HO5120	20' Hose Set	60059_{TF}	141.99

SEASTAR



Pro Helm

Compact stylish design with convenient front of dash fill. Requires 3" cut out on dash. Complete with elbow fittings.



Mfg #HH5770
Order No. 60096_{TF} \$599.99

SEASTAR



Pro Sport Tilt Helm

- 5 Wheel positions of tilt.
- 48° tilt range (12° down, 36° up)
- Remote fill point
- Complete with elbow fittings



Mfg #HH6190
Order No. 60097_{TF} \$812.99

Standard Hydraulic Cylinder (Single Engine)



Mfg #HC5345
Order No. 60072_{TF} \$640.49

Cylinder Spacer Kit

Honda 1998 to Date - 30 & 50 HP
OMC/Suzuki 1998 to Date - 65 & 70 HP
Mercury 1998 to Date - All 40 thru 60 HP
Yamaha 1998 to Date - 40 thru 60, & 90 HP
Suzuki 1998 to Date - 115-140 HP
Force 1985-1994 - 90/150 HP



Mfg #HO5090
Order No. 60086_{TF} \$27.99



BAYSTAR
HYDRAULIC STEERING KIT

SEASTAR SOLUTIONS

Hydraulic Steering

HK4200 Hydraulic Steering System for Outboard Powered Boats up to 150 HP
 *BayStar is not intended for high speed or performance type boats.
 BayStar kits include everything needed for an install. The cylinder utilizes the factory drag link for simplified installation.

3 Easy Steps to order your BayStar system:

- 1) Check helm dimensions: Standard 5" helm requires 3" hole in dash
- 2) Check cylinder dimensions: Is the splashwell wide enough?
 Requires 32" splashwell width. 4½ Steering wheel turns, stop to stop.
 Provides full engine stop movement.
- 3) Is there enough room in the splashwell for full engine tilt?
 Find the dimension of your splashwell. Check them against the minimum splashwell dimension for full engine tilt for your engine and cylinder.

Mfg #HK-4200A
Order No. 60046TF \$784.99



BayStar Cylinder Pivot Plates

An HC4645H is included in the BayStar steering kit. If your engine requires use of a cylinder other than HC4645H or HC4658H, you must purchase one of the pivot plates below.



Replacement for HC4645H

Mfg #HA4640
Order No. 60043TF \$64.99



Yamaha to make HC4648H

Mfg #HA4642
Order No. 60045TF \$89.99



Honda to make HC4647H

Mfg #HA4641
Order No. 60044TF \$89.99





Helm Oil Fill Kit

Mfg #HA5438
Order No. 60098TF \$19.99

Replacement vented fill plug

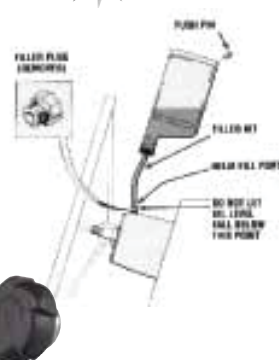
Mfg #HP6126
Order No. 60091TF \$7.49





Hydraulic Steering Oil

Mfg #Quart
Order No. 60099TF \$24.99

Mfg #Gallon
Order No. 60100TF \$84.99





Hyd. Seal Kit Snap Ring End Caps

Mfg #HS5152
Order No. 60085TF \$54.99

BayStar Cylinder Seal Kit

Mfg #HP4600
Order No. 60084TF \$94.99

SeaStar Cylinder Seal Kit

Mfg #HS5157 Kit
Order No. 60082TF \$125.99

Mfg #HS5167 Glands Only
Order No. 60081TF \$101.99

Bleed Nipple

Mfg #HF5548 2 per kit
Order No. 60078TF \$21.99

Horizontal Bleeder Tee

Mfg #HF5520 2 per kit
Order No. 60077TF \$64.99





Quad Ring Seal Kit for Helms

Mfg #HP6032
Order No. 60083TF \$13.69

Hardware Kit for All Cylinders

Mfg #HP6033
Order No. 60080TF \$45.99

20 Degree Wedge Kit

Mfg #HA5419
Order No. 60095TF \$75.99



Kit Includes:

- 2 washers-202300
- 1 spacer & boot-828016
- 1 adj. nut-828085
- 2 spacers-995876
- 1 spacer-996689

Navigation Lites

Steering/ Controls

Hardware/ Fasteners

Covers/ Windshield

Pumps/ Int. Lites

Electric/ Battery

Trolling Motor

Gauges

Electronics/ Radios

Fuel

Lube/ Motor Care

Aux. Brkts/ Tilt/Trim

Spark Plug/ Starters

Props

Seats/ Pedestals

Anchors/ Rod Holder

Winches/ Jacks

Lites/ Tie Downs

Tires/ Couplers

Boat Care

Misc./ Flooring

Ski's/Tubes

Floatation

Ladders

Water Front

Fenders/ Dock Lines

Navigation Lites
 Steering/ Controls
 Hardware/ Fasteners
 Covers/ Windshield
 Pumps/ Int. Lites
 Electric/ Battery
 Trolling Motor
 Gauges
 Electronics/ Radios
 Fuel
 Lube/ Motor Care
 Aux. Brkts/ Tilt/Trim
 Spark Plug/ Starters
 Props
 Seats/ Pedestals
 Anchors/ Rod Holder
 Winches/ Jacks
 Lites/ Tie Downs
 Tires/ Couplers
 Boat Care
 Misc./ Flooring
 Ski's/Tubes
 Floatation
 Ladders
 Water Front
 Fenders/ Dock Lines



GoTech Hydraulic Outboard Steering System
 Steering solution for pontoon boats and other boats with moderate torque. Designed to handle 4-stroke OB engines up to 115HP. Eliminates steering torque that can occur in some mechanical steering applications.

- Max. HP: 115
- Helm: UP 18 F front mount
- Turns Lock-to-Lock: 4.5
- 30' of nylon tubing
- 2 quarts 15SAE oil
- Warranty: 2 years

Mfg #	Order No.	Retail
GOTECH 1.0	63240 _{TF}	\$684.99



HyTech Hydraulic Outboard Steering System
 Features a unique split tilt tube rod for installation of the cylinder without removing the engine. Steering solution for boats with 150HP engines and under. Includes a composite UP20 helm for effortless steering. Applicable for almost all 2 and 4 stroke OB's. Hytech 1.0 is not suitable for Honda BF115 and BF130 engines and Mercury Optimax™ 75, 90, 115. For these engines HyTech 3.0 is available.

- Max. HP: 150
- Helm: UP 20 F front mount
- Turns Lock-to-Lock: 5
- 40' of nylon tubing
- 2 quarts 15SAE oil
- Warranty: 2 years

Mfg #	Order No.	Retail
HYTECH 1.0	63241 _{TF}	\$739.99



ProTech Hydraulic Outboard Steering System
 The ProTech is built for longevity and peak performance with a stainless steel helm shaft, heavy duty shaft seals, carbon steel piston, 304 electro polished and passivated stainless link assemblies. Adjustable boss style fittings to allow for easy hose routing.

- Max. HP: 300
- Helm: UP 28 F front mount
- Turns Lock-to-Lock: 4.3
- Hoses sold separately
- 2 quarts 15SAE oil
- Warranty: 2 years

Mfg #	Description	Order No.	Retail
PROTECH 1.0	See Application Chart	63242 _{TF}	\$999.99
PROTECH 2.0	See Application Chart	63244 _{TF}	999.99
PROTECH 3.0	See Application Chart	63246 _{TF}	999.99



Hydraulic Steering Hoses
 Consists of a pair of high pressure hoses supplied with preassembled fittings on both ends. Sold as pairs.

Mfg #	Order No.	Retail
KITOB-14'	63262 _{TF}	\$119.99
KITOB-16'	63264 _{TF}	119.99
KITOB-18'	63266 _{TF}	119.99
KITOB-20'	63268 _{TF}	119.99



ProTech Hydraulic Outboard Steering System Application Chart				
Engine	Power	Year	Packaged Kit	Single Cylinder
Evinrude	E75-E90 2 Stroke	2004-to date	Protech 2.0	UC128OBF-2
Evinrude	E115-E130-E135 2 Stroke V4	1995-to date	Protech 2.0	UC128OBF-2
Evinrude	E150-E175-E200 2 Stroke V6	1995-to date	Protech 2.0	UC128OBF-2
Evinrude	E200 HO-E225-E250 2 Stroke V6	1995-to date	Protech 2.0	UC128OBF-2
Evinrude	E250 HO-E300 2 Stroke V6		Protech 2.0	UC128OBF-2
Honda	BF75-90 4 Stroke	1995- to date	Protech 1.0	UC128OBF-1
Honda	BF115D	1998 - 2009	Protech 3.0	UC128OBF-3
Honda	BF115A	2009-to date	Protech 1.0	UC128OBF-1
Honda	BF130A	1998 - 2005	Protech 3.0	UC128OBF-3
Honda	BF135-150 4 Stroke	2005-to date	Protech 1.0	UC128OBF-1
Honda	BF90-BF150 V-TEC 4 Stroke	2008-to date	Protech 1.0	UC128OBF-1
Honda	BF175-200-225 4 Stroke	2001-to date	Protech 1.0	UC128OBF-1
Johnson	BJ90-115-140 4 Stroke	2001 - 2007	Protech 1.0	UC128OBF-1
Johnson	J90-115 V4 2 Stroke	1995 - 2007	Protech 2.0	UC128OBF-2
Johnson	J150-175 V6 2 Stroke	1995 - 2007	Protech 2.0	UC128OBF-2
Johnson	J200-225 V6 4 Stroke	2004 - 2007	Protech 2.0	UC128OBF-2
Mercury/Mariner	75-90-115-125 Optimax 2 Stroke	2004-to date	Protech 3.0	UC128OBF-3
Mercury/Mariner	135-150-175 Optimax 2 Stroke	1999-to date	Protech 1.0	UC128OBF-1
Mercury/Mariner	200-225-250 Optimax 2 Stroke	1999-to date	Protech 1.0	UC128OBF-1
Mercury/Mariner	Racing 300 Optimax 2 Stroke	1999 - 2011	Protech 1.0	UC128OBF-1
Mercury/Mariner	100-115-EFI 4 Stroke	2007-to date	Protech 1.0	UC128OBF-1
Mercury/Mariner	115-125-150 EFI 2 Stroke	1990 - 2007	Protech 1.0	UC128OBF-1
Mercury/Mariner	225-250 EFI 2 Stroke	2000 - 2007	Protech 1.0	UC128OBF-1
Mercury/Mariner	250 Saltwater EFI 4 Stroke	2007 - 2011	Protech 1.0	UC128OBF-1
Mercury/Mariner	135 Verado L4 4 Stroke	2004 - 2006	Protech 1.0	UC128OBF-1
Mercury/Mariner	150-175-200 Verado L4 4 Stroke	2004-to date	Protech 1.0	UC128OBF-1
Suzuki	DF70-80-90 4 Stroke	1998-to date	Protech 2.0	UC128OBF-2
Suzuki	DF100-115-140 4 Stroke	1998-to date	Protech 1.0	UC128OBF-1
Suzuki	DF150-175 4 Stroke	2006-to date	Protech 1.0	UC128OBF-1
Suzuki	DF200-DF225-DF250-DF300		Protech 2.0	UC128OBF-2
Tohatsu	115-120-140 2 Stroke	2004-to date	Protech 2.0	UC128OBF-2
Tohatsu	70-90-115 TLDI 4 Stroke	2004-to date	Protech 1.0	UC128OBF-1
Yamaha	75C-90 2 Stroke	1998-2008	Protech 2.0	UC128OBF-2
Yamaha	115C-130B 2 Stroke	1990-2008	Protech 2.0	UC128OBF-2
Yamaha	150F-200F-250G 2 Stroke	1996-2007	Protech 2.0	UC128OBF-2
Yamaha	150 HPDI VMAX 2 Stroke	2000-2008	Protech 2.0	UC128OBF-2
Yamaha	175-200-225-250-300 HPDI VMAX 2 St	2000-2008	Protech 2.0	UC128OBF-2
Yamaha	F70	2010-to date		UC128OBF-1P
Yamaha	F90-F100-F115-F150 EFI 4 Stroke	1999-2007	Protech 1.0	UC128OBF-1
Yamaha	F200-F225-F250- F300 4 Stroke	2002-to date	Protech 2.0	UC128OBF-2
Yamaha	F115-F150	2004-to date	Protech 1.0	UC128OBF-1

WARNING: These recommendations should be used as a general reference only. Final selection should be made with the assistance of a qualified installation technician. For any further information please contact our technical service.

Navigation
LitesSteering/
ControlsHardware/
FastenersCovers/
WindshieldPumps/
Int. LitesElectric/
BatteryTrolling
Motor

Gauges

Electronics/
Radios

Fuel

Lube/
Motor CareAux. Brkts/
Till/TrimSpark Plug/
Starters

Props

Seats/
PedestalsAnchors/
Rod HolderWinches/
JacksLites/
Tie DownsTires/
CouplersBoat
CareMisc./
Flooring

Ski's/Tubes

Floatation

Ladders

Water
FrontFenders/
Dock Lines

Navigation Lites
 Steering/ Controls
 Hardware/ Fasteners
 Covers/ Windshield
 Pumps/ Int. Lites
 Electric/ Battery
 Trolling Motor
 Gauges
 Electronics/ Radios
 Fuel
 Lube/ Motor Care
 Aux. Brkts/ Tilt/Trim
 Spark Plug/ Starters
 Props
 Seats/ Pedestals
 Anchors/ Rod Holder
 Winches/ Jacks
 Lites/ Tie Downs
 Tires/ Couplers
 Boat Care
 Misc./ Flooring
 Ski's/Tubes
 Floation
 Ladders
 Water Front
 Fenders/ Dock Lines



Power Purge, Jr.

The Power Purge, Jr. is the quickest way to bleed a SeaStar® or BayStar® system and assure a rock-solid steering feel every time! Dramatically reduces purging time. Increased quality of system purge for solid, responsive steering feel. Fast and efficient set-up; easy to operate. Screens contaminants from oil. Quick connect fittings. Uses a 12-volt boat battery.



Power Purge JR

**Special Order Only
 7-10 Day Delivery**

Mfg #HA5445-2
Order No. 60093_{TF} \$969.99



Outboard Stabilizer Clips

Snaps over outboard's hydraulic steering cylinder rods to help keep engine centered during trailering. Fits most cylinder rods 1997 and newer.

Mfg #55-2190
Order No. 57158 \$12.49



**Steer-Stop™
 Hydraulic Steering Lock**

Locks hydraulic steering when trailering. Clips onto Hydraulic Steering Rams. Keeps engine straight and prevents damage to transom savers.

Mfg #SS-1
Order No. 57323 \$17.19



Ball Joint

Exclusive design is spring loaded for zero end-play. 3/8-24 Thread.

Mfg #FBJ-9004
Order No. 57860 \$34.99

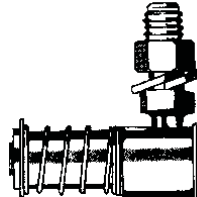

Quick Disconnect - Zinc

The ball stud is 3/8-24 thread by 1-7/8" long. Body is tapped for 3/8-24 threaded rod.

Mfg #	Description	Order No.	Retail
99-09028	Quick Disconnect	25270	\$9.99
99-05028	Ball Stud Only w/Hdwr	25274	9.99



Kicker tie bar kit drive bracket that will fit most common hydraulic steering units including Seastar Solutions.

Mfg #55-2750
Order No. 57136_N \$79.99



SS Auxilliary Motor Bracket Kit

Kit includes:
 Bracket, Washers, Bolt & Locktite.

Mfg #55-5705
Order No. 57135 \$34.99

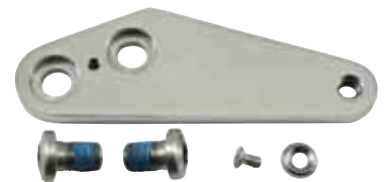

SS Drive Bracket

Kicker tie bar kit drive bracket that will fit most common hydraulic steering units including Uflex.

Mfg #55-2950
Order No. 57137_N \$99.99



Auxiliary Motor Steering Kit
Connects a trolling motor to your main engine. Easy to install.



Mfg #55-2400
Order No. 57133 \$39.99

Navigation Lites
Steering/ Controls
Hardware/ Fasteners

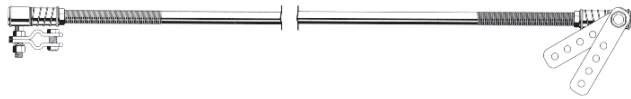

Motor Steering Kit
Connects a trolling motor to your main engine. Easy to install.



Mfg #11663-7
Order No. 09280 \$25.99

Covers/ Windshield
Pumps/ Int. Lites
Electric/ Battery
Trolling Motor



Kicker Cable Tie Bar
Allows a user to manually steer an auxiliary engine using their existing Seastar hydraulic steering system. Teleflex has incorporated a *TFXTREME* cable as the linkage between the two engines.

Features:

- Flexible cable for locations of kicker motor.
- Allows independent trim/tilt of both engines.
- Allows full steering stroke of both engines.

Mfg #	Size	Order No.	Retail
HO6116	16" Cable	60069 _{TF}	\$406.99
HO6122	22" Cable	60070 _{TF}	411.99

Retrofittable to Seastar Front Mount Cylinders. Drive/drag link from kicker motor Not Included.

Gauges
Electronics/ Radios
Fuel
Lube/ Motor Care
Aux. Brkts/ Tilt/Trim
Spark Plug/ Starters
Props
Seats/ Pedestals



Kicker or Trolling Motor single cylinder tiebar kit. May require trolling motor steering bracket supplied by engine manufacturer.



Mfg #HO6010
Order No. 60068_{TF} \$379.99



Universal trolling motor tie bar kit
This tie bar kit will fit on the front mount cylinder used in all OEM applications.



Mfg #HP6083
Order No. 60092_{TF} \$119.99

Anchors/ Rod Holder
Winches/ Jacks
Lites/ Tie Downs
Tires/ Couplers
Boat Care
Misc./ Flooring
Ski's/Tubes
Floatation

Universal Trolling Motor Tie Bar Kit
Kicker or Trolling Motor single cylinder tiebar kit. May require trolling motor steering bracket supplied by engine manufacturer.



Mfg #55-2700
Order No. 57134_N \$259.99

Ladders
Water Front
Fenders/ Dock Lines

Navigation Lites
 Steering/ Controls
 Hardware/ Fasteners
 Covers/ Windshield
 Pumps/ Int. Lites
 Electric/ Battery
 Trolling Motor
 Gauges
 Electronics/ Radios
 Fuel
 Lube/ Motor Care
 Aux. Brkts/ Tilt/Trim
 Spark Plug/ Starters
 Props
 Seats/ Pedestals
 Anchors/ Rod Holder
 Winches/ Jacks
 Lites/ Tie Downs
 Tires/ Couplers
 Boat Care
 Misc./ Flooring
 Ski's/Tubes
 Floatation
 Ladders
 Water Front
 Fenders/ Dock Lines



Zero Torque Tiller Steering System

Locks out the torque while the boat is not actively being steered. Consists of a hydraulic cylinder with a control valve that opens and closes following the operation made on the handle. The valve closes when the steering effort by the driver is stopped; as a consequence the cylinder locks the steering position.

Features:

- Boats up to 150HP
- Hydraulic torque lockout
- Consistent boat direction
- Includes Mercury Big Tiller



Mfg #ZTF Tiller
Order No. 63248_{TF} \$2849.99

Through Tilt Tube Electro Steer

24' cable allows you to steer your kicker motor from anywhere in the boat. Mounts to your kicker motor in minutes. Does not take up space on your transom. Two button hand-held remote with 24' cable and mounting hardware included.

T-4 requires 9" between motors

Mfg #55-0102 
Order No. 56904_N \$499.99

T-5 requires 4" between motors

Mfg #55-0502 
Order No. 56913_N \$599.99



Electro Steering

Frees your hands from the steering wheel and allows you to steer your boat with the push of a button. Steers separate from your main engine. 24' harness. Quick response; quick disconnect. Compact design with waterproof motor. Black anodized finish.



Mfg #55-0100A
Order No. 56906_N \$436.99



Wireless Remote Control (Optional)

200 ft. range. Operates on 12 volt battery. Works on all Panther Steering and Trim & Tilt units. Lanyard included.

Mfg #55-0105 
Order No. 57105_N \$229.99



**SS137
Safe-T QC Steering System**

ALL LENGTHS \$199.99



THF		THF	
Length	Order No.	Length	Order No.
10'	60101	15'	60106
11'	60102	16'	60107
12'	60103	17'	60108
13'	60104	18'	60109
14'	60105	19'	60110
		20'	60111



**SS132 Safe-T II
Single Cable
NFB System**

- Compact, rugged rotary helm
- Patented No Feedback Technology
- 3.0 turns lock-to-lock
- Fits Boats up to 24' - non power assisted outboard
- Replaces Teleflex Safe-T without dash modification

T			T		
Length	Order No.	Retail	Length	Order No.	Retail
10'	60461	\$243.99	15'	60466	\$256.99
11'	60462	245.99	16'	60467	258.99
12'	60463	248.99	17'	60468	261.99
13'	60464	250.99	18'	60469	263.99
14'	60465	253.99	19'	60470	266.99
			20'	60471	268.99







- Fits Boats up to 24' - non power assisted outboard
- Replaces Teleflex Safe-T without dash modification
- Compact, rugged rotary helm
- Patented No Feedback Technology
- 4.2 turns lock-to-lock
- Standard 3/4" tapered steering shaft
- Stainless steel telescopic ram
- Meets N.M.M.A. certification & A.B.Y.C. standards

SS147 NFB 4.2 Rotary Single Cable System		T		T	
Length	Order No.	Length	Order No.	Length	Order No.
10'	60339	15'	60344		
11'	60340	16'	60345		
12'	60341	17'	60346		
13'	60342	18'	60347		
14'	60343	19'	60348		
		20'	60349		

ALL LENGTHS \$264.99

SS148 NFB 4.2 Rotary Twin Cable System		
T		
Length	Order No.	Retail
12'	60365	\$630.99
13'	60366	635.99
14'	60367	641.99
15'	60368	647.99
16'	60369	653.99

**SS157 NFB Tilt 4.2 Rotary
Single Cable System**

T			T		
Length	Order No.	Retail	Length	Order No.	Retail
11'	60350	\$364.99	16'	60355	\$377.99
12'	60351	366.99	17'	60356	380.99
13'	60352	369.99	18'	60357	383.99
14'	60353	372.99	19'	60358	386.99
15'	60354	375.99	20'	60359	389.99

Navigation Lites

Steering/ Controls

Hardware/ Fasteners

Covers/ Windshield

Pumps/ Int. Lites

Electric/ Battery

Trolling Motor

Gauges

Electronics/ Radios

Fuel

Lube/ Motor Care

Aux. Brkts/ Tilt/Trim

Spark Plug/ Starters

Props

Seats/ Pedestals

Anchors/ Rod Holder

Winches/ Jacks

Lites/ Tie Downs

Tires/ Couplers

Boat Care

Misc./ Flooring

Ski's/Tubes

Floatation

Ladders

Water Front

Fenders/ Dock Lines

Navigation Lites
 Steering/ Controls
 Hardware/ Fasteners
 Covers/ Windshield
 Pumps/ Int. Lites
 Electric/ Battery
 Trolling Motor
 Gauges
 Electronics/ Radios
 Fuel
 Lube/ Motor Care
 Aux. Brkts/ Tilt/Trim
 Spark Plug/ Starters
 Props
 Seats/ Pedestals
 Anchors/ Rod Holder
 Winches/ Jacks
 Lites/ Tie Downs
 Tires/ Couplers
 Boat Care
 Misc./ Flooring
 Ski's/Tubes
 Floatation
 Ladders
 Water Front
 Fenders/ Dock Lines



RoTech Rotary Steering System

Featuring the T71FC helm with a planetary gear design. Reduces steering effort and delivers more balanced loads on the steering wheel, which improves durability and lost motion. Direct replacement for competing system, requiring no new holes for installation. Fits non-power assisted V-4 and smaller outboards up to 50mph.

- Turns Lock-to-Lock: 3.8 • replacement cable M66 series • Warranty: 2 years.



ALL LENGTHS \$189.99

Length	Order No.	Length	Order No.
10'	63250	16'	63256
11'	63251	17'	63257
12'	63252	18'	63258
13'	63253	19'	63259
14'	63254	20'	63260
15'	63255		

SS141 Back Mount Rack Single Cable System

- Fits Boats up to 24' -- non power assisted outboard
- Back Mount Design for Easy Installation!
- Replaces Teleflex Rack & Pinion without dash modification
- Pre-assembled Rack & Cable • 4 Turns Lock-to-Lock
- Standard 3/4" tapered steering shaft • Stainless steel telescopic ram
- Meets N.M.M.A. certification requirements & A.B.Y.C. standards



ALL LENGTHS \$204.99

Length	Order No.	Length	Order No.	Length	Order No.
8'	60472 _{THF}	13'	60477 _{THF}	17'	60481 _{THF}
9'	60473 _{THF}	14'	60478 _{THF}	18'	60482 _{THF}
10'	60474 _{THF}	15'	60479 _{THF}	19'	60483 _{THF}
11'	60475 _{THF}	16'	60480 _{THF}	20'	60484 _{THF}
12'	60476 _{THF}				



SS151 NFB Rack Single Cable System

- Fits Boats up to 24' -- non power assisted outboard
- Replaces standard Teleflex Rack without dash modification
- Precision Rack and Pinion Steering
- Patented No Feedback Technology
- 4 Turns Lock-to-Lock
- Standard 3/4" tapered steering shaft
- Stainless steel telescopic ram
- Meets N.M.M.A. certification requirements & A.B.Y.C. standards



Length	Order No.	Retail	Length	Order No.	Retail
	T			T	
10'	60485	\$290.99	15'	60490	\$292.99
11'	60486	293.99	16'	60491	295.99
12'	60487	296.99	17'	60492	312.99
13'	60488	287.99	18'	60493	315.99
14'	60489	289.99	19'	60494	318.99
			20'	60495	321.99



SS152 NFB Pro Rack Twin Cable System



- Fits Boats up to 24' -- non power assisted outboard
- Replaces standard Teleflex Rack without dash modification
- Precision Rack and Pinion Steering
- Patented No Feedback Technology
- 4 Turns Lock-to-Lock
- Standard 3/4" tapered steering shaft
- Stainless steel telescopic ram
- Meets N.M.M.A. certification requirements & A.B.Y.C. standards

Length	OrderNo.	Retail
12'	60496 _T	\$604.99
13'	60497 _T	609.99
14'	60498 _T	614.99
15'	60499 _T	649.99
16'	60500 _T	655.99

The EZY STIK II is a mechanical steering system designed so the operator may be positioned in the front of the boat for better visibility and convenience. This system is rated for engines NOT to exceed 70 HP. Any length not listed can be special ordered.

**"STIK II"
MODEL 840**

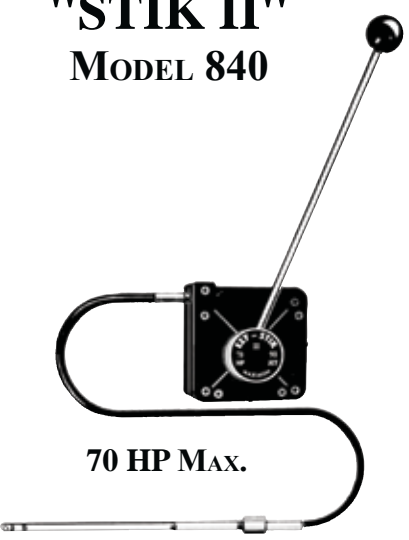

70 HP MAX.

*Special Order Only
7-10 Day Delivery*

KITS \$429.99		CABLE ONLY \$209.99	
Length	Order No.	Length	Order No.
8'	18745 ^{THF}	8'	18760 ^{THF}
9'	18746 ^{THF}	9'	18761 ^{THF}
10'	18747 ^{THF}	10'	18762 ^{THF}
11'	18749 ^{THF}	11'	18764 ^{THF}
12'	18751 ^{THF}	12'	18766 ^{THF}
13'	18753 ^{THF}	13'	18768 ^{THF}
14'	18755 ^{THF}	14'	18770 ^{THF}
15'	18756 ^{THF}	15'	18771 ^{THF}

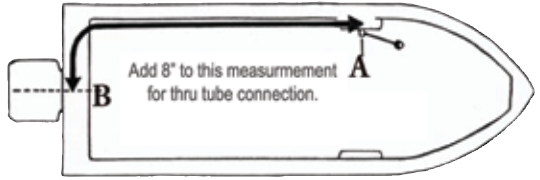

Mfg #	Description	Order No.	Retail
K-060	Replacement Knob	18775 ^{THF}	\$4.99
H-260	Replacement Lever	18776 ^{THF}	27.99
DC-840	Replacement Cover	18777 ^{THF}	6.49
HP-900	Hardware Package	18778 ^{THF}	5.99

- Navigation Lites
- Steering/ Controls
- Hardware/ Fasteners
- Covers/ Windshield
- Pumps/ Int. Lites
- Electric/ Battery
- Trolling Motor
- Gauges
- Electronics/ Radios
- Fuel
- Lube/ Motor Care

E.Z. STEER™

**Steering For Your Auxiliary Outboard Motor
Steer Your Auxiliary O/B From Your Main Units Steering Wheel**

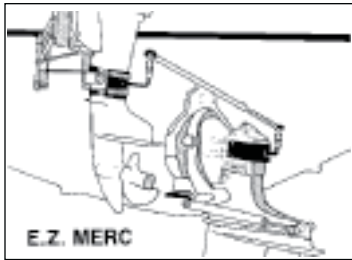
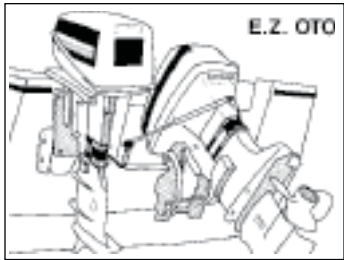

*Use with stern drive or outboard
whether transom mount or extended bracket.
Main motor or auxiliary outboard
may be raised together or independently.
No holes to drill for installations*

*Special Order Only
7-10 Day Delivery*

Mfg No.	Description	Rod Length	Order No.	Retail
EZ-22002	OMC Cobra Outdrive.....	23" to 26"	18704 ^N	\$299.99
EZ-22003	OMC Cobra Outdrive.....	29" to 33"	18708 ^N	299.99
EZ-30002	Mercruiser Alpha One.....	23" to 26"	18712 ^N	299.99
EZ-37002	Mercruiser Alpha One 2nd Generation...	23" to 26"	18722 ^N	299.99
EZ-42002	Volvo II ('89 & Newer).....	23" to 26"	18721 ^N	299.99
EZ-44002	Volvo SX/Cobra.....	23" to 26"	18723 ^N	299.99
EZ-60001	Outboard to Outboard.....	19" to 22"	18724 ^N	299.99
EZ-60002	Outboard to Outboard.....	23" to 26"	18728 ^N	299.99
EZ-60003	Outboard to Outboard.....	29" to 33"	18732 ^N	299.99



Mfg #	Description	Order No.	Retail
10001	19"-22" Short Rod Assy.	18735 ^T	\$169.99
10002	23"-26" Standard Rod Assy.	18736 ^T	169.99
10003	29"-33" Long Rod Assy.	18737 ^T	169.99
50010	Small O/B Bracket	18738 ^T	79.99
60010	Large O/B Bracket	18741 ^T	79.99
18020	SST Bands (2/pk)	18742 ^T	24.99
13200	Quick Disconnect	18743 ^T	16.99

- Aux. Brkts/ Tilt/Trim
- Spark Plug/ Starters
- Props
- Seats/ Pedestals
- Anchor/ Rod Holder
- Winches/ Jacks
- Lites/ Tie Downs
- Tires/ Couplers
- Boat Care
- Misc./ Flooring
- Ski's/Tubes
- Floatation
- Ladders
- Water Front
- Fenders/ Dock Lines

Jet Boat Steering

Teleflex JBS is recommended for use in all jet boat applications powered by Mercury Sport Jet or OMC Turbo Jet drives up to 175 HP. System components sold separately.



Ultra-compact helm with stylish 4.4" bezel. 135 or 270 degree turning arc lock-to-lock. Easy to install 90 degree dash mounting bezel. 90 or 180 degree cable entry into helm allows alternate cable routing. Standard 3/4" tapered shaft.

Steering helm with 135 degree turning arc
SH5087 \$194.99 Order No. 64160SO**

Steering helm with 270 degree turning arc
SH5088 \$189.99 Order No. 64161SO**

Bezel and Mounting hardware kit
SB39452 \$24.99 Order No. 64162SO**

Mercury Nozzle Conn. Kit
SA27591 \$82.99 Order No. 64164SO**

OMC Nozzle Conn. Kit
SA27590 \$72.49 Order No. 64163SO**

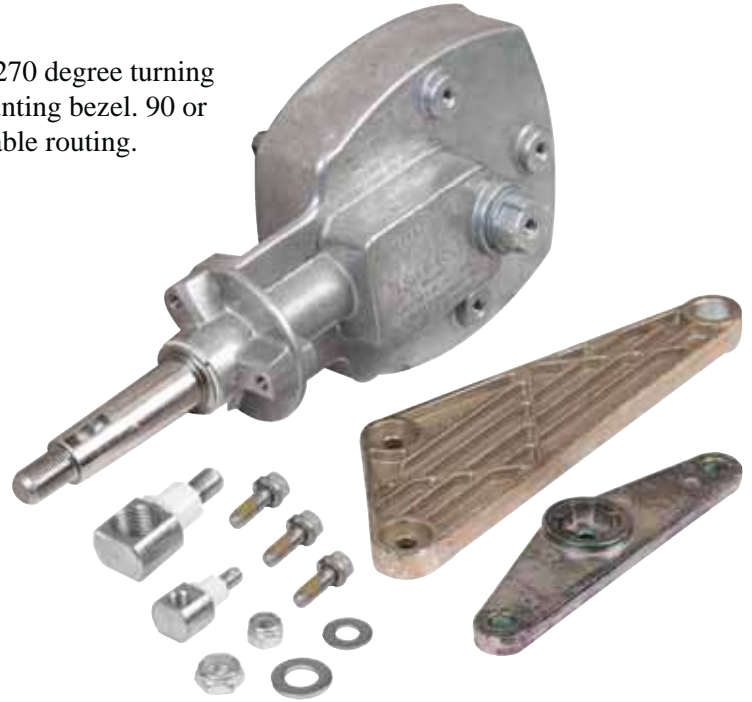

		SPECIAL ORDER		Length	Order No.	Retail
		SSC219 Cable with stainless steel output ends.		10'	64150	\$156.99
		5/16-28 Threaded ends		11'	64151	160.99
		JBS is designed specifically for today's jet-powered boats using the Mercury Sport Jet, OMC Turbo Jet, or similar powerplants.		12'	64152	164.99
				13'	64153	168.99
				14'	64154	172.99
				15'	64155	176.99



****SPECIAL ORDER****

43BC Jet Boat Steering Cable (CCX430)

3" Travel - 1/4-28 Threads



Length	Order No.	Retail	Length	Order No.	Retail	Length	Order No.	Retail
12'	64166	\$113.99	14'	64168	\$118.99	16'	64170	\$123.49
13'	64167	116.49	15'	64169	120.99			



Gate control Cables - CC213

3" Travel - 10/32" Threads

****SPECIAL ORDER****



Length	Order No.	Retail	Length	Order No.	Retail
8'	64138	\$115.99	12'	64142	\$122.99
9'	64139	116.99	13'	64143	124.99
10'	64140	118.99	14'	64144	125.49
11'	64141	122.49	15'	64145	126.99



SSC61 QCII
Rotary Steering Cable
 Replaces SSC72 and SSC62 Cables
 Replaces Morse 304415



(Includes SA27620 Adapter)

Now One Teleflex Cable Fits All These Rotary Helms

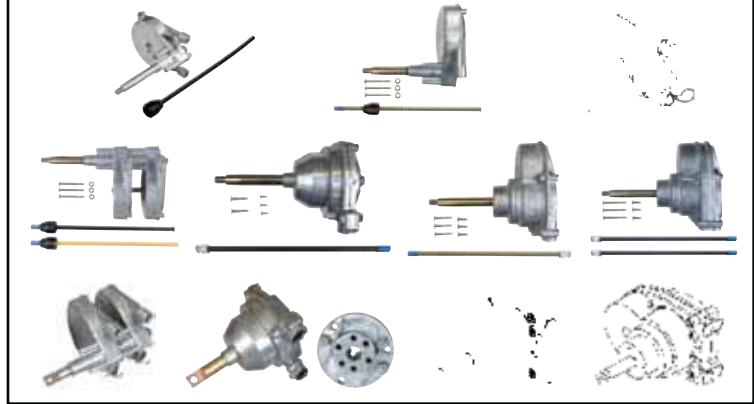

For Replacement Cable Measure Conduit and ADD 18"

Length	Order No.	Retail	Length	Order No.	Retail	Length	Order No.	Retail
6'	60436	\$186.99	13'	60443	\$159.99	20'	60450	\$159.99
7'	60437	186.99	14'	60444	159.99	22'	60451	244.99
8'	60438	159.99	15'	60445	159.99	24'	60452	259.99
9'	60439	159.99	16'	60446	159.99	26'	60453	275.99
10'	60440	159.99	17'	60447	159.99	28'	60454	290.99
11'	60441	159.99	18'	60448	159.99	30'	60455	306.99
12'	60442	159.99	19'	60449	159.99			



SSC52/SSC290 Steering Cable

For Replacement Cable Measure Conduit and ADD 18"

****SPECIAL ORDER****

Replaces: Morse Command 290 Rotary Cables, 304411



Length	Order No.	Retail	Length	Order No.	Retail	Length	Order No.	Retail
5'	43005	\$125.99	12'	60550	\$191.99	18'	60556	\$213.99
7'	60545	180.99	13'	60551	195.99	19'	60557	217.99
8'	60546	180.99	14'	60552	198.99	20'	60558	221.99
9'	60547	180.99	15'	60553	202.99	28'	43024	204.99
10'	60548	184.99	16'	60554	206.99	34'	43027	236.99
11'	60549	187.99	17'	60555	210.99	36'	43028	249.99



SSC130 Command 200 Cable

For Replacement Cable Measure Conduit and ADD 30"

****SPECIAL ORDER****



Length	Order No.	Retail	Length	Order No.	Retail	Length	Order No.	Retail
10'	60532	\$182.99	14'	60536	\$202.99	18'	60540	\$223.99
11'	60533	187.99	15'	60537	207.99	19'	60541	228.99
12'	60534	192.99	16'	60538	213.99	20'	60542	233.99
13'	60535	197.99	17'	60539	218.99			

- Navigation Lites
- Steering/ Controls
- Hardware/ Fasteners
- Covers/ Windshield
- Pumps/ Int. Lites
- Electric/ Battery
- Trolling Motor
- Gauges
- Electronics/ Radios
- Fuel
- Lube/ Motor Care
- Aux. Brkts/ Tilt/Trim
- Spark Plug/ Starters
- Props
- Seats/ Pedestals
- Anchors/ Rod Holder
- Winches/ Jacks
- Lites/ Tie Downs
- Tires/ Couplers
- Boat Care
- Misc./ Flooring
- Ski's/Tubes
- Floatation
- Ladders
- Water Front
- Fenders/ Dock Lines

Navigation Lites
 Steering/ Controls
 Hardware/ Fasteners
 Covers/ Windshield
 Pumps/ Int. Lites
 Electric/ Battery
 Trolling Motor
 Gauges
 Electronics/ Radios
 Fuel
 Lube/ Motor Care
 Aux. Brkts/ Tilt/Trim
 Spark Plug/ Starters
 Props
 Seats/ Pedestals
 Anchors/ Rod Holder
 Winches/ Jacks
 Lites/ Tie Downs
 Tires/ Couplers
 Boat Care
 Misc./ Flooring
 Ski's/Tubes
 Floatation
 Ladders
 Water Front
 Fenders/ Dock Lines

"THE RACK" Rack & Pinion Steering Cable SSC124

(Discontinued in 1997)



For Replacement Cable Measure
 Conduit and ADD 30" Square Rack

Length	Order No.	Retail	Length	Order No.	Retail	Length	Order No.	Retail
10'	60375	\$179.99	14'	60379	\$199.99	18'	60383	\$219.99
11'	60376	184.99	15'	60380	204.99	19'	60384	224.99
12'	60377	189.99	16'	60381	209.99	20'	60385	229.99
13'	60378	194.99	17'	60382	214.99			



SSC134 Single Rack Cable

(1998 and Newer)



For Replacement Cable Measure Conduit and ADD 30"
 Rectangular Rack

Length	Order No.	Retail	Length	Order No.	Retail	Length	Order No.	Retail
9'	60505	\$184.99	13'	60509	\$158.99	17'	60513	\$170.99
10'	60506	188.99	14'	60510	161.99	18'	60514	173.99
11'	60507	191.99	15'	60511	164.99	19'	60515	175.99
12'	60508	155.99	16'	60512	167.99	20'	60516	178.99



SSC135 Dual Rack Cable

For Replacement Cable Measure
 Conduit and ADD 30"



Length	Order No.	Retail	Length	Order No.	Retail	Length	Order No.	Retail
11'	60521	\$491.99	14'	60524	\$513.99	17'	60527	\$534.99
12'	60522	498.99	15'	60525	520.99	18'	60528	542.99
13'	60523	506.99	16'	60526	527.99			



Universal Quick Connect Rotary Steering Cable
 Stainless steel output fittings for longevity and smooth steering.



Length	Order No.	Length	Order No.
10'	63274	16'	63280
11'	63275	17'	63281
12'	63276	18'	63282
13'	63277	19'	63283
14'	63278	20'	63284
15'	63279		

ALL LENGTHS \$144.99

Rotary Helms (Uses SSC61 Cables)



**Safe-T "TS"
Threaded-Spigot**

SH5023 Single \$199.99
Order No. 60274



**Safe-T "QC"
Quick-Connect**

SH5094 Single \$99.99
Order No. 60280

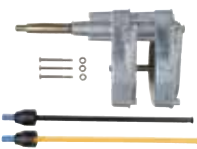

**Safe-T "QC"
Quick-Connect**

SH4952P Dual \$329.99
Order No. 60285



90-Degree Mount (Black) SB27484
Order No. 60579 \$25.99



20-Degree Mount (Black) SB27483
Order No. 60611 \$39.49

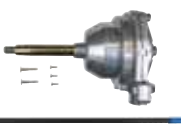

**Safe-T II "NFB"
No-Feedback**

SH5150 Single \$174.99
Order No. 60282

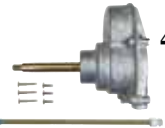

**4.2 Rotary "NFB"
No-Feedback**

SH4910 Single \$189.99
Order No. 60272



**4.2 Rotary "NFB"
No-Feedback**

SH4920 Dual \$334.99
Order No. 60273



90-Degree Mount (Black) SB27150
Order No. 60580 \$30.99



20-Degree Mount (Black) SB27483
Order No. 60611 \$39.49

Rack & Pinion Helms



Single SH5210
\$89.99
Order No. 60283

90° Black Mount
SB39526 \$25.99
Order No. 60672

20° Wedge Kit
SB27449 \$26.99
Order No. 60602

Friction Device \$44.99
Order No. 60606

"Back Mount"

Use Either SSC134 or SSC135 Dual Cables



NFB

Single SH5230
\$189.99
Order No. 60284

90° Black Mount
SB39544 \$26.99
Order No. 60668

20° Wedge Kit
SB27449 \$26.99
Order No. 60602

Tilt Rotary Helms (Use SSC61 Cables)



Safe-T "QC" Quick-Connect

SH91523 Single \$154.99
Order No. 60266



Safe-T "QC" Quick-Connect

SH91524 Dual \$376.99
Order No. 60267



Safe-T II "NFB" No-Feedback

SH91190 Single \$199.99
Order No. 60275

4.2 Rotary "NFB" No-Feedback



SH91526 Single \$299.99
Order No. 60270

4.2 Rotary "NFB" No-Feedback



SH91527 Dual \$394.99
Order No. 60271

Performance Tilt Unit



SH91800 \$184.99
Order No. 60264

For use with All tilt helms

Navigation Lites

Steering/ Controls

Hardware/ Fasteners

Covers/ Windshield

Pumps/ Int. Lites

Electric/ Battery

Trolling Motor

Gauges

Electronics/ Radios

Fuel

Lube/ Motor Care

Aux. Brkts/ Tilt/Trim

Spark Plug/ Starters

Props

Seats/ Pedestals

Anchors/ Rod Holder

Winches/ Jacks

Lites/ Tie Downs

Tires/ Couplers

Boat Care

Misc./ Flooring

Ski's/Tubes

Floatation

Ladders

Water Front

Fenders/ Dock Lines

Navigation Lites
 Steering/ Controls
 Hardware/ Fasteners
 Covers/ Windshield
 Pumps/ Int. Lites
 Electric/ Battery
 Trolling Motor
 Gauges
 Electronics/ Radios
 Fuel
 Lube/ Motor Care
 Aux. Brkts/ Tilt/Trim
 Spark Plug/ Starters
 Props
 Seats/ Pedestals
 Anchors/ Rod Holder
 Winches/ Jacks
 Lites/ Tie Downs
 Tires/ Couplers
 Boat Care
 Misc./ Flooring
 Ski's/Tubes
 Floatation
 Ladders
 Water Front
 Fenders/ Dock Lines



Tilt Rack & Pinion Helms



"NFB" Tilt Helm
 (4 turns lock-to-lock)
 Single SH91630
 \$219.99
Order No. 60279

Uses **SSC134** Single or **SSC135** Dual Cables



"Back Mount" Tilt Helm
 Single SH91610
 \$125.99
Order No. 60278

Uses **SSC134** Single or **SSC135** Dual Cables



Performance Tilt Unit
 SH91800
 \$184.99
Order No. 60264

For use with All tilt helms

Steering Wheel Hdwe.



For helms with tapered shafts
 SA27454
 (Included in bezel kits)

\$12.49

Order No. 60669



Champion



Stealth

New



Ace

Mfg No.	Description	Order No.	Retail
SW59291	"Champion" 13-1/2" Dia. 3/4" Taper - .43-3/8" dish	60673	\$69.99
SW59401B	"Stealth" 14" Dia. 3/4" Taper	60674	69.99
SW59691	"Ace" 13-1/2" Dia. 3/4" Taper - 3-3/8" dish	60675	45.99



DetMar CORPORATION

Viper Steering Wheel
 Stylish, distinctive, clean appearance. Soft textured leather grained rim with finger grips and stitching. 13.4" dia. 4" dish. Fits 3/4" tapered shaft.

Mfg #12-2502AC
Order No. 15595_T \$49.99



DetMar CORPORATION

Legend Steering Wheel
 Rugged, non-magnetic high impact plastic. 13-1/2" 3-7/8" dish. Completely U.V. resistant. Fits standard 3/4" tapered shaft.

Mfg #12-2800C
Order No. 15597_T \$36.99



DetMar CORPORATION

Contour Steering Wheel
 Equidistant modern three spoke design for boats with hydraulic steering. Black U.V. hard grip rim. 13-3/4" dia. 4-5/8" dish. Fits 3/4" tapered shaft.

Mfg #12-2301AC
Order No. 15598_T \$49.99



attwood

Soft Grip Steering Wheel
 with hard plastic center cap. 13" dia. wheel resists UV rays and is nonmagnetic. 3-3/8" deep dish. Fits 3/4" Tapered shaft. Ideal for bass boats, sport boats, & runabouts.

Mfg #8315-4
Order No. 07151_{THF} \$49.99

MECHANICAL STEERING CONNECTION COMPONENTS

Navigation
Lites

Steering/
Controls

Hardware/
Fasteners

Covers/
Windshield

Pumps/
Int. Lites

Electric/
Battery

Trolling
Motor

Gauges

Electronics/
Radios

Fuel

Lube/
Motor Care

Aux. Brkts/
Tilt/Trim

Spark Plug/
Starters

Props

Seats/
Pedestals

Anchors/
Rod Holder

Winches/
Jacks

Lites/
Tie Downs

Tires/
Couplers

Boat
Care

Misc./
Flooring

Ski's/Tubes

Floatation

Ladders

Water
Front

Fenders/
Dock Lines

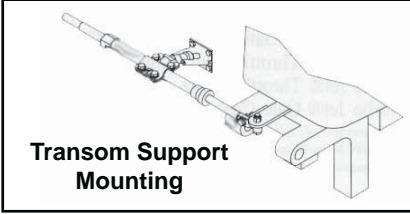

Transom Support Mounting

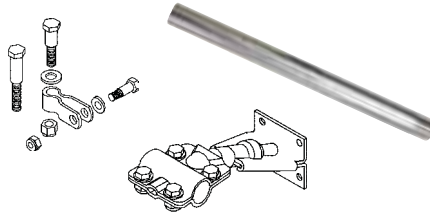

Transom Support Mounting Kit for Older Outboards without Tilt Tubes. SA27256

Order No. 60635 \$209.99

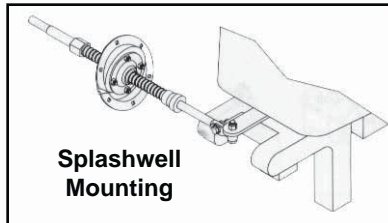

Splashwell Mounting

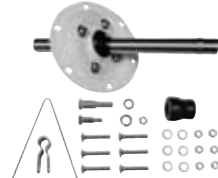

15 Degree Splashwell Mounting Kit SA27253

Order No. 60627 \$219.99

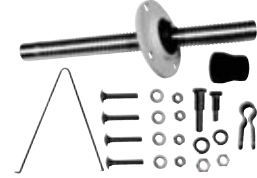

90 Degree Splashwell Mounting Kit SA27254

Order No. 60631 \$144.99

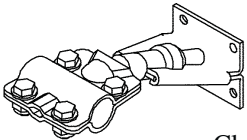

Clamp Block for Outboards SA27055

Order No. 60571 \$129.99



SST Clevis Kit

With Short Bolt SA27314

Order No. 60651 \$55.99

With Long Bolt SA27329

Order No. 60652 \$49.99



Rod End Kit - 1/2-20 Thread SA27276

Order No. 60643 \$78.99



Splashwell Threaded Support Tube W/Ball SA36316

Order No. 60677 \$51.99

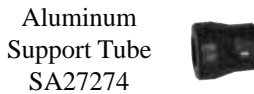

Aluminum Support Tube SA27274

Order No. 60639 \$30.99

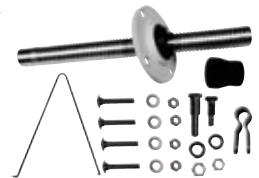

Boot Only With Felt Washer SA37868

Order No. 60690 \$14.99



SSC61 Cable Adapter for "TS" Threaded Helms SA27620

Order No. 60637 \$20.49



Spent Tube for NFB & Safe-T QC Helms SA38603

Order No. 60692 \$10.99



Spent Tube for Safe-T "TS" Helms SA35680

Order No. 60676 \$10.49

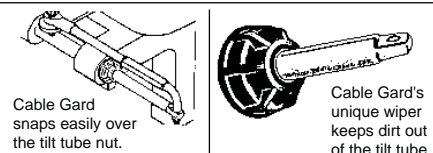

Cable Gard snaps easily over the tilt tube nut.

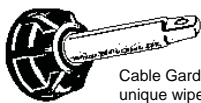

Cable Gard's unique wiper keeps dirt out of the tilt tube.



Cable Gard
One small step to solve one big steering problem. SA39329

\$15.99
Order No. 60693

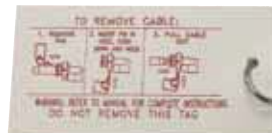

Hitch Pin & Tag for Quick-connect Helms SA27245P

Order No. 60621 \$6.49

Navigation Lites
 Steering/ Controls
 Hardware/ Fasteners
 Covers/ Windshield
 Pumps/ Int. Lites
 Electric/ Battery
 Trolling Motor
 Gauges
 Electronics/ Radios
 Fuel
 Lube/ Motor Care
 Aux. Brkts/ Tilt/Trim
 Spark Plug/ Starters
 Props
 Seats/ Pedestals
 Anchors/ Rod Holder
 Winches/ Jacks
 Lites/ Tie Downs
 Tires/ Couplers
 Boat Care
 Misc./ Flooring
 Ski's/Tubes
 Floatation
 Ladders
 Water Front
 Fenders/ Dock Lines



Standard 3/8" Diameter



Link Arms (Plated Steel)

Adjustable ball joints and nylon lock nuts to insure vibration proof locking.

SLA-940F 60-120 H.P. Johnson/Evinrude \$63.99 **Order No. 57830**
 SLA-950F 60-120 H.P. Mercury 71.99 **Order No. 57831**



3/8" N.F. thin S.S. nylon lock replacement nuts for all steering link arms. #151
 \$2.99 ea.
Order No. 57874



Clamp Mount Kit

These kits mount on the engine clamp brackets to provide thru tube steering. Freshwater kits include aluminum brackets and plated hardware.

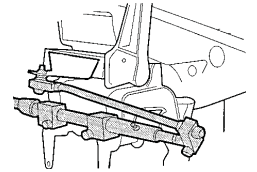

FWK-3477 50 H.P. Johnson/Evinrude \$173.99 **Order No. 57872**



Clamp Mount Kit

This freshwater kit fits under the engine clamps and is designed to prevent motor from jumping off transom. Also prevents transom damage by the clamps. Constructed of aluminum and plated steel.

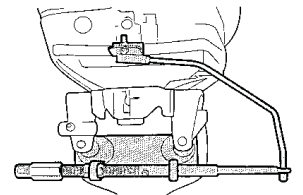

Fits:

Mariner 9.9-15 HP 1982 and newer
 Suzuki 9.9-15-16-25 HP 1982 and newer
 John/Evin 9.9-15-25-30-35-40 HP 1977 and newer
 Yamaha 9.9-15 HP 1984 and newer

FWK-3475 \$171.99

Order No. 57870



Front Mount Kit

For use when obstructions prevent thru tube installations. Fits over motor mounting bolts. Freshwater kit with aluminum brackets and plated steel hardware.

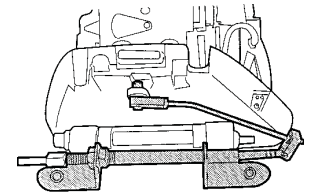

Fits: 50-140 HP Johnson/Evinrude FWK-3470 \$210.99 **Order No. 57867**

Fits:

Mercury 1980 and newer Black Max
 Mariner 1980 and newer
 Fits all Mercury-Mariner 2.4
 Suzuki 150-150SS-200 HP 1986 and newer
 Suzuki 115-140 HP 1987 and newer
 Johnson 115-140 4-stroke



Dual - Same Side

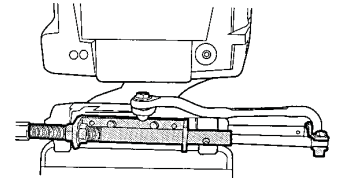

OSM-3798 \$159.99
Order No. 57827

Steering Link Arm NOT included in this kit

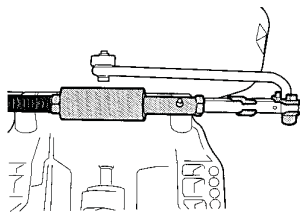

Dual - Same Side

Dual cable kit for cables installed down same side of boat (port or starboard). Steering tube and all parts are provided for simple hook up. Stainless steel and gold plated aluminum makes this kit corrosion resistant.

Yamaha 115-220 HP 1984 and newer

Steering Link Arm NOT included in these kits



OSM-3792 \$159.99
Order No. 57823



Tiller Line Clamp
For 3/16" to 1/4" cable
(1-pr/Skin Pack)



Mfg #	Order	Retail
8043-3	07121	\$17.99



Pulley Strap
Chrome plated - length 1-1/2"
(2/card)



Mfg #	Order No.	Retail
1225	58610	\$5.99

Navigation Lites

Steering/ Controls

Hardware/ Fasteners

Covers/ Windshield

Pumps/ Int. Lites

Electric/ Battery

Trolling Motor

Gauges

Electronics/ Radios

Fuel

Lube/ Motor Care

Aux. Brkts/ Till/Trim

Spark Plug/ Starters

Props

Seats/ Pedestals

Anchors/ Rod Holder

Winches/ Jacks

Lites/ Tie Downs

Tires/ Couplers

Boat Care

Misc./ Flooring

Ski's/Tubes

Floatation

Ladders

Water Front

Fenders/ Dock Lines



Oval Grommet



Mfg #	Description	Order No.	Retail
OG-1	1-1/2" x 3" Grommet	57426	\$4.99



Cable Boot Grommet
Protects cables, hoses and wires from chafing. Fits into the pass thru hole for steering, electrical and control cables and provides a smooth, chafe free fitting.

Mfg #	Description	Order No.	Retail
CBG-1	Grommet fits 3" cable boot	57401	\$5.49
CBG-2	Grommet fits 2" cable boot	57402	5.49



Tiller Cable

- Vinyl jacketed twisted steel
- Replaces steering cable
- 3/16" diameter

Mfg #	Description	Order No.	Retail
51820	3/16" x 250' Spool	62598	\$61.99



Swivel Pulley
(1/Skin Pack)

Mfg #2906-3	Order No. 06809	\$14.99
-------------	-----------------	---------



Swivel Tiller Pulley
(2/Skin Pack)

Mfg #0565DP	Order No. 45316T	\$22.49
-------------	------------------	---------



Rope Guide
Chrome plated zinc
7/8" pulley, 2"x 3/4" base
(1/Skin Pack)

Mfg # 1243DP	Order No. 45480T	\$10.99
--------------	------------------	---------

Navigation Lites
 Steering/ Controls
 Hardware/ Fasteners
 Covers/ Windshield
 Pumps/ Int. Lites
 Electric/ Battery
 Trolling Motor
 Gauges
 Electronics/ Radios
 Fuel
 Lube/ Motor Care
 Aux. Brkts/ Tilt/Trim
 Spark Plug/ Starters
 Props
 Seats/ Pedestals
 Anchors/ Rod Holder
 Winches/ Jacks
 Lites/ Tie Downs
 Tires/ Couplers
 Boat Care
 Misc./ Flooring
 Ski's/Tubes
 Floatation
 Ladders
 Water Front
 Fenders/ Dock Lines



Split Motorwell Boot
 4" Diameter hole



Includes tie for a secure fit. Black rubber construction with polypropylene attachment gasket ring.

Mfg #	Description	Order No.	Retail
12820-5	4" Motorwell boot	09295	\$9.99



Motorwell Boots



For sealed pass-thru of cables, wires and fuel lines. Molded of durable vinyl that resists flex fatigue, gas, oil and UV. Available in three sizes to fit all applications.

Mfg #	Description	Order No.	Retail
10-15-1	4" Boot - covers 4" hole	15621	\$7.99
10-15-11	3" Boot - covers 3" hole	15622	6.99
10-15-2	2" Boot - covers 2" hole	15623	6.99



UG



CB

Molded of tough, flexible vinyl. Providing an area to pass cables and wires thru without damage. Both designs hold wires and cables tight to prevent chafing.



Mfg #	Description	Order No.	Retail
UG-1	2-1/4" Utility grommet	57425	\$10.69
CB-1	3" Motorwell boot	57394	7.49
CB-4	4-1/2" Motorwell boot	57397	9.99



Steering Tube Cleaning Brush

Cleans corroded engine tilt tubes. Constructed of steel wire with 8" shaft. For use with electric drill.



Mfg #TB-10	
Order No. 57787	\$25.99



Steering Cable Boot

Protects against cable freeze-up, rust and corrosion. Extends steering cable life. Keeps steering cable lubricated. Fits most outboard and I/O steering cables.



Mfg #SB-34	
Order No. 57792	\$19.59

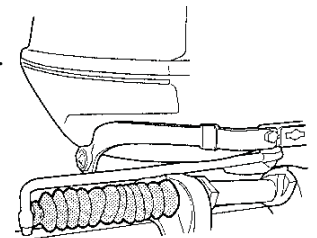



Cable Loom

- Black polyethylene corrugated loom is durable; split for easy installation.
- For protection of wires on cars, buses, trucks, and boats.
- Coiled and boxed.
- Temp rating of 93°C (200°F)

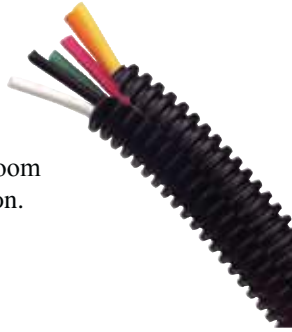

Mfg #	Size	Order No.	Retail
05749	1/4" x 100'	19205	\$28.49
05750	3/8" x 100'	19206	28.49
05751	1/2" x 100'	19207	33.99
05752	5/8" x 100'	19209	41.49



Split Wire Conduit

Mfg #	Size	Order No.	Retail
128-0146B	1/4" x 50'	63627	\$16.49
128-0386B	3/8" x 50'	63628	16.49
128-0126B	1/2" x 50'	63630	19.49
128-0586B	5/8" x 50'	63632	23.49
128-0346B	3/4" x 50'	63634	25.49
128-1006B	1" x 50'	63636	35.99
128-1146B	1-1/4" x 50'	63638	55.99
128-1126B	1-1/2" x 50'	63640	89.99



Flex Sleeving Spooled

Flex is a light weight jacketing for bundling and protecting wires, cables and hoses. Braided from high temperature yarns, Flex offers total protection for wire and cable assemblies. Flex expands to four times its original size.

Mfg #	Description	Order No.	Retail
FLX-50	1/2" Flex sleeving - 100' spool	57441	\$89.99
FLX-75	3/4" Flex sleeving - 100' spool	57442	120.99
FLX-150	1-1/2" Flex sleeving - 50' spool	57444	\$113.49
FLX-200	2" Flex sleeving - 50' spool	57445	\$139.99



Hot Foot Pro
Top Load Foot Throttle
New top loading for the throttle cable makes "Hot Foot Pro" easier to install and gives more foot and leg room. Standard features include a patented idle stop for the Ficht and Optimax engines, Stainless steel return spring, teflon bushings on all critical pivot points and toe clip for added security.



Mfg #	Description	Order No.	Retail
HF-1T	Fits OMC, Merc/Mariner	57359 _T	\$159.99



Hot Foot Slide Mount

- 5" of Slide

Mfg #	Order No.	Retail
HFM-1	57360 _T	\$69.99



Hot Foot

Marine foot throttle for outboard and inboard engine applications, a safety feature adaptable to all high performance boats...Uses standard control cables for easy hook-up. Mounts directly to floor of boat with four screws.



Mfg #	Description	Order No.	Retail
HF-1	Fits Most Applications	57358 _T	\$144.99
HFS-1	Replacement Spring	57354	18.99

Navigation Lites

Steering/Controls

Hardware/Fasteners

Covers/Windshield

Pumps/Int. Lites

Electric/Battery

Trolling Motor

Gauges

Electronics/Radios

Fuel

Lube/Motor Care

Aux. Brkts/Tilt/Trim

Spark Plug/Starters

Props

Seats/Pedestals

Anchors/Rod Holder

Winches/Jacks

Lites/Tie Downs

Tires/Couplers

Boat Care

Misc./Flooring

Ski's/Tubes

Floatation

Ladders

Water Front

Fenders/Dock Lines

Navigation Lites
 Steering/ Controls
 Hardware/ Fasteners
 Covers/ Windshield
 Pumps/ Int. Lites
 Electric/ Battery
 Trolling Motor
 Gauges
 Electronics/ Radios
 Fuel
 Lube/ Motor Care
 Aux. Brkts/ Tilt/Trim
 Spark Plug/ Starters
 Props
 Seats/ Pedestals
 Anchors/ Rod Holder
 Winches/ Jacks
 Lites/ Tie Downs
 Tires/ Couplers
 Boat Care
 Misc./ Flooring
 Ski's/Tubes
 Floatation
 Ladders
 Water Front
 Fenders/ Dock Lines

Teleflex CH1700 Side Mount Control

Created with a focus on ergonomics in every detail, these controls are rugged and substantial, yet feel natural in every function. For single station use with nearly any engine.



- Ergonomically designed handle with soft touch grip
- Precise, smooth, positive action
- Lanyard style cut-off switch for emergency engine shutdown
- Optional Tilt switch
- Trim in handle; push button style warm up; neutral interlock prevents starts in gear
- *Accepts virtually every type of OEM and 3300 type cable, including Merc Gen II*

Mfg #	Order No.	Retail
CH1751P	60667 _T	\$399.99

Morse SL-3 - Dual Function, Single Lever Control

A snap to install and a perfect match with any engine; outboards, inboards or sterndrives.



- Firm yet effortless shift and throttle motion
- Port or starboard installation with various cable entry angles
- Easily adapted to push or pull mode without tools
- Accepts virtually any type of cable
- Push button for neutral engine warm-up
- *With emergency cut-off feature available on the side mount model*



Mfg #	Description	Order No.	Retail
309473	Side Mount Control w/o Trim Switch	43176 _T	\$299.99
309474	Side Mount Control w/Trim Switch	43177 _T	349.99
309476	Top Mount Control w/o Trim Switch	43169 _T	\$344.99
309477	Top Mount Control w/Trim Switch	43170 _T	389.99
315590	Replacement Trim Switch Only	43138 _T	\$19.99
051801-033	Replacement Neutral Safety Switch	43139	20.99

Single Lever Control

This economical single lever/dual action control with positive detents for shifts uses universal cables. It's an excellent replacement for both outboard and sterndrive controls using universal type cables.



Mfg #CH-2700P	Control w/Trim Switch
Order No. 60665_T	Retail \$295.99
Mfg #CH-2600P	Control w/o Trim Switch
Order No. 60666_T	Retail \$294.99
Mfg #CA-27090P	Optional Neutral Safety Switch
Order No. 60658_T	Retail \$41.49



Shift & Throttle Control Mounting Board

• Made from King StarBoard® marine grade plastic.

Mfg #	Size	Order No.	Retail
950	12"x12"x1/2"	48004	\$28.99
960	12"x24"x1/2"	48006	56.99

CCX633/CC633/33C Supreme
Ideal For Twin Stations & Difficult Routings
For Outboards, Sterndrives & Inboards

- 10-32 UNF threaded ends • 4" Minimum Bend Radius
- Nominal 3" travel • Splined Core for unparalleled smoothness and response



Length	Order No.	Retail	Length	Order No.	Retail	Length	Order No.	Retail
6'	64224	\$42.49	12'	64175	\$50.99	18'	64182	\$59.49
7'	64225	43.49	13'	64176	52.49	19'	64183	60.99
8'	64171	44.99	14'	64177	53.99	20'	64184	62.49
9'	64172	46.49	15'	64178	55.49	22'	64185	65.49
10'	64173	47.99	16'	64179	56.49	24'	64181	68.49
11'	64174	49.49	17'	64180	58.49			

Universal - CC230/172/3300
Industry standard shift and throttle cable,
3" travel and 10-32" threads.



Length	Order No.	Retail	Length	Order No.	Retail	Length	Order No.	Retail
10'	64094	\$36.99	16'	64100	\$41.49	24'	64106	\$49.99
11'	64095	37.49	17'	64101	42.49	36'	64112	88.99
12'	64096	37.99	18'	64102	43.49	38'	64113	95.99
13'	64097	38.99	19'	64103	44.49	40'	64114	100.99
14'	64098	39.49	20'	64104	45.49			
15'	64099	40.49	22'	64105	48.49			

Type 33C - Red Jacket
Industry standard shift and throttle cable, 3" travel and 10-32" threads.



Length	Order No.	Retail	Length	Order No.	Retail
19'	42769	\$44.99	36'	42778	\$86.99
32'	42776	71.99	40'	42780	98.99

33C Supreme
The answer to long and complex cable routings...
4" minimum bend radius capability versus 8" min.
bend radius for standard 33C Red Jacket...



High efficiency shift & throttle cable for
multiple station use, 3" travel, 10-32 thread.

Length	Order No.	Retail	Length	Order No.	Retail	Length	Order No.	Retail
19'	42859	\$54.99	30'	42870	\$ 69.99	38'	42878	\$99.99
			32'	42872	86.99	40'	42880	104.99

Gen II Merc Cable - CC189
Industry standard shift and throttle cable, 3" travel.



Length	Order No.	Retail	Length	Order No.	Retail	Length	Order No.	Retail
12'	64214	\$42.49	15'	64218	\$44.49	18'	64221	\$46.49
13'	64215	42.99	16'	64219	44.99	19'	64222	47.49
14'	64216	43.99	17'	64220	45.99	20'	64223	47.99

Navigation Lites
Steering/ Controls
Hardware/ Fasteners
Covers/ Windshield
Pumps/ Int. Lites
Electric/ Battery
Trolling Motor
Gauges
Electronics/ Radios
Fuel
Lube/ Motor Care
Aux. Brkts/ Tilt/Trim
Spark Plug/ Starters
Props
Seats/ Pedestals
Anchors/ Rod Holder
Winches/ Jacks
Lites/ Tie Downs
Tires/ Couplers
Boat Care
Misc./ Flooring
Ski's/Tubes
Floatation
Ladders
Water Front
Fenders/ Dock Lines

Navigation
Lites

Mercury 4000 series controls - Gen II CCX189/CC679
 Performance Advantage - Engineered to significantly reduce or eliminate cable "Wig-Wag" - Improve the feel of the Mercury 4000 series control



Steering/
Controls

Hardware/
Fasteners

Covers/
Windshield

Pumps/
Int. Lites

Electric/
Battery

Length	Order No.	Retail	Length	Order No.	Retail	Length	Order No.	Retail
12'	64195	\$53.99	16'	64199	\$59.99	20'	64203	\$65.99
13'	64196	55.49	17'	64200	61.49	21'	64261	67.99
14'	64197	56.99	18'	64201	62.99	22'	64262	69.49
15'	64198	58.49	19'	64202	64.49			

Trolling
Motor

Gauges

Electronics/
Radios

Mercury/Mariner - CC179/600
 Replacement shift and throttle cable for Mariner, Mercury and Mercruiser.



Fuel

Lube/
Motor Care

Aux. Brkts/
Tilt/Trim

Spark Plug/
Starters

Props

Length	Order No.	Retail	Length	Order No.	Retail	Length	Order No.	Retail
10'	64064	\$32.99	16'	64070	\$40.99	24'	64076	\$60.49
11'	64065	33.99	17'	64071	41.99	30'	64079	63.99
12'	64066	35.49	18'	64072	42.99	32'	64080	70.99
13'	64067	36.99	19'	64073	44.49	34'	64081	77.99
14'	64068	38.49	20'	64074	45.49	36'	64082	83.99
15'	64069	39.99	22'	64075	57.49			

Seats/
Pedestals

Anchors/
Rod Holder

Winches/
Jacks

Lites/
Tie Downs

Tires/
Couplers

Boat
Care

Misc./
Flooring

Mercury/Mariner 1965 and newer - CCX179/CC635
 Performance Advantage - Premium Control Cable can be used with Mercury/Mariner 1965 and newer and late model Force®



Length	Order No.	Retail	Length	Order No.	Retail	Length	Order No.	Retail
6'	64226	\$44.49	12'	64186	\$52.49	18'	64192	\$61.49
7'	64227	45.99	13'	64187	53.99	19'	64193	62.99
8'	64228	47.49	14'	64188	55.49	20'	64194	64.49
9'	64229	48.99	15'	64189	56.99	22'	64232	69.49
10'	64230	49.49	16'	64190	58.49	24'	64233	72.49
11'	64231	50.99	17'	64191	59.99			

Ski's/Tubes

Floation

Ladders

Water
Front

Fenders/
Dock Lines

Mariner - CC210/630
 Replacement cable for Mariner low horsepower engines when used with mercury controls.



Length	Order No.	Retail	Length	Order No.	Retail	Length	Order No.	Retail
10'	64124	\$50.49	13'	64127	\$54.49	17'	64131	\$59.49
11'	64125	51.99	14'	64128	55.99	18'	64132	60.99
12'	64126	52.99	15'	64129	57.49	19'	64133	62.49
			16'	64130	58.49	20'	64134	63.99

BRP/OMC Series - CCX205/CC636
 Extreme replacement for the 479 Series



Length	Order No.	Retail	Length	Order No.	Retail	Length	Order No.	Retail
6'	64234	\$44.49	12'	64204	\$52.49	18'	64210	\$61.49
7'	64235	45.99	13'	64205	53.99	19'	64211	62.99
8'	64236	47.49	14'	64206	55.49	20'	64212	64.49
9'	64237	48.99	15'	64207	56.99	22'	64240	69.49
10'	64238	49.49	16'	64208	58.49	24'	64242	72.49
11'	64239	50.99	17'	64209	58.99			

New Style OMC - CC205/479
 Replacement shift and throttle cable for Evinrude, Johnson and OMC 1979 to date.



Length	Order No.	Retail	Length	Order No.	Retail	Length	Order No.	Retail
10'	64034	\$33.99	16'	64040	\$38.99	24'	64046	\$ 65.49
11'	64035	34.99	17'	64041	39.99	28'	64048	62.99
12'	64036	35.99	18'	64042	40.99	36'	64052	99.99
13'	64037	36.49	19'	64043	41.49	38'	64053	108.99
14'	64038	37.49	20'	64044	42.49	40'	64054	117.99
15'	64039	38.49	22'	64045	62.49			

Old Style OMC - CC170/400
 Replacement shift and throttle cables for Evinrude, Johnson and OMC 1978 & earlier



Length	Order No.	Retail	Length	Order No.	Retail	Length	Order No.	Retail
6'	64000	\$34.49	14'	64008	\$40.49	24'	64016	\$63.49
7'	64001	35.49	15'	64009	41.49	26'	64017	66.49
8'	64002	34.99	16'	64010	42.49	28'	64018	68.99
9'	64003	35.99	17'	64011	43.49	32'	64020	74.99
10'	64004	36.99	18'	64012	44.49	34'	64021	85.99
11'	64005	37.99	19'	64013	45.49	36'	64022	96.99
12'	64006	38.99	20'	64014	46.49	38'	64023	106.99
13'	64007	39.49	22'	64015	60.99			

OMC/Volvo Penta - CCX214
 Volvo Engines using BRP/OMC controls.



Length	Order No.	Retail	Length	Order No.	Retail	Length	Order No.	Retail
12'	64250	\$59.99	15'	64253	\$64.49	18'	64256	\$69.49
13'	64251	61.49	16'	64254	66.49	19'	64257	70.99
14'	64252	62.99	17'	64255	67.99	20'	64258	72.49

- Navigation Lites
- Steering/ Controls
- Hardware/ Fasteners
- Covers/ Windshield
- Pumps/ Int. Lites
- Electric/ Battery
- Trolling Motor
- Gauges
- Electronics/ Radios
- Fuel
- Lube/ Motor Care
- Aux. Brkts/ Tilt/Trim
- Spark Plug/ Starters
- Props
- Seats/ Pedestals
- Anchors/ Rod Holder
- Winches/ Jacks
- Lites/ Tie Downs
- Tires/ Couplers
- Boat Care
- Misc./ Flooring
- Ski's/Tubes
- Floatation
- Ladders
- Water Front
- Fenders/ Dock Lines

- Navigation Lites
- Steering/Controls
- Hardware/Fasteners
- Covers/Windshield
- Pumps/Int. Lites
- Electric/Battery
- Trolling Motor
- Gauges
- Electronics/Radios
- Fuel
- Lube/Motor Care
- Aux. Brkts/Tilt/Trim
- Spark Plug/Starters
- Props
- Seats/Pedestals
- Anchors/Rod Holder
- Winches/Jacks
- Lites/Tie Downs
- Tires/Couplers
- Boat Care
- Misc./Flooring
- Ski's/Tubes
- Flotation
- Ladders
- Water Front
- Fenders/Dock Lines

SEASTAR SOLUTIONS®



Ball Joint Assembly
Fits shift and throttle universal style cables with 10-32" threads.

Mfg #CA37701P
Order No. 60683 \$16.99

SEASTAR SOLUTIONS®



Clamp/Shim Kit
For 3300 universal shift and throttle cables.

Mfg #CA28020P
Order No. 60569 \$11.99

SEASTAR SOLUTIONS®



Johnson/Evinrude Connection Kit
For use with 400 & 3400 cables on engines 35hp & below. (1973-1978)

Mfg #CA27208P
Order No. 60591T \$63.49

SEASTAR SOLUTIONS®



Universal Inboard Connection Kit
For use with universal type cables.

Mfg #CA27024P
Order No. 60567T \$60.49

SEASTAR SOLUTIONS®

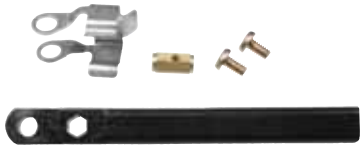

OMC/Johnson/Evinrude Connection Kit
For use with 400 & 3400 cables on engines over 35hp.(1973-1978)

Mfg #CA27247P
Order No. 60619T \$20.99

SEASTAR SOLUTIONS®



Johnson/Evinrude/OMC Pre 1978 Connection Kit
For use with universal type cables.

Mfg #CA27321P
Order No. 60663T \$30.99

SEASTAR SOLUTIONS®



Mercury O/B & I/O Connection Kit
For use with universal style cables.

Mfg #CA27319P
Order No. 60655T \$24.99

SEASTAR SOLUTIONS®

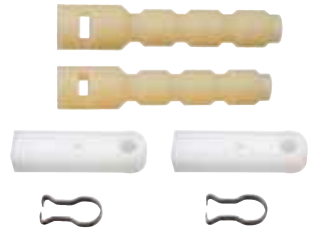

OMC Connection Kit
For use with universal cables.

Mfg #CA27320P
Order No. 60659T \$24.99

SEASTAR SOLUTIONS®



Mercury Control Adapter
Adapts universal cables for use with Mercury/Mariner controls.

Mfg #301074
Order No. 43116T \$76.49

SEASTAR SOLUTIONS®



OMC Control Adapter
Adapts universal cables for use with 1979 and later OMC controls.

Mfg #304939
Order No. 43117T \$119.99