

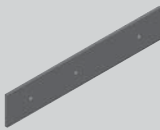







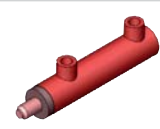

Hydraulische Verlegezange | Hydraulic Installation Clamp HVZ-UNI-II

Artikel / Article	Beschreibung / Description	Best.-Nr. / Order-Number
Gleitführung Sliding guide	 PE-Gleitführung unten PE sliding guide bottom	3640.0390
Gleitführung Sliding guide	 PE-Gleitführung oben PE sliding guide top	3640.0391
Handgriff Handle	 Handgriff oben komplett Handle top complete	3312.0049
ADV	 Einstellbare Abdrückschiene komplett ohne Verbreiterung Adjustable pressure rail complete with no expansion	4140.0975
Verbreiterung Expansion	 Verbreiterung für Abdrückschiene Expansion for pressure rail	4140.0240
ADV	 Gummianschlag ADV, 10 mm breit ADV rubber stop, 10 mm wide	2107.0138
ADV	 Hydraulikzylinder ADV hydraulic cylinder	2221.0041
ADV	 Druckfeder ADV pressure spring	2170.0069
Absetzrolle Set-down roller	 Absetzrolle komplett Set-down roller complete	4140.0962
Absetzrolle Set-down roller	 Feder für Absetzrolle Spring for set-down roller	2171.0011
Kette an Aufhängung Chain on suspension	 Kette mit Schutzschlauch für Aufhängung Chain with protective hose for suspension	4140.0945







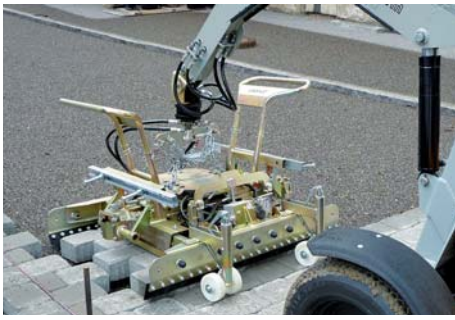

Hydraulische Verlegezange | Hydraulic Installation Clamp HVZ-UNI-II

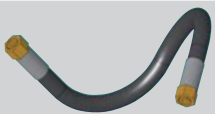
Artikel / Article	Beschreibung / Description	Best.-Nr. / Order-Number
Feder Aufhängung Spring suspension	 Feder an Aufhängung Spring on suspension	2171.0026
Höhenverstellung Height adjustment	 Höhenverstellung links komplett Height adjustment left complete	4140.0969
Höhenverstellung Height adjustment	 Höhenverstellung rechts komplett Height adjustment right complete	4140.0970
Seitenspannung Side gripping	 Anschlag Gummipuffer zylindrisch Stop rubber buffer cylindrical	2107.0009
Seitenspannung Side gripping	 Zylinder komplett für Seitenspannung Cylinder complete for side gripping	2220.0090
Seitenspannung Side gripping	 Dichtsatz für Seitenspannung Seal set for side tensioning	2151.0055
Hauptspannung Main gripping	 Zylinder komplett für Hauptspannung Cylinder complete for main gripping	3220.0021
Handgriff Handle	 Handgriff Wange rot Cheek handle red	2160.0016
Auflage Support	 Polyamidauflage für Aufhängung Polyamide support for suspension	3640.0377

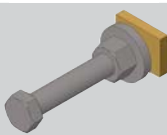

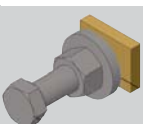
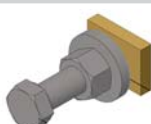
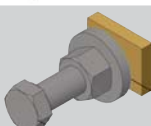
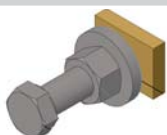



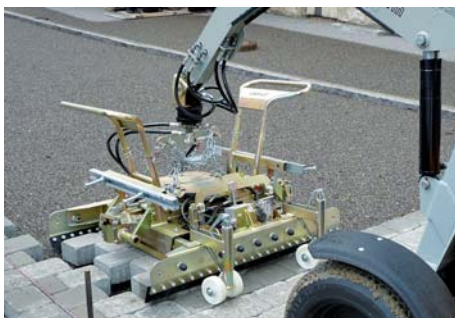



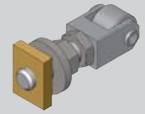

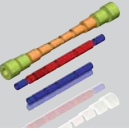
Allgemeine Ersatzteile für Hydraulische Verlegezangen HVZ Basic Spare Parts for Hydraulic Installation Clamps HVZ

Artikel / Article	Beschreibung / Description	Best.-Nr. / Order-Number
HD-Schlauch HD hose	 HD-Verbindungsschlauch 1.700 mm HD 1,700 mm connecting hose	2200.0007
HD-Schlauch HD hose	 HD-Verbindungsschlauch 2.500 mm HD 2,500 mm connecting hose	2200.0014
HVZ-Positionsadapter HVZ position adapter	 HVZ-Positionsadapter 80 mm mit Nutstein und Schrauben 80 mm HVZ position adapter with tenon block and screws	4140.0123
HVZ-Positionsadapter HVZ position adapter	 HVZ-Positionsadapter 100 mm mit Nutstein und Schrauben 100 mm HVZ position adapter with tenon block and screws	4140.0036
HVZ-Positionsadapter HVZ position adapter	 HVZ-Positionsadapter 110 mm mit Nutstein und Schrauben 110 mm HVZ position adapter with tenon block and screws	4140.0121
HVZ-Positionsadapter HVZ position adapter	 HVZ-Positionsadapter 120 mm mit Nutstein und Schrauben 120 mm HVZ position adapter with tenon block and screws	4140.0128
HVZ-Positionsadapter HVZ position adapter	 HVZ-Positionsadapter 130 mm mit Nutstein und Schrauben 130 mm HVZ position adapter with tenon block and screws	4140.0129
HVZ-Positionsadapter HVZ position adapter	 HVZ-Positionsadapter 140 mm mit Nutstein und Schrauben 140 mm HVZ position adapter with tenon block and screws	4140.0130
HVZ-Positionsadapter HVZ position adapter	 HVZ-Positionsadapter 160 mm mit Nutstein und Schrauben 160 mm HVZ position adapter with tenon block and screws	4140.0132
Gewindeplatte Positionsadapter Threaded plate Position adapter	 Gewindeplatte für Positionsadapter Threaded plate for position adapter	2019.0004
HVZ Positionsadapter Rolle HVZ Position adapter roller	 Positionsadapter mit Rolle 120 mm Position adapter with 120 mm roller	4140.1020



Allgemeine Ersatzteile für Hydraulische Verlegezangen HVZ Basic Spare Parts for Hydraulic Installation Clamps HVZ

Artikel / Article	Beschreibung / Description	Best.-Nr. / Order-Number
HVZ Positionsadapter Rolle HVZ Position adapter roller 	Positionsadapter mit Rolle 100 mm Position adapter with 100 mm roller	4140.1010
HVZ Positionsadapter Rolle HVZ Position adapter roller 	Positionsadapter mit Rolle 80 mm Position adapter with 80 mm roller	4140.1019
Baggeraufhängung Digger mounting 	UBA-1200	4140.0571
Adaptersatz UBA UBA adapter set 	Hülsensatz für UBA 1200 Sleeve set for UBA 1200	4140.0683
Halfeneisen Halfen anchoring system 	Halfeneisen 760 mm zu Seitenspannung 760 mm Halfen anchoring system to side tensioning	3401.0065
Halfeneisen Halfen anchoring system 	Halfeneisen 860 mm zu Seitenspannung 860 mm Halfen anchoring system to side tensioning	3401.0046
Halfeneisen Halfen anchoring system 	Halfeneisen 950 mm zu Seitenspannung 950 mm Halfen anchoring system to side tensioning	3401.0018
Gewindeplatte Halfeneisen Threaded plate Halfen anchoring system 	Gewindeplatte für Halfeneisen Threaded plate for Halfen anchoring system	2019.0003
Dichtsatz Seal set 	für alle HVZ. Hauptspannungszylinder for all HVZ. Main voltage gripping cylinder	2151.0041
Lamelle Standard Rib standard 	Lamelle 5x95x100 geschlitzt Slotted rib for HVZ, 5x95x100 slotted	3401.0097
Lamelle standard Rib standard 	Lamelle halbe Breite, 5x50x95 geschlitzt Rib half-width, 5x50x95 slotted	3401.0099

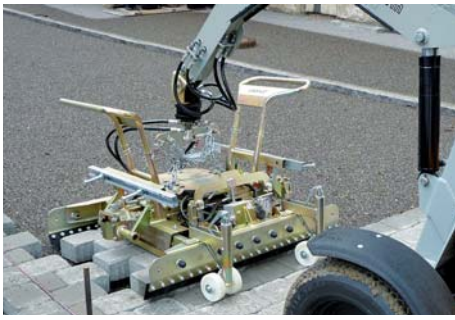

Allgemeine Ersatzteile für Hydraulische Verlegezangen HVZ Basic Spare Parts for Hydraulic Installation Clamps HVZ

Artikel / Article	Beschreibung / Description	Best.-Nr. / Order-Number
Lamelle standard Rib standard	 Lamelle breit, 5x150x95 geschlitzt Rib wide, 5x150x95 slotted	3401.0100
Lamelle lang Rib long	 Lamelle 5x120x100 geschlitzt Rib 5x120x100 slotted	3401.0059
Lamelle lang Rib long	 Lamelle lang, halbe Breite, 5x120x100/50 Rib long, half-width, 5x120x100/50	3401.0060
Lamelle lang Rib long	 Lamelle lang, breit 5x120x100/150 Rib long, wide 5x120x100/150	3401.0061
Tellerfedern Plate springs	 Tellerfedernsatz bestehend aus 144 Stück Plate spring set comprising 144 units	4140.0013
Sechskantmutter zu Tellerfedern Hex nut for plate springs	 Sechskantmutter M 12 (48 Stück Bedarf) Hex nut M 12 (48 units required)	2010.0017
Sechskantschraube zu Tellerfedern Hex screw for plate springs	 Sechskantschraube M 12 x 35 Hex screw M 12 x 35	2000.0025
Absetzrolle Set-down roller	 Polyamidrad 125/40 Polyamide wheel 125/40	2180.0001
Manometer	 HVZ-Manometer 400 bar	2213.0002
Bordwerkzeug On-board tools	 Rohrsteckschlüssel SW24 Tubular wrench SW24	7069.0041
Bordwerkzeug On-board tools	 Imbusschlüssel SW8 Allen key SW8	7063.0001

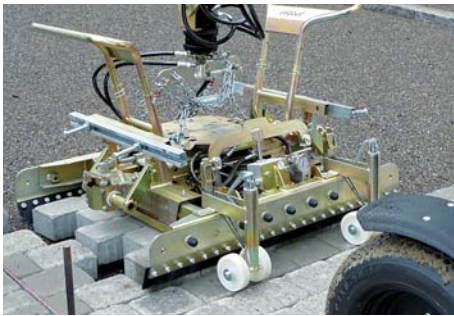

Hydraulische Verlegezange | Hydraulic Installation Clamp HVZ-UNI

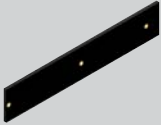
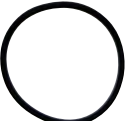
Artikel / Article	Beschreibung / Description	Best.-Nr. / Order-Number
Gleitführung Sliding guide	 PE-Gleitführung unten PE sliding guide bottom	3640.0207
Gleitführung Sliding guide	 PE-Gleitführung oben PE sliding guide top	3640.0208
Handgriff Handle	 Handgriff oben komplett Top handle complete	4140.0252
ADV	 Führung ADV guide	4140.0489
ADV	 Rückschlagventil für ADV-Zylinder im ADV-Block Check valve for ADV cylinder in ADV block	2204.0030
ADV	 Federriegel ADV Schiene Spring lock ADV bar	2054.0024
ADV	 Einstellbare Abdrückschiene komplett Adjustable pressure rail complete	4140.0245
ADV	 Druckfeder ADV compression spring	2170.0030
ADV	 Kolbenstange mit Führung und Dichtung Piston rod with guide and seal	2154.0005
ADV	 Dichtungssatz für ADV-Zylinder Seal set for ADV cylinder	2154.0004
Gummi Absetzrolle Rubber Set-down roller	 O-Ring, 100 x 6 zu Absetzrolle O-ring, 100 x 6 for set-down roller	2155.0058

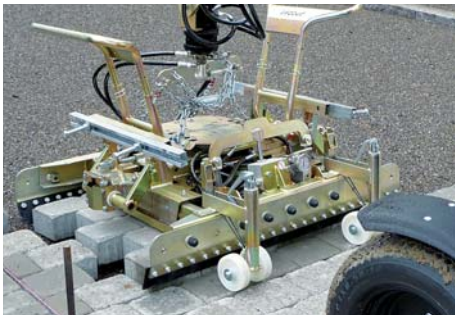

Hydraulische Verlegezange | Hydraulic Installation Clamp HVZ-UNI

Artikel / Article	Beschreibung / Description	Best.-Nr. / Order-Number
Absetzrolle Set-down roller	 Absetzrolle komplett Set-down roller complete	4140.0313
ADV Ventil ADV valve	 Druckfolgeventil kurz Pressure sequence valve, short	2203.0032
ADV Ventil ADV valve	 Druckfolgeventil lang Pressure sequence valve, long	2203.0033
Kette an Wangen Chain on cheeks	 Kette DIN 5685 23 Glieder (Bedarf 2 Stück) DIN 5685 chain 23 links (requirement: 2 units)	2100.0179
Kette an Aufhängung Chain on suspension	 Kette DIN 5685 38 Glieder (Bedarf 2 Stück) DIN 5685 chain 38 links (requirement: 2 units)	2100.0180
Höhenverstellung Height adjustment	 Höhenverstellung komplett links Height adjustment complete left	4140.0258
Höhenverstellung Height adjustment	 Höhenverstellung komplett rechts Height adjustment complete right	4140.0259
Schäkel Aufhängung Shackle suspension	 Schäkel hochfest 0,75 t Shackle high-tensile 0.75 t	2103.0006
Spannhülse Clamping sleeve	 für Schäkel hochfest 0,75 t an HVZ-Mittelteil for shackle high-strength 0.75 t on HVZ middle port	2053.0069
Schäkel Kette Wange Shackle chain cheek	 Schäkel verzinkt 0,25 t Shackle galvanised 0.25 t	2103.0002
Seitenspannung Side gripping	 Schweißteil an Zahnstange Bolt short	4140.0314

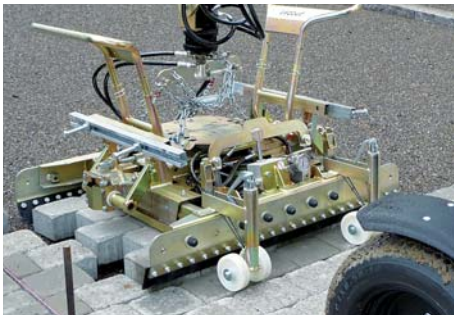

Hydraulische Verlegezange | Hydraulic Installation Clamp HVZ-UNI

Artikel / Article	Beschreibung / Description	Best.-Nr. / Order-Number
Seitenspannung Side gripping	 Bolzen kurz Bolt short	3331.0006
Seitenspannung Side gripping	 Bolzen lang Bolt long	3331.0003
Hauptspannung Main gripping	 Zylinder komplett für Hauptspannung Cylinder complete for main gripping	3220.0021
Seitenspannung Side gripping	 Zylinder komplett für Nebenspannung Cylinder complete for side gripping	2221.0046
Ventilblock Valve block	 Ventilblock inkl. Druckhalteventil Valve block incl. pressure retaining valve	2204.0015
Schutzkappe Protective cap	 Schutzkappe Schraubenkopf an Lamellenträger Protective cap screw head on support strap	2107.0065
Druckschalter Pressure switch	 Druckschalter mit Würfelstecker Pressure switch	2411.0020
Karabiner Snap hook	 Karabinerhaken 60 x 6 Snap hook 60 x 6	2102.0012

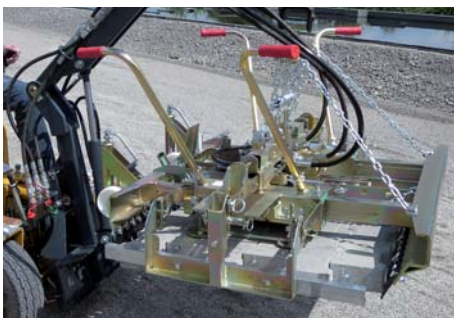



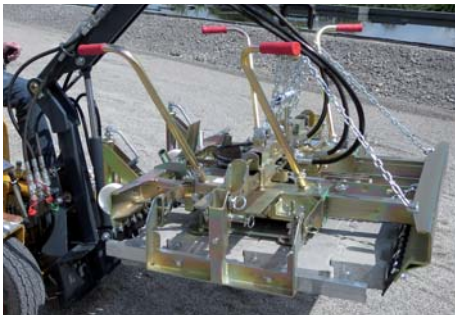

Hydraulische Verlegezange | Hydraulic Installation Clamp HVZ-STANDARD

Artikel / Article	Beschreibung / Description	Best.-Nr. / Order-Number
Zylinder Cylinder	 Zylinder Seitenspannung Cylinder side gripping	2220.0001
Zylinder Cylinder	 Zylinder Hauptspannung Cylinder main gripping	3220.0021
Bolzen Bolt	 Seitenspannung 16 x 139 Side gripping 16 x 139	3032.0036
Bolzen Bolt	 Seitenspannung 20 x 79 Side gripping 20 x 79	3032.0037
Bolzen Bolt	 Seitenspannung 16 x 53 Side gripping 16 x 53	3032.0002
Bolzen Bolt	 Seitenspannung 20 x 71 Side gripping 20 x 71	3035.0009
Bolzen Bolt	 Klappspinn Linchpin	2054.0036
Gleitschiene Sliding rail	 Gleitführung Polyamid Polyamide sliding guide	3641.0026
Aufhängung Suspension	 Zugfeder 9 x 35 x 226 x 19 Tension spring 9 x 35 x 226 x 19	2171.0004
Aufhängung Suspension	 Kette 10 Glieder Chain 10 links	2100.0164
Aufhängung Suspension	 Kette 12 Glieder Chain 12 links	2100.0088



Hydraulische Verlegezange | Hydraulic Installation Clamp HVZ-STANDARD

Artikel / Article	Beschreibung / Description	Best.-Nr. / Order-Number
Aufhängung Suspension	 Schraube M10 x 45 10.9 Screw M10 x 45 10.9	2000.0239
Aufhängung Suspension	 Schraube M10 x 65 10.9 Screw M10 x 65 10.9	2000.0261
Ventilblock Valve block	 Ventilblock inkl. Druckhalteventil Valve block incl. pressure retention valve	2204.0015
ADV	 Druckfeder ADV Compression spring ADV	2170.0009
ADV	 Führung ADV Guide ADV	4140.0489