

TURBOCOMPRESSORS

Hydrodynamic Bearings

Notebook

Flexware, Inc.

P.O. Box 110
Grapeville, PA,
U. S. A.

sales@flexwareinc.com
www.flexwareinc.com

© 2020

FHBNB2020

About the Authors

Anibal R. Arias is President and Technical Director of [SEMTEC](#), a company specialized in Turbomachinery and its Associated Systems. Mr. Arias has worked 19 years for Petroquímica Bahía Blanca, an ethylene producer located in Argentina. During this time he was responsible for Preventive and Predictive Maintenance of Rotating Machinery; Maintenance Engineering and before resigning from the petrochemical company he was Mechanical Maintenance Manager.

In his past professional experience from 1975 to 2001, Mr. Arias taught engineering courses in Universidad Nacional del Sur. Before resigning from this position, he was Adjunct Professor of Machine Elements course.

In 1990 he founded [SEMTEC](#). Since then he has conducted numerous seminars and workshops on technical and maintenance organization matters in Argentina and around the world including “Compressor Performance Seminar”.

Mr. Arias has a Mechanical Engineering Degree from Universidad Nacional del Sur and has extensive hands-on technical training in the USA with Davy-Mc Kee Corporation and Elliott Company. He is a member of ASME, The Vibration Institute and the Society of Tribologist and Lubrication Engineers. You can contact Mr. Arias at: semtec@speedy.com.ar

M. Theodore (Ted) Gresh is President & CEO of Flexware, Inc., Grapeville, Pennsylvania, U.S.A. Mr. Gresh does consulting work, organizes Turbomachinery training seminars and is technical director of Flexware software maintenance and upgrade and other engineering activities.

While at Elliott Co., Jeannette, PA, USA, he was Sr. Design Engineer in charge of the design of centrifugal compressors. During this period he was involved in the design of new centrifugal compressor staging, oil seal redesign as well as the resolution of various shop problems. As Sr. Compressor Service Engineer at Elliott Co. he was involved with the field-testing of compressors and steam turbines and troubleshooting various field problems like performance issues, bearing and seal problems and vibration problems including instability problems.

Gresh received a B.S. degree (Aerospace Engineering, 1971) from the University of Pittsburgh. In addition to numerous papers and magazine articles, he has published a book on the subject of compressor performance, and has several patents related to turbomachinery. He is a registered Professional Engineer in the State of Pennsylvania. You can contact Mr. Gresh at his e-mail address: mtgresh@flexwareinc.com

Hydrodynamic Bearings



Purpose of the Journal Bearings

- Each compressor is equipped with two journal bearings and one thrust bearing.
- Support and distribute the weight and forces acting on the rotor.
- Maintain concentricity of the rotor with respect to the stationary parts of the casing.
- Provide stabilizing forces to the rotor-bearing system.

Type and size of Bearings

- The type and size of the bearing is dependent on the following:
 - ⇨ Maintain bearing loading within acceptable limits.
 - ⇨ Maintain rubbing speed within acceptable limits to keep bearing metal temperatures low.
 - ⇨ Maintain stiffness and damping coefficients values to provide sufficient margins between critical speeds and operating speed and to ensure stable operation of the rotor-bearing system.
- Journal bearings operate on the hydrodynamic principle.
- When lubricant fills the space between two surfaces having relative motion, the lubricant is drawn into a converging wedge.
- A pressure is generated which causes a force normal to the direction of motion.

- This force tends to push both surfaces apart.

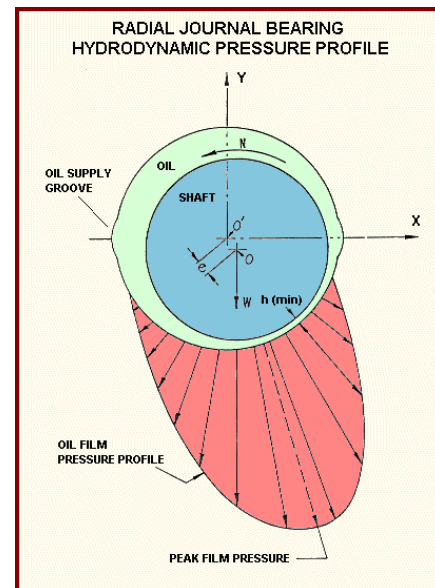

- It is this force which gives the bearing its load carrying capacity.
- For every force there is an equilibrium distance between the surfaces. As load increases, this distance decreases.

Operational characteristics of a bearing

- With rotor at rest, the shaft is at the bottom of the bearing.

- As rotation begins, the shaft begins to climb the bearing wall, with metal-to-metal contact occurring.

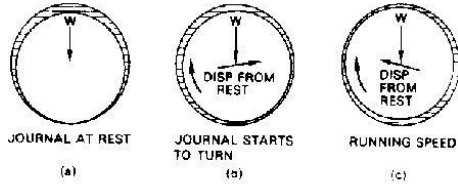

- As speed increases, the oil pressure begins to build up, lifting the rotor off the bearing.
- As speed increases further, the pressure continues to build up and pushes the shaft to the center or opposite side.
- Oil film thickness depends on the load, bearing geometry (diameter and length), rpm, bearing clearance, and lubricant viscosity.
- All these variable are grouped in what is called the Sommerfeld number.
- Since oil film separates shaft from bearing during normal operation, the majority of bearing wear occurs during start-up and shutdown operation.

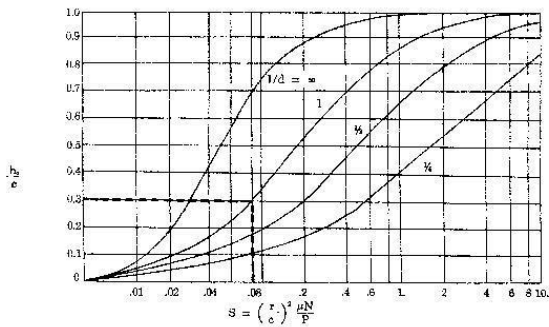

- Wear occurring during normal operation is typically due to dirt particles passing through the bearing and disrupting the oil film.
- Dirt particles larger than the oil film scratch or score the bearing and shaft journal.
- Journal bearings provide more damping than rolling bearings because of the lubricant presence.

- More viscous and thicker lubricant films provide higher damping properties.
- As the available damping increases, the bearing stability also increases.
- A stable bearing design holds the rotor at a fixed attitude angle during transient periods such as machine start-ups, shutdowns or load changes.
- The damping properties of the lubricant also provide an excellent medium for limiting vibration transmission.
- A vibration measurement taken at the bearing housing does not represent the actual vibration experienced by the rotor within its bearing clearances.

Type of Bearings

- Plain Bearings.
- Lemon or Elliptical Bearings.
- Pressure Dam Bearings.
- Tilting Pad Bearings.

Plain Bearings

- Simplest and more common design with a high load carrying capacity and lowest cost.
- Cylindrical configuration with a clearance of about 1-2 mils per inch of journal diameter.
- It is common during installation to provide a slight amount of “crush” to force the bearing into its housing.
- Due to its cylindrical configuration it is the most susceptible bearing to oil whirl.

Lemon or Elliptical Bearings

- Is a variation on the plain bearing where the bearing clearance is reduced on one direction.
- During manufacturing this bearing has shims installed at the split line and then bored cylindrical.
- For horizontally split bearings, this design creates an increased vertical pre-load onto the shaft.
- This bearing has lower load carrying capacity than plain bearings, but are still susceptible to oil whirl at high speeds.

Pressure Dam Bearings

- A pressure dam bearing basically is a plain bearing which has been modified to
- incorporate a central relief groove or scallop along the top half of the bearing shell ending abruptly at a step.
- As lubricant is carried around the bearing it encounters the step that causes an increased pressure at the top of the journal inducing a stabilizing force onto the journal which forces the shaft into the bottom half of the bearing.
- This bearing has a high load capacity and is a common correction for machine designs susceptible to oil whirl.
- Pressure dam bearings are a unidirectional configuration.

Tilting Pad Bearings

- Tilting pad bearings is a partial arc design.
- This configuration has individual bearing pads which are allowed to pivot or tilt to conform with the dynamic loads from the lubricant and shaft.
- This type of bearing is a unidirectional design and is available in several variations incorporating differing numbers of pads with the generated load applied on a pad or between the pads.
- Tilting pad bearings are largely used in turbomachinery.
- This is due to increasing severity of applications caused by new process demands, light weight and high speed rotors and customers preferences.

Tilting Pad Bearings Advantages

- Good stiffness and damping coefficients which are readily adjustable to eliminate oil film destabilizing forces which are inherent to plain bearings.
- High threshold speed for hydrodynamic instability.
- Eliminates oil whip.
- Inherent self aligning capability to compensate for load and rotor position changes.

- More effective flushing out of foreign particles which enter the bearing with the oil.

Tilting Pad Bearings Disadvantages

- Utilization of more parts.
- More expensive.
- Closer tolerances.
- More difficult to service.

Tilting Pad Bearings Design Considerations

- ⇒ Control of stiffness and damping properties to achieve rotor stability and acceptable critical speed margins.
- ⇒ Mechanical reliability.
- ⇒ Serviceability.
- ⇒ Optimization of power losses and cooling oil requirements.

Stiffness and damping properties

- **L/D Ratio:**
 - ⇒ Length over diameter ratio is normally 0.3 to 1.0
 - ⇒ Generally, the smallest L/D ratio is selected to minimize power losses while still maintaining acceptable bearing load limits.
- Number of pads.
 - ⇒ Typically, 5 pads are used.
 - ⇒ In certain instances less than 5 pads but not less than 3 pads are used.
 - ⇒ More than 5 pads complicates the design and does not significantly improve performance.
- Orientation.
 - ⇒ Load Between Pads (LBP) is typical.
 - ⇒ Load On Pads (LOP) is also sometimes used.
 - ⇒ In a LBP configuration, two pads are in the bottom half of the bearing and three pads are in the upper half.

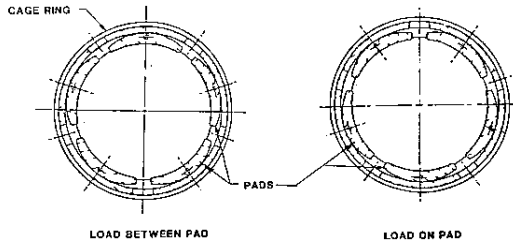

- The advantages of LBP versus LOP are:
 1. Load is split among the lower two pads as opposed to being on only one pad.
 2. Improved bearing fatigue life.
 3. More vertical and horizontal stiffness values.
- Pivot location.
 - ⇨ Tilt pad pivot are generally located in the center of the pad.
 - ⇨ In certain instances, pivots may be offset towards the pad trailing edge for improved oil wedge formation and increased stiffness.

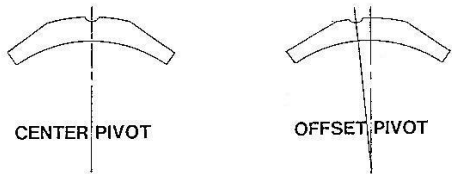

- Preload.
 - ⇨ Bearing preload is the relationship of the curvature of the pads to the curvature of the shaft.

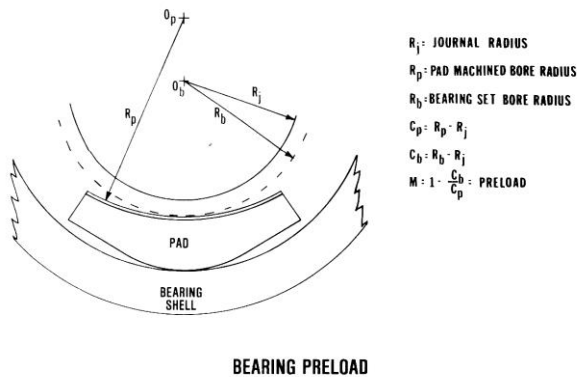

- ⇨ Bearing preloads are always kept positive between values of +0.1 to +0.7, with the majority being kept around +0.3 to 0.4.
- ⇨ Positive preload indicates the curvature of the pad is greater than the curvature of the shaft.
- ⇨ Positive preload is conducive to the formation of an oil wedge and obtaining good damping

coefficients.

- ⇨ Increasing the preload of a bearing causes increased stiffness coefficients.

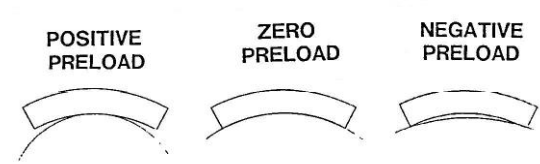

- Clearance.
 - ⇨ Bearing clearances are typically 1.0 to 1.5 mils clearance per inch of shaft diameter.
- OEMs predetermine the above discussed variables for standard bearing designs. These standard designs are then selected for given applications to meet rotordynamics requirements.
- The effects of slight changes can be evaluated since stiffness and damping properties are computerized for almost any combination of variables.



Mechanical Reliability

- Aspects to consider:
 - ⇨ Pad thickness should be as thick as practical to prevent deflection under maximum anticipated load, which can be applied to the bearing.
 - ⇨ Pad pivot areas and hardness must be considered to prevent fretting and pivot area indentation.
 1. Point pivot pads require the use of hardened materials due to high contact stresses.
 2. Pads with increased surface area such as ball or spherical pivots generally do not require hardening but may be hardened to improve wear resistance.
 3. Generally, a low alloy steel case hardened to about 60 HRC with a core hardness of 35 HRC works well as a pivot.

- ⇒ The bearing pad inner surface is covered with a softer material, commonly called Babbitt.
 1. Babbitt is a tin or lead based alloy, such as ASTM B23 alloy number 2.
 2. Thickness of Babbitt is generally kept to less than 0.05” to provide good fatigue resistance.
- ⇒ Machining tolerances on a tilt pad bearing are extremely tight to achieve the desired assembled clearance and preload.
 1. Pad curvature must be inspected by a bluing contact check on accurately ground arbors to ensure proper preload.
- ⇒ Cooling oil supply to the bearing must be such that all the pads receive adequate oil.
 1. Oil flow to the bearing is typically governed by an inlet flow control orifice.
 2. Wiper rings at both sides provide a slight backpressure in the bearing.
 3. Excess backpressure or excessive oil flow increase power losses.
- Aspects to consider:
 - ⇒ The design of tilt pad bearings should include easy assembly and replacement of wearing parts.
 - ⇒ Individual parts (i.e. pads set) should be replaceable since whole bearing is expensive.

Serviceability

- ⇒ It is desirable to have bearing pieces be interchangeable.
- ⇒ It is desirable to have clearance adjustment without extensive parts replacement.
- ⇒ Bearings should always be accessible without having to disturb the seals, casing or coupling.

Power loss and cooling oil flow

- ⇒ Oil requirements for tilt pad journal bearings are defined from testing of the bearings.
- ⇒ Only a small percentage of the oil flow gets into the oil film supporting the rotor.
 1. The bulk of the oil circulates behind and around the pads carrying heat away.
- ⇒ For every bearing there is an optimum flow rate.

1. Increasing flow beyond this rate does not significantly increase cooling rate, but does increase power loss.



- ⇒ Oil flow and power loss are related as follows:

$$\text{GPM/HP} = 12.18 / (T_2 - T_1)$$

where,

T_2 = Throw off oil temperature, Deg F.

T_1 = Bearing oil inlet temp, Deg F.

- ⇒ At low speeds, where minimum oil film thickness is a concern, low temperature rise is desirable.
- ⇒ At higher speeds, larger temperature rises are acceptable.

Maintenance of tilt pad bearings

- Theoretically, properly designed and operated bearings should last indefinitely.
- However, in practical applications, maintenance intervals of 1 to 3 years are typically recommended provided there is no indication of trouble.
- Bearing maintenance should include the following checks:
 - ⇒ Dowels
 1. Bearing housing dowels should be checked for looseness

2. Bearings center the rotor with respect to the compressor internals. Loose dowels may cause bearing housing to shift and result in a rub.

⇨ Pivot support

1. Inspect bearing housing bores or bearing retainers, which support pads.
2. Fretting or brinelling in the support areas can result in increased clearance or hinder pad motion.
3. Any extreme wear in this area must be corrected by either replacing the retainer or having it plated or reground to the proper diameter.

⇨ Pads.

1. The bearing surface of the pads generally shows some sign of wear such as scoring, wiping or fatigue.
2. Damaged pads should always be replaced.
3. If a Load On Pad configuration shows some sign of wiping, a change to Load Between Pads configuration can generally be accomplished by rotating the retainer and the anti-rotation pin. Typically this change is not detrimental to performance, but the OEM should be consulted first.

⇨ Wiper rings

1. Wiper rings should be checked for proper clearance to ensure correct cooling oil flow rates.
2. Floating wipers should be checked for freedom of movement.

⇨ Clearance

1. Assembled clearance check of tilted pad bearings is done in the field by performing a lift check in both the horizontal and vertical planes.
2. A vertical check is done by raising the rotor from rest on the bottom pads until it contacts the top pads.

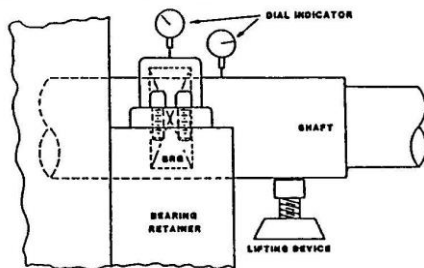

3. A horizontal check is done by raising the rotor half of the vertical clearance and then barring from one side to the other.
4. Large capacity cranes should not be used since they can damage parts.

⇨ Alignment

1. Misalignment problems can affect bearing performance and result in vibration problems.
2. Alignment not only refers to shaft alignment, but also applies to bearing retainer to shaft centerline alignment.
3. In certain instances, adjustable bearing retainers provide a means to adjust position to obtain the best bearing contact pattern possible.
4. Alignment should be checked at regular maintenance intervals.

Bearing Health Monitoring

- Through proper attention to available supervisory instrumentation and maintenance of the lube oil system, bearing life can be extended and the need for maintenance reduced.
- The supervisory instrumentation provided on a compressor is typically used to accomplish the following:
 - ⇨ Monitor bearing operating parameters.
 - ⇨ Establish trends as to the condition of the bearing as a basis for maintenance evaluation.
 - ⇨ Shut the compressor down in the event a specific set point is exceeded.
- In order to evaluate the condition of the bearings, good record keeping is a must.
- Record keeping is accomplished through daily operating data log sheets, or through process control computer.
- The main concern is to evaluate the data on a regular basis, looking for changes which may be gradual or sudden which would indicate the need for further observation, analysis or maintenance planning.

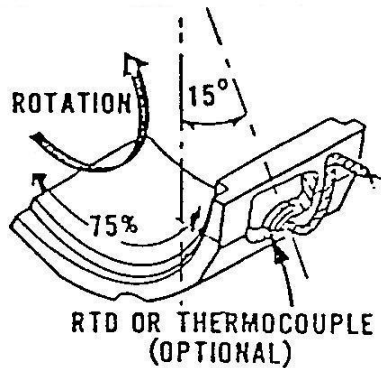

Pad Metal Temperature

- Pad metal temperature is considered the best indicator of actual bearing condition.
- Temperature is monitored by RTD's or thermocouples installed in the trailing edge of the pads at the point of highest bearing load.
- Often two pads are instrumented to provide redundancy in the event one sensor fails.
- Recommended alarm and trip settings are:
Alarm: 270 Degrees F. (132 Deg. C)
Trip: 280 Degrees F. (138 Deg. C)

Bulk Oil Temperature Rise

- Not nearly as good as pad metal temperature as an indication of bearing condition.
- Typically the oil drain is a combination of thrust bearing and journal bearing throw off temperature.
- An increase of 5-10 Deg. F with no change in machine conditions can be an indicator of inadequate oil flow.

Proximity Probe Gap Voltage

- Gap voltage may be used to determine if bearing clearance has increased due to wear.
- Changes in machine conditions do affect rotor running position in the bearing, thus only significant changes in gap voltage should be a concern.

Lube Oil System

- Lube oil system maintenance is by far the single most important action to increase bearing life.

- Impurities in oil such as water and dirt are the major causes of bearing damage.
- Water corrodes carbon steel piping, valves, reservoirs and bearing parts creating rust like sludge, which can score pads and journals.
- Water should be drained from the reservoir bottom and filters changed at regular intervals.
- Oil should contain additives to provide anti-rust, anti-wear, anti-foam and oxidation stability.

Purpose of Thrust Bearings

- Absorb axial thrust generated by the compression aerodynamic forces.
- Axially position the rotor with respect to the stationary parts of the compressor.

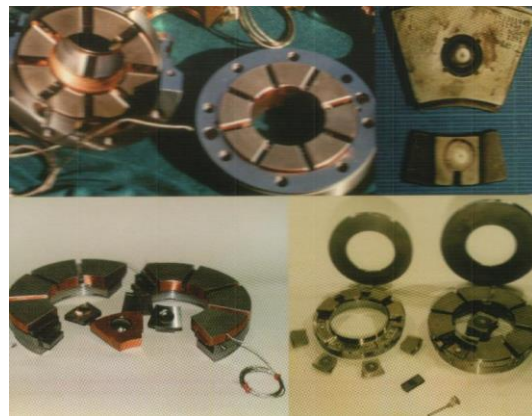

- The thrust bearing must withstand the maximum amount of thrust, which can be imposed during normal and off-design conditions and aerodynamic instabilities.
- Severe shock or distress, such as liquid ingestion, are outside the realm of normal operation and typically the thrust bearing is not capable of withstanding such forces.

Type and size of Bearings

- The type and size of the bearing is dependent on the following:
 - ⇒ Maintain bearing loading within acceptable limits.
 - ⇒ Maintain rubbing speed within acceptable limits to keep bearing metal temperatures low.

- Thrust bearings operate on the same hydrodynamic principle as journal bearings.
- With the rotor at rest, the thrust collar may or may not be resting against the thrust bearing.
- As rotation begins, the thrust collar may make metal-to-metal contact with the thrust bearing.

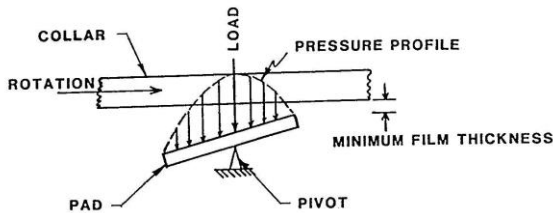

- As speed increases, the oil pressure begins to build up between the thrust collar and the thrust bearing, pushing the collar away from the thrust bearing.

Oil Film

- Since oil film separates the thrust collar from the thrust bearing during normal operation, the majority of the bearing wear occurs during start-up and shutdown operations.
- Wear occurring during normal operation is typically due to dirt particles passing through the bearing and disrupting the oil film.
- Dirt particles larger than the oil film scratch or score the bearing and thrust collar.

Thrust Bearing Design Objectives

- ⇒ Sizing for proper load capacity.
- ⇒ Optimization of power losses and cooling oil requirements.

Load Capacity

- Load capacity is a function of oil film thickness, mechanical design and temperature.

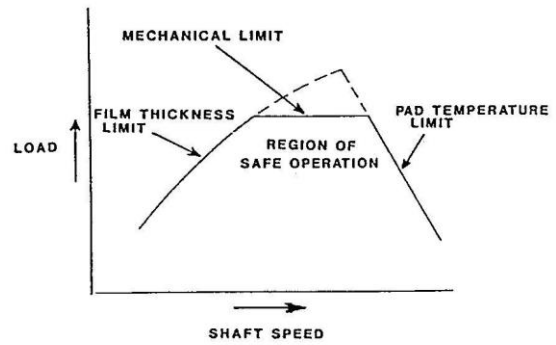

- At low speeds, oil film thickness is the limiting parameter.
- As speed increases, the pressure in the converging oil film increases providing increased load carrying capacity.
- Oil film temperature increases with the speed and eventually the temperature limit of the Babbitt begins to limit the load.
- Chrome copper backed pads permit higher load capacity than steel pads.
- Highest load capacity is in the medium speed range and may be cut off by mechanical design of the bearing assembly as deflection becomes excessive.

Cooling Oil and Power Loss Requirements

- ⇒ Oil requirements for thrust bearings are defined from testing of the bearings.
- ⇒ Only a small percentage of the oil flow gets into the oil film between the thrust collar and pads.

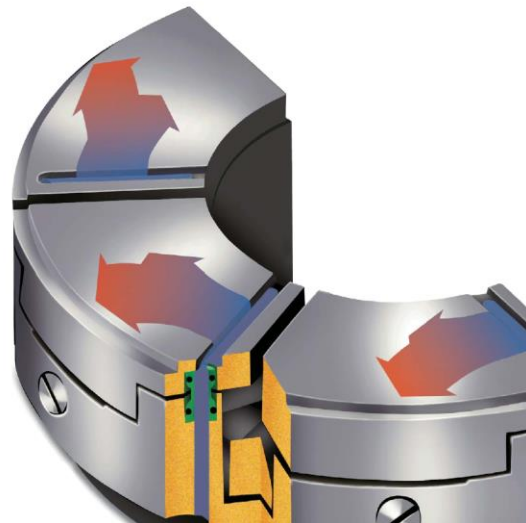

1. The bulk of oil circulates behind and around the pads carrying away heat.
- ⇒ For every bearing there is an optimum flow rate.
1. Increasing flow beyond this rate does not significantly increase cooling rate, but does increase power loss.

Maintenance of Tilting Pad Bearings

⇒ Pads

1. The Babbitt surface of the thrust pads generally shows some sign of wear such as scoring, wiping or fatigue.
2. Damaged pads should be replaced.
3. Pad orientation is typically not a concern except for pads with instrumentation, offset pivot or leading edge lubrication.

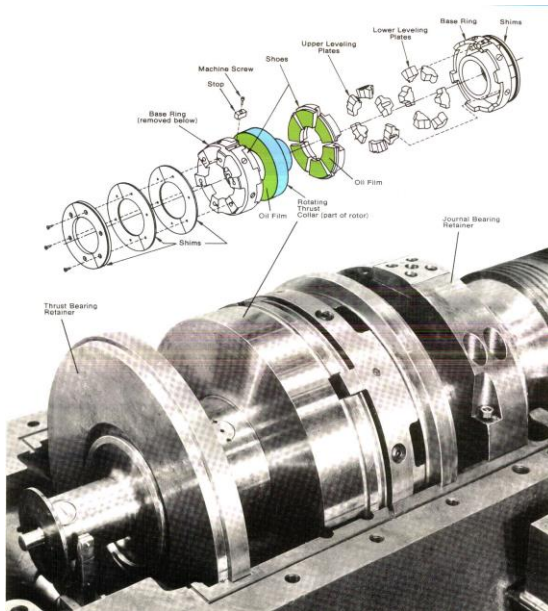

4. The preference is to replace thrust bearing pads as a complete set and not individually.
5. Worn or damaged thrust collars should be repaired or replaced.

⇒ Leveling links

1. Leveling links and backup plate pivot points should be inspected for wear or brinelling.
2. Preference is to replace leveling links if worn.

⇒ Thrust Bearing Position and Float

1. During compressor disassembly and assembly, the rotor position and thrust bearing float should be checked.
2. If the thrust bearing float check shows an

increase in float, the bearing should be inspected for wear.

- 2a. It is possible for thrust float to increase due to shim pack compression.
- 2b. To prevent this occurrence, one piece shim plates should be used rather than multiple thin shim sheets.

- The following steps are suggested for setting rotor running position and thrust float:

1. Check the total rotor float using a dial indicator on the shaft end with the thrust bearing removed. If the total float has changed since the last reading investigate the cause.

- 1a. Changes in total rotor float may be due to an internal piece of hardware improperly installed, foreign material or the result of an axial rub.

- 1b. Total float can also be used as a check whenever the upper half casing is installed to ensure no piece of hardware will prevent axial movement.

2. Determine rotor running position that satisfies clearances and alignments specified on assembly drawings in the OEM instruction books.

- 2a. Compressor rotor running position is usually defined by:

I. Alignment of impellers with diffusers.

II: Shaft end seals requirements.

- 2b. Change active side bearing shim plates as required to set the rotor in running position.

3. Determine thrust bearing float from OEM's assembly drawings.

- 3a. Adjust inactive side shim plates as required to obtain desired thrust float.

4. Install top half of bearing case and recheck thrust float to ensure it is as specified and determined in step 3.

- 4a. Adjust inactive side shims as required until thrust float is obtained.

- 4b. Final check should always be done with bearing housing cover bolted up to ensure movement of the thrust bearing in the free state does not cause erroneous readings.

5. Install and set axial position probes.

- 5a. Thrust monitor may be set up to read zero with the rotor in the middle of the float.

- 5b. Thrust monitor may be set up to read zero with the rotor against the active thrust bearing.

Bearing Health Monitoring

- The concepts outlined for journal bearings also apply to thrust bearings.
 - ⇒ Use of supervisory instrumentation.
 - ⇒ Monitor operating bearing parameters.
- ⇒ Establish trends.
- ⇒ Shut down the compressor when a setpoint is exceeded.

Bearing Damage

It is not uncommon occurrence in opening up a compressor, to find that the bearings have been damaged in service but the cause of damage may be obscure.

The bearings are often blamed and whilst faulty design or manufacture of the bearings may be responsible, the cause most frequently lies in extraneous sources.

- The coming slides show different type of damage the bearings can suffer and likely causes of bearing damage.

Scoring due to foreign matter or “dirt”



Scoring due to foreign matter or “dirt”

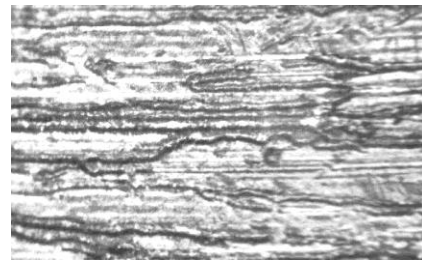

Magnification of previous photo. Note irregular tracks caused by rolling of metal particles.

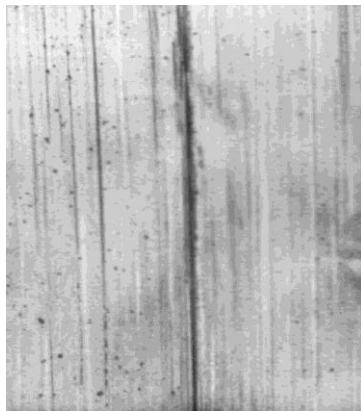

Scoring due to foreign matter or “dirt”



Pitting due to foreign matter or “dirt”

- This is usually attributed to contamination of the lubricant, which includes:
 - ⇒ “Built-in” dirt on bearing housings and lube oil system: piping, filters and reservoir, left during maintenance actions.
 - ⇒ “Entrained dirt” entering through reservoir breathers.
 - ⇒ Metallic wear particles resulting from abrasive wear of moving parts.

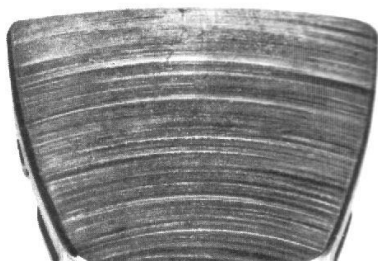

- The degree of severity damage caused by “dirt” depends upon the nature and size of the dirt particle, or oil film thickness and type of bearing material.

Wiping of bearing surfaces

- A wiped bearing surface is where surface rubbing, melting and smearing is evident.
- This is usually due to inadequate running clearance with consequence surface overheating, or may be due to inadequate oil supply, or to both these causes.

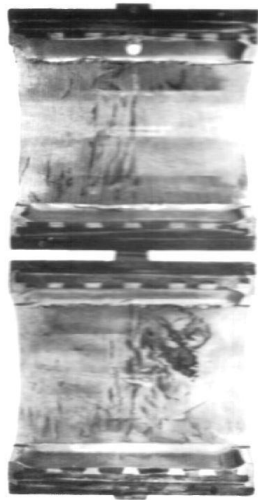
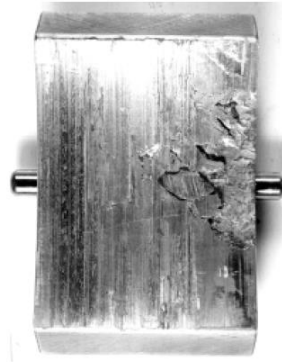

Wiped top and bottom halves due to inadequate clearance.

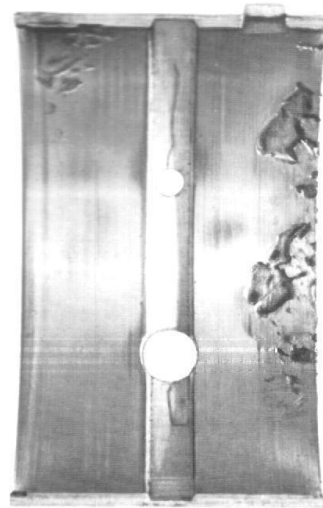

Babbitt fatigue due to high edge loading.

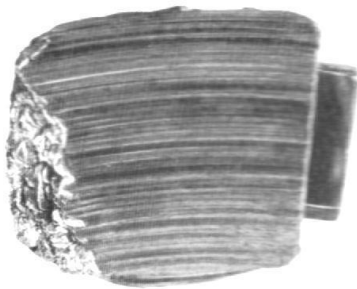

Wiped thrust pad due to high load.

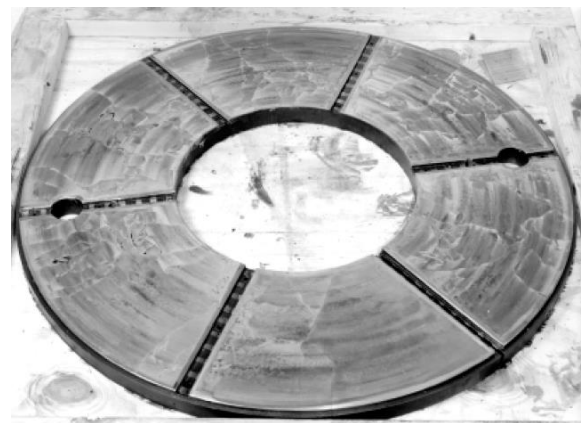

Fatigue failure of thrust bearing

Corrosion

- Corrosion of the lead in copper-lead and lead-bronze alloys and lead base white metal may be caused by acidic oil oxidation products formed in service, by ingress of water into the lubricating oil, or by decomposition of certain additives.

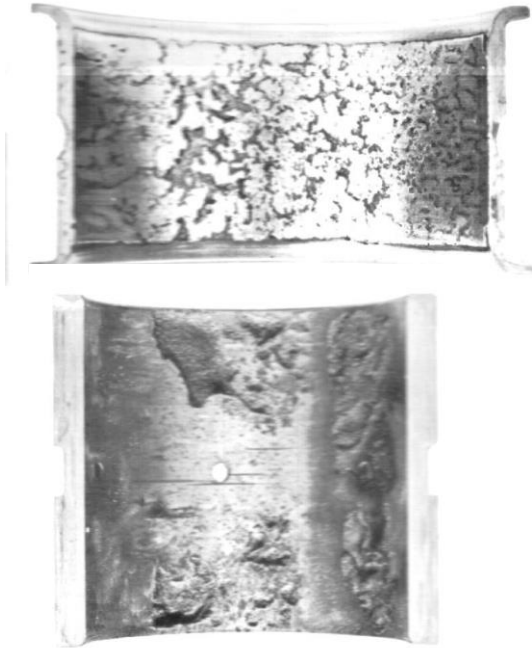

Bearing corrosion.



Tin oxide damage of thrust shoe.

Cavitation - Erosion

- This is an impact fatigue attack caused by the formation and collapse of vapour bubbles in the oil film.



”Black scab” or “Wire wool”

- A large dirt particle carried into the clearance space by the lubricating oil, and becoming embedded in the bearing may form a hard scab of material by contact with the steel journal or thrust collar.
- This scab will cause then very severe damage to the mating steel surface which is literally machined away with the formation of the so-called “wire wool”

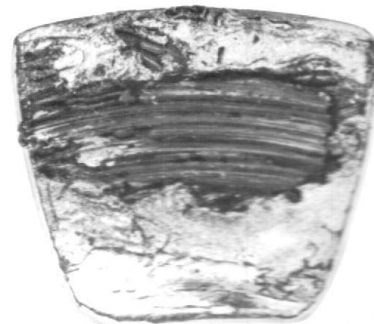

- Susceptibility to scab formation depends upon the nature of the lubricant and the composition of the steel of the rotor shaft or collar.
- Steels containing chromium or manganese in excess of 1 % appear to be highly susceptible to scab formation.

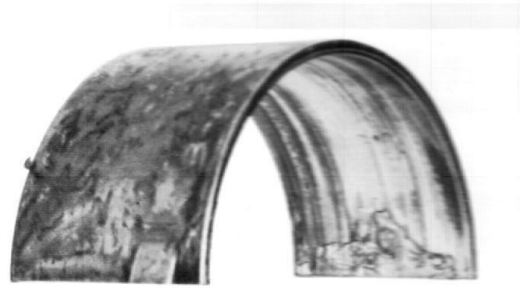

Fretting.

Pitting due to electrical discharge

- Electrical discharge through the oil film between journal and bearing may occur due to faulty insulation or earthing or to the build-up of static electricity.



Misalignment of thrust housing.

Fretting damage due to vibration

- Bearing operating surfaces may suffer fretting damage while the shaft is at rest due to vibrations transmitted to the machine from external sources.



Fretting.

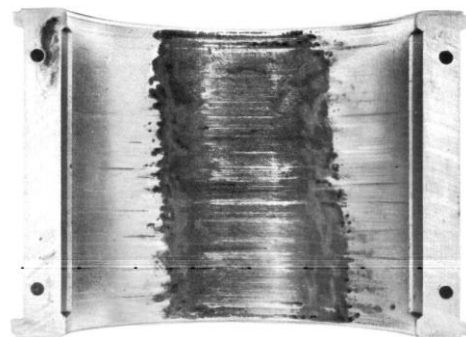

Damage caused by vibration while shaft was idle.

- Babbitt extrusion and cracking may be due to overheating with its consequent reduction in strength so that the material yields and cracks due to the effect of normal and shear forces transmitted through very thin oil films.



Fatigue Failure



Fatigue Failure

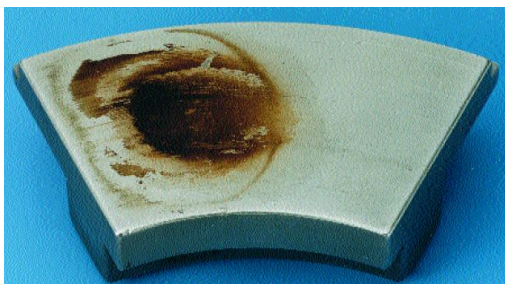

Varnishing

Leveling links fatigue

- Axial vibrations can cause damage and fatigue of tilting pad leveling links and retaining ring.
- Axial vibrations may be caused by thrust collar face running out of true.

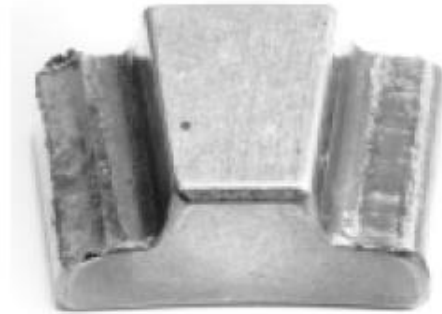

Leveling link damage.

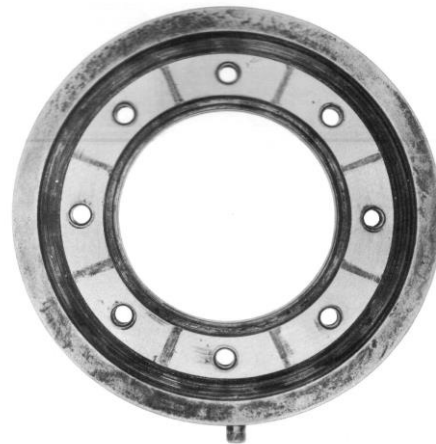

Damage from axial vibration.