

IMAGININGS





FACE BRICK

Endicott has a face brick to meet most any design criteria. A variety of colors, including authentic Ironspots and a wide selection of textures and sizes, provides the designer with an array of product selections.

FACE BRICK SIZES AND SPECIFICATIONS



MODULAR



ENGINEER MODULAR



CLOSURE
(Economy Modular)



NORMAN

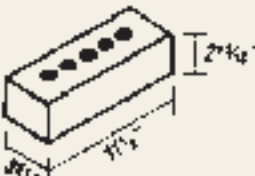

NORWEGIAN
(Engineer Norman)



3" UTILITY
(3" Bed Economy Norman)

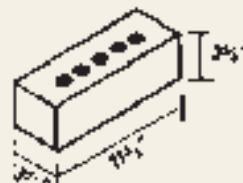

UTILITY
(Economy Norman)

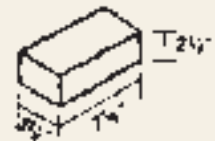

**DANISH
HAND MOULD**

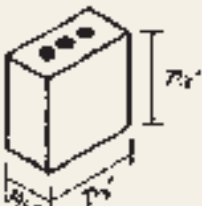

TRIPLE BRICK



KINGSIZE

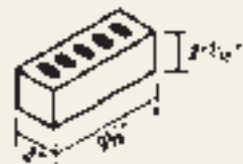

ENGINEER KINGSIZE

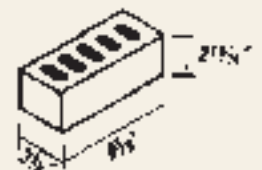

**FULL BED
ENGINEER KINGSIZE**

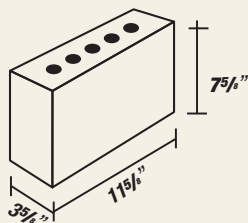

DOUBLE UTILITY

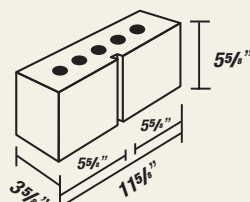

GIANT NORMAN
(Center Slot optional)

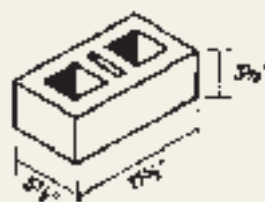

6" THRU WALL UNIT

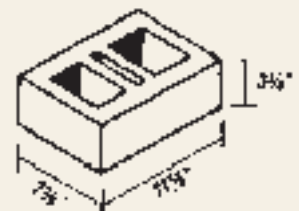

8" THRU WALL UNIT



SPECIAL SHAPES

Regardless of what's perceived in the mind's eye, Endicott possesses the ability to transform that image into an aesthetically beautiful shape of the highest quality. These shapes, available in colors, textures and sizes to match the face brick, create the benchmark for design flexibility.





POOL COPING

Applications for this unit are limited only by the imagination. In addition to swimming pools, other unique applications include step nosing and decorative accents on windows, fireplace mantels and hearths.

Pool coping units are available in colors to coordinate with Endicott pavers and tile.

ESTIMATING DATA

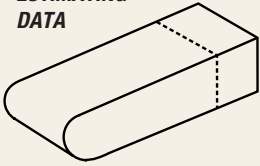

POOL COPING:

actual size – 2 1/4" x 3 5/8" x 9"
double bullnose – one end
metric size – 57 x 92 x 228
weight per unit – 6#
no. per linear ft. – 3

actual size – 2 1/4" x 3 5/8" x 11 5/8"
double bullnose – one end
metric size – 57 x 92 x 295
weight per unit – 7.5#
no. per linear ft. – 3

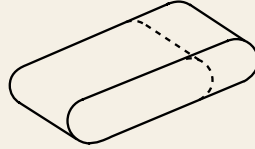

POOL COPING DOUBLE BULLNOSE:

actual size – 2 1/4" x 3 5/8" x 9"
metric size – 57 x 92 x 228
weight per unit – 6#
no. per linear ft. – 3

actual size – 2 1/4" x 3 5/8" x 11 5/8"
metric size – 57 x 92 x 295
weight per unit – 7.5#
no. per linear ft. – 3

PAVERS

Nationally recognized for their aesthetic beauty and durability, Endicott's complete line of brick pavers gracefully enhances any landscape setting and coordinates perfectly with Endicott's face brick, tile and pool coping units.

Endicott's relieved edge pavers feature beveled edges that make a unique visual presentation. The pavers are set hand-tight or butt joint. Beveled edges create a spaced joint effect yet are not grouted. Small spacings (1/16"-1/8") between units accommodate sand sweepings to keep the units apart and create interlock. They are manufactured to meet ASTM C902, Class SX, Type I, Application PX or ASTM C1272, Type R, Application PX specifications.



Private Residence – Lincoln, Nebraska
 Relieved Edge Pavers

PAVER SIZES AND SPECIFICATIONS

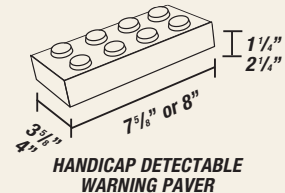
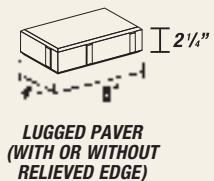
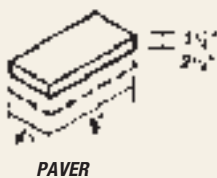
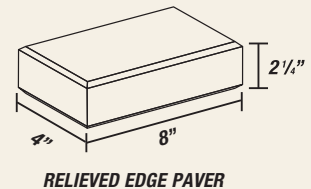
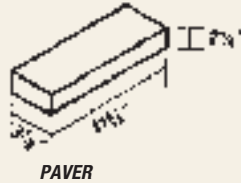
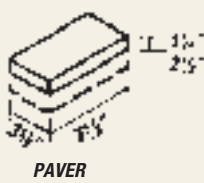
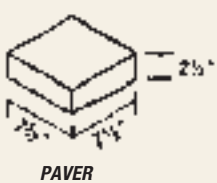



Liberty Plaza – Pittsburgh, Pennsylvania
Medium Ironspot #46 – 1/2" x 3 5/8" x 11 5/8" and Dark Ironspot – 1/2" x 3 5/8" x 11 5/8" accent

THIN BRICK

Endicott thin brick is ideally suited to year-round commercial, residential and remodeling applications.

Genuine kiln-fired thin brick possesses all the durability and unparalleled elegance of Endicott face brick, yet when installed maximizes space and weighs considerably less.

Whether it's new construction or a remodeling project, Endicott thin brick may be applied over any structurally sound substrate. And because no footings or supports are required, the thin brick may extend all the way to grade.

There are a number of prefabricated panel systems available to the industry that can receive the thin brick as factory or job site applied. Reputable installation suppliers have literature that you may obtain for review regarding project applicability.

Endicott thin brick has been tested according to ASTM-C1088 specifications and meets Type TBX requirements.

THIN BRICK SIZES AND TRIM UNITS

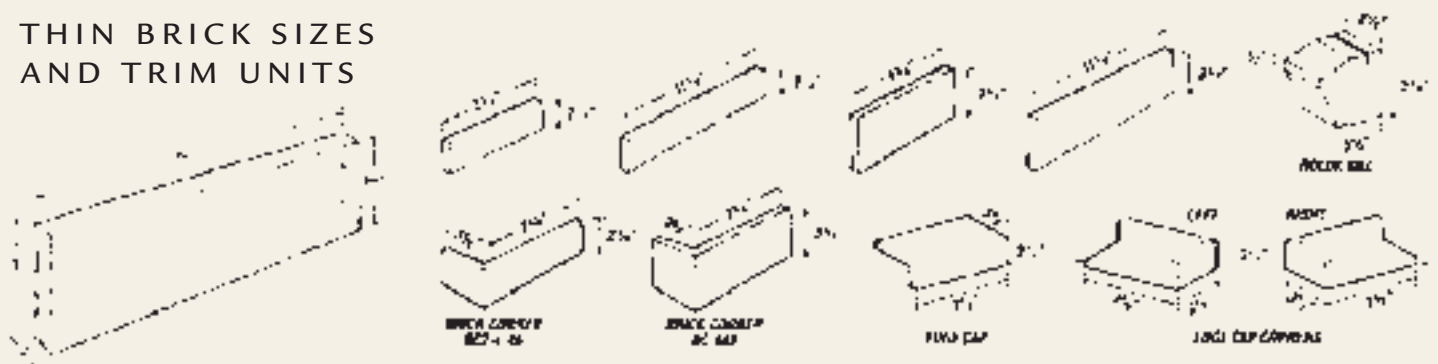

FACE BRICK AND THIN BRICK

Endicott provides you with a wide variety of colors and textures.
Face Brick colors are listed here and Thin Brick colors are identified with a **TB**.



RED HERITAGE – HERITAGE TEXTURE



ORLEANS SANDS – SAND TEXTURE



SAHARA SANDS – SAND TEXTURE



HERITAGE 46 – HERITAGE TEXTURE



DESERT SANDS – SAND TEXTURE



DARK IRONSPOT – SMOOTH TEXTURE

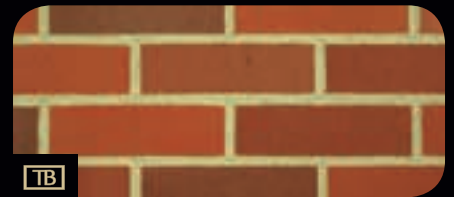

RED BLEND – SMOOTH TEXTURE



BURGUNDY SANDS – SAND TEXTURE



AUTUMN SANDS – SAND TEXTURE



BORDEAUX BLEND – VELOUR TEXTURE



MERLOT SANDS ANTIQUE –
ANTIQUE TEXTURE (FACE BRICK ONLY)

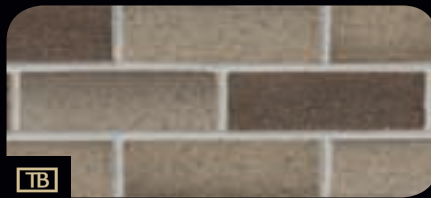

GREY SANDS – SAND TEXTURE



MEDIUM IRONSPOT #77 –
ARTISAN TEXTURE (FACE BRICK ONLY)

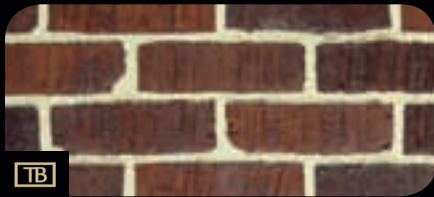

MEDIUM IRONSPOT #46 –
DANISH HAND MOULD (FACE BRICK ONLY)



MANGANESE IRONSPOT – VELOUR TEXTURE

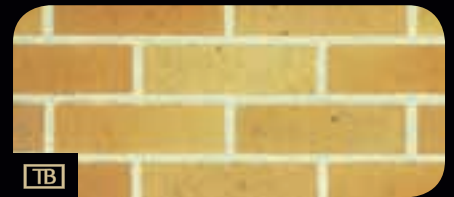

DESERT IRONSPOT (LIGHT) – SMOOTH TEXTURE

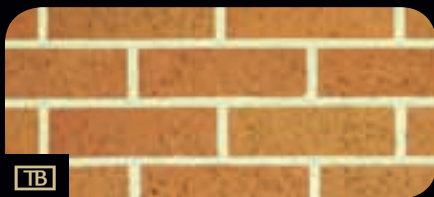

COPPERTONE – VELOUR TEXTURE

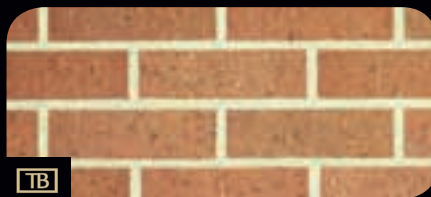

ROSE BLEND – VELOUR TEXTURE



GOLDEN BUFF – VELOUR TEXTURE

TILE



COPPERTONE



MEDIUM IRONSPOT #77



ROSE BLEND

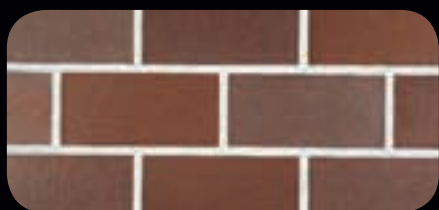

MEDIUM IRONSPOT #46

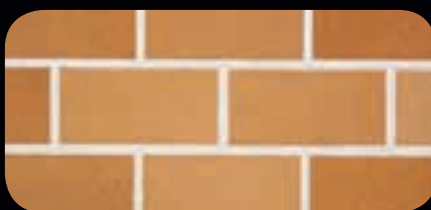

DESERT IRONSPOT (LIGHT)

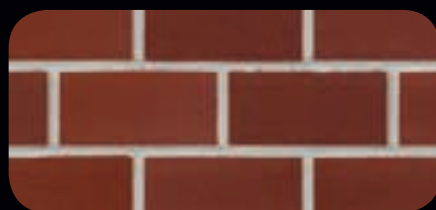

RED BLEND

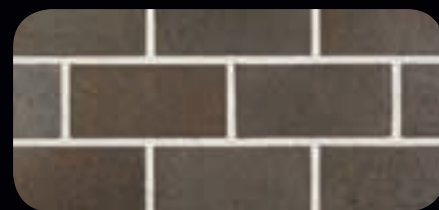

MANGANESE IRONSPOT

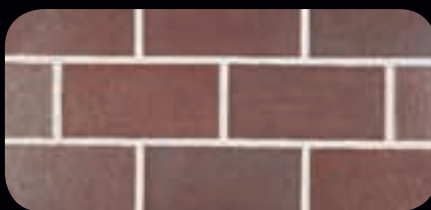

DARK IRONSPOT

AVAILABLE TEXTURES

FACE BRICK

Antique
Artisan
Danish Hand Mould
Matt (not shown)
Sand
Sand Heritage

Smooth
Velour
Velvetex (not shown)
Vertical Score (not shown)

THIN BRICK

Sand
Sand Heritage
Smooth
Velour
Wirecut

PAVERS

Wirecut

TILE TEXTURES



SMOOTH TEXTURE



WIRECUT TEXTURE

PAVERS (ALL WIRECUT TEXTURES)



ROSE BLEND



MEDIUM IRONSPOT #77



MANGANESE IRONSPOT



MEDIUM IRONSPOT #46



COPPERTONE



RED BLEND



BORDEAUX BLEND



DARK IRONSPOT

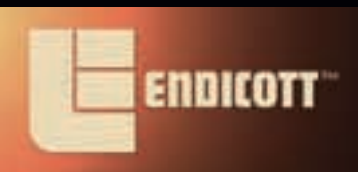

Endicott Clay Products Co.
P.O. Box 17
Fairbury, Nebraska USA 68352
402/729-3315 FAX: 402/729-5804

Endicott Tile LLC
P.O. Box 645
Fairbury, Nebraska USA 68352
402/729-3323 FAX: 402/729-5804

endicott@endicott.com
endicott.com



Try our new
Masonry Designer
and Virtual Mason
now at endicott.com