



## CONDAIR GS

Gas-fired steam humidifier  
Economic, high capacity humidification



Humidification and Evaporative Cooling

 **condair**

**Insulation**

Fully insulated water tank for energy efficient operation.

**Wide door**

Provides easy access to the water tank for maintenance.

**Heat exchanger**

The stainless steel heat exchanger has large flat surfaces that shed scale during operation, reducing maintenance and improving thermal efficiency.

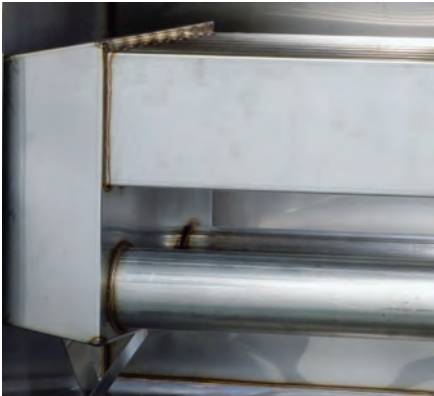

**Stainless steel water tank**

Quality construction provides a long and reliable operational lifetime.

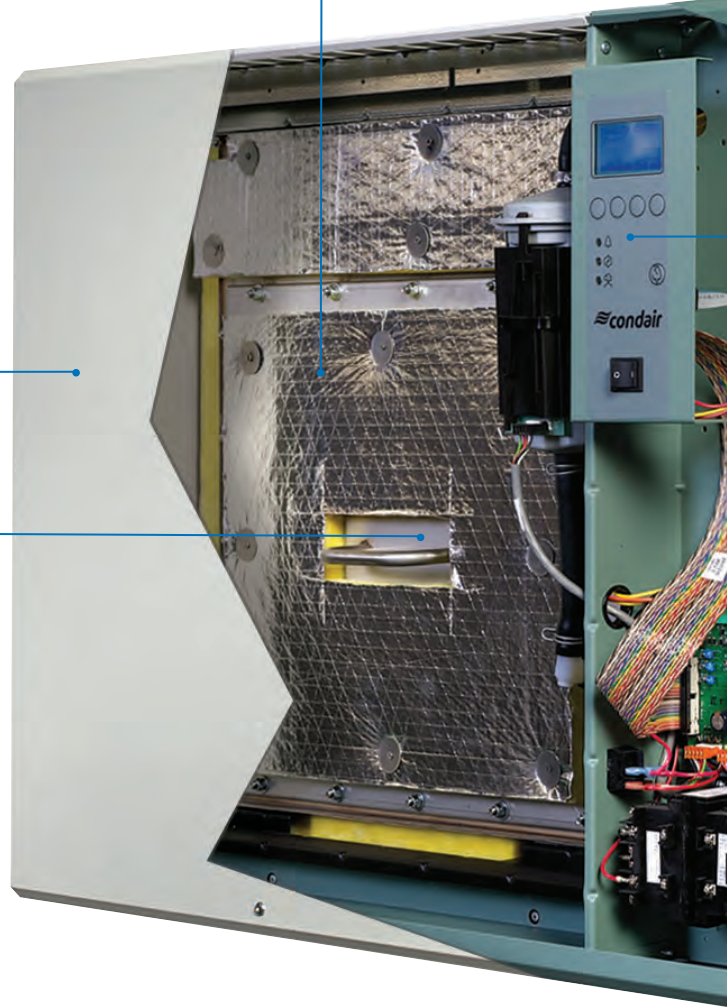

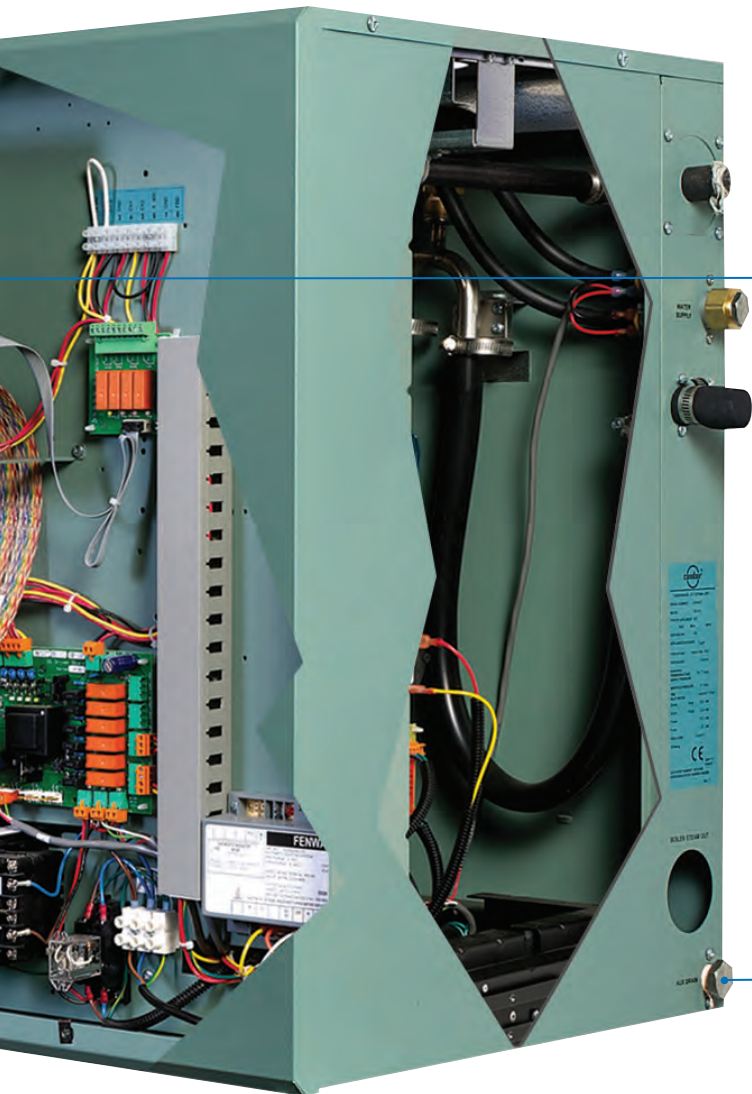

### Control panel

A keypad, digital backlit display and LED indicators make operating the humidifier simple. The display provides information on operational status, fault and maintenance requirements, trouble shooting guidelines and graphs illustrating historic performance and demand.

### 360° gas burner

Gas combustion occurs uniformly around the entire surface of the burner. This maximises thermal transfer to the heat exchanger resulting in thermal efficiency of over 90%.

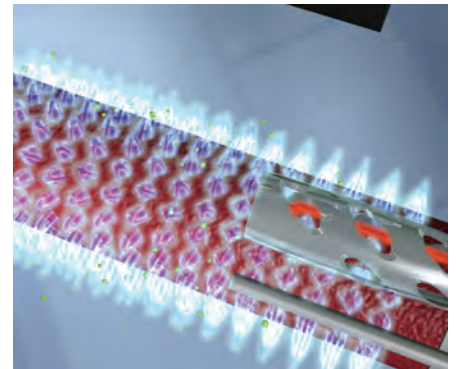

### Drain

Water temperature is tempered prior to draining to avoid stress on pipework.

The Condair GS gas-fired steam humidifier offers high capacity steam generation with the economy of using gas rather than electricity. Savings in

energy costs can result in rapid payback when replacing electric steam humidifiers.

The Condair GS has been designed to need minimal maintenance and, when

servicing is required, it is simple and straight forward.

Quality construction, state-of-the-art safety features, a user-friendly design and a variety of flexible options make the Condair GS the number one choice for gas-fired humidification.



Fast payback when replacing electric steam humidifiers

## The economy of gas

If you are using electric steam humidifiers, retrofitting gas-fired humidification can pay for itself within 1-2 years.

Humidification output (kg/h)

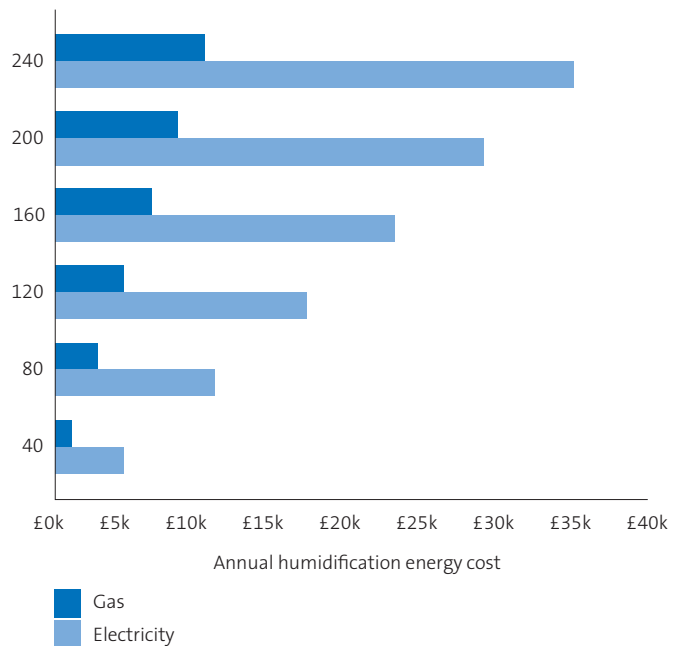

Based on full humidifier output for 2,400 hrs per year, gas at 3p/kWh and electricity at 9p/kWh.

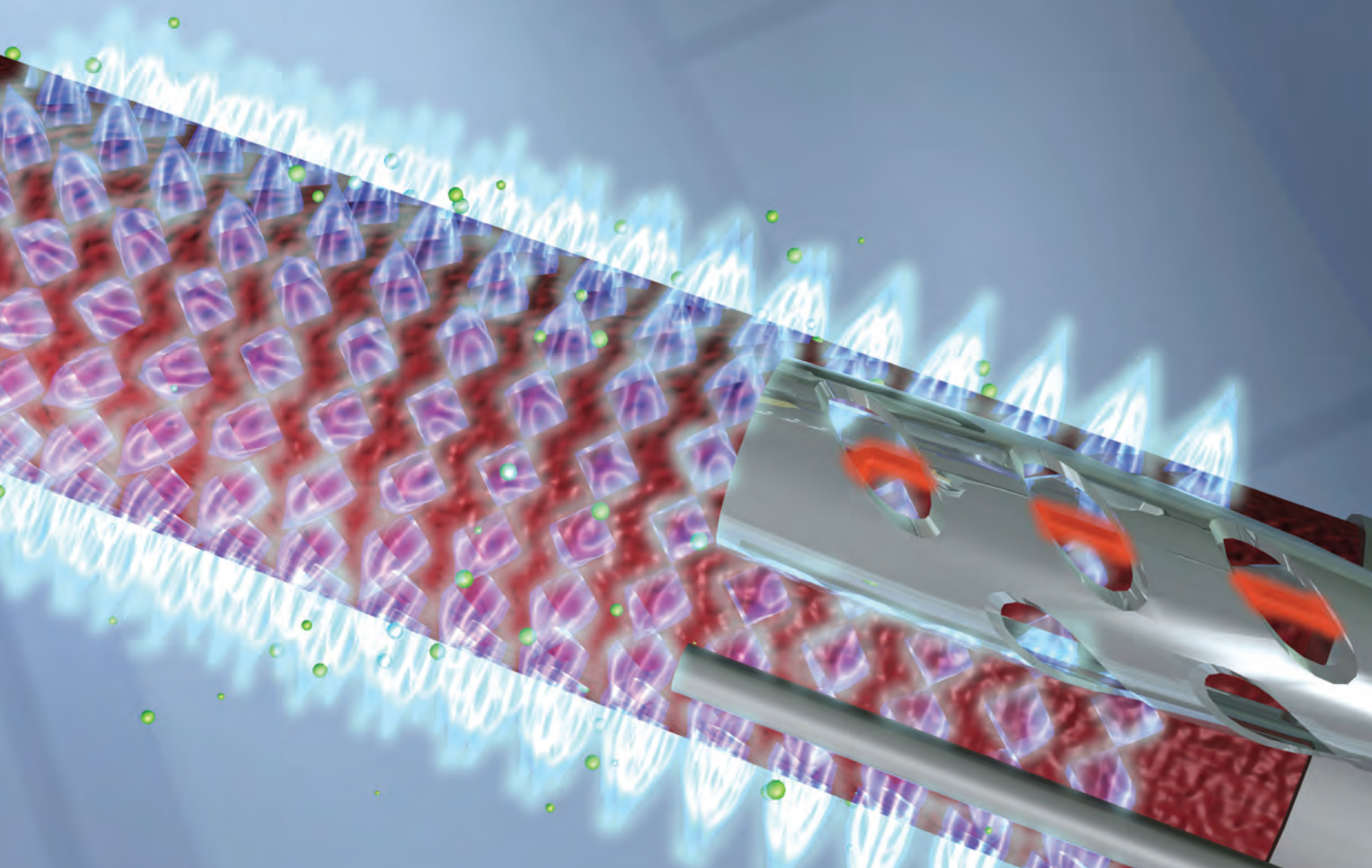

Advanced features make the Condaire GS the most efficient unit of its type on the market

## Industry leading technology

### **360° full circle burner**

The cylindrical burner in the Condaire GS has flame uniformly around its entire surface. This maximises the thermal transfer to the heat exchanger resulting in a thermal efficiency of over 90%.

The humidifier therefore reacts very quickly to a requirement for humidification whilst minimising gas consumption and emissions. Steam output can also be consistently controlled from outputs as low as 10kg/hr.

### **Low maintenance**

The stainless steel heat exchanger has large flat surfaces that dislodge scale during operation. This scale falls to the bottom of the water tank where it is either removed by the heavy-duty pumped drain or is emptied during servicing. The large flat surfaces of the

heat exchanger make it easy to remove what little scale is left behind. Also, as the heat exchanger remains mostly scale-free, the efficiency of heat transfer to the water is maximised.

### **Scale management**

To reduce scale build-up in the boiling chamber, a low volume of fresh water is continually added and high mineral content water removed. This not only decreases scale build-up but improves humidity control when compared to other gas-fired humidifiers, which occasionally stop steam production and run a complete tank drain to combat scale.

Before being sent to drain, waste water is cooled to minimise stress on pipework.



Modern building management based on integrated technology. By using **e-LINKS**, communication with the humidification system is simple, quick and clear.

## In control

### **BMS connectivity**

The humidifier has an option to be operated from a BMS and accepts Modbus Standard, BACnet or LonWorks protocols.

### **On-board controller**

The Condair GS incorporates a state-of-the-art controller with a backlit LCD display. It has a continuous self-diagnostic feature with self-correction and fail-safe operation. An on-screen trouble shooting feature walks the user through corrective processes that can avoid the expense of an engineer call-out.

Other features include on-screen indication of service and fault history as well as humidity demand trends.

Up to ten Condair GS humidifiers can be chained together providing a huge potential output of up to 2,400kg/hr.

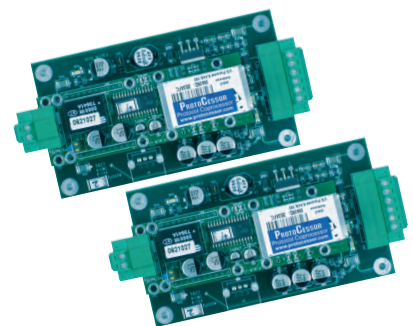

**e-LINKS**  
for connection to a BMS



With three different models, the Condair GS range provides comprehensive design alternatives

## Comprehensive range

The Condair GS is available in six sizes from 40-240kg/hr and in three different models.



**Condair GS**  
Room air dependent model uses air for combustion from the room



**Condair GS RS**  
Room air independent model can draw air for combustion from an external source



**Condair GS OC**  
Outdoor unit with an all-weather enclosure and anti-freeze protection



**RO water filter**  
The PureFlo RO water filter removes 95% of minerals from supply water to reduce scale build-up and maintenance

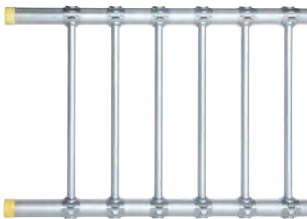

**Condair OptiSorp**  
Rapid evaporation steam distribution manifold for short absorption distances inside an AHU



**Stand**  
For use with the indoor GS and GS RS models

## Standard system

- Stainless steel heat exchanger
- 360° full circle burner
- Internal PI humidity controller
- Control panel with LCD display
- Self diagnostic system
- Stand for internal room units

## Accessories

- 1 Steam distribution
- 2 Steam hose
- 3 Condensate hose
- 4 Flue

## Options

- e-LINKS for BMS connection
- OptiSorp rapid steam distribution manifold
- Pressure compensation to 10,000Pa
- PureFlo reverse osmosis water filter
- Humidity sensors and humidistats

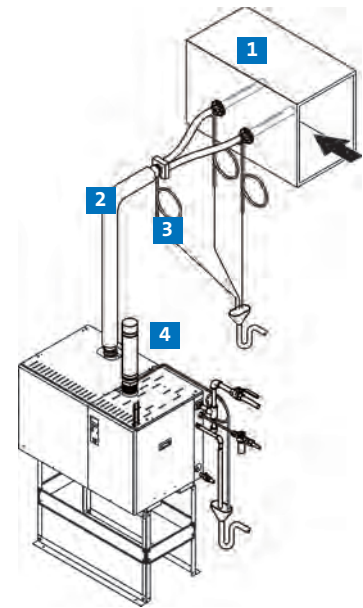

## Technical data

Max. steam output	kg/h	40	80	120	160	200	240
Gas consumption	kW	36.5	73.0	109.5	146.0	182.5	219.0
Gas types	Natural gas, G13, G20, G25, G30, G37, G50 or propane gas G31						
Admissible duct air pressure	-800...+1700Pa						
Water quality	Untreated drinking water or demineralised						

Condair GS (room air dependent), Condair GS RS (room air independent)

Width / height	mm	1140/810					
Depth	mm	530	690	1090	1090	1490	1490

Condair GC-OC (outdoor unit)

Width / height	mm	1262/1380					
Depth	mm	545	708	1104	1104	1500	1500
Conformities	CE, VDE, GOST, DVGW						