

ICS429

Weighing terminals Terminal and platform combinations

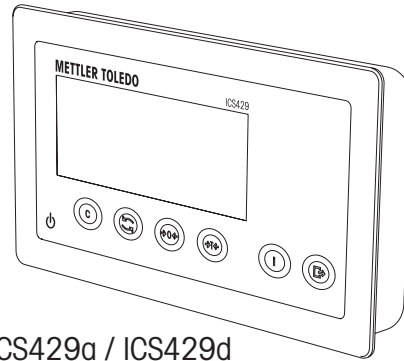

ICS429a / ICS429d

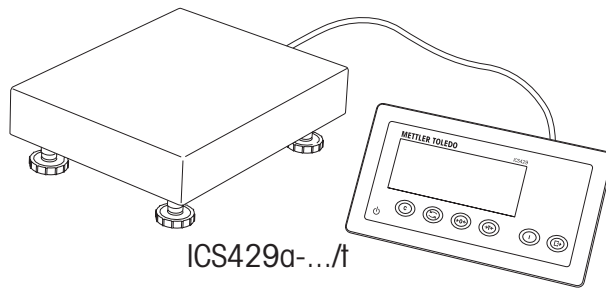

ICS429a-.../t

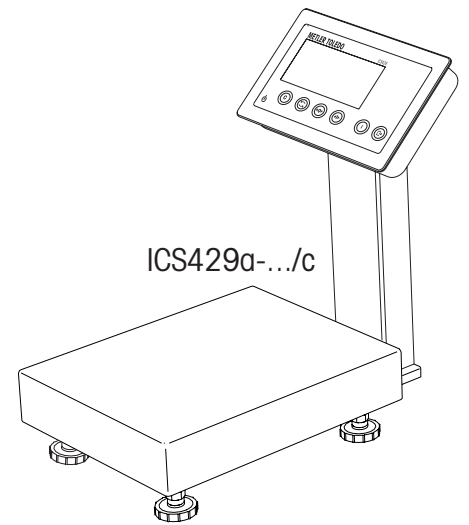

ICS429a-.../c

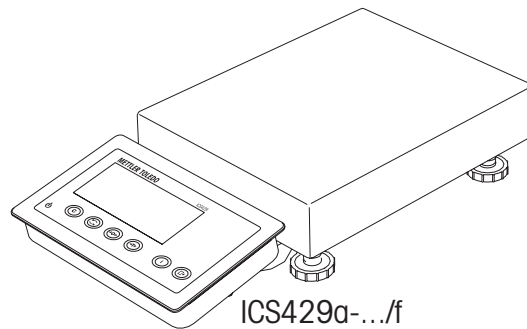

ICS429a-.../f

ServiceXXL

Tailored Services

Congratulations on choosing the quality and precision of METTLER TOLEDO. Proper use according to these instructions and regular calibration and maintenance by our factory-trained service team ensure dependable and accurate operation to protect your investment. Contact us about a ServiceXXL agreement tailored to your needs and budget.

We invite you to register your product at

www.mt.com/productregistration

so we can contact you about enhancements, updates and important notifications concerning your METTLER TOLEDO product.

Contents

1	Introduction.....	4
1.1	Safety instructions	4
1.2	Presentation.....	5
1.3	Commissioning	12
1.4	Use in hygienically sensitive areas.....	14
2	Operation.....	15
2.1	Switching on and off.....	15
2.2	Zeroing / Zero point correction.....	15
2.3	Simple weighing.....	15
2.4	Weighing with tare.....	16
2.5	Displaying the capacity available	17
2.6	Average (dynamic) weighing.....	18
2.7	Working with identifications.....	18
2.8	Printing results	19
2.9	Displaying information	19
2.10	Environment and cleaning	20
2.11	Verification test.....	22
3	Settings in the menu.....	23
3.1	Operating the menu	23
3.2	Scale menu block – analog scales	26
3.3	Scale menu block – IDNet scales	29
3.4	Application menu block.....	32
3.5	Terminal menu block.....	33
3.6	Communication menu block.....	36
3.7	Maintenance menu block.....	44
4	Event and error messages.....	45
4.1	Error conditions	45
4.2	Errors and warnings.....	46
4.3	Smart weighing counter / spanner icon	47
5	Technical data and accessories.....	48
5.1	Technical data weighing terminal	48
5.2	Technical data of weighing platforms.....	50
5.3	Accessories.....	53
6	Appendix	55
6.1	Notice for verified instruments in EC countries.....	55
6.2	Disposal.....	55
6.3	Tables of Geo Code values.....	56
6.4	Protocol printouts	57
6.5	Index.....	58

1 Introduction

1.1 Safety instructions



General

- ▲ Do not use the device in an hazardous environment! Special devices are available in our range of products for hazardous environments.
- ▲ The safety of the device cannot be ensured if it is not operated in accordance with these operating instructions.
- ▲ Only authorised personnel may open the device.



Devices with built-in power supply unit

- ▲ Ensure that the power socket outlet for the device is earthed and easily accessible, so that it can be de-energised rapidly in emergencies.
- ▲ Ensure that the supply voltage at the installation site lies within the range of 100 V to 240 V.
- ▲ Check the power cable regularly for damage. If it is damaged, immediately disconnect the device from the power supply.
- ▲ Ensure that there is a space of at least 3 cm at the rear in order to prevent the power cable from being bent too strongly.



Devices with built-in storage battery

- ▲ Do not use the battery charger in humid or dusty rooms or below 0°C (32 °F) ambient temperature. After the built-in storage battery has been charged, the cover cap of the charging socket at the device must be closed.



Terminal and platform combinations

- ▲ The maximum static safe load must never be exceeded. Observe the operation limits, see Technical data.
- ▲ Avoid falling loads, shock loads as well as impacts from the side.

1.2

Presentation

1.2.1

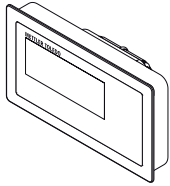

Weighing terminals

There are two versions of the ICS429 weighing terminal:

ICS429a with analog scale interface:

to connect analog METTLER TOLEDO weighing platforms

ICS429d with digital scale interface:

to connect METTLER TOLEDO weighing platforms with IDNet interface

On the rear the weighing terminal is equipped with a swivel bracket for mounting the terminal on the wall or to a METTLER TOLEDO column. As an accessory a table stand for setting up the terminal on the table is available.

1.2.2

Terminal and platform combinations

The complete name of a terminal and platform combination also indicates the type, size and capacity of the connected analog weighing platform. E.g., ICS429a-QA6/c stands for

ICS429a type of weighing terminal and type of weighing interface

QA design and size of the weighing platform

6 weighing platform capacity in kg

c mechanical design

By default the weighing platforms are equipped with an aluminium load cell and a readability setting of 3000 or 5000 divisions, non-approved.

ICS429a-.../f

The weighing terminal is fixed to the front of the weighing platform.

Terminal and platform can be handled as one unit, easy to install and to change the location. The perfect solution if a stand or a bracket would hinder an effective working process.

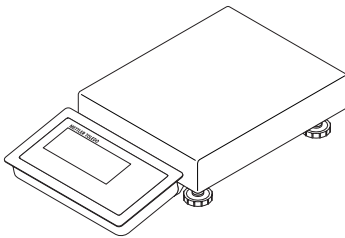

ICS429a-.../t

Weighing terminal and weighing platform are connected by cable.

Suitable for wall mount operation and desk operation with an additional desk mounting plate, see Options. The combination can be upgraded with a stand, see Accessories.

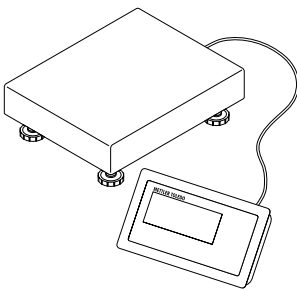

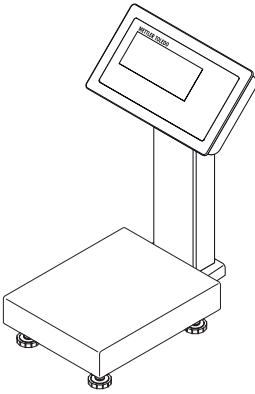

ICS429a-.../c

Hygienic optimal version. Weighing terminal and column are seamlessly welded together. Easy to clean, cables run inside the column.

1.2.3

Options

The following options are available for the ICS429:

Weighing terminal

- Built-in storage battery
- One additional communication interface
 - RS232
 - RS422/RS485
 - Ethernet interface
 - USB device interface
 - Digital I/O (4 Inputs and 4 Outputs)
- Desk mounting plate

Terminal and platform combinations

- Load cells for more challenging environments
 - Standard: aluminium load cell (identical to PBA226 with hygienic kit)
 - Option: potted stainless steel load cell (identical to PBA426 with hygienic kit)
 - Option: hermetically sealed stainless steel load cell (identical to PBA429 with hygienic kit)
- Other resolutions (availability depending on region, weighing unit and Weights and Measures approval)
 - Verification OIML Class III, 1 x 3,000 e
 - 6,000 d (non-approvable)
 - 10,000 d (non-approvable)
 - 15,000 d (non-approvable)

Metrological data line

In the metrological data line the following information is displayed:

Symbol	Information	Remark
	Accuracy classes	Displayed only if the scale is approved according to the Weights and Measures guidelines
W1 , W2 , W3	Weighing range information	For multi range devices only, displayed only if the scale is approved according to the Weights and Measures guidelines
Max. , cap	Maximum capacity	
Min	Minimum capacity	Displayed only if the scale is approved according to the OIML Weights and Measures guidelines
e =	Approved resolution	OIML: Displayed only if the scale is approved NTEP: Displayed only if the scale is approved and d is different from e
d =	Display resolution	OIML: Displayed only if the scale is not approved or if d is different from e NTEP: Displayed always
Approved scale	Approved weighing device	Metrology display disabled, Weights and Measures data must be indicated on a label near the weight display





Weight display

The weight value can be marked with the following symbols:

Symbol	Information	Remark
*	Calculated weight value	E.g. for average weighing results
–	Sign	For negative weight values
○	Stability monitor	For unstable weight values
1.234₃ kg	Non-approved last digit with $e > d$	For approved scales only The example shows the weight value for a scale with $e = 1 \text{ g}$ and $d = 0.1 \text{ g}$ The last, smaller digit is not approved

Symbols and info line

In the symbols and info line the following information may be displayed:

Symbol	Information	Remark
<-> 1	Weighing range	For multi range or multi interval scales only
	Weight below minimum weight	MinWeigh must be activated in the menu
	Average weighing	Average must be activated in the menu
	Automatic taring	Auto Tare must be activated in the menu
	Automatic clearing of the tare weight	A-Clear Tare must be activated in the menu
>0<	Center of zero indication	Availability depending on local Weights and Measures regulations

Device information

ICS429 offers the possibility to configure the following device information to identify the device according to your company's naming conventions:

- Device identifier
- Device location

In addition Device name provides the complete type information already entered in the factory, e.g., ICS429a-A15/t

This device information can be used as follows:

- displayed in the auxiliary line of the display
- displayed via **i**
- printed/transferred together with the weight value

→ Please ask the METTLER TOLEDO service technician to configure Device identifier and Device location according to your specific requirements.

1.2.5

Keyboard



Key	Name	Function in the operating mode	Function in the menu
	Power	<ul style="list-style-type: none"> Switch on and off Cancel editing 	<ul style="list-style-type: none"> Cancel editing Exit menu
	Clear	<ul style="list-style-type: none"> Clear tare Leave info page 	<ul style="list-style-type: none"> Clear value, clear digit
	Switch	<ul style="list-style-type: none"> Switch over weight unit 	<ul style="list-style-type: none"> In numeric entries: to the next digit to the right Re-edit
	Zero	<ul style="list-style-type: none"> Set scale to zero, clear tare 	<ul style="list-style-type: none"> Scroll up In numeric entries: increment value
	Tare	<ul style="list-style-type: none"> Tare scale, clear tare 	<ul style="list-style-type: none"> Scroll down In numeric entries: decrement value
	Info	<ul style="list-style-type: none"> Activate info screen Proceed to next info line / info page Freeze and release startup screen 	<ul style="list-style-type: none"> To the next higher menu level (scroll left) In numeric entries: to the next digit to the left
	Transfer	<ul style="list-style-type: none"> Transfer data to a printer or computer Press and hold key: Call up menu 	<ul style="list-style-type: none"> Enter menu item (scroll right) Confirm entry / selection

1.2.6

Connections

Weighing terminal only, ICS429a-.../f, ICS429a-.../t

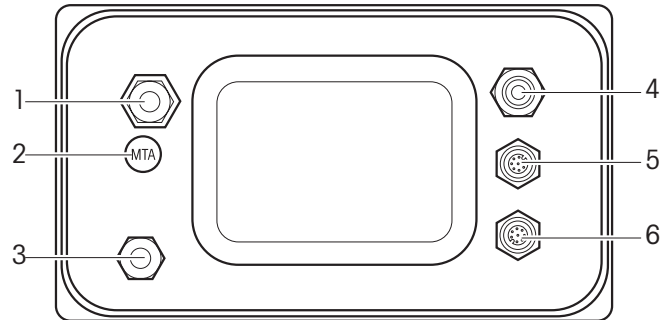

- 1 Weighing platform connection
- 2 Verification securing seal
- 3 Pressure compensation
- 4 AC power supply or battery charging
- 5 Standard interface COM1 (RS232)
- 6 Optional interface COM2

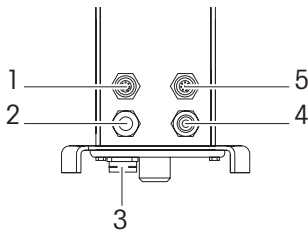

ICS429a-.../c

- 1 Optional interface COM2
- 2 Weighing platform connection
- 3 Pressure compensation
- 4 AC power supply or battery charging
- 5 Standard interface COM1 (RS232)

Note

The verification securing seal is applied on the weighing terminal as described in the section above.

1.3

Commissioning

1.3.1

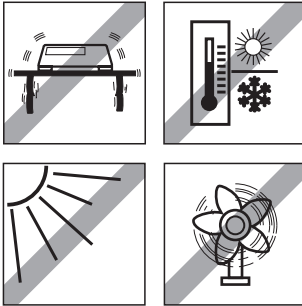

Selecting the weighing platform location

The correct location is crucial to the accuracy of the weighing results.

- Select a stable, vibration-free and if possible a horizontal location for the weighing platform.
 - The ground must be able to safely bear the weight of the fully loaded weighing platform.
- Observe the following environmental conditions:
 - No direct sunlight
 - No strong drafts
 - No excessive temperature fluctuations

1.3.2

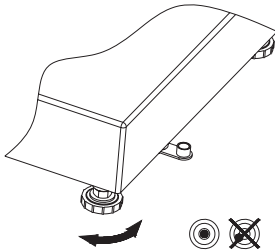

Levelling the weighing platform

Only weighing platforms that have been levelled precisely horizontally provide accurate weighing results. Weights and Measures approved weighing platforms have a spirit level to simplify levelling.

1. Turn the adjustable feet of the weighing platform until the spirit level's air bubble is inside the inner circle.
2. Tighten the lock nuts of the adjustable feet.

1.3.3

Weighing platform connection and interface commissioning

The weighing platform connection to the weighing terminal as well as the commissioning of the interfaces are described in the ICS4x9 installation instructions.

- Call the METTLER TOLEDO service technician or carry out commissioning in accordance with the installation instructions.

1.3.4



Power supply connection

CAUTION

Risk of electric shock!

- ▲ Before connecting the power supply, check whether the voltage value printed on the rating plate corresponds to your local system voltage.
- ▲ Do not under any circumstances connect the device if the voltage value on the rating plate deviates from the local system voltage.
- ▲ Make sure the weighing platform has reached room temperature before switching on the power supply.

- Plug the power plug into the power socket.
 - After it has been connected, the device runs a self-test. The device is ready to operate when zero appears on the display.

1.3.5

Handling of the built-in storage battery

Note the following when operating a device with a built-in storage battery:



- The operating life depends on the intensity of use, the configuration and the connected scale. For details see the technical data.
- The battery symbol shows the current state of charge of the storage battery.
 - One segment corresponds to approx. 25 % capacity.
 - If the symbol flashes, the storage battery has to be charged. A message is displayed, too.
 - During charging the segments are "running" until the battery is fully charged and all segments light up continuously.
- The charging time of the storage battery amounts to approx. 6 hours. If work is continued during the charging process, the charging time is extended.
- The storage battery is protected against overcharging.
- The storage battery has a service life of approx. 2 years or 500 to 1,000 charging/discharging cycles.
- The storage battery is also suitable for permanent mains operation.



CAUTION

Danger of soiling because the charger for the storage battery is not protected to IP69K!

- ▲ Do not charge the device in humid or dusty rooms.
- ▲ After the storage battery has been charged, close the cover cap of the charging socket at the device.



CAUTION

No success in charging the storage battery due to low temperatures!

- ▲ Do not charge the battery if the battery temperature is below 0 °C (32 °F). Charging is not possible in this temperature range.
- ▲ Do not operate the battery charger outside its temperature range of 0 °C to 40 °C (32 °F to 104 °F).

Recommended use of the built-in storage battery

The characteristics mentioned above are only valid if the following recommendations are observed:

- Connect the device to the battery charger as soon as the warning message "Low battery" appears and the battery symbol starts flashing. When the message appears you still have enough time (at least 10 minutes) to complete your current task.
- Keep the battery charger connected until the charging process is completed, i.e., all segments of the battery symbol light up continuously.
- For optimum battery performance operate the device with built-in storage battery at an ambient temperature in the range of 10 °C to 30 °C (50 °F to 86 °F). This applies to discharging as well as charging the battery.
- If you plan to put the scale out of operation for a longer period charge the battery completely.
- Even if you do not use the instrument, charge the battery at least every 3 months to avoid deep discharge.

1.4

Use in hygienically sensitive areas

The device is easy to clean and is designed to be used in the food industry.

Features

- Terminal housing and load plate made of stainless steel
- No open threads
- No screws with recesses
- Keypad made of PET with a smooth surface
- Reduced horizontal surfaces
- Continuous welding seams



The standard load cell is made of aluminium. As an option, stainless steel load cells are available.

2 Operation

2.1 Switching on and off

Switching on → Press .

For a few seconds, the device shows a start-up screen with device name, software version, serial number of the weighing terminal and the Geo value (only if an analog weighing device is connected).



You can freeze the start-up screen by pressing **i**.

Switching off → Press .

Before the display goes out, **-OFF-** appears briefly.

2.2 Zeroing / Zero point correction

Zeroing corrects the influence of slight changes on the load plate or minor deviations from the zero point.

Manual

1. Unload scale.
2. Press **→0←**.
Zero appears in the display.

Automatic In the case of non-verified scales, the automatic zero point correction can be deactivated in the menu or the zero range can be changed. Approved scales are set fixed to 0.5 d. As standard, the zero point of the scale is automatically corrected when the scale is unloaded.



- The zero function is only available within a limited weighing range.
- After zeroing the scale, the whole weighing range is still available.
- A successful zeroing will always delete a tare weight.

2.3 Simple weighing

1. Place weighing sample on the scale.
2. Wait until the stability monitor  goes out.
3. Read the weighing result.

2.4 Weighing with tare

2.4.1 Taring

- Place the empty container on the scale and press **→T←**.
The zero display and the symbol **NET** appear.
The tare weight remains stored until it is cleared.

2.4.2 Clearing the tare

- Press **C**.

The symbol **NET** goes out, the gross weight appears in the display.



If the symbol  is lighting, i.e., the `A-Clear Tare` function is activated in the menu under `Scale -> Tare`, the tare weight is automatically cleared as soon as the scale is unloaded.

2.4.3 Automatic clearing of the tare

A tare weight is automatically cleared when the scale is unloaded.

Prerequisite

- ✓ The symbol  lights in the display, i.e., the tare function `A-Clear Tare` is activated in the menu under `Scale -> Tare`.

2.4.4 Automatic taring

If you place a weight on an empty scale, the scale tares automatically and the symbol **NET** is displayed.

Prerequisite

- ✓ The symbol  lights in the display, i.e., the tare function `Auto Tare` is activated in the menu under `Scale -> Tare`.



The weight to be tared automatically, e.g., packaging material, must be heavier than 9 display steps of the scale.

2.4.5

Chain tare

With this function it is possible to tare several times if, e.g., cardboard is placed between individual layers in a container.

Prerequisite

✓ The tare function `Chain tare` is activated in the menu under `Scale -> Tare`.

1. Place the first container or packaging material on the scale and press **→T←**.
The packaging weight is automatically saved as the tare weight, the zero display and the symbol **NET** appear.
2. Weigh the weighing sample and read/print out the result.
3. Place the second container or packaging material on the scale and press **→T←** again.
The total weight on the scale is saved as the new tare weight. The zero display appears.
4. Weigh the weighing sample in the second container and read/print the result.
5. Repeat steps 3 and 4 for other containers.

2.4.6

Tare preset

If you know the weight of your containers, you can enter the tare weight via barcode or SICS command. Thus you do not have to tare the empty container.

Prerequisite

✓ For barcode use `Tare preset` is selected as destination for external input.

1. Enter the known tare weight via barcode or SICS command.
The weight display shows the negative tare weight and the symbol **NET** appears.
2. Place the full container on the weighing platform.
The net weight is displayed.



The entered tare weight is valid until a new tare weight is entered or the tare weight is cleared.

2.5

Displaying the capacity available



The terminal provides a graphic display of the scale capacity available.

The bargraph indicates how many per cent of the scale capacity is already occupied and what capacity is still available.

In the example, approx. 65 % of the scale capacity is occupied.

2.6 Average (dynamic) weighing

With the average weighing function, it is possible to weigh restless weighing samples such as living animals. If this function is activated,  is displayed in the info line.

With average weighing, the scale calculates the mean value from 56 weighing operations within 4 seconds.

With manual start

- ✓ Average -> Manual is selected in the menu.
- ✓ The weighing sample must be heavier than 9 scale divisions.

1. Place the weighing sample on the scale.
2. Press  to start average weighing.
3. During average weighing, stars appear in the display, and the average result will be displayed with the symbol *.
4. Unload the scale to be able to start a new average weighing operation.

With automatic start

- ✓ Average -> Auto is selected in the menu.
- ✓ The weighing sample must be heavier than 9 scale divisions.

1. Place the weighing sample on the scale.
Average weighing is started automatically.
During average weighing, stars appear in the display, and the average result will be displayed with the symbol *.
2. Unload the scale to be able to perform a new average weighing operation.

2.7 Working with identifications

Weighing series can be assigned 2 identification numbers ID1 and ID2 with up to 40 characters that are also printed out in the protocols. If, e.g., a customer number and an article number are assigned, it can be clearly seen in the protocol which article was weighed for which customer.

Barcode use (for one identification only)

- ✓ ID1 or ID2 is selected as destination for external input.
- ✓ To display the identification ID1 or ID2 is activated in the auxiliary line.

Using SICS command set (one or two identifications)

- ✓ To display the identification(s) ID1 and/or ID2 are activated in the auxiliary line.

2.8 Printing results

If a printer or computer is connected, weighing results and other information can be printed out or transferred to a computer.

→ Press **☞**.

The defined data is printed out or transferred to the computer.



The printout content can be defined in the `Templates` menu.

2.9 Displaying information

Up to 10 different values for display can be configured in the menu for the info key. Depending on the configuration in the menu `Terminal -> Device -> Keyboard -> Info key`, the following data can be assigned in a free order, e.g.:

- Date & Time
- Weight values
- Identifications
- Device information

1. Press **i**.

The (first) info screen is displayed.

2. Press **i** again.

With one info screen only, the weight display appears.

With several info screens, the next info screen is displayed.

3. With several info screens, press **C** to leave the info screens.



An info screen is displayed until **i** is pressed again or **C** is pressed.

2.10 Environment and cleaning

2.10.1 Overview

The devices are designed to be used in a wet environment. Depending on the environment and the cleaning procedures, we suggest weighing platforms with different types of load cells. The following table gives you a detailed overview about recommended environment and suitable cleaning procedures.

	Terminal	Weighing platform		
	ICS429a ICS429d	Standard version potted aluminium load cell	Option potted stainless steel load cell	Option hermetically sealed stainless steel load cell
IP rating	IP68/IP69k	IP65	IP65/IP67	IP68/IP69k
Environment				
Short time wet (30 min / day)	✓	✓	✓	✓
Part time wet (120 min / day)	✓	–	✓	✓
Permanently wet	✓	–	–	✓
Cleaning procedure				
Wet wipe down	✓	✓	✓	✓
Light hose down < 5 l / min, 20 kPa	✓	✓	✓	✓
Light wash down < 12.5 l / min, 30 kPa	✓	–	✓	✓
Heavy wash down high pressure water and steam jet up to 10000 kPa	✓	–	–	✓
Cleaning detergents				
Mild detergents	✓	✓	✓	✓
Other detergents in accordance with the manufacturer's specifications and instructions	✓	–	✓	✓

2.10.2



General cleaning recommendations

Danger of electric shock

- ▲ Before cleaning, unplug the power plug in order to disconnect the terminal from the power supply.
 - ▲ Cover open connectors with cap plugs.
-
- Clean the protective cover separately. The protective hood is dishwasher-safe.
 - Replace the protective hood regularly.
 - Take off the load plate and remove any dirt and foreign substances which may have collected underneath. Do not use any hard objects to do so.
 - Do not disassemble the weighing device.
 - Remove any possibly remaining detergent by rinsing with clear water.
 - To prolong the lifetime of the load cell, dry it with a soft lint-free cloth immediately after cleaning.
 - Observe all the existing regulations on cleaning intervals and permissible cleaning agents.

Cleaning of different weighing platforms as described in this User manual

- Make sure to observe the cleaning instructions for the connected weighing platform. The weighing platform may not be designed for wet environments and the cleaning procedures described above.

2.11

Verification test

The weighing instrument is verified if

- the accuracy class is displayed in the metrological line,
- the securing seal is not tampered with,
- it bears an official verification mark, e.g., the green M sticker (OIML),
- the validity is not expired.

The weighing instrument is also verified if

- the metrological line shows "Approved scale",
- labels with the metrological data are placed near the weight display,
- the securing seal is not tampered with,
- it bears an official verification mark, e.g., the green M sticker (OIML),
- the validity is not expired.



The period of validity is country-specific. It is in the responsibility of the owner to renew verification in due time.

Terminal and platform combinations

Combinations of a weighing terminal and an analog weighing platform use a Geo Code to compensate for gravitational influence.

The manufacturer of the weighing instrument uses a defined Geo Code value for verification.

- ➔ Please check if the Geo Code in the instrument corresponds with the Geo Code value defined for your location.

The Geo Code value is displayed when you switch on the instrument.

The Geo Code for your location is shown in the Appendix.

- ➔ Call the METTLER TOLEDO service technician if the Geo Code values do not match.

3 Settings in the menu

In the menu, settings can be changed and functions can be activated. This enables adaptation to individual weighing requirements.

The menu consists of the following 5 main blocks containing various submenus on several levels.



Scale	see section 3.2 (analog scales) or 3.3 (IDNet scales)
Application	see section 3.4
Terminal	see section 3.5
Communication	see section 3.6
Maintenance	see section 3.7

3.1 Operating the menu



3.1.1 Calling up the menu and entering the password

The menu has 2 different operating levels: Operator and Supervisor. The Supervisor level can be protected by a password. When the device is delivered, both levels are accessible without a password.

Operator menu

1. Press  and keep it pressed until `Enter code` appears.
2. Press  again.
The menu item `Terminal` is displayed. Only parts of the submenu `Device` are accessible.

Supervisor menu

1. Press  and keep it pressed until `Enter code` appears.
2. Enter the password and confirm with .

The first menu item `Scale` is highlighted.



No supervisor password has been defined when the device is first delivered. Therefore, confirm the password inquiry with  when you call up the menu for the first time. If a password has still not been entered after a few seconds, the scale returns to the weighing mode.

Emergency password for Supervisor access to the menu

If a password has been issued for Supervisor access to the menu and you have forgotten it, you can still enter the menu:

→ Press **→0←** 3 times and confirm with .

3.1.2 Display presentation in the menu

Menu items are displayed together with their context. The following example shows the menu start screen.

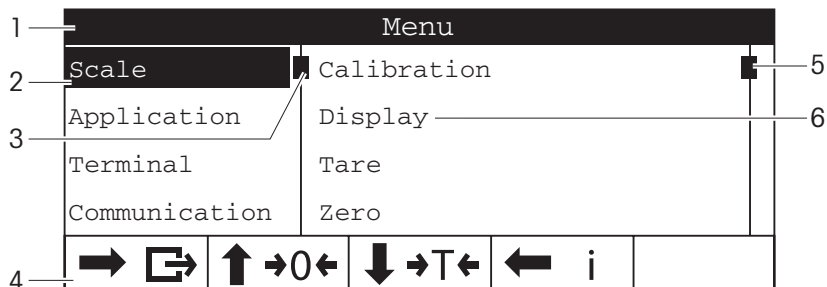

- 1 Menu info line, i.e., menu path of the current menu item
- 2 Menu items, the selected menu item is highlighted
- 3 Scroll flag (left), like the scroll bar of your PC
- 4 Navigation info line
- 5 Scroll flag (right), like the scroll bar of your PC
- 6 Sub-menu items

3.1.3 Numeric entry in the menu, e.g., date

Numeric entry

1. Change the highlighted number using $\rightarrow 0 \leftarrow$ to increment or $\rightarrow T \leftarrow$ to decrement.
2. Press $\rightarrow \leftarrow$ to move to the next place.
3. Repeat steps 1 and 2 until all places are set.
4. Confirm entry with $\rightarrow \leftarrow$.

3.1.4 Exiting the menu

1. Press $\rightarrow \leftarrow$.
The last menu item `End` appears. "Save settings ?" is displayed.
2. Press **OK**.
The menu changes are saved and the terminal returns to the weighing mode.
- or -
 \rightarrow Press **ESC** for further menu settings.
- or -
 \rightarrow Press **NO** to discard changes and return to the weighing mode.

3.1.5 Selecting and setting parameters in the menu

Example: Setting of the Chain tare function

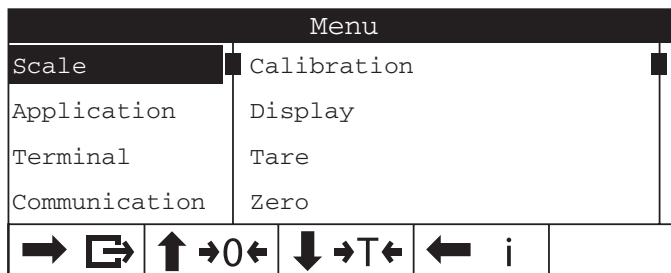

1. In the menu start screen, press \rightarrow to switch to the right side. The first submenu `Calibration` is highlighted.
2. Use $\rightarrow 0 \leftarrow / \rightarrow T \leftarrow$ to select `Tare`. The current `Tare` settings are displayed on the right side.

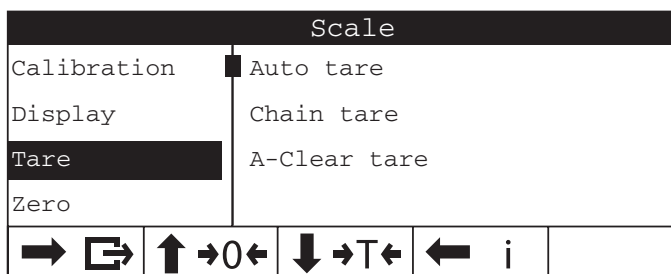

3. Press \rightarrow to open the selected (highlighted) menu item `Tare`. The `Tare` submenus are displayed on the left side.
4. Use $\rightarrow 0 \leftarrow / \rightarrow T \leftarrow$ to select `Chain tare`. The current `Chain tare` setting is displayed on the right side.

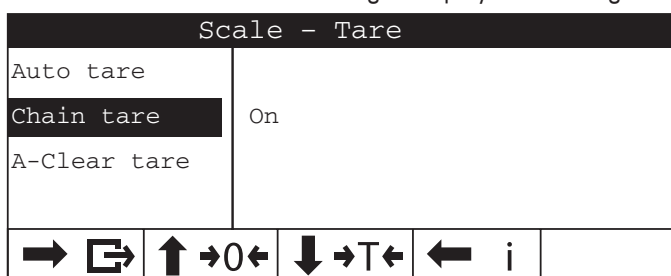

5. Press \rightarrow to open the selected (highlighted) menu item `Chain tare`. All possible `Chain tare` settings are displayed on the right side, the current setting is highlighted.
6. Use $\rightarrow 0 \leftarrow / \rightarrow T \leftarrow$ to change the `Chain tare` setting.
7. Confirm the setting with \rightarrow .

3.2 Scale menu block – analog scales

Factory settings are printed in **bold** in the following overview.





3.2.1 Overview

Level 1	Level 2	Level 3
Calibration		
Display/ Units	Unit 1	g, kg , oz, lb, lb-oz, t
	Unit 2	g , kg, oz, lb, lb-oz, t
	Resolution	
	Unit roll	On, Off
Zero	AZM	Off, 0.5 d , 1 d, 2 d, 5 d, 10 d
Tare	Auto tare	On, Off
	Chain tare	On , Off
	A-Clear tare	On, Off , 9 d
Restart	On, Off	
Filter	Vibration	Low, Medium , High
	Process	Universal , Dosing
	Stability	Fast, Standard , Precise
MinWeigh	Function	On, Off
Reset	Perform reset ?	

3.2.2 Description of the (analog) SCALE menu block

(Analog) Scale → Calibration

This menu item is not available for verified scales.

Perform calibration ?	<ol style="list-style-type: none"> 1. Unload scale. 2. Start calibration with . The scale determines the zero point, -0- appears in the display. The calibration weight to be placed on the scale flashes in the display. 3. If necessary, change the weight value displayed with  T . 4. Place the calibration weight on the scale and confirm with . <p>The scale calibrates with the calibration weight loaded. After calibration is completed, -Done- appears briefly in the display. In order to achieve particularly high precision, calibrate under full load.</p>
Note	The calibration process can be aborted using  .

(Analog) Scale → Display/Units – Weighing unit and display accuracy

Unit 1	Select weighing unit 1: g, kg, oz, lb, lb-oz, t
Unit 2	Select weighing unit 2: g, kg, oz, lb, lb-oz, t
Resolution	Select readability (resolution), the possible settings depend on the connected scale.
Unit roll	When unit roll is switched on, the weight value can be displayed in all available units with  .
Notes	<ul style="list-style-type: none"> • In case of verified scales, individual sub-items of the <code>Display</code> menu item may not be available or only to a limited extent, depending on the respective country. • On dual-range/dual interval scales, resolutions marked with <-> 1/2 are divided up into 2 weighing ranges / intervals, e.g., 2 x 3000 d.

(Analog) Scale → Zero – Automatic zero update

AZM	<p>On verified scales, this menu item does not appear. Switching on/off automatic zero update and selecting zeroing range. Possible settings: Off; 0.5 d; 1 d; 2 d; 5 d; 10 d</p>
------------	--

(Analog) Scale → Tare – Tare function

Auto tare	Switching on/off automatic taring
Chain tare	Switching on/off chain tare
A-Clear tare	Switching on/off automatic clearing of the tare weight when the load is removed from the scale. <ul style="list-style-type: none"> • On The tare weight is automatically cleared if the gross weight is 0 or below zero • Off No automatic clearing of the tare weight • 9 d The tare weight is automatically cleared if the gross weight is within +/- 9 display steps

(Analog) Scale → Restart – Automatic saving of zero point and tare value

Restart	When the restart function is activated, the last zero point and the tare value are saved. After switching off/on or after a power interruption, the device continues to work with the saved zero point and tare value.
----------------	--

**(Analog) Scale → Filter –
Adaptation of the ambient conditions and the weighing type**

Vibration	Adaptation to the ambient conditions
Low	<ul style="list-style-type: none"> • Very steady and stable environment. The scale works very rapidly, but is very sensitive to external influences.
Medium	<ul style="list-style-type: none"> • Normal environment. The scale operates at medium speed.
High	<ul style="list-style-type: none"> • Restless environment. The scale works more slowly, but is insensitive to external influences.
Process	Adaptation to the weighing process
Universal	<ul style="list-style-type: none"> • Universal setting for all weighing samples and normal weighing goods.
Dosing	<ul style="list-style-type: none"> • Dispensing liquid or powdery weighing samples.
Stability	Adjusting the stability defector
Fast	<ul style="list-style-type: none"> • The scale operates very fast.
Standard	<ul style="list-style-type: none"> • The scale operates at medium speed.
Precise	<ul style="list-style-type: none"> • The scale operates with the greatest possible reproducibility. <p>The slower the scale works, the greater the reproducibility of the weighing results.</p>

(Analog) Scale → MinWeigh – Minimum weighing-in quantity

Before you can use this function, the METTLER TOLEDO service technician has to determine and to enter a minimum weight value.

Function	Switching minimum weight function on/off If the weight on the scale drops below the stored minimum weight,  appears in the symbols and info line.
-----------------	---

(Analog) Scale → Reset – Resetting scale settings to factory settings

Perform reset ?	Confirmation inquiry <ul style="list-style-type: none"> • Reset the analog scale settings to factory settings with YES. • Do not reset scale settings with NO.
------------------------	--

3.3 Scale menu block – IDNet scales

Factory settings are printed in **bold** in the following overview.

3.3.1 Overview

Level 1	Level 2	Level 3
Display/ Units	Unit 2	g , kg, oz, lb, t
	Unit roll	On, Off
Zero	AZM	On , Off
Tare	Auto tare	On, Off
	Chain tare	On , Off
	A-Clear tare	On, Off , 9 d
Restart	On, Off	
Filter	Vibration	Stable, Normal , Unstable
	Process	Finefill, Universal , Absolut
	Stability	ASD=0, ASD=1, ASD=2 , ASD=3, ASD=4
Update	The possible settings depend on the connected scale	
MinWeigh	Function	On, Off
Reset	Perform reset?	

3.3.2

Description of the (IDNet) Scale menu block

(IDNet) Scale -> Display – Weighing unit

Unit 2	Select weighing unit 2: g, kg, oz, lb, t
Unit roll	When unit roll is switched on, the weight value can be displayed in all available units with  .
Notes	<ul style="list-style-type: none"> • In case of verified scales, individual sub-items of the <code>Display</code> menu item may not be available or only to a limited extent, depending on the respective country. • On multi-range/multi-interval scales, the symbol I<->I with number indicates the current range or interval.

(IDNet) Scale -> Zero – Automatic zero update

AZM	<p>On verified scales, this menu item does not appear.</p> <p>Switching on/off automatic zero update</p> <p>The effective range of the zero update mode (0.5 d; 1 d; 2 d; 3 d) can only be set by service technician.</p>
------------	--

(IDNet) Scale -> Tare – Tare function

Auto tare	Switching on/off automatic taring
Chain tare	Switching on/off chain tare
A-Clear tare	<p>Switching on/off automatic clearing of the tare weight when the load is removed from the scale.</p> <ul style="list-style-type: none"> • On The tare weight is automatically cleared if the gross weight is 0 or below zero • Off No automatic clearing of the tare weight • 9 d The tare weight is automatically cleared if the gross weight is within +/- 9 display steps

(IDNet) Scale -> Restart – Automatic saving of zero point and tare value

Restart	<p>When the Restart function is activated, the last zero point and the tare value are saved.</p> <p>After switching off/on or after a power interruption, the device continues to work with the saved zero point and tare value.</p>
----------------	--

(IDNet) Scale -> Filter –

Adaptation to the ambient conditions and the weighing type

<p>Vibration</p> <p>Stable</p> <p>Normal</p> <p>Unstable</p>	<p>Adaptation to the ambient conditions</p> <ul style="list-style-type: none"> • Very steady and stable environment. The scale works very rapidly, but is very sensitive to external influences. • Normal environment. The scale operates at medium speed. • Restless environment. The scale works more slowly, but is insensitive to external influences. 																		
<p>Process</p> <p>Finefill</p> <p>Universal</p> <p>Absolut</p>	<p>Adaptation to the weighing process</p> <ul style="list-style-type: none"> • Dispensing of liquid or powdered weighing samples. • Universal setting for all weighing modes and normal weighing goods. • For solid bodies under extreme conditions, e.g. strong vibrations. 																		
<p>Stability</p> <p>ASD = 0 ... ASD = 4</p>	<p>Adjusting stability monitoring</p> <table border="0"> <tr> <td>ASD = 0</td> <td>Stability monitoring switched off</td> <td></td> </tr> <tr> <td></td> <td>Only possible for non-verified scales</td> <td></td> </tr> <tr> <td>ASD = 1</td> <td>Rapid display</td> <td>Good reproducibility</td> </tr> <tr> <td>ASD = 2</td> <td>↑</td> <td>↓</td> </tr> <tr> <td>ASD = 3</td> <td>↑</td> <td>↓</td> </tr> <tr> <td>ASD = 4</td> <td>Slow display</td> <td>Excellent reproducibility</td> </tr> </table>	ASD = 0	Stability monitoring switched off			Only possible for non-verified scales		ASD = 1	Rapid display	Good reproducibility	ASD = 2	↑	↓	ASD = 3	↑	↓	ASD = 4	Slow display	Excellent reproducibility
ASD = 0	Stability monitoring switched off																		
	Only possible for non-verified scales																		
ASD = 1	Rapid display	Good reproducibility																	
ASD = 2	↑	↓																	
ASD = 3	↑	↓																	
ASD = 4	Slow display	Excellent reproducibility																	

(IDNet) Scale -> Update – Setting the display speed of the weight display

This menu item is only displayed if the UPDATE function is supported by the connected scale.

<p>xx UPS</p>	<p>Selecting the number of updates per second (UPS)</p>
<p>Note</p>	<p>The possible settings depend on the connected scale</p>

(IDNet) Scale -> MinWeigh – Minimum weighing-in quantity

Before you can use this function, the METTLER TOLEDO service technician has to determine and to enter a minimum weight value.

<p>Function</p>	<p>Switching minimum weight function on/off</p> <p>If the weight on the scale drops below the stored minimum weight,  appears in the symbols and info line.</p>
------------------------	--

(IDNet) Scale -> Reset – Resetting scale settings to factory settings

<p>Perform reset ?</p>	<p>Confirmation inquiry</p> <ul style="list-style-type: none"> • Reset the digital scale settings to factory settings with YES. • Do not reset scale settings with NO.
-------------------------------	--

3.4 Application menu block

Factory settings are printed in **bold** in the following overviews

3.4.1 Overview

Level 1	Level 2	Level 3
Average	Off , Auto, Manual	
Reset	Perform reset ?	

3.4.2 Description

Application → Average – Determining the average weight for an unstable load (dynamic weighing)

Off	Calculating average weight switched off
Auto	Calculating average weight with automatic start of the weighing cycle
Manual	Calculating average weight with manual start of the weighing cycle via 

Application → Reset – Resetting application settings to factory settings

Perform reset ?	Confirmation inquiry <ul style="list-style-type: none"> • Reset the application settings to factory settings with YES. • Do not reset application settings with NO.
------------------------	---

3.5 Terminal menu block

Factory settings are printed in **bold** in the following overview.



3.5.1 Overview





Level 1	Level 2	Level 3	Level 4	Level 5	
Device	Language	English , German, French, Spanish, Italian, Chinese, ...			
	Sleep / Power off	Off , 1 minute, 3 minutes, 5 minutes, 15 minutes, 30 minutes			
	Display	Layout	Default , Big font mode, 3-Line mode		
		Auxiliary line	Not used, Date & Time , Gross, Net, Tare, HighRes, ID1, ID2, Dev. identifier, Dev. location		
		Contrast	1 ... 10		
		Brightness	1 ... 10		
		Backlight	off, 5 seconds, 10 seconds, 30 seconds, 1 minute, On		
		Weight hold	0 s ... 10 s		
	Keyboard	Key lock	Power, Clear, Switch, Info, Transfer	Lock, Unlock	
		Info key	Item 1 ... Item 10	Not used, Date & Time, Gross, Net, Tare, HighRes & Net, ID1, ID2, Dev. identifier, Dev. location, Dev. name, SNR Terminal, SNR Scale 1, Firmware Vers.	
	Date & Time	Format	EU , US		
		Date	dd/mm/yyyy (EU), mm/dd/yyyy (US)		
		Time	hh:mm:ss		
		Meridian	AM, PM		
	Beeper	On , Off			
	Access	Supervisor	Password		
	Reset	Perform Reset ?			

3.5.2

Description of the Terminal menu block

Terminal → Device – General device settings





Language	Selecting the language of the operator interface Possible languages: English , German, French, Spanish, Italian, Chinese We will expand the available languages continuously.
Sleep (User access)	This menu item only appears on devices in mains operation. When Sleep is activated, the device switches off display and backlighting after the time period set when not in use and gross weight 0. Display and backlighting are switched on again by pressing a key or if the weight changes. Possible settings: Off , 1 min, 3 min, 5 min, 15 min, 30 min (approximate values)
Power Off (User access)	This menu item only appears on devices in battery operation. When Power Off is activated, the device switches itself off automatically after the time period set when not in use. After this, it must be switched on again using  . Possible settings: Off , 1 min, 3 min, 5 min, 15 min, 30 min (approximate values)
Display	Configuring the display window.
Layout	Selecting the presentation of the weight value Possible settings: Default, Big font mode, 3-Line mode
Auxiliary line	Selecting the contents of the auxiliary display line Possible settings: Not used (auxiliary line blank), Date & Time, Gross, Net, Tare, HighRes (weight value in higher resolution), ID1, ID2, Device Identifier, Device Location
Contrast (User access)	Setting the contrast of the display Possible settings: 1 ... 10
Brightness (User access)	Setting the brightness of the display Possible settings: 1 ... 10
Backlight (User access)	Setting whether and after which time the background lighting is switched off. Possible settings: Off (no background lighting), 5 sec, 10 sec, 30 sec, 1 min, On (background lighting always on) (approximate values) Factory setting AC version On Factory setting battery version 5 sec
Weight hold	Setting how long the weighing result is frozen in the display after the transfer key  has been pressed or auto print was generated. Possible settings: 0 s ... 10 s

<p>Keyboard</p> <p>Key lock</p> <p>Info key</p>	<p>Switching keys on/off and setting info key</p> <p>Selecting keys to lock/unlock Possible keys: Power (), Clear (C), Unit switch (), Info (i), Transfer ()</p> <p>Setting up to 10 items to be displayed using the info key (i).</p> <ol style="list-style-type: none"> 1. Select from Item 1 ... Item 10. 2. Assign contents.
<p>Note</p>	<ul style="list-style-type: none"> • If you want to lock the tare key () and/or the zero key (), ask the METTLER TOLEDO service technician. • Locked keys cannot be activated by the user, but the supervisor can still activate these keys by entering his password

<p>Date & Time</p> <p>Format</p> <p>Date</p> <p>Time</p> <p>Meridian</p>	<p>Setting date and time</p> <p>Selecting date format Possible settings: EU, US</p> <p>Setting date in the selected format dd/mm/yyyy (EU) or mm/dd/yyyy (US)</p> <p>Setting time in the following format: hh:mm:ss</p> <p>For US format only: Setting AM/PM</p>
---	--

<p>Beeper</p>	<p>Each keystroke can be confirmed by a short beep. Switching beeper on/off.</p>
----------------------	--

Terminal → Access – Password for Supervisor menu access

<p>Supervisor</p> <p>Enter code</p> <p>Retype code</p>	<p>Entering password for Supervisor menu access</p> <p>Request to enter password → Enter password and confirm with .</p> <p>Request to repeat the password entry → Enter password again and confirm with .</p>
<p>Notes</p>	<ul style="list-style-type: none"> • The password can consist of up to 4 characters (keys). •  must not be part of the password. It is required for confirming the password. •  may only be used in combination with another key. • If you enter an impermissible code or make a typing error when retyping, "code error" appears in the display.

Terminal → Reset – Resetting terminal settings to factory settings

Perform reset ?	Confirmation inquiry <ul style="list-style-type: none"> • Reset the terminal settings to factory settings with YES. • Do not reset terminal settings with NO.
------------------------	---

3.6**Communication menu block**

For detailed information on interface protocols and commands refer to the following documents:

- SICS Reference manual
- MT continuous Reference manual

The Communication menu block consists of the following subblocks:

COM 1 Parameter settings for the standard RS232 interface COM 1.

COM 2 Parameter settings for the optional interface COM 2.

The interfaces identify themselves. Therefore only those menu settings appear which are relevant for the individual interface.

If no optional interface is installed, the entire COM 2 menu will not appear.

Templates Define templates to be selected via COM x → Printer → Template.

3.6.1 Available interface settings / factory settings

		COM1	COM2			
		RS232	RS232	RS422/RS485	Ethernet	USB
Mode	Print	✓	✓	✓	✓	–
	Auto print	✓	✓	✓	✓	–
	Instant print	✓	✓	✓	✓	–
	Continuous ¹⁾	✓	✓	✓	✓	✓
	Dialog ¹⁾	Factory setting	Factory setting	Factory setting	Factory setting	Factory setting
	External input	✓	✓	✓	✓	✓
	Demand mode ²⁾	✓	✓	✓	✓	–
	Demand m auto ²⁾	✓	✓	✓	✓	–
	Cont.-weight ²⁾	✓	✓	✓	✓	✓
Printer		✓	✓	✓	✓	–
Destination		✓	✓	✓	✓	✓
Parameter	Baud	9600	9600	9600	–	–
	Parity	8 none	8 none	8 none	–	–
	Handshake	✓	✓	✓	–	–
	RS Type	–	–	✓	–	–
	Net Address	–	–	✓	–	–
	Checksum	✓	✓	✓	✓	–
	STX	✓	✓	✓	✓	–
	Print G	✓	✓	✓	✓	–
	Load resistor	–	–	✓	–	–

¹⁾ for more information see Reference manual "MT-SICS for ICS4xx"

²⁾ for more information see Reference manual "MT-Demand and Continuous", not recommended for new installations



3.6.2 Overview RS232 / RS422 / RS485 menu blocks (COM 1 / COM 2)

Level 1	Level 2	Level 3	Level 4	
Mode	Print, Auto print, Instant print, Continuous, Dialog, External input, Demand mode, Demand m auto, Cont.-Weight			
Printer	Type	ASCII printer , Label printer, GA46 printer		
	Template	Standard , Template 1 ... Template 5		
	ACII Format	Line format	Multiple , Single, Fixed	
		Line length	1 ... 24 ... 100	
		Separator	. , : ; - _ / \ Space	
		Expanded	On, Off	
		Add line feed	0 ... 9	
Destination	Off , Tare preset, ID1, ID2			
Parameter	Baud	300, 600, ..., 57600, 115200		
	Parity	7 none, 8 none, 7 odd, 8 odd, 7 even, 8 even		
	Handshake	Off , Xon - Xoff		
	RS Type	RS422 , RS485		
	Net Address	0 ... 31		
	Checksum	On, Off		
	STX	On, Off		
	Print G	On, Off		
	Load resistor	On, Off		
Reset	Perform reset ?			

3.6.3

Description of the RS232 / RS422 / RS485 menu blocks (COM 1 / COM 2)

Communication → COM x → Mode – Operating mode of the serial interface

Print	Manual data output to the printer with 
Auto print	Automatic output of stable results to the printer (e.g., for series weighing operations)
Instant print	Immediate manual data output to the printer with  (not verifiable)
Continuous	Ongoing output of all weight values via the interface
Dialog	Bi-directional communication via MT-SICS commands, control of the device via PC
External input	Input other than via terminal keypad. What the input is used for is defined in the Destination menu block
Demand mode	Manual data transmission with 
Demand m auto	Automatic transmission of stable results (e.g. for series weighing operations)
Cont.-Weight	TOLEDO Continuous mode
Note	<p>Printing conditions for <i>Auto print</i> and <i>Demand m auto</i>:</p> <ul style="list-style-type: none"> • The weight must be heavier than 9 display increments. • A weight change of at least 9 display increments is required to initiate the next print out

Communication → COM x → Printer – Settings for protocol printout

Type	Selecting printer type from the following: ASCII printer , Label printer, GA46 printer Note If Label printer is selected, the transmitted data does not include the name of the variable, e.g., Date, Gross, ID1, but the value and, if appropriate, the unit as a separate line. This allows the label printer to fill its template with the required data.
Template	Selecting protocol printout. Possible settings: Standard , Template 1 ... Template 5
ASCII Format Line format	Selecting formats for the protocol printout. Selecting line format from the following: <ul style="list-style-type: none"> • Multiple (multiple lines) • Single (single line) • Fixed (Records output in single lines; every record includes the number of characters that was defined under Line length)
Line length	Setting line length Possible settings: 0 to 100 characters Factory setting: 24 characters This item is only displayed for the line formats Multiple and Fixed
Separator	Selecting the separator: Possible settings: , ; : \ _ - and space This item is only displayed for the line format Single
Expanded	Printout with bigger font size on METTLER TOLEDO printers.
Add line feed	Adding linefeeds Possible settings: 0 ... 9

Communication → COM x → Destination – Destination for barcode input

None	Input destination is not predefined. The input will be shown on the display, you can decide what to do with the input
Tare preset	Input via barcode is recognised as tare preset
ID1, ID2	Input via barcode is recognised as ID1 resp. ID2

Communication → COM x → Reset – Resetting Digital I/O settings to factory settings

Perform reset ?	Confirmation inquiry <ul style="list-style-type: none"> • Reset the Digital I/O settings to factory settings with YES. • Do not reset communication settings with NO.
------------------------	---

Communication -> COM x -> Parameter - Communication parameters

Baud	Selecting baud rate Possible settings: 300, 600, 1200, 2400, 4800, 9600, 19200, 38400, 57600, 115200
Parity	Selecting parity Possible settings: 7 none, 8 none, 7 odd, 8 odd, 7 even, 8 even
Handshake	Selecting handshake Possible settings: Off , Xon-Xoff
RS Type	Selecting type of the optional RS422/RS485 interface: RS422 or RS485
Net Address	Assigning network address: 0 ... 31, only for RS485
Checksum	Activating/deactivating checksum byte
STX	Activating/deactivating STX If STX is enabled, the STX signal (0x02) is sent at the beginning of each output string that is sent via the interface.
Print G	This functionality can only be enabled if one of the Demand mode templates is selected. If it is enabled, the gross weight is marked with "G". Examples Print G enabled, no tare: _ _2.001_kg_G Print G disabled, no tare _ _2.001_kg Print G enabled, tare active: _ _2.025_kg_G_ _2.000_kg_T_ _0.025_kg_NET Print G disabled, tare active: _ _2.025_kg_ _2.000_kg_T_ _0.025_kg_NET
Load resistor	Only for the optional RS422/RS485 interface To avoid reflexions on a network, we recommend to make a defined termination. To this purpose the load resistor within the terminal can be used. When set to "On", a resistor of approx. 100 Ω between the signal lines is enabled

**Communication -> COM x -> Reset COM x -
Resetting communication settings to factory settings**

Perform reset ?	Confirmation inquiry <ul style="list-style-type: none"> • Reset the communication settings to factory settings with YES. • Do not reset communication settings with NO.
------------------------	---

3.6.4 Digital I/O menu blocks (COM 2)

Level 1	Level 2	Level 3
Input	Input pin 1 ... Input pin 4	Off , Zero, Tare, Transfer, Switch, Clear, Info
Output	Ready, Stable, Tare, Zero, < MinWeigh, >= MinWeigh, Underload, Overload, <= Setpoint 1, > Setpoint 1, <= Setpoint 2, > Setpoint 2, Star	Off , Output Pin 1 ... Output Pin 4
Setpoints	Setpoint 1, Setpoint 2	
Output mode	Continuous , Stable	
Reset Digital I/O	Perform reset ?	

COM 2 (Digital I/O) -> Input/Output – Configuring inputs/outputs

Configuring inputs

1. Select an input pin.
2. Assign an input signal to the selected input pin.

Configuring outputs

1. Select an output signal.
2. Assign the desired output pin.

COM 2 (Digital I/O) -> Setpoints – Entering values

Setpoint 1	Enter value for setpoint 1
Setpoint 2	Enter value for setpoint 2

COM 2 (Digital I/O) -> Output Mode – Behaviour of the digital outputs

Continuous	Digital outputs are updated continuously
Stable	Digital outputs are updated only when the weight is stable

3.6.5 Ethernet menu block (COM 2)

Item	Reference
Mode	See RS232 / RS422 / RS485 menu blocks
Printer	
Destination	
Parameter	
DHCP	If DHCP is set to "On", the device will receive the IP address automatically. Then IP address, Subnet mask and Gateway are read-only fields
IP address	Enter/display IP address
Subnet mask	Enter/display Subnet address
Gateway	Enter/display Gateway address
Reset Ethernet	See RS232 / RS422 / RS485 menu blocks

3.6.6 USB menu block (COM 2)

Item	Reference
Mode	See RS232 / RS422 / RS485 menu blocks
Destination	
Checksum	
STX	
Reset USB	

3.6.7 Templates menu block

Level 1	Level 2	Level 3
Template 1 ... Template 5	Line 1 ... Line 15	Not used , Header, Date, Time, Gross, Net, Tare, High resolution, ID1, ID2, Dev. identifier, Dev. location, SNR Terminal, SNR Scale 1, Star line, New line, Form feed

Configuring templates

1. Select a template.
2. Select the line to be configured.
3. Assign the line contents.





The header can be specified via SICS command I31, see Reference manual "MT-SICS for ICS4xx".

3.7 Maintenance menu block

<p>Test Scale</p>	<p>Testing the scale</p> <p>Scales with an analog interface will offer the test procedure described below. Scales with an IDNet interface and an internal calibration weight perform an automatic calibration check.</p> <ol style="list-style-type: none"> 1. The scale checks the zero point. - 0 - appears in the display. 2. The test weight value flashes in the display. If necessary, change the weight value displayed using $\rightarrow T \leftarrow$. 3. Put the test weight on the scale and confirm with $\leftarrow \rightarrow$. The scale checks the test weight. 4. After the test is completed, the deviation from the last calibration briefly appears in the display, ideally *d=0.0g, after which the device changes to the next menu item.
<p>Keyboard Test</p> <p>Start ?</p>	<p>Keyboard test</p> <ol style="list-style-type: none"> 1. Press $\leftarrow \rightarrow$ to start the keyboard test. 2. Press the keys in the displayed order. If the key works, the device switches to the next key.
<p>Display Test</p> <p>Start ?</p>	<p>Display test</p> <ol style="list-style-type: none"> 1. Press $\leftarrow \rightarrow$ to start the display test. A checkerboard pattern is displayed. 2. Press $\leftarrow \rightarrow$ to proceed with the display test. The checkerboard pattern is displayed inverted. 3. Press $\leftarrow \rightarrow$ to leave the display test. <p>The display works properly if the black and white fields are displayed without missing pixels.</p>
<p>Serial number</p>	<p>Display of the serial number of the weighing terminal and the connected weighing platform</p>
<p>Print Setup</p>	<p>Printout of a list of all menu settings</p>
<p>Reset All</p> <p>Perform reset ?</p>	<p>Reset all settings to factory settings</p> <p>Confirmation inquiry</p> <ul style="list-style-type: none"> • Reset all settings to factory settings with YES. • Do not reset settings with NO.

4 Event and error messages

4.1 Error conditions

Error	Cause	Remedy
Display dark	• Backlighting set too dark	→ Set backlighting brighter.
	• No mains voltage	→ Check mains.
	• Unit switched off	→ Switch on unit.
	• Mains cable not plugged in	→ Plug in mains cable.
	• Brief fault	→ Switch device off and on again.
Weight display unstable	• Restless installation location	→ Adjust vibration adapter.
	• Draft	→ Avoid draft.
	• Restless weighing sample	→ Dynamic weighing.
	• Contact between weighing pan and/or weighing sample and surroundings	→ Remedy contact.
	• Mains fault	→ Check mains.
Incorrect weight display	• Incorrect zeroing	→ Unload scale, set to zero and repeat weighing operation.
	• Incorrect tare value	→ Clear tare.
	• Contact between weighing pan and/or weighing sample and surroundings	→ Remedy contact.
	• Weighing platform tilted	→ Level weighing platform.
	• Load plate not on the scale • Weighing range not reached	→ Place load plate on the scale. → Set to zero.
	• Weighing range exceeded	→ Unload scale. → Reduce preload.
	• Result not yet stable	→ If necessary, adjust vibration adapter.
"Attention: Approval invalid" alternating with metrological data	• Approval was tampered with	→ Call METTLER TOLEDO service technician.

4.2 Errors and warnings

4.2.1 Error messages

Error messages contain the following information:

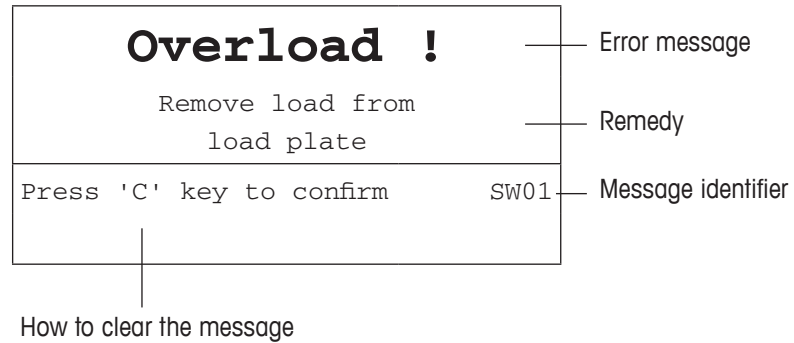

4.2.2 Warnings

Warnings are displayed briefly and then disappear automatically.

Example

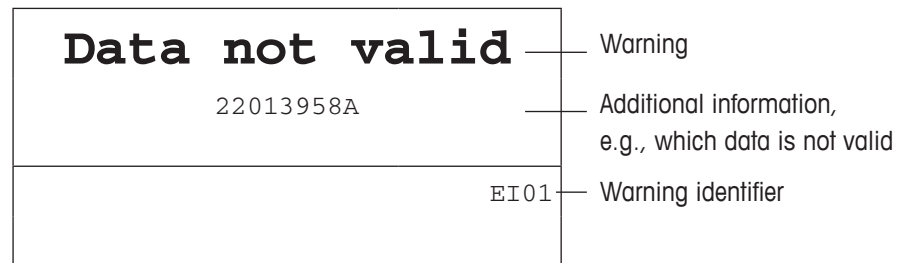

4.3 Smart weighing counter / spanner icon

This weighing instrument features several control functions to monitor the condition of the device.

The METTLER TOLEDO service technician can setup and enable these functions.

This helps the user and the METTLER TOLEDO service technician to determine how the device is treated and what measures are needed to keep it in a good shape.

If the control functions put out an alert, a message is shown.

You can confirm the message and continue to work with the weighing instrument. The spanner icon  lights up.

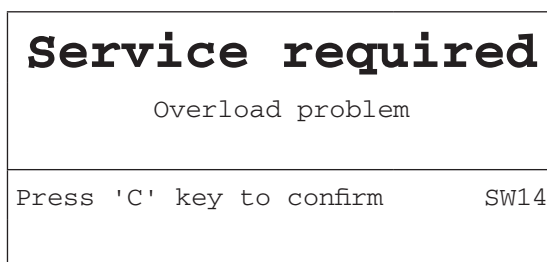

In case of an alert we strongly recommend calling the METTLER TOLEDO service technician

- to replace parts which are at the end of lifetime,
- to correct wrong settings,
- to educate operators about proper handling,
- to perform routine service work,
- to reset the alert,

The control functions monitor the following conditions:

- number of weighings
- number of overloads
- maximum weight
- zero commands and zero failures
- battery charging cycles
- power-on time
- date for the next service inspection

5 Technical data and accessories

5.1 Technical data weighing terminal

Housing	Stainless steel 1.4301 or AISI 304
Display	<ul style="list-style-type: none"> LCD liquid crystal graphical display, with backlighting Size: 125 x 50 mm / 240 x 96 pixels
Keyboard	<ul style="list-style-type: none"> Tactile-touch membrane keypad Scratch-resistant labelling
Protection type	<ul style="list-style-type: none"> Terminal IP68/IP69k Standard weighing platform IP65 Weighing platform with option potted stainless steel load cell IP65/IP67 Weighing platform with option hermetically sealed stainless steel load cell IP68/IP69k
Net weight	<ul style="list-style-type: none"> Application indoor use only Terminal 2.0 kg ICS429a.../c 3.2 kg + weight of the weighing platform
Mains connection	<ul style="list-style-type: none"> Direct connection to power supply (supply voltage fluctuation not exceeding $\pm 10\%$ of the rated voltage) Rated voltage 100 – 240 V ~ / 50 – 60 Hz / 300 mA
Storage battery operation	<ul style="list-style-type: none"> Supply of device: 12 V \equiv / 2.5 A If the supply voltage is interrupted, the device automatically switches over to storage battery operation
Battery charger	<ul style="list-style-type: none"> Ambient conditions: 0 – 40 °C / 32 – 104 °F, dry environment
Ambient conditions	<ul style="list-style-type: none"> Application indoor use only Altitude up to 2,000 m Temperature range Class III –10 – 40 °C / 14 – 104 °F Temperature range Class II 0 – 40 °C / 32 – 104 °F Overvoltage category II Pollution degree 2 Humidity Max. rel. humidity 80 % for temperatures up to 31 °C, decreasing linearly to 50 % rel. humidity at 40 °C
Interfaces	<ul style="list-style-type: none"> 1 interface RS232 integrated 1 further optional interface possible
W & M approvals	<ul style="list-style-type: none"> OIML Class II, III, IIII NTEP Class II, III

Applications

- Weighing
- Average weighing

Operating life with storage battery

The operating life during storage battery operation differs depending on the intensity of use, the configuration and the connected scale.

The following approximate values apply with standard RS232 interface and the brightness set to 5.

Weighing platform	Conditions	Duration
With 1 strain gauge weighing cell, e.g., ICS429a-A15...	10 % operation, 90 % power-off mode	150 h
	Continuous operation	15 h
With 4 strain gauge weighing cells, e.g., a floor scale	10 % operation, 90 % power-off mode	120 h
	Continuous operation	12 h
K line weighing platforms	10 % operation, 90 % power-off mode	60 h
	Continuous operation	6 h

Dimensional drawing

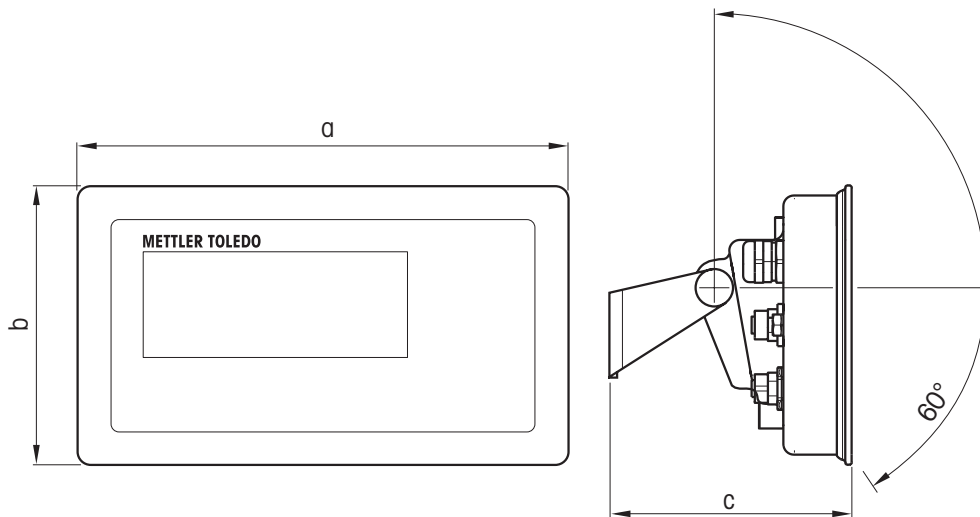

Dimension	[mm]	["]
a	232	9.13
b	132	5.20
c	115	4.53

5.2

Technical data of weighing platforms

- The size of the weighing platform (A, BB, B, QA, QB) is indicated at the end of the product name, e.g., ICS429a-**QA6**.
- Other combinations of weighing range and readability can be adjusted by the METTLER TOLEDO service technician on site.
- The table below indicates the factory settings of weighing range and readability.

Weighing ranges and readability (factory setting)

Model	Weighing range	Readability	Model	Weighing range	Readability
A3	3 kg / 5 lb	1 g / 0.001 lb	QA3	3 kg / 5 lb	1 g / 0.001 lb
A6	6 kg / 10 lb	2 g / 0.002 lb	QA6	6 kg / 10 lb	2 g / 0.002 lb
A15	15 kg / 25 lb	5 g / 0.005 lb	QB15	15 kg / 25 lb	5 g / 0.005 lb
BB30	30 kg / 50 lb	10 g / 0.01 lb	QB30	30 kg / 50 lb	10 g / 0.01 lb
BB60	60 kg / 100 lb	20 g / 0.02 lb	QB60	60 kg / 100 lb	20 g / 0.02 lb
B30	30 kg / 50 lb	10 g / 0.01 lb			
B60	60 kg / 100 lb	20 g / 0.02 lb			

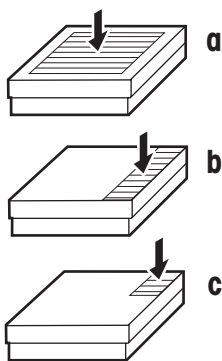
Operation limits – maximum static safe load

Model	a – center load	b – side load	c – corner load
A	40 kg / 80 lb	30 kg / 60 lb	15 kg / 30 lb
BB	100 kg / 200 lb	70 kg / 140 lb	35 kg / 70 lb
B	200 kg / 400 lb	140 kg / 280 lb	75 kg / 150 lb
QA	40 kg / 80 lb	30 kg / 60 lb	15 kg / 30 lb
QB	100 kg / 200 lb	70 kg / 140 lb	35 kg / 70 lb

Weights, approx. values

Model	Standard: potted aluminium	Option: potted stainless steel	Option: hermetically sealed stainless steel
A	4.8 kg / 10.6 lb	5.5 kg / 12.1 lb	5.7 kg / 12.6 lb
BB	7.2 kg / 15.9 lb	7.9 kg / 17.4 lb	8.1 kg / 17.9 lb
B	12.0 kg / 16.5 lb	15.0 kg / 33.1 lb	15.2 kg / 33.5 lb
QA	3.7 kg / 8.2 lb	4.4 kg / 9.7 lb	4.6 kg / 10.1 lb
QB	6.0 kg / 13.2 lb	6.7 kg / 14.8 lb	6.9 kg / 15.2 lb

Length of load cell cable for ICS429a-.../t

Model	Potted aluminium load cell	Potted stainless steel load cell	Hermetically sealed stainless steel load cell
A	1 m / 3.3 ft	3 m / 9.9 ft	3 m / 9.9 ft
BB	2 m / 6.6 ft	3 m / 9.9 ft	3 m / 9.9 ft
B	2 m / 6.6 ft	3 m / 9.9 ft	3 m / 9.9 ft
QA	1 m / 3.3 ft	3 m / 9.9 ft	3 m / 9.9 ft
QB	2 m / 6.6 ft	3 m / 9.9 ft	3 m / 9.9 ft

Dimensional drawings

The size of the weighing platform (A, BB, B, QA, QB) is indicated at the end of the product name, e.g., ICS429a-**QA6**.

Weighing platform

Front view

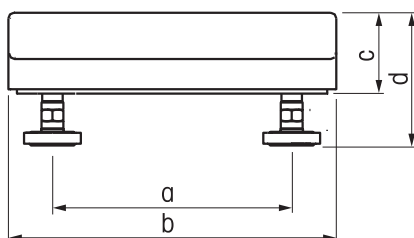

Side view

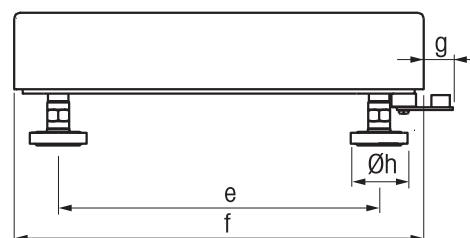

Dim.	A		BB		B		QA		QB	
	[mm]	["]	[mm]	["]	[mm]	["]	[mm]	["]	[mm]	["]
a	175	6.89	235	9.25	335	13.81	163	6.41	240	9.45
b	240	9.45	300	11.81	400	15.74	228	8.97	305	12.00
c	59	2.32	76	2.99	108.5	4.27	59	2.32	76	2.99
d	97	3.81	108	4.25	134.5	5.29	97	3.81	108	4.25
e	235	9.25	335	13.81	435	17.12	163	6.41	254	10.0
f	300	11.81	400	15.74	500	19.68	228	8.97	305	12.00
g	21	0.83	18	0.70	18	0.70	21	0.83	17	0.67
h	42	1.65	42	1.65	42	1.65	42	1.65	42	1.65

ICS429a-.../f

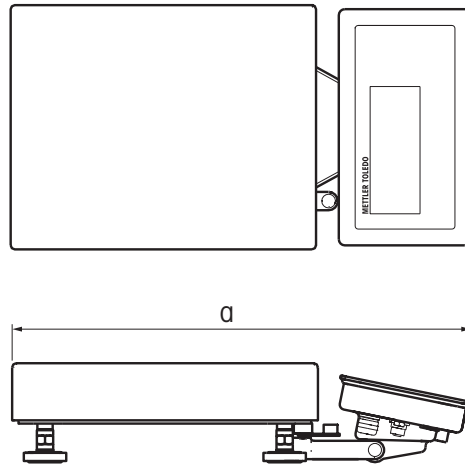

	A		BB		B		QA		QB	
Dim.	[mm]	["]	[mm]	["]	[mm]	["]	[mm]	["]	[mm]	["]
a	452	17.80	549	21.61	649	25.55	380	14.96	452	17.80

ICS429a-.../c

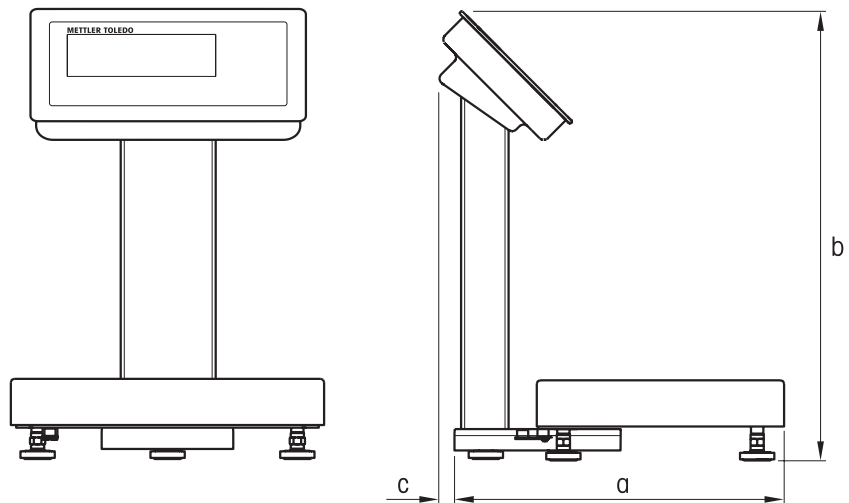

	A		BB		B		QA		QB	
Dim.	[mm]	["]	[mm]	["]	[mm]	["]	[mm]	["]	[mm]	["]
a	452	17.80	515	20.28	615	24.21	347	13.66	419	16.50
b	386	15.20	386	15.20	386	15.20	386	15.20	386	15.20
c	13	0.51	13	0.51	13	0.51	13	0.51	13	0.51

5.3

Accessories

Printers	Order no.
GA46 printer, RS232, incl. 8-pin M12 plug 2.5 m cable 0.4 m cable	22 019 925 22 019 926
Retrofitable interfaces (conversion kits)	Order no.
Kit must be fitted by a METTLER TOLEDO service technician	
RS232 conversion kit terminal, .../t, .../f version .../c version	22 012 112 22 012 117
RS422/RS485 conversion kit terminal, .../t, .../f version .../c version	22 012 113 22 012 118
Ethernet conversion kit terminal, .../t, .../f version .../c version	22 012 114 22 012 119
USB Device conversion kit terminal, .../t, .../f version .../c version	22 012 115 22 012 120
Digital I/O conversion kit, 4 outputs and 4 inputs terminal, .../t, .../f version .../c version	22 012 116 22 012 121
Cables (always delivered with 90° angled M12 plug)	Order no.
RS232 cable for SICS scale, 8 pin M12 <-> 9 pin sub D plug, 3 m	22 021 088
RS232 cable for PC, 8 pin M12 <-> 9 pin sub D receptacle, 3 m	22 021 087
RS422/RS485 cable, 6 pin M12 <-> open ends, 3 m	22 021 089
Ethernet 10/100 Base T twisted pair cable, 4 pin M12 coding D <-> RJ45 5 m 20 m	22 021 090 22 021 091
USB cable, connection to PC, 4 pin M12 coding A <-> USB series A plug, 3 m	22 021 092
Cable to connect Digital I/O option with Relay box, 12 pin M12 <-> open ends, 10 m	22 021 093
I/O accessories	Order no.
Relay box for Digital I/O option	22 011 967
Power supply for Relay box 4 (110–230 V~)	00 505 544

Plugs	Order no.
RS232 counter plug, 8 pin M12	22 021 105
RS485 counter plug, 6 pin M12	22 021 106
Ethernet counter plug, 4 pin, coding D, M12	22 021 107
USB counter plug, 4 pin, coding A, M12	22 021 108
Adapters *	Order no.
RS232 adapter, 8 pin M12 plug <-> 8 pin Binder receptacle, 0.2 m	22 021 094
RS485 adapter, 6 pin M12 plug <-> 6 pin Binder receptacle, 0.2 m	22 021 095
Ethernet adapter, 4 pin coding D M12 plug <-> 16 pin Binder receptacle, 0.2 m	22 021 096
USB adapter, 4 pin coding A M12 plug <-> 16 pin Binder receptacle, 0.2 m	22 021 097
Digital I/O adapter, 12 pin M12 plug <-> 19 pin Binder receptacle, 0.2 m	22 021 098

* Use already installed cables/plugs with our new ICS4x9 M12 plug

Mechanical parts	Order no.
Protective cover for terminals ICS4x9, set of 3 pieces	22 021 109
Stand ICS4x9, for .../t version or terminal with PBA226, PBA426 or PBA429	
Height 120 mm	72 219 393
Height 330 mm	72 198 702
Height 660 mm	72 198 703
Height 900 mm	72 198 704
Stand ICS4x9 for KA, KB, MA, MB and DB platforms, height 330 mm	22 014 836
Bench stand ICS4x9 for scale bench 00503632 or 00504854, height 500 mm	22 014 835
Floor stand ICS4x9, height 1000 mm	22 014 834
Standbase for floor stand	22 011 982
Wall bracket ICS4x9, inclinable and swivelling	22 014 833
Desk mounting plate, for terminal and .../t version only	22 021 111

6 Appendix

6.1 Notice for verified instruments in EC countries



Weighing instruments verified at the place of manufacture bear the preceding mark on the packing label and a green "M" sticker on the descriptive plate. They may be set to work immediately.



Weighing instruments which are verified in two steps have no green "M" on the descriptive plate and bear the preceding identification mark on the packing label. The second step of the verification must be carried out by the approved METTLER TOLEDO service or Weights and Measures authorities. Please contact your METTLER TOLEDO organisation. The first step of the verification has been carried out at the manufacturing plant.

If national regulations in individual countries limit the period of validity of the verification, the operator of such a weighing instrument is himself responsible for its timely re-verification.

6.2 Disposal



In conformance with the European Directive 2002/96 EC on Waste Electrical and Electronic Equipment (WEEE), this device may not be disposed of with domestic waste. This also applies to countries outside the EU, according to their specific requirements.

Please dispose of this product in accordance with local regulations at the collecting point specified for electrical and electronic equipment.

If you have any questions, please contact the responsible authority or the distributor from which you purchased this device.

Should this device be passed on to other parties (for private or professional use), the content of this regulation must also be related.

Thank you for your contribution to environmental protection.

6.3 Tables of Geo Code values

For weighing instruments verified at the manufacturer's, the Geo Code value indicates the country or geographical zone for which the instrument is verified. The Geo Code value set in the instrument (e.g. "Geo 18") appears briefly after switching on.

Table "Geo Code values 3000e" shows the Geo Code values for European countries.

Table "Geo Code values 6000e/7500e" shows the Geo Code values for different gravitation zones.

6.3.1 Geo Code values 3000e, OIML Class III (European Countries)

Country	Geographical latitude	Geo Code value
Austria	46°22' – 49°01'	18
Belgium	49°30' – 51°30'	21
Bulgaria	41°41' – 44°13'	16
Croatia	42°24' – 46°32'	18
Czechia	48°34' – 51°03'	20
Denmark	54°34' – 57°45'	23
Estonia	57°30' – 59°40'	24
Finland	59°48' – 64°00'	25*
	64°00' – 70°05'	26
France	41°20' – 45°00'	17
	45°00' – 51°00'	19*
Germany	47°00' – 55°00'	20
Greece	34°48' – 41°45'	15
Hungary	45°45' – 48°35'	19
Iceland	63°17' – 67°09'	26
Ireland	51°05' – 55°05'	22
Italy	35°47' – 47°05'	17
Latvia	55°30' – 58°04'	23

Country	Geographical latitude	Geo Code value
Liechtenstein	47°03' – 47°14'	18
Lithuania	53°54' – 56°24'	22
Luxemburg	49°27' – 50°11'	20
Netherlands	50°46' – 53°32'	21
Norway	57°57' – 64°00'	24*
	64°00' – 71°11'	26
Poland	49°00' – 54°30'	21
Portugal	36°58' – 42°10'	15
Romania	43°37' – 48°15'	18
Slovakia	47°44' – 49°46'	19
Slovenia	45°26' – 46°35'	18
Spain	36°00' – 43°47'	15
Sweden	55°20' – 62°00'	24*
	62°00' – 69°04'	26
Switzerland	45°49' – 47°49'	18
Turkey	35°51' – 42°06'	16
United Kingdom	49°00' – 55°00'	21*
	55°00' – 62°00'	23

* factory setting

6.3.2

Geo Code values 6000e/75000e OIML Class III (Height ≤ 1000 m)

Geographical latitude	Geo Code value	Geographical latitude	Geo Code value
00°00' – 12°44'	18	43°26' – 47°51'	18
05°46' – 17°10'	21	45°38' – 50°06'	22
12°44' – 20°45'	16	47°51' – 52°22'	20
17°10' – 23°54'	18	50°06' – 54°41'	21
20°45' – 26°45'	20	52°22' – 57°04'	24*, 26
23°54' – 29°25'	23	54°41' – 59°32'	21
26°45' – 31°56'	24	57°04' – 62°09'	15
29°25' – 34°21'	25*, 26	59°32' – 64°55'	18
31°56' – 36°41'	17, 19*	62°09' – 67°57'	19
34°21' – 38°58'	20	64°55' – 71°21'	18
36°41' – 41°12'	15	67°57' – 75°24'	15
38°58' – 43°26'	19	71°21' – 80°56'	24*, 26
41°12' – 45°38'	26	75°24' – 90°00'	18

* factory setting

6.4

Protocol printouts

GA46 printouts, in English

Straight weighing

XXXXXXXXXXXXXXXXXXXXX	Starline
Gross 1.19 kg	Gross/Net/Tare weights
Net 0.37 kg	
Tare 0.82 kg	
	New line

Average weighing

XXXXXXXXXXXXXXXXXXXXX	Starline
Gross 1.19 kg	Gross/Net/Tare weights
NetAverage 0.37 kg	
Tare 0.82 kg	
	New line

Printout with header (standard printout)

METTLER TOLEDO	Header
Tel. +49 7431 140	
Germany	
www.mt.com	
	New line
Date 27/04/2010	Date & Time
Time 22:21:14	
Net 0.37 kg	Net/Tare weights
Tare 0.82 kg	
	New line
Dev. Id #4591-22.A	Device information
Dev.Loc Building B9	
	New line

Printout with header and identification data

METTLER TOLEDO	Header
Tel. +49 7431 140	
Germany	
www.mt.com	
Date 27/04/2010	Date & Time
Time 21:50:48	
ID1 Company ABC	Identifications
ID2 67195 Town	
Net 0.57 kg	Net/Tare/Gross weights
Tare 0.82 kg	
Gross 1.39 kg	
	New line

6.5 Index

- A**
 Accessories 53
 Average weighing 18, 32
- B**
 Barcode
 Destination 40
 Tare preset 17, 18
 Battery
 Handling 13
 Specification 48
 Beeper 35
- C**
 Commissioning 12
 Connections 11
- D**
 Date 35
 Device information , 9, 34
 Display 7
 3-line mode 7
 Backlighting 34
 Bargraph 7, 17
 Big font mode 7
 Brightness 34
 Capacity available 7, 17
 Contrast 34
 Default layout 7
 Metrological data 8
 Presentation in the menu ... 24
 Symbols and info line 9
 Weight display 8
 Disposal 55
 Dynamic weighing 18, 32
- E**
 Environment 48
 Errors 45
 Error conditions 45
 Error messages 46
- G**
 Geo value 15, 22, 56
- H**
 Hygienically sensitive areas ... 14
- I**
 Identifications 34, 35
 Info key , 19
 Interface settings 36
 Digital I/O 42
 Ethernet 43
 RS232 38
 RS422 / RS485 38
 USB 43
- K**
 Keyboard 10
 Key lock 35
- M**
 Menu
 Access 35
 Application 32
 Communication 36
 Maintenance 44
 Operation 23
 Password 23, 35
 Scale (analog) 26
 Scale (IDNet) 29
 Terminal 33
 Messages 45
 MinWeigh 29, 31
 Mode
 Demand mode 39
 Dialog mode 39
 Print mode 39
 MT continuous 36
- O**
 Options 6, 50, 51
 Output mode 42
- P**
 Power off 34
 Power supply 12, 48
 Printing 19
 Printout
 Examples 57
 Templates 43
- S**
 Safety instructions 4, 21
 Setpoints 42
 SICS
 Command set 36
 Tare preset 17, 18
 Simple weighing 15
 Sleep mode 34
 Smart weighing counter 47
 Spanner icon 7, 47
 Switching on and off 15
- T**
 Tare
 Automatic clearing 16, 28, 30
 Automatic taring ... 16, 28, 30
 Chain tare 17, 28, 30
 Tare preset 17, 18
 Taring 16
 Technical data
 Weighing platforms 50
 Weighing terminal 48
 Terminal and platform
 combinations 5, 50
 Test
 Display 44
 Keyboard 44
 Scale 44
 Verification 22
 Time 35
- V**
 Verified instruments in EC
 countries 55

W
Warnings 46

Z
Zero
 Automatic zero update. 27, 30
 Zeroing 15
 Zero point correction..... 15

**To protect your METTLER TOLEDO
product's future:**

METTLER TOLEDO Service XXL assures
the quality, measuring accuracy and
preservation of value of all METTLER
TOLEDO products for years to come.

Please send for full details about our
attractive terms of service.
Thank you.

www.mt.com/service

For more information

Mettler-Toledo (Albstadt) GmbH

D-72458 Albstadt
Tel. +49 7431-14 0
Fax +49 7431-14 232

Subject to technical changes
© 08/2010 Mettler-Toledo (Albstadt) GmbH
Printed in Germany
Order number 22019646A



* 2 2 0 1 9 6 4 6 A *