

## Ignition Keys

■NOTE: The information listed below will help on ordering any replacement keys. On most models, the key identification number is stamped on the key. Record this number in the space provided in the Operator's Manual as well as on the sales receipt during each sale for reference if a consumer ever needs to replace or copy a key.

### ATV/ROV Keys

**2006-Present ROV**  
**2008-Present 400-1000 ATV (except 425)**

0430-042	Left-Side Groove with key codes of 4000-4149
0430-043	Right-Side Groove with key codes of 4150-4299

■NOTE: A dealer can order blank keys and get them cut as long as they have the original key to copy. If the customer has lost both keys, the ignition switch assembly must be replaced.

■NOTE: If a dealer wants Arctic Cat to cut the key, the dealer needs to order a Key (p/n 0409-003). Dealer must then enter the 4-digit key code (4000-4299) found on each key.

**1996-2007 ATV (except 2006-2007 250);**  
**2011-Present 350, 366, & 425**

0409-059 - A-Series	3409-011 - D-Series
0409-060 - B-Series	3409-012 - E-Series
3409-007 - C-Series	3409-013 - F-Series

■NOTE: A dealer can order blank keys and get them cut as long as they have the original key to copy. If the customer has lost both keys on a 2005 and later ATV, the ignition switch assembly must be replaced.

■NOTE: If a dealer wants Arctic Cat to cut the key for a model prior to 2005, the dealer needs to order a Key (ex: p/n 0409-059). Dealer must then enter code letter and 5 numbers (ex: E12345). Code can also be found on the ignition switch.

**2006-Present 50, 90, 250, and 300**

3304-520	Right-Side Cut
3304-521	Left-Side Cut

■NOTE: Hold the key pointing downward and the cut side is the narrow side. This will determine if the key is a right or left cut key.

■NOTE: A dealer can order blank keys and cut them as long as they have the original key to copy. If the customer has lost both keys, the ignition switch assembly must be replaced.

■NOTE: If a dealer wants Arctic Cat to cut the key, the dealer must order Key (p/n 0409-003). Dealer must specify the three digit code and specify if it is a left or right cut key.

### Snowmobile Keys

**2010-Present 4-Stroke Snowmobile**

0430-042	Left-Side Groove with key codes of 4000-4149
0430-043	Right-Side Groove with key codes of 4150-4299

■NOTE: A dealer can order blank keys and get them cut as long as they have the original key to copy. If the customer has lost both keys, the ignition switch assembly must be replaced.

■NOTE: If a dealer wants Arctic Cat to cut the key, the dealer needs to order a Key (p/n 0409-003). Dealer must then enter the 4-digit key code (4000-4299) found on each key.

**1998-Present 2-Stroke Snowmobile**  
**2010-Earlier 4-Stroke Snowmobile**

■NOTE: If a dealer wants Arctic Cat to cut the key, the dealer needs to order a Key (p/n 0409-003). Dealer must then enter the code (ex: A79620).

■NOTE: Each key code is stamped and/or is molded into the head of the key (example: Electric start snowmobile keys with a "1A" code order p/n 0609-453). If a key has been lost, the code is also located on the front side of the ignition switch.

1998-Present 2-Stroke Models			
Electric Start Models		Non-Electric Start Models	
p/n	Key Series	p/n	Key Series
0609-453	1A	0609-349	1A
0609-454	1B	0609-350	1B
0609-455	1C	0609-351	1C
0609-456	1D	0609-352	1D
0609-457	1E	0609-353	1E
0609-458	1F	0609-354	1F
0609-459	2A	0609-355	2A
0609-460	2B	0609-356	2B
0609-461	2C	0609-357	2C
0609-462	2D	0609-358	2D
0609-463	2E	0609-359	2E
0609-464	2F	0609-360	2F

2-Stroke and 4-Stroke through 2006 (Closed Ignitions)	
p/n	Key Series
0609-412	A
0609-467	B
0609-468	C
0609-469	D
0609-470	E

2007-2009 4-Stroke Models	
p/n	Key Series
0409-059	A
0409-060	B

## Sizing Charts

### Adult Helmets\*

Helmet Size	Head-Hat Size	Head Circumference (in.)	Head Circumference (cm)
2XS	6 1/2-6 5/8	20 1/2-20 7/8	52-53
XS	6 3/4-6 7/8	21 1/4-21 5/8	54-55
Small	7-7 1/8	22-22 1/2	56-57
Medium	7 1/4-7 3/8	22 3/4-23 1/4	58-59
Large	7 1/2-7 5/8	23 5/8-24	60-61
XL	7 3/4-7 7/8	24 1/2-24 7/8	62-63
2XL	8-8 1/4	25 1/8-25 1/2	64-65
3XL	8 3/8-8 1/2	26-26 3/8	66-67
4XL	8 1/2-8 5/8	26 3/4-27 1/8	68-69

■NOTE: MX SnoCross helmets run about one size smaller on average than the regular shield helmets (i.e. MX SnoCross Large = Shield Helmet Medium).

### Youth Helmets

Helmet Size	Head-Hat Size	Head Circumference (in.)	Head Circumference (cm)
Medium	6 1/8 - 6 1/4	19 - 20	48 - 49
Large	6 3/8 - 6 1/2	20 - 21 1/2	50 - 51

■NOTE: This is a guideline only. Head shape can vary size.

■NOTE: Sizing charts should be used as general guides for determining approximate size. Differences in individual body shape, as well as the type of cut and style of each garment, should be considered to ensure appropriate fit. Please visit your local Authorized Arcticwear Dealer to try on your selection.

### Men's Outerwear

Size	Chest	Waist	Inseam
S	36" - 38"	28" - 30"	31"
M	40" - 42"	32" - 34"	31"
MT	40" - 42"	32" - 34"	34"
L	44" - 46"	36" - 40"	32"
LT	44" - 46"	36" - 40"	35"
XL	48" - 50"	42" - 44"	33"
XLT	48" - 50"	42" - 44"	36"
2XL	52" - 54"	46" - 48"	33"
2XLT	52" - 54"	46" - 48"	36"
3XL	56" - 58"	50" - 52"	33"
3XLT	56" - 58"	50" - 52"	36"
4XL	60" - 62"	54" - 56"	33"
5XL	64" - 66"	58" - 60"	33"

■NOTE: 5' 11" and taller, use tall sizes.

### Women's Outerwear

Size	Chest	Waist	Hips	Inseam
XS	26" - 30"	19" - 23"	30" - 34"	31"
S	30" - 34"	23" - 26"	34" - 37"	31"
M	34" - 37"	26" - 30"	37" - 40"	31"
MT	34" - 37"	26" - 30"	37" - 40"	33"
L	37" - 40"	30" - 34"	40" - 43"	31"
LT	37" - 40"	30" - 34"	40" - 43"	33"
XL	40" - 43"	34" - 38"	43" - 46"	31"
XLT	40" - 43"	34" - 38"	43" - 46"	33"
2XL	43" - 46"	38" - 41"	46" - 49"	31"
3XL	46" - 49"	41" - 45"	49" - 52"	31"
4XL	49" - 52"	45" - 49"	52" - 55"	31"

■NOTE: 5' 8" and taller, use tall sizes.

### Youth Outerwear

Size	Height	Chest	Waist	Inseam
4	45" - 47"	23" - 25"	20" - 22"	17"
6	47" - 49"	25" - 26"	22" - 23"	19"
8	49" - 50"	26" - 27"	23" - 24"	21"
10	51" - 54"	27" - 28"	24" - 25"	23"
12	55" - 58"	29" - 30"	25" - 26"	25"
14	59" - 61"	30" - 32"	26" - 27"	26"
16	62" - 64"	32" - 33"	27" - 28"	27"

### One-Piece

Size	Height	Chest	Waist	Inseam
2	33" - 35"	21" - 22"	19" - 20"	16"
3	36" - 38"	22" - 23"	20" - 21"	17"
4	39" - 41"	23" - 24"	21"	18"
5	42" - 44"	24" - 25"	21" - 22"	19"
6	45" - 46"	25" - 26"	22"	20"
7	47" - 49"	26" - 27"	22" - 23"	21"

### Glossary

**Missy/Womens** - Missy sizes, also referred to as straight sizes, are the sizes most commonly carried in standard women's clothing stores and generally run from 2 to 18 in even sizes.

**Juniors** - Juniors sizes are designed for young women ages 13 to 18 and are usually cut slimmer in the hips and bust than missy sizes. They're designated by uneven sizes 0 to 17.

## Arcticwear Size Ratios

<b>Jackets and Pants</b>												
	S	M	MT	L	LT	XL	XLT	2XL	2XLT	3XL		
Men's	2%	10%	2%	28%	6%	30%	8%	10%	2%	2%		
Women's	12%	33%	2%	32%	2%	16%	1%	2%				
	<b>4</b>	<b>6</b>	<b>8</b>	<b>10</b>	<b>12</b>	<b>14</b>	<b>16</b>					
Youth	4%	10%	18%	20%	20%	15%	13%					
	<b>2</b>	<b>3</b>	<b>4</b>	<b>5</b>	<b>6</b>	<b>7</b>						
Youth One Piece Suits	10%	14%	17%	22%	19%	18%						
<b>Boots</b>												
	6	7	8	9	10	11	12	13				
Men's		5%	8%	18%	25%	23%	15%	6%				
Women's	10%	23%	35%	22%	10%							
Youth Boots	<b>8</b>	<b>9</b>	<b>10</b>	<b>11</b>	<b>12</b>	<b>13</b>	<b>1</b>	<b>2</b>	<b>3</b>	<b>4</b>	<b>5</b>	<b>6</b>
Children's	7%	8%	11%	14%	15%	15%	15%	15%				
Boy's									18%	18%	26%	38%
<b>Helmets</b>												
	2XS	XS	S	M	L	XL	2XL	3XL				
TXi / PFP	2%	2%	11%	24%	30%	19%	9%	3%				
MX			4%	15%	41%	30%	10%					
Youth				42%	58%							
<b>Gloves</b>												
	XS	S	M	L	XL	2XL	3XL					
Adult	2%	6%	17%	32%	30%	11%	2%					
Youth		15%	30%	35%	20%							
<b>Sportswear</b>												
	S	M	L	XL	2XL							
Adult Shirts	5%	15%	35%	30%	15%							
	6-8	10-12	14-16									
Youth Shirts	27%	33%	40%									

## Accessory Bag Dimensions

Ref	p/n	Description		Length	Width/Depth	Height
90	5639-618	Tunnel Pack		15"	12"	4"
90	5639-573	Tunnel Pack		13"	13"	7"
90	5639-433	Tunnel Pack		24"	15"	6"
90	5639-707	Tunnel Gear Bag		22"	12"	7"
90	5639-574	Tunnel Gear Bag		20"	12"	8"
90	5606-171	Touring Gear Bag		19"	13"	9"
90	4639-712	Touring Saddlebags		22"	7"	12"
91	5639-712	Windshield Bag		9"	14"	4"
91	4639-714	Windshield Bag		23"	10"	6"
91	5639-304	Windshield Bag		24"	12"	6"
91	4639-428	Windshield Bag		26"	3"	5"
91	5639-708	Handlebar Bag		7"	10"	5"
91	5639-709	Handlebar Bag		7"	10"	8"
91	4639-429	Handlebar Bag		9"	6"	7"
91	5639-303	Handlebar Bag		6"	11"	8"
91	5639-434	Handlebar Bag		6"	7"	7"
91	5639-041	Custom Handlebar Bag		8"	4"	6"
109	5639-710	Mountain Pack		9"	14"	6"
109	5639-711	Mountain Gear Bag		18"	14"	8"
109	5639-043	Mountain Seat Bag		12"	16"	9"
110	5639-767	Goggle Holder		9"	6"	4"
110	4639-732	Goggle Holder		10"	3"	6"
118	5639-049	Bearcat Gear Bag		31"	17"	15"
118	6606-252	Tunnel Pack		14"	17"	10"
16	3639-715	Windshield Bag		38"	5"	7"
16	3639-962	Windshield Bag		13"	3"	7"
18	4639-445	LXR Saddlebags		20"	6"	11"
18	5639-301	Seat Pack	Main	9"	13"	8"
18	4639-715	Custom Saddlebags		14"	4"	12"
18	4639-426	Tank Bag		13"	9"	10"
18	5639-305	Underhood Bag		9"	21"	9"
19	4639-427	Windshield Flair Bags		4"	11"	3"
19	3639-722	Firecat Trunk Bag		10"	14"	7"
34	5639-044	Mountain Gear Bag		14"	20"	9"
34	3639-725	Mountain Pack		9"	12"	7"
34	4639-727	Mountain Gear Bag	Main	17"	16"	8"
			Side	10"	4"	7"

## Kit Installation Times

p/n	Description	Application	Labor (mins)
5639-347	Tunnel Rails (Pair)	'10-'11 F Series, Z1, Z1 Turbo; '12 F5, F570	25
5639-348	Tunnel Rails (Pair)	'10-'11 Z1 Turbo EXT; '11 F8 EXT	25
5639-717	2-Up Seat Kit	'12 F 800, F 1100, F 1100 Turbo, XF 800, XF 1100, XF 1100 Turbo	30
5639-307	2-up Seat Kit	'10-'11 F Series, Z1, Z1 Turbo, Z1 Turbo EXT; '11 F8 EXT; '12 F5, F570	20
5639-308	2-up Seat Kit	'09-'11 CF, CFR (Requires Hitch Kit)	15
5639-150	2-up Seat Kit	'09 F Series (Liquid-Cooled), Z1, Z1 Turbo	20
4639-451	2-up Seat Kit	'07-'08 F Series (Liquid-Cooled), JR	60
5639-850, 851, 852	Sport Bumper	'12 F 800, F 1100, M 800, M 800 HCR, M 1100, XF 800, XF 800 HC, XF 1100	10
5639-825, 826, 827	Sport Bumper	'07-'11 F Series; '08-'11 T 570, TZ1 Touring; '09-'11 BC 570, Z1, Z1 Turbo; '12 F5, F570	20
5639-065	Sport Bumper - Green (Aluminum)	'10-'11 Sno Pro 500	15
5639-622, 623, 624	Sport Bumper	'05-'11 M Series; '06-'11 CF; '09-'11 CFR, M8 HCR	20
5639-312	Touring Bumper - Black (Steel)	'07-'11 F Series; '08-'12 T 570, TZ1 Touring; '09-'12 BC 570, Z1 (Non-Turbo)	20
5639-718, 719, 720	Procross Rack	'12 F 800, F 1100, F 1100 Turbo, XF 800, XF 1100, XF 1100 Turbo	15
5639-313, 314, 315	Sport Rack	'10-'11 F Series, Z1, Z1 Turbo, Z1 Turbo EXT; '11 F8 EXT	10
5639-155, 156, 157	Crossfire Rack - Green	'09-'11 CF, CFR (Requires Hitch Kit)	15
5639-316, 317	Touring Rack - Short/Long	'08-'12 T 570, TZ1 Touring; '09-'12 BC 570	20
5639-721	Hitch Kit, Pivot	'12 F 800, F 1100, F 1100 Turbo 128-in.	40
5639-722	Hitch Kit, Pivot	'12 XF 800, XF 1100, XF 1100 Turbo 141-in.	40
5639-723	Hitch Kit, Pivot	'12 M 800, M 800 HCR, M 1100, M 1100 Turbo, XF 800 HC, XF 1100 Turbo HC 153-in.	40
5639-724	Hitch Kit, Pivot	'12 M 800, M 1100 Turbo, M 1100 Turbo HCR 162-in.	40
5639-318	Hitch Kit, Pivot	'10-'11 F Series, Z1, Z1 Turbo 128-in.; '12 F5, F570	30
5639-319	Hitch Kit, Pivot	'10-'11 Z1 Turbo EXT; '11 F8 EXT 144-in.	30
4639-966	Hitch Kit, Pivot	'09 F Series, Z1, Z1 Turbo 128-in.	30
4639-452	Hitch Kit, Pivot	'07-'08 JR; '07-'08 F Series (Liquid-Cooled)	20
5639-158	Hitch Kit, Pivot	'09-'11 M Series, M8 HCR 153-in.	30
5639-159	Hitch Kit, Pivot	'09-'11 M Series 162-in.	30
5639-166	Hitch Kit, Pivot	'09-'11 CF 141-in.	30
5639-202	Hitch Kit, Pivot	'09-'11 CFR 128-in.	30
4639-788	Hitch Kit, Pivot	'06-'08 CF; '07-'08 M Series	25
4639-723	Hitch Kit, Pivot	'08-'12 T 570, TZ1 Touring (Pivot)	25
4639-907	Hitch Kit, Pintle	'08-'12 T 570, TZ1 Touring (Pintle)	25
1639-607	Hitch Kit, Pivot	'00-'05 PTA; '04-'07 T660 Touring	30
1639-507	Hitch Kit, Pivot	'99-'02 PA; '99-'06 121-in. Models; '07 Z, T660 Trail	25
2639-686	Hitch Kit, Pivot	'03-'06 FC; '04-'06 SC 128-in. & 144-in.	25
5639-725	Tow Hitch - Pivot	'12 F 800, F 1100, F 1100 Turbo, M 800, M 800 HCR, M 1100, M 1100 Turbo, M 1100 Turbo HCR, XF 800, XF 1100, XF 1100 Turbo, XF 800 HC, XF 1100 Turbo HC	15
5639-324	Tow Hitch - Pivot	'09-'11 CF, CFR, M Series; '10-'11 F Series, Z1, Z1 Turbo, Z1 Turbo EXT; '11 F8 EXT	25
4639-124	Tow Hitch - Pivot	'05-'08 M Series; '06-'08 CF	25
1639-505	Tow Hitch - Pivot	'99-'06 121-in. Models; '07 Z, T660 Trail	25
3639-189	Pintle Conversion Kit	Fits Pivot Hitch Kits Listed Above	5
5639-531	Remote Start Kit	'08-'12 TZ1 Touring; '09-'12 BC Z1 XT, Z1	60
5639-646	Electric Start Kit	'11 F Series 800	190
5639-321	Electric Start Kit	'10 BC 570	190
5639-198	Electric Start Kit	'09-'11 F Series 800, 1000	190
4639-803	Electric Start Kit	'08-'11 CF, M Series 500, 600	120
4639-782	Electric Start Kit	'08-'11 F Series 500, 600	190
5639-861	Engine Heater (US & Canada)	'12 F 1100, F 1100 Turbo, M 1100, M 1100 Turbo, XF 1100, XF 1100 Turbo, XF 1100 Turbo HC	45
5639-823	Engine Heater (US & Canada)	'07-'12 TZ1; '09-'12 BC Z1 XT, Z1, Z1 Turbo (US & Canada)	45
5639-824	Engine Heater (International)	'07-'12 TZ1; '09-'12 BC Z1 XT, Z1, Z1 Turbo (International)	45
0638-188	Engine Heater	'99-'07 LC Models Except CF, F, FC, JR, M, SC, 4-Stroke	30
5639-731	Fox Float Evol, Ski Shock Kit (Pair)	'12 F 800, F 1100, F 1100 Turbo, XF 800, XF 1100, XF 1100 Turbo (42-in. Stance)	15
5639-732	Fox Float Evol, Ski Shock Kit (Pair)	'12 M 800, M 1100, M 1100 Turbo (40-in. Stance)	15
5639-733	Fox Float R Evol, Ski Shock Kit (Pair)	'12 F 800, F 1100, F 1100 Turbo, XF 800, XF 1100, XF 1100 Turbo (42-in. Stance)	15
5639-734	Fox Float R Evol, Ski Shock Kit (Pair)	'12 M 800, M 1100, M 1100 Turbo, M 1100 Turbo HCR (40-in. Stance)	15
5639-587	Fox Float R Evol, Ski Shock Kit (Pair)	'07-'11 F Series; '09-'11 Z1, Z1 Turbo	15
5639-588	Fox Float R Evol, Ski Shock Kit (Pair)	'05-'11 M Series	15
5639-589	Fox Float R Evol, Ski Shock Kit (Pair)	'06-'11 CF; '09-'11 CFR	15
5639-590	Fox Float R Evol, Ski Shock Kit (Pair)	'10-'11 Sno Pro 500	10
5639-735	Fox Float RC2 Evol, Ski Shock Kit (Pair)	'12 F 800, F 1100, F 1100 Turbo, XF 800, XF 1100, XF 1100 Turbo (42-in. Stance)	15
5639-625	Fox Float RC2 Evol, Ski Shock Kit (Pair)	'10-'11 Sno Pro 500	10
5639-729	Fox Float 2, Ski Shock Kit (Pair)	'12 F 800, F 1100, F 1100 Turbo, XF 800, XF 1100, XF 1100 Turbo (42-in. Stance)	15
5639-730	Fox Float 2, Ski Shock Kit (Pair)	'12 M 800, M 1100, M 1100 Turbo (40-in. Stance)	15
5639-583	Fox Float 2, Ski Shock Kit (Pair)	'07-'11 F Series; '09-'11 Z1, Z1 Turbo	15

## Kit Installation Times (cont)

p/n	Description	Application	Labor (mins)
5639-584	Fox Float 2, Ski Shock Kit (Pair)	'05-'11 M Series	15
5639-585	Fox Float 2, Ski Shock Kit (Pair)	'06-'11 CF; '09-'11 CFR	15
5639-586	Fox Float 2, Ski Shock Kit (Pair)	'10-'11 Sno Pro 500	10
5639-750	Fox Float 2, Rear Arm Shock Kit	'12 M 800, M 1100, M 1100 Turbo, XF 800, XF 1100, XF 1100 Turbo; '08-'11 M Series	15
5639-727	Pink Accessory Kit	'12 F 800 LXR, F 1100 LXR - Black	40
5639-728	Pink Accessory Kit	'12 XF 800 LXR, XF 1100 LXR - Black	40
5639-806	Pink Accessory Kit	'12 F570	40
5639-838	Pink Accessory Kit	'12 F5 LXR	60
5639-576	Pink Accessory Kit	'11 F 570	40
5639-607	Pink Accessory Kit	'11 F5 LXR	60
5639-608	Pink Accessory Kit	'11 F8, Z1 LXR	60
5639-745, 746, 747, 748	Skid Plate, Front	'12 F 800, F 1100, M 800, M 800 HCR, M 1100, XF 800, XF 800 HC, XF 1100	10
5639-893, 894, 895, 896	Skid Plate, Rear	'12 F 800, F 1100, F 1100 Turbo, M 800, M 800 HCR, M 1100, M 1100 Turbo, M 1100 Turbo HCR, XF 800, XF 800 HC, XF 1100, XF 1100 Turbo, XF 1100 Turbo HC	40
4639-567, 568, 569	Skid Plate	'07-'11 F Series; '08-'12 T 570, TZ1 Touring; '09-'11 Z1, Z1 Turbo; '10-'11 Z1 Turbo EXT; '11 F8 EXT; '12 F5, F570	30
3639-838, 839	Skid Plate	'05-'11 M Series; '06-'11 CF; '09-'11 CFR, M8 HCR	30
4639-564	Skid Plate	'05-'11 M Series; '06-'11 CF; '09-'11 CFR, M8 HCR	30
5639-582, 223	Skid Plate	'05-'11 M Series; '06-'11 CF; '09-'11 CFR, M8 HCR	30
1639-417	Skid Plate - Black	'00-'06 ZR; '01-'03 ZI; '01-'04 MC; '01-'08 Z; '04-'06 KC	30
5639-328, 329, 330	Grip Plates (Pair)	'10-'11 F Series, Z1, Z1 Turbo, Z1 Turbo EXT; '11 F8 EXT; '12 F5, F570	10
5639-611	Toe Hold (Pair) - Black	'10-'12 Sno Pro 500	20
5639-062	Cargo Rack	'09-'12 BC XT	15
5639-060, 061	Side Rails - Short/Long	'09-'12 BC XT	5
5639-339	Receiver Bumper - Rear	'09-'12 BC XT	30
5639-338	Receiver Bumper - Front	'09-'12 BC XT	40
5639-386	Hitch	'09-'12 BC XT	5
5639-387	Pivot Hitch Conversion	'06-'07 BC Wt; '07 BC 570; '09-'12 BC XT	5
5639-340	Receiver Winch	'09-'12 BC XT	35
5639-457	Transport Mount	'09-'12 BC XT	10
5639-456	Rear Harness	'09-'12 BC XT	60
5639-341	Snow Plow Push Frame	'09-'12 BC XT	25
0436-296	Snow Plow Blade	'09-'12 BC XT	20
5639-389	Backup Light Kit	'09-'12 BC XT	35
4639-970	Passenger Handwarmers	'09-'12 BC Z1 XT	40
4639-802	Passenger Handwarmers	'08-'09 T500	40
5639-254	Ski Skins	'09-'12 BC 570, BC XT (8-in. Saddleless Skis)	15
5639-441	Sway Bar	'09-'12 BC 570 XT; '10-'12 BC Z1 XT	25
5639-200	Sway Bar Kit	'09-'12 BC 570	25
4639-322	Sway Bar Kit	'99-'07 PA, Z; '06-'08 BC	25
4639-967	Radiator Kit	'09-'12 BC Z1 XT	90
4639-971	Heated Seat Kit	'09-'11 BC Z1 XT	45
5639-597, 598	Billet Rack	'09-'11 M Series, M8 HCR	10
5639-600, 601, 602	Mountain Seat	'05-'09 M Series; '06-'11 CF; '09-'11 CFR	10
4639-975, 976, 977	M Series Rack	'09-'11 M Series, M8 HCR	10
5639-897	Ice Scratchers	'09-'11 M Series, M8 HCR, CF	10
5639-528	Four Wheel Kit (Adds 2 Inside Wheels)	'09-'11 M Series	25
4639-997	Two Wheel Kit	'08 M Series; '09-'11 CF	20
5639-358	Mountain Strap	'10-'11 Z1 Turbo EXT; '11 F8 EXT	5
5639-360	Long Track Kit	'10-'11 Z1 Turbo EXT; '11 F8 EXT	150
4639-995	Lightweight Front Axle Kit	'05-'08 M Series	60
4639-994	Float Conversion	'05-'07 M Series; '09-'10 CF (Std)	90
5639-107, 108, 109	Tunnel Flares (Pair)	'09-'11 M Series, M8 HCR, CF, CFR	10
5639-580	Switch Guards	'07-'11 M Series; '09-'11 M8 HCR	5
5639-813	Telescopic Steering Post	'12 F 800, XF 800, M 800 (Std)	70
5639-516	Telescopic Steering Post	'09-'11 M Series (Std), CF (Std)	40
5639-858	DC Power Kit	'12 F 800, M 800, XF 800, XF 800 HC	20
5639-258	DC Power Kit	'09-'11 CF, CFR, M Series 800, 1000	25

■NOTE: The above information is intended for use as a guideline when quoting installation time for customers. Variables may cause installation time to be higher or lower. The times listed are not labor rates to be reimbursed to dealers.

## Covers



Page 86

### PREMIUM COVERS

Application	p/n
(A) '12 F 800, F 1100, XF 800, XF 1100 (Inc Turbo) - Green	5639-669
(A) '12 F 800, F 1100, XF 800, XF 1100 (Inc Turbo) - Orange	5639-670
(A) '12 M 800, M 800 HCR, M 1100, M 1100 Turbo, M 1100 Turbo HCR, XF 800 HC, XF 1100 Turbo HC - Green	5639-671
(A) '12 M 800, M 800 HCR, M 1100, M 1100 Turbo, M 1100 Turbo HCR, XF 800 HC, XF 1100 Turbo HC - Orange	5639-672
(B) '12 F5, F570; '07-'11 F Series; '09-'11 Z1, Z1 Turbo - Black	5639-673
(B) '08-'12 T570, TZ1, TZ1 LXR Touring - Black	5639-674
(C) '12 F 1100, XF 1100 (Inc Turbo) - LTD White	5639-696
(C) '12 M 1100 (Inc Turbo) - LTD White	5639-697
(D) '12 F 1100, XF 1100 (Inc Turbo) - LTD Black	5639-698
(D) '12 M 1100 (Inc Turbo) - LTD Black	5639-699



Page 87

### ARCTIC CAT CANVAS COVERS

Application	p/n
(E) '12 F 800, F 1100, XF 800, XF 1100 (Inc Turbo)	5639-675
(E) '12 F 800, F 1100, XF 800, XF 1100 (Inc Turbo) w/High WS	5639-676
(E) '12 F 800, F 1100, XF 800, XF 1100 (Inc Turbo) w/2-Up & High WS	5639-677
(E) '12 F5, F570; '07-'11 F Series; '09-'11 Z1, Z1 Turbo	5639-680
(F) '12 M 800, M 800 HCR, M 1100, M 1100 Turbo, M 1100 Turbo HCR, XF 800 HC, XF 1100 Turbo HC	5639-678
(F) '12 M 800, M 800 HCR, M 1100, M 1100 Turbo, M 1100 Turbo HCR, XF 800 HC, XF 1100 Turbo HC w/High WS	5639-679
(G) '08-'12 T570, TZ1, TZ1 LXR Touring	5639-681
(G) '09-'12 Bearcat 570	5639-682
(G) '09-'12 Bearcat 570 XT, Bearcat Z1 XT; '12 Bearcat Z1 XT GS	5639-683

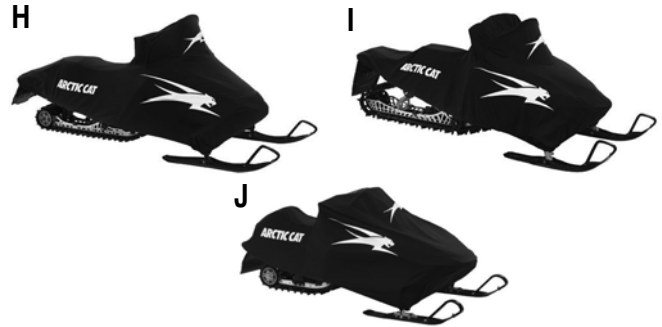

Page 87

### ARCTIC CAT CANVAS COVERS

Application	p/n
(H) '06-'11 Crossfire	5639-543
(H) '06-'11 Crossfire w/2-Up Seat	5639-283
(H) '09-'11 CFR	5639-544
(H) '12 F5, F570; '07-'11 F Series; '09-'11 Z1, Z1 Turbo w/Extreme High WS	5639-546
(H) '12 F5, F570; '07-'11 F Series; '09-'11 Z1, Z1 Turbo w/2-Up Seat	5639-286
(H) '10-'11 Z1 Turbo EXT; '11 F8 EXT	5639-547
(I) '09-'11 M Series, M8 HCR 153"-162"; '05-'08 M Series 153"	5639-548
(I) '05-'08 M Series 153"-162"	5639-241
(J) '00-'12 120	5639-290



Page 88

### TEAM ARCTIC PREMIUM COVERS

Trailerable

Application	p/n
'10-'12 Sno Pro 500	5639-702
'10-'12 Sno Pro 500 w/High WS	5639-703
'12 F 800, F 1100, F 1100 Turbo, XF 800, XF 1100, XF 1100 Turbo	5639-704



Page 88

**CUSTOM COVERS (NON-CURRENT)**

Trailerable

Application	p/n
<b>'03-'06 128"</b> Firecat, Sabercat	5639-017
<b>'99-'06 121"</b> Cougar, EXT, T660, Thundercat, Z, ZL, ZR, ZRT	5639-018
<b>'05-'08 M Series</b> M Series 153"-162"	5639-241
<b>'02-'04 Mountain</b> King Cat, Mountain Cat, Powder Special	5639-019
<b>'00-'06 2-Up Touring</b> Panther, Pantera, T660 Touring	5639-020
<b>'03-'08 Bearcat W/T</b> Bearcat W/T	5639-021



Page 88

**UNDERCOVER LINER**

Application	p/n
Universal	5639-570



**REPLACEMENT COVER STRAPS**

Description	p/n
(A) Sew-On Straps w/Buckles (Pkg 4)	0636-610
(B) Cinch Straps w/Hook (Pkg 4)	0636-527



Page 88

**DUST COVER**

Application	p/n
121-in.-128-in.	5639-705
136-in.-162-in. Mountain	5639-706
2-Up Touring	5639-716



## Touring Bags

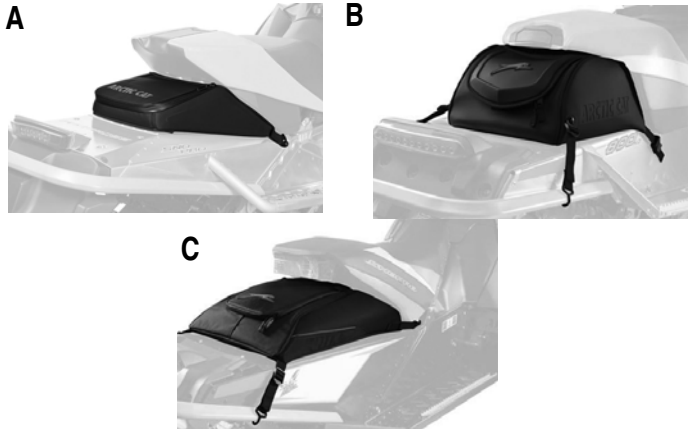

Page 90

### TUNNEL PACK

Application	p/n
(A) '12 F 800, F 1100, F 1100 Turbo, M 800, M 800 HCR, M 1100, M 1100 Turbo, M 1100 Turbo HCR, XF 800, XF 1100, XF 1100 Turbo, XF 800 HC, XF 1100 Turbo HC	5639-618
(B) '12 F5, F570; '07-'11 F Series, '10-'11 Z1, Z1 Turbo, Z1 Turbo EXT; '11 F8 EXT	5639-573
(C) '10-'12 Sno Pro 500, '10-'11 M Series	5639-433
Replacement Strap w/Hook (Pkg/4)	0641-994
Replacement Spool (Each)	1623-940

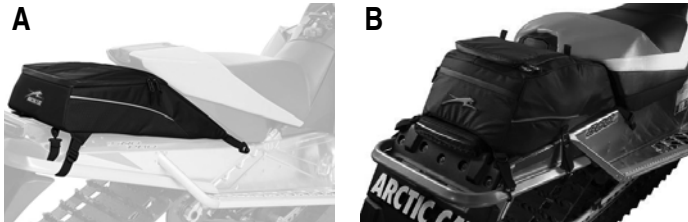

Page 90

### TUNNEL GEAR BAG

Application	p/n
(A) '12 F 800, F 1100, F 1100 Turbo, XF 800, XF 1100, XF 1100 Turbo	5639-707
(B) '12 F5, F570; '10-'11 F Series, M Series, Z1, Z1 Turbo, Z1 Turbo EXT; '11 F8 EXT	5639-574
Replacement Strap w/Hook (Pkg/4)	0641-994
Replacement Cam Buckles (Pkg/2)	0639-089

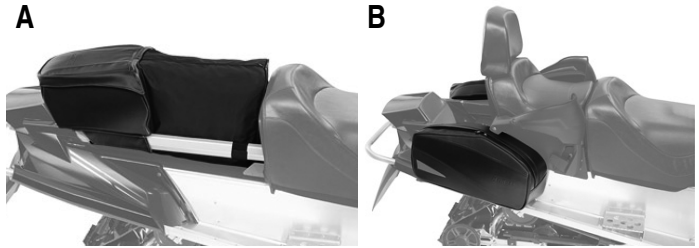

Page 90

### A. TOURING GEAR BAG

Application	p/n
'08-'12 T 570, TZ1 Touring; '09-'12 BC 570	5606-171

### B. TOURING SADDLEBAGS

Application	p/n
'08-'12 T 570, TZ1 Touring; '09-'12 BC 570	4639-712



p/n 5639-712

p/n 4639-714



p/n 3639-715



p/n 3639-962



p/n 4639-428



Page 91

### WINDSHIELD BAG

Not recommended for fan-cooled machines.

Application	p/n
'12 F 800, F 1100, F 1100 Turbo, M 800, M 800 HCR, M 1100, M 1100 Turbo, M 1100 Turbo HCR, XF 800, XF 1100, XF 1100 Turbo, XF 800 HC, XF 1100 Turbo HC	5639-712
'12 F5, F570; '08-'11 F Series, TZ1 Touring; '09-'12 BC; '09-'11 Z1	4639-714
'09-'11 Z1 Turbo, TZ1 Turbo Touring	5639-304
'05-'11 M Series; '06-'11 CF; '09-'11 CFR, M8 HCR	4639-428
'03-'06 FC; '04-'06 SC	3639-715
'00-'06 ZR; '01-'04 MC 600, 800, 900; '02-'05 PTA; '04-'06 KC; '03-'07 BC WT (Non-Turbo)	3639-962

p/n 5639-708



p/n 5639-709



p/n 4639-429



p/n 5639-434



Page 91

**HANDLEBAR BAG**

Application	p/n
'12 F 800, F 1100, F 1100 Turbo, M 800 (STD), M 1100 (STD), XF 800, XF 1100, XF 1100 Turbo; '12 F570; '10-'11 F Series, Z1 (STD)	5639-708
'12 M 800 SP, M 800 HCR, M 1100 SP, M 1100 Turbo SP, M 1100 Turbo HCR, XF 800 HC, XF 1100 Turbo HC; '09-'12 BC 570, BC XT; '05-'11 M Series; '06-'11 CF	5639-709
'12 F5 LXR; '08-'12 T570, TZ1 Touring; '07-'09 F Series; '09-'11 CFR; '10-'11 F Series, Z1 LXR & Sno Pro	4639-429
'10-'12 Sno Pro 500	5639-434



Page 91

**BAG HEATER KIT**

Application	p/n
Fits Handlebar Bags 5639-708, 5639-709	5639-837



Page 91

**CUSTOM HANDLEBAR BAG**

Application	p/n
Universal	5639-041



Page 92

**SPORT MUFFS**

Application	p/n
'12 F 800, F 1100, F 1100 Turbo, M 800, M 800 HCR, M 1100, M 1100 Turbo, M 1100 Turbo HCR, XF 800, XF 1100, XF 1100 Turbo	5639-714
'07-'11 Models	5639-524



Page 92

**HANDLEBAR MUFFS**

Application	p/n
Universal	5639-713



Page 92

**PASSENGER HAND MUFFS**

<b>Application</b>	<b>p/n</b>
'08-'12 T 570, TZ1 Touring; '09-'12 BC 570, BC XT	5639-353



**CUSTOM SADDLEBAGS**

<b>Application</b>	<b>p/n</b>
'07-'09 F Series; '09 Z1	4639-715
Replacement Cam Buckles	1639-248



**LXR SADDLEBAGS**

<b>Application</b>	<b>p/n</b>
'07-'09 F Series; '09 Z1	4639-445
Replacement Cam Buckles (Pkg/2)	1639-248



**TANK BAG**

<b>Application</b>	<b>p/n</b>
'12 F5, F570; '07-'11 F Series; '08-'11 T 570, TZ1 Touring; '09-'11 BC 570, Z1, Z1 Turbo	4639-426



**SEAT PACK**

<b>Application</b>	<b>p/n</b>
'12 F5, F570; '07-'11 F Series, Z1, Z1 Turbo, Z1 Turbo EXT; '11 F8 EXT (Fixed or Adjustable Seat)	5639-301



**UNDERHOOD BAG**

<b>Application</b>	<b>p/n</b>
'09-'11 TZ1 Touring, Z1 (Non-Turbo)	5639-305



**WINDSHIELD FLAIR BAGS**

Sold as a pair.

**Application**  
'00-'06 ZR; '01-'04 MC; '01-'07 Z; '02-'05 PTA;  
'04-'06 KC; '03-'08 BC 570, PA

**p/n**  
4639-427



**FIRECAT TRUNK BAG**

**Application**  
'03-'06 FC 128"  
Replacement Cam Buckles

**p/n**  
3639-722  
1639-248

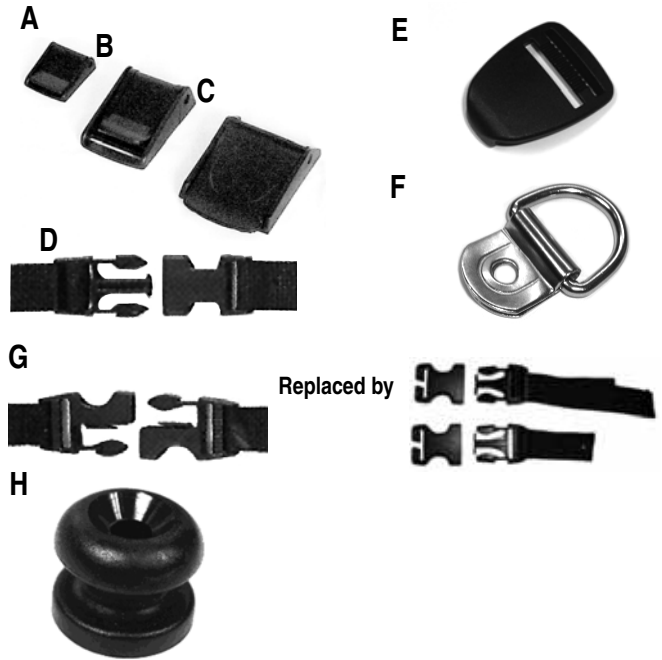

**REPLACEMENT HARDWARE**

<b>Description</b>	<b>p/n</b>
(A) Cam Buckle (Pair) - 1"	0639-089
(B) Cam Buckle (Pair) - 1-1/2"	1639-248
(C) Cam Buckle (Pair) - 2"	2639-152
(D) SR1 Buckle Kit (Pair)	0638-082
(E) Strap Hook (Pair)	0641-485
(F) Tunnel Clip - Black (Each)	6606-244
(G) Buckle Kit - Unisex Replacement (Pair)	2639-662
(H) Spool (Each)	1623-940

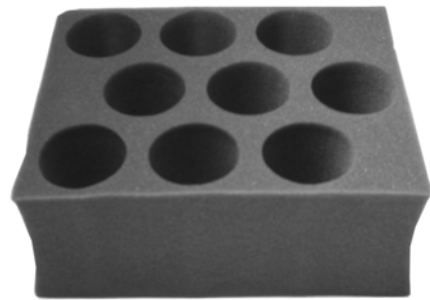

**FOAM BEVERAGE HOLDER**

<b>Description</b>	<b>p/n</b>
Foam Beverage Holder 11" x 9" x 4"	1639-599

## Touring Accessories

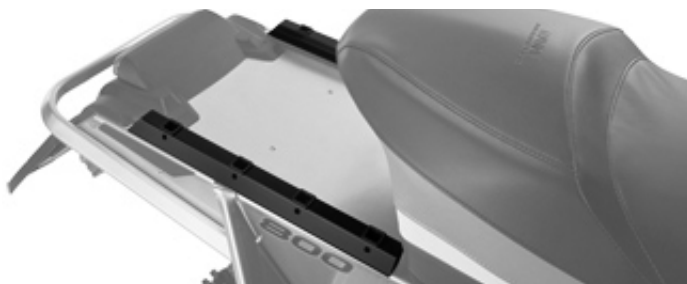

Page 93

### TUNNEL RAILS

Includes mounting pockets for 2-Up seat and rack.

Application	p/n
'12 F5, F570; '10-'11 F Series, Z1, Z1 Turbo	5639-347
'10-'11 Z1 Turbo EXT; '11 F8 EXT	5639-348

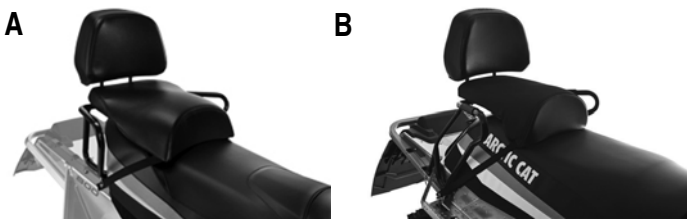

Page 93

### 2-UP SEAT KIT

Application	p/n
'12 F 800, F 1100, F 1100 Turbo, XF 800, XF 1100, XF 1100 Turbo (Requires Hitch Kit with mounting pockets)	5639-717
(A) '12 F5, F570; '10-'11 F Series, Z1, Z1 Turbo, Z1 Turbo EXT; '11 F8 EXT (Requires Tunnel Rails)	5639-307
(B) '09-'11 CF, CFR (Requires Hitch Kit with mounting pockets) - will accept rear rack or rear bag	5639-308
(C) '09 F Series (Liquid-Cooled), Z1, Z1 Turbo	5639-150
(C) '07-'08 F Series (Liquid-Cooled), JR	4639-451

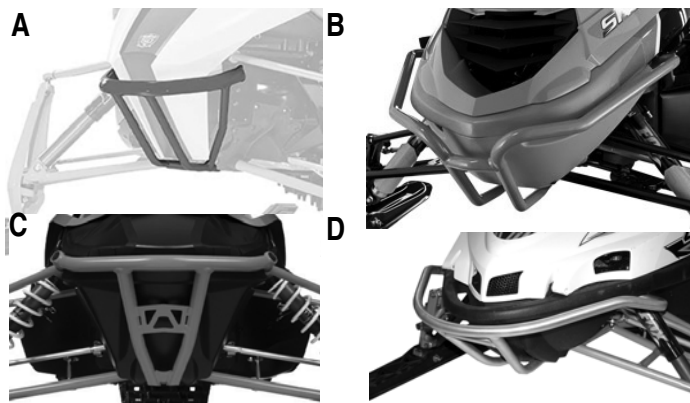

Page 94

### SPORT BUMPER - ALUMINUM

Application	Color	p/n
(A) '12 F 800, F 1100, M 800, M 800 HCR, M 1100, XF 800, XF 800 HC, XF 1100	Black Green Orange	5639-850 5639-851 5639-852
(B) '12 F5, F570; '07-'11 F Series; '08-'12 T570, TZ1 Touring; '09-'12 BC 570; '09-'11 Z1, Z1 Turbo	Black Green Orange	5639-825 5639-826 5639-827
(C) '10-'12 Sno Pro 500	Green	5639-065
(D) '05-'11 M SERIES; '06-'11 CF; '09-'11 CFR, M8 HCR	Black Green Orange	5639-622 5639-623 5639-624



Page 94

### TOURING BUMPER - STEEL

Top tube interferes with hood removal on turbo models.

Application	Color	p/n
'12 F5, F570; '07-'11 F Series; '08-'12 T570, TZ1 Touring; '09-'12 BC 570; '09-'11 Z1 (Non-Turbo)	Black	5639-312



### REPLACEMENT PIN

Description	p/n
Pin w/Clip (Each)	0441-555

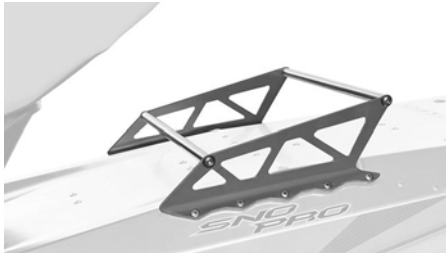

Page 94

## PROXCROSS RACK

**Application**

'12 F 800, F 1100, F 1100 Turbo, XF 800, XF 1100, XF 1100 Turbo

**Color**

Green 5639-718  
Orange 5639-719  
Silver 5639-720

**p/n**

■NOTE: XF High Country models require Proclimb Rack shown on page 35.



Page 94

## CROSSFIRE RACK

Requires Hitch Kit with mounting pockets.

**Application**

'09-'11 CF, CFR

**Color**

Green  
Orange  
Unpainted

**p/n**

5639-155  
5639-156  
5639-157



Page 94

## SPORT RACK

Mounts directly to the tunnel, or quick-attach to Tunnel Rails.

**Application**

'12 F5, F570; '10-'11 F Series; '10-'11 Z1, Z1 Turbo, Z1 Turbo EXT; '11 F8 EXT

**Color**

Green  
Orange  
Unpainted

**p/n**

5639-313  
5639-314  
5639-315



Page 95

## TOURING RACK

**Application**

'08-'12 T570, TZ1 Touring; '09-'12 BC 570

**Style**

(A) Short 5639-316  
(B) Long 5639-317

**p/n**



Page 95

## HITCH KITS - PIVOT STYLE

**Application**

'12 F 800, F 1100, F 1100 Turbo 128" (Includes Mounting Pockets for 2-Up Seat) 5639-721  
'12 XF 800, XF 1100, XF 1100 Turbo 141" (Includes Mounting Pockets for 2-Up Seat) 5639-722  
'12 M 800, M 800 HCR, M 1100, M 1100 Turbo, XF 800 HC, XF 1100 Turbo HC 153" 5639-723  
'12 M 800, M 1100 Turbo, M 1100 Turbo HCR 162" 5639-724  
'12 F5, F570; '10-'11 F Series, Z1, Z1 Turbo 128" 5639-318  
'10-'11 Z1 Turbo EXT; '11 F8 EXT 144" 5639-319  
'09 F Series, Z1, Z1 Turbo 128" 4639-966  
'09-'11 M Series; '10 M8 HCR 153" 5639-158  
'09-'11 M Series; '11 M8 HCR 153" 5639-159  
'09-'11 CF 141" (Includes Mounting Pockets for 2-Up Seat and Rack) 5639-166  
'09-'11 CFR 128" (Includes Mounting Pockets for 2-Up Seat and Rack) 5639-202  
'08-'12 T570, TZ1 Touring (Pivot) 4639-723  
'08-'12 T570, TZ1 Touring (Pintle) 4639-907  
'06-'08 CF; '07-'08 M Series 4639-788  
'07-'08 JR; '07-'08 F Series (Liquid-cooled) 4639-452  
'03-'06 FC; '04-'06 SC 128" & 144" 2639-686  
'00-'05 PTA; '04-'07 T660 Touring 1639-607  
'99-'02 PA; '99-'06 121-IN. Models; '07 Z, T660 Trail 1639-507



Page 95

## PINTLE CONVERSION KIT

**Application**

Fits Pivot-Style Hitch Kits

**p/n**

3639-189

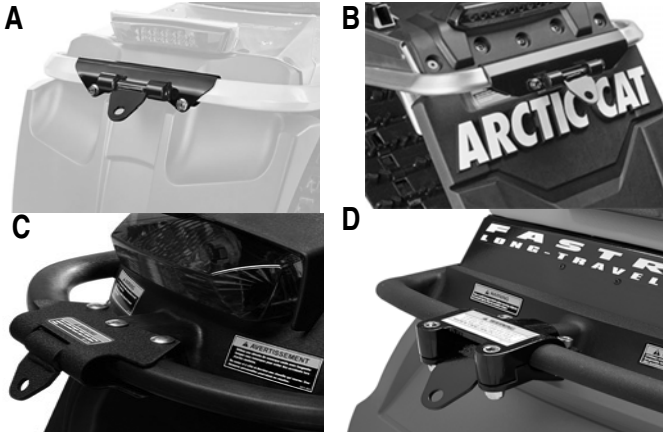

Page 95

### TOW HITCH

Application	p/n
(A) '12 F 800, F 1100, F 1100 Turbo, M 800, M 800 HCR, M 1100, M 1100 Turbo, M 1100 Turbo HCR, XF 800, XF 1100, XF 1100 Turbo, XF 800 HC, XF 1100 Turbo HC	5639-725
(B) '12 F5, F570; '10-'11 F Series; '09-'11 CF, CFR, M Series; '10-'11 Z1, Z1 Turbo, Z1 Turbo EXT; '11 F8 EXT	5639-324
(C) '05-'08 M Series; '06-'08 CF	4639-124
(D) '99-'06 121-in. Models; '07 Z, T660 Trail	1639-505



Page 96

### TETHER SWITCH

Application	p/n
'12 F 800, M 800, XF 800, XF 800 HC	5639-859
'12 F 1100, F 1100 Turbo, M 1100, M 1100 Turbo, XF 1100, XF 1100 Turbo, XF 1100 Turbo HC	5639-860
'07-'11 F LXR; '07-'12 T570; '09-'12 BC 570	4639-784
'07-'11 F Series Std & Sno Pro; '08-'11 CF, M Series; '09-'11 CFR; '99-'07 Normally Open Circuits	4639-140
'08-'09 TZ1; '09 Z1, BC Z1 XT (inc. Turbo)	4639-785
'10-'11 Z1; '10-'12 TZ1, BC Z1 XT Normally Closed Circuits	5639-523 0638-887
Replacement Tether Cord	0709-055



Page 96

### HEATED SEAT KIT

NOTE: Not available for 2-stroke - power output insufficient.

Application	Year	p/n
F 1100, F 1100 Turbo, XF 1100, XF 1100 Turbo	'12	5639-828
M 1100, M 1100 Turbo	'12	5639-829
BC Z1 XT (Driver & Passenger)	'09-'12	4639-971
BC Z1 XT LTD (Passenger)	'11-'12	5639-638



Page 96

### ELECTRIC START KIT

For replacement parts, see appropriate parts manual.

Application	p/n
'10 BC 570	5639-321
'08-'11 CF, M Series 500, 600	4639-803
'08-'11 F Series 500, 600	4639-782
'11 F Series 800	5639-646
'09-'10 F Series 800, 1000	5639-198



### DC POWER KIT

Application	Year	p/n
F 800, M 800, XF 800	'12	5639-858
CF, CFR, M Series 800/1000	'09-'11	5639-258



### ENGINE HEATER

Application	p/n
'12 F 1100, F 1100 Turbo, M 1100, M 1100 Turbo, XF 1100, XF 1100 Turbo, XF 1100 Turbo HC	5639-861
'07-'12 TZ1; '09-'12 BC Z1 XT, TZ1 Turbo; '07-'11 Z1, Z1 Turbo	5639-823
'99-'07 LC Models except CF, F, FC, JR, M, SC, 4-Stroke	0638-188

**A**



**B**



**REMOTE START KIT**

**Application**

'08-'12 TZ1 Touring; '09-'11 BC Z1 XT, Z1, Z1 Turbo

**Replacement Transmitter**

- (A) 2 Button
- (B) 3 Button

Year	p/n
'08-'11	5639-531

0630-146
0630-187

Replacement Battery A23S 12V (purchase locally)

■ **NOTE: For programming instructions, please visit Cat Tracker Online.**

**BATTERIES**

**Application**

- BC 570
- BC 570 XT
- BC Z1 XT
- CF 500
- CF 600
- F5
- F570
- F6
- F8, F 1000
- F 1100, F 1100 Turbo
- M 1100, M 1100 Turbo
- M6
- T500
- T570
- TZ1 Touring
- TZ1 Turbo Touring
- XF 1100, XF 1100 Turbo
- Z1, Z1 Turbo

Year	p/n
'09-'12	0745-047
'04-'08	0745-059
'09-'12	0745-047
'09-'12	0645-480
'07-'09	0645-480
'06-'11	0645-480
'07-'12	0745-047
'08-'12	0745-047
'07-'11	0745-047
'07-'11	0645-480
'12	0645-480
'12	0645-480
'05-'11	0645-480
'08-'09	0745-047
'08-'12	0745-047
'08-'12	0645-480
'09-'12	0645-480
'12	0645-480
'09-'11	0645-480



## Windscreens

Page 99

	'12 F 800, F 1100, M 800, M 1100, XF 800, XF 1100 (Inc Turbo)			'12 F5, F570; '07-'11 F Series; '09-'11 Z1; '09-'12 Bearcat, TZ1			'05-'11 M Series; '06-'11 CF; '09-'11 CFR, M8 HCR		
	p/n	Height	Width	p/n	Height	Width	p/n	Height	Width
<b>Extreme Low</b>									
Black	5639-790	8"	15 1/2"				5639-525		
White	5639-791	8"	15 1/2"				5639-526		
<b>Flyscreens</b>									
Black	5639-794	11"	15 1/2"	5639-132	5 1/2"	29"	5639-140	12"	25 1/2"
Green	5639-792	11"	15 1/2"				5639-138	12"	25 1/2"
Orange	5639-793	11"	15 1/2"				5639-139	12"	25 1/2"
<b>Windscreens</b>									
Low, Black	5639-797	13"	20"	5639-130	7 1/2"	29"	5639-136	14 1/2"	27 3/4"
Low, Green	5639-795	13"	20"	5639-128	7 1/2"	29"	5639-134	14 1/2"	27 3/4"
Low, Orange	5639-796	13"	20"	5639-129	7 1/2"	29"	5639-135	14 1/2"	27 3/4"
Low, Pink	5639-798	13"	20"	5639-178	7 1/2"	29"			

**Side Deflectors (Pair) Fits Low Windscreens 5639-795, 5639-796, 5639-797, 5639-798 (Width 24 1/2")**

<b>Windscreens</b>									
Low, Tint				5606-960	8 1/2"	29"			
Mid, Tint	5639-799	16"	30"	5639-439	12"	33"	4639-203	16"	29 3/4"
Mid, Clear, Green	5639-916	16"	30"						
Mid, Clear, Orange	5639-917	16"	30"						
Mid, Clear, Pink	5639-800	16"	30"	5639-631	12"	33"			
High, Tint	5639-801	19"	32"	4639-719	15 1/4"	33"	4639-227	18 1/2"	29 3/4"
Extreme High, Clear				5639-222***	20 1/2"	33"			

\*\*\*Extreme High Windshield requires Brace kit (5639-628)

<b>Windscreens</b>	'10-'12 Sno Pro 500; '08-'11 Sno Pro 600			'09-'12 TZ1 Turbo; '09-'11 Z1 Turbo			'04-'06 KC; '01-'04 MC500-900; '02-'05 PTA; '01-'08 PA; '01-'07 Z; '01-'03 ZL; '00-'06 ZR		
Low, Black	5639-449	8 1/2"	30"	5639-142*	10"	31"			
Low, Green	5639-451	6"	25"	5639-465*	10"	31"	5639-221	12"	32"
Mid, Tint	5639-615	13"	32"	5606-669*	10"	31"	2606-471	14 1/2"	31 1/2"
High, Tint	5639-500	16"	32"	5639-154**	15"	31"	2606-163	16"	33"

\*Turbo Low/Mid Windshield requires Brace Kit (5639-518) \*\*Turbo High Windshield requires Brace Kit (5639-455)

<b>Windscreens</b>	'03-'06 FC, SC			'99-'01 600 Touring, PTA; '99-'02 MC 1000; '99-'02 TC, ZRT			'98-'00 PS, Z, ZL; '98-'99 ZR		
Low, Green	5639-220	11 3/4"	32 3/4"						
Low, Tint							1606-818	12 1/4"	30 1/4"
Mid, Tint	3606-943	13 3/4"	31 3/4"	1606-323	14"	31"	1606-074	15 3/4"	28"
High, Tint				1606-541	17 1/2"	31"			

<b>Windscreens</b>	'06-'08 BC WT Turbo; '04-'07 T660		
High, Tint	3639-906	20"	33"

<b>Production Windscreens</b>	'12 F, M, XF		
Sno Pro, Black	6606-376	8 1/2"	20"
Mountain, Black	6606-134	13 1/2"	25 1/2"
LXR, Tint	6606-377	16 1/2"	27 1/2"

■NOTE: If replacing the adjustable windshield on '07 F Series and JR, Windshield Mounting Kit (p/n 4639-735) is required.

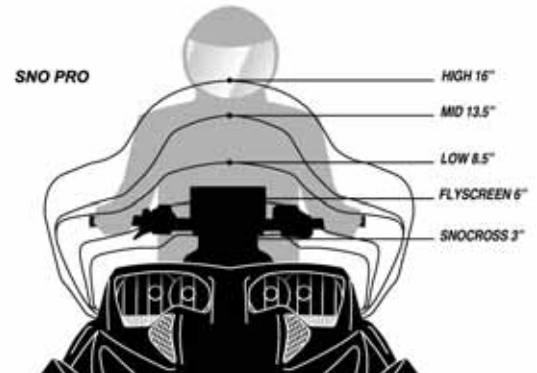
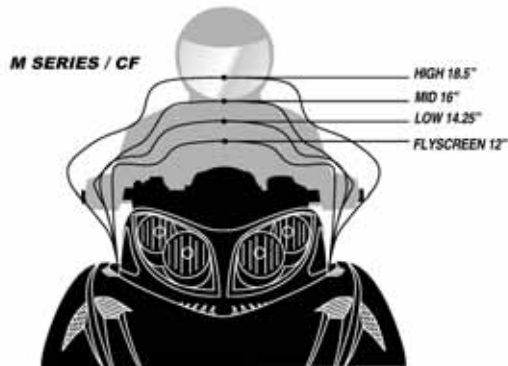
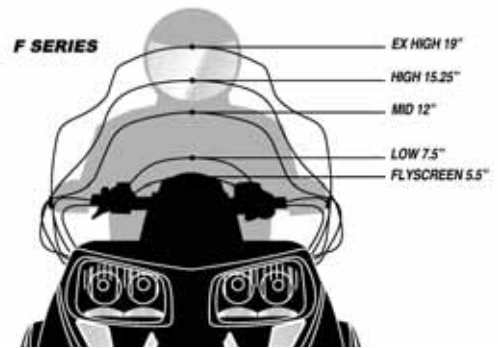
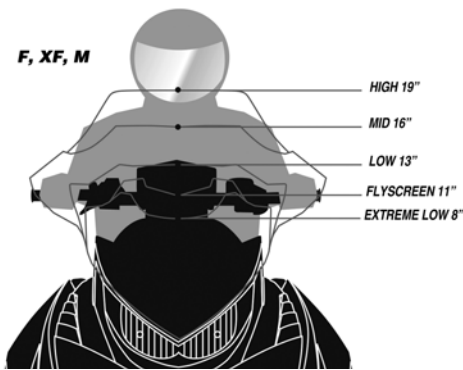

Measurements are taken vertically from dash panel to top of windshield. Style illustrations apply to indicated models only. Use reference point to determine style of windshield to order. Style of windshield for all other models is determined by measuring upward from lowest front center point on windshield to top center point. Accessory windshields do not have pre-drilled mirror mounting holes.



Page 99

**A. WINDSHIELD BRACE KIT**

**Application**

Turbo Low/Mid Windshield (5606-669, 5639-142, 5639-465)  
Turbo High Windshield (5639-154)  
Extreme High Windshield (5639-222)

**p/n**

5639-518  
5639-455  
5639-628

**B. WINDSHIELD MOUNTING RING**

**Description**

Universal (Each)

**p/n**

2606-853

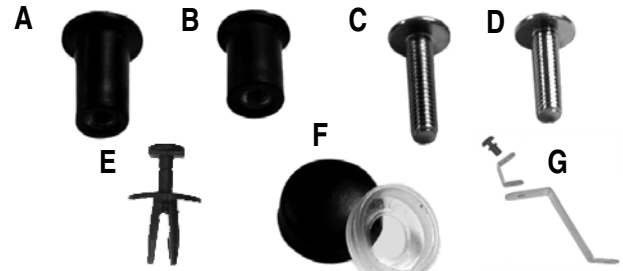

**WINDSHIELD HARDWARE**

**Description**

(A) Expansion Nut 10-32 Long	0123-010
(B) Expansion Nut 10-32 Short	0623-845
(B) Expansion Nut M5	1623-764
(C) Screw 10-32 x 3/4	0623-121
(D) Screw 10-32 x 5/8	0623-902
(D) Screw M5	8477-516
(E) Rivet, Plastic	0623-362
(F) Snap Cap w/Washer	0124-054
(G) Mounting Kit - Required when replacing adjustable windshield on '07 F Series and JR	4639-735

## Custom Accessories

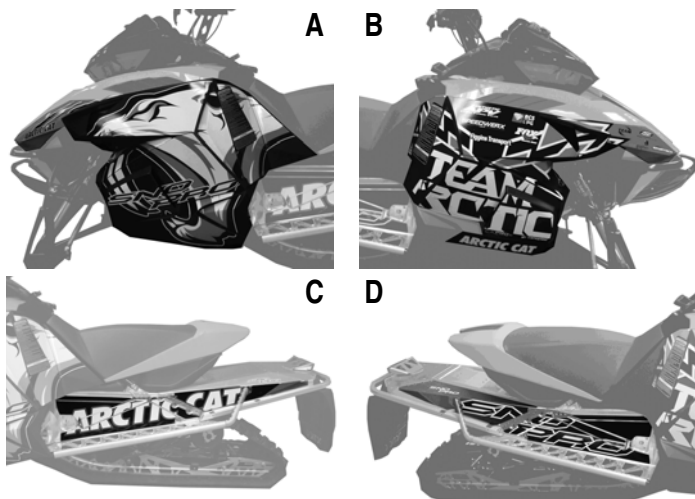

### GRAPHIC KITS

Bold, new graphics are available in two styles. Hood and Tunnel kits sold separately. Includes RH & LH Graphics. Fits all '12 F, M, and XF models.

#### Hood Graphics

	p/n
(A) Sabertooth - Green	5639-918
(A) Sabertooth - Orange	5639-919
(B) Team Arctic - Green	5639-920
(B) Team Arctic - Orange	5639-921

#### Tunnel Graphics

	p/n
(C) Arctic Cat - Green	5639-922
(C) Arctic Cat - Orange	5639-923
(D) Sno Pro - Green	5639-928
(D) Sno Pro - Orange	5639-929



Page 100

### PINK ACCESSORY KITS

#### Application

	p/n
'12 F 800 LXR, F 1100 LXR (Black)	5639-727
'12 XF 800 LXR, XF 1100 LXR (Black)	5639-728
'12 F570	5639-806
'12 F5 LXR	5639-838
'11 F 570	5639-576
'11 F5 LXR	5639-607
'11 F8, Z1 LXR	5639-608



Page 101

### FOX FLOAT 2

Sold in pairs. Includes pump.

#### Application

	p/n
'12 F 800, F 1100, F 1100 Turbo, XF 800, XF 1100, XF 1100 Turbo (42" Ski Stance)	5639-729
'12 M 800, M 1100, M 1100 Turbo (40" Ski Stance)	5639-730
'12 F5, F570; '07-'11 F Series; '09-'11 Z1, Z1 Turbo	5639-583
'05-'11 M Series	5639-584
'06-'11 CF; '09-'11 CFR	5639-585
'10-'12 Sno Pro 500	5639-586



Page 101

### FOX FLOAT EVOL

Sold in pairs. Includes pump.

#### Application

	p/n
'12 F 800, F 1100, F 1100 Turbo, XF 800, XF 1100, XF 1100 Turbo (42" Ski Stance)	5639-731
'12 M 800, M 1100, M 1100 Turbo (40" Ski Stance)	5639-732



Page 101

### FOX FLOAT R EVOL

Sold in pairs. Includes pump.

#### Application

	p/n
'12 F 800, F 1100, F 1100 Turbo, XF 800, XF 1100, XF 1100 Turbo (42" Ski Stance)	5639-733
'12 M 800, M 1100, M 1100 Turbo, M 1100 Turbo HCR (40" Ski Stance)	5639-734
'12 F5, F570; '07-'11 F Series; '09-'11 Z1, Z1 Turbo	5639-587
'05-'11 M Series	5639-588
'06-'11 CF; '09-'11 CFR	5639-589
'10-'12 Sno Pro 500	5639-590



Page 101

**FOX FLOAT RC2 EVOL**

Sold in pairs. Includes pump.

Application	p/n
'12 F 800, F 1100, F 1100 Turbo, XF 800, XF 1100, XF 1100 Turbo (42" Ski Stance) (XC Valving)	5639-735
'10-'12 Sno Pro 500 (XC Valving)	5639-625
'10-'12 Sno Pro 500 (Sno Cross Valving)	0641-250



Page 102

**SUSPENSION BLOCKS**

Application	p/n
<b>Universal</b>	
Black (Pair)	4639-853
Silver (Pair)	4639-855



Page 101

**FOX FLOAT 2 REAR ARM**

Application	p/n
'12 M 800, M 1100, M 1100 Turbo, XF 800, XF 1100, XF 1100 Turbo; '08-'11 M Series	5639-750



Page 102

**RECOIL HANDLE**

Description	p/n
Black	5639-452
Silver	5639-454



Page 101

**AIRSHOX GUARDS**

Description	Color	p/n
Fox Float, Float 2, Float Evol, Float R Evol (Pair)	Black	4639-044
	Green	4639-135
	Orange	4639-136

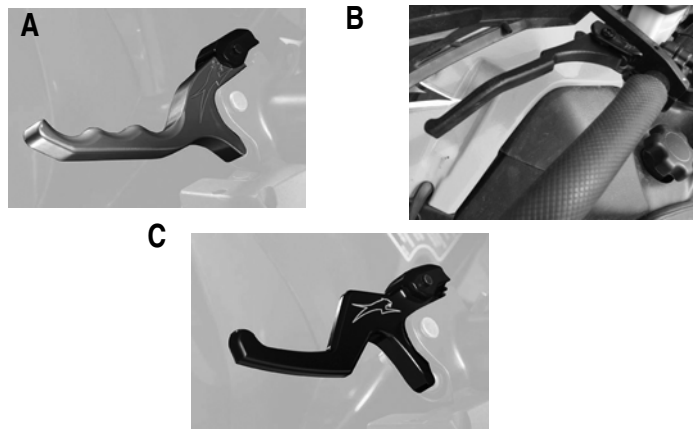

Page 102

**BRAKE LEVER**

Application	p/n
<b>Billet Brake Lever - '12 F 800, F 1100, F 1100 Turbo, M 800, M 800 HCR, M 1100, M 1100 Turbo, M 1100 Turbo HCR, XF 800, XF 1100, XF 1100 Turbo</b>	
Black	5639-736
Silver	5639-737
<b>(A) Billet Brake Lever - '12 F5, F570; All '07-'11 Models (Excludes Sno Pro 500)</b>	
Black	4639-797
Silver	4639-799
<b>(B) Sno Pro Lever - '10-'12 Sno Pro 500</b>	
Black	5639-619
Silver	5639-620
<b>(C) Shorty Lever - '12 F5, F570; All '07-'11 Models (Excludes Sno Pro 500)</b>	
Black	5639-505
Silver	5639-506

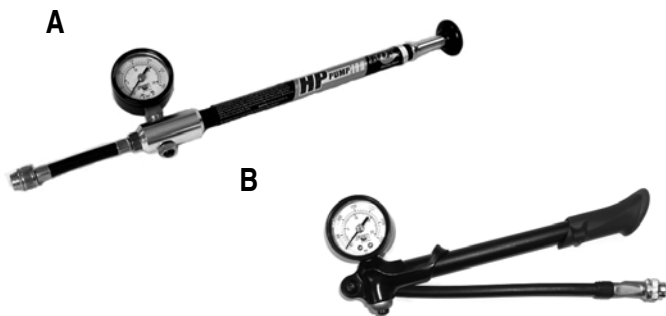

**AIRSHOX PUMP**

Application	p/n
(A) Replacement Pump - 150 psi (Float, Float 2)	2603-614
(B) Replacement Pump - Dual 100 psi; 300 psi (Float Evol, Float R Evol, Float RC2 Evol)	0641-257



Page 102

### AXLE WASHERS

Application	Color	p/n
'12 F 800, F 1100, F 1100 Turbo, M 800, M 800 HCR, M 1100, M 1100 Turbo, M 1100 Turbo HCR, XF 800, XF 1100, XF 1100 Turbo; '09-'11 M Series, M8 HCR	Black Silver	5639-591 5639-592



Page 102

### POD SCREWS - PAIR

Application	Color	p/n
'12 F5, F570; '07-'11 F Series; '08-'12 T570, TZ1 Touring; '09-'12 BC 570; '09-'11 Z1, Z1 Turbo	Black Silver	5639-593 5639-594



Page 103

### SNO PRO HAND GUARDS

Sold in pairs. Mounts sold separately. Requires low windshield.

Description	p/n
Black	5639-581
Green	5639-384
Orange	5639-261
White	5639-262

Fits Mounts A, B



Page 103

### HAND GUARD EXTENSION

Sold in pairs. Black.

Application	p/n
Sno Pro Hand Guards	5639-263

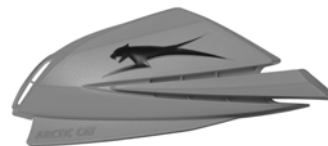

Page 103

### ARCTIC CAT HAND GUARDS

Sold in pairs. Mounts sold separately. Requires low windshield.

Description	p/n
Black	4639-806
Green	4639-807
Orange	4639-808
Pink	5639-179

Fits Mounts C, D, E

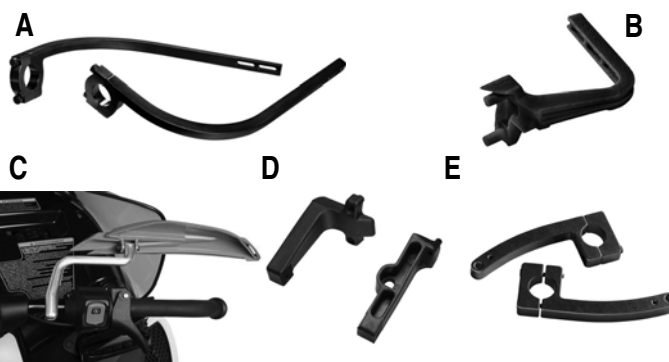

Page 103

### HAND GUARD MOUNTS

Sold in pairs.

	'12 F 800, F 1100 (Inc Turbo)	'12 M 800, M 1100, XF 800, XF 1100 (Inc Turbo)	'10-'12 SP 500	'12 F5, F570 '09-'11 CFR '07-'11 F Series '09-'11 Z1, Z1 Turbo
	p/n	p/n	p/n	p/n
(A) Aluminum	5639-264	N/A	5639-264	5639-264
(B) Nylon	5639-763	5639-763	N/A	5639-385
(C) Aluminum	N/A	N/A	4639-805	4639-805
(D) Nylon	N/A	N/A	N/A	4639-804
(E) Aluminum	N/A	N/A	N/A	N/A

	'07-'11 CF '07-'11 M '09-'11 M8 HCR	'06 CF '05-'06 M '00-'02 ZR	'03-'06 FC
	p/n	p/n	p/n
(A) Aluminum	N/A	N/A	5639-264
(B) Nylon	5639-385	N/A	N/A
(C) Aluminum	N/A	N/A	4639-805
(D) Nylon	4639-804	3639-077	3639-078
(E) Aluminum	N/A	N/A	3639-858

#### Replacement Hardware

For p/n 4639-804	0641-987
For p/n 5639-264	0641-261
For p/n 5639-385, 5639-763	0641-258



Page 103

**HANDLEBAR GRIPS**

Two 8-in. black grips. Cut to length.

**Description**  
Black (Pair)

**p/n**  
5639-655

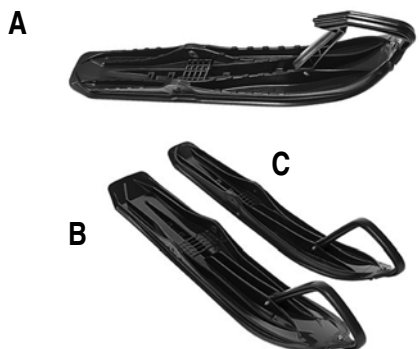

Page 104

**ARCTIC CAT SADDLELESS SKIS**

Includes 4" carbides. Fits all applications (97 & Newer Models) except cast-aluminum spindle (see Universal Plastic Skis). Sold in pairs.

**Description**

(A) 6" Ski Kit (Standard Keel) - Mountain Ski  
 (A) 6" Ski Kit (Competition Keel) - Mountain Ski  
 (B) 8" Ski Kit - Black - Trail Ski  
 (C) 6" Ski Kit - Black - Trail Ski  
 Replacement Wearbars (See page 49, Ref A)

**p/n**  
5639-877  
5639-878  
5639-323  
5639-322



Page 104

**C&A PRO ADX SKIS**

Fits all applications except cast aluminum spindles. Includes mounting hardware. Wearbars sold separately. Sold in pairs.

**Description**

6" Ski Kit - Black  
 Replacement Wearbars (See page 49, Ref E)

**p/n**  
5639-603



Page 104

**SLP POWDER PRO SKIS™**

Wearbars sold separately. Fits all applications except cast-aluminum spindle. Sold in pairs.

**Description**

7" Ski Kit - Black  
 Replacement Wearbars (See page 49, Ref D)

**p/n**  
5639-326

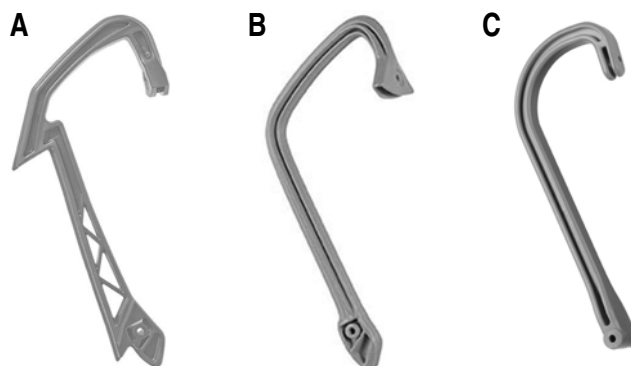

Page 104

**ARCTIC CAT SKI HANDLES**

Sold in pairs.

**Description**

**(A) '12 Arctic Cat Saddleless Skis**

Green  
 Orange

**p/n**  
5639-743  
5639-744

**(B) '05-'11 Arctic Cat Saddleless Skis**

Green  
 Orange

3639-777  
 3639-778

**(C) Arctic Cat & Parabolic Skis**

Green  
 Orange

3639-781  
 3639-865



**BLOW-MOLDED SKIS**

Includes 4" carbides. Fits all '09 and earlier applications except cast aluminum spindle. Sold in pairs.

**Description**

5" Ski Kit - Black  
 Replacement Wearbars (See page 49, Ref C)

**p/n**  
1639-575



## UNIVERSAL PLASTIC SKIS

Fits all '09 and earlier Arctic Cat independent front suspensions including cast aluminum spindle style pictured. Includes 4" carbides and all hardware for conversion. Sold in pairs.

Description	p/n
Ski Kit - Black	0639-225
Replacement Wearbars (See page 49, Ref B)	

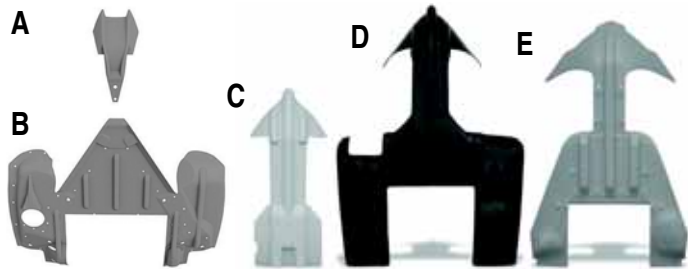

Page 105

## SKID PLATES

■ **NOTE:** '10-'11 Z1 models require trimming for exhaust outlet.

Application	p/n
<b>(A) '12 F 800, F 1100, M 800, M 800 HCR, M 1100, XF 800, XF 800 HC, XF 1100</b>	
Black - Front	5639-745
Green - Front	5639-746
Orange - Front	5639-747
White - Front	5639-748
<b>(B) '12 F 800, F 1100, F 1100 Turbo, M 800, M 800 HCR, M 1100, M 1100 Turbo, M 1100 Turbo HCR, XF 800, XF 800 HC, XF 1100, XF 1100 Turbo, XF 1100 Turbo HC</b>	
Black - Rear	5639-893
Green - Rear	5639-894
Orange - Rear	5639-895
White - Rear	5639-896
<b>(C) '05-'11 M Series; '06-'11 CF; '09-'11 CFR, M8 HCR</b>	
Black	3639-838
Green	3639-839
Orange	4639-564
White	5639-582
Replacement Hardware (includes 12 Steel Rivets (3/16" x .925"), 2 Steel Rivets (3/16" x .750"), and 4 Washers (3/16" x 3/4"))	0641-719
<b>(D) '05-'11 M SERIES; '06-'11 CF; '09-'11 CFR, M8 HCR</b>	
Heavy-Duty Black	5639-223
<b>(E) '12 F5, F570; '10-'11 F Series; '08-'12 T570, TZ1 Touring; '09-'11 Z1, Z1 Turbo; '10-'11 Z1 Turbo EXT; '11 F8 EXT</b>	
Black	4639-567
Green	4639-568
Orange	4639-569
Replacement Hardware (includes 10 Steel Rivets (3/16" x .750"), 8 Washers (1/4" x 1"), 4 Pan-Head Screws (1/4"-20 x 1.1/4"), 1 Pan-Head Screw (1/4"-20 x 2 1/4"), and 5 Nyloc Nuts (1/4"-20))	4639-684
<b>'00-'06 ZR; '01-'03 ZL; '01-'04 MC; '01-'08 Z; '04-'06 KC</b>	
Black	1639-417
Replacement Hardware	0641-508



Page 105

## GRIP PLATES - PAIR

Application	Color	p/n
'12 F5, F570; '10-'11 F Series; '10-'11 Z1, Z1 Turbo, Z1 Turbo EXT; '11 F8 EXT	Black	5639-328
	Green	5639-329
	Orange	5639-330



Page 105

## GRIPPER SEAT COVER

Application	p/n
'12 F 800, F 1100, F 1100 Turbo, XF 800, XF 1100, XF 1100 Turbo	5639-845
'12 M 800, M 800 HCR, M 1100, M 1100 Turbo, M 1100 Turbo HCR, XF 800 HC, XF 1100 Turbo HC	5639-846
'10-'12 Sno Pro 500	5639-667
'10-'11 M Series, M8 HCR	5639-666

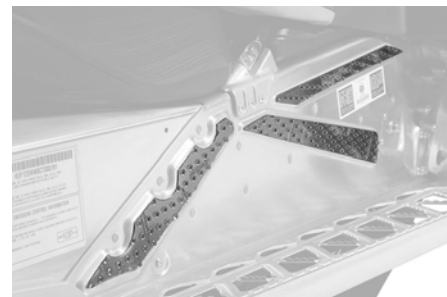

Page 105

## TUNNEL GRIPS

Application	p/n
'12 F 800, F 1100, F 1100 Turbo, M 800, M 800 HCR, M 1100, M 1100 Turbo, XF 800, XF 1100, XF 1100 Turbo	5639-839

**SNOW MESH**

Hood mesh not for use on Fan-Cooled Models.

<b>Application</b>	<b>p/n</b>
<b>Bumper (Coarse Mesh)</b>	
'12 F 1100, F 1100 Turbo, M 1100, M 1100 Turbo, M 1100 Turbo HCR, XF 1100, XF 1100 Turbo, XF 1100 Turbo HC	5639-836
'12 F5, F570; '10-'11 F Series; '08-'12 T570, TZ1 Touring; '09-'12 BC 570; '09-'11 Z1	5639-332
'09-'12 TZ1 Turbo Touring, '09-'11 Z1 Turbo	5639-352
'05-'11 M Series; '06-'11 CF; '09-'11 CFR, M8 HCR	5639-169
'09-'12 BC 570 XT, BC Z1 XT (See page 41)	5639-522
<b>Hood (Coarse Mesh) (Liquid-Cooled Models)</b>	
'12 F5; '07-'11 F Series; '08-'12 TZ1 Touring; '09-'12 BC Z1 XT; '09-'11 Z1 (Non-turbo)	5639-458
'05-'11 M Series; '06-'11 CF; '09-'11 CFR, M8 HCR	5639-333
'10-'12 Sno Pro 500	5639-396
'03-'06 FC, SC	5639-633
<b>Clutch (Coarse Mesh)</b>	
'12 F 800, F 1100, F 1100 Turbo, M 800, M 800 HCR, M 1100, M 1100 Turbo, M 1100 Turbo HCR, XF 800, XF 800 HC, XF 1100, XF 1100 Turbo, XF 1100 Turbo HC	5639-835
<b>Intake (Fine Mesh)</b>	
'12 F 800, F 1100, F 1000 Turbo, XF 800, XF 1100, XF 1100 Turbo	5639-947
'05-'11 M Series; '06-'11 CF; '09-'11 CFR, M8 HCR	5639-334
<b>Side Panel, Rear (Coarse Mesh)</b>	
'09-'12 BC Z1 XT	5639-499



**SNOWFLAP**

<b>Application</b>	<b>p/n</b>
'12 F 800, F 1100, F 1100 Turbo, XF 800, XF 1100, XF 1100 Turbo Green	5639-840
Orange	5639-841
'12 M 800, M 800 HCR, M 1100, M 1100 Turbo, M 1100 Turbo HCR, XF 800 HC, XF 1100 Turbo HC Green	5639-842
Orange	5639-843

p/n 5639-332

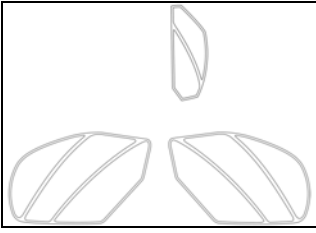

p/n 5639-352

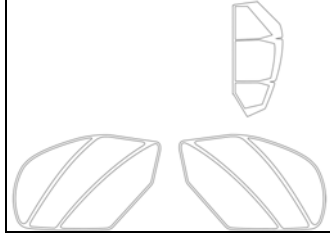

p/n 5639-169

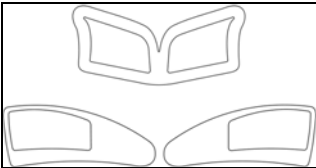

p/n 5639-333

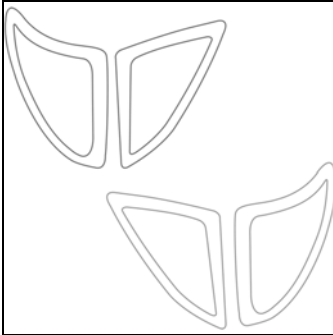

p/n 5639-458

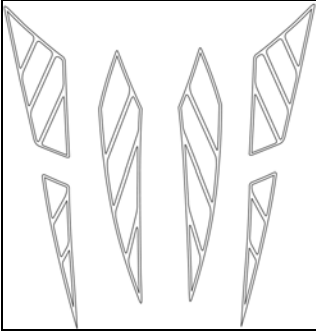

p/n 5639-334

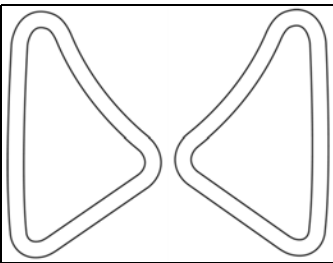

p/n 5639-396

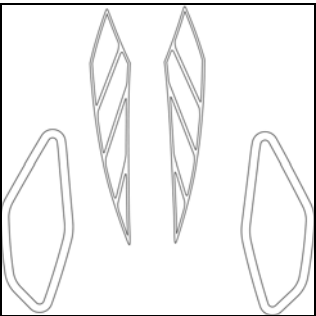

p/n 5639-499



p/n 5639-836

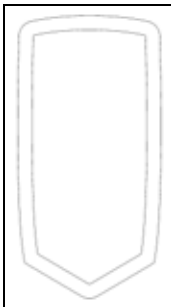

p/n 5639-633



p/n 5639-835

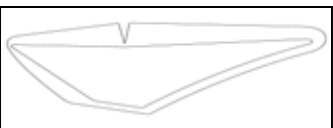

p/n 5639-947

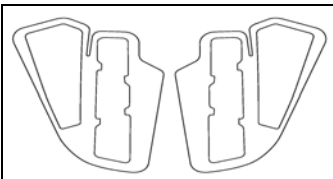



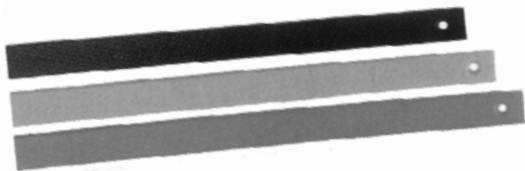

Page 106

## WEAR STRIPS

Sold individually.

Application	p/n
<b>121-128"</b>	
Green	2604-819
Orange	2604-289
Black	2604-257
White	2604-543
<b>136-162"</b>	
Green	2604-821
Orange	1604-769
Black	2604-799



Page 107

## HEADLIGHT COVERS

Not for use at night.

Application	p/n
<b>'12 F 800, F 1100, F 1100 Turbo, M 800, M 800 HCR, M 1100, M 1100 Turbo, M 1100 Turbo HCR, XF 800, XF 800 HC, XF 1100, XF 1100 Turbo, XF 1100 Turbo HC</b>	
Chrome	5639-753
Green Chrome	5639-754
Smoke	5639-755
<b>'12 F5, F570; '07-'11 F Series; '10-'11 Z1, Z1 Turbo, Z1 Turbo EXT; '11 F8 EXT</b>	
Chrome	5639-756
Green Chrome	5639-757
Smoke	5639-758
<b>'05-'11 M Series; '06-'11 CF; '09-'11 CFR, M8 HCR</b>	
Chrome	5639-759
Green Chrome	5639-760
Smoke	5639-761
Replacement Velcro Dots (8 pc)	4639-625

**NOTE:** Some states and municipalities may have laws prohibiting the use of colored headlight covers. Please check state and local laws before using headlight covers. Arctic Cat Sales Inc. shall not be liable for any claims resulting from illegal use of headlight covers.



Page 107

## A-ARM DEFLECTORS

Application	Color	p/n
'12 F5, F570; '10-'11 F Series; '08-'12 T570, TZ1 Touring; '09-'12 BC 570; '09-'11 Z1	Black	4639-897
	Green	4639-898
	Orange	4639-899



Page 107

## A. HOOD-MOUNTED MIRRORS

Application	p/n
<b>'12 F 800, F 1100, F 1100 Turbo, M 800, M 800 HCR, M 1100, M 1100 Turbo, M 1100 Turbo HCR, XF 800, XF 800 HC, XF 1100, XF 1100 Turbo, XF 1100 Turbo HC</b>	
Single, RH	5639-830
Single, LH	5639-831
Pair	5639-832

## B. WINDSHIELD MIRRORS

Application	p/n
<b>'12 F5, F570; '10-'11 F Series; '08-'12 T570, TZ1 Touring; '09-'11 BC, Z1, Z1 Turbo</b>	
Black - Single	4639-734
Black - Pair	4639-733

## C.-D. COMPACT MIRRORS

Sold individually.

Application	p/n
(C) '05-'11 M Series; '06-'11 CF; '09-'11 CFR, M8 HCR	4639-463
(D) '12 F5, F570; '10-'11 F Series; '08-'12 T570, TZ1 Touring; '09-'11 BC, Z1, Z1 Turbo	4639-565



Page 107

## HAND MIRROR

Description	p/n
Hand Mirror	4992-810



**TOE HOLD**

Sold in pairs.

**Application**

'10-'12 Sno Pro 500

**p/n**

5639-611



**RECOIL HANDLE**

Sold individually.

**Description**

Black  
Green  
Orange

**p/n**

0636-363  
3639-866  
3639-867



**WHEELS (IDLER WHEELS)**

Includes bearing. Sold individually.

Description	p/n	Description	p/n
<b>(A) 5.63" x .787" ID</b>		<b>(A) 7.12" x .787" ID</b>	
Black	3604-386	Black	3604-063
Green	3604-047	Green	3604-066
Orange	3604-048	Orange	3604-065
Pink	3604-379	Pink	3604-380
Red	3604-044	Red	3604-064
Silver	3604-043	Silver	3604-062
Yellow	3604-040	Yellow	3604-068
<b>(A) 5.63" x .625" ID</b>		<b>(A) 7.12" x .625" ID</b>	
Green	1604-691	Black	1604-683
Silver	1604-693	Green	1604-745
Yellow	2604-122	Silver	1604-971
<b>(A) 6.38" x .787" ID</b>		<b>(B) 8.00" x .787" ID</b>	
Black	3604-387	Black	3604-073
Green	3604-053	Green	3604-075
Orange	3604-054	Orange	3604-071
Red	3604-052	Red	3604-074
Silver	3604-055	Silver	3604-076
<b>(A) 6.38" x .625" ID</b>		<b>(C) 5.63" x .625" ID</b>	
Green	1604-692	Green	0604-981
Orange	1604-765	<b>(C) 6.38" x .625" ID</b>	
Red	1604-767	Green	0604-980
Silver	1604-694		

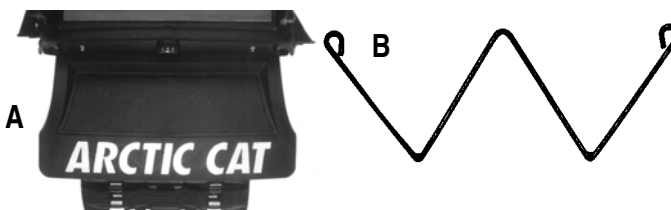

**A. SHORT SNOWFLAP**

**Application**

'99-'06 121" Models  
Models prior to '99

**p/n**

1606-507  
0616-613

**B. SNOWFLAP SUPPORT BRACKET**

**Application**

'99-'06 121" Models

**p/n**

2706-648

## Mountain Accessories

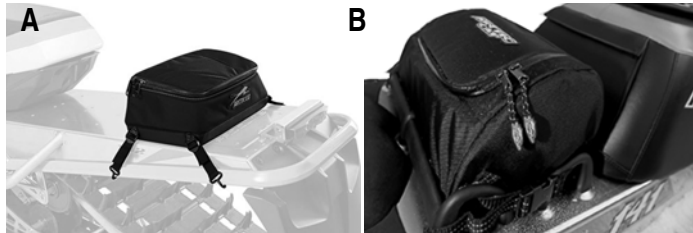

Page 109

### MOUNTAIN PACK

Application	p/n
(A) '12 M 800, M 800 HCR, M 1100, M 1100 Turbo, M 1100 Turbo HCR, XF 800, XF 800 HC, XF 1100, XF 1100 Turbo, XF 1100 Turbo HC; '09-'11 M Series; M8 HCR	5639-710
(B) '05-'08 M Series; '06-'08 CF	3639-725
Replacement Straps w/Hook (Pkg 4)	0641-994



Page 109

### MOUNTAIN GEAR BAG

Application	p/n
(A) '12 M 800, M 800 HCR, M 1100, M 1100 Turbo, M 1100 Turbo HCR, XF 800, XF 800 HC, XF 1100, XF 1100 Turbo, XF 1100 Turbo HC	5639-711
(B) '09-'11 M Series; M8 HCR	5639-044
(C) '05-'08 M Series; '06-'08 CF	4639-727
Replacement Straps w/Hook (Pkg 4)	0641-994

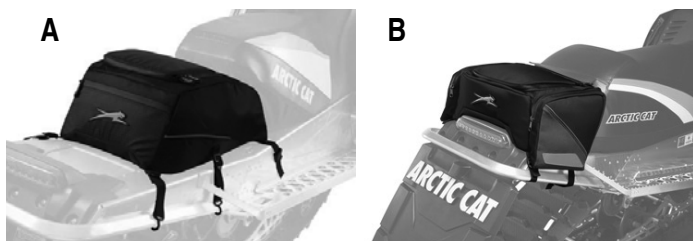

Page 109

### TUNNEL GEAR BAG

Application	p/n
(A) '12 F5, F570; '10-'11 F Series; M Series, Z1, Z1 Turbo, Z1 Turbo EXT; '11 F8 EXT	5639-574
(B) '09-'11 M Series, CF, CFR, M8 HCR	5639-043
Replacement Straps w/Hook (Pkg 4)	0641-994
Replacement Cam Buckles (Pkg 2)	0639-089



Page 109

### TUNNEL PACK

Application	p/n
'10-'12 Sno Pro 500; '10-'11 M Series	5639-433



Page 109

### HANDLEBAR BAG

Application	p/n
'12 M 800 SP, M 800 HCR, M 1100 SP, M 1100 Turbo SP, M 1100 Turbo HCR, XF 800 HC, XF 1100 Turbo HC; '09-'12 BC 570, BC XT; '05-'11 M Series; '06-'11 CF; '04-'06 KC	5639-709



Page 110

### TANK PADS

Sold in pairs.

Application	p/n
(A) '12 F 800, F 1100, F 1100 Turbo, M 800, M 800 HCR, M 1100, M 1100 Turbo, M 1100 Turbo HCR, XF 800, XF 1100, XF 1100 Turbo Black	5639-764
(B) '05-'11 M Series; '06-'11 CF; '09-'11 CFR, M8 HCR Black Green Orange	5639-050 5639-051 5639-052
Replacement Mounting Screw '05-'07 (Std)	8017-427
Replacement Mounting Screw '08-'10 (Metric)	8475-512
(C) '10-'12 Sno Pro 500 Black	5639-612



## TANK JACKET

Application	p/n
'05-'11 M Series; '09-'11 M8 HCR	
Black	5639-053
'06-'11 CF; '09-'11 CFR	
Black	5639-056
Replacement Velcro (Pair)	4639-602

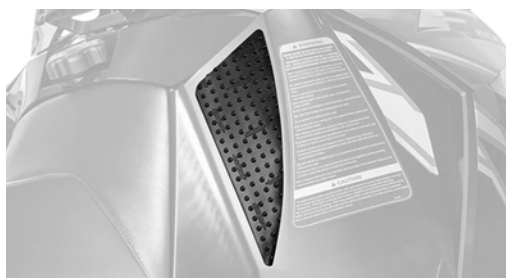

Page 110

## TANK GRIPS

Application	p/n
'12 F 800, F 1100, F 1100 Turbo, M 800, M 800 HCR, M 1100, M 1100 Turbo, M 1100 Turbo HCR, XF 800, XF 800 HC, XF 1100, XF 1100 Turbo, XF 1100 Turbo HC	5639-762



Page 110

## WINDSHIELD BAG

Application	p/n
'12 F 800, F 1100, F 1100 Turbo, M 800, M 800 HCR, M 1100, M 1100 Turbo, M 1100 Turbo HCR, XF 800, XF 1100, XF 1100 Turbo, XF 800 HC, XF 1100 Turbo HC	5639-712
'05-'11 M-Series; '06-'11 CF, '09-'11 CFR, M8 HCR	4639-428



Page 110

## GOGGLE HOLDER

**CAUTION:** Do not leave goggles in holder for an extended period of time. Excessive heat may damage goggles.

Application	p/n
(A) '12 F 800, F 1100, F 1100 Turbo, M 800, M 800 HCR, M 1100, M 1100 Turbo, M 1100 Turbo HCR, XF 800, XF 800 HC, XF 1100, XF 1100 Turbo, XF 1100 Turbo HC	5639-767
(B) '05-'11 M Series; '06-'11 CF; '09-'11 CFR, M8 HCR	4639-732



Page 110

## LINER BAG

Application	p/n
'10-'11 M Series, M8 HCR	5639-350

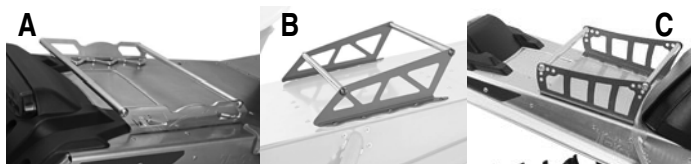

Page 111

## A. BILLET RACK

Application	p/n
'09-'11 M Series, M8 HCR	
Black	5639-597
Silver	5639-598

## B. PROCLIMB RACK

Application	p/n
'12 M 800, M 800 HCR, M 1100, M 1100 Turbo, M 1100 Turbo HCR, XF 800 HC, XF 1100 Turbo HC	
Green	5639-773
Orange	5639-774
Silver	5639-775

## C. M SERIES RACK

Application	p/n
'09-'11 M Series, M8 HCR	
Green	4639-975
Orange	4639-976
Unpainted	4639-977



Page 111

**RACK STRAP**

<b>Application</b>	<b>p/n</b>
(A) '12 M 800, M 800 HCR, M 1100, M 1100 Turbo, M 1100 Turbo HCR, XF 800, XF 1100, XF 1100 Turbo; '09-'11 M Series, M8 HCR, CF (Ratchet)	4639-978
(B) '05-'08 M Series; '06-'08 CF (Cam Buckle)	3639-579



Page 111

**MOUNTAIN SEAT**

<b>Application</b>	<b>Color</b>	<b>p/n</b>
'05-'09 M Series; '06-'11 CF; '09-'11 CFR	Black	5639-600
	Green	5639-601
	Orange	5639-602



Page 111

**BEARD MOUNTAIN SEAT**

<b>Application</b>	<b>p/n</b>
'05-'11 M Series; '06-'11 CF; '09-'11 CFR	5639-875



Page 112

**FLOAT AVALANCHE AIRBAGS**

For technical assistance, contact BCA at 303-417-1345, ext. 0. Includes pressurized air cylinder, requires hazardous material shipping.

<b>Description</b>	<b>p/n</b>
(A) Float 30	5639-482
(B) Float 18	5639-812



Page 112

**AVALANCHE BEACONS**

For technical assistance contact: BCA at 303-417-1345, ext. 0.

<b>Description</b>	<b>p/n</b>
(A) BCA Tracker DTS (457 kHz)	5639-267
(B) BCA Tracker 2 (457 kHz)	5639-610



Page 112

**BACKCOUNTRY KIT**

<b>Description</b>	<b>p/n</b>
BCA Squall Backpack, Tracker2 Beacon, B-1 EXT Shovel, Profile 240 Probe	5639-768



Page 113

**BACKPACKS**

**Description**

- (A) BCA Squall H<sup>2</sup>O - 2.0 lbs, 27 Liter capacity
- (B) BCA Throttle H<sup>2</sup>O - 3.3 lbs, 35 Liter capacity
- (C) Ogio Capital - 2.6 lbs, 34 Liter capacity

**p/n**

- 5639-769
- 5639-653
- 5639-432

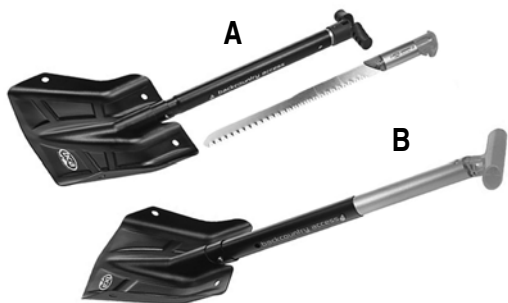

Page 113

**SNOW SHOVELS**

**Description**

- (A) BCA A-2 EXT with Saw (Extendable handle)
- (B) BCA B-1 EXT (Extendable handle)

**p/n**

- 5639-786
- 5639-770

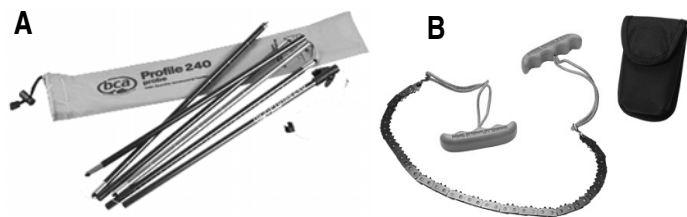

Page 113

**A. AVALANCHE PROBE**

**Description**

BCA Profile 240

**p/n**

5639-266

**B. POCKET SAW**

**Application**

Saw with Pouch

**p/n**

4639-979



Page 114

**ICE SCRATCHERS**

■NOTE: Models listed have mounting holes in rails. Installation on other models will require drilling mounting holes.

**Application**

'12 M 800, M 1100, M 1100 Turbo, XF 800, XF 800 HC, XF 1100, XF 1100 Turbo, XF 1100 Turbo HC; '09-'11 M Series, M8 HCR, CF

**p/n**

5639-897

Replacement Wire - RH

1704-734

Replacement Wire - LH

1704-735



Page 114

**VENTED HOOD PANELS**

**Description**

'12 F 800, F 1100, F 1100 TURBO, M 800, M 800 HCR, M 1100, M 1100 Turbo, M 1100 Turbo HCR, XF 800, XF 800 HC, XF 1100, XF 1100 Turbo, XF 1100 Turbo HC

**p/n**

**Hood Panel Kit with Screens**

- Black 5639-862
- Green 5639-863
- Orange 5639-864
- White 5639-991

**Screen Set Only**

Hood Screens (Pair) 5639-948

**Replacement Screens**

- Hood Screen - RH 6606-468
- Hood Screen - LH 6606-469



**VENTED HEADLIGHT COWL (INTAKE)**

**Description**

'12 F 800, F 1100, F 1100 TURBO, XF 800, XF 1100, XF 1100 Turbo

**p/n**

**Headlight Cowl with Screens**

Black 3718-

**Screen Set Only**

Headlight Cowl Screens (Pair) 5639-947

**Replacement Screens**

- Intake Screen - RH 0608-666
- Intake Screen - LH 0608-667

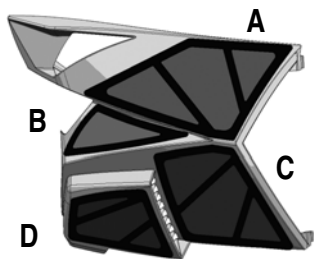

Page 114

## VENTED SIDE PANELS

**Description**

p/n

'12 F 800, F 1100, F 1100 Turbo, M 800, M 800 HCR, M 1100, M 1100 Turbo, M 1100 Turbo HCR, XF 800, XF 800 HC, XF 1100, XF 1100 Turbo, XF 1100 Turbo HC

Side Panel Kit with Screens

Black 5639-865  
Green 5639-866

**Screen Set Only**

Side Panel Screens (Set of 7) 5639-949

**Replacement Screens**

(A) Upper RH 6606-470  
(A) Upper LH 6606-471  
(B) Mid LH 6606-485  
(C) Lower, Rear - RH 6606-474  
(C) Lower, Rear - LH 6606-475  
(D) Lower, Front - RH 6606-472  
(E) Lower, Front - LH 6606-473

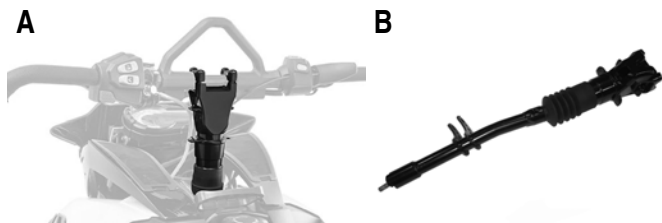

Page 115

## TELESCOPIC STEERING POST

■NOTE: Not available for CF5 - insufficient cable length.

**Application**

p/n

(A) '12 F 800, XF 800, M 800 (STD) 5639-813  
(B) '09-'11 M Series (Std), CF (Std) 5639-516



Page 115

## SWITCH GUARDS

**Application**

p/n

'12 M 800, M 800 HCR, M 1100, M 1100 Turbo, M 1100 Turbo HCR, XF 800, XF 800 HC, XF 1100, XF 1100 Turbo, XF 1100 Turbo HC; '07-'11 M Series; '09-'11 M8 HCR 5639-580

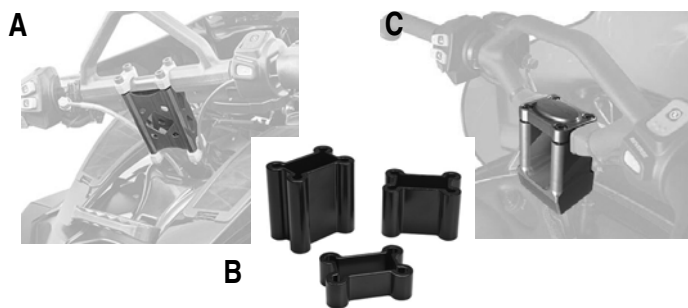

Page 115

## A. HANDLEBAR RISERS

**Application**

p/n

'12 F 800, F 1100, F 1100 Turbo, M 800 (STD), M 1100, M 1100 Turbo, XF 800, XF 1100, XF 1100 Turbo

4.5" - Black 5639-881  
5.5" - Black 5639-882  
6.5" - Black 5639-883  
7.5" - Black 5639-884  
8.5" - Black 5639-885  
4.5" - Green 5639-886  
5.5" - Green 5639-887  
6.5" - Green 5639-888  
7.5" - Green 5639-889  
8.5" - Green 5639-890

## B. HANDLEBAR RISERS

**Application**

p/n

'05-'11 M Series (STD); '06-'11 CF (STD)

1" - Black 5639-776  
2" - Black 5639-777  
3" - Black 5639-778

## C. ANGLED HANDLEBAR RISER

**Application**

p/n

'05-'11 M Series (STD); '06-'11 CF (STD)

2" - Silver 5639-503  
3" - Silver 5639-504



Page 115

## OFFSET RISER

**Application**

p/n

'09-'11 M Series; M8 HCR w/Telescopic Post

Black 5639-595  
Silver 5639-596



**Page 116**  
**MOUNTAIN STRAP**

**Application** '10-'11 Z1 Turbo EXT; '11 F8 EXT **p/n** 5639-358



**Page 116**  
**LIGHTWEIGHT FRONT AXLE KIT**

**Application** '05-'08 M Series **p/n** 4639-995



**Page 116**  
**RACK PAD**

**Application** '09-'11 M Series, M8 HCR, CF (12.75-in. Long) 4639-988  
'10-'11 F Series, Z1, Z1 Turbo, Z1 Turbo EXT; '11 F8 EXT (21-in. Long) 5639-351



**Page 116**  
**HI-TEMP CAM ROLLER**

Set of 6.

**Application** ACT Driven Pulley **p/n** 5639-468

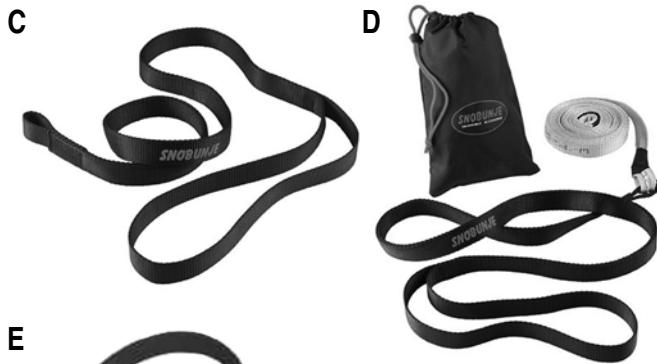
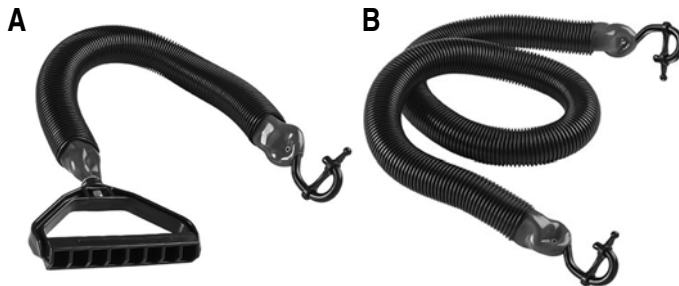

**Page 116**  
**SNOBUNJE PULLING TOOLS**

Description	p/n
(A) Rattler (32" Long, 1.5 lbs)	5639-639
(B) Cobra (52" Long, 2.5 lbs)	5639-640
(C) Adapter Strap (60" Long)	5639-642
(D) Slicktape 20 (20' Long)	5639-643
(E) Cobra Adapter Strap (15" Long)	5639-641



**Page 116**  
**PULL STRAP**

**Description** Pull Strap **p/n** 5639-512





**A. FOUR WHEEL KIT**

Adds two inside wheels.

**Application** p/n  
'09-'11 M Series 5639-528

**B. TWO WHEEL KIT**

**Application** p/n  
'08 M Series; '09-'11 CF 4639-997  
\*05-'07 M Series; '04 MC; '04-'06 KC  
\*Requires Spacer (p/n 1604-810)



**LONG TRACK KIT**

Requires Power Claw notched track (p/n 2602-367) sold separately.

**Application** p/n  
'10-'11 Z1 Turbo EXT; '11 F8 EXT 5639-360



**FLOAT CONVERSION**

**Application** p/n  
'05-'07 M Series; '09-'10 CF (STD) 4639-994

■NOTE: '11 Models require Float Shock (p/n 1704-813) only.



**TUNNEL FLARES**

**Application** p/n  
'09-'11 M Series, M8 HCR, CF, CFR   
Black 5639-107  
Green 5639-108  
Orange 5639-109



**38" A-ARM KIT**

Converts models with 40"-41" Ski Stance to 38"-39". Available with Black, Green, or White A-Arms. Includes Upper & Lower A-Arms, Tie-Rod Tubes and Shock Spacers (Requires rebuilding shocks to add a spacer to shorten travel).

**Application** p/n  
'12 M 800 (Std), M 800 SP, M 1100 (Std), M 1100 SP, M 1100 Turbo (Std),   
M 1100 Turbo SP, M 1100 Turbo HCR   
Black 5639-938  
Green 5639-939  
White 5639-940

## Utility



Page 118

### BEARCAT GEAR BAG

**Application**  
'09-'12 BC 570 XT, BC Z1 XT

**p/n**  
5639-049



Page 118

### TUNNEL PACK

**Application**  
'09-'12 BC 570 XT, BC Z1 XT

**p/n**  
6606-252



Page 118

### SNOW MESH

**Application**  
'09-'12 BC 570 XT, BC Z1 XT  
\*For other BC applications, see page 31.

**p/n**  
5639-522



Page 119

### THIRD SEAT

**Application**  
'09-'12 BC 570 XT, BC Z1 XT

**p/n**  
5639-063



Page 119

### CARGO RACK

**Application**  
'09-'12 BC 570 XT, BC Z1 XT

**p/n**  
5639-062

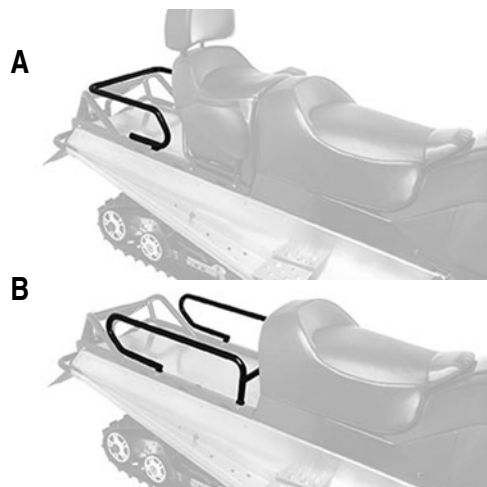

Page 119

### SIDE RAILS

**Application**  
'09-'12 BC 570 XT, BC Z1 XT  
(A) Short  
(B) Long

**p/n**  
5639-060  
5639-061

Replacement Strap for p/n 5639-060 (ea)

0641-993



**Page 119**  
**LIGHT BAR**

**Application** **p/n**  
'09-'12 BC 570 XT, BC Z1 XT 5639-803



**Page 119**  
**STROBE LIGHT**

**Application** **p/n**  
Fits Light Bar (5639-803) 5639-871

**GROOMER HARNESS KIT**

Includes dash-mounted control switches, wiring harness, and rear outlet.

**Application** **p/n**  
'09-'12 BC 570 XT, BC Z1 XT 5639-876

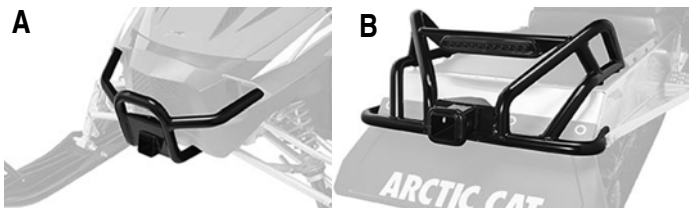

**Page 120**  
**RECEIVER BUMPER**

**Application** **p/n**  
'09-'12 BC 570 XT, BC Z1 XT  
(A) Front 5639-338  
(B) Rear 5639-339  
Replacement Hitch Cover 0641-248



**Page 120**  
**A. HITCH**  
Pintle hitch not included.

**Application** **p/n**  
'09-'12 BC XT - Receiver Bumper (p/n 5639-339) 5639-386

**B. PIVOT HITCH CONVERSION KIT**

**Application** **p/n**  
'09-'12 BC 570 XT, BC Z1 XT; '06-'07 BC WT; '07 BC 570 5639-387

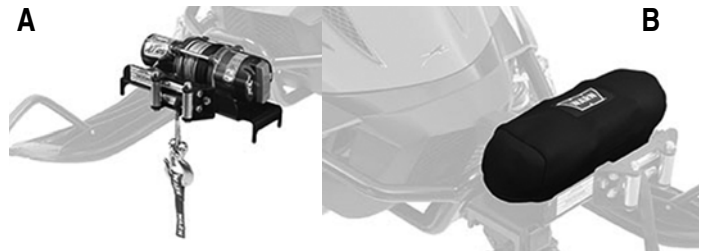

**Page 120**  
**RECEIVER WINCH**

**Application** **p/n**  
(A) '09-'12 BC 570 XT, BC Z1 XT 5639-340  
(B) Winch Cover 5639-459

**Replacement Components**

Fairlead, Roller	0441-403
Mounting Pin	1441-977
Mounting Pin Clip	1441-143
Mounting Plate 2" Receiver	0641-256
Solenoid	0409-080
Switch, Handlebar	0641-249



**Page 120**  
**TRANSPORT MOUNT**

**Application** **p/n**  
'09-'12 BC 570 XT, BC Z1 XT 5639-457



Page 120

**REAR HARNESS**

<b>Application</b>	<b>p/n</b>
'09-'12 BC 570 XT, BC Z1 XT	5639-456



Page 120

**WARN PORTABLE WINCH KIT**

<b>Description</b>	<b>p/n</b>
Winch Kit (Models with Standard Battery)	4639-138
<b>Replacement Components</b>	
Quick-Disconnect Plug	0641-940
Synthetic Rope	0641-941



Page 120

**SNOW PLOW PUSH FRAME**

Requires Front Receiver Bumper and Receiver Winch.

<b>Application</b>	<b>p/n</b>
'09-'12 BC 570 XT, BC Z1 XT	5639-341
<b>Replacement Components</b>	
Eyebolt	0441-332
Mounting Pin	1441-977
Mounting Pin Clip	1441-143
Spring - Kickover	0741-009

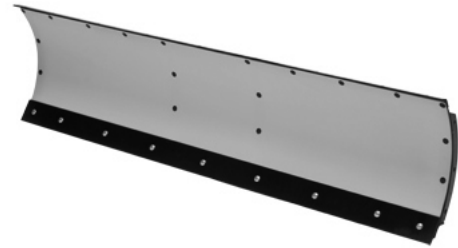

Page 120

**SNOW PLOW BLADE**

60" Blade.

<b>Application</b>	<b>p/n</b>
'09-'11 BC XT	0436-296
<b>Optional Accessories</b>	
Edge Marker Kit	0436-235
Side Plate Kit	0436-232
Snow Deflector	0436-299
<b>Replacement Components</b>	
Skid	0441-341
Wearbar	0441-447



Page 121

**CARGO SLEDS**

Additional shipping charges may apply. Order in multiples of 3.

<b>Description</b>	<b>p/n</b>
74" L X 38" W X 17" D, 48 lb, Capacity - 600 lb	4639-126



Page 121

**CARGO SLED RUNNER KIT**

<b>Application</b>	<b>p/n</b>
Cargo Sled (4639-126) 6 Wearstrips	4639-131



Page 121

### CARGO SLED COVER

Attaches with elastic cord.

**Application**  
Cargo Sled (4639-126)

**p/n**  
4639-129

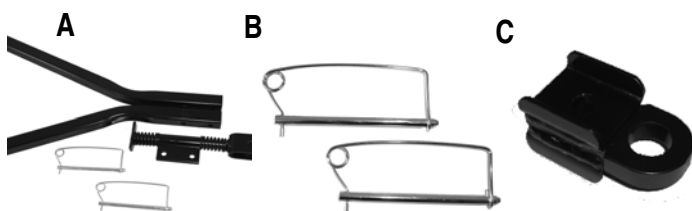

### REPLACEMENT HARDWARE

**Description**

- (A) Replacement Hitch
- (B) Replacement Pins (Pair)
- (C) Pintle Hitch Adapter

**p/n**  
4639-941  
5639-236  
5639-463



Page 121

### SKI SKINS

Fits 8" Saddleless Skis. 12" wide. Sold in pairs.

**Application**  
'09-'12 BC 570, BC 570 XT, BC Z1 XT

**p/n**  
5639-254



Page 121

### BACKUP LIGHT KIT

**Application**  
'09-'12 BC 570 XT, BC Z1 XT

**p/n**  
5639-389



Page 121

### PASSENGER HAND WARMERS

■NOTE: Not available for fan-cooled models - power output insufficient.

**Application**  
(A) '09-'12 BC Z1 XT; '11-'12 BC Z1 XT Ltd  
(B) '08-'09 T500

**p/n**  
4639-970  
4639-802

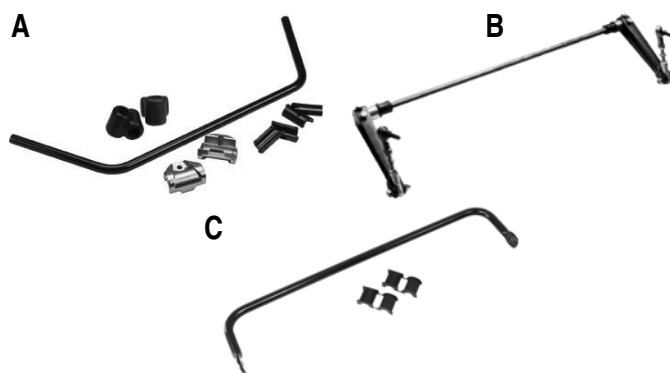

### SWAY BAR KITS

■NOTE: '11-'12 Sno Pro 500 requires Mounting Hardware Kit (p/n 5639-635).

**Application**  
(A) '09-'12 BC 570 XT; '10-'12 BC Z1 XT  
(A) '09-'12 BC 570  
(B) '99-'07 PA, Z; '06-'08 BC (7/16-in. Dia)  
(C) '10-'12 Sno Pro 500 - 11.7 mm  
(C) '10-'12 Sno Pro 500 - 12.7 mm  
(C) '10-'12 Sno Pro 500 - 14.3 mm

**p/n**  
5639-441  
5639-200  
4639-322  
4639-961  
4639-962  
4639-963

**Heavy-Duty Sway Bar (1/2" Dia bar)**  
'99-'07 Models with Standard 7/16" Sway Bar

0703-193



### RACK MAT

**Application**  
'09-'12 BC 570 XT, BC Z1 XT

**p/n**  
5606-368



### RADIATOR KIT

Includes radiator with electric cooling fan, hoses, and wiring.

<b>Application</b>	<b>p/n</b>
'09-'12 BC Z1 XT	4639-967



### OVERLOAD SPRING KIT

<b>Application</b>	<b>p/n</b>
'09-'10 BC 570	5639-106



### PASSENGER SEAT KIT

Includes seat assembly with backrest.

<b>Application</b>	<b>p/n</b>
'09-'10 BC 570	5639-201

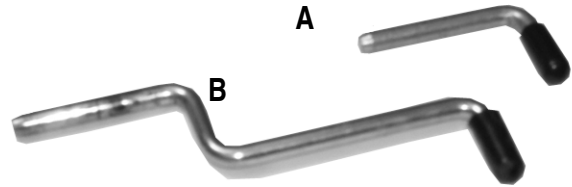

### REPLACEMENT PINS

<b>Description</b>	<b>p/n</b>
(A) Replacement Pins (Pkg 5)	0436-759
(B) Pin '06-'08 BC WT (Each)	1623-422

## Bearcat Trail Groomer

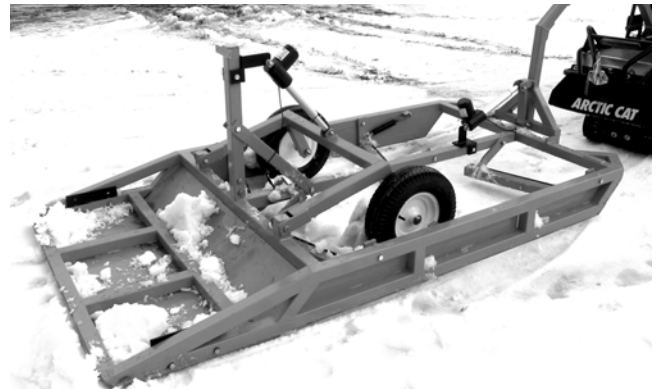

*The Bearcat Trail Groomer is designed to maintain a 4-ft wide trail*

- Two electric actuators that control cutting depth and wheel lift are pre-wired for the Bearcat Z1 XT GS rear outlet
- Four spring-loaded, pivoting cutting edges (front two are serrated) ('12 Bearcat Z1 XT models have pre-drilled mounting holes, '09-'11 models require drilling)
- Goose-neck hitch features an anti-scalping design
- Includes a snowmobile hitch plate with 1-7/8-in. ball that bolts directly to pre-drilled tunnel rails
- 52-in. x 96-in., 350 lb

■NOTE: The '12 Bearcat Z1 XT GS has an under-seat radiator and Groomer switches and outlet factory-installed. All other '09-'12 Bearcat Z1 XT models require a Radiator Kit (page 45) and Groomer Harness Kit when pulling a Trail Groomer.

Description	Application	p/n
Trail Groomer w/Mounting Plate & Ball	'12 BC Z1 XT GS	5639-891
Groomer Harness Kit	'09-'12 BC Z1 XT	5639-876
Includes dash-mounted control switches, wiring harness, and rear outlet		

**120**



**HAND WARMER KIT**

Includes external hand warmer elements, wiring, and switch.

**Application**  
'01-'12 120 Models

**p/n**  
2639-019

**A**



**B**

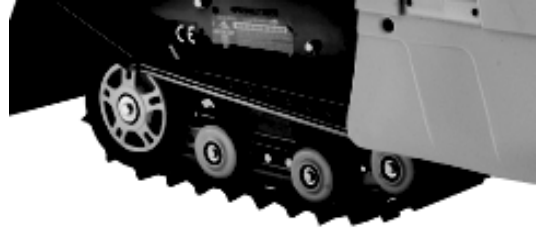

**WHEEL KITS**

**Description**

- (A) Ski Wheel Kit  
(includes two 8-in. wheels and mounting hardware)
- (B) Rear Suspension Wheel Kit (Black)  
(includes six idler wheels and mounting hardware)

<b>Year</b>	<b>p/n</b>
'01-'12	1639-795
'01-'12	5639-346



**HEAVY DUTY SHOCK KIT**

Includes two shock assemblies with springs.

**Application**  
'01-'05 120 Models

**p/n**  
4639-137

## Tracks

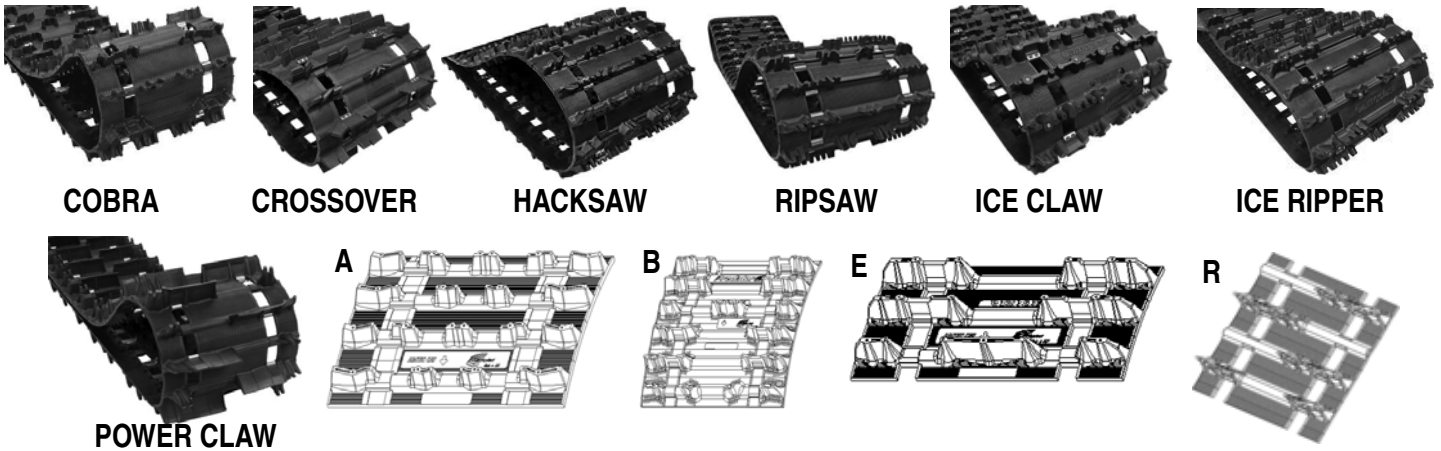

Page 123

### TRACKS - 2007-CURRENT APPLICATIONS

Tracks listed are required for use on 2007 and newer models with ACT drive and reverse but will also fit older models. All tracks listed feature an "All Open" window configuration with 2-ply construction unless noted. Pitch is measured at center of rods.

#### PERFORMANCE (2.52 P)

p/n	Dimensions (Studs)	Style	Duro	Weight	Clips
*1602-976	15" x 121" x 1.00"	Hacksaw	80/70	33	Every 3rd
*2602-268	15" x 121" x 1.352"	Cobra (Single-Ply)	80	32	Every Other
*2602-002	15" x 121" x 1.25"	Ripsaw	80/70	36	Every 3rd
*2602-047	14" x 128" x 1.00"	Hacksaw	80/70	34	Every 3rd
*2602-019	15" x 128" x 1.00"	Hacksaw	80/70	36	Every 3rd
*2602-162	15" x 128" x 1.352"	Cobra	80	37	Every Other
*2602-255	15" x 128" x 1.352"	Cobra (Single-Ply)	80	34	Every 3rd
*2602-046	15" x 128" x 1.25"	Ripsaw	80/70	41	Every 3rd
*2602-835	15" x 128" x 1.50"	Ripsaw	80/70	42	Every 3rd
*1602-997	15" x 136" x 1.25"	Ripsaw	80/70	42	Every 3rd
*2602-005	15" x 136" x 1.50"	Ripsaw	80/70	42	Every 3rd

#### PERFORMANCE (2.86 P)

2602-474	15" x 128" x 1.25" (Sno Pro XC)	Ripsaw	80	39	Every Other
2602-490	15" x 128" x 1.25"	Ripsaw II	80	39	Every Other
2602-491	15" x 128" x 1.352"	Cobra	80	36	Every Other
2602-485	15" x 128" x 1.70" (Sno Pro SX)	Sno Pro	80	42	Every Other

#### TOURING (2.52 P)

*2602-003	15" x 136" x 1.00"	Hacksaw	80/70	37	Every 3rd
*2602-101	15" x 144" x 1.00"	Hacksaw	80/70	40	Every 3rd
*2602-163	15" x 144" x 1.352"	Cobra	80	41	Every Other
*2602-350	15" x 144" x 1.50"	Crossover (Single-Ply)	80	47	Every 3rd

#### MOUNTAIN TRACKS (3.0 P)

2602-169	15" x 141" x 1.352"	Cobra (Single-Ply)	80	38	Every Other
2602-170	15" x 141" x 1.60"	Cobra (Single-Ply)	80	40	Every Other
2602-166	15" x 141" x 2.25"	Power Claw (Single-Ply)	80	44	Every Other
2602-167	15" x 153" x 2.25"	Power Claw (Single-Ply)	80	48	Every Other
2602-399	15" x 153" x 2.25"	Power Claw (Single-Ply)	85	48	Every Other
2602-168	15" x 162" x 2.25"	Power Claw (Single-Ply)	80	50	Every Other
2602-367	15" x 162" x 2.25"	Power Claw (Single-Ply) (Notched)	80	48	Every Other
2602-438	15" x 162" x 2.25"	Power Claw (Single-Ply)	85	50	Every Other

#### UTILITY (2.52 P)

2602-314	15" x 151" x 1.25"	Ripsaw (Single-Ply)	80	45	Every 3rd
0602-962	20" x 156" x 1.00"		60	63	Fully Clipped
1602-869	20" x 156" x 1.25"		80	67	Fully Clipped

#### UTILITY (2.86 P)

2602-358	20" x 154" x 1.375"	(Single-Ply)	80/70	58	Every 3rd
----------	---------------------	--------------	-------	----	-----------

#### ICE TECH SERIES (2.52 P)\*\*

*2602-030	15" x 121" x 1.00" (240) ICE Claw	70	36	Every 3rd
*2602-032	15" x 121" x 1.25" (258) ICE Ripper	70	37	Every 3rd
2602-376	15" x 128" x 1.25" (272) ICE Ripper	70	39	Every 3rd

\* ACT Quiet Tracks are for use on '03 and newer models only.

\*\*To protect the tunnel from possible stud damage, a Tunnel Protector Kit (page 55) should be installed on models not equipped.

### 2009-2012 TRACK APPLICATION

Model	Year	Single-Ply	2-Ply
Bearcat 570	'10-'12	2602-314	
	'09		2602-163
Bearcat 570 XT, Z1 XT	'11-'12	2602-358	
	'09-'11		1602-869
	'12		1602-869
Bearcat Z1 XT GS			
Crossfire	'09-'11	2602-169	
Crossfire Sno Pro	'09-'11	2602-170	
CFR	'09-'11		2602-047
F 800, 1100 LXR	'12		2602-019
F 800, 1100 Sno Pro (Inc. Turbo)	'12		2602-046
F 1100 Turbo LXR	'12		2602-046
F Series (Std), LXR	'09-'12		2602-019
F Series Sno Pro	'10-'11		2602-046
	'09	2602-255	
Sno Pro 500	'11-'12		2602-019
	'10	2602-255	
Z1 (Std), LXR	'09-'11		2602-019
Z1 Turbo (Std)	'09-'10		2602-019
Z1 Turbo LXR	'10-'11		2602-046
	'09	2602-255	
Z1 Turbo Sno Pro	'10-'11		2602-046
	'09	2602-255	
F8 EXT, Z1 Turbo EXT	'10-'11		2602-163
T570, TZ1 Touring	'09-'12		2602-101
TZ1 Turbo Touring	'09-'12		2602-163
XF 800, 1100 LXR (Inc Turbo)	'12	2602-169	
XF 800, 1100 Sno Pro (Inc Turbo)	'12	2602-170	

#### Z1 Turbo EXT, F8 EXT Optional Tracks

Standard Length Option	1602-137	144" x 2.00"
Long Track Kit Option	2602-367	162" x 2.25"

NOTE: For more information on the Arctic Cat Track Exchange Program, see page 1.



## TRACKS - 2006-PRIOR APPLICATIONS

Tracks listed below will not fit 2007 and newer models with ACT drive and reverse.

### 15" TRACKS (2.52 P)

p/n	Dimensions	Style	Duro	Weight	Clips	Windows
*1602-756	121" x .850"	A	60	34	Every 3rd	Every 3rd Closed
2602-398	121" x 1.00"	Hacksaw NQ	80/70	33	Every 3rd	All Open
*1602-504	121" x 1.00"	B	80/60	34	Every 3rd	Every 3rd Closed
2602-396	121" x 1.25"	Ripsaw NQ	80/70	36	Every 3rd	All Open
2602-397	121" x 1.352"	Cobra NQ (Single-Ply)	80	32	Every Other	All Open
*1602-506	121" x 1.375"	E	80/60	40	Fully Clipped	All Open
2602-004	121" x 1.50"	Ripsaw	80/70	38	Every 3rd	All Open
*1602-537	136" x 1.25"	B	80/60	44	Every 3rd	Every 3rd Closed
1602-326	136" x 2.00" w/o Notch	Challenger	80	50	Fully Clipped	All Open

### 15" TRACKS (3.0 P)

1602-607	141" x 1.60"	R	80	40	Every Other	All Open
----------	--------------	---	----	----	-------------	----------

### 13.5" TRACKS (2.52 P)

*1602-502	128" x 1.00"	E	80/60	33	Every 3rd	Every 3rd Closed
*1602-886	128" x 1.00"	Hacksaw	80/60	34	Every 3rd	Every 3rd Closed
*1602-503	128" x 1.375"	E	80/60	39	Fully Clipped	All Open
1602-750	144" x 1.25"	A	80/60	34	Every 3rd	All Open

### MISC. TRACKS

0602-927	Kitty Cat
1602-015	120 (10" x .688")

- 60 Durometer is a softer compound and is preferred by deep powder riders.
- 80 and 90 Durometer is a harder compound to give greater penetration and are preferred hill climb tracks.
- 80/60, 80/70 Durometer are dual compound tracks with the lug tip 60 or 70 durometer and the remainder 80 durometer.
- Tracks w/o Notch fit '03-'04 MC models.
- 2.25" tracks fit '99-'04 MC models.
- NonQuiet (NQ) Tracks can be used on competitive brands.

### MAXIMUM LUG HEIGHT

Model	Year	Height
CF	'09-'11	2.25"
	'06-'08	2.00"
F Series	'07-'11	1.50"
FC (ACT)	'05-'06	1.70"
JR	'07-'08	1.50"
T570, TZ1	'08-'11	1.25"
Z1	'09-'11	1.50"
136" Straight Tunnel Models		1.60"

## Wearbars

Page 126

<b>Ski Applications</b>					
	<b>A</b>	<b>B</b>	<b>C</b>	<b>D</b>	<b>E</b>
<b>Standard Wearbars</b>	<b>'05-'12 Saddleless '03-'06 FC, SC '02-'06 ZR</b>	<b>ZR-Style, Parabolic, Deep Snow, Universal Plastic Ski</b>	<b>Blow-Molded Plastic Ski</b>	<b>SLP Powder Pro</b>	<b>C&amp;A Pro ADX</b>
<b>7/16" Diameter Round Host Bar (Pair)</b>	<b>p/n</b>	<b>p/n</b>	<b>p/n</b>	<b>p/n</b>	<b>p/n</b>
Hardweld Wearbar (No Carbide Inserts)	3639-309	0639-198	1639-744		
4" Carbide With Hardweld			1639-527		
6" Carbide With Hardweld			1639-528		
<b>1/2" Diameter Round Host Bar (Pair)</b>					
4" Carbide With Hardweld	3639-310	3639-978		3639-420	
6" Carbide With Hardweld	3639-311	1639-521		3639-421	5639-604
8" Carbide With Hardweld	3639-312	0639-378			5639-605
10" Carbide With Hardweld	3639-313				
<b>5/8" Diameter Round Host Bar (Pair)</b>					
8" Carbide With Hardweld	3639-314				
10" Carbide Without Hardweld					5639-606
<b>Shaper Wearbars</b>					
4.5" Carbide (Pair)	4639-949			5639-195	
6" Carbide (Pair)	4639-950			5639-196	
7.5" Carbide (Pair)					4639-952
9" Carbide (Pair)	4639-951			5639-197	4639-953

■NOTE: The accessory Saddleless Ski wearbars listed use a 4-bolt stud pattern. When using accessory wearbars on Saddleless Skis with a 3-bolt stud pattern, it will be necessary to drill another mounting hole in the ski.

<b>Dual Wearbars</b>	<b>'05-'12 Saddleless '03-'06 FC, SC '02-'06 ZR</b>	<b>ZR-Style, Para- bolic, Deep Snow, Universal</b>
<b>Dooly™ Twin Carbide Wearbars (Each)</b>		
Hardweld Wearbar	5639-879	
4" Carbide With Hardweld	3639-343	3639-346
6" Carbide With Hardweld	3639-344	3639-347
8" Carbide With Hardweld	3639-345	3639-348
<b>Deuce™ Twin Carbide Wearbars (Each)</b>		
4.5" Carbide	5639-251	
6" Carbide	5639-252	
9" Carbide	5639-253	
<b>Staggered Wearbars (Each)</b>		
4" Carbide (RH) 3-Bolt	2603-988	
4" Carbide (LH) 3-Bolt	2603-989	
<b>Steel Ski Wearbars</b>	<b>AFS (4-Bolt)</b>	<b>AWS (3-Bolt)</b>
<b>7/16-in. Diameter Round Host Bar (Pair)</b>		
Hardweld Wearbar		1639-784
4-in. Carbide With Hardweld	0638-399	4639-013
6-in. Carbide With Hardweld	0638-520	

### Bulk Pack Wearbars

Our most popular 4", 6", and 8" accessory carbide wearbars are available in bulk packaging, 10 pairs with nuts to a box. These are the same wearbars that we offer in Arctic Cat packaging. Bulk packaging allows Arctic Cat to offer you ultra-competitive pricing on these high volume wearbars.

<b>Description</b>	<b>p/n</b>
<b>Wearbars For Arctic Cat '05-'12 Saddleless Skis; '03-'06 FC, SC; '02-'06 ZR</b>	
10 Pairs 3639-310 - 4" Carbide With Hardweld	2639-184
10 Pairs 3639-311 - 6" Carbide With Hardweld	2639-185
10 Pairs 3639-312 - 8" Carbide With Hardweld	2639-186
<b>Wearbars for ZR Style Parabolic, and Deep Snow Plastic Skis</b>	
10 Pairs 3639-978 - 4" Carbide With Hardweld	3639-979
10 Pairs 1639-521 - 6" Carbide With Hardweld	2639-189

### Stud Quantity/Inches of Turning Carbide

<b>Sled</b>	<b>Trail</b>	<b>Performance</b>
50-75 HP	48/4 in.	48/6 in.
75-125 HP	102/6 in.	153/8 in.
125-150 HP	153/8 in.	153/10 in.
150-170 HP	153/8 in.	153/10 in.



## STEEL SKI WEARBAR APPLICATIONS

### HARDWELD WEARBARS

Application	Year	p/n
4-Stroke Trail	'02	1639-744
4-Stroke Touring	'02	1639-744
BC 340	'97-'01	0639-198
	'00	1639-744
	'95-'99	1639-784
BC 440	'99-'00	0639-198
	'97-'98	1639-784
	'98-'02	0639-198
BC 550	'92-'93	1639-784
Cheetah Touring	'94	1639-784
Cheetah 340, 440, 550	'92-'98	1639-784
Cougar, Cougar 2-Up	'98	0639-198
Cougar Dix	'91-'98	1639-784
EXT	'98	0639-198
EXT Dix	'91	1639-784
EXT Special	'97-'98	1639-784
EXT 600	'98	0639-198
EXT 600 Touring	'03	3639-309
FC	'92-'99	1639-784
Jag	'92-'93	1639-784
Jag AFS L/T	'96	1639-784
Jag Liquid	'91	1639-784
Jag Special	'92-'93	1639-784
Lynx	'01-'04	0639-198
MC	'02-'03	1639-744
PTA 550	'02-'03	0639-198
PTA 660	'02	0639-198
PTA 800	'91-'01	0639-198
PTA	'91-'96	1639-784
PA	'00-'05	1639-744
	'92-'99	1639-784
PE	'97-'98	0639-198
PS	'96-'00	0639-198
Prowler	'91-'95	1639-784
	'90	1639-784
Prowler Special	'91	1639-784
Puma	'94-'97	1639-784
TC	'97-'02	0639-198
	'93-'95	1639-784
WC	'95-'96	1639-784
	'91	1639-784
WC EFI (AFS)	'91-'92	1639-784
Z 370	'99-'05	1639-744
Z 440	'00-'02	1639-744
	'97-'99	0639-198
Z 570	'02-'05	1639-744
ZL	'97-'03	0639-198
ZR	'97-'01	0639-198
ZR 440	'96-'99	0639-198
ZRT	'96-'02	0639-198

Application	Year	4" Carbide With Hardweld p/n	6" Carbide With Hardweld p/n
AFS	'91 & older	0638-399	0638-520
BC 340	'95-'99	0638-399	0638-520
BC 440	'95-'98	0638-399	0638-520
BC 550	'95-'97	0638-399	0638-520
Cheetah Touring	'86-'91	0638-399	0638-520
	'92-'93	4639-013	
Cheetah	'94	4639-013	
Cougar	'86-'91	0638-399	0638-520
Cougar, Cougar MC	'92-'97	4639-013	
El Tigre	'86-'89	0638-399	0638-520
EXT, EXT MC	'89-'91	0638-399	0638-520
	'92-'97	4639-013	
EXT Special	'91	4639-013	
	'92	0638-399	0638-520
EXT MC	'94-'96	0638-399	0638-520
EXT 580 Z	'93	0638-399	0638-520
EXT 600	'97-'98	4639-013	
Jag, Jag Deluxe	'92-'97	4639-013	
Jag AFS	'89-'91	0638-399	0638-520
Jag AFS LT	'90-'91	0638-399	0638-520
Jag Special	'91	4639-013	
	'92	0638-399	0638-520
Jag Z	'93-'94	0638-399	0638-520
Lynx	'91	0638-399	0638-520
	'92-'93	4639-013	
PTA	'86-'90	0638-399	0638-520
	'91-'96	4639-013	
PA	'90-'91	0638-399	0638-520
	'92-'99	4639-013	
Prowler, Prowler MC	'90	0638-399	0638-520
	'91-'95	4639-013	
Prowler Special	'91	4639-013	
	'92	0638-399	0638-520
Puma, Deluxe, 2-Up	'94-'97	4639-013	
TC	'93-'96	4639-013	
TC MC	'94-'95	4639-013	
WC, WC MC	(AFS) '91-'92	4639-013	
	(AWS) '92-'94	0638-399	0638-520
	'95-'96	4639-013	
Z 440	'95-'96	0638-399	0638-520
ZR 440	'93-'94	0638-399	0638-520
ZR 580, 700 (Steel Ski)	'93-'96	0638-399	0638-520

4 Bolt Wearbar; 0638-399, 0638-520  
3 Bolt Wearbar; 4639-013

## Traction & Control

### 2012 TRACK LUG HEIGHTS AND RECOMMENDED STUD LENGTH

Model	Track Length/ Lugs	Woody's Stud Length	Stud Boy Stud Length	Model	Track Length/ Lugs	Woody's Stud Length	Stud Boy Stud Length
<b>Single-Ply Tracks</b>				<b>2-Ply Tracks</b>			
Bearcat 570	151" x 1.250"	1.325	1.375	F 800, 1100 LXR	128" x 1.000"	1.075	1.080
Bearcat 570 XT, Z1 XT	154" x 1.375"	1.450	1.500	F 1100 Turbo LXR	128" x 1.250"	1.325	1.375
XF 800, 1100 LXR (Inc Turbo)	141" x 1.352"	1.325	1.375	F 800, 1100 SP (Inc Turbo)	128" x 1.250"	1.325	1.375
XF 800, 1100 SP (Inc Turbo)	141" x 1.600"	N/A	N/A	Sno Pro 500	128" x 1.000"	1.075	1.080
				T570, TZ1, TZ1 LXR	144" x 1.000"	1.075	1.080
				TZ1 Turbo LXR	144" x 1.352"	1.325	1.375

### CAUTION

- To protect the tunnel from possible damage from the studs, install a Tunnel Protector Kit (see page 55) on models not so equipped. Do not use longer than recommended studs. Use only Arctic Cat approved Stud Templates shown on page 55.
- For Stud Length 1.325" and longer, we recommend the use of a Big Nut or Power Tower Support Nut.
- A short snowflap is required when installing studs on '07-'09 F Series, JR, Z1, and '09 CF (see page 55).
- Do not stud the original 1.250" track on the '06-'08 BC WT Turbo. Damage to the heat exchangers may occur. If you wish to install studs on '06-'08 BC WT Turbo track, the original 1.250" track must be replaced with a 1.00" track.

### Single-Ply Track Application

■NOTE: '09-'12 Track applications shown on page 47.

### ⚠ WARNING

When installing studs on a single ply track, it is important to use Arctic Cat-approved studs (proper head diameter). If approved studs (proper head diameter) are not used, studs could tear free of the track causing possible injury or even death.

### WOODY'S

A. Page 127

#### GRAND MASTER™ TRACTION KITS

60° Carbide Tip, 5/16" Thread, 1.20" Head.

Application	Qty	p/n
<b>'09 F Series Sno Pro, Z1 Turbo LXR, Z1 Turbo Sno Pro; '10 Sno Pro 500 128" x 1.25"</b>		
Grand Master Stud Kit (1.325" Studs)	102/pk	5639-230
Grand Master Stud Kit (1.325" Studs)	153/pk	5639-231
<b>'12 XF 800 LXR, XF 1100 LXR (Inc. Turbo); '09-'11 CF 141" x 1.352"</b>		
Grand Master Stud Kit (1.325" Studs)	94/pk	5639-144
<b>'11-'12 BC XT 154" x 1.375"</b>		
Grand Master (1.450" Studs)	108/pk	5639-626

#### GRAND MASTER™ STUDS

60° Carbide Tip, 5/16" Thread, 1.20" Head.

Description	Qty	p/n
1.325" With Big Nut	500/pk	5639-426

#### GRAND MASTER™ SUPPORT PLATES

Description	Qty	p/n
Single, Square 1.50" - 5/16"	500/pk	5639-427
Double - 5/16"	51/pk	5639-486

### STUD BOY

Page 128

#### POWER POINT PLUS STUDS

60° Carbide Tip, 5/16" Thread, 1.16" Head. Support Plates sold separately.

Description	Qty	p/n
1.080 With Nyloc Nut	102/pk	5639-183
	153/pk	5639-184
	1000/pk	5639-185
1.187 With Nyloc Nut	102/pk	5639-186
	153/pk	5639-187
	1000/pk	5639-188
1.375 With Nyloc Nut	102/pk	5639-189
	153/pk	5639-190
	1000/pk	5639-191

#### POWER PLATE PLUS BACKERS

Description	Qty	p/n
Square 1.375" - 5/16"	102/pk	5639-192
	153/pk	5639-193
	1000/pk	5639-194

## 2-Ply Track Application

### ARCTIC CAT TRACTION BY



**B. Page 127**

#### SIGNATURE SERIES STAINLESS STEEL

60° Carbide Tip, 5/16" Threads, 15/16" Head. Support Plates sold separately.

Description	Qty	p/n
1.075 With Nyloc Nut	102/pk	3639-915
	153/pk	4639-739
	1000/pk	3639-917
1.175 With Nyloc Nut	102/pk	3639-919
	153/pk	4639-740
	1000/pk	3639-921
1.325 With Big Nut	102/pk	3639-923
	153/pk	4639-741
	1000/pk	3639-925
1.450 With Big Nut	102/pk	3639-927
	153/pk	4639-742
	1000/pk	3639-929

**C. Page 127**

#### GOLD DIGGER® TRACTION MASTER®

60° Carbide Tip, 5/16" Threads, 1" Head. Support Plates sold separately.

Description	Qty	p/n
1.075 With Nyloc Nut	102/pk	3639-067
	153/pk	4639-748
	1000/pk	1639-118
1.175 With Nyloc Nut	102/pk	3639-069
	153/pk	4639-749
	1000/pk	1639-958
1.325 With Big Nut	102/pk	3639-362
	153/pk	4639-750
	1000/pk	1639-519
1.450 With Big Nut	102/pk	5639-913
	153/pk	5639-914
	1000/pk	5639-915



**D. Page 127**

#### BIG NUT

These aluminum nuts provide extra strength and are recommended when using studs 1.325" and longer.

Description	Qty	p/n
Short - 1.325" Studs	102/pk	4639-736
	153/pk	4639-737
	1000/pk	4639-738
Tall - 1.450" Studs	102/pk	4639-794
	153/pk	4639-795
	1000/pk	4639-796



**Page 127**

#### TRACTION KITS

Includes Studs, Support Plates, Standard or Big Nuts, Template, Drill, and Track Marker.

**CAUTION**

CF, CFR require Tunnel Protector Kit (see page 55).

Application	Qty	p/n
<b>'12 F 800 Sno Pro, F 1100 Sno Pro, F 1100 Turbo LXR, Sno Pro; '10-'11 F Series Sno Pro, Z1 Turbo LXR, Sno Pro 128" x 1.25"</b>	102/pk	5639-781
	153/pk	5639-782
<b>'12 F 800 LXR, F1100 LXR; '07-'11 F Series; '09-'11 CFR, Z1, Z1 Turbo; '11-'12 Sno Pro 500 128" x 1.00"</b>	102/pk	4639-550
	153/pk	4639-551
<b>'06-'08 CF 136" x 1.25"</b>	108/pk	4639-340
	162/pk	4639-341
<b>'08-'10 Sno Pro 600</b>	94/pk	4639-948
	128/pk	5639-383
<b>'11 Sno Pro 600</b>	90/pk	5639-637



**Page 128**

#### A. DIGGER SUPPORT PLATES

Description	Qty	p/n
Square 1.250" - 5/16"	102/pk	3639-093
	153/pk	4639-752
	1000/pk	0639-907
Round 1.375" - 5/16"	102/pk	3639-091
	153/pk	4639-751
	1000/pk	3639-005

#### B. DIGGER COLORED SUPPORT PLATES

Description	Color	Qty	p/n
Square 1.250" - 5/16"	Black	102/pk	4639-257
		153/pk	4639-753
		1000/pk	4639-259
	Green	102/pk	3639-388
		153/pk	4639-754
		1000/pk	2639-857
	Orange	102/pk	3639-390
		153/pk	4639-755
		1000/pk	2639-861

## 2-Ply Track Application



Page 128

### DOUBLE DIGGER™ SUPPORT PLATES

**Description**  
5/16"

Qty	p/n
12/pk	2639-134
48/pk	2639-135

**Woody's Limited Warranty**

International Engineering & Manufacturing, Inc. warrants each product manufactured by it to be free from defects in material and workmanship under use for the purpose for which it is intended. The Company shall not be liable for damage or delays caused by defective materials or workmanship; is limited to the repair or replacement at its factory of defective article or part thereof, which may be returned to the factory, transportation charges, prepaid within one (1) year after delivery to the original purchaser. Proof of purchase is also required. The Company shall be the sole judge of the existence of any defect in the article so returned. No claims for charges incurred in the removal, disassembly or reinstallation of such article shall be allowed. Product manufactured for consumer use on snowmobiles is designed for snow or ice only, use on any other surface voids warranty.

This Warranty shall not cover any article which has been misused or neglected or damaged by accident or any article which has been altered outside the Company's factory. The Warranty for studs is void unless the studs are installed with Woody's installation tools, support plates and lock nuts; according to the recommendations set forth in Woody's Instructions and Template Patterns. This Warranty does not cover bending, chipping, flaking or carbide pin breakage or pin loss from stud wear, stud replacement labor or shipping.

The Company shall, in no event be liable for consequential damage or contingent liability arising out of any total or partial failure to function of any article manufactured by it or of any equipment on or in which it is used. Failure of a user to give notice to claim as to defect claimed under the provisions of the Warranty within one (1) year after delivery to original use, such claim shall constitute a waiver by consumer of all claims with respect to goods and equipment.

No express, implied, or statutory warranty other than that herein set forth is made or authorized to be made by the Company. All returned warranties will not be accepted without a return authorization number.

Woody's® Team Woody's®, Snowmobiler Logo, Traction Master, Flat-Top, Gold Digger, Mega-Bite, Excel, Chisel Tooth, Square Digger, Round Digger, Double Digger, Road Runner, Star Stud, Top-Stock, Extender Trail III, Trail Blazer IV, Executive, and Ultra Series are trademarks and/ or trade names of International Engineering and Manufacturing, Inc. Traction Master refers to a patented product of International Engineering & Manufacturing, Inc. and is covered by US Patent No. 5,23,266 and Canadian Patent No. 2,086,186. Woody's® Mega-Bite studs are covered by US Patent No. D415, 954 and Canadian Patent No. 88,613. Woody's® Universal Template is Patent Pending.

**Woody's® Manufacturer Warranty Returns**

Call our customer service department for a Return Authorization Number. This number must be visible on the outside of the box. The product must be inspected by a Woody's technician to determine if the product is defective due to material, quality or workmanship before a final warranty determination is made. Proof of purchase is required. All returns to the manufacturer are for exchange only.

## ARCTIC CAT TRACTION BY

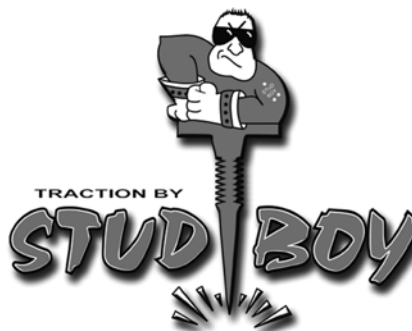

Page 128

### POWER POINT™

60° Carbide Tip, 5/16" Thread, 1" Head. Support Plates sold separately.

Description	Qty	p/n
1.080 With Nyloc Nut	102/pk	5639-072
	153/pk	5639-073
	1000/pk	5639-074
1.187 With Nyloc Nut	102/pk	5639-075
	153/pk	5639-076
	1000/pk	5639-077
1.375 With Nyloc Nut	102/pk	5639-078
	153/pk	5639-079
	1000/pk	5639-080
1.500 With Nyloc Nut	102/pk	5639-081
	153/pk	5639-082
	1000/pk	5639-083



Page 128

### POWER PLATE™ BACKERS

Description	Qty	p/n
Square 1.270" - 5/16"	102/pk	5639-093
	153/pk	5639-094
	1000/pk	5639-095

## 2-Ply Track Application

Page 128

### POWER POINT™ TRACTION KITS

Application	Qty	p/n
'12 F 800 Sno Pro, F 1100 Sno Pro, F 1100 Turbo LXR, Sno Pro; 10-'11 F Series Sno Pro, Z1 Turbo LXR, Sno Pro 128" x 1.25"	102/pk	5639-783
Power Point (1.375" Studs)	153/pk	5639-784
'12 F 800 LXR, F 1100 LXR; '07-'11 F Series; '09-'11 CFR, Z1, Z1 Turbo; '11-'12 Sno Pro 500 128" x 1.00" Track	102/pk	5639-099
Power Point (1.080" Studs)	153/pk	5639-100
'08-'12 T570, TZ1 144" x 1.00" Track	114/pk	5639-146
Power Point (1.080" Studs)		
'08-'10 Sno Pro 600		
Sno Cross (1.875" Studs)	68/pk	4639-965
Sno Cross (1.875" Studs)	96/pk	4639-947
Cross Country (1.375" Studs)	153/pk	5639-325
'11 Sno Pro 600		
Sno Cross (1.875" Studs)	90/pk	5639-636



Page 129

### SUPER-LITE PLUS BACKERS

Single-Ply and 2-Ply application

Description	Color	Qty	p/n	
1.450" x 5/16"	Black	102/pk	5639-362	
		153/pk	5639-363	
		1000/pk	5639-364	
	Green	102/pk	5639-366	
		153/pk	5639-367	
		1000/pk	5639-368	
	Orange	102/pk	5639-370	
		153/pk	5639-371	
	White	1000/pk	5639-372	
		102/pk	5639-443	
			153/pk	5639-444



Page 129

### SUPER-LITE PLUS DOUBLE BACKERS

Single-Ply application

Description	Color	Qty	p/n
5/16"	Black	51/pk	5639-429
	Green	51/pk	5639-430
	Orange	51/pk	5639-431
	White	51/pk	5639-447

#### Stud Boy Limited Warranty

Liberty Products, Inc. warrants each product manufactured by it to be free of defects in workmanship and material while used for the purpose for which it is designed. Liberty Products, Inc. shall not be liable for damages or delays as a result of defects caused by defective workmanship or materials. Warranty is limited to the repair or replacement at Liberty Products of any defective part or product, within one (1) year of the delivery to the original purchaser, proof of purchase must accompany the product returned (freight prepaid). Liberty Products, Inc. shall be the sole judge of any defect, which might be claimed on the returned product. No other charges may be claimed in conjunction with the removal, reinstallation of such product. These products are designed and manufactured for use on snowmobiles on snow and ice only, use on other surfaces voids warranty. Warranty will be void if product has been mis-used, neglected, damaged or modified outside of Liberty Products, Inc. Does not cover bending, chipping, flaking or carbide breakage or loss from wear. Liberty Products, Inc. will not be liable for consequential damage or contingent liability arising from any total or partial failure to function of any product manufactured by it or any equipment on or in which it is used. No further warranty of any type is intended or implied or will be authorized to be made by Liberty Products, Inc.



Page 129

### POWER TOWER SUPPORT NUTS

Recommended when using studs 1.375" and longer.

Description	Qty	p/n
.750"	102/pk	5639-096
	153/pk	5639-097
	1000/pk	5639-098



Page 129

### STUD DRILL

Description	p/n
5/16"	1639-629



Page 129

### TRACK MARKER

Description	p/n
Track Marker	1639-520

Page 129

## STUD TEMPLATES

Application	p/n
'12 F5, F570, F 800, F 1100, F 1100 Turbo; '11-'12 Sno Pro 500;	4639-443
'07-'11 F Series; '09-'11 CFR, Z1 128-in. (2-Ply)	
'12 XF 800 LXR, XF 1100 LXR (Inc Turbo); '09-'11 CF 141-in. (Single-Ply)	4639-991
'08-'12 T570, TZ1, TZ1 LXR; '10-'11 Z1 Turbo EXT; '11 F8 EXT 144-in. (2-Ply)	5639-160
'11-'12 BC XT 154-in. (Single-Ply)	5639-609
'09-'10 BC XT 156-in. (2-Ply); '10-'12 BC 570 151-in. (Single-Ply)	5639-461
'09 F Series Sno Pro, Z1 Turbo LXR, Sno Pro; '10 Sno Pro 500 128-in. (Single-Ply)	5639-428
'06-'08 CF 136-in. (2-Ply)	4639-344
All Purpose 15" x 121" Tracks (2-Ply)	4639-488
All Purpose 13.5" Tracks (2-Ply)	3639-589

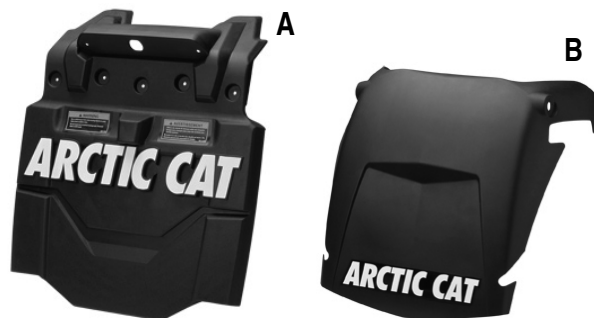

Page 129

## SHORT SNOWFLAP

Required when installing studs on the models listed below.

Application	Year	p/n
(A) CF, CFR	'09-'11	5639-232
(B) F Series	'07-'09	4706-462
(B) JR	'07-'08	4706-462
(B) Z1, Z1 Turbo	'09	4706-462



Page 129

## TUNNEL PROTECTOR KIT

Required when installing studs on the models listed below. On liquid-cooled models not listed, the heat exchanger acts as a tunnel protector. Be sure not to install studs in line with the heat exchanger.

Application	Year	p/n
F 800, F 1100, F 1100 Turbo	'12	5639-668
XF 800, XF 1100, XF 1100 Turbo	'12	5639-752
CF, CFR	'09-'11	4639-968
BC 570	'09-'12	4639-771
BC Z1 XT	'09-'12	5639-143
CF	'06-'08	4639-338
F570, T570	'08-'12	4639-771
M Series, M8 HCR	'09-'11	5639-268



## Oil & Care

### 2012 MODEL YEAR SNOWMOBILE OIL APPLICATION CHART

Model	0W-40	APV	Formula SS	Formula 50	Capacity
120	X				20.3 U.S. oz
Sno Pro 500		X	X	X	2.75 U.S. Qt
Bearcat 570/ F570/T570				X	4.2 U.S. Qt
Bearcat 570 XT				X	4.8 U.S. Qt
F 800/M 800/XF 800 Models		X	X		3.9 U.S. Qt
F 1100/M 1100/ XF 1100 Models	X				3.28 U.S. Qt
Bearcat Z1/TZ1 Models	X				4.0 U.S. Qt

Visit [www.arcticcatlubricants.com](http://www.arcticcatlubricants.com) for more oil information.



Page 130

### APV SYNTHETIC OIL

Our APV Synthetic Oil stands alone as the best, most performance oriented lubrication that could possibly be put through your sled. The best oil for the dollar guarantees flawless engine operation.

Description	p/n
Quart	4639-349
Gallon	5639-469
2.5 Gallon	4639-347
16 Gallon Drum	2639-510
16 Gallon Drum (50th Anniversary)	5639-908
55 Gallon Drum	2639-509



Page 131

### FORMULA SS SEMI-SYNTHETIC OIL

Formula SS Semi-Synthetic 2-cycle oil offers the benefits of a semi-synthetic formulation at a phenomenal value. Use in ALL Arctic Cat 2-cycle engines, including Arctic Power Valve engines.

Description	p/n
Quart	5639-470
Gallon	5639-471
2.5 Gallon	5639-472
16 Gallon Drum	5639-473
16 Gallon Drum (50th Anniversary)	5639-909
55 Gallon Drum	5639-474



Page 131

### FORMULA 50 OIL

Mineral based 50:1 Injection Oil. High quality mineral base formulation, proven performance over time. Provides rust and corrosion protection. Mixes easily with fuel and all other Arctic Cat 2-cycle engine oils.

Description	p/n
Quart	5639-475
Gallon	5639-476
2.5 Gallon	5639-477
16 Gallon Drum	5639-478
16 Gallon Drum (50th Anniversary)	5639-910
55 Gallon Drum	5639-479



Page 131

### SYNTHETIC 0W-40 OIL

Unique synthetic formulation designed and tested for use in Arctic Cat 4-Cycle Snowmobiles. Premium additive system provides superior cleanliness, anti-wear protection, and minimizes deposit formations.

Description	p/n
Quart	5639-172
Gallon	5639-173
16 Gallon Drum	5639-912
16 Gallon Drum (50th Anniversary)	5639-911
55 Gallon Drum	5639-175



Page 131

### SYNTHETIC OIL CHANGE KIT

Application	p/n
'07-'11 1100 cc Models (Includes Turbo)	5639-174



**EMPTY DRUM**

**Application**  
16 Gallon (50th Anniversary)

**p/n**  
5639-907



Page 132

**CHAIN LUBE**

**Description**  
8 oz.

**p/n**  
4639-363



Page 132

**SYNTHETIC TRANSMISSION LUBE**

**Description**  
12 oz.

**p/n**  
5639-039



Page 132

**SYNTHETIC ACT GEARCASE FLUID**

**Description**  
3 oz. ACT Non-Reverse  
12 oz. ACT w/Reverse  
15 oz. ACER (Engine) Reverse  
Gallon

**p/n**  
4639-361  
4639-628  
5639-219  
5639-632

■NOTE: ACT Drive Gasket Sets (See pg. 68)



Page 132

**ARCTIC CAT TRANSMISSION LUBE**

**Description**  
12 oz.  
2.5 Gallon

**p/n**  
4639-364  
1639-247



Page 132

**ACT FLUSH FLUID**

**Description**  
6 oz.  
Gallon

**p/n**  
4639-333  
5639-847



Page 132

**SYNTHETIC CHAIN LUBE**

**Description**  
8 oz.

**p/n**  
5639-038



Page 132

**SYNTHETIC SHOCK OIL**

**Description**  
Lt Wt - Quart  
Med/Lt Wt - Quart  
Med Wt - Quart

**p/n**  
4639-367  
4639-369  
4639-368



Page 132

**SEMI-SYNTHETIC SHOCK OIL**

**Description**  
Quart

**p/n**  
5639-530



Page 133

**FUEL STABILIZER**

**Description**  
8 oz.

**p/n**  
0436-907



Page 132

**ARCTIC CAT SHOCK OIL**

**Description**  
Quart

**p/n**  
4639-366



Page 133

**DOT 4 BRAKE FLUID**

**Description**  
12 oz.

**p/n**  
5639-848



Page 133

**ARCTIC CAT ANTIFREEZE**

**Description**  
Gallon

**p/n**  
0436-909



Page 133

**FUEL INJECTOR & CARBURETOR CLEANER**

**Description**  
12 oz.

**p/n**  
0436-904



Page 133

**FUEL DE-ICER**

**Description**  
12 oz.

**p/n**  
0436-906



Page 133

**ENGINE PRESERVER**

**Description**  
12 oz.

**p/n**  
0436-888



**FOX FLOAT FLUID**

Specially made for use in the air chamber of FOX FLOAT Air Shox.

**Description** **p/n**  
8 oz. 4639-012



**HOOD & WINDSHIELD CLEANER/POLISH**

**Description** **p/n**  
8 oz. 4639-559



Page 133

**ARCTIC CAT ALL-TEMP GREASE**

**Description** **p/n**  
14 oz. 4639-365

**MISCELLANEOUS GREASE**

**Description** **p/n**  
Throttle Cable Lube .5 oz. 1056-053  
Electric Start 2 cc 1056-272  
High Temperature .5 oz. 1056-077  
Dielectric 2.7 oz. 1056-287



**CHAIN LUBRICANT**

**Description** **p/n**  
12 oz. 0436-903



**HIGH OCTANE RACE FUEL**

**Description** **p/n**  
**110 Octane Race Fuel**  
16 Gallon Drum 2639-098  
55 Gallon Drum 2639-097

**116 Octane Race Fuel** **p/n**  
16 Gallon Drum 3639-620  
55 Gallon Drum 3639-621

**DRUM PUMP (NOT SHOWN)**

**Application** **p/n**  
16 to 55 Gallon Drums 1639-249



Page 133

**CAT CLEANER**

**Description** **p/n**  
22 oz. 4639-371



**VEHICLE WASH/CLEANER**

<b>Description</b>	<b>p/n</b>
Gallon	4639-631
5 Gallon	4639-630
30 Gallon	4639-629



**ALL PURPOSE CLEANER**

<b>Description</b>	<b>p/n</b>
Gallon	4639-634
5 Gallon	4639-633
30 Gallon	4639-632



**HEAVY DUTY CLEANER/DEGREASER**

<b>Description</b>	<b>p/n</b>
Gallon	4639-637
5 Gallon	4639-636
30 Gallon	4639-635

**CLEANING KIT**

Kit includes two gallons each of the following cleaners:  
Vehicle Wash/Cleaner, All Purpose Cleaner, Heavy Duty Cleaner/Degreaser.

<b>Description</b>	<b>p/n</b>
Cleaning Kit	4639-666



**LEATHER CLEANER/CONDITIONER**

<b>Description</b>	<b>p/n</b>
Leather Cleaner/Conditioner	4912-051



**LEATHER WATER REPELLENT**

<b>Description</b>	<b>p/n</b>
Leather Water Repellent	4912-052



**REVIVEX WATER & STAIN REPELLENT**

<b>Description</b>	<b>p/n</b>
Revivex Water & Stain Repellent	4201-280



**WATER/STAIN REPELLENT**

<b>Description</b>	<b>p/n</b>
Water/Stain Repellent	4912-152

## General Maintenance



Page 134

### SLED LIFT

Maximum lift capacity 625 lbs.

**Description**

- (A) Sled Lift (Ship wt. 65 lb)
- (B) Wheel Kit (Ship wt. 15 lb)

**p/n**

- 4639-992
- 4639-993

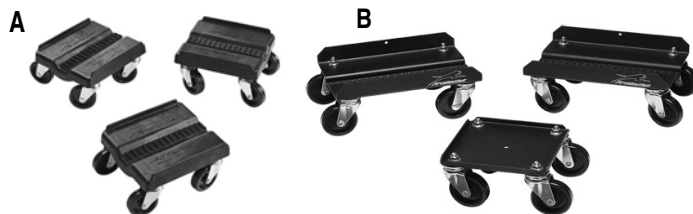

Page 134

### CAT CADDY

Set of 3.

**Description**

- (A) Plastic - Black
- (A) Plastic - Green
- Replacement Wheel - Push-in (Each)
- (B) Aluminum - Black
- Replacement Wheel - Threaded (Each)

**p/n**

- 5639-873
- 5639-874
- 0641-264
- 4639-766
- 0641-535



Page 134

### SLED SLIDES

Set of 3.

**Description**

- Steel - Green

**p/n**

- 5639-579



Page 134

### JACK STAND

**Description**

- 33" High

**p/n**

- 4639-768



Page 135

### FRONT END LIFT

**Description**

- Front End Lift

**p/n**

- 5639-151



Page 135

### HANDLEBAR STAND

**Description**

- (A) Handlebar Stand
- (B) Steering Post Stand

**p/n**

- 5639-152
- 5639-946



Page 135

**SHOP DOLLY**

Added freight charges may apply.

Description	p/n
Shop Dolly (Shipping: 46L x 25W x 11H, 70 lb)	5639-373
Replacement Strap	5639-446
Replacement Wheel (Each)	5639-514



Page 136

**A. STANDARD TIE-DOWNS**

1" x 69", 1,000-lb Rating  
Sold in pairs.

Description	p/n
Black	5639-411
Green	5639-415

**B. DELUXE TIE-DOWNS**

1.125" x 78", 1,200-lb Rating  
Sold in pairs.

Description	p/n
Black	5639-423

**C. RATCHET TIE-DOWNS**

1.125" x 102" 1,200-lb Rating. Sold in pairs.

Description	p/n
Black	5639-424



Page 136

**A. TOW STRAP**

Description	p/n
Tow Strap	4639-247

**B. TOW ROPE**

Description	p/n
Tow Rope	0636-577



Page 136

**TOOL ROLL**

Description	p/n
Tool Roll	5639-047



Page 136

**TOOL BAG**

Description	p/n
Tool Bag	5639-834



Page 136

## HEATED SHIELD ADAPTER

**Application**

Models with accessory outlet

**p/n**

5639-645



Page 136

## RACING TAPE

2" x 60-yd. rolls.

**Description**

Black  
Green  
Orange

**p/n**

4639-579

4639-580

5639-103



Page 136

## TOUCH-UP PAINT

Description	Application	1/2 oz.	12 oz.
<b>Hood Paint</b>			
Black (Gloss)	Black Hoods	0652-100	0652-022
Apple Green Metallic	'10 F Series LE, TZ1 Turbo LE, Z1 Turbo LE	0652-152	0652-153
Cat Green	'00-'04 ZR; '01-'04 Z; '03-'04 FC; '04 MC	0652-099	0652-067
Copper	'09 F Series LE, TZ1 Turbo LE, Z1 Turbo LE	0652-139	0652-140
Desert Red Metallic	'11-'12 TZ1 LXR, TZ1 Turbo LXR, BC Z1 XT LTD	0652-160	0652-161
Navy Blue	'10 TZ1 LXR, TZ1 Turbo LXR	0652-154	0652-155
Orange * (Top Coat)	'04-'06 KC; '05-'06 FC; '06-'07 Z; '05-'08 M; '06-'08 CF; '07-'08 F Series; '11 CF SP	0652-105	0652-106
Pearl Cat Green	'05-'06 FC, SC, Z, ZR; '05-'07 M; '06-'07 CF; '09-'11 M8 HCR	0652-115	0652-117
Pearl White (Top Coat)****	'12 F, M, XF Ltd	0652-175	0652-176
Pearl White (Base Coat)	'12 F, M, XF Ltd	0652-181	0652-182
Pink **	'09-'10 Accessory Kit	0652-137	0652-138
Sublime Green***	'11 M8 LTD, CF LTD, F8 LTD, Z1 Turbo LTD	0652-164	0652-165
White Metallic * (Top Coat)	'08-'11 M Series SP; '11 CFR, TZ1 LXR, TZ1 Turbo LXR	0652-133	0652-134
Gold Metallic (Top Coat)		0652-173	0652-174
White (Base Coat)		0652-119	0652-120
Clear (Top Coat) (12-oz. Overspray Leveler)		0652-109	0652-166

\* Metallic Top Coat only. You must first apply White (Base Coat) before applying color.

\*\* Pink 1/2 oz. (p/n 0652-137) consists of a Base Coat and a Top Coat.

Pink 12 oz. (p/n 0652-138) requires White (Base Coat) (p/n 0652-120).

\*\*\* Sublime Green (Base Coat) requires the use of Gold Metallic Top Coat.

\*\*\*\* Metallic Top Coat only. You must first apply Pearl White (Base Coat) before applying color.

Metal Paint		1/2 oz.	12 oz.
Black	Metal Parts	0652-110	0652-024
Cat Green	'98-'11	0652-111	0652-077
Orange	'08-'12	0652-141	0652-142
Orange Metallic (Top Coat)*****	'12 F, M, XF Ltd	0652-183	0652-184
Orange Metallic (Base Coat)	'12 F, M, XF Ltd	0652-179	0652-180
Pearl Cat Green	'08-'12	0652-144	0652-145
Pearl White (Top Coat)****	'12 F, M, XF Ltd	0652-177	0652-178
Pearl White (Base Coat)	'12 F, M, XF Ltd	0652-181	0652-182
Platinum	'02-'12	0652-112	0652-096
Black	High Temp		0652-052

\*\*\*\* Metallic Top Coat only. You must first apply Pearl White (Base Coat) before applying color.

\*\*\*\*\* Metallic Top Coat only. You must first apply Orange Metallic (Base Coat) before applying color.

**NOTE: Models not listed have non-paintable, color-molded plastic.**





Page 137

### CTEK BATTERY MAINTAINER

**Description**

12V 800 mA (Includes leads A, B, & D on this page)

**p/n**

5639-418



Page 137

### CTEK BATTERY CHARGER/MAINTAINER

**Description**

12V 3.3 amp (Includes leads A, B, & D on this page)

**p/n**

5639-419

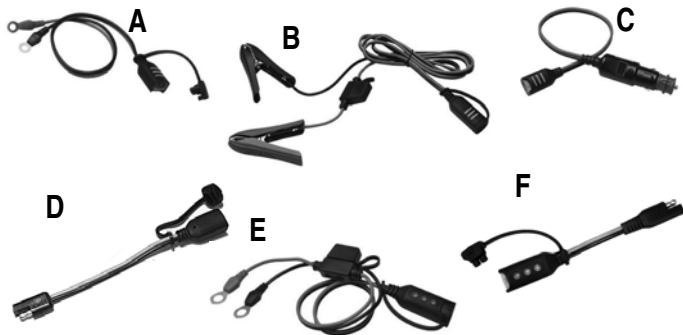

Page 137

### CTEK BATTERY LEADS

■NOTE: Comfort Indicators feature a three LED battery condition indicator.

**Description**

- (A) Ring Terminals
- (B) Alligator Clips
- (C) Outlet
- (D) Style 21 Adapter
- (E) Comfort Indicator - Ring Terminals
- (F) Comfort Indicator - Style 21

**p/n**

- 5639-420
- 5639-421
- 5639-422
- 5639-484
- 5639-485
- 5639-397



### YUASA BATTERY MAINTAINER

**Description**

12V 900 mA

**p/n**

4639-998

A



B

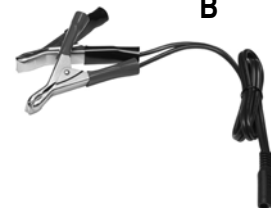

### YUASA BATTERY LEADS

**Description**

- (A) Ring Terminals
- (B) Alligator Clips

**p/n**

- 5639-162
- 5639-163



### ACCESSORY ADAPTER

**Description**

- 2-Outlet
- 3-Outlet

**p/n**

- 1639-623
- 1639-624

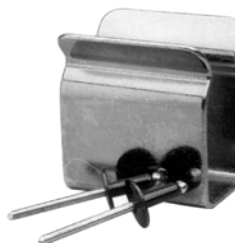

### DRIVE BELT HOLDER

**Description**

Drive Belt Holder

**p/n**

0636-659

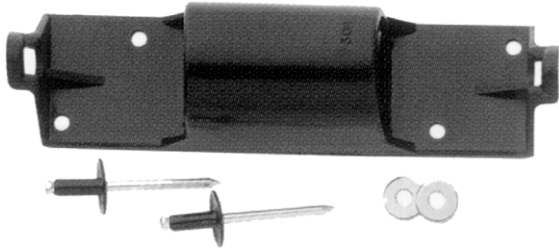

**RIVET-MOUNTED PLUG HOLDER**

**Description**  
Plug Holder

**p/n**  
4639-549



**SPARK PLUG CADDY**

**Description**  
Green

**p/n**  
1639-618



**TEMPERATURE GAUGE**

**Application**  
'99-'07 LC Models Except CF, F, FC, JR, M, SC, 4-Stroke

**p/n**  
1639-217

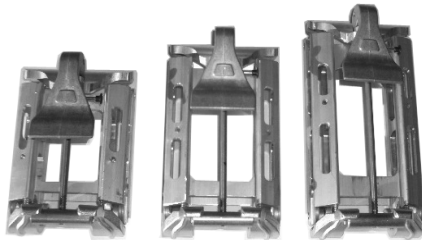

**HANDLEBAR RISER KIT**

Fits '07-'11 F Series Sno Pro; '09-'11 CFR, Z1

**Description**  
4"  
5"  
6"

**p/n**  
4639-599  
4639-600  
4639-601

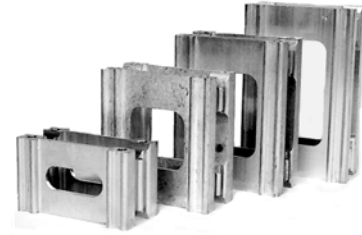

**HANDLEBAR RISERS**

Fits '02-'06 ZR; '03-'06 FC; '07-'11 F Series (Std)

**Description**  
2.44"  
3.00"  
4.44"  
5.44"  
6.44"

**p/n**  
0605-514  
0605-884  
0605-513  
0605-491  
0605-512

■NOTE: If 6.44" Riser Block (p/n 0605-512) is used on an '05-'06 FC with ACT Drive, it is necessary to install a longer Brake Line (p/n 1602-588).



**WHEEL KIT**

**Application**  
'08-'10 Sno Pro 600

**p/n**  
4639-964



**HOOD LATCH REPAIR KIT**

Includes two pins.

**Application**  
'05-'11 CF, CFR, M Series

**p/n**  
5639-498



## HORN KIT

**Application** p/n  
'08 JR; '08-'11 F Series (Liquid-Cooled), TZ1; '09-'11 Z1 (Non-Turbo) 4639-857



## 2012 DRIVE BELTS

Model	p/n	Model	p/n
BC 570	0627-067	M 1100 Turbo	0627-082
BC 570 XT	0624-046	T570	0627-067
BC Z1 XT	0627-047	TZ1 Touring	0627-069
F5 LXR, F570	0627-067	TZ1 Turbo Touring	0627-082
F 800	0627-083	XF 800	0627-083
F 1100	0627-081	XF 1100	0627-081
F 1100 Turbo	0627-082	XF 1100 Turbo	0627-082
M 800	0627-083	Sno Pro 500	0627-047
M 1100	0627-081		

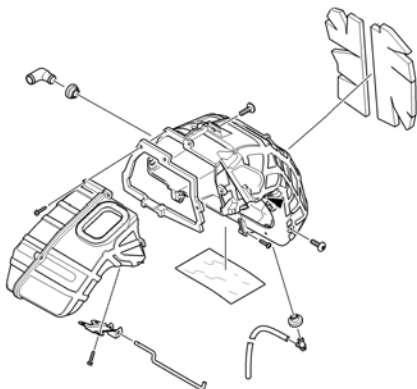

## SPLIT AIRBOX KIT

Two-piece design provides easier access to engine components.

**Application** p/n  
'07-'08 JR; '08-'11 TZ1; '09-'11 BC Z1 XT, Z1 5639-934



## NGK® SPARK PLUGS

Arctic Cat ATV and Snowmobile applications in **BOLD**.

Description	p/n
<b>Iridium Spark Plugs</b>	
BR8EIX	<b>0217-735</b>
BR9EIX	<b>0217-729</b>
BR10EIX	0217-804
CR6EIA-9	0217-733
CR7EIX	<b>0217-734</b>
DR7EIX	<b>0217-736</b>
MR8AI-9	<b>0217-806</b>
<b>Standard Spark Plugs</b>	
AB7	0217-728
AB8	0217-808
B2LM	0217-778
B4LM	0217-770
B6L	0217-789
B6S	0217-765
B7HS	0217-044
B8ES	0217-029
B8HS	0217-043
B9ES	0217-015
B9HS-10	0217-791
BKR6EKU	0217-793
BM7A	0217-781
BMR4A	0217-767
BMR6A	0217-753
BP4HS	0217-761
BP5HS	0217-783
BP8H-N-10	0217-746
BPM6A	0217-763
BPM7A	0217-749
BPM7Y	0217-764
BPM8Y	0217-752
BPMR4A	0217-772
BPMR6A	0217-773
BPMR7A	0217-741
BPR2ES	0217-747
BPR4ES	<b>0217-809</b>
BPR4HS	0217-785
BPR5ES	0217-704
BPR5HS	0217-702
BPR6ES	<b>0217-807</b>
BPR6EFS	0217-748
BPR6HS	0217-777
BPR7HS	<b>0217-716</b>
BPR9ES	0217-762
BPZ8H-N-10	0217-769
BPZ8HS-10	0217-757
BR6FS	0217-742
BR6HS	0217-027
BR7ES	0217-745
BR7HS	0217-768
BR7HS-10	0217-758
BR8ES (SCREW CAPS)	0217-034
BR8ES (SOLID CAPS)	<b>0217-701</b>
BR8HS	0217-739
BR8HS-10	0217-743
BR9ECS-5	0217-786
BR9ES (SCREW CAPS)	<b>0217-035</b>
BR9ES (SOLID CAPS)	<b>0217-700</b>
BR9EYA	<b>0217-709</b>
BR9HS-10	0217-756
BR10ES (SOLID CAPS)	<b>0217-634</b>
BR10EYA	<b>0217-714</b>
BU8H	0217-744
BUHW	0217-751
BUHW-2	0217-750
CMR7A	0217-776
CPR8E	0217-799
CR6E	<b>0217-632</b>
CR6HS	0217-792
CR6HSA	<b>0217-725</b>
CR7E	<b>0217-708</b>
CR7HS	0217-788
CR7HSA	<b>0217-726</b>
CR8E	<b>0217-705</b>
CR8EK	<b>0217-711</b>
CR9E	0217-738
CR9EH-9	0217-766
CR9EK	0217-755
CR10EK	0217-787
D7EA	0217-795
D8EA	0217-796
D8HA	0217-794
D9EA	0217-784
DCPR6E	0217-779
DCPR7E	<b>0217-717</b>
DCPR8E	0217-774
DP8EA-9	0217-782
DPR6EA-9	0217-754
DPR7EA-9	<b>0217-730</b>
DPR8EA-9	0217-737
DPR8Z	0217-775
DPR9EA-9	0217-790
DR7EA	<b>0217-713</b>
DR8EA	3304-919
DR8ES	0217-771
DR8ES-L	0217-740
IZFR5G	0217-759
KR8AI	<b>0217-719</b>
LFR5A-11	0217-760
LFR6A-11	0217-780
PZFR6H	0217-641



## SPARK PLUG CAPS

**Description**

(A) Silicone Rubber - Black  
(B) Standard Type - Black

**p/n**

3006-367  
3003-175



## RAIL BRACE KIT

Includes RH & LH rail braces and mounting hardware.

**Application**

M Series 153" & 162", XF 141"

**Year**

'12

**Color**

Black  
Orange  
Unpainted  
Unpainted

**p/n**

5639-981  
5639-982  
5639-983  
5639-242

M Series 153"

'09-'11

## SPEEDOMETER/TACHOMETER

**Application**

'08-'09 Sno Pro 600

**p/n**

4639-960

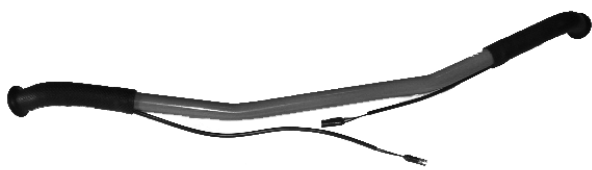

## HEAVY-DUTY HANDLEBAR

Includes grips and heating elements.

**Application**

'05-'10 Sno Pro 600

**p/n**

1705-155



## THROTTLE LEVER BOLT KIT

Fits models with aluminum throttle block.

**Application**

'05-'10 Sno Pro 600

**p/n**

4639-336



## FUEL PUMP REPAIR KITS

**Description**

Rectangular Mikuni  
Round Mikuni  
Square Mikuni  
Pentagon Mikuni  
ATP 2/3

**p/n**

0636-272  
0636-276  
0636-640  
1639-191  
2639-095

## SILICONE GASKET MAKER

Excellent for sealing around belly pan area and air box seams.

**Description**

Ultra Black Silicone Gasket Maker 70 ml

**p/n**

1639-834

## HIGH TEMP SILICONE SEALANT

This sealant is recommended for sealing the crankcase halves of all Suzuki liquid-cooled engines.

**Description**

High Temperature Silicone 90 ml

**p/n**

0636-069

## ARCTIC CAT LOCTITE

**Description**

Loctite 242 Blue 10 ml  
Loctite 242 Blue 50 ml  
Loctite 263 Red 10 ml  
Loctite 263 Red 50 ml  
Loctite 271 Red 10 ml  
Loctite 271 Red 50 ml  
Loctite 290 Green Wicking 10 ml  
Loctite 290 Green Wicking 50 ml  
Loctite 609 Green Retaining 50 ml  
Loctite 620 Green Ret Hi Temp 10 ml  
Loctite 620 Green Ret Hi Temp 50 ml

**p/n**

1639-814  
1639-815  
5639-901  
5639-902  
1639-819  
1639-820  
1639-823  
1639-824  
1639-821  
1639-826  
1639-822

## HANDLEBAR GRIP ADHESIVE

**Description**

Loctite 498 1 oz.

**p/n**

1048-058

## CRANKCASE SEALANT

This sealant is highly recommended for sealing all Arctic Cat, Suzuki fan-cooled engine crankcase halves.

**Description**

Three-Bond Gasket Sealant

**p/n**

0636-070

## CRANKCASE SEALANT - 4-STROKE

This sealant is recommended for Arctic Cat 4-Stroke engines.

**Description**

Sealant, 100 gram tube

**p/n**

1048-070

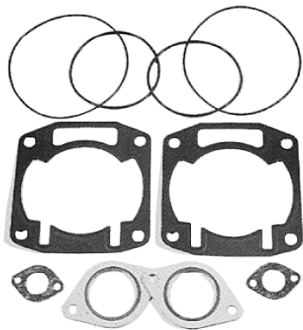

## GASKET SETS

### Application

340 F/C Twin  
370 F/C Twin  
440 F/C Twin (Except those listed below)  
440 F/C Twin ('99 Z 440; '00-'03 Z 440 Sno Pro)  
440 F/C Twin  
440 L/C Twin

440 L/C Twin (ZR)  
440 L/C Twin (Prowler Special)  
440 L/C Twin w/Reed  
500 F/C Twin (56 H.P.)  
500 F/C Twin (48 H.P.)  
500 L/C Twin, Non-APV "Laydown" (Sno Pro)  
500 L/C Twin, APV "Laydown"  
500 L/C Twin, APV  
500 L/C Twin, Non-APV  
530 L/C Twin

550 L/C Twin  
570 F/C Twin  
580 L/C Twin  
600 L/C Twin, APV "Laydown"  
600 L/C Twin, APV  
600 L/C Twin, Non-APV  
600 L/C Triple, APV  
600 L/C Triple  
650 L/C Twin  
660 L/C Triple (4-Stroke)

660 L/C Triple (4-Stroke) Turbo  
700 L/C Twin, APV "Laydown"  
700 L/C Twin

800 L/C Twin, APV "Laydown" (Power Up)

800 L/C Twin, APV  
800 L/C Triple  
900 L/C Twin, APV  
900 L/C Triple  
1000 L/C Twin, APV "Laydown"  
1000 L/C Triple  
1100 L/C Twin (4-Stroke)

Year	p/n
'79-'00	0636-128
'99-'08	1639-123
'97-'06	0639-441
'99-'03	1639-605
'80-'96	0636-095
'90-'00	0636-635
'78-'89	0636-096
'93-'95	0636-884
'91-'92	0636-884
'97-'00	0639-224
'86-'91	0636-093
'85-'87	0636-094
'04-'12	3639-539
'03-'06	2639-972
'01-'02	1639-988
'98-'02	0639-115
'87-'91	0636-097
'86	0636-183
'80-'85	0636-098
'91-'05	0636-812
'02-'12	2639-147
'91-'04	0636-812
'04-'09	3639-538
'01-'03	1639-989
'98-'02	0639-115
'01-'02	1639-990
'95-'00	0638-938
'88-'90	0636-409
'03-'08	3006-944
'02	3006-296
'05-'07	3006-961
'04	3006-759
'03-'06	2639-973
'91-'96,	0636-813
'99-'00	
'10-'12	5639-520
'07-'09	4639-664
'01-'04	1639-991
'95-'01	0638-205
'03-'06	1639-991
'93-'97	0638-205
'07-'12	4639-663
'98-'02	0638-205
'07-'12	4639-619

## ACT DRIVE GASKET SETS

### Application

CF, M Series  
F Series

Year	p/n
'08	2602-267
'07	2602-191
'07-'08	2602-192

## ACT DRIVE CASE SEALANT

This sealant is recommended for ACT drive cases.

### Description

Sealant, 3-oz. tube

p/n
4639-030

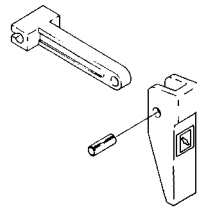

## CHOKE LEVER REPAIR KIT

### Application

Single or Dual Carburetor  
Triple Carburetor  
'01-'02 Triple Models

p/n
0636-062
0638-630
1639-835



## TRACK CLIP TOOL

### Description

Track Clip Tool

p/n
0644-194

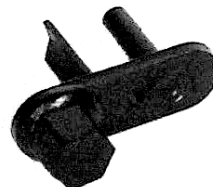

## OVERLOAD SPRING TOOL

### Description

Overload Spring Tool

p/n
0744-022

## FOX SHOCK REBUILD KITS

### Description

IFP Shock  
Front Arm Adjustable Shock  
Clicker Shock  
Float w/o Reservoir  
Float w/Reservoir

p/n
1639-769
1639-770
1639-771
2604-796
2603-498



## DRIVE CLUTCH SPRING

Provides smoother, lower RPM clutch engagement.

### Application

'10-'12 800 cc Models

p/n
0646-252

## Helmet Parts



### TXI



### EYEPORT FOAM PIECE

Description	p/n
'02-'11	
3/4"	4212-291
5/8"	4212-292



A



B

### A. CHIN CURTAIN

Description	p/n
Chin Curtain	4212-290

### B. CHIN VENT

Description	p/n
Chin Vent	4222-801
Chrome Chin Vent	4252-032



### SIDE AND TOP VENT COVER KIT

Description	p/n
Vent Cover Kit	4222-800
Chrome Vent Cover Kit (Side Vents Only)	4252-033



### RATCHET KIT

Description	p/n
Ratchet Kit	4212-919
Shield Screws Only (10/pkg)	4212-801



A



B

### A. SHIELD

Description	p/n
Clear	4212-845
Smoke	4212-846
Yellow	4212-847
Silver Mirror	4222-740
Chrome Frame/Clear	4232-880
Chrome Frame/Smoke	4232-881
Chrome Frame/Yellow	4232-882
Chrome Frame/Silver Mirror	4232-883

### B. ELECTRIC SHIELD KIT

Description	p/n
Electric Shield Kit	4212-848
Replacement Elec. Coil Cord	4202-922
Replacement Elec. Dash Cord	4202-923
Accessory Ext. Harness - 24"	1686-457
Replacement Elec. Shield Only	4212-849
Electric Shield Cord Converter (PFP coil cord to TXi dash)	4222-510
Electric Shield Cord Converter (TXi coil cord to PFP dash)	4222-511



### VISOR

Description	p/n
Black	4212-101
Chrome	4232-884
Visor Screws Only (12/pkg)	4222-803



**PFP & PFP YOUTH**



**PFP II**

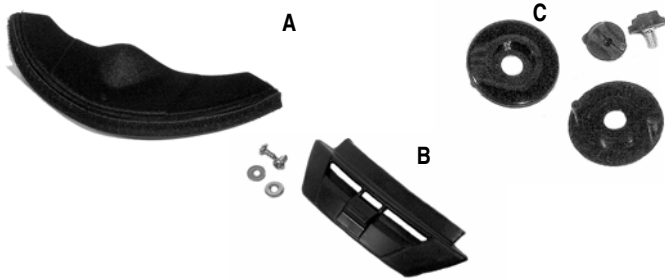

**A. BREATH DEFLECTOR**

**Description**  
Breath Deflector **p/n**  
4982-765

**B. CHIN VENT**

**Description**  
Chin Vent **p/n**  
4992-735

**C. RATCHET KIT**

**Description**  
Ratchet Kit **p/n**  
4912-122  
Shield Screws Only (Metal Thread) 10/pkg 4212-801



**RATCHET KIT**

**Description**  
Ratchet Kit **p/n**  
4982-762  
Shield Screws Only (10/pkg) 4212-801



**A. SHIELD**

**Description**  
Clear **p/n**  
4972-463  
Smoke 4972-464

**B. ELECTRIC SHIELD**

**Description**  
Electric Shield **p/n**  
4972-468  
Replacement Electric Coil Cord 4962-712  
Replacement Electric Dash Cord 4962-713  
Accessory Ext. Harness - 24" 1686-457  
Replacement Electric Shield Only 4972-469



**A. SHIELD**

**Description**  
Clear **p/n**  
4212-810  
Smoke 4212-811  
Amber/Yellow 4212-812

**B. ELECTRIC SHIELD KIT**

**Description**  
Electric Shield Kit (2012) **p/n**  
5222-500  
Replacement Electric Coil Cord (2012) 4202-922  
Replacement Electric Dash Cord (2012) 4202-923  
Replacement Electric Shield Only (2012) 5222-501  
Replacement Electric Coil Cord (2011 and older) 4962-712  
Replacement Electric Dash Cord (2011 and older) 4962-713  
Electric Shield Cord Converter (PFP 2011 coil cord to TXi dash) 4222-510  
Electric Shield Cord Converter (TXi coil cord to PFP 2011 dash) 4222-511  
Accessory Ext. Harness - 24" 1686-457



**ATV OPEN FACE**



**VISOR**

**Description**  
Visor

**p/n**  
4208-239



**VISOR (2005-2011)**

**Description**  
Visor

**p/n**  
4258-009



**SNO-CROSS SNO PRO (Model Pro-X)**

**VISOR**

**Description**

Black	5212-600
Sno Pro Orange Graphics (2012)	5222-400
Sno Pro Black Graphics (2012)	5222-360



**SNO/ATV MX (Model 555)**

**A. VISOR**

<b>Description</b>	<b>p/n</b>
Black	4242-950
Chrome	4252-017
Flat Black	4282-920
Visor Screws (10/pkg)	4212-801

**B. FRONT VENT**

<b>Description</b>	<b>p/n</b>
Front Vent	4242-951

**C. TOP VENT COVER**

<b>Description</b>	<b>p/n</b>
Top Vent Cover	4242-953

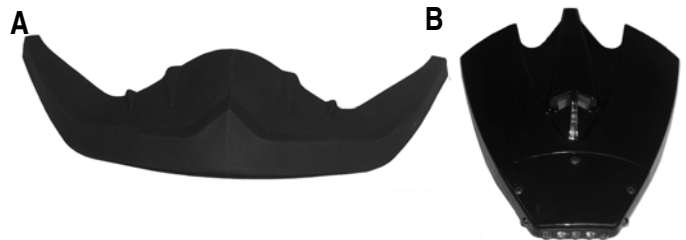

**A. WINDGUARD**

<b>Description</b>	<b>p/n</b>
Windguard	4242-954

**B. TAILLIGHT**

<b>Description</b>	<b>p/n</b>
Taillight	4242-952





**TEAM ARCTIC (Model Moto X)**

**A. VISOR**

Description	p/n
Black	5212-601
Team Arctic Green Graphics (2012)	5222-390
Team Arctic Black Graphics (2012)	5222-370
Team Arctic Orange Graphics (2012)	5222-380

**B. BREATH DEFLECTOR**

Description	p/n
Breath Deflector	5212-599

**CROSSTEC**



**FRONT & REAR LED LIGHT**

Description	p/n
(A) Front Light Assy	4262-900
(B) Rear LED Light Assy	4262-901
(B) Rear Light Cover	4262-902



**FRONT LIGHT LENS**

Description	p/n
Front Light Lens	4282-904
Light Button	4282-903



**MIC & SPEAKERS**

Description	p/n
VRE Mic. Assy	4262-903
VRE Mic. Foam Assy	4262-904
Headset Speaker (Each)	4262-905



**SHIELD**

Description	p/n
(C) Electric Shield Kit ('02-'09)	4282-869
(C) Electric Shield Only ('02-'09)	4282-865
Electric Shield Coil Cord (Not Shown)	4202-922
Electric Shield Power Cord (Not Shown)	4202-923
Accessory Ext. Harness - 24"	1686-457
(A) Magnetic Power Cord	4262-907
(B) Crosstec/TXI Retrofit Headset Electric Shield Cord	4262-716
Clear Replacement Shield	4282-859
VRE Headset Electric Shield Cord (Not Shown)	4262-717
(D) Sun Shield - Smoke	4262-713
(D) Sun Shield - Yellow	4262-714
(D) Sun Shield - Orange	4262-715
Sun Shield Knob w/screw (Not Shown)	4272-997



**BREATH DEFLECTOR**

<b>Description</b>	<b>p/n</b>
Breath Deflector (XS-M)	4282-860
Breath Deflector (L-2XL)	4282-861



**VISOR**

<b>Description</b>	<b>p/n</b>
Visor - Black (2007-2009)	4272-999



**RATCHET KIT**

<b>Description</b>	<b>p/n</b>
(A) Ratchet Kit	4262-911
Ratchet Disc Set	4282-901
(B) Aluminum Shield Screws (Pair)	4262-910
(C) Top Ratchet Bar	4282-902



**CHINBAR**

<b>Description</b>	<b>p/n</b>
(A) Replacement Chinbar	4272-998
(B) Chinbar Lock Plate	4282-223



**CHIN PAD**

<b>Description</b>	<b>p/n</b>
Chin Pad	4262-933



**CHIN CURTAIN**

<b>Description</b>	<b>p/n</b>
(A) Chin Curtain	4262-912
(B) Extended Chin Curtain	4282-900



**VRE MUSIC ADAPTER CORD**

<b>Description</b>	<b>p/n</b>
Adapter Cord	4262-906
Cat Comm MP3/Satellite Radio Cord - 80"	4292-950

## High Altitude Kits

■NOTE: For more information on the High Altitude Kit Exchange Program, see page 1.

## 2012 Optional Rear Suspension Springs

Model	Standard Rear Arm Spring	Optional Rear Arm Spring	Spring Type
Bearcat 570, T570, TZ1 Models	1704-146/147	L 1704-678/679 H 1704-360/361	SQUARE SQUARE
F 800 Models, F 1100 Models	1704-576/577	L 1704-354/355 H 1704-560/561	SQUARE SQUARE
F5, F570	1704-504/505	L 1704-576/577 H 1704-710/711	SQUARE SQUARE
BC XT GS	1704-842/843	L N/A H 1704-384/385	SQUARE SQUARE
BC 570 XT/BC Z1 XT	1704-852/853	L 1704-562/563 H 1704-842/843	SQUARE SQUARE

### Rear Suspension Spring Selection Chart

This chart was compiled to assist technicians in fine-tuning the Arctic Cat rear suspension when the original springs are not satisfactory and a softer or firmer ride is desired. A longer spring in areas (D) and (E) can be selected if cut off to match the original spring. The replacement spring must match the original spring in areas (D) and (E).

■NOTE: The wire diameter and length of the spring have a large influence over the valving of the shocks.

■NOTE: When installing Springs (p/n 1704-148/149), you must also use the white Plastic Sleeves (p/n 2604-379).

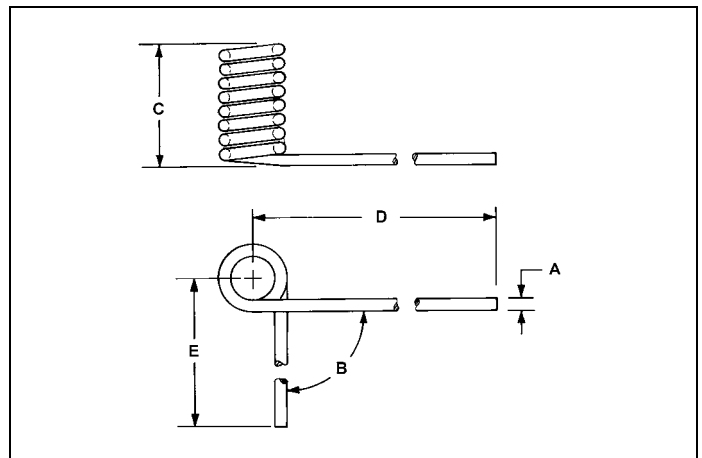

2012 Models	Altitude	p/n	Components
F 570 T 570 Bearcat 570	5-9,000 ft.	5639-489	(2) 6505-029 Pilot Jet 35 (3) 0746-695 (67.0 g) Cam Arm (1) 0748-700 (P1 36°)(N) Torque Bracket
	Over 9,000 ft.	5639-490	(2) 6505-029 Pilot Jet 35 (3) 0746-670 (65.0 g) Cam Arm* (1) 0748-700 (P1 36°)(N) Torque Bracket
Bearcat 570 XT	5-9,000 ft.	5639-627	(2) 6505-029 Pilot Jet 35 (3) 0746-669 (60.0 g) Cam Arm (1) 0748-700 (P1 36°)(N) Torque Bracket
	Over 9,000 ft.	5639-490	(2) 6505-029 Pilot Jet 35 (3) 0746-670 (65.0 g) Cam Arm* (1) 0748-700 (P1 36°)(N) Torque Bracket
Bearcat Z1 XT	5-9,000 ft.	5639-935	(3) 0746-828 (57.0 g) Cam Arm*
	Over 9,000 ft.	5639-936	(3) 0746-829 (52.0 g) Cam Arm* (1) 0646-433 Gold Stripe Clutch Spring
Bearcat Z1 XT GS	Over 9,000 ft.	5639-937	(3) 0746-828 (57.0 g) Cam Arm* (1) 0646-433 Gold Stripe Clutch Spring
TZ1 (Non Turbo)	5-9,000 ft.	4639-687	(3) 0746-678 (P3 55.0 g) Cam Arm (1) 0748-662 (36°) Torque Bracket
	Over 9,000 ft.	4639-639	(3) 0746-663 (52.0 g) Cam Arm (1) 0748-662 (36°) Torque Bracket
F5 LXR	5-9,000 ft.	4639-639	(3) 0746-663 (52.0 g) Cam Arm (1) 0748-662 (36°) Torque Bracket
	Over 9,000 ft.	4639-640	(3) 0746-792 (47.0 g) Cam Arm (1) 0748-662 (36°) Torque Bracket
F 800	5-9,000 ft.	5639-972	(3) 0746-671(P1 70.0 g) Cam Arm*
	Over 9,000 ft.	5639-974	(3) 0746-695 (P1 67.0 g) Cam Arm* - Wide (1) 0748-729 (36°) Torque Bracket**
F 1100 (Non Turbo)	5-9000 ft.	5639-978	(3) 0746-663 (52.0 g) Cam Arm
	Over 9,000 ft.	5639-979	(3) 0746-705 (P2 49.0 g) Cam Arm* -
Sno Pro 500	5-9000 ft.	5639-507	(3) 0746-666 (55.0 g) Cam Arm*
	Over 9,000 ft.	5639-508	(3) 0746-661 (52.0 g) Cam Arm*
XF 800 LXR, SP Models	3-6,000 ft.	5639-971	(3) 0746-716 (P1 73.0 g) Cam Arm* - Wide (1) 0748-729 (36°) Torque Bracket**
	6-9,000 ft.	5639-973	(3) 0746-671 (P1 70.0 g) Cam Arm* (1) 0748-729 (36°) Torque Bracket**
	Over 9,000 ft.	5639-974	(3) 0746-695 (P1 67.0 g) Cam Arm* - Wide (1) 0748-729 (36°) Torque Bracket**
XF 800 High Country	0-3,000 ft.	5639-975	(3) 0746-672 (P1 75.0 g) Cam Arm* (1) 0748-731 (42°/40°) Torque Bracket**
	3-6,000 ft.	5639-971	(3) 0746-716 (P1 73.0 g) Cam Arm* - Wide (1) 0748-729 (36°) Torque Bracket**
	Over 9,000 ft.	5639-974	(3) 0746-695 (P1 67.0 g) Cam Arm* - Wide (1) 0748-729 (36°) Torque Bracket**
XF 1100 (Non Turbo)	3-6,000 ft.	5639-977	(3) 0746-674 (P2 55.0 g) Cam Arm* - Wide
	6-9,000 ft.	5639-978	(3) 0746-663 (P2 52.0 g) Cam Arm* - Wide
	Over 9,000 ft.	5639-979	(3) 0746-705 (P2 49.0 g) Cam Arm* - Wide
XF 1100 (Turbo)	6-9,000 ft.	0748-747	(1) 0748-731 (42°/40°) Torque Bracket**
	Over 9000 ft.	0748-747	(1) 0748-731 (42°/40°) Torque Bracket**
■Note: M 800 and M 1100 models have been set up at the factory to operate at an altitude of 6,000 to 9,000 feet.			
M 800	0-3,000 ft.	5639-975	(3) 0746-672 (P1 75.0 g) Cam Arm* (1) 0748-731 (42°/40°) Torque Bracket**
	3,000-6,000 ft.	5639-227	(3) 0746-716 (P1 73.0 g) Cam Arm* - Wide
	Over 9,000 ft.	4639-644	(3) 0746-695 (P1 67.0 g) Cam Arm* - Wide
M 1100 (Non Turbo)	0-3,000 ft.	5639-976	(3) 0746-632 (60.0 g) Cam Arm* - Wide
	3,000-6,000 ft.	5639-977	(3) 0746-674 (P2 55.0 g) Cam Arm* - Wide
	Over 9,000 ft.	5639-979	(3) 0746-705 (P2 49.0 g) Cam Arm* - Wide

\* w/set screw

\*\* w/bearing assembly

# Catalog

## Table of Contents

P/N	Replaced By	Wire Diameter (A)	Angle (B)	Number of Coils	Coil Width (C)	Length (D)	Length (E)	Spring Type
0604-054/053		.406	65°	7.75	3.88	17.50	4.50	Round
0604-118/117	1704-174/175	.460	45°	9.00	4.75	17.50	4.50	Round
0604-272/273		.437	90°	9.00	4.80	17.50	5.50	Round
0604-282/283		.437	75°	9.00	4.80	17.50	5.50	Round
0604-288/289		.460	60°	9.00	4.75	17.50	4.50	Round
0604-290/291		.490	60°	9.00	5.02	17.50	4.50	Round
0604-314/315**		.460	90°	9.00	5.03	17.50	5.50	Round
0604-400/401	1704-182/183	.406	90°	8.75	4.32	17.50	5.50	Round
0604-454/455*		.437	90°	9.00	4.80	17.50	4.50	Round
0604-474/475	1704-072/073	.406	90°	7.75	3.88	17.50	4.50	Round
0604-492/493		.406	90°	8.75	4.32	15.75	5.50	Round
0604-584/585	0704-986/987	.406	90°	8.75	4.32	18.10	5.70	Round
0604-592/593		.460	83°	8.75	4.80	15.75	5.50	Round
0604-654/655		.437	83°	8.75	4.59	20.00	5.70	Round
0604-660/661		.437	83°	8.73	4.59	18.10	5.70	Round
0604-746/747		.390	90°	8.75	4.32	19.75	5.70	Round
0604-970/971*		.421	90°	8.75	4.43	15.90	5.70	Round
0704-822/821		.452	90°	8.75	4.45	18.75	5.50	Round
0704-856/857**		.437	90°	8.75	4.59	20.00	5.70	Round
0704-876/877	1604-616/617	.375	90°	5.75	3.00	15.62	5.12	Square
0704-886/887**	1604-060/601	.460	77°	8.75	4.85	20.00	5.50	Round
0704-888/889**	1604-062/063	.437	75°	8.75	4.60	18.00	5.50	Round
0704-890/891	1604-600/601	.359	90°	5.75	3.00	15.62	5.12	Square
0704-892/893	1604-818/819	.405	75°	8.75	4.32	19.00	5.50	Square
0704-902/901		.405	80°	7.75	3.92	19.00	5.50	Square
0704-908/909**		.437	75°	8.75	4.60	18.50	5.50	Round
0704-926/927	2604-352/353	.375	80°	5.75	3.00	18.50	5.12	Square
0704-934/935	2604-356/357	.405	90°	5.75	3.00	18.50	5.12	Square
0704-938/939	1604-442/443	.452	90°	8.75	4.53	16.00	5.70	Round
0704-944/945**	1604-604/605	.452	75°	8.75	4.62	18.75	5.50	Round
0704-968/969		.437	90°	6.75	3.50	18.50	5.12	Square
0704-988/989**		.437	90°	8.75	4.59	18.10	5.70	Round
0704-990/991	1604-178/179**	.421	77°	8.75	4.32	20.00	5.50	Round
0704-994/995	1604-388/389**	.452	75°	8.75	4.60	18.00	5.50	Round
1604-065/064		.421	75°	8.75	4.45	18.00	5.50	Round
1604-067/066	1704-083/082	.460	75°	8.75	4.83	18.00	5.50	Round
1604-076/077**		.460	97°	9.00	4.53	16.00	5.70	Round
1604-078/079**	1704-300/301	.437	83°	8.75	4.56	21.00	5.70	Round
1604-144/145***	1704-302/303	.437	77°	8.75	4.52	22.00	8.00	Round
1604-146/147***		.421	77°	8.75	4.52	22.00	8.00	Round
1604-149/148**	1704-289/288	.460	77°	8.75	4.84	22.00	8.00	Round
1604-194/195**	1704-088/089	.460	90°	8.75	4.53	16.00	6.70	Round
1604-224/225**	1704-290/291	.460	83°	8.75	4.53	21.00	5.70	Round
1604-381/380***	1704-135/134	.452	77°	8.75	4.97	22.00	8.00	Round
1604-608/609	1704-344/345	.437	83°	8.75	4.59	20.75	5.70	Round
1604-739/740**		.437	75°	8.75	4.60	16.00	5.50	Round
1704-044/045		.405	75°	8.75	4.32	18.50	5.50	Square
1704-146/147		.405	70°	6.75	4.32	18.50	5.50	Square
1704-148/149		.437	75°	7.75	4.25	18.50	5.50	Square
1704-184/185		.421	90°	8.75	4.43	18.10	5.70	Round
1704-260/261		.405	70°	7.75	3.85	18.50	5.50	Square
1704-352/353		.375	80°	7.75	3.80	18.50	5.50	Square
1704-354/355		.375	75°	8.75	4.32	18.50	5.50	Square
1704-360/361		.405	70°	5.75	4.00	18.50	5.50	Square
1704-382/383		.359	90°	5.75	3.00	15.62	4.60	Square
1704-384/385		.375	90°	5.75	3.00	15.62	4.60	Square
1704-444/445		.437	90°	6.75	3.65	18.50	5.50	Square
1704-504/505		.405	85°	6.75	3.65	18.50	5.50	Square
1704-560/561		.405	85°	6.75	3.65	18.50	5.48	Square
1704-562/563		.405	70°	6.75	4.50	18.50	5.50	Square
1704-566/567		.405	85°	6.75	3.65	18.50	5.36	Square
1704-576/577		.405	94°	6.75	3.65	18.50	5.50	Square
1704-678-679		.405	78°	6.75	4.00	18.50	5.50	Square
1704-710/711		.405	75°	6.75	3.65	18.50	5.50	Square
1704-808/809		.405	90°	8.00	3.87	18.50	5.50	Square
1704-842/843		.437	80°	7.75	4.50	18.50	5.50	Square
1704-852/853		.437	75°	7.75	4.50	18.50	5.50	Square
2604-044/045		.452	90°	8.75	4.68	18.75	5.50	Round
2604-566/567*		.488	85°	5.75	4.00	18.75	5.50	Round
2604-612/613		.405	70°	6.75	4.00	18.50	5.50	Square
2604-898/899*		.465	80°	5.00	3.40	18.75	5.50	Round
2704-224/225		.437	105°	8.80	3.75	15.62	4.70	Square
3604-488/489		.437	80°	7.75	4.50	18.50	5.50	Square

\*Long leg of spring is bent inward \*\*Short leg of spring is bent inward \*\*\*Must be cut to correct length • Titanium \*\* Spring color is Platinum

# Drive Belts

## Application Guide

**1988**

Jag 340, 440, Jag Deluxe..... 0227-100  
 Super Jag, Panther..... 0227-030  
 Cougar, Panthera..... 0227-101  
 El Tigre 5000, 6000..... 0227-101  
 Cheetah Touring, L/C..... 0227-101  
 Wildcat 650..... 0627-004

**1989**

Jag 340, Jag Deluxe..... 0227-100  
 Super Jag, Jag AFS..... 0227-032  
 Panther, Cougar..... 0227-032  
 Panthera, Cheetah Touring..... 0227-032  
 El Tigre 6000, EXT..... 0227-032  
 Wildcat 650..... 0627-001

**1990**

Jag 340..... 0227-100  
 Jag Mountain Cat..... 0227-100  
 Panther, Jag AFS..... 0227-103  
 Cougar, Cheetah Touring..... 0227-103  
 Panthera, El Tigre EXT..... 0227-103  
 Wildcat 650..... 0627-006  
 Prowler..... 0227-103

**1991**

Lynx..... 0227-030  
 Jag AFS, Panther..... 0227-103  
 Jag Long Track..... 0227-103  
 Super Jag..... 0227-103  
 Jag 340 Mountain Cat..... 0227-100  
 Cougar, Cheetah Touring..... 0227-103  
 Panthera, Prowler..... 0227-103  
 El Tigre EXT..... 0227-103  
 Prowler Special..... 0227-103  
 EXT Special..... 0227-103  
 Wildcat 700..... 0627-006

**1992**

Jag, Jag Special..... 0227-103  
 Super Jag..... 0227-103  
 Jag AFS LT..... 0227-103  
 Cheetah..... 0227-103  
 Cougar..... 0227-103  
 Lynx, Lynx Deluxe..... 0227-030  
 Lynx Mountain Cat..... 0227-103  
 Panthera..... 0227-103  
 Prowler, Prowler Special..... 0227-103  
 EXT, EXT Special..... 0227-103  
 Panther..... 0227-103  
 Wildcat (AWS)..... 0627-008  
 Wildcat EFI (AFS)..... 0627-006

**1993**

Jag, Jag 440 Z..... 0227-103  
 Jag AFS LT..... 0227-103  
 Cheetah..... 0227-103  
 Cougar..... 0227-103  
 Lynx, Lynx Deluxe..... 0227-030  
 Lynx Mountain Cat..... 0227-103  
 Panthera..... 0227-103  
 Prowler, Prowler 440Z..... 0227-103  
 EXT, EXT 580 Z..... 0227-103  
 Panther..... 0227-103  
 Wildcat..... 0627-011  
 Thundercat..... 0627-010  
 ZR Models..... 0627-012

**1994**

Puma, Puma Deluxe,  
 Puma 2-Up..... 0227-103  
 Jag, Jag 440Z..... 0227-103  
 Cheetah Models..... 0227-103  
 Cougar..... 0227-103  
 Panthera..... 0227-103  
 Prowler EFI..... 0227-103  
 EXT 580 Models..... 0627-012  
 Panther Deluxe..... 0227-103  
 Wildcat EFI..... 0627-011  
 ZR Models..... 0627-012  
 Thundercat..... 0627-010

**1995**

Puma, Puma Deluxe,  
 Puma 2-Up..... 0227-103  
 Jag, Jag Deluxe..... 0227-103  
 Panther..... 0227-103  
 Bearcat 340..... 0627-013  
 Bearcat 440 & 550 0627-014  
 Cougar..... 0627-012  
 Prowler..... 0627-012  
 Panthera..... 0627-012  
 EXT..... 0627-012  
 EXT Powder Special..... 0627-010  
 Wildcat, Wildcat Touring..... 0627-010  
 Thundercat..... 0627-010  
 Z440..... 0627-012  
 ZR440, ZR580..... 0627-012  
 ZR700..... 0627-010  
 ZRT800..... 0627-010

**1996**

Puma, Puma Deluxe,  
 Puma 2-Up..... 0227-103  
 Jag, Jag Deluxe, Jag L/C..... 0227-103

**1996 (Cont.)**

Z440, Panther Deluxe,  
 Panther L/C..... 0627-012  
 Bearcat 340..... 0627-013  
 Bearcat 440 & 550..... 0627-014  
 Cougar, Cougar 2-Up,  
 Cougar M/C..... 0627-012  
 Panthera..... 0627-012  
 EXT EFI Models..... 0627-012  
 EXT 580..... 0627-012  
 EXT 580 Powder Special..... 0627-010  
 Wildcat Models..... 0627-010  
 Thundercat, ZRT 800,  
 ZRT 600..... 0627-010  
 ZR 580 Models, ZR440..... 0627-012

**1997**

Puma, Puma Deluxe,  
 Puma 2-Up..... 0627-012  
 Jag, Jag Deluxe..... 0627-012  
 Panther, Panther L/C..... 0627-012  
 Z440, ZL440..... 0627-012  
 Bearcat 340..... 0627-013  
 Bearcat 440 & 550..... 0627-014  
 Cougar, Cougar M/C..... 0627-012  
 Panthera..... 0627-012  
 EXT EFI Models..... 0627-012  
 Powder Special EFI..... 0627-012  
 Thundercat, ZRT 800,  
 ZRT 600..... 0627-010  
 ZR 580, ZR440..... 0627-010  
 EXT 600, Powder Extreme..... 0627-010  
 Powder 580 Carb..... 0627-010

**1998**

Jag 340, Panther 340..... 0627-012  
 Jag 440, Jag 440 DLX..... 0627-012  
 Z 440, Panther 440..... 0627-012  
 Panther 550..... 0627-021  
 Bearcat 340..... 0627-013  
 Bearcat 440,  
 Bearcat Wide Track..... 0627-014  
 Cougar, Cougar DLX,  
 Cougar M/C..... 0627-021  
 Panthera 580..... 0627-021  
 Panthera 800..... 0627-020  
 EXT EFI..... 0627-020  
 EXT EFI DLX..... 0627-021  
 EXT 600, EXT 600 Touring..... 0627-020  
 Powder Special,  
 Powder Special EFI..... 0627-020  
 Powder Extreme..... 0627-020  
 Thundercat, Thundercat M/C..... 0627-020  
 ZRT 600, ZRT 800..... 0627-020  
 ZR 600, ZR 600 EFI..... 0627-020  
 ZL 440..... 0627-021  
 ZL 500, ZR 500..... 0627-020  
 ZR 440..... 0627-020

**1999**

Jag 340 DLX, Panther 340..... 0627-012  
 Jag 440, Jag 440 DLX..... 0627-012  
 Panther 440..... 0627-012  
 Panther 550..... 0627-021  
 Bearcat 340, Bearcat 440 I..... 0627-013  
 Bearcat 440 II,  
 Bearcat Wide Track..... 0627-014  
 Panthera 580 EFI..... 0627-021  
 Panthera 800..... 0627-020  
 Triple Touring 600..... 0627-020  
 Powder Special 500 EFI..... 0627-020  
 Powder Special 600 Models..... 0627-020  
 Powder Special 700..... 0627-020  
 Thundercat, Thundercat M/C..... 0627-020  
 Z 370..... 0627-021  
 Z 440..... 0627-021  
 ZL 440..... 0627-021  
 ZL 500 Models,  
 ZL 600 Models..... 0627-020  
 ZR 500 Models..... 0627-020  
 ZR 600 Models..... 0627-020  
 ZR 700..... 0627-020  
 ZRT 600, ZRT 800..... 0627-020

**2000**

Bearcat 340..... 0627-013  
 Bearcat 440 I/440 II/  
 Wide Track..... 0627-014  
 Panthera Models..... 0627-020  
 Panthera 340/440..... 0627-012  
 Panther 550..... 0627-021  
 Powder Special Models..... 0627-020  
 Thundercat Models..... 0627-020  
 Triple Touring 600..... 0627-020  
 Z Models..... 0627-021  
 ZL 440/550..... 0627-021  
 ZL 500/580/600/700..... 0627-020  
 ZR Models..... 0627-020  
 ZRT Models..... 0627-020

**2001**

Bearcat W/T..... 0627-014

**2001 (Cont.)**

Mountain Cat Models..... 0627-020  
 Panther Models..... 0627-020  
 Panther 370 Models..... 0627-013  
 Panther 440 Models..... 0627-012  
 Panther 550..... 0627-021  
 Thundercat..... 0627-020  
 Triple Touring 600..... 0627-020  
 Z Models..... 0627-021  
 ZL Models..... 0627-020  
 ZR Models..... 0627-020  
 ZRT Models..... 0627-020

**2002**

Bearcat W/T..... 0627-014  
 Mountain Cat Models..... 0627-020  
 Panthera 550..... 0627-021  
 Panthera Models (EFI)..... 0627-020  
 Panther Models..... 0627-021  
 Thundercat..... 0627-020  
 Mountain Cat Models..... 0627-021  
 ZL Models..... 0627-020  
 ZR Models..... 0627-020  
 ZRT 600..... 0627-020

**2003**

Bearcat W/T..... 0627-026  
 Firecat 500/600 Models..... 0627-020  
 Firecat 700 Models..... 0627-020/035\*  
 4-Stroke Touring/Trail  
 Mountain Cat Models..... 0627-013  
 Panthera 550..... 0627-021  
 Panthera Models (EFI)..... 0627-020  
 Panther Models..... 0627-021  
 Z Models..... 0627-021  
 ZL Models..... 0627-020  
 ZR Models..... 0627-020/035\*

**2004**

Bearcat 570..... 0627-013  
 Bearcat W/T..... 0627-033  
 Firecat 500 Models..... 0627-020  
 Firecat 600/700 Models..... 0627-031  
 King Cat..... 0627-020  
 Mountain Cat Models..... 0627-020  
 Panthera 550..... 0627-021  
 Panthera Models (EFI)..... 0627-020  
 Panther Models..... 0627-021  
 Sabercat 500..... 0627-021  
 Sabercat 600/700 Models..... 0627-031  
 T660 Touring..... 0627-021  
 T660 Turbo Models..... 0627-028  
 Z Models..... 0627-021  
 ZR Models..... 0627-032

**2005**

Bearcat 570..... 0627-013  
 Bearcat W/T..... 0627-033  
 Firecat 500 Models..... 0627-034  
 Firecat 600/700 Models..... 0627-034  
 King Cat..... 0627-020  
 M-Series..... 0627-036  
 Panthera 550..... 0627-021  
 Panthera 600 EFI..... 0627-020  
 Panther Models..... 0627-021  
 Sabercat 500..... 0627-020  
 Sabercat 600/700 Models..... 0627-035  
 T660 Touring..... 0627-021  
 T660 Turbo Models..... 0627-028  
 Z Models..... 0627-021  
 ZR 900 Models..... 0627-032

**2006**

Bearcat 570..... 0627-013  
 Bearcat W/T..... 0627-033  
 Bearcat W/T Turbo..... 0627-049  
 Crossfire Models..... 0627-036  
 Firecat 500 Models..... 0627-044  
 Firecat 600 EFI..... 0627-020  
 Firecat 600/700 Models (w/o Reverse) 0627-044  
 Firecat 700 EFI..... 0627-035  
 King Cat Models..... 0627-020  
 M-Series Models..... 0627-036  
 Panther 370/570 Models..... 0627-021  
 Panther 680 Models..... 0627-013  
 Sabercat 500/600 Models..... 0627-020  
 Sabercat 700 Models..... 0627-035  
 T660 Touring..... 0627-013  
 T660 Turbo Models..... 0627-048  
 Z Models..... 0627-021  
 ZR 900 EFI Models..... 0627-045

**2007**

Bearcat 570..... 0627-013  
 Bearcat W/T..... 0627-033  
 Bearcat W/T Turbo..... 0627-049  
 Crossfire 5/6/8..... 0627-046  
 Crossfire 1000..... 0627-060  
 F-Series 5/6/8..... 0627-046  
 F1000..... 0627-060  
 Jaguar Z1..... 0627-047  
 M-Series..... 0627-046

**2007 (Cont.)**

Panther 370/570..... 0627-021  
 Panther 660..... 0627-013  
 T660..... 0627-048  
 Z 370/570..... 0627-021

**2008**

Bearcat 570..... 0627-013  
 Bearcat W/T..... 0627-033  
 Bearcat W/T Turbo..... 0627-049  
 Crossfire 5/6/8..... 0627-046  
 Crossfire 1000..... 0627-060  
 F-Series 5/6/8/570..... 0627-046  
 F1000..... 0627-060  
 Jaguar Z1..... 0627-047  
 M-Series 6/8..... 0627-046  
 M1000..... 0627-060  
 Panther 370..... 0627-021  
 Panther 660..... 0627-013  
 600 Sno Pro..... 0627-066  
 T500/T570..... 0627-046  
 TZ1..... 0627-047

**2009**

Bearcat 570..... 0627-067  
 Bearcat 570 XT..... 0627-046  
 Bearcat Z1 XT..... 0627-047  
 Crossfire 500..... 0627-067  
 Crossfire 6/8/R8..... 0627-046  
 Crossfire 1000/R1000..... 0627-060  
 F5/570..... 0627-067  
 F6/8..... 0627-046  
 F1000 Sno Pro..... 0627-060  
 M6/8/HCR..... 0627-046  
 M1000..... 0627-060  
 T500/570..... 0627-067  
 TZ1..... 0627-047  
 TZ1 Turbo..... 0627-066  
 Z1..... 0627-047  
 Z1 Turbo..... 0627-066  
 600 Sno Pro (Sno Cross)..... 0627-070  
 600 Sno Pro (Cross Country)..... 0627-066

**2010**

Bearcat 570..... 0627-067  
 Bearcat 570 XT..... 0627-046  
 Bearcat Z1 XT..... 0627-047  
 Crossfire 6..... 0627-046  
 Crossfire 8, CFR 8, CFR 1000..... 0627-060  
 F5 LXR/570..... 0627-067  
 F6 Sno Pro/8/8 Sno Pro..... 0627-046  
 M6/8/HCR..... 0627-046  
 M1000..... 0627-060  
 T570..... 0627-067  
 TZ1..... 0627-069  
 TZ1 Turbo/LXR..... 0627-073  
 Z1..... 0627-069  
 Z1 Turbo/EXT/ Sno Pro..... 0627-073  
 Sno Pro 500..... 0627-047  
 Sno Pro 600 (Sno Cross)..... 0627-075  
 Sno Pro 600 (Cross Country)..... 0627-076

**2011**

Bearcat 570/LTD..... 0627-067  
 Bearcat 570 XT..... 0627-046  
 Bearcat Z1 XT/LTD..... 0627-047  
 Crossfire 6..... 0627-046  
 Crossfire 8, CFR 8, CFR 1000..... 0627-060  
 F5 LXR/570..... 0627-067  
 F6 Sno Pro/8 EXT/LXR/  
 8 Sno Pro LTD..... 0627-046  
 M6/8/HCR..... 0627-046  
 M1000 Sno Pro..... 0627-060  
 T570..... 0627-067  
 TZ1/LXR LTD..... 0627-069  
 TZ1 Turbo LXR LTD..... 0627-073  
 Z1 LXR..... 0627-069  
 Z1 Turbo EXT/LXR/Sno Pro..... 0627-073  
 Sno Pro 500..... 0627-047  
 Sno Pro 600 (Sno Cross)..... 0627-075  
 Sno Pro 600 (Cross Country)..... 0627-076

**2012**

BC 570..... 0627-067  
 BC 570 XT..... 0624-046  
 BC Z1 XT..... 0627-047  
 F5 LXR, F570..... 0627-067  
 F 800..... 0627-083  
 F 1100..... 0627-081  
 F 1100 Turbo..... 0627-082  
 M 800..... 0627-083  
 M 1100..... 0627-081  
 M 1100 Turbo..... 0627-082  
 T570..... 0627-067  
 TZ1 Touring..... 0627-069  
 TZ1 Turbo Touring..... 0627-082  
 XF 800..... 0627-083  
 XF 1100..... 0627-081  
 XF 1100 Turbo..... 0627-082  
 Sno Pro 500..... 0627-047

**Dimension Chart**

BELT P/N	LENGTH	WIDTH
0100-088	43.125 ± .188 inch	1.188 inch
0100-092	43.813 ± .188 inch	1.250 inch
0227-011	44.000 ± .188 inch	1.250 inch
0227-014	45.500 ± .188 inch	1.250 inch
0227-016	45.063 ± .188 inch	1.250 inch
0227-019	43.250 ± .188 inch	1.250 inch
0227-020	46.688 ± .188 inch	1.250 inch
0227-030	43.500 ± .188 inch	1.375 inch
0227-100	45.500 ± .188 inch	1.375 inch
0227-103	43.625 ± .125 inch	1.375 inch
*0627-002	43.625 ± .188 inch	1.375 inch
*0627-004	43.625 ± .188 inch	1.375 inch
*0627-006	43.625 ± .188 inch	1.375 inch
*0627-010	47.750 ± .188 inch	1.375 inch
*0627-011	45.750 ± .188 inch	1.375 inch
*0627-012	47.750 ± .188 inch	1.375 inch
0627-013	49.000 ± .188 inch	1.437 inch
0627-014	49.000 ± .188 inch	1.437 inch
*0627-020	48.071 ± .188 inch	1.406 inch
*0627-021	47.750 ± .188 inch	1.385 inch
*0627-031	47.750 ± .178 inch	1.382 inch
*0627-032	44.570 ± .178 inch	1.448 inch

BELT P/N	LENGTH	WIDTH
*0627-033	50.285 ± .188 inch	1.437 inch
*0627-034	44.024 ± .178 inch	1.448 inch
*0627-035	47.750 ± .178 inch	1.400 inch
*0627-036	45.024 ± .178 inch	1.448 inch
*0627-044	44.706 ± .178 inch	1.448 inch
*0627-045	45.223 ± .178 inch	1.448 inch
*0627-046	45.998 ± .178 inch	1.448 inch
*0627-047	43.547 ± .178 inch	1.448 inch
*0627-048	46.986 ± .178 inch	1.448 inch
*0627-049	48.162 ± .178 inch	1.448 inch
*0627-059	48.162 ± .178 inch	1.448 inch
**0627-060	45.998 ± .178 inch	1.448 inch
*0627-067	45.394 ± .178 inch	1.406 inch
*0627-069	42.953 ± .178 inch	1.406 inch
*0627-070	44.250 ± .178 inch	1.448 inch
***0627-073	43.547 ± .178 inch	1.448 inch
**0627-075	44.250 ± .178 inch	1.448 inch
**0627-076	43.547 ± .178 inch	1.448 inch
*0627-081	46.378 ± .178 inch	1.448 inch
***0627-082	46.259 ± .178 inch	1.448 inch
**0627-083	47.519 ± .178 inch	1.448 inch
***0627-085	48.149 ± .178 inch	1.448 inch

\*High Performance \*\*Improved Compression Resistance; Improved Heat Resistance \*\*\*Best Compression Resistance; Best Heat Resistance

■NOTE: The difference between a \* drive belt and a \*\* drive belt of the same dimension is hardness. A \*\* drive belt is more flexible and if used in place of a \* drive belt, the engine will run at a lower RPM.

## Index

■NOTE: Bolded Items are not found in the CAtalog.

<b>#</b>	
120	46

<b>A</b>	
A-ARM KIT, 38"	40
ACCESSORY ADAPTER	64
<b>AIRBOX KIT, SPLIT</b>	<b>66</b>
ALTITUDE KITS, HIGH	74
ANTIFREEZE	58
AVALANCHE AIRBAG	36
AVALANCHE BEACONS	36
AVALANCHE PROBE	37
AXLE KIT, LIGHTWEIGHT FRONT	39

<b>B</b>	
BAGS	
Backpack	37
Dimensions	11
Foam Beverage Holder	19
Gear	16,41,34
Handlebar	17,34
Heater	17
Liner	35
Mountain Pack	34
Saddlebags	16,18
Seat Pack	18
Tank	18
Trunk, Firecat	19
Tunnel Pack	16,41,34
Underhood	18
Windshield	16,19,35
Replacement Hardware	19
BATTERY CHARGERS/MAINTAINERS	64
BELTS, DRIVE	66
Application Guide	76
Dimension Chart	77
Holder	64
BILLET ACCESSORIES	27-28, 35
BODY PANELS, VENTED	37-38
BUMPER	20,42

<b>C</b>	
CAM ROLLER, HI-TEMP	39
CARGO SLEDS	43-44
CHOKE LEVER REPAIR KIT	68
CLEANERS	59,60
COVERS	
Arctic Cat Canvas Covers	14
Custom	15
Dust	15
Headlight	32
Premium	14
Team Arctic	14
Undercover Liner	15
Replacement Straps	15

<b>D</b>	
DC POWER KIT	22
<b>DRIVE CLUTCH SPRING</b>	<b>68</b>
DOLLY	
Cat Caddy	61
Shop	62

<b>E</b>	
ELECTRIC START KIT	22
ENGINE HEATER	22

<b>F</b>	
FLOAT CONVERSION	40
FLUID	
ACT Gearcase	57
Fox Float	59
Flush	57
FUEL	
High Octane Race	59
De-Icer	58
Injection & Carburetor Cleaner	58
Stabilizer	58
FUEL PUMP REPAIR KITS	67

<b>G</b>	
GASKET SETS	68
GAUGE, TEMPERATURE	65
GOGGLE HOLDER	35
GREASE	59
<b>GRAPHIC KITS</b>	<b>26</b>
GRIP PLATES	30

<b>H</b>	
HANDLEBAR	
Grip Adhesive	67
Grips	29
Heavy-Duty	67
Muffs	17
Risers	38, 65
Stand	61
Steering Post	61
HAND GUARD MOUNTS	28
HAND GUARDS	28
HAND WARMER KIT	46
HAND WARMERS, PASSENGER	44
HEATED SEAT KIT	22
HEATED SHIELD ADAPTER	63
HELMET PARTS	69-73
HITCH KITS	21,22,42
HOOD LATCH REPAIR KIT	65
HORN KIT	66

<b>I</b>	
ICE SCRATCHERS	37

<b>L</b>	
LIFT	
Sled	61
Front End	61
LIGHT	
Backup	44
Bar	42
Strobe	42
LOCTITE	67
LUBE	
Transmission	57
Chain	57

<b>M</b>	
MIRRORS	32
<b>Hood-Mounted</b>	<b>32</b>

<b>O</b>	
OIL	
Engine	56
Shock	57-58
OVERLOAD SPRING TOOL	68

<b>P</b>	
PAINT	63
PINK ACCESSORY KITS	26

<b>R</b>	
RACK	
Billet	35
Cargo	41
Sport	21
Crossfire	21
Procross	21
Proclimb	35
Touring	21
Mat/Pad	44,39
M Series	35
Strap	36
RADIATOR KIT	45
RAIL BRACE KIT	67
REAR SUSPENSION, FLOAT CONVERSION	40
RECOIL HANDLE	27,33
REMOTE START KIT	23
HANDLEBAR GRIPS	29

<b>S</b>	
SAW, POCKET	37
SEALANT	67-68
SEAT COVER, GRIPPER	30
SEAT KIT, 2-UP	20
SEAT KIT, PASSENGER	45
SEAT, MOUNTAIN	36
SEAT, THIRD	41
SHOCKS	
FOX Float	26-27
Airshox Guards	27
Airshox Pump	27
Rebuild Kits	68
SHOVELS	37
SIDE RAILS	41
SKI	
Handles	29
Plastic	29-30
Skins	44
SKID PLATES	30
SNOBUNJE	39
SNOWFLAPS	31,33,55
SNOW MESH	31,41
SNOW PLOW	
Blades	43
Push Frame	43
SPARK PLUGS	66
Caddy	65
Caps	67
SPRING CHART, OPTIONAL	74-75
SPRING KIT, OVERLOAD	45
STAND, JACK	61
STEERING POST, TELESCOPIC	38
STUD ACCESSORIES	51-55
SWAY BAR KITS	44
SWITCH GUARDS	38

<b>T</b>	
TANK	
Grips	35
Jacket	35
Pads	34
TAPE	63
TETHER SWITCH	22
TIE-DOWNS	62
TOE HOLD	33
TOOL ROLL	62
TOW ROPE	62
TRACK KIT, LONG	40
TRACKS	47,48
TRACK CLIP TOOL	68
TRAIL GROOMER	45
TUNNEL FLARES	40
TUNNEL GRIPS	30
TUNNEL PROTECTOR KIT	55
TUNNEL RAILS	20

<b>W</b>	
WEARBARS	49-50
WEAR STRIPS	32
WHEELS, IDLER	33
WHEEL KITS	40,46,65
WINCH KIT, WARN	42,43
WINDSHIELDS/WINDSCREENS	24
WINDSHIELD MOUNTING RING	25
WINDSHIELD HARDWARE	25