



[DOWNLOAD MANUAL HERE](#)

www.CrossCreekTractor.com

Call Us: 1 (800) 462-7335

AFTERMARKET TRACTOR PARTS FOR

CASE - IH

**ALL PARTS LISTED ARE AFTERMARKET REPLACEMENT PARTS AND ARE NOT
PRODUCED BY THE ORIGINAL EQUIPMENT MANUFACTURER**



[DOWNLOAD MANUAL HERE](#)

Tractor Parts

Call Us: 1 (800) 462-7335

Cooling	268
Electrical.....	271
Engine, Crankshafts	259
Engine, Misc.....	260
Engine, Overhaul Kits	252
Fuel	264
Hydraulic, Control Valve Parts	283
Hydraulic, Hitch	284
Hydraulic, Hydraulic Pumps.....	282
Mufflers.....	263
Rear Axle & Brakes.....	281
Sheet Metal	286
Steering, Control Valves.....	273
Steering, Misc.....	277
Steering, P/S Cylinders.....	275
Steering, P/S Cylinder Parts	275
Steering, Sectors	274
Steering, Tie Rod Ends	276
Transmission & PTO.....	278
Wheels & Rims	287



[DOWNLOAD MANUAL HERE](#)

Tractor Parts

Call Us: 1 (800) 462-7335

**IH B-275, B414, 424, 444, 354, 365, 384, 3414, 2424, 2444, 238, 500, TD5
BD144/BD154 Diesel Engine**

EOKIHBD154A

Engine Overhaul Kit
Contains Sleeves, Pistons,
Rings, Sleeve Seals,
Piston Pin Bushings,
Complete Gasket Set,
Front and Rear Crankshaft Seals

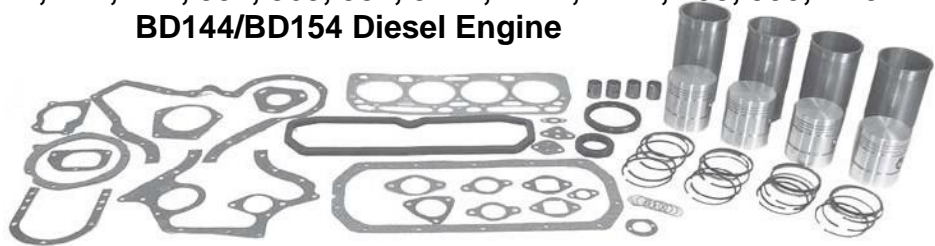

(Order Bearings Separately)

Order Individual Parts Below

3044486R3

Piston w/ Pin



3044487R93

Piston Ring Set (1 Per Piston)

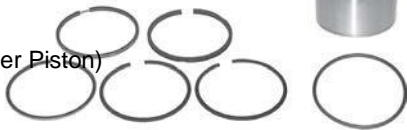

3044481R3

Sleeve

704100R1

Sleeve O-Ring



3070546R91

Rod Bearing Set Std

3070546R91.010

Rod Bearing Set .010

3070546R91.020

Rod Bearing Set .020

3070546R91.030

Rod Bearing Set .030



708912R91

Main Bearing Set Std

708912R91.010

Main Bearing Set .010

708912R91.020

Main Bearing Set .020

708912R91.030

1082164R91

Complete Gasket Set

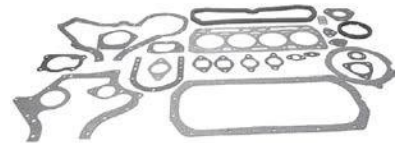

703883R6

Head Gasket



703840R1

Oil Pan Gasket



Main Bearing Set .030



703844R91

Front Crankshaft Seal

3072092R91

Replaces

708903R91

Rear Crankshaft Seal

1082175R91

Cam Bearing Set

3043611R1

Connecting Rod

Bushing

3064060R91

Oil Pump w/ Tach

Drive



[DOWNLOAD MANUAL HERE](#)

Tractor Parts

Call Us: 1 (800) 462-7335

**IH 385, 395, 500C
D155 3 Cylinder Diesel Engine**

EOKiHD155A

Engine Overhaul Kit
Contains Sleeves, Pistons,
Rings, Sleeve Seals,
Piston Pin Bushings,
Complete Gasket Set,
Front and Rear
Crankshaft Seals



(Order Bearings Separately)

Order Individual Parts Below

3139586R95

Piston and Sleeve Set



3136798R98

Head Gasket Set

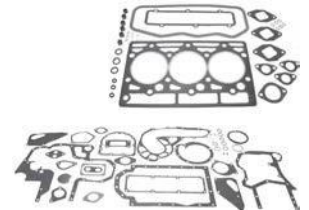

3055351-3

Rod Bearing Set Std



3136802R98

Oil Pan Gasket Set



3056834-3

Rod Bearing Set .010

3056879-3

Rod Bearing Set .020

Oil Pump



3055130-3

Main Bearing Set Std



3056832-3

Main Bearing Set .010

3056877-3

Main Bearing Set .020



3132018R2

Piston Pin Bushing



3136429R95

3228401R91
Front Crankshaft Seal

3138701R91
Rear Crankshaft Seal

3055008R2

F
r
o
n
t

C
a
m

B
e
a
r
i
n
g

(
O
n
e

r
e
q
u
i
r
e
d
)

1806820C1

C
a
m

B
e
a
r
i
n
g

(
T
h
r
e
e

r
e
q
u
i
r
e

ed)

3055055R2
intake Valve

3055056R2
Exhaust Valve

3055022R1
Valve Guide



Case / IH

Engine, Overhaul Kits

**IH 454, 464, 484, 485, 495, 3220, 380B, 2400, 2400A, 3400
D179 3 Cylinder Diesel Engine**

EOKiHD179A

Engine Overhaul Kit
Contains Sleeves, Pistons,
Rings, Sleeve Seals,
Piston Pin Bushings,
Complete Gasket Set,
Front and Rear
Crankshaft Seals



(Order Bearings Separately)

Order Individual Parts Below

3218759R95
Piston and Sleeve Set



3136798R98
Head Gasket Set

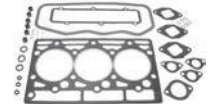

3055351-3
Rod Bearing Set Std



3136802R98
Oil Pan Gasket Set

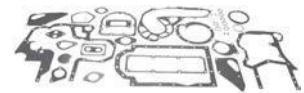

3056834-3
Rod Bearing Set .010



3228401R91
Front Crankshaft Seal



3056879-3
Rod Bearing Set .020



3138701R91
Rear Crankshaft Seal



3055130-3
Main Bearing Set Std



3055008R2
Cam Bearing, Front
(One required)



3056832-3
Main Bearing Set .010



1806820C1
Cam Bearing, Rear
(Three required)



3056877-3
Main Bearing Set .020



3055055R2
intake Valve



3132018R2
Piston Pin Bushing



3055056R2
Exhaust Valve



3136429R95
Oil Pump



3055022R1
Valve Guide





Engine, Overhaul Kits

Case / IH

**IH 584, 585, 3230, 100C, TD7C
D206 4 Cylinder Diesel Engine**

EOKiHD206A

Engine Overhaul Kit
Contains Sleeves, Pistons,
Rings, Sleeve Seals,
Piston Pin Bushings,
Complete Gasket Set,
Front and Rear
Crankshaft Seals

(Order Bearings Separately)



Order Individual Parts Below

3139586R95

Piston and Sleeve Set



3136799R99

Head Gasket Set

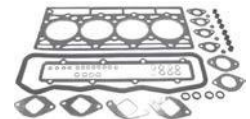

3055351-4

Rod Bearing Set Std



3228431R91

Oil Pan Gasket Set



3056834-4

Rod Bearing Set .010

3228401R91

Front Crankshaft Seal



3056879-4

Rod Bearing Set .020

3138701R91

Rear Crankshaft Seal



3055130-4

Main Bearing Set Std



3055008R2

Cam Bearing, Front
(One required)



3056832-4

Main Bearing Set .010

1806820C1

Cam Bearing, Rear
(Four required)



3056877-4

Main Bearing Set .020

3132018R2

Piston Pin Bushing



3055055R2

intake Valve



3136430R95

Oil Pump



3055056R2

Exhaust Valve



3055022R1

Valve Guide





Case / IH

Engine, Overhaul Kits

IH 574, 674, 684, H84, 685, 695, 4210, 250A, 2500, 2500A, 2500B, 3500, 3600, TD7E, TD8, 125C D239 4 Cylinder Diesel Engine

EOKiHD239A

Engine Overhaul Kit
 Contains Sleeve, Pistons,
 Rings, Sleeve Seals,
 Piston Pin Bushings,
 Complete Gasket Set,
 Front and Rear
 Crankshaft Seals

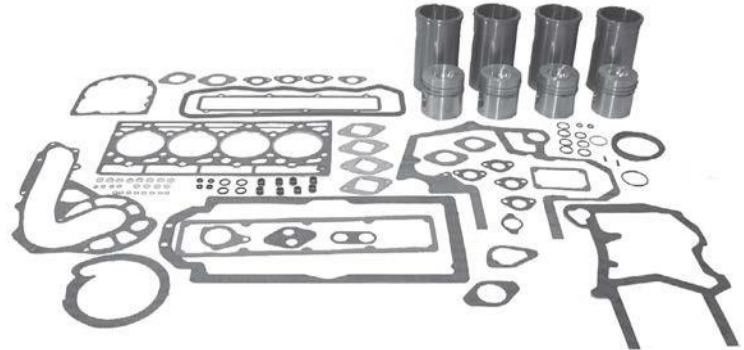

(Order Bearings Separately)

Order Individual Parts Below

3218759R95

Piston and Sleeve Set



3055351-4

Rod Bearing Set Std



3056834-4

Rod Bearing Set .010

3056879-4

Rod Bearing Set .020

3055130-4

Main Bearing Set Std



3056832-4

Main Bearing Set .010

3056877-4

Main Bearing Set .020

3132018R2

Piston Pin Bushing



3136430R95

Oil Pump

3136799R99

Head Gasket Set

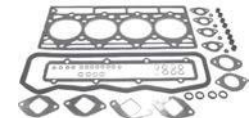

3228431R91

Oil Pan Gasket Set



3228401R91

Front Crankshaft Seal



3138701R91

Rear Crankshaft Seal

3055008R2

Cam Bearing, Front
 (One required)



1806820C1

Cam Bearing, Rear
 (Four required)



3055055R2

Intake Valve



3055056R2

Exhaust Valve

3055022R1

Valve Guide



Engine, Overhaul Kits

Case / IH

**IH 686, 706, 756, 2706, 2756, HYDRO 86
D310 6 Cylinder Diesel Engine**

EOKiHD310A

Engine Overhaul Kit
Contains Sleeves, Pistons,
Rings, Sleeve Seals,
Piston Pin Bushings,
Complete Gasket Set,
Front and Rear
Crankshaft Seals



(Order Bearings Separately)

Order Individual Parts Below

3139586R95

Piston and Sleeve Set



3136801R99

Complete Gasket Set



3055351-6

Rod Bearing Set Std



3228401R91

Front Crankshaft Seal



3056834-6

Rod Bearing Set .010

3138701R91

Rear Crankshaft Seal



3056879-6

Rod Bearing Set .020

3055008R2

Cam Bearing, Front
(One required)



3055130-6

Main Bearing Set Std

1806820C1

Cam Bearing, Rear
(Order as required)



3056832-6

Main Bearing Set .010



3056877-6

Main Bearing Set .020

3132018R2

Piston Pin Bushing



3055055R2

intake Valve

3055056R2

Exhaust Valve



3136433R95

Oil Pump
For Tractors with internal Oil Pump



3055022R1

Valve Guide



Case / IH

Engine, Overhaul Kits

**IH 786, 826, 886, 2826, 3088, 3288 D358
6 Cylinder Diesel Engine**

EOKiHD358A

Engine Overhaul Kit
Contains Sleeves, Pistons,
Rings, Sleeve Seals,
Piston Pin Bushings,
Complete Gasket Set,
Front and Rear
Crankshaft Seals



(Order Bearings Separately)

Order Individual Parts Below

3218759R95
Piston and Sleeve Set



3136801R99
Complete Gasket Set

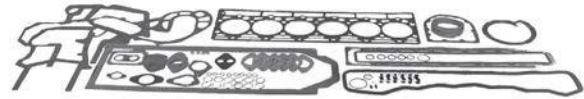

3055351-6
Rod Bearing Set Std



3228401R91
Front Crankshaft Seal



3056834-6
Rod Bearing Set .010

3056879-6
Rod Bearing Set .020

3138701R91
Rear Crankshaft Seal



3055130-6
Main Bearing Set Std

3056832-6
Main Bearing Set .010

3056877-6
Main Bearing Set .020



3055008R2
Cam Bearing, Front
(One required)



1806820C1
Cam Bearing, Rear
(Order as required)



3132018R2
Piston Pin Bushing



3055055R2
intake Valve

3055056R2
Exhaust Valve

3055022R1
Valve Guide





Engine, Crankshafts

Case / IH

CRANKSHAFT04

Replaces 751303R1, 3110995R91
Crankshaft iH BD144 BD154



Fits iH B275, B414, 424, 434, 444, 354, 364, 384, 3414, 2424, 2444, TD5, Early 500

CRANKSHAFT25

Replaces A144011
Crankshaft Case 207 Non-Turbo



Fits 580, 580B, 580C, 580D

CRANKSHAFT05

Replaces 3144626R1
Crankshaft iH D239, DT239, D246
With Center Balancer Gear



Fits iH 574, 674, 684, 685, 695, 784, 250A, 2500, 3500, 4500, TD7, TD8, 125 Crawler

CRANKSHAFT27

Replaces A39146, A151015, A39151
Crankshaft Case 188
With Splined Pilot Hole



Fits 430, 530, 470, 570, 580, 580B, 480, 480B, 480C, 310, 350, 450

CRANKSHAFT06

Replaces 3132968R93
Crankshaft iH D206
With Center Balancer Gear



Fits iH 584, 585, 595, TD7C

CRANKSHAFT26

Replaces G11889, A39150, A39151
Crankshaft Case 188
With Smooth Pilot Hole



Fits 430, 530, 470, 570, 580, 580B, 480, 480B, 480C, 310, 350, 450

CRANKSHAFT13

Replaces 3228376R91
Crankshaft iH D268
With Center Balancer Gear



Fits 884, 885, 895, 510 Wheel Loader

CRANKSHAFT34

Replaces G11700, G11164, G10071, G11701
Crankshaft Case G148



Fits 300, 300B 320, 400B, 310



Case / IH

Engine, Crankshaft & Misc

CRANKSHAFT44

Replaces 966772, A22578, A58889, A58787, A166001, A42802

Crankshaft Case 251, 267, 301, 336
Small Journal, Rod Journals 2.750 Main Journals 3.00



Fits 730, 830, 770, 870, 680B, 680C, 680D, 680E, 680G, 680H, 850, 850B, W7, W14

CRANKSHAFT50

Replaces A65109

Crankshaft Case 336
Large Journal Rod Journals 2.999 Main Journals 3.499



Fits 780, 880, 880B

A153521

Replaces A39013, A36853

Camshaft 188, 207



G47077

Lifter 188, 207



Fits 430, 530, 470, 570, 580CK, 580B, 580C, 580D

16040DD

Lifter

D361, DT361, D407, DT407



Fits 806, 1026, 1206, 856, 1256, 1456

3055028R1

Crankshaft Gear

33 Teeth for D155, D179, D206, D239, D246, D268 Engines



Fits 454, 574, 674, 484, 584, 684, 784, 884, 385, 485, 585, 685, 785, 885, 495, 595, 695, 895, 2400, 2500, 3400, 3500, 3600, 250A, 260A, 270A, TD7, TD8, TD9

3136237R1

Crankshaft Balancer Gear

80 Teeth
for D206, D239, D246 Engines



Fits 574, 674, 584, 684, 784, 884, 485, 585, 685, 785, 595, 695, 2400, 2500, 3400, 3500, 3600, 250A, 260A, TD7, TD8, TD9

3132874R93

Balancer

For D206, D239, D246 Engines



Fits 574, 674, 684, 685, 695, 584, 585, 595, 250A, 2500, 3500, 4500, TD7, TD8

1967032C1

Replaces 3055030R24

Connecting Rod

For D-179, D-239, D-246 Engines



Fits 454, 464, 574, 674, 484, 684, 784, 884, 485, 585, 685, 785, 885, 495, 595, 695, 895, 2400, 2500, 3400, 3500, 3600, 250A, 260A

Engine, Misc

Case / IH

3043824R1

Replaces 703872R98
Cylinder Head w/ Valves
For BD144, BD154 Engine



Fits iH B275, B414, 424, 434, 444, 354, 364, 384, 3414, 2424, 2444, TD5, Early 500

BD154VALVESET

Valve kit
(Contains intake and Exhaust Valves, Springs, Cups, and Keepers)



Fits iH B275, B414, 424, 434, 444, 354, 364, 384, 3414, 2424, 2444, TD5, Early 500

3040912R91

Replaces 3447288R31
Cylinder Block
For BD154 Engine



Fits iH B275, B414, 424, 434, 444, 354, 364, 384, 3414, 2424, 2444, TD5, Early 500

3064086R91

Replaces 3063934R3, 709450R1
Camshaft



New style camshaft with 1.312 inch keyed end for cam gear. if replacing camshaft with smaller keyed end, also order 3064085R91 Cam Gear Below

3064085R1

Camshaft Gear



SHORTBLOCK04

Short Block Assy
For BD154 Engine



Fits iH B275, B414, 424, 434, 444, 354, 364, 384, 3414, 2424, 2444, TD5, Early 500

704782R1

Valve Lifter



3061215R1

Replaces 3061214R91
Connecting Rod



Fits iH B275, B414, 424, 434, 444, 354, 364, 384, 3414, 2424, 2444, TD5, Early 500

43249D

Camshaft Retaining Plate



703865R1

Crankshaft Gear



Fits iH B275, B414, 424, 434, 444, 354, 364, 384, 3414, 2424, 2444, TD5, Early 500

Case / IH

Engine, Misc

375712R1

Replaces 6779DB
Camshaft Gear
For C113, C123,
C135, C146, C153
Gasoline Engines



Fits A, B, C, Super A, B, C, 100, 130, 230, 140, 240, 340,
404, 504, 424

3064063R11

Oil Pan, Deep Style
BD144, BD154



Fits iH B275, B414, 424, 434, 444, 354, 364, 384, 3414,
2424, 2444, TD5, Early 500

3064060R91

Oil Pump w/ Tach Drive
BD144, BD154



Fits iH B275, B414, 424, 434, 444, 354, 364, 384, 3414,
2424, 2444, TD5, Early 500

359875R1

Oil Pan Drain Plug



3405H

Oil Pan Drain Plug Gasket



Fits iH B275, B414, 424, 434, 444, 354, 364, 384, 3414,
2424, 2444, TD5, Early 500

3042420R92

Oil Filter Base
With Canister
BD144, BD154



Fits iH B275, B414, 424, 434, 444, 354, 364, 384, 3414,
2424, 2444, TD5, Early 500

3045354R11

Replaces 3042719R11
Exhaust Manifold
BD144, BD154



704165R2

Replaces 704165R1
Exhaust Manifold Gasket
BD144, BD154



Fits iH B275, B414, 424, 434, 444, 354, 364, 384, 3414,
2424, 2444, TD5, Early 500

FILTERKIT01

Spin On Oil Filter Adapter Kit



Fits B275, B414, 424, 444, 354, 364, 384, 3414, 2424,
2444



Engine, Misc

Case / IH

3043830R1

Oil Pump Gear
For BC144 Gasoline Engine



Fits B414, 354 Gas

A182084

Exhaust Manifold



Fits 430, 530, 470, 570, 480, 480B, 480C, 480D, 480LL,
580, 580B, 580C, 580D, 584C, 585C, 586C, 584D, 585D,
586D, 350, 350B, 450, 450B, 455B, DH5, W11

3109792R92

Muffler



Fits B275, B414, 424, 444, 354, 364, 384

529372R1

Muffler



Fits 454, 464, 574, 674

83027C1

Muffler



Fits 484, 584, 684, 784, 884, 385, 485, 585, 685, 785XL,
885

251175R21

Manifold



Fits A, B, C, Super A, Super C, 100, 120, 200, 230, 240
All with C113 & C123 Gas Engines



Case / IH

Fuel

3040870R94

CAV injector



708314R1

Precombustion Chamber Holder



710382R3

Pre Combustion Chamber Upper Gasket
Fits Between Pre Combustion Chamber
and Pre Combustion Chamber Holder



3045523R1

Precombustion Chamber



710383R1

Pre Combustion Chamber Upper Gasket
Fits Between Pre Combustion Chamber
and Pre Combustion Chamber Holder



Fits iH B275, B414, 424, 434, 444, 354, 364, 384, 3414,
2424, 2444, TD5, Early 500

708294R93

Fuel Pump
For CAV injection System



Fits B275, B414, 424, 444, 354, 364, 384, 3414, 2424,
2444

iNJPUMP31

Replaces 3044494R92, 3240F538
3040869R92
injection Pump iH BD154
CAV Type



Fits B-414, 424, 444, 354, 364, 384, 3414, 2424, 2444
TD5, Early 500

iNjLiNESET01

injector Line Set
All 4 injector Lines
For CAV inline
injection Pump

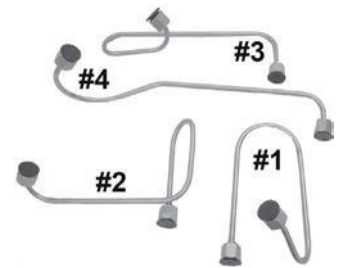

Fits B275, B414

708307R21

injector Line #1



708308R21

injector Line #2



708309R21

injector Line #3



708310R21

injector Line #4



For Rotary CAV injection System
Fits B414, 424, 444, 354, 364, 384, 3414, 2424, 2444



Fuel

Case / IH

7135-110

Injection Pump Repair Kit

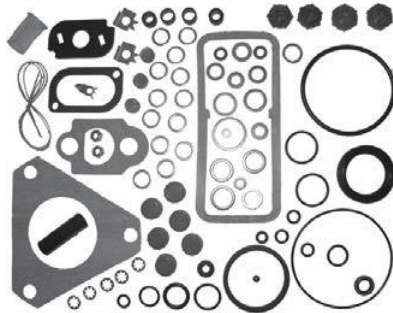

For Most CAV pumps

61782C91

Sediment Bowl



Fits CUB, CUB LO-BOY, A, B, SUPER A, AV, A1, AV1, C, SUPER C, 100, 130, 140, 340, 404, 454, 460, 464, 504, 574, 606, 656, 674, 2400A, 2500A, 2404, 2504, 2606, 2656

380426S

Sealing Washer
For Top Cover



FITS MOST LUCAS/CAV INJECTION PUMPS

568-010

O-RING
For Top Cover Lever Shafts



FITS MOST LUCAS/CAV INJECTION PUMPS

5393-252U

Seal
For CAV injection Pump
Drive Hub



FITS MOST LUCAS/CAV INJECTION PUMPS

370832R91

Fuel Sediment Bowl



Fits H, HV, M, OS4, O4, SUPER M, SUPER MTA, W4, 460, 560, 600, 650, 656, 660, 706, 756, 766, 806, 826, 856, 2656, 2706, 2756, 2826, 2856

Case / IH

Fuel

BK18

Carburetor Kit
For 251234R94 and
364579R91 Carburetors



Fits Cub, Cub Lo-Boy

K2112

Carburetor Kit
For 12115, 12122,
12225, 12285 and
13781 Carburetors



Fits 130, 230, 240, 330, 340, CUB

BK9V

Carburetor Kit
For 9752, 10514A, 52499D,
352376RR2 Carburetors



Fits A, AV, B, Super A

BK318

Carburetor Kit



Fits 454, 464, 574, 674, 2400A, 2400B, 2500A, 2500B

BK200V

Carburetor Kit
For Carter Carburetors



Fits C, Super A, Super C

251293R1

Replaces 251234R94
Float



Fits Cub, Cub Lo-Boy

C509BV

Carburetor Kit
For Zenith 11115 and IH
355485R91 Carburetors



Fits Super A and Super C

69919D

Float
For Small Marvel
Schebler Carburetors



Fits 200, 230, 240, 330, 340

BK311

Carburetor Kit
For Marvel Schebler TSX744
and TSX748 Carburetors



Fits 200, 230, 240, 330, 340

381962R1

Float
For Large Marvel
Schebler Carburetors



Fits 454, 464, 574, 674, 2400A, 2400B, 2500A, 2500B



Fuel

Case / IH

13794

Replaces 63349C91,
405004R91, 13781
Carburetor



Fits Cub, Cub LoBoy, Cub LoBoy 154 and 184

14996

Replaces TSX857, TSX925, TSX925SL,
TSX927, TSX933, TSX934, TSX934SL, TSX939,
TSX940, TSX940SL, TSX942, TSX943, TSX946,
TSX955, TSX959, TSX959SL, TSX961
TSX961SL, TSX974SL, TSX960, TSX964SL,
TSX965SL, TSX798, TSX799, TSX854
Carburetor



Fits iH and Farmall 504, 454, 464, 574, 674, 656, 544,
666, 686, 2400A, 2400B, 2500A, 2500B, 3400A, 3500A
CASE 540, 541, 600, 640, 641

14007

Replaces TSX175
Carburetor



Fits A, B, C, Super A, Super C

14997

Replaces TSX974, TSX975,
TSX975SL, TSX980SL,
TSX782, TSX785, TSX863
Carburetor



Fits iH AND Farmall 574, 674, 666, 686, 2500, 3500A.
CASE 700, 740, 840

12566

Replaces TSX165, TSX157, TSX171, TSX198,
TSX319, TSX333, TSX347, TSX348, TSX730,
TSX744, TSX748, TSX827, TSX926, TSX896,
TSX896SL, TSX930, TSX946, TSX949, TSX42,
TSX43, TSX74, TSX114, TSX212, TSX253,
TSX474, TSX513, TSX668, TSX695, TSX409,
TSX597, TSX635, TSX663, TSX681, TSX710,
TSX762, TSX804, TSX936, TSX936SL, TSX937,
TSX937SL, TSX957SL

Carburetor



Fits iH and Farmall A, B, C, Super A, Super C, 100, 130,
140, 200, 230, 240, 330, 340, 404, 424, 444, T340 Crawler,
TD5 Crawler, 500 Crawler, CASE VA, VAB, VAC, 200B,
210, 300, 300B, 310, 320, 440, 480, 500, 600

3045515R92

Carburetor

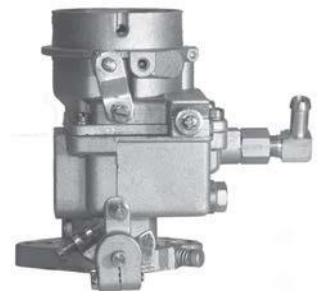

Fits B275, B414, 354



Case / IH

Air Cleaner & Cooling

73186

Pre-Cleaner Bowl
7 1/4 inch Diameter

Fits All Models



A42467

Pre-Cleaner Bowl
10 1/2 inch Diameter

Fits All Models

PC7-2.25

Pre-Cleaner Assembly
7 inch Bowl, 2.25 inch Mount



PC10-3

Pre-Cleaner Assembly
10 inch Bowl, 3 inch Mount



PC10-3.5

Pre-Cleaner Assembly
10 inch Bowl, 3.5 inch Mount

PC10-4

Pre-Cleaner Assembly
10 inch Bowl, 4 inch Mount

PC10-4.5

Pre-Cleaner Assembly
10 inch Bowl, 4.5 inch Mount

NR1259

Fuel Tank Liner Kit



Fits Most Gas and Diesel Fuel Tanks

A146584

Water Pump



Fits 530, 570, 630, 1835, 1845, 1845B, 1845S, 3330B, 350B, 450B, 455B, 586D, 584D, 585D all dsl, 450 W/207 eng, 580D w/ 207 eng, also Super D

703820R94

Water Pump



Fits B275, B414, 424, 444, 354,364, 384, 3414, 2424, 2444

3132676R93

Water Pump



Fits 686, 706, 756, 70, 86, w/ D310 Engine, 786 w/ D358 Engine, 826, 3088, 3288, 886 all w/ D358 Engine

3136053R92

Water Pump



Fits, 385, 395, 484, 485, 495, 574, 584, 585, 595, 674, 684, 685, 695, 784, H84, 3500A, 380B, all with D/DT239 4 Cylinder, D179 3 Cylinder Diesel Engines

1273085C91

Water Pump



Fits iH 244, 254, MiTS 370, 370D & SATOH BEAVER



Cooling

Case / IH

351878R93

Radiator
Core Dimensions: 13 3/4" X 11 3/4"



Fits Cub, Cub Lo-Boy

RADIATOR01

Replaces 3041403R91,
3041405R91, 3044008R91
Radiator



Fits B-275, B-414 (Will also Fit 424, 444, 354, 364, 384 Diesel Tractors with Modification)

58124DBX

Radiator
Core Dimensions: 15 7/8" X 16"



Fits A, B, BN, SUPER A, SUPER A1, SUPER AV, SUPER AV1

84524C93

Replaces 3121412R91,
3121413R91, 3121414R92
Radiator
Core Dimensions: 18.5" x 19"
Neck Height: 5 1/16"



Fits 380B, 484, 485, 574, 584, 684, 784, Hydro 84, (585, 685, 885, W/O Air Conditioning)

356356R94

Replaces 356356R96
Radiator
Core Dimensions: 16" X 16"



Fits A1, AV, AV1, SUPER A, SUPER C, 100, 130, 200, 230

1536373C1

Radiator
Core Dimensions: 18 1/4" X 18"



Fits 395, 495, 595, 695, 895, 995 ALL 2WD Without AC

369400R94

Radiator
Core Dimensions: 16" X 16 3/4"



Fits 140

71611C1

Radiator
Core Dimensions: 24" X 22 1/8"
Filler Neck 4 1/2"



Fits 766, 886, 966, 986, 1066, 1086, 1466, 1486, 1566, 1586, HYDRO 100, HYDRO 186

Case / IH

Cooling

84673C6

Radiator



Fits 585, 595, 685, 695, 885, 895 With Air Conditioning

D89103

Radiator



Fits 580C

A39344

Radiator



Fits 430CK, 480B, 480CK, 530CK GAS / DSL STD, 580B SN <-8685801 STD, WITH MECHANICAL SHUTTLE / HYDRAULIC

A39345

Radiator



Fits 530CK GAS WITH TORQUE CONVERTOR DSL WITH CASE O MATIC, 580B GAS & DIESEL WITH POWER SHUTTLE, 580CK SN <-8685801 POWER SHUTTLE, 580B DSL

Electrical

Case / IH

1109611

Replaces 1109603,
1109613
Starter



Fits Cub, Cub Lo-Boy

593292C1

Replaces 1925781
Starter Switch



Fits CUB, CUB LO BOY, A, B, C, H, M, SUPER A, SUPER AV, SUPER C, SUPER H, SUPER HV, SUPER M, SUPER MV, 100, 130, 140, 200, 230, 240

104221A2R

Replaces 355794R91
Starter



Fits A, B, C, Super A, Super C, 200, 230

107296C91

Distributor
Replaces 107304C91,
353890R91, 354900R91,
357935R91



Fits CUB, CUB LO BOY, A, B, C, H, M, SUPER A, SUPER AV, SUPER C, SUPER H, SUPER HV, SUPER M, SUPER MV, 100, 130, 140, 200, 230, 240, 330, 340, 404, 424, 444, 504

104219A2R

Replaces 63608D
Starter



Fits H & M

704447R95

Starter



Fits B275, B414, 424, 444, 354, 364, 384, 2300, 3414, 2424, 3444

396546R93

Coil



Fits 6 volt systems with or without external resistance, 12 volt systems with external resistance.

189330A5

Replaces 3125850R91,
537140R95, 403300R91,
121449A1, 189300A3
Starter



Fits 484, 584, 684, 784, 884, 385, 485, 585, 685, 785, 885, 395, 495, 595, 695, 895, 995, 3220, 3230, 4210, 4230

706685R92

Resistor indicator Assy



710348R2

Glow Plug



Fits iH B275, B414, 424, 434, 444, 354, 364, 384, 3414, 2424, 2444, TD5, Early 500

Case / IH

Electrical

TUKiH01

Tune Up Kit



Contains ignition Kit, Spark Plugs, Plug Wires, and Distributor Cap For individual Parts Order Below



ATK5BiR

ignition Kit With Rotor



AL386

Spark Plug



SWS259

Spark Plug Wire Set



351693R92

Distributor Cap



Fits 4 Cylinder Gas Engines With Battery ignition 1951 thru 1962 With iH Distributor. (Not For Prestolite)

A0NN10670A

Amp Gauge Chrome
Replaces **FAD10850A**
360053R91, 378424R91,
393334R91, 208302



Fits Universal Gauge

9N9273A

Oil Pressure Gauge



Fits Universal Gauge

TUKiH02

Tune Up Kit



Contains ignition Kit, Spark Plugs, Plug Wires, and Distributor Cap For individual Parts Order Below



ATK9BiR

ignition Kit With Rotor



AL386

Spark Plug



SWS259

Spark Plug Wire Set



351693R92

Distributor Cap



Fits 4 Cylinder Gas Engines With Battery ignition 1963 And Later With iH Distributor. (Not For Prestolite)

UTG25

Temperature Gauge
Adapter is 3/4-14 thread,
probe is 3/8-16 thread.
6 Foot Cable



Fits Universal Gauge

16-RU12

Resistor



Fits Universal Fit





Steering, Control Valves

Case / IH

67698C92

Steering Motor
w/o Relief Valve



Fits 84 and 85 Series

88107C92

Steering Motor
w/ Relief Valve



Fits 84 and 85 Series

70110C94

Steering Motor
With Splined/Threaded Shaft



Fits 454, 464, 574, 674, 2400, 2500, 240A,
250A, 260A, 3400A, 3500A

70114C94

Replaces 535233R92
Steering Motor
With Tilt Steering
With Splined/Threaded Shaft



Fits 766, 966, 1066, 1466, 1468, 1566,
1568, Hydro 100

70111C94

Replaces 534994R91
Steering Motor
Without Tilt Steering
With Splined/Threaded Shaft



Fits 766, 966, 1066, 1466, 1468, 1566,
1568, Hydro 100

1263446C91

Replaces 70113C93
Steering Motor
With Roll Pin Shaft



Fits 786, 886, 986, 1086, 1486, 5088, 5288, 5488, Hydro
3488

A63549

Steering Motor
With Roll Pin Shaft



Fits Case 1175, 1370

D63250

Replaces D89898
Steering Motor
With Roll Pin Shaft



Fits Case 480C, 580C, 480D, 480LL, 580F

HG500007

Replaces 123465C1, 224712C1, 517416, A47038
Steering Control Valve Upper Seal Kit
For Ross, TRW, and Hydraguide Units



Fits 454, 464, 574, 674, 666, 686, 766, 866, 1066, 1466,
1468, 1566, 1568, 786, 886, 986, 1086, 1486, 1586,
HYDRO 100, 186, 70, 86, 2400, 2500, 3400, 3600



Case / IH

Steering, Steering Sectors

CS11100B

Steering Motor
With Splined/Threaded Shaft
This is an Economical Option
to Replace Ross/Hydroglide
Units in Most Applications
(With Line Modification)



Fits 454, 464, 574, 674, 2400, 2500, 240A,
250A, 260A, 3400A, 3500A, 766, 966, 1066, 1466, 1468,
1566, 1568, HYDRO 100

99327C1

Steering Sector



Fits iH 234 Compact Tractor

CS11125B

Steering Motor
Roll Pin Type Shaft
This is an Economical Option
to Replace Ross/Hydroglide
Units in Most Applications
(With Line Modification)



Fits 786, 886, 986, 1086, 1486, 5088, 5288, 5488, Hydro
3488, Case 1175, 1370, 480C, 580C, 480D, 480LL, 580F

SECTOR01

Steering Sector Complete



Fits B275, B414 - (Will Not Fit B-414 With Fuel/Water
Separator Made to Bottom of Fuel Tank)

Steering, P/S Cylinders & Parts

Case / IH

188842A1

Replaces 549667R93
Power Steering Cylinder



400587R1

Power Steering Cylinder Barrel



549668R2

Power Steering Rod and Piston



400591R1

Power Steering Cylinder End Cap



549670R2

Replaces 3125306R1
Power Steering Clevis



Fits 454, 464, 474, 574, 674, 484, 584, 684, 784, 884, 385, 485, 585, 685, 785XL, 885, 395, 495, 595, 695, 895, 3220, 3230, 4210, 4230, 4240

55355C91

Steering Cylinder Seal Kit



Fits 454, 464, 474, 574, 674, 484, 584, 684, 784, 884, 385, 485, 585, 685, 785XL, 885, 395, 495, 595, 695, 895, 3220, 3230, 4210, 4230, 4240

533279R94

Power Steering Cylinder



Fits 766, 966, 1066, 1466, 1468, 1566, 1568, Hydro 100

533287R2

Power Steering Cylinder End



Fits 966, 1066, 1466, 1468, 1566, 1568



Case / IH

Steering, Tie Rod Ends

3040922R92

Drag Link End

A - 3.060"
B - .625"
19 R/H Std Thread

Fits B275, B414, 2300A, 354, 364



3040920R92

Short Tie Rod

A - 3.125"
B - .750"
16 R/H Thread

Fits B414 354, 364, 384



359984R93

Tie Rod End, Long



384006R92

Tie Rod End, Short



383917R1

Tie Rod Tube



Fits 1026, 1066, 1086, 1206, 1256, 1456, 1466, 1486, 1568, 1586, 460, 544, 560, 656, 660, 666, 706, 756, 766, 806, 826, 856, 966, 986, 100, 186, 70 Hydro

1968463C1

Replaces 1868468C1
Tie Rod End



1968464C1

Tie Rod End



Fits 395, 495, 585, 595, 685, 695, 885, 895 with ZF MFWD Axle

527658R91

Short Tie Rod

A - 3.062
B - .687
18 R/H thread

Fits 574, 674, 385, 454, 485



3125171R1

Replaces 1332805C1

Long Tie Rod
A - 14.125
B - .812

Fits 585, 595, 684, 685



3116406R3

Tie Rod End, Long



3116407R3

Tie Rod End, Short



3116408R1

Tie Rod Tube

A - 16.187
.82 i.D.

Fits 385, 395, 484, 485, 495, 584, 585, 595, 684, 685, 695, 884, 885, 895





Steering, Misc

Case / IH

60069D

Steering Wheel

Fits CUB, A, B, SUPER A



708424R91

Steering Wheel

Fits B275, B414



385156R1

Replaces 3123597R91

Steering Wheel

Fits 454 through 895

708601R1

Side Steering Bushing

708602R1

Side Steering Seal



708611R1

Includes 708612R1
Bearing and Race Assy



708613R1

Upper Steering Bushing



708609R1

Side Plate Gasket



708623R1

Shaft Gasket



708604R1

Steering Worm Shaft



708605R1

Steering Side Shaft



Fits B275, B414

372592R91-PiN

Steering Sector Pitman Shaft Pin
Weld in Place of Original



Fits 330, 340, 460 UTILITY TRACTORS

1432160R91

Steering Shaft



Fits 274

3109613R1

Replaces 842388R1
Front Axle Stay Ball Cap



3043920R1

Front Axle Stay Ball Socket



Fits 424, 444, 354, 364, 384

369008R5

Front Axle Pivot Bracket



Fits 240, 404, 424, 444

531248R2

Steering Arm L/H



531249R2

Steering Arm R/H

Fits 706 through 1586

67527C91

Front Wheel Hub



Fits 584, 585, 595, 674, 684, 685,
695, 784, 884, 885, 895, 995, Hydro 84

Case / IH

Transmission

CKiH01

Clutch Kit
Contains Clutch, Pressure Plate, Release Bearing, Pilot Bearing, and Alignment Tool



Fits Cub, Cub Lo-Boy

CKiH02

Clutch Kit
Contains Clutch, Pressure Plate, Release Bearing, Pilot Bearing, and Alignment Tool



Fits A, AV, B, C, SUPER A, SUPER C, 100, 130, 140, 200, 230, 240, 404

92602C92

Replaces **70716C1**,
2726336C91, **529566R92**,
69211C91
Pressure Plate
Laycock 11 inch



Fits 584, 684, 784, 884, 485, 585, 685, 785XL, 885, 495, 595, 3210, 3220, 3230, 2400, 2400A, 2400B, 2500, 2500A, 2500B, 3400A, 3500A, 4500, 4500A, 4500B, 3434, 3514, 380B

70093C91

Replaces **3121506R1**,
3121506R91, **3121507R1**,
3121507R91, **3129463R91**,
3121463R94, **3121463R95**,
401479R93
Clutch Disc
6 Pad Button Type



Fits 454, 464, 574, 674, 384, 484, 584, 684, 784, 884, 385, 485, 585, 685, 785XL, 885, 395, 495, 595, 695, 795XL, 895, 3210, 3220, 3230, 248, 258, 276, 278, 2400, 2400A, 2400B, 2500, 2500A, 2500B, 3400, 3400A, 3500, 3500A, 3514, 380B

751049R2

Clutch Fork
For Single Clutch



Fits 354, 364, 384

1971045C1

Release Bearing Carrier



Fits 385, 495, 595

1970934C1

Release Bearing Carrier



Fits 495, 595, 695, 895



Transmission

Case / IH

G16624

Replaces A144361
Manual Shuttle Gear
27 Teeth



Fits 430, 470, 530,
570, 580CK, 480B, 580B

G16623

Manual Shuttle
input Gear
25 Teeth



Fits 430, 470, 530, 570, 580CK, 480B, 580B

G16799

Manual Shuttle input Shaft
28 Teeth
External Splines



Fits 430, 470, 530, 570, 580CK,
480B, 580B

A151114

**Replaces A51874,
G45049**
Synchronizer
Manual Shuttle



Fits 430, 530, 470, 570, 580CK, 480B, 580B, 480C, 580C

A37617

Manual Shuttle input Shaft
28 Teeth
internal Splines



Fits 430, 470, 530, 570, 580CK,
480B, 580B

G46077

Replaces 71840R1
Synchronizer Ring



Fits 300, 320, 400, 430, 500, 530, 600, 630, 470, 570, 480,
480CK, 480B, 580, 580CK, 580B

G16626

Manual Shuttle input Shaft
28 Teeth
internal Splines



Fits 430, 470, 530, 570, 580CK, 480B,
580B



Case / IH

PTO

704392R1

PTO Lever Bracket



704393R91

PTO Shifter Seal



3063246R11

Replaces **751115R92**
PTO Shifter internal Lever



3064230R91

Replaces **3119812R9**
PTO Lever & Shaft
(will not work on tractors
with remote hydraulics)



Fits B275, B414, 424, 444, 354, 364, 384, 3414, 2424, 2444

704387R12

PTO Retainer & Seal Assy



45702D

PTO Seal



3073111R91

PTO Shaft Assy



48594DA

PTO Shaft Bushing



704385R1

PTO Circlip



Fits B275, B414, 424, 444, 354, 364, 384, 3414, 2424, 2444

751113R2

PTO Shift Coupling



Fits B275, B414, 424, 444, 354, 364, 384, 3414, 2424, 2444

66184DA

PTO Shaft



Fits iH A-240

G10675

PTO Gear
14 Teeth



G10676

PTO Gear
46 Teeth



A37644

PTO Shaft
6 & 10 Splines



Fits 200, 430, 530, 470, 570, 580

351287R11

PTO Shifter



Fits Cub, Cub LoBoy

Rear Axle & Brakes

Case / IH

3105296R91

Brake Actuator



Fits B414 ,424, 444, 354, 364, 384, 3414, 2424, 2444

3043997R12

Rear Axle
8 Lug, 6 inch Bolt Circle



Fits B275, B414, 354, 364, 384, 3414

395161R1

Brake Disc
6-1/2 inch Diameter



Fits B414, 424, 444, 354, 364, 384, 2424, 2444, 3414, 3444

3069966R91

Ring Gear & Pinion Set



Fits B414, 424, 444, 354, 364, 384, 3414, 2424, 2444

1287734C92

Brake Master Cylinder



Fits 3220, 3230, 4210, 4230, 4240, 5120, 5130, 5140, 5220, 5230, 5240, 5250

3071402R11

Replaces 3064164R11
& 3072916R11
Bull Pinion Cage R/H



Fits B414 ,424, 444, 354, 364, 384, 3414, 2424, 2444

1287843C92

Brake Master Cylinder



Fits 3220, 3230, 4210, 4230, 4240, C50, C60, C70, C80, C90, C100

527542R92

Brake Master Cylinder



Fits 454, 464, 574, 674, 484, 584, 684, 784, 884, H84, 385, 485, 585, 685, 785, 885, 2400, 248, 258, 268, 278

Case / IH

Hydraulic, Hydraulic Pumps

704330R95

Hyd Pump
For Manual Steering



Fits B275, B414, 424, 444,
354, 364, 384

3072695R91

Hyd Pump
For Tractors with
Power Steering



Fits 424, 444

3063911R92

Hydraulic Pump
For Tractors with
Power Steering



Fits B414, 424, 444, 354, 364, 384, 3414, 2424, 2444

93835C92

Hydraulic Pump



Fits 454 through 995



70931C91

Hydraulic Pump
12 GPM Main Hitch Pump
Note: Pump pressure is rated at 2250 PSi, exceeding
pressure may damage pump and void the warranty

Fits 786, 886, 1086, 1486, 1586, 186 Hydro

70932C91

Hydraulic Pump
15 GPM Main Hitch Pump
Note: Pump pressure is rated at 2250 PSi, exceeding
pressure may damage pump and void the warranty

Fits 786, 886, 1086, 1566, 1568, 1586, 3088, 3288, 3688

70933C91

Hydraulic Pump
12 GPM Main Hitch Pump
Note: Pump pressure is rated at 2250 PSi, exceeding
pressure may damage pump and void the warranty

Fits 330, 340, 504, 460, 560, 606, 660, 544, 656, 756,
766, 806, 826, 856, 1026, 1066, 1206, 1468, 1566, 1568,
21026, 21256, 21456, 2504, 2606, 2544, 2656, 2706,
2756, 2826, 2856, 1456D, 1466, 100 Hydro

70935C91

Hydraulic Pump
17 GPM Main Hitch Pump
Note: Pump pressure is rated at 2250 PSi, exceeding
pressure may damage pump and void the warranty

Fits 330, 340, 460, 504, 544, 560, 606, 656, 660, 664,
666, 686, 706, 756, 806, 826, 856, 1026, 1456, 21026,
21456, 2706, 2756, 2826, 2856, 3488, 3498,
186, 70, 86, all Hydro



Hydraulic, Hydraulic Pumps & Control Valve Parts

Case/IH

527397R93

MCV Hydraulic Pump
9 GPM

Note: Pump pressure is rated at 2250 PSI, exceeding pressure may damage pump and void the warranty



Fits 706, 806, 1026, 1206, 756, 856, 1246, 1456, 766, 966, 1066, 1466, 1566

120114C91

MCV Hydraulic Pump
12 GPM

Note: Pump pressure is rated at 2250 PSI, exceeding pressure may damage pump and void the warranty

Fits 786, 886, 986, 1086, 1486, 1568, 1586, 3088, 3688

3069236R92

Control Valve & Cylinder



3044376R92

Hydraulic Piston
O-Ring Style



381871R1

Hydraulic Piston O-Ring

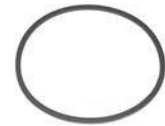

D53690

Hydraulic Pump



Fits 530, 580, 580B, 580C, 480, 480B, 480C

3047294R95

Orifice Filter Assy



3045105R1

Speed Control Piston & Spring



350709R1

Hydraulic Pump Gear
For Gas Engines
16 Teeth



Fits Super A, C, Super C, 100, 130, 140, 200, 230, 240, 330, 340, 404, 424, 444, 2404, 2424, 2444

3049088R91

Spool and Valve



3044368R93

Replaces 704342R91

Hydraulic Filter



Fits B275, B414, 424, 444, 354, 364, 384, 3414, 2424, 2444, 238



Case / IH

Hydraulic, Hitch

527948R91

Leveling Yoke L/H
19.380 inches Long



Fits 454, 464, 484, 495, 574, 584, 585, 595

527967R91

Leveling Yoke L/H
14.380 Long



Fits 454, 464, 484, 495, 574, 584, 585, 595

527937R1

Leveling Yoke Nut



Fits 385-885, 395-895, 454-484, 584-884

3121964R91

Leveling Fork
1 inch Spread



Fits 454, 464, 484, 495, 574, 584

402635R4

Leveling Fork
1-5/8 inch Spread



Fits 454, 464, 484, 495, 574

223320

Leveling Assy CAT i
With 3121964R91 Fork



Fits 454, 464, 484, 574, 584, 595, 674, 684, 784, 884, 895, 995

223321

Leveling Assy CAT ii
With 402635R4 Fork



Fits 454, 464, 484, 574, 584, 595, 674, 684, 784, 884, 895, 995

223322

Leveling Assy CAT ii
With 402635R4 Fork
For Row Crop Tractors w/ Bar Axles



Fits 584, 674, 784, 884, 585, 595, 685, 885, 895, 995

223323

Leveling Assy CAT ii
With 402635R4 Fork
For Tractors w/ Telescopic Arms & Flanged Axles



Fits 395, 495, 784, 884, 584, 585, 595, 685, 695, 895, 995



Hydraulic, Hitch

Case / IH

751506R2

Top Link Spring (Small)



751505R1

Top Link Spring (Large)



751509R4

Top Link Shaft



Fits B275, B414, 424, 444, 354, 364, 384, 3414, 2424, 2444

3069056R91

Leveling Assy R/H



704207R3

Leveling Assy L/H



Fits B275, B414, 424, 444, 354, 364, 384, 3414, 2424, 2444

3044341R91

Lower Lift Arm

R/H, L/H, 28 inches Center to Center



Fits B275, B414, 424, 444, 354, 364, 384, 3414, 2424, 2444

DRAWBARKiT03

Drawbar and Bracket Assy



Fits B275, B414, 424, 444, 354, 364, 384, 3414, 2424, 2444

108632C93

Center Link Cat ii



Fits 1026, 2756, 2826, 2856, 3088, 3288, 3488, 3688, 756, 766, 786, 826, 856, 886, 966, 986, 100, 1086



Case / IH

Sheet Metal

45640DB

Headlight (6 Volt)

Fits A, B, C, Cub, Cub Lo-Boy, H, M, MD, OS4, OS6, O4, O6, WD6, WD9, W4, W6, W9, 100, 130, 140, 200, 230, 240, 300, 330, 340, 350, 400, 450, 600, 650, SUPER A, SUPER C, SUPER H, SUPER M, SUPER W4, SUPER W6



136165A1

Fender, R/H



401933R1

Battery Cover
20 3/8 inches Long

Fits 454, 464, 574, 674, 2400, 2500



538641R4

Fender, L/H



3121393R91

Battery Cover
18 1/8 inches Long

Fits 484, 584, 684, 784, 884, 385, 395

Fits 585, 684, 784, 884, 585, 685, 885, 985, 595, 695, 895

357518R92

Seat Pan Steel Red and White
FOR 4 BOLT PATTERN ONLY



Fits A, AV, B, C, CUB, CUB LO-BOY, H, HV, M, MD, MDV, MTD, MV, SUPER H, SUPER M WDR9, WD9, 100, 140, 200, 230, 240, 300, 340, 350, 460, 600, 650

399328R2

L/H Fender
Two Headlight Style

399329R2

R/H Fender
Two Headlight Style



Fits 544, 656, 706, 756, 806, 826, 856, 1026, 1206, 1256, 1456

537496R1

Grille with Screen



Fits 354, 364, 454, 464, 574, 674

533187R1

L/H Fender
One Headlight Style

533188R1

R/H Fender
One Headlight Style

Fits 666, 686, 766, 966, 1066, 1466, 1468, 1566, 1568, 100, 70, 86 Hydro



Wheels & Rims

Case / IH

WHEEL01

Replaces **361714R91, 704675R92, 380065R91, A36738, A185090, G10660**

Front Wheel 4.5 inches X 16 inches, For a 6.00 inch X 16 inch Tire



Fits 240, 340, 404, 504, 544, 606, B275, B414, 424, 444, 354, 364, 384, 454, 464, 574, 674, 484, 584, 684, 395, 495, 595, 695, DB 770, 880, 990, 995, Case 210, 310, 440, 430, 470, 530, 570

WHEEL02

Replaces **364343R92, 380339R1, K947941, G57046, A57333**

Front Wheel 5.5 inches X 16 inches, For a 7.50 inch X 16 inch Tire



Fits 240, 340, 404, 504, 544, 606, B275, B414, 424, 444, 354, 364, 384, 454, 464, 574, 674, 484, 584, 684, 884, 395, 495, 595, 695, 895, 656, 706, 806, 686, 756, 856, 1056, 766, 966, 1066, 786, 886, 986, 1086, 4210, 4230, 4240, 4200, C50, C60, C80, C100, DB 770, 880, 885, 990, 995, 1200, 1210, 1290, 1390, 1490, 1394, 1494, 1594, 1690, Case 210, 310, 440, 430, 470, 530, 570, 630, 730, 830, 930, 770, 870, 970, 1070

WEIGHT01

Front Wheel Weight
40 Lbs



Fits most 16 inch Front Rims



WHEEL03

Replaces **703928R91, 361700R91, G12202**

Rear Rim 10 inches X 28 inches, 6 Loop

WHEEL04

Replaces **1265034C1, K301002, 67980**

Rear Rim 11 inches X 28 inches, 6 Loop

WHEEL05

Replaces **363988R92, G45710**

Rear Rim 12 inches X 28 inches, 6 Loop

WHEEL19

373508R91

Rear Rim 13 inches X 28 inches, 6 Loop

Fits 240, 340, 404, 504, 544, 606, B275, B414, 424, 444, 354, 364, 384, 454, 464, 574, 674, 484, 584, 684, 884, 395, 495, 595, 695, 895, DB770, 880, 885, 990, 995, 1200, 1210, 1290, 1390, 1490, 1394, 1494, 1594, 1690, Case 210, 310, 440, 430, 470, 530, 570

Case / IH

Wheels & Rims

WHEEL29

Replaces 361724R1,
129374A1, 1333149C1,
G12001

Wheel Center
For 28 inch Rim
Will also work on 30
inch Rims with
Drop Center



Fits 240, 340, 404, 504, 606, 544, 656, 424, 444, 384,
454, 574, 674, 484, 584, 684, 784, 884, 385, 485, 585,
685, 785, 885, 395, 495, 595, 695, 895, 4210, 4230, 4240,
4200, C50, C60, C80, C100, Case 210, 310, 440, 430, 470,
530, 570

BOLTKiT01

Bolt & Nut Fiat Style
2-1/2 inches Long



BOLTKiT02

Bolt & Nut MF Style
3 inches Long



BOLTKiT03

Bolt & Nut Ford Style
3 inches Long



BOLTKiT04

Bolt & Nut JD Style
4-3/4 inches Long



WHEEL33

Rear Rim 15 x 30
For Square Type
Wheel Center



WHEEL35

Rear Wheel Center 30 inch
For Square Type Rim



Fits 484, 584, 684, 784, 884, 385, 485, 585, 685, 785, 885,
395, 495, 595, 695, 895, 4210, 4230, 4240, 4200, C50,
C60, C80, C100, Case 210, 310, 440, 430, 470, 530, 570