



Quality Parts

RICAMBI ALTERNATIVI PER MOTORI :

**INTERMOTOR, LOMBARDINI Benzina,
SLANZI, ACME, RUGGERINI**

NON ORIGINAL PARTS FOR ENGINES :

**INTERMOTOR, LOMBARDINI Petrol,
SLANZI, ACME, RUGGERINI**

CAPITOLI CHAPTERS		
Istruzioni	0	<i>Instructions</i>
INTERMOTOR LOMBARDINI Benzina	14	<i>INTERMOTOR LOMBARDINI Petrol</i>
SLANZI	15	<i>SLANZI</i>
ACME	16	<i>ACME</i>
RUGGERINI Serie MC - RF	17	<i>RUGGERINI MC - RF Series</i>
RUGGERINI Serie RD	18	<i>RUGGERINI RD Series</i>
RUGGERINI Serie MD	19	<i>RUGGERINI MD Series</i>
RUGGERINI Serie RY	20	<i>RUGGERINI RY Series</i>
RUGGERINI Serie CRD - P - RP	21	<i>RUGGERINI CRD - P - RP Series</i>

Questo catalogo contiene dati ed informazioni provenienti dalla pluriennale esperienza di Finimpianti. Tuttavia non possiamo assumere alcuna responsabilità per eventuali dati errati od incompleti.

Tutti i dati e le informazioni contenute nel presente catalogo sono fornite a puro scopo informativo e senza responsabilità e non potranno dare adito ad alcuna forma di risarcimento.

Visto il continuo sviluppo dei nostri prodotti, Finimpianti si riserva il diritto di apportare modifiche senza preavviso.

Denominazioni, numeri e codici originali sono riportati a puro titolo di riferimento.

All the information and data contained in this catalogue came from the long Finimpianti experience. Nevertheless we can not assume any responsibility for possible mistakes.

All the information and data contained in this catalogue are provide "as is" without any representation or warranty express or implied. Under no circumstances whatsoever shall Finimpianti be liable for any damages whatsoever arising out of the use of the information and data contained in this catalogue.

Finimpianti does not warrant the accuracy or completeness of the materials and content contained in this catalogue and reserves the right to correct any errors or omissions at any time without notice and without obligation to the users of this catalogue.

OEM names, codes and part numbers, used in this catalogue, are for reference only.

ELENCO MOTORI

ENGINES LIST

	Motore	Capitolo	Pag.
	<i>Engine</i>	<i>Chapter</i>	<i>Page</i>
ACME	AD 108	16	5
ACME	AD 110	16	7
ACME	AD 112	16	13
ACME	AD 114	16	11
ACME	AD 114/A	16	9
ACME	AD 116	16	15
ACME	ADN 37	16	17
ACME	ADN 37 W	16	19
ACME	ADN 43	16	21
ACME	ADN 43 W	16	23
ACME	ADN 45 1°SERIE	16	25
ACME	ADN 45 2260000 ←	16	27
ACME	ADN 45 W 2260001 →	16	29
ACME	ADN 48	16	31
ACME	ADN 48 2260000 ←	16	33
ACME	ADN 48 W 2260001 →	16	35
ACME	ADN 54 1°SERIE	16	37
ACME	ADN 54 2260000 ←	16	39
ACME	ADN 54 W 2260001 →	16	41
ACME	ADN 60 1°SERIE	16	43
ACME	ADN 60 2260000 ←	16	45
ACME	ADN 60 W 2260001 →	16	47
ACME	ADX 300	16	49
ACME	ADX 370	16	51
ACME	ADX 600	16	53
ACME	ADX 740	16	55
ACME	ADX 742	16	57
ACME	AL 480	16	61
ACME	ALN 290 W	16	1
ACME	ALN 330 W	16	3
ACME	VT 88 W	16	59
ACME	ACME ALTRI ARTICOLI <i>OTHERS ITEMS ACME</i>	16	63
INTERMOTOR	IM 250 1176998 ←	14	1
INTERMOTOR	IM 250 1176999 →	14	3
INTERMOTOR	IM 252 1176998 ←	14	5
INTERMOTOR	IM 252 1176999 →	14	7
INTERMOTOR	IM 300 1176998 ←	14	9
INTERMOTOR	IM 300 1176999 →	14	11
INTERMOTOR	IM 302 1176998 ←	14	13
INTERMOTOR	IM 302 1176999 →	14	15
INTERMOTOR	IM 350 1176998 ←	14	17
INTERMOTOR	IM 350 1176999 →	14	19
INTERMOTOR	IM 352 1176998 ←	14	21
INTERMOTOR	IM 352 1176999 →	14	23
INTERMOTOR	IM 359 1176998 ←	14	25
INTERMOTOR	IM 359 1176999 →	14	27
INTERMOTOR	LA 250	14	29

ELENCO MOTORI

ENGINES LIST

	Motore	Capitolo	Pag.
	<i>Engine</i>	<i>Chapter</i>	<i>Page</i>
INTERMOTOR	LA 300	14	33
INTERMOTOR	LA 490	14	37
INTERMOTOR	LAP 250	14	31
INTERMOTOR	LAP 300	14	35
INTERMOTOR	LAP 490	14	39
LOMBARDINI Benzina / Petrol	LGA 184 1139537 →	14	41
LOMBARDINI Benzina / Petrol	LGA 225 1139537 →	14	45
LOMBARDINI Benzina / Petrol	LGA 226	14	49
LOMBARDINI Benzina / Petrol	LKA 184 1139537 →	14	43
LOMBARDINI Benzina / Petrol	LKA 225 1139537 →	14	47
LOMBARDINI Benzina / Petrol	LKA 226	14	51
INTERMOTOR-LOMBARDINI Benzina / Petrol	INTERMOTOR ALTRI ARTICOLI <i>OTHERS ITEMS INTERMOTOR</i>	14	53
RUGGERINI	CRD 100	21	5
RUGGERINI	CRD 100 / 2	21	7
RUGGERINI	CRD 951	21	1
RUGGERINI	CRD 951 / 2	21	3
RUGGERINI	MC 70	17	1
RUGGERINI	MC 71	17	3
RUGGERINI	MD 150	19	5
RUGGERINI	MD 151	19	7
RUGGERINI	MD 170	19	21
RUGGERINI	MD 171	19	23
RUGGERINI	MD 190	19	25
RUGGERINI	MD 191	19	27
RUGGERINI	MD 300	19	9
RUGGERINI	MD 301	19	11
RUGGERINI	MD 350	19	29
RUGGERINI	MD 351	19	31
RUGGERINI	MD 75.0	19	1
RUGGERINI	MD 75.1	19	3
RUGGERINI	MD 85.0	19	13
RUGGERINI	MD 85.1	19	15
RUGGERINI	MD 95.0	19	17
RUGGERINI	MD 95.1	19	19
RUGGERINI	P 101	21	9
RUGGERINI	P 101 / 2	21	13
RUGGERINI	P 101 / 2L	21	15
RUGGERINI	P 101 L	21	11
RUGGERINI	P 105 / 2	21	17
RUGGERINI	P 105 / 2L	21	21
RUGGERINI	P 105 / 2R	21	19
RUGGERINI	RD 180	18	5
RUGGERINI	RD 181	18	7
RUGGERINI	RD 188	18	9
RUGGERINI	RD 200	18	15
RUGGERINI	RD 201	18	17
RUGGERINI	RD 208	18	19

ELENCO MOTORI

ENGINES LIST

	Motore	Capitolo	Pag.
	<i>Engine</i>	<i>Chapter</i>	<i>Page</i>
RUGGERINI	RD 210	18	27
RUGGERINI	RD 211	18	29
RUGGERINI	RD 218	18	31
RUGGERINI	RD 220	18	33
RUGGERINI	RD 240	18	41
RUGGERINI	RD 248	18	43
RUGGERINI	RD 270	18	53
RUGGERINI	RD 278	18	55
RUGGERINI	RD 290	18	59
RUGGERINI	RD 80	18	1
RUGGERINI	RD 81	18	3
RUGGERINI	RD 850	18	11
RUGGERINI	RD 900	18	21
RUGGERINI	RD 901	18	23
RUGGERINI	RD 901/2	18	35
RUGGERINI	RD 901/A	18	13
RUGGERINI	RD 901/AD	18	25
RUGGERINI	RD 92/2	18	45
RUGGERINI	RD 92/2 L	18	47
RUGGERINI	RD 920	18	37
RUGGERINI	RD 920 L	18	39
RUGGERINI	RD 950	18	49
RUGGERINI	RD 950 L	18	51
RUGGERINI	RD 952	18	57
RUGGERINI	RF 100	17	15
RUGGERINI	RF 120	17	17
RUGGERINI	RF 121	17	19
RUGGERINI	RF 130	17	21
RUGGERINI	RF 140	17	23
RUGGERINI	RF 148	17	25
RUGGERINI	RF 80	17	5
RUGGERINI	RF 81	17	7
RUGGERINI	RF 88	17	9
RUGGERINI	RF 90	17	11
RUGGERINI	RF 91	17	13
RUGGERINI	RP 170	21	25
RUGGERINI	RP 178	21	27
RUGGERINI	RP 280	21	23
RUGGERINI	RP 320	21	29
RUGGERINI	RP 328	21	31
RUGGERINI	RP 360	21	33
RUGGERINI	RP 368	21	35
RUGGERINI	RP 380	21	37
RUGGERINI	RP 388	21	39
RUGGERINI	RY 100	20	13
RUGGERINI	RY 101	20	15
RUGGERINI	RY 103	20	11
RUGGERINI	RY 110	20	17

ELENCO MOTORI

ENGINES LIST

	Motore	Capitolo	Pag.
	<i>Engine</i>	<i>Chapter</i>	<i>Page</i>
RUGGERINI	RY 120	20	19
RUGGERINI	RY 121	20	21
RUGGERINI	RY 125	20	23
RUGGERINI	RY 50	20	1
RUGGERINI	RY 70	20	3
RUGGERINI	RY 75	20	9
RUGGERINI	RY 85.0	20	5
RUGGERINI	RY 85.1	20	7
RUGGERINI	SP 420	18	61
RUGGERINI	SERIE CRD-P-RP ALTRI ARTICOLI <i>OTHERS ITEMS CRD-P-RP SERIES</i>	21	41
RUGGERINI	SERIE MC - RF ALTRI ARTICOLI <i>OTHERS ITEMS MC-RF SERIES</i>	17	27
RUGGERINI	SERIE MD ALTRI ARTICOLI <i>OTHERS ITEMS MD SERIES</i>	19	33
RUGGERINI	SERIE RD ALTRI ARTICOLI <i>OTHERS ITEMS RD SERIES</i>	18	63
RUGGERINI	SERIE RY ALTRI ARTICOLI <i>OTHERS ITEMS RY SERIES</i>	20	25
SLANZI	DVA 1030	15	7
SLANZI	DVA 1030 S	15	9
SLANZI	DVA 1200	15	19
SLANZI	DVA 1500	15	27
SLANZI	DVA 1550	15	11
SLANZI	DVA 1550 S	15	13
SLANZI	DVA 1750	15	21
SLANZI	DVA 1750 S	15	23
SLANZI	DVA 1800	15	33
SLANZI	DVA 2000	15	39
SLANZI	DVA 2200	15	29
SLANZI	DVA 2350	15	25
SLANZI	DVA 2700	15	35
SLANZI	DVA 2900	15	31
SLANZI	DVA 3000	15	41
SLANZI	DVA 3600	15	37
SLANZI	DVA 4000	15	43
SLANZI	DVA 460	15	1
SLANZI	DVA 515	15	5
SLANZI	DVA 650	15	15
SLANZI	DVA 680	15	17
SLANZI	DVA 920	15	3
SLANZI	SLANZI ALTRI ARTICOLI <i>OTHERS ITEMS SLANZI</i>	15	45

ISTRUZIONI

INSTRUCTIONS

1	Come leggere il catalogo <i>How to read the catalogue</i>
6	Pistoni <i>Pistons</i>
8	Segmenti <i>Rings</i>
10	Bronzine <i>Bearings</i>
11	Valvole <i>Valves</i>
12	Guida Valvole <i>Valves Guides</i>
12	Cilindri <i>Cylinders</i>

Questo catalogo contiene dati ed informazioni provenienti dalla pluriennale esperienza di Finimpianti. Tuttavia non possiamo assumere alcuna responsabilità per eventuali dati errati od incompleti.

Tutti i dati e le informazioni contenute nel presente catalogo sono fornite a puro scopo informativo e senza responsabilità e non potranno dare adito ad alcuna forma di risarcimento.

Visto il continuo sviluppo dei nostri prodotti, Finimpianti si riserva il diritto di apportare modifiche senza preavviso.

Denominazioni, numeri e codici originali sono riportati a puro titolo di riferimento.

All the information and data contained in this catalogue came from the long Finimpianti experience. Nevertheless we can not assume any responsibility for possible mistakes.

All the information and data contained in this catalogue are provide "as is" without any representation or warranty express or implied. Under no circumstances whatsoever shall Finimpianti be liable for any damages whatsoever arising out of the use of the information and data contained in this catalogue.

Finimpianti does not warrant the accuracy or completeness of the materials and content contained in this catalogue and reserves the right to correct any errors or omissions at any time without notice and without obligation to the users of this catalogue.

OEM names, codes and part numbers, used in this catalogue, are for reference only.

RUGGERINI						
RF 80	Cm³	CILINDRI CYLINDERS	ALESAGGIO BORE	CORSA STROKE	VERSIONE VERSION	
	377	1	80	75		

Costruttore Manufacturer	Motore Engine	Cilindrata Cubic displacement	Cilindri Nr. of Cylinders	Alesaggio Bore	Corsa Stroke	Versione Version
-------------------------------------	--------------------------	--	--	---------------------------	-------------------------	-----------------------------

	TESTA HEAD	H01	Tipo di Pistone (vedi tabella) Piston type (see table)	
		A	85	Dimensioni in millimetri Dimensions in millimeters
B	47			
C	16,5			
D	43,1			
E	62	Codice Finimpianti per lo Spinotto Finimpianti Gudgeon Pin part number		
F	23	Codice OEM a cui lo Spinotto è adattabile Suitable to this Gudgeon Pin OEM part number		

FIN457PN	Codice Finimpianti per il Pistone Completo (Pistone, serie Segmenti, Spinotto, Segers) Finimpianti Piston Assembly part number	
8480.009	Codice OEM a cui il Pistone è adattabile Suitable to this Piston OEM part number	

85	6501.073	FIN157PC00	Diametro del Pistone Piston diameter
85,5	6501.074	FIN157PC05	
86	6501.075	FIN157PC10	

	4	2	Tipo di Segmento (vedi tabella) Ring type (see table)
	10	2	Spessore del Segmento in millimetri Ring thickness in millimeters
	10	2	
	22	4	

8210.055	FIN040RS00	Codice Finimpianti per la Serie Segmenti Finimpianti Ring Set part number
8210.056	FIN040RS05	Codice OEM a cui la Serie Segmenti è adattabile Suitable to this Ring Set OEM part number
8210.057	FIN040RS10	

TIPO TYPE	A		Tipo di Cilindro (vedi tabella) Cylinder type (see table)
	G	100	Dimensioni in millimetri Dimensions in millimeters
	H	162	
	I	91,9	
	L	116,5	
2380.553	FIN157SL00		Codice Finimpianti per il Cilindro Finimpianti Cylinder part number
			Codice OEM a cui il Cilindro è adattabile Suitable to this Cylinder OEM part number

Come leggere il Catalogo

How to read the Catalogue

Posizione bronzina
(vedi tabella)
Bearing position
(see table)

Diametro albero
Shaft Diameter

Diametro sede
Housing bore

Minorazioni
Undersizes

Codice OEM a cui la bronzina misura standard è adattabile
Suitable to this standard size bearing OEM part number

Nr.				

Materiale
(vedi tabella)
Material
(see table)

Quantità
Quantity

Lunghezza bronzina
Bearing Length

Entrobordi
Distance between flanges

Codice Finimpianti per la bronzina misura standard
Finimpianti standard size bearing part number

ADATTABILE A:
SUITABLE FOR:

Posizione valvola
IN=aspirazione EX=scarico
Valve position
IN=inlet EX=exhaust

Materiale
(vedi tabella)
Material
(see table)

Forma
(vedi tabella)
Shape
(see table)

Codice OEM a cui la valvola è adattabile
Suitable to this valve OEM part number

	IN EX		Nr.	O	P	M	N		ADATTABILE A: <i>SUITABLE FOR:</i>	
	IN	ES	1	34,3	7	99,4	45	A1	9652.017	FINA066
	EX	FN	1	29,5	7	99	45	A1	9685.027	FINS067

Quantità
Quantity

Dimensioni in millimetri
Dimensions in millimeters

Codice Finimpianti per la valvola
Finimpianti valve part number

Posizione guida valvola
IN=aspirazione EX=scarico
Valve guide position
IN=inlet EX=exhaust

Materiale
(vedi tabella)
Material
(see table)

Forma
(vedi tabella)
Shape
(see table)

Codice OEM a cui la guida valvola è adattabile
Suitable to this valve guide OEM part number

	IN EX		Nr.	R	S	T		ADATTABILE A: <i>SUITABLE FOR:</i>	
	IN	G	1	11,06	7,03	56	L	4845.154	FIN927AA
	IN	G		11,26	7,03	56	L		FIN927AB
	EX	B	1	11,06	7,03	44	L	4845.156	FIN928SA
	EX	B		11,26	7,03	44	L		FIN928SB

Quantità
Quantity

Dimensioni in millimetri
Dimensions in millimeters

Codice Finimpianti per la guida valvola
Finimpianti valve Guide part number

Come leggere il Catalogo

How to read the Catalogue

Serie guarnizioni motore con anelli di tenuta <i>Gasket set with seal rings</i>	Anello tenuta Lato Volano <i>Flywheel side seal ring</i>	Anello tenuta Lato Distribuzione <i>Gear side seal ring</i>	Guarnizione Coppa Olio <i>Oil pan gasket</i>	Guarnizione scarico <i>Outlet Gasket</i>
	8205.81	8185.01	1210.076	1213.388
FIN070CGA	FIN070CB	FIN670CM	FIN976RT	FIN978RT

Serie guarnizioni motore senza anelli di tenuta <i>Gasket set without seal rings</i>	Serie Smeriglio <i>Top set gasket</i>	Guarnizione Coperchio Bilancieri <i>Rocker box cap</i>	Guarnizione aspirazione <i>Inlet Gasket</i>
		IN	EX
		4600.090	4400.014
		4500.014	4500.091
		FIN070CO	FIN671CB
		FIN470I	FIN371EG

Spessore della guarnizione in millimetri
Gasket Thickness in millimeters

	ADATTABILE A: SUITABLE FOR:	
0,6 mm	4730.117	FIN270HG
0,7 mm	4730.118	FIN271HG
0,8 mm	4730.119	FIN272HG
0,9 mm	4730.120	FIN273HG
1,0 mm	4730.121	FIN274HG

Codice OEM a cui è adattabile
Suitable to this OEM part number

Codice Finimpianti
Finimpianti part number

Guarnizione aspirazione
Inlet Gasket

Codice Finimpianti per la guarnizione testa
Finimpianti head gasket part number

Codice OEM a cui la guarnizione testa è adattabile
Suitable to this head gasket OEM part number

Numero di cilindri presenti nel kit
Numbers of liners in the kit

Numero di pistoni completi presenti nel kit
Numbers of pistons assembly in the kit

Numero di guarnizione smeriglio presenti nel kit
Numbers of top set gasket in the kit

Nr.	ENGINE KIT
1	
1	
1	
4898.002	FIN0535KIT

Codice OEM a cui il kit motore è adattabile
Suitable to this engine kit OEM part number

Codice Finimpianti per il kit motore
Finimpianti engine kit part number







ELECTRIC KIT

FIN001ME









Codice Finimpianti per il kit trasformazione elettrico :
volano con corona, convogliatore, piastra, coperchio bilancieri, marmitta con protezione, bulloneria varia, motorino d'avviamento, quadro accensione, alternatore, regolatore di tensione, cablaggi vari.
Finimpianti electric starter kit part number:
flywheel with crown- shroud- flanging plate- rocker box cap- muffler with airtight plates- various screws- starter engine- command panel- alternator- voltage regulator- various connecting cables

Come leggere il Catalogo







How to read the Catalogue

Filtro aria <i>Air cleaner</i>	Prefiltro <i>Cyclon prefilter element</i>	Massa filtrante metallica <i>Metallic filtering element</i>	Massa filtrante poliuretanica <i>Polyurethanic filtering element</i>	Cartuccia filtro olio <i>Oil filter element</i>	Tappo sfiato <i>Breather cap</i>		
							
3700.102	1301.069	5496.111	5496.110	2175.00	2175.028	1400.36	9050.050
FIN102	FIN269PF	FIN112NF	FIN070CFA	FIN309FE	FIN428OF	FIN018OL	FIN050SF









Codice OEM a cui è adattabile <i>Suitable to this OEM part number</i>	Codice Finimpianti <i>Finimpianti part number</i>	Cartuccia filtro combustibile <i>Fuel filter cartridge</i>	Asta livello olio <i>Oil dipstick</i>
---	---	--	---

Biella completa <i>Connecting rod assembly</i>	Gruppo bilanciere completo <i>Cocker arm assembly</i>	Testa completa : valvole, guide, sedi, cappellotti , molle, bilanciere, viti. Cylinder head assembly: <i>Valves, guides ,seats, valve caps, springs, rocker arm, screws.</i>					
							
1526.159	1051.005	8676.09 1610.02		4336.023	606.025	9200.0	9200.087
FIN1003KR	FIN005CK	FIN1098CS	FIN061RK	FIN061OP	FIN061SK	FIN587	FIN588CP









Albero motore <i>Crankshaft</i>	Supporto albero motore lato volano con boccia 1 mm. <i>Flywheel side crankshaft support with 1mm. bushing</i>	Pompa olio <i>Oil pump</i>	Perno bilanciere <i>Rocker arm shaft</i>	Testa con sedi e guide. <i>Cylinder head with seats and guides</i>
---	---	--------------------------------------	--	--

Pompa alimentazione <i>Fuel feeding pump</i>	Iniettore completo <i>Nozzle holder</i>	Polverizzatore <i>Nozzle</i>	Pompante <i>Injection plunger</i>	Valvolina mandata <i>Delivery valve</i>	Basamento motore <i>Crankcase</i>		
							
6585.031	6590.263	6615.013	6531.265	6578.013	9672.013	1510.668	2125.193
FIN031FP	FIN033JP	FIN013NH	FIN017NO	FIN078E	FIN016DV	FIN823KK	FIN393CL

Pompa iniezione <i>Injection pump</i>	Codice OEM a cui è adattabile <i>Suitable to this OEM part number</i>	Codice Finimpianti <i>Finimpianti part number</i>	Coperchio bilanciere <i>Cocker box cap</i>
---	---	---	--

Puleggia avviamento <i>Starting pulley</i>	Fune avviamento <i>Rope starting</i>	Tappo starter <i>Starter cap</i>	Tappo serbatoio <i>Tank cap</i>	Serbatoio <i>Tank</i>	Piastra convogliatore <i>Shroud plate</i>		
							
6961.029	4055.045		9043.025	8102.093	2567.616	6370.326	5096.019
FIN02	FIN003PN		FIN025TS	FIN755TK	FIN SR	FIN355RP	FIN86 P

Codice OEM a cui è adattabile <i>Suitable to this OEM part number</i>	Codice Finimpianti <i>Finimpianti part number</i>	Convogliatore <i>Shroud</i>	Lamiera di protezione <i>Guard panel</i>
---	---	---------------------------------------	--

Alternatore <i>Alternator</i>	Regolatore di tensione <i>Voltage regulator</i>	Motorino d'avviamento <i>Starter engine</i>	Marmitta insonorizzata <i>Silenced muffler</i>	Lamiera <i>Airtight plate</i>	Lamiera <i>Airtight plate</i>		
							
1157.153	7362.228	5840.142	5462.084	6927.342	5066.248	5066.247	6647.057
FIN553VA	FIN238VR	FIN142TL	FIN084SI	FIN382PM	FIN086LA	FIN085LS	FIN3 L

Codice OEM a cui è adattabile <i>Suitable to this OEM part number</i>	Codice Finimpianti <i>Finimpianti part number</i>	Protezione marmitta <i>Muffler guard</i>	Coppa olio <i>Oil pan</i>
---	---	--	-------------------------------------

Pistoni

Pistons

H01	H02	H03	H04	H05
H06	H07	H08	H09	H10
H11	H12	H13	H14	H15
H16	H17	H18	H19	H20
H21	H22	H23	H24	H25











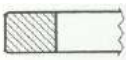
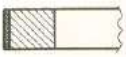

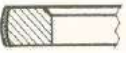
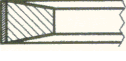
Pistoni







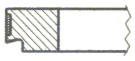
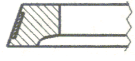

Pistons

H26	H27	H28	H29	H30
H31	H32	H33	H34	H35
H36	H37	H38	H39	H40
H41	H42	H43	H44	H45
H46	H47	H48	H49	H50

Segmenti

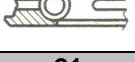
Rings

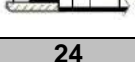
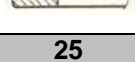
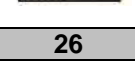
Anello di compressione standard	 1	<i>Standard compression ring</i>
Anello di compressione cromato	 2	<i>Chrome plated compression ring</i>
Anello di compressione cromato e bombato	 3	<i>Barrel shaped and chrome plated compression ring</i>
Anello di compressione cromato bombato torsionale	 4	<i>Barrel shaped and chrome plated internal bevelled compression ring</i>
Anello di compressione cromato bitrapezoidale	 5	<i>Chrome plated keystone compression ring</i>
Anello di compressione cromato bombato bitrapezoidale	 6	<i>Barrel shaped and chrome plated keystone compression ring</i>
Anello di compressione molibdenato bombato bitrapezoidale	 7	<i>Barrel shaped and molybdenum plated keystone compression ring</i>
Anello di compressione torsionale molibdenato	 8	<i>Molybdenum plated internal bevelled compression ring</i>
Anello di compressione conico	 9	<i>Taper faced compression ring</i>
Anello di compressione conico torsionale	 10	<i>Taper faced internally bevelled compression ring (positive twist type)</i>
Anello di compressione conico cromato	 11	<i>Chrome plated taper faced compression ring</i>
Anello di compressione torsionale	 12	<i>Internal bevelled compression ring (positive twist type)</i>
Anello di compressione torsionale cromato	 13	<i>Internally bevelled chrome plated compression ring</i>
Anello raschiaolio con scalino	 14	<i>Napier ring</i>

Anello raschiaolio con scalino molibdenato	 15	<i>Molybdenum plated napier ring</i>
Anello di compressione conico torsionale inverso molibdenato	 16	<i>Molybdenum plated taper faced internal bevelled compression ring</i>
Anello raschiaolio a feritoie	 17	<i>Slotted oil control ring</i>
Anello raschiaolio a feritoie a smussi paralleli	 18	<i>Double bevelled oil control ring</i>
Anello raschiaolio a feritoie a smussi convergenti	 19	<i>Bevelled edge oil control ring</i>
Anello raschiaolio expander a smussi paralleli a feritoie con molla di espansione	 20	<i>Flexoil expander type top bevelled oil control ring</i>
Anello raschiaolio a feritoie smussi convergenti con molla a spirale	 21	<i>Double bevelled oil control ring with spiral expander</i>
Anello raschiaolio a feritoie smussi paralleli con molla a spirale	 22	<i>Top bevelled oil control ring with spiral expander</i>
Anello raschiaolio a feritoie smussi convergenti cromato con molla a spirale	 23	<i>Chrome double bevelled oil control ring with spiral expander</i>
Anello raschiaolio Nifflex	 24	<i>Multi pieces steel rail oil control ring (Nifflex)</i>
Anello di compressione bombato e torsionale	 25	<i>Barrel shaped internal bevelled ring</i>
Anello di compressione Cord	 26	<i>Multi pieces ring (Cord)</i>
Anello raschiaolio Duaflex	 27	<i>Multi pieces steel rail oil control ring (Duaflex)</i>

Bronzine

Bearings

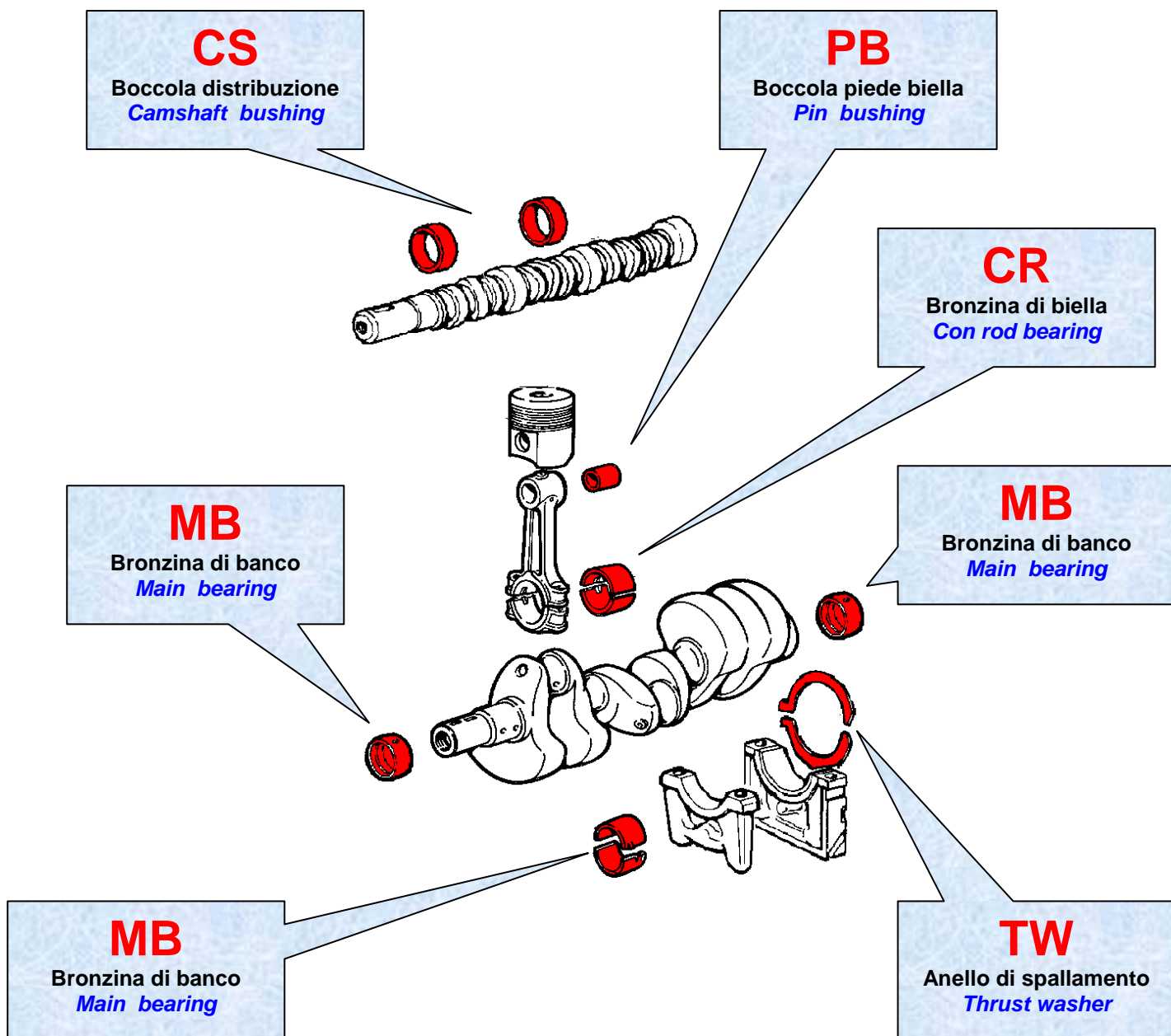

	MATERIALE	MATERIAL
AL	Lega Alluminio / Stagno	<i>Aluminium / Tin Alloy</i>
ALL	Alluminio	<i>Aluminium</i>
AQ	Acciaio	<i>Steel</i>
ASI	Lega Alluminio / Silicio	<i>Aluminium / Silicon Alloy</i>
BM	Bimetallico	<i>Bimetallic</i>
BR	Bronzo	<i>Bronze</i>
GH	Ghisa	<i>Cast Iron</i>
MB	Metallo Bianco	<i>White Metal</i>
RP	Lega Rame / Piombo	<i>Copper / Lead Alloy</i>







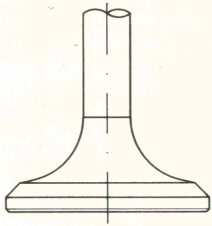
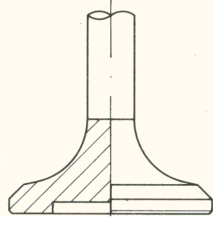
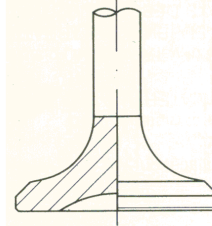
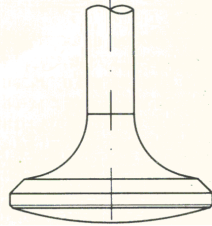
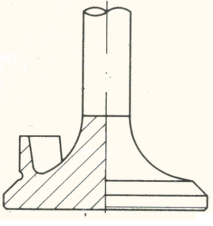

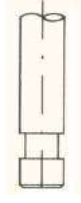
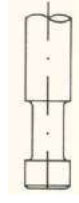
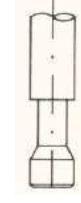
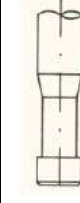
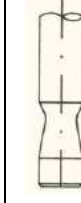
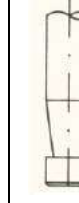
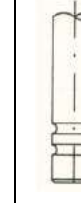
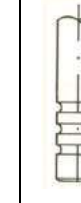
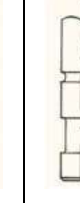
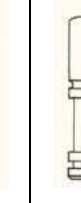

Valvole

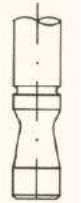
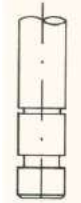
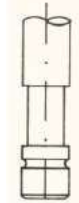
Valves

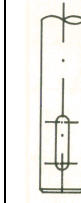
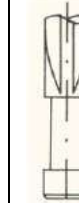
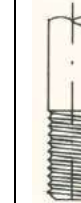
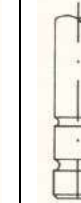
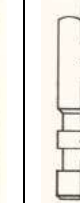
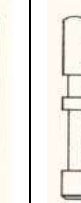
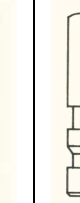
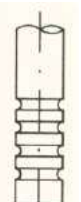
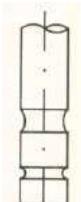
FORME TESTA HEAD SHAPES

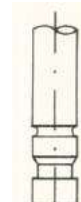
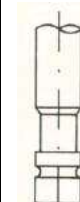
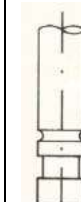
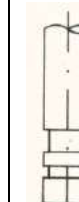
				
A	B	C	D	E

FORME ARRESTO RETAINER SHAPES

											
1	2	3	4	5	6	7	8	9	10	11	12
											
13	14	15	16	17	18	19	20	21	22	23	24
											
25	26	27	28	29	30	31	32	33	34		

	MATERIALE	MATERIAL
FS	Acciaio martensitico al cromo silicio	<i>Silicon chrome-plated martensitic steel</i>
FN	Acciaio al cromo-nichel	<i>Chrome-nickel steel</i>
FSN	Bimetallico : acciaio austenitico e amagnetico per la testa e martensitico per lo stelo	<i>Bimetallic : austeniticamagnetic steel for the head and martensitic steel for stem</i>
FR	Acciaio al cromo-nichel-manganese	<i>Chrome-nickel-manganese steel</i>
/CR	Valvola con stelo cromato	<i>Chrome plated stem valve</i>

Guida Valvole

Valves Guides

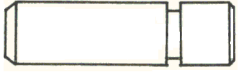
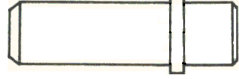
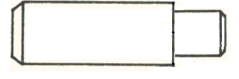
FORME <i>SHAPES</i>		
		
L	F	I

	MATERIALE	MATERIAL
G	Ghisa	Cast Iron
B	Bronzo	Bronze

Cilindri

Cylinders

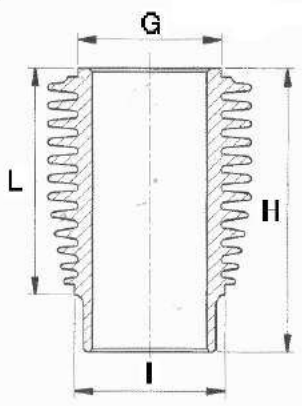
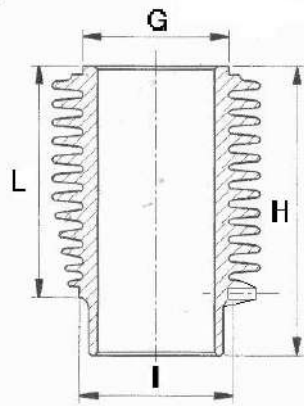
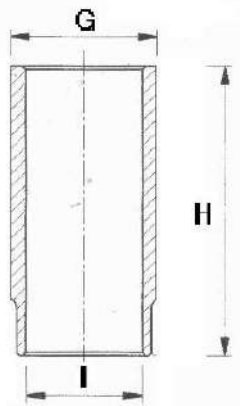
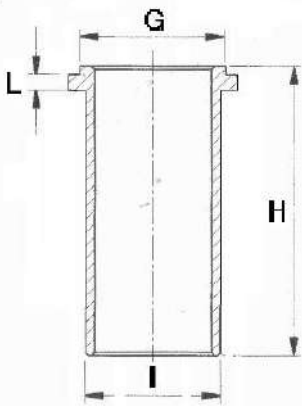
			
A	AF	CL	CB

INTERMOTOR LOMBARDINI

Benzina - *Petrol*

1	IM 250	1176998 ←
3	IM 250	1176999 →
5	IM 252	1176998 ←
7	IM 252	1176999 →
9	IM 300	1176998 ←
11	IM 300	1176999 →
13	IM 302	1176998 ←
15	IM 302	1176999 →
17	IM 350	1176998 ←
19	IM 350	1176999 →
21	IM 352	1176998 ←
23	IM 352	1176999 →
25	IM 359	1176998 ←
27	IM 359	1176999 →
29	LA 250	
31	LAP 250	
33	LA 300	
35	LAP 300	
37	LA 490	
39	LAP 490	
41	LGA 184	1139537 →
43	LKA 184	1139537 →
45	LGA 225	1139537 →
47	LKA 225	1139537 →
49	LGA 226	
51	LKA 226	
53	ALTRI ARTICOLI	<i>OTHERS ITEMS</i>

Questo catalogo contiene dati ed informazioni provenienti dalla pluriennale esperienza di Finimpianti. Tuttavia non possiamo assumere alcuna responsabilità per eventuali dati errati od incompleti.

Tutti i dati e le informazioni contenute nel presente catalogo sono fornite a puro scopo informativo e senza responsabilità e non potranno dare adito ad alcuna forma di risarcimento.

Visto il continuo sviluppo dei nostri prodotti, Finimpianti si riserva il diritto di apportare modifiche senza preavviso.

Denominazioni, numeri e codici originali sono riportati a puro titolo di riferimento.

All the information and data contained in this catalogue came from the long Finimpianti experience. Nevertheless we can not assume any responsibility for possible mistakes.



All the information and data contained in this catalogue are provide "as is" without any representation or warranty express or implied. Under no circumstances whatsoever shall Finimpianti be liable for any damages whatsoever arising out of the use of the information and data contained in this catalogue.







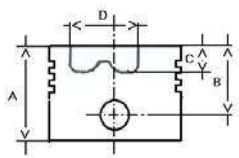

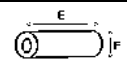
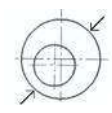
Finimpianti does not warrant the accuracy or completeness of the materials and content contained in this catalogue and reserves the right to correct any errors or omissions at any time without notice and without obligation to the users of this catalogue.

OEM names, codes and part numbers, used in this catalogue, are for reference only.

INTERMOTOR

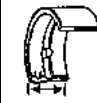
IM 250	Cm³	CILINDRI CYLINDERS	ALESAGGIO BORE	CORSA STROKE	VERSIONE VERSION
	254	1	70	66	1176998 ←

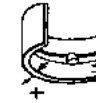
		TESTA HEAD	H09		TIPO TYPE	
		A				
		B	32,7			
		C				
		D				
		E	55			
FIN986PN		F	15			
8480.002						
	70	6502.080	FIN136PC00	8210.096	FIN026RS00	
	70,5	6502.082	FIN136PC05	8210.097	FIN026RS05	
	71	6502.083	FIN136PC10	8210.098	FIN026RS10	

		Nr.						ADATTABILE A: SUITABLE FOR:	
---	---	------------	---	---	---	---	---	--------------------------------	---

--	--	--	--	--	--	--	--	--	--

MB		1	GABBIA A RULLI - NEEDLE BEARING				3030.028	FIN3283GR
----	--	---	---------------------------------	--	--	--	----------	-----------





MB		1	CUSCINETTO A SFERA - BALL BEARING				3001.070	FIN3700BR
----	--	---	-----------------------------------	--	--	--	----------	-----------



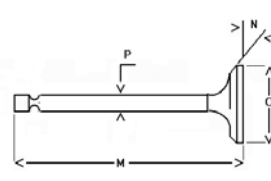

--	--	--	--	--	--	--	--	--	--

--	--	--	--	--	--	--	--	--	--

--	--	--	--	--	--	--	--	--	--

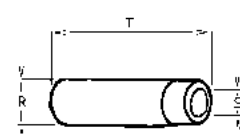
--	--	--	--	--	--	--	--	--	--

	IN EX		Nr.	O	P	M	N		ADATTABILE A: SUITABLE FOR:			
	IN		FS	1	32	7	94,1		45	A33	9652.016	FINA051
	EX		FN	1	28	7	93,8		45	A33	9685.022	FINS052

	IN EX		Nr.	R	S	T		ADATTABILE A: SUITABLE FOR:			
	IN		B	1	12,05	7,05		37	I	4845.028	FIN935ASA
	IN										
	EX		B	1	12,05	7,05		37	I	4845.028	FIN935ASA
EX											

Ricambi non originali per motori. Denominazioni e codici originali, sono riportati a puro titolo di riferimento.

1 - 14

rel. 1511

Non original engine parts. OEMs names and part numbers are for reference purpose only.

INTERMOTOR

IM 250	Cm³	CILINDRI CYLINDERS	ALESAGGIO BORE	CORSA STROKE	VERSIONE VERSION
	254	1	70	66	1176998 ←

	8180.186		1213.002	1213.056				
FIN997CGA	FIN997CGB		FIN955RT	FIN947RT				

 	ADATTABILE A: SUITABLE FOR:		Nr.	ENGINE KIT	ELECTRIC KIT
	4730.530	FIN390HG	1		
			1		
			1		



3700.277		5496.062		3730.041			
FIN707AF		FIN1100NF		FIN4300FE			







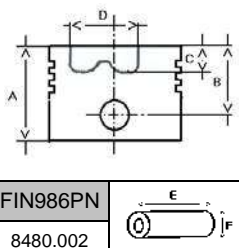

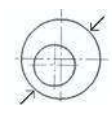
1526.026							
FIN6206KR STD							

Ricambi non originali per motori. Denominazioni e codici originali, sono riportati a puro titolo di riferimento.

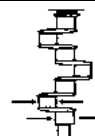
INTERMOTOR

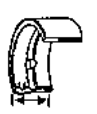
IM 250	Cm³	CILINDRI CYLINDERS	ALESAGGIO BORE	CORSA STROKE	VERSIONE VERSION
	254	1	70	66	1176999 →

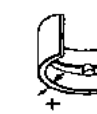
		TESTA HEAD	H09		1	2	TIPO TYPE	
		A			10	2		
		B	32,7		22	4		
		C						
		D						
		E	55					
		F	15					
	FIN986PN							
	8480.002							
	70	6502.080	FIN136PC00	8210.096	FIN026RS00			
	70,5	6502.082	FIN136PC05	8210.097	FIN026RS05			
	71	6502.083	FIN136PC10	8210.098	FIN026RS10			

		Nr.						ADATTABILE A: SUITABLE FOR:	
---	---	------------	---	---	---	---	---	--	---

--	--	--	--	--	--	--	--	--	--

MB		2	CUSCINETTO A SFERA – BALL BEARING					3001.070	FIN3700BR
----	--	---	-----------------------------------	--	--	--	--	----------	-----------





--	--	--	--	--	--	--	--	--	--



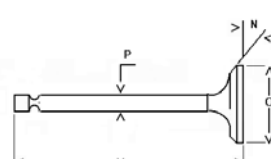

--	--	--	--	--	--	--	--	--	--

--	--	--	--	--	--	--	--	--	--

--	--	--	--	--	--	--	--	--	--

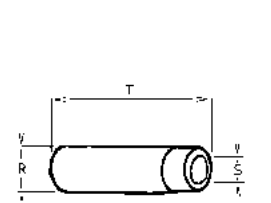
--	--	--	--	--	--	--	--	--	--

	IN EX		Nr.	O	P	M	N		ADATTABILE A: SUITABLE FOR:	
	IN	FS	1	32	7	94,1	45	A33	9652.016	FINA051
	EX	FN	1	28	7	93,8	45	A33	9685.022	FINS052

	IN EX		Nr.	R	S	T		ADATTABILE A: SUITABLE FOR:	
	IN	B	1	12,05	7,05	37	I	4845.028	FIN935ASA
	IN								
	EX	B	1	12,05	7,05	37	I	4845.028	FIN935ASA
	EX								

Ricambi non originali per motori. Denominazioni e codici originali, sono riportati a puro titolo di riferimento.

3 - 14

rel. 1511

Non original engine parts. OEMs names and part numbers are for reference purpose only.

INTERMOTOR

IM 250	Cm³	CILINDRI CYLINDERS	ALESAGGIO BORE	CORSA STROKE	VERSIONE VERSION
	254	1	70	66	1176999 →

	8180.186		1213.002	1213.056				
FIN997CGA	FIN997CGB		FIN955RT	FIN947RT				

 	ADATTABILE A: SUITABLE FOR:		Nr.	ENGINE KIT	ELECTRIC KIT
	4730.530	FIN390HG	1		
			1		
			1		



3700.277		5496.062		3730.041			
FIN707AF		FIN1100NF		FIN4300FE			





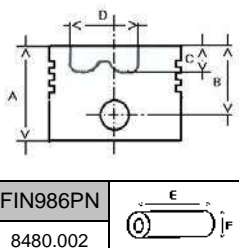

1526.026							
FIN6206KR STD							

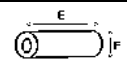
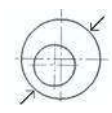
Ricambi non originali per motori. Denominazioni e codici originali, sono riportati a puro titolo di riferimento.

INTERMOTOR

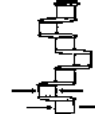
IM 252	Cm³	CILINDRI CYLINDERS	ALESAGGIO BORE	CORSA STROKE	VERSIONE VERSION
	254	1	70	66	1176998 ←

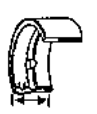
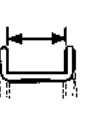
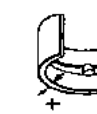
		TESTA HEAD	H09		1	2	TIPO TYPE	
		A			10	2		
		B	32,7		22	4		
		C						
		D						
		E	55					
	FIN986PN							
	8480.002							
	70	6502.080	FIN136PC00	8210.096	FIN026RS00			
	70,5	6502.082	FIN136PC05	8210.097	FIN026RS05			
	71	6502.083	FIN136PC10	8210.098	FIN026RS10			

		Nr.						ADATTABILE A: SUITABLE FOR:	
---	---	------------	---	---	---	---	---	--	---

--	--	--	--	--	--	--	--	--	--

MB		1	GABBIA A RULLI - NEEDLE BEARING				3030.028	FIN3283GR
----	--	---	---------------------------------	--	--	--	----------	-----------





MB		1	CUSCINETTO A SFERA - BALL BEARING				3001.070	FIN3700BR
----	--	---	-----------------------------------	--	--	--	----------	-----------



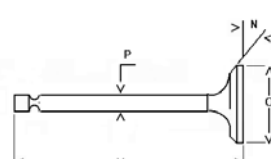

--	--	--	--	--	--	--	--	--	--

--	--	--	--	--	--	--	--	--	--

--	--	--	--	--	--	--	--	--	--

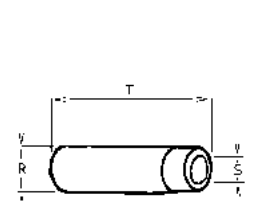
--	--	--	--	--	--	--	--	--	--

	IN EX		Nr.	O	P	M	N		ADATTABILE A: SUITABLE FOR:	
	IN	FS	1	32	7	94,1	45	A33	9652.016	FINA051
	EX	FN	1	28	7	93,8	45	A33	9685.022	FINS052

	IN EX		Nr.	R	S	T		ADATTABILE A: SUITABLE FOR:	
	IN	B	1	12,05	7,05	37	I	4845.028	FIN935ASA
	IN								
	EX	B	1	12,05	7,05	37	I	4845.028	FIN935ASA
EX									

Ricambi non originali per motori. Denominazioni e codici originali, sono riportati a puro titolo di riferimento.

5 - 14

rel. 1511

Non original engine parts. OEMs names and part numbers are for reference purpose only.

INTERMOTOR

IM 252	Cm³	CILINDRI CYLINDERS	ALESAGGIO BORE	CORSA STROKE	VERSIONE VERSION
	254	1	70	66	1176998 ←

	8180.186		1213.002	1213.056				
FIN997CGA	FIN997CGB		FIN955RT	FIN947RT				

 	ADATTABILE A: SUITABLE FOR:		Nr.	ENGINE KIT	ELECTRIC KIT
	4730.530	FIN390HG	1		
			1		
			1		



3700.277		5496.062		3730.041			
FIN707AF		FIN1100NF		FIN4300FE			





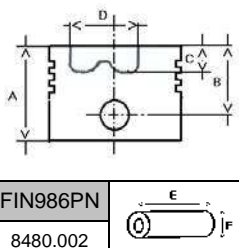

1526.026							
FIN6206KR STD							

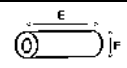
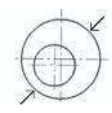
Ricambi non originali per motori. Denominazioni e codici originali, sono riportati a puro titolo di riferimento.

INTERMOTOR

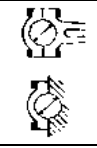
IM 252	Cm³	CILINDRI CYLINDERS	ALESAGGIO BORE	CORSA STROKE	VERSIONE VERSION
	254	1	70	66	1176999 →

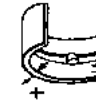
		TESTA HEAD	H09		1	2	TIPO TYPE	
		A			10	2		
		B	32,7		22	4		
		C						
		D						
		E	55					
	FIN986PN							
	8480.002							
	70	6502.080	FIN136PC00	8210.096	FIN026RS00			
	70,5	6502.082	FIN136PC05	8210.097	FIN026RS05			
	71	6502.083	FIN136PC10	8210.098	FIN026RS10			

		Nr.						ADATTABILE A: SUITABLE FOR:	
---	---	------------	---	---	---	---	---	--------------------------------	---

--	--	--	--	--	--	--	--	--	--

MB		2	CUSCINETTO A SFERA – BALL BEARING					3001.070	FIN3700BR
----	--	---	-----------------------------------	--	--	--	--	----------	-----------





--	--	--	--	--	--	--	--	--	--



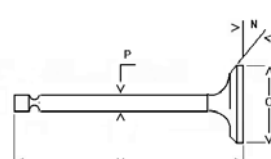

--	--	--	--	--	--	--	--	--	--

--	--	--	--	--	--	--	--	--	--

--	--	--	--	--	--	--	--	--	--

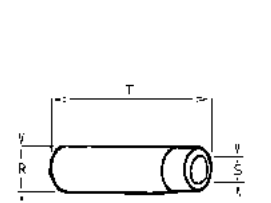
--	--	--	--	--	--	--	--	--	--

	IN EX		Nr.	O	P	M	N		ADATTABILE A: SUITABLE FOR:	
	IN	FS	1	32	7	94,1	45	A33	9652.016	FINA051
	EX	FN	1	28	7	93,8	45	A33	9685.022	FINS052

	IN EX		Nr.	R	S	T		ADATTABILE A: SUITABLE FOR:	
	IN	B	1	12,05	7,05	37	I	4845.028	FIN935ASA
	IN								
	EX	B	1	12,05	7,05	37	I	4845.028	FIN935ASA
EX									

Ricambi non originali per motori. Denominazioni e codici originali, sono riportati a puro titolo di riferimento.

7 - 14

rel. 1511

Non original engine parts. OEMs names and part numbers are for reference purpose only.

INTERMOTOR

IM 252	Cm³	CILINDRI CYLINDERS	ALESAGGIO BORE	CORSA STROKE	VERSIONE VERSION
	254	1	70	66	1176999 →

	8180.186		1213.002	1213.056				
FIN997CGA	FIN997CGB		FIN955RT	FIN947RT				

 	ADATTABILE A: SUITABLE FOR:		Nr.	ENGINE KIT	ELECTRIC KIT
	4730.530	FIN390HG	1		
			1		
			1		



3700.277		5496.062		3730.041			
FIN707AF		FIN1100NF		FIN4300FE			







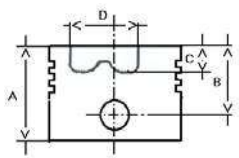

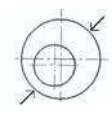
1526.026							
FIN6206KR STD							

Ricambi non originali per motori. Denominazioni e codici originali, sono riportati a puro titolo di riferimento.

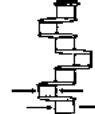
INTERMOTOR

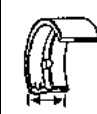
IM 300	Cm³	CILINDRI CYLINDERS	ALESAGGIO BORE	CORSA STROKE	VERSIONE VERSION
	300	1	76	66	1176998 ←

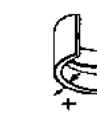
		TESTA HEAD	H09		3	2	TIPO TYPE	
		A	58		10	2		
		B	32,7		22	4		
		C						
		D						
	FIN986PN	E	55					
	8480.002	F	15					
	76	6502.015	FIN138PC00	8210.077	FIN028RS00			
	76,5	6502.016	FIN138PC05	8210.078	FIN028RS05			
	77	6502.017	FIN138PC10	8210.079	FIN028RS10			

		Nr.						ADATTABILE A: SUITABLE FOR:	
---	---	------------	---	---	---	---	---	--	---

--	--	--	--	--	--	--	--	--	--

MB		1	GABBIA A RULLI – NEEDLE BEARING				3030.028	FIN3283GR
----	--	---	---------------------------------	--	--	--	----------	-----------





MB		1	CUSCINETTO A SFERA – BALL BEARING				3001.070	FIN3700BR
----	--	---	-----------------------------------	--	--	--	----------	-----------



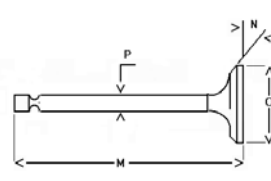

--	--	--	--	--	--	--	--	--	--

--	--	--	--	--	--	--	--	--	--

--	--	--	--	--	--	--	--	--	--

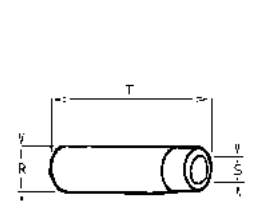
--	--	--	--	--	--	--	--	--	--

	IN EX		Nr.	O	P	M	N		ADATTABILE A: SUITABLE FOR:	
	IN	FS	1	32	7	94,1	45	A33	9652.016	FINA051
	EX	FN	1	28	7	93,8	45	A33	9685.022	FINS052

	IN EX		Nr.	R	S	T		ADATTABILE A: SUITABLE FOR:	
	IN	B	1	12,05	7,05	37	I	4845.028	FIN935ASA
	IN								
	EX	B	1	12,05	7,05	37	I	4845.028	FIN935ASA
EX									

Ricambi non originali per motori. Denominazioni e codici originali, sono riportati a puro titolo di riferimento.

9 - 14

rel. 1511

Non original engine parts. OEMs names and part numbers are for reference purpose only.

INTERMOTOR

IM 300	Cm³	CILINDRI CYLINDERS	ALESAGGIO BORE	CORSA STROKE	VERSIONE VERSION
	300	1	76	66	1176998 ←

	8180.187		1213.002	1213.056				
FIN049CGA	FIN049CGB		FIN955RT	FIN947RT				

 	ADATTABILE A: SUITABLE FOR:		Nr.	ENGINE KIT	ELECTRIC KIT
	4730.531	FIN391HG	1		
			1		
			1		

3700.277		5496.062		3730.041			
FIN707AF		FIN1100NF		FIN4300FE			

1526.026							
FIN6206KR STD							

Ricambi non originali per motori. Denominazioni e codici originali, sono riportati a puro titolo di riferimento.



10 - 14







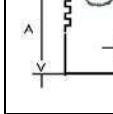
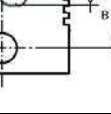

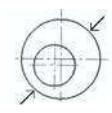
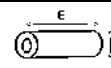
rel. 1511

Non original engine parts. OEMs names and part numbers are for reference purpose only.

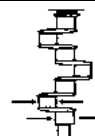
INTERMOTOR

IM 300	Cm³	CILINDRI CYLINDERS	ALESAGGIO BORE	CORSA STROKE	VERSIONE VERSION
	300	1	76	66	1176999 →

			TESTA HEAD	H09		3	2	TIPO TYPE	
						10	2		
						22	4		
	FIN986PN 8480.002		E	55	8210.077	FIN028RS00			
	76	6502.015	FIN138PC00		8210.078	FIN028RS05			
	76,5	6502.016	FIN138PC05		8210.079	FIN028RS10			
	77	6502.017	FIN138PC10						

		Nr.						ADATTABILE A: SUITABLE FOR:	
---	---	------------	---	---	---	---	---	--------------------------------	---

--	--	--	--	--	--	--	--	--	--

MB		2	CUSCINETTO A SFERA – BALL BEARING					3001.070	FIN3700BR
----	--	---	-----------------------------------	--	--	--	--	----------	-----------





--	--	--	--	--	--	--	--	--	--



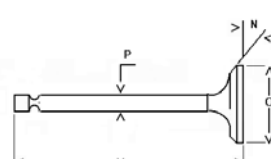

--	--	--	--	--	--	--	--	--	--

--	--	--	--	--	--	--	--	--	--

--	--	--	--	--	--	--	--	--	--

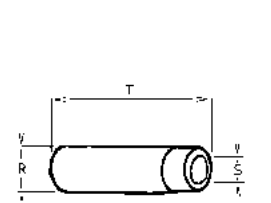
--	--	--	--	--	--	--	--	--	--

	IN EX		Nr.	O	P	M	N		ADATTABILE A: SUITABLE FOR:								
	IN								FS	1	32	7	94,1	45	A33	9652.016	FINA051
	EX								FN	1	28	7	93,8	45	A33	9685.022	FINS052

	IN EX		Nr.	R	S	T		ADATTABILE A: SUITABLE FOR:							
	IN							B	1	12,05	7,05	37	I	4845.028	FIN935ASA
	IN														
	EX							B	1	12,05	7,05	37	I	4845.028	FIN935ASA
EX															

Ricambi non originali per motori. Denominazioni e codici originali, sono riportati a puro titolo di riferimento.

11 - 14

rel. 1511

Non original engine parts. OEMs names and part numbers are for reference purpose only.

INTERMOTOR

IM 300	Cm³	CILINDRI CYLINDERS	ALESAGGIO BORE	CORSA STROKE	VERSIONE VERSION
	300	1	76	66	1176999 →

	8180.187		1213.002	1213.056				
FIN049CGA	FIN049CGB		FIN955RT	FIN947RT				

 	ADATTABILE A: SUITABLE FOR:		Nr.	ENGINE KIT	ELECTRIC KIT
	4730.531	FIN391HG	1		
			1		
			1		

3700.277		5496.062		3730.041			
FIN707AF		FIN1100NF		FIN4300FE			

1526.026							
FIN6206KR STD							

Ricambi non originali per motori. Denominazioni e codici originali, sono riportati a puro titolo di riferimento.



12 - 14





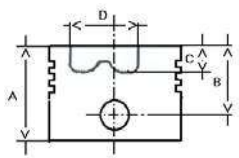

rel. 1511

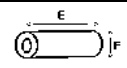
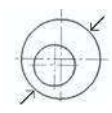
Non original engine parts. OEMs names and part numbers are for reference purpose only.

INTERMOTOR

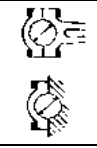
IM 302	Cm³	CILINDRI CYLINDERS	ALESAGGIO BORE	CORSA STROKE	VERSIONE VERSION
	300	1	76	66	1176998 ←

		TESTA HEAD	H09		3	2	TIPO TYPE	
		A	58		10	2		
		B	32,7		22	4		
		C						
		D						
		E	55					
FIN986PN		F	15					
8480.002								
	76	6502.015	FIN138PC00	8210.077	FIN028RS00			
	76,5	6502.016	FIN138PC05	8210.078	FIN028RS05			
	77	6502.017	FIN138PC10	8210.079	FIN028RS10			

		Nr.						ADATTABILE A: SUITABLE FOR:	
---	---	------------	---	---	---	---	---	--------------------------------	---

--	--	--	--	--	--	--	--	--	--

MB		1	GABBIA A RULLI - NEEDLE BEARING				3030.028	FIN3283GR
----	--	---	---------------------------------	--	--	--	----------	-----------





MB		1	CUSCINETTO A SFERA - BALL BEARING				3001.070	FIN3700BR
----	--	---	-----------------------------------	--	--	--	----------	-----------



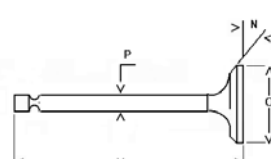

--	--	--	--	--	--	--	--	--	--

--	--	--	--	--	--	--	--	--	--

--	--	--	--	--	--	--	--	--	--

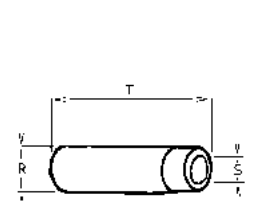
--	--	--	--	--	--	--	--	--	--

	IN EX		Nr.	O	P	M	N		ADATTABILE A: SUITABLE FOR:			
	IN		FS	1	32	7	94,1		45	A33	9652.016	FINA051
	EX		FN	1	28	7	93,8		45	A33	9685.022	FINS052

	IN EX		Nr.	R	S	T		ADATTABILE A: SUITABLE FOR:			
	IN		B	1	12,05	7,05		37	I	4845.028	FIN935ASA
	IN										
	EX		B	1	12,05	7,05		37	I	4845.028	FIN935ASA
EX											

Ricambi non originali per motori. Denominazioni e codici originali, sono riportati a puro titolo di riferimento.

13 - 14

rel. 1511

Non original engine parts. OEMs names and part numbers are for reference purpose only.

INTERMOTOR

IM 302	Cm³	CILINDRI CYLINDERS	ALESAGGIO BORE	CORSA STROKE	VERSIONE VERSION
	300	1	76	66	1176998 ←

	8180.187		1213.002	1213.056				
FIN049CGA	FIN049CGB		FIN955RT	FIN947RT				

 	ADATTABILE A: SUITABLE FOR:		Nr.	ENGINE KIT	ELECTRIC KIT
	4730.537	FIN392HG	1		
			1		
			1		



3700.277		5496.062		3730.041			
FIN707AF		FIN1100NF		FIN4300FE			







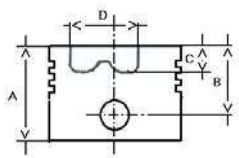

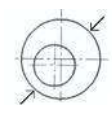
1526.026							
FIN6206KR STD							

Ricambi non originali per motori. Denominazioni e codici originali, sono riportati a puro titolo di riferimento.

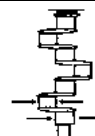
INTERMOTOR

IM 302	Cm³	CILINDRI CYLINDERS	ALESAGGIO BORE	CORSA STROKE	VERSIONE VERSION
	300	1	76	66	1176999 →

		TESTA HEAD	H09		3	2	TIPO TYPE	
		A	58		10	2		
		B	32,7		22	4		
		C						
		D						
	FIN986PN	E	55					
	8480.002	F	15					
	76	6502.015	FIN138PC00	8210.077	FIN028RS00			
	76,5	6502.016	FIN138PC05	8210.078	FIN028RS05			
	77	6502.017	FIN138PC10	8210.079	FIN028RS10			

		Nr.						ADATTABILE A: SUITABLE FOR:	
---	---	------------	---	---	---	---	---	--------------------------------	---

--	--	--	--	--	--	--	--	--	--

MB		2	CUSCINETTO A SFERA – BALL BEARING				3001.070	FIN3700BR
----	--	---	-----------------------------------	--	--	--	----------	-----------





--	--	--	--	--	--	--	--	--	--



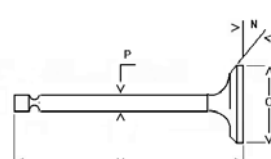

--	--	--	--	--	--	--	--	--	--

--	--	--	--	--	--	--	--	--	--

--	--	--	--	--	--	--	--	--	--

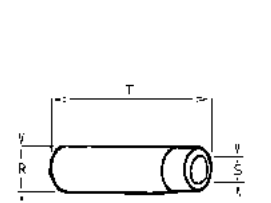
--	--	--	--	--	--	--	--	--	--

	IN EX		Nr.	O	P	M	N		ADATTABILE A: SUITABLE FOR:	
	IN	FS	1	32	7	94,1	45	A33	9652.016	FINA051
	EX	FN	1	28	7	93,8	45	A33	9685.022	FINS052

	IN EX		Nr.	R	S	T		ADATTABILE A: SUITABLE FOR:	
	IN	B	1	12,05	7,05	37	I	4845.028	FIN935ASA
	IN								
	EX	B	1	12,05	7,05	37	I	4845.028	FIN935ASA
EX									

Ricambi non originali per motori. Denominazioni e codici originali, sono riportati a puro titolo di riferimento.

15 - 14
rel. 1511

Non original engine parts. OEMs names and part numbers are for reference purpose only.

INTERMOTOR

IM 302	Cm³	CILINDRI CYLINDERS	ALESAGGIO BORE	CORSA STROKE	VERSIONE VERSION
	300	1	76	66	1176999 →

	8180.187		1213.002	1213.056				
FIN049CGA	FIN049CGB		FIN955RT	FIN947RT				

 	ADATTABILE A: SUITABLE FOR:		Nr.	ENGINE KIT	ELECTRIC KIT
	4730.537	FIN392HG	1		
			1		
			1		



3700.277		5496.062		3730.041			
FIN707AF		FIN1100NF		FIN4300FE			





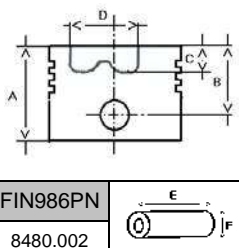

1526.026							
FIN6206KR STD							

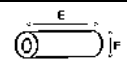
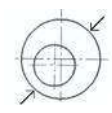
Ricambi non originali per motori. Denominazioni e codici originali, sono riportati a puro titolo di riferimento.

INTERMOTOR

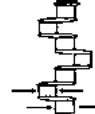
IM 350	Cm³	CILINDRI CYLINDERS	ALESAGGIO BORE	CORSA STROKE	VERSIONE VERSION
	349	1	82	66	1176998 ←

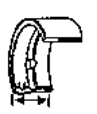
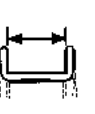
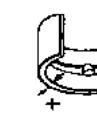
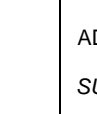
		TESTA HEAD	H09		3	2	TIPO TYPE	
		A	56		10	2		
		B	32,7		22	4		
		C						
		D						
		E	55					
FIN986PN 8480.002		F	15					
	82	6502.081	FIN140PC00	8211.197	FIN030RS00			
	82,5	6502.084	FIN140PC05	8211.198	FIN030RS05			
	83	6502.085	FIN140PC10	8211.199	FIN030RS10			

		Nr.							ADATTABILE A: SUITABLE FOR:	
---	---	------------	---	---	---	---	---	---	--------------------------------	---

--	--	--	--	--	--	--	--	--	--	--

MB		1	GABBIA A RULLI - NEEDLE BEARING					3030.028	FIN3283GR
----	--	---	---------------------------------	--	--	--	--	----------	-----------





MB		1	CUSCINETTO A SFERA - BALL BEARING					3001.070	FIN3700BR
----	--	---	-----------------------------------	--	--	--	--	----------	-----------



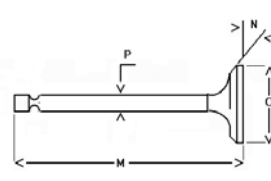

--	--	--	--	--	--	--	--	--	--	--

--	--	--	--	--	--	--	--	--	--	--

--	--	--	--	--	--	--	--	--	--	--

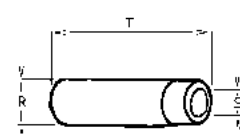
--	--	--	--	--	--	--	--	--	--	--

	IN EX		Nr.	O	P	M	N		ADATTABILE A: SUITABLE FOR:	
	IN	FS	1	32	7	94,1	45	A33	9652.016	FINA051
	EX	FN	1	28	7	93,8	45	A33	9685.022	FINS052

	IN EX		Nr.	R	S	T		ADATTABILE A: SUITABLE FOR:	
	IN	B	1	12,05	7,05	37	I	4845.028	FIN935ASA
	IN								
	EX	B	1	12,05	7,05	37	I	4845.028	FIN935ASA
EX									

Ricambi non originali per motori. Denominazioni e codici originali, sono riportati a puro titolo di riferimento.

17 - 14

rel. 1511

Non original engine parts. OEMs names and part numbers are for reference purpose only.

INTERMOTOR

IM 350	Cm³	CILINDRI CYLINDERS	ALESAGGIO BORE	CORSA STROKE	VERSIONE VERSION
	349	1	82	66	1176998 ←

	8180.188		1213.002	1213.056				
FIN904CGA	FIN904CGB		FIN955RT	FIN947RT				

 	ADATTABILE A: SUITABLE FOR:		Nr.	ENGINE KIT	ELECTRIC KIT
	4730.537	FIN392HG	1		
			1		
			1		

3700.277		5496.062			3730.041		
FIN707AF		FIN1100NF			FIN4300FE		

1526.026							
FIN6206KR STD							

Ricambi non originali per motori. Denominazioni e codici originali, sono riportati a puro titolo di riferimento.



18 - 14







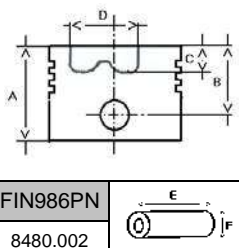

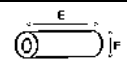
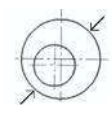
rel. 1511

Non original engine parts. OEMs names and part numbers are for reference purpose only.

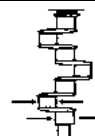
INTERMOTOR

IM 350	Cm³	CILINDRI CYLINDERS	ALESAGGIO BORE	CORSA STROKE	VERSIONE VERSION
	349	1	82	66	1176999 →

		TESTA HEAD	H09		3	2	TIPO TYPE	
		A	56		10	2		
		B	32,7		22	4		
		C						
		D						
		E	55					
FIN986PN 		F	15					
	82	6502.081	FIN140PC00	8211.197	FIN030RS00			
	82,5	6502.084	FIN140PC05	8211.198	FIN030RS05			
	83	6502.085	FIN140PC10	8211.199	FIN030RS10			

		Nr.						ADATTABILE A: SUITABLE FOR:	
---	---	------------	---	---	---	---	---	--	---

--	--	--	--	--	--	--	--	--	--

MB		2	CUSCINETTO A SFERA – BALL BEARING					3001.070	FIN3700BR
----	--	---	-----------------------------------	--	--	--	--	----------	-----------





--	--	--	--	--	--	--	--	--	--



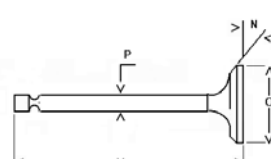

--	--	--	--	--	--	--	--	--	--

--	--	--	--	--	--	--	--	--	--

--	--	--	--	--	--	--	--	--	--

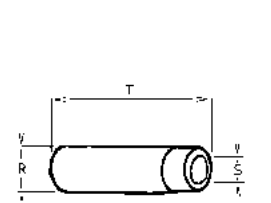
--	--	--	--	--	--	--	--	--	--

	IN EX		Nr.	O	P	M	N		ADATTABILE A: SUITABLE FOR:	
	IN	FS	1	32	7	94,1	45	A33	9652.016	FINA051
	EX	FN	1	28	7	93,8	45	A33	9685.022	FINS052

	IN EX		Nr.	R	S	T		ADATTABILE A: SUITABLE FOR:	
	IN	B	1	12,05	7,05	37	I	4845.028	FIN935ASA
	IN								
	EX	B	1	12,05	7,05	37	I	4845.028	FIN935ASA
EX									

Ricambi non originali per motori. Denominazioni e codici originali, sono riportati a puro titolo di riferimento.

19 - 14

rel. 1511

Non original engine parts. OEMs names and part numbers are for reference purpose only.

INTERMOTOR

IM 350	Cm³	CILINDRI CYLINDERS	ALESAGGIO BORE	CORSA STROKE	VERSIONE VERSION
	349	1	82	66	1176999 →

	8180.188		1213.002	1213.056				
FIN904CGA	FIN904CGB		FIN955RT	FIN947RT				

 	ADATTABILE A: SUITABLE FOR:		Nr.	ENGINE KIT	ELECTRIC KIT
	4730.537	FIN392HG	1		
			1		
			1		

3700.277		5496.062		3730.041			
FIN707AF		FIN1100NF		FIN4300FE			

1526.026							
FIN6206KR STD							

Ricambi non originali per motori. Denominazioni e codici originali, sono riportati a puro titolo di riferimento.



20 - 14





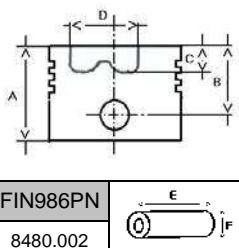

rel. 1511

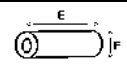
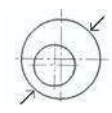
Non original engine parts. OEMs names and part numbers are for reference purpose only.

INTERMOTOR

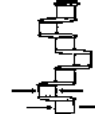
IM 352	Cm³	CILINDRI CYLINDERS	ALESAGGIO BORE	CORSA STROKE	VERSIONE VERSION
	349	1	82	66	1176998 ←

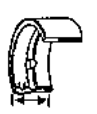
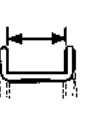
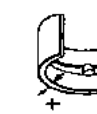
		TESTA HEAD	H09		3	2	TIPO TYPE	
		A	56		10	2		
		B	32,7		22	4		
		C						
		D						
		E	55					
FIN986PN		F	15					
8480.002								
	82	6502.081	FIN140PC00	8211.197	FIN030RS00			
	82,5	6502.084	FIN140PC05	8211.198	FIN030RS05			
	83	6502.085	FIN140PC10	8211.199	FIN030RS10			

		Nr.						ADATTABILE A: SUITABLE FOR:	
---	---	------------	---	---	---	---	---	--------------------------------	---

--	--	--	--	--	--	--	--	--	--

MB	1	GABBIA A RULLI - NEEDLE BEARING					3030.028	FIN3283GR
----	---	---------------------------------	--	--	--	--	----------	-----------





MB	1	CUSCINETTO A SFERA - BALL BEARING					3001.070	FIN3700BR
----	---	-----------------------------------	--	--	--	--	----------	-----------



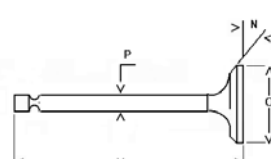

--	--	--	--	--	--	--	--	--	--

--	--	--	--	--	--	--	--	--	--

--	--	--	--	--	--	--	--	--	--

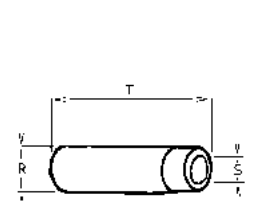
--	--	--	--	--	--	--	--	--	--

	IN		Nr.	O	P	M	N		ADATTABILE A: SUITABLE FOR:								
	IN								FS	1	32	7	94,1	45	A33	9652.016	FINA051
	EX								FN	1	28	7	93,8	45	A33	9685.022	FINS052

	IN		Nr.	R	S	T		ADATTABILE A: SUITABLE FOR:							
	IN							B	1	12,05	7,05	37	I	4845.028	FIN935ASA
	EX							B	1	12,05	7,05	37	I	4845.028	FIN935ASA
	EX														

Ricambi non originali per motori. Denominazioni e codici originali, sono riportati a puro titolo di riferimento.

21 - 14

rel. 1511

Non original engine parts. OEMs names and part numbers are for reference purpose only.

INTERMOTOR

IM 352	Cm³	CILINDRI CYLINDERS	ALESAGGIO BORE	CORSA STROKE	VERSIONE VERSION
	349	1	82	66	1176998 ←

	8180.188		1213.002	1213.056				
FIN904CGA	FIN904CGB		FIN955RT	FIN947RT				

 	ADATTABILE A: SUITABLE FOR:		Nr.	ENGINE KIT	ELECTRIC KIT
	4730.537	FIN392HG	1		
			1		
			1		

3700.277		5496.062		3730.041			
FIN707AF		FIN1100NF		FIN4300FE			

1526.026							
FIN6206KR STD							

Ricambi non originali per motori. Denominazioni e codici originali, sono riportati a puro titolo di riferimento.



22 - 14







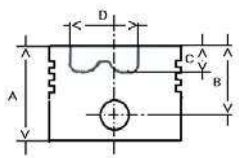

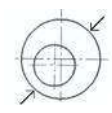
rel. 1511

Non original engine parts. OEMs names and part numbers are for reference purpose only.

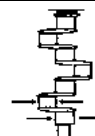
INTERMOTOR

IM 352	Cm³	CILINDRI CYLINDERS	ALESAGGIO BORE	CORSA STROKE	VERSIONE VERSION
	349	1	82	66	1176999 →

		TESTA HEAD	H09		3	2	TIPO TYPE	
		A	56		10	2		
		B	32,7		22	4		
		C						
		D						
	FIN986PN	E	55					
	8480.002	F	15					
	82	6502.081	FIN140PC00	8211.197	FIN030RS00			
	82,5	6502.084	FIN140PC05	8211.198	FIN030RS05			
	83	6502.085	FIN140PC10	8211.199	FIN030RS10			

		Nr.						ADATTABILE A: SUITABLE FOR:	
---	---	------------	---	---	---	---	---	--------------------------------	---

--	--	--	--	--	--	--	--	--	--

MB		2	CUSCINETTO A SFERA – BALL BEARING					3001.070	FIN3700BR
----	--	---	-----------------------------------	--	--	--	--	----------	-----------





--	--	--	--	--	--	--	--	--	--



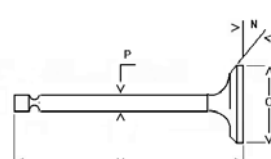

--	--	--	--	--	--	--	--	--	--

--	--	--	--	--	--	--	--	--	--

--	--	--	--	--	--	--	--	--	--

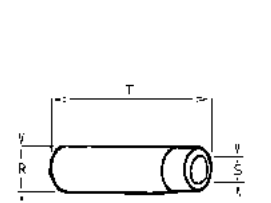
--	--	--	--	--	--	--	--	--	--

	IN EX		Nr.	O	P	M	N		ADATTABILE A: SUITABLE FOR:	
	IN	FS	1	32	7	94,1	45	A33	9652.016	FINA051
	EX	FN	1	28	7	93,8	45	A33	9685.022	FINS052

	IN EX		Nr.	R	S	T		ADATTABILE A: SUITABLE FOR:	
	IN	B	1	12,05	7,05	37	I	4845.028	FIN935ASA
	IN								
	EX	B	1	12,05	7,05	37	I	4845.028	FIN935ASA
EX									

Ricambi non originali per motori. Denominazioni e codici originali, sono riportati a puro titolo di riferimento.

23 - 14

rel. 1511

Non original engine parts. OEMs names and part numbers are for reference purpose only.

INTERMOTOR

IM 352	Cm³	CILINDRI CYLINDERS	ALESAGGIO BORE	CORSA STROKE	VERSIONE VERSION
	349	1	82	66	1176999 →

	8180.188		1213.002	1213.056				
FIN904CGA	FIN904CGB		FIN955RT	FIN947RT				

 	ADATTABILE A: SUITABLE FOR:		Nr.	ENGINE KIT	ELECTRIC KIT
	4730.537	FIN392HG	1		
			1		
			1		

3700.277		5496.062		3730.041			
FIN707AF		FIN1100NF		FIN4300FE			

1526.026							
FIN6206KR STD							

Ricambi non originali per motori. Denominazioni e codici originali, sono riportati a puro titolo di riferimento.



24 - 14





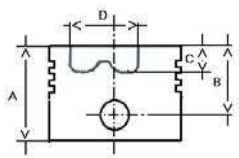

rel. 1511

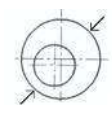
Non original engine parts. OEMs names and part numbers are for reference purpose only.

INTERMOTOR

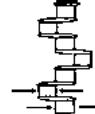
IM 359	Cm³	CILINDRI CYLINDERS	ALESAGGIO BORE	CORSA STROKE	VERSIONE VERSION
	349	1	82	66	1176998 ←

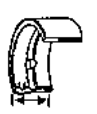
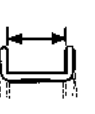
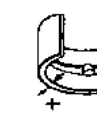
		TESTA HEAD	H09		3	2	TIPO TYPE	
		A	56		10	2		
		B	32,7		22	4		
		C						
		D						
	FIN986PN	E	55					
	8480.002	F	15					
	82	6502.081	FIN140PC00	8211.197	FIN030RS00			
	82,5	6502.084	FIN140PC05	8211.198	FIN030RS05			
	83	6502.085	FIN140PC10	8211.199	FIN030RS10			

		Nr.						ADATTABILE A: SUITABLE FOR:	
---	---	------------	---	---	---	---	---	--------------------------------	---

--	--	--	--	--	--	--	--	--	--

MB		1	GABBIA A RULLI - NEEDLE BEARING				3030.028	FIN3283GR
----	--	---	---------------------------------	--	--	--	----------	-----------





MB		1	CUSCINETTO A SFERA - BALL BEARING				3001.070	FIN3700BR
----	--	---	-----------------------------------	--	--	--	----------	-----------



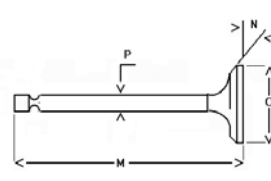

--	--	--	--	--	--	--	--	--	--

--	--	--	--	--	--	--	--	--	--

--	--	--	--	--	--	--	--	--	--

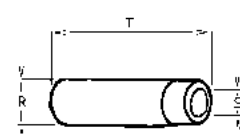
--	--	--	--	--	--	--	--	--	--

	IN EX		Nr.	O	P	M	N		ADATTABILE A: SUITABLE FOR:	
	IN	FS	1	32	7	94,1	45	A33	9652.016	FINA051
	EX	FN	1	28	7	93,8	45	A33	9685.022	FINS052

	IN EX		Nr.	R	S	T		ADATTABILE A: SUITABLE FOR:	
	IN	B	1	12,05	7,05	37	I	4845.028	FIN935ASA
	IN								
	EX	B	1	12,05	7,05	37	I	4845.028	FIN935ASA
EX									

Ricambi non originali per motori. Denominazioni e codici originali, sono riportati a puro titolo di riferimento.

25 - 14
rel. 1511

Non original engine parts. OEMs names and part numbers are for reference purpose only.

INTERMOTOR

IM 359	Cm³	CILINDRI CYLINDERS	ALESAGGIO BORE	CORSA STROKE	VERSIONE VERSION
	349	1	82	66	1176998 ←

	8180.193		1213.002	1213.056				
FIN905CGA	FIN905CGB		FIN955RT	FIN947RT				

 	ADATTABILE A: SUITABLE FOR:		Nr.	ENGINE KIT	ELECTRIC KIT
	4730.537	FIN392HG	1		
			1		
			1		

3700.277		5496.062		3730.049			
FIN707AF		FIN1100NF		FIN4301FE			

1526.026							
FIN6206KR STD							

Ricambi non originali per motori. Denominazioni e codici originali, sono riportati a puro titolo di riferimento.



26 - 14







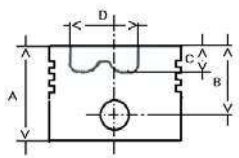

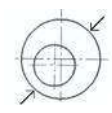
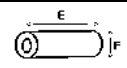
rel. 1511

Non original engine parts. OEMs names and part numbers are for reference purpose only.

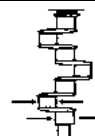
INTERMOTOR

IM 359	Cm³	CILINDRI CYLINDERS	ALESAGGIO BORE	CORSA STROKE	VERSIONE VERSION
	349	1	82	66	1176999 →

		TESTA HEAD	H09		3	2	TIPO TYPE	
					10	2		
					22	4		
	FIN986PN 8480.002		E	55	8211.197	FIN030RS00		
	82	6502.081	FIN140PC00		8211.198	FIN030RS05		
	82,5	6502.084	FIN140PC05		8211.199	FIN030RS10		
	83	6502.085	FIN140PC10					

		Nr.						ADATTABILE A: SUITABLE FOR:	
---	---	------------	---	---	---	---	---	--------------------------------	---

--	--	--	--	--	--	--	--	--	--

MB		2	CUSCINETTO A SFERA – BALL BEARING					3001.070	FIN3700BR
----	--	---	-----------------------------------	--	--	--	--	----------	-----------





--	--	--	--	--	--	--	--	--	--



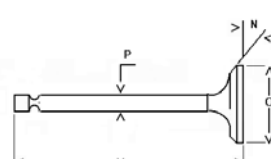

--	--	--	--	--	--	--	--	--	--

--	--	--	--	--	--	--	--	--	--

--	--	--	--	--	--	--	--	--	--

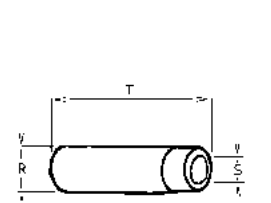
--	--	--	--	--	--	--	--	--	--

	IN EX		Nr.	O	P	M	N		ADATTABILE A: SUITABLE FOR:	
	IN	FS	1	32	7	94,1	45	A33	9652.016	FINA051
	EX	FN	1	28	7	93,8	45	A33	9685.022	FINS052

	IN EX		Nr.	R	S	T		ADATTABILE A: SUITABLE FOR:	
	IN	B	1	12,05	7,05	37	I	4845.028	FIN935ASA
	IN								
	EX	B	1	12,05	7,05	37	I	4845.028	FIN935ASA
EX									

Ricambi non originali per motori. Denominazioni e codici originali, sono riportati a puro titolo di riferimento.

27 - 14

rel. 1511

Non original engine parts. OEMs names and part numbers are for reference purpose only.

INTERMOTOR

IM 359	Cm³	CILINDRI CYLINDERS	ALESAGGIO BORE	CORSA STROKE	VERSIONE VERSION
	349	1	82	66	1176999 →

	8180.193		1213.002	1213.056				
FIN905CGA	FIN905CGB		FIN955RT	FIN947RT				

 ADATTABILE A: SUITABLE FOR:	 FIN392HG	Nr.	ENGINE KIT	ELECTRIC KIT
		1		
		1		
		1		



3700.277		5496.062		3730.049			
FIN707AF		FIN1100NF		FIN4301FE			







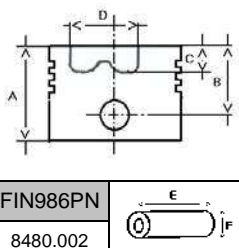

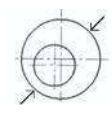
1526.026							
FIN6206KR STD							

Ricambi non originali per motori. Denominazioni e codici originali, sono riportati a puro titolo di riferimento.

INTERMOTOR

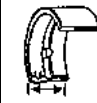
LA 250	Cm³	CILINDRI CYLINDERS	ALESAGGIO BORE	CORSA STROKE	VERSIONE VERSION
	252	1	72	62	

		TESTA HEAD	H09		10	2	TIPO TYPE	
		A			10	2		
		B	34,7		17	4		
		C						
		D						
	FIN986PN	E	55					
	8480.002	F	15					
	72	6500.099	FIN137PC00	8210.025	FIN027RS00			
	72,5	6501.049	FIN137PC05	8210.026	FIN027RS05			
	73	6501.050	FIN137PC10	8210.027	FIN027RS10			

		Nr.						ADATTABILE A: SUITABLE FOR:	
---	---	------------	---	---	---	---	---	--------------------------------	---

CR	AL	1	28,00	31,00	17,00		STD - 025 - 050 075 - 100	1640.035	FIN662CR STD
----	----	---	-------	-------	-------	--	------------------------------	----------	--------------

--	--	--	--	--	--	--	--	--	--





--	--	--	--	--	--	--	--	--	--



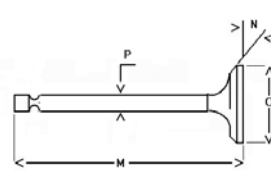

--	--	--	--	--	--	--	--	--	--

--	--	--	--	--	--	--	--	--	--

--	--	--	--	--	--	--	--	--	--

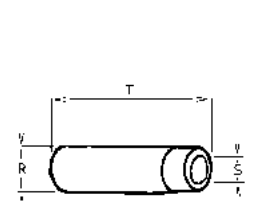
--	--	--	--	--	--	--	--	--	--

	IN EX		Nr.	O	P	M	N		ADATTABILE A: SUITABLE FOR:			
	IN		FS	1	32	7	94,1		45	A33	9652.016	FINA051
	EX		FN	1	28	7	93,8		45	A33	9685.022	FINS052

	IN EX		Nr.	R	S	T		ADATTABILE A: SUITABLE FOR:			
	IN		B	1	12,05	7,05		37	I	4845.028	FIN935ASA
	IN										
	EX		B	1	12,05	7,05		37	I	4845.028	FIN935ASA
EX											

Ricambi non originali per motori. Denominazioni e codici originali, sono riportati a puro titolo di riferimento.

29 - 14
rel. 1511

Non original engine parts. OEMs names and part numbers are for reference purpose only.

INTERMOTOR

LA 250	Cm³	CILINDRI CYLINDERS	ALESAGGIO BORE	CORSA STROKE	VERSIONE VERSION
	252	1	72	62	

	8180.034		1213.002	1213.056				
FIN998CGA	FIN998CGB		FIN955RT	FIN947RT				

 	ADATTABILE A: SUITABLE FOR:		Nr.	ENGINE KIT	ELECTRIC KIT
	4730.014	FIN393HG	1		
			1		
			1		

Ricambi non originali per motori. Denominazioni e codici originali, sono riportati a puro titolo di riferimento.



30 - 14







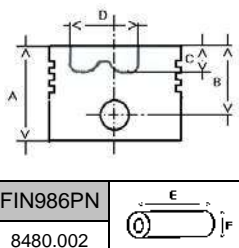

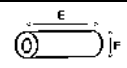
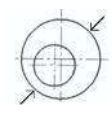
rel. 1511

Non original engine parts. OEMs names and part numbers are for reference purpose only.

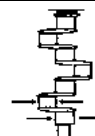
INTERMOTOR

LAP 250	Cm³	CILINDRI CYLINDERS	ALESAGGIO BORE	CORSA STROKE	VERSIONE VERSION
	252	1	72	62	

		TESTA HEAD	H09		10	2	TIPO TYPE	
		A			10	2		
		B	34,7		17	4		
		C						
		D						
		E	55					
FIN986PN 8480.002		F	15					
	72	6500.099	FIN137PC00	8210.025	FIN027RS00			
	72,5	6501.049	FIN137PC05	8210.026	FIN027RS05			
	73	6501.050	FIN137PC10	8210.027	FIN027RS10			

		Nr.						ADATTABILE A: SUITABLE FOR:	
---	---	------------	---	---	---	---	---	--------------------------------	---

CR	AL	1	28,00	31,00	17,00		STD - 025 - 050 075 - 100	1640.035	FIN662CR STD
----	----	---	-------	-------	-------	--	------------------------------	----------	--------------

--	--	--	--	--	--	--	--	--	--





--	--	--	--	--	--	--	--	--	--



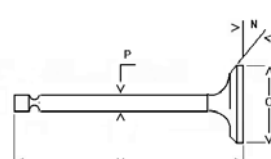

--	--	--	--	--	--	--	--	--	--

--	--	--	--	--	--	--	--	--	--

--	--	--	--	--	--	--	--	--	--

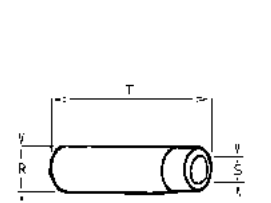
--	--	--	--	--	--	--	--	--	--

	IN EX		Nr.	O	P	M	N		ADATTABILE A: SUITABLE FOR:			
	IN		FS	1	32	7	94,1		45	A33	9652.016	FINA051
	EX		FN	1	28	7	93,8		45	A33	9685.022	FINS052

	IN EX		Nr.	R	S	T		ADATTABILE A: SUITABLE FOR:				
	IN		B	1	12,05	7,05		37	I	4845.028	FIN935ASA	
	IN											
	EX		B	1	12,05	7,05		37	I	4845.028	FIN935ASA	
EX												

Ricambi non originali per motori. Denominazioni e codici originali, sono riportati a puro titolo di riferimento.

31 - 14

rel. 1511

Non original engine parts. OEMs names and part numbers are for reference purpose only.

INTERMOTOR

LAP 250	Cm³	CILINDRI CYLINDERS	ALESAGGIO BORE	CORSA STROKE	VERSIONE VERSION
	252	1	72	62	

	8180.034		1213.002	1213.056				
FIN998CGA	FIN998CGB		FIN955RT	FIN947RT				

 ADATTABILE A: SUITABLE FOR: 4730.014	 FIN393HG	Nr.		ENGINE KIT		ELECTRIC KIT	
		1					
		1					
		1					

--	--	--	--	--	--	--	--

--	--	--	--	--	--	--	--

--	--	--	--	--	--	--	--



--	--	--	--	--	--	--	--







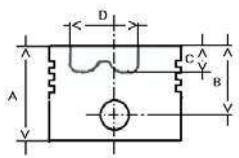

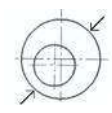
--	--	--	--	--	--	--	--

Ricambi non originali per motori. Denominazioni e codici originali, sono riportati a puro titolo di riferimento.

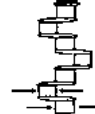
INTERMOTOR

LA 300	Cm³	CILINDRI CYLINDERS	ALESAGGIO BORE	CORSA STROKE	VERSIONE VERSION
	300	1	76	66	

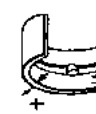
		TESTA HEAD	H09		3	2	TIPO TYPE	
		A	58		10	2		
		B	32,7		22	4		
		C						
		D						
		E	55					
		F	15					
	FIN986PN							
	8480.002							
	76	6502.015	FIN138PC00	8210.077	FIN028RS00			
	76,5	6502.016	FIN138PC05	8210.078	FIN028RS05			
	77	6502.017	FIN138PC10	8210.079	FIN028RS10			

		Nr.						ADATTABILE A: SUITABLE FOR:	
---	---	------------	---	---	---	---	---	--------------------------------	---

CR	AL	1	28,00	31,00	17,00		STD - 025 - 050 075 - 100	1640.035	FIN662CR STD
----	----	---	-------	-------	-------	--	------------------------------	----------	--------------

--	--	--	--	--	--	--	--	--	--





--	--	--	--	--	--	--	--	--	--



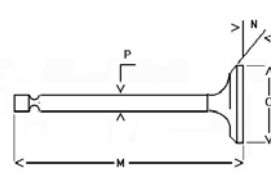

--	--	--	--	--	--	--	--	--	--

--	--	--	--	--	--	--	--	--	--

--	--	--	--	--	--	--	--	--	--

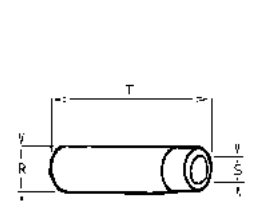
--	--	--	--	--	--	--	--	--	--

	IN EX		Nr.	O	P	M	N		ADATTABILE A: SUITABLE FOR:			
	IN		FS	1	32	7	94,1		45	A33	9652.016	FINA051
	EX		FN	1	28	7	93,8		45	A33	9685.022	FINS052

	IN EX		Nr.	R	S	T		ADATTABILE A: SUITABLE FOR:			
	IN		B	1	12,05	7,05		37	I	4845.028	FIN935ASA
	IN										
	EX		B	1	12,05	7,05		37	I	4845.028	FIN935ASA
EX											

Ricambi non originali per motori. Denominazioni e codici originali, sono riportati a puro titolo di riferimento.

33 - 14

rel. 1511

Non original engine parts. OEMs names and part numbers are for reference purpose only.

INTERMOTOR

LA 300	Cm³	CILINDRI CYLINDERS	ALESAGGIO BORE	CORSA STROKE	VERSIONE VERSION
	300	1	76	66	

	8180.042		1213.002	1213.056				
FIN999CGA	FIN999CGB		FIN955RT	FIN947RT				

 	ADATTABILE A: SUITABLE FOR:		Nr.	ENGINE KIT	ELECTRIC KIT
	4730.028	FIN389HG	1		
			1		
			1		

Ricambi non originali per motori. Denominazioni e codici originali, sono riportati a puro titolo di riferimento.





34 - 14





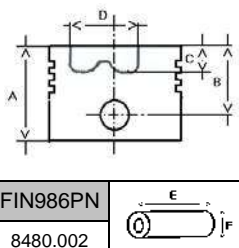

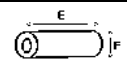

rel. 1511

Non original engine parts. OEMs names and part numbers are for reference purpose only.

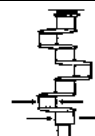
INTERMOTOR

LAP 300	Cm³	CILINDRI CYLINDERS	ALESAGGIO BORE	CORSA STROKE	VERSIONE VERSION
	300	1	76	66	

		TESTA HEAD	H09		3	2	TIPO TYPE	
		A	58		10	2		
		B	32,7		22	4		
		C						
		D						
		E	55					
FIN986PN		F	15					
8480.002								
	76	6502.015	FIN138PC00	8210.077	FIN028RS00			
	76,5	6502.016	FIN138PC05	8210.078	FIN028RS05			
	77	6502.017	FIN138PC10	8210.079	FIN028RS10			

		Nr.						ADATTABILE A: SUITABLE FOR:	
---	---	------------	---	---	---	---	---	--------------------------------	---

CR	AL	1	28,00	31,00	17,00		STD - 025 - 050 075 - 100	1640.035	FIN662CR STD
----	----	---	-------	-------	-------	--	------------------------------	----------	--------------

--	--	--	--	--	--	--	--	--	--





--	--	--	--	--	--	--	--	--	--



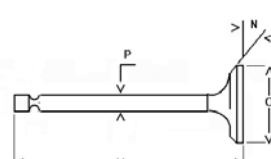

--	--	--	--	--	--	--	--	--	--

--	--	--	--	--	--	--	--	--	--

--	--	--	--	--	--	--	--	--	--

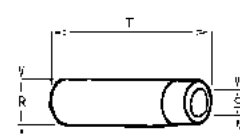
--	--	--	--	--	--	--	--	--	--

	IN EX		Nr.	O	P	M	N		ADATTABILE A: SUITABLE FOR:			
	IN		FS	1	32	7	94,1		45	A33	9652.016	FINA051
	EX		FN	1	28	7	93,8		45	A33	9685.022	FINS052

	IN EX		Nr.	R	S	T		ADATTABILE A: SUITABLE FOR:			
	IN		B	1	12,05	7,05		37	I	4845.028	FIN935ASA
	IN										
	EX		B	1	12,05	7,05		37	I	4845.028	FIN935ASA
EX											

Ricambi non originali per motori. Denominazioni e codici originali, sono riportati a puro titolo di riferimento.

35 - 14
rel. 1511

Non original engine parts. OEMs names and part numbers are for reference purpose only.

INTERMOTOR

LAP 300	Cm³	CILINDRI CYLINDERS	ALESAGGIO BORE	CORSA STROKE	VERSIONE VERSION
	300	1	76	66	

	8180.042		1213.002	1213.056				
FIN999CGA	FIN999CGB		FIN955RT	FIN947RT				

 	ADATTABILE A: SUITABLE FOR:		Nr.	ENGINE KIT	ELECTRIC KIT
	4730.028	FIN389HG	1		
			1		
			1		

Ricambi non originali per motori. Denominazioni e codici originali, sono riportati a puro titolo di riferimento.



36 - 14







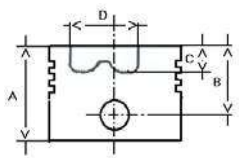

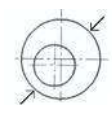
rel. 1511

Non original engine parts. OEMs names and part numbers are for reference purpose only.

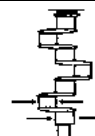
INTERMOTOR

LA 490	Cm³	CILINDRI CYLINDERS	ALESAGGIO BORE	CORSA STROKE	VERSIONE VERSION
	487	1	88	80	

		TESTA HEAD A B 44 C 5 D 68,5 E 65 F 18		3	2	TIPO TYPE	
				10	2		
	88	6500.081	FIN166PC00	8210.028	FIN044RS00		
	88,5	6500.082	FIN166PC05	8210.029	FIN044RS05		
	89	6500.083	FIN166PC10	8210.030	FIN044RS10		

		Nr.						ADATTABILE A: SUITABLE FOR:	
---	---	------------	---	---	---	---	---	--------------------------------	---

CR	AL	1	35,00	38,11	27,03		STD - 025	1640.030	FIN080CR STD
----	----	---	-------	-------	-------	--	-----------	----------	--------------

--	--	--	--	--	--	--	--	--	--





--	--	--	--	--	--	--	--	--	--



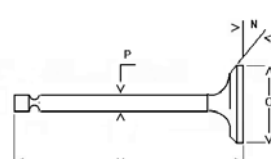

--	--	--	--	--	--	--	--	--	--

PB	BM	1	18,00	20,02	25,12		SEMIF.	1630.009	FIN612PB
----	----	---	-------	-------	-------	--	--------	----------	----------

--	--	--	--	--	--	--	--	--	--

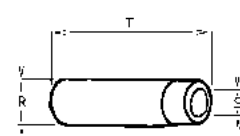
--	--	--	--	--	--	--	--	--	--

	IN EX		Nr.	O	P	M	N		ADATTABILE A: SUITABLE FOR:								
	IN								FS	1	42	8	89	45	A1	9652.011	FINA055
	EX								FN	1	34	10	89	45	A1	9685.011	FINS056

	IN EX		Nr.	R	S	T		ADATTABILE A: SUITABLE FOR:							
	IN							G	1	14,05	8,03	41	L	4845.019	FIN915AA
	IN							G		14,25	8,03	41	L		FIN915AB
	EX							B	1	14,05	10,05	43,5	L	4845.021	FIN916SA
	EX							B		14,25	10,05	43,5	L		FIN916SB

Ricambi non originali per motori. Denominazioni e codici originali, sono riportati a puro titolo di riferimento.

37 - 14

rel. 1511

Non original engine parts. OEMs names and part numbers are for reference purpose only.

INTERMOTOR

LA 490	Cm³	CILINDRI CYLINDERS	ALESAGGIO BORE	CORSA STROKE	VERSIONE VERSION
	487	1	88	80	

	8180.018		1210.045	1210.024				
FIN972CGA	FIN972CGB		FIN1003RT	FIN954RT				

 ADATTABILE A: SUITABLE FOR:	 FIN388HG	Nr.		ENGINE KIT		ELECTRIC KIT	
		1					
		1					
		1					
4730.009							



3700.101		5496.111	5496.110				
FIN101AF		FIN112NF	FIN070CFA				







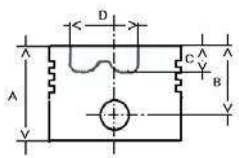

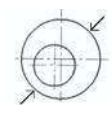
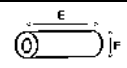
6585.006							
FIN006FP							

Ricambi non originali per motori. Denominazioni e codici originali, sono riportati a puro titolo di riferimento.

INTERMOTOR

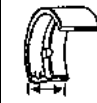
LAP 490	Cm³	CILINDRI CYLINDERS	ALESAGGIO BORE	CORSA STROKE	VERSIONE VERSION
	487	1	88	80	

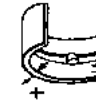
		TESTA HEAD A B 42 C 17 D 78,2 E 65 F 18		3	2	TIPO TYPE		
				10	2			
	FIN988PN			17	4,5			
	88			6501.004	8210.028			FIN044RS00
	88,5			6501.005	8210.029			FIN044RS05
	89	6501.006	FIN165PC10	8210.030	FIN044RS10			

		Nr.						ADATTABILE A: SUITABLE FOR:	
---	---	------------	---	---	---	---	---	--------------------------------	---

CR	AL	1	35,00	38,11	27,03		STD - 025	1640.030	FIN080CR STD
----	----	---	-------	-------	-------	--	-----------	----------	--------------

--	--	--	--	--	--	--	--	--	--





--	--	--	--	--	--	--	--	--	--



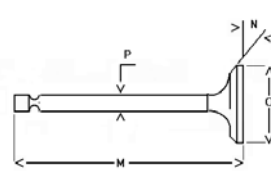

--	--	--	--	--	--	--	--	--	--

PB	BM	1	18,00	20,02	25,12		SEMIF.	1630.009	FIN612PB
----	----	---	-------	-------	-------	--	--------	----------	----------

--	--	--	--	--	--	--	--	--	--

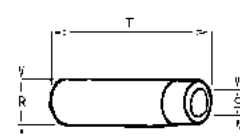
--	--	--	--	--	--	--	--	--	--

	IN EX		Nr.	O	P	M	N		ADATTABILE A: SUITABLE FOR:			
	IN		FS	1	42	8	89		45	A1	9652.011	FINA055
	EX		FN	1	34	10	89		45	A1	9685.011	FINS056

	IN EX		Nr.	R	S	T		ADATTABILE A: SUITABLE FOR:			
	IN		G	1	14,05	8,03		41	L	4845.019	FIN915AA
	IN		G		14,25	8,03		41	L		FIN915AB
	EX		B	1	14,05	10,05		43,5	L	4845.021	FIN916SA
	EX		B		14,25	10,05		43,5	L		FIN916SB

Ricambi non originali per motori. Denominazioni e codici originali, sono riportati a puro titolo di riferimento.

39 - 14

rel. 1511

Non original engine parts. OEMs names and part numbers are for reference purpose only.

INTERMOTOR

LAP 490	Cm³	CILINDRI CYLINDERS	ALESAGGIO BORE	CORSA STROKE	VERSIONE VERSION
	487	1	88	80	

	8180.018		1210.045	1210.024				
FIN972CGA	FIN972CGB		FIN1003RT	FIN954RT				

 ADATTABILE A: SUITABLE FOR:	 FIN388HG	Nr.		ENGINE KIT		ELECTRIC KIT	
		1					
		1					
		1					
4730.009							

3700.101		5496.111	5496.110				
FIN101AF		FIN112NF	FIN070CFA				





6585.006							
FIN006FP							





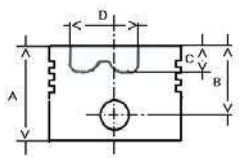

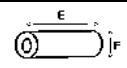

Ricambi non originali per motori. Denominazioni e codici originali, sono riportati a puro titolo di riferimento.

LOMBARDINI

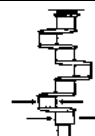
Benzina *Petrol*

LGA 184	Cm³	CILINDRI CYLINDERS	ALESAGGIO BORE	CORSA STROKE	VERSIONE VERSION
	181	1	66	53	1139537 →

 	TESTA HEAD	H09		TIPO TYPE	
	A				
	B				
	C				
	D				
	FIN986PN				E
8480.002		F	15		
	66	6500.893	FIN594PC00	8211.074	FIN595RS00
	66,5	6500.894	FIN594PC05	8211.075	FIN595RS05
	67	6500.895	FIN594PC10	8211.076	FIN595RS10

		Nr.						ADATTABILE A: SUITABLE FOR:	
---	---	------------	---	---	---	---	---	--------------------------------	---

--	--	--	--	--	--	--	--	--	--

MB		2	GABBIA A RULLI - NEEDLE BEARING					3001.082	FIN2810GR
----	--	---	---------------------------------	--	--	--	--	----------	-----------





--	--	--	--	--	--	--	--	--	--



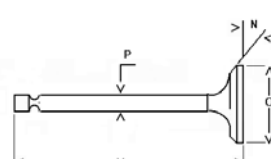

--	--	--	--	--	--	--	--	--	--

--	--	--	--	--	--	--	--	--	--

--	--	--	--	--	--	--	--	--	--

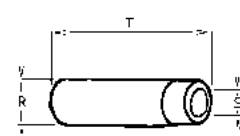
--	--	--	--	--	--	--	--	--	--

	IN EX		Nr.	O	P	M	N		ADATTABILE A: SUITABLE FOR:	
	IN	FS	1	28	7	89,3	45	A33	9652.044	FINA140
	EX	FN	1	28	7	89,3	45	A33	9652.045	FINS141

	IN EX		Nr.	R	S	T		ADATTABILE A: SUITABLE FOR:	
	IN	G	1					4845.202	FIN1658AA
	IN								
	EX	G	1					4845.080	FIN1657SA
EX									

Ricambi non originali per motori. Denominazioni e codici originali, sono riportati a puro titolo di riferimento.

41 - 14

rel. 1511

Non original engine parts. OEMs names and part numbers are for reference purpose only.

LGA 184	Cm³	CILINDRI CYLINDERS	ALESAGGIO BORE	CORSA STROKE	VERSIONE VERSION
	181	1	66	53	1139537 →

	8180.191		1213.205	1210.024				
FIN907CGA	FIN907CGB		FIN3250RT	FIN954RT				

 ADATTABILE A: SUITABLE FOR: 		Nr.	ENGINE KIT	ELECTRIC KIT
	4730.528	1		
		1		
		1		
	FIN6290HG			

3700.398		2175.156		3730.049			
FIN708AF		FIN725NF		FIN4301FE			

1526.126							
FIN6216KR STD							

LOMBARDINI

Benzina *Petrol*

LKA 184	Cm³	CILINDRI CYLINDERS	ALESAGGIO BORE	CORSA STROKE	VERSIONE VERSION
	181	1	66	53	1139537 →

	TESTA HEAD		H09		TIPO TYPE
	A				
	B				
	C				
	D				
	E		55		
FIN986PN			F	15	
8480.002					
	66	6500.893	FIN594PC00	8211.074	FIN595RS00
	66,5	6500.894	FIN594PC05	8211.075	FIN595RS05
	67	6500.895	FIN594PC10	8211.076	FIN595RS10

		Nr.						ADATTABILE A: SUITABLE FOR:	
--	--	------------	--	--	--	--	--	--------------------------------	--

--	--	--	--	--	--	--	--	--	--

MB	2	GABBIA A RULLI - NEEDLE BEARING					3001.082	FIN2810GR
----	---	---------------------------------	--	--	--	--	----------	-----------

--	--	--	--	--	--	--	--	--	--

--	--	--	--	--	--	--	--	--	--

--	--	--	--	--	--	--	--	--	--

--	--	--	--	--	--	--	--	--	--

--	--	--	--	--	--	--	--	--	--

	IN		Nr.	O	P	M	N		ADATTABILE A: SUITABLE FOR:								
	IN								FS	1	28	7	89,3	45	A33	9652.044	FINA140
	EX								FN	1	28	7	89,3	45	A33	9652.045	FINS141

	IN		Nr.	R	S	T		ADATTABILE A: SUITABLE FOR:							
	IN							G	1				4845.202	FIN1658AA	
	IN														
	EX							G	1				4845.080	FIN1657SA	
EX															

Ricambi non originali per motori. Denominazioni e codici originali, sono riportati a puro titolo di riferimento.

43 - 14

rel. 1511

Non original engine parts. OEMs names and part numbers are for reference purpose only.

LKA 184	Cm³	CILINDRI CYLINDERS	ALESAGGIO BORE	CORSA STROKE	VERSIONE VERSION
	181	1	66	53	1139537 →

	8180.191		1213.205	1210.024				
FIN907CGA	FIN907CGB		FIN3250RT	FIN954RT				

 ↓ === ↑	ADATTABILE A: SUITABLE FOR:		Nr.	ENGINE KIT	ELECTRIC KIT
	4730.528	FIN6290HG	1		
			1		
			1		





3700.398		2175.156		3730.049			
FIN708AF		FIN725NF		FIN4301FE			





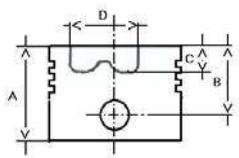

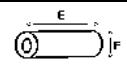

1526.126							
FIN6216KR STD							

LOMBARDINI

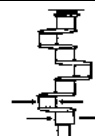
Benzina *Petrol*

LGA 225	Cm³	CILINDRI CYLINDERS	ALESAGGIO BORE	CORSA STROKE	VERSIONE VERSION
	216	1	72	53	1139537 →

 	TESTA HEAD	H09		TIPO TYPE	
	A				
	B				
	C				
	D				
	FIN986PN				E
8480.002		F	15		
	72	6500.896	FIN596PC00	8211.085	FIN597RS00
	72,5	6500.897	FIN596PC05	8211.086	FIN597RS05
	73	6500.898	FIN596PC10	8211.087	FIN597RS10

		Nr.						ADATTABILE A: SUITABLE FOR:	
---	---	------------	---	---	---	---	---	--------------------------------	---

--	--	--	--	--	--	--	--	--	--

MB	2	GABBIA A RULLI - NEEDLE BEARING					3001.082	FIN2810GR
----	---	---------------------------------	--	--	--	--	----------	-----------





--	--	--	--	--	--	--	--	--	--



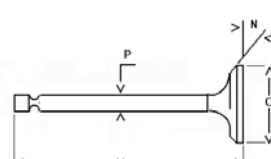

--	--	--	--	--	--	--	--	--	--

--	--	--	--	--	--	--	--	--	--

--	--	--	--	--	--	--	--	--	--

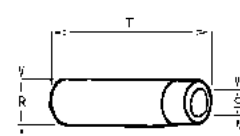
--	--	--	--	--	--	--	--	--	--

	IN EX		Nr.	O	P	M	N		ADATTABILE A: SUITABLE FOR:	
	IN	FS	1	28	7	89,3	45	A33	9652.044	FINA140
	EX	FN	1	28	7	89,3	45	A33	9652.045	FINS141

	IN EX		Nr.	R	S	T		ADATTABILE A: SUITABLE FOR:	
	IN	G	1					4845.202	FIN1658AA
	IN								
	EX	G	1					4845.080	FIN1657SA
EX									

Ricambi non originali per motori. Denominazioni e codici originali, sono riportati a puro titolo di riferimento.

45 - 14

rel. 1511

Non original engine parts. OEMs names and part numbers are for reference purpose only.

LOMBARDINI

Benzina *Petrol*

LGA 225	Cm³	CILINDRI CYLINDERS	ALESAGGIO BORE	CORSA STROKE	VERSIONE VERSION
	216	1	72	53	1139537 →

	8180.192		1213.205	1210.024				
FIN908CGA	FIN908CGB		FIN3250RT	FIN954RT				

 ADATTABILE A: SUITABLE FOR: 	 FIN6291HG	Nr.	ENGINE KIT		ELECTRIC KIT 	
			1			
			1			
			1			

3700.398		2175.156		3730.049			
FIN708AF		FIN725NF		FIN4301FE			

1526.126							
FIN6216KR STD							

Ricambi non originali per motori. Denominazioni e codici originali, sono riportati a puro titolo di riferimento.

46 - 14

rel. 1511

Non original engine parts. OEMs names and part numbers are for reference purpose only.

LKA 225	Cm³	CILINDRI CYLINDERS	ALESAGGIO BORE	CORSA STROKE	VERSIONE VERSION
	216	1	72	53	1139537 →

	TESTA HEAD		H09		TIPO TYPE
	A				
	B				
	C				
	D				
	E		55		
FIN986PN			F	15	
8480.002					
	72	6500.896	FIN596PC00	8211.085	FIN597RS00
	72,5	6500.897	FIN596PC05	8211.086	FIN597RS05
	73	6500.898	FIN596PC10	8211.087	FIN597RS10

		Nr.						ADATTABILE A: SUITABLE FOR:	
--	--	------------	--	--	--	--	--	--------------------------------	--

--	--	--	--	--	--	--	--	--	--

MB	2	GABBIA A RULLI - NEEDLE BEARING					3001.082	FIN2810GR
----	---	---------------------------------	--	--	--	--	----------	-----------

--	--	--	--	--	--	--	--	--	--

--	--	--	--	--	--	--	--	--	--

--	--	--	--	--	--	--	--	--	--

--	--	--	--	--	--	--	--	--	--

--	--	--	--	--	--	--	--	--	--

	IN		Nr.	O	P	M	N		ADATTABILE A: SUITABLE FOR:								
	IN								FS	1	28	7	89,3	45	A33	9652.044	FINA140
	EX								FN	1	28	7	89,3	45	A33	9652.045	FINS141

	IN		Nr.	R	S	T		ADATTABILE A: SUITABLE FOR:							
	IN							G	1				4845.202	FIN1658AA	
	IN														
	EX							G	1				4845.080	FIN1657SA	
EX															

LKA 225	Cm³	CILINDRI CYLINDERS	ALESAGGIO BORE	CORSA STROKE	VERSIONE VERSION
	216	1	72	53	1139537 →

	8180.192		1213.205	1210.024				
FIN908CGA	FIN908CGB		FIN3250RT	FIN954RT				

 ↓ === ↑	ADATTABILE A: SUITABLE FOR:		Nr.	ENGINE KIT	ELECTRIC KIT
	4730.529	FIN6291HG	1		
			1		
			1		



3700.398		2175.156		3730.049			
FIN708AF		FIN725NF		FIN4301FE			







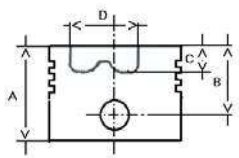

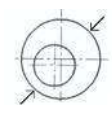
1526.126							
FIN6216KR STD							

LOMBARDINI

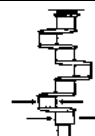
Benzina *Petrol*

LGA 226	Cm³	CILINDRI CYLINDERS	ALESAGGIO BORE	CORSA STROKE	VERSIONE VERSION
	220	1	72	54	

 	TESTA HEAD	H09		3	2	TIPO TYPE	
	A			10	2		
	B	24		22	4		
	C						
	D						
	E	52					
FIN987PN							
8480.102							
	72	6501.566	FIN598PC00	8211.254	FIN599RS00		
	72,5	6501.567	FIN598PC05	8211.255	FIN599RS05		
	73	6501.568	FIN598PC10	8211.256	FIN599RS10		

		Nr.						ADATTABILE A: SUITABLE FOR:	
---	---	------------	---	---	---	---	---	--------------------------------	---

--	--	--	--	--	--	--	--	--	--

MB	2	GABBIA A RULLI - NEEDLE BEARING					3001.082	FIN2810GR
----	---	---------------------------------	--	--	--	--	----------	-----------





--	--	--	--	--	--	--	--	--	--



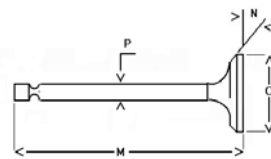

--	--	--	--	--	--	--	--	--	--

--	--	--	--	--	--	--	--	--	--

--	--	--	--	--	--	--	--	--	--

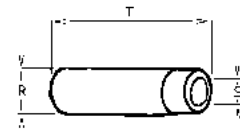
--	--	--	--	--	--	--	--	--	--

	IN EX		Nr.	O	P	M	N		ADATTABILE A: SUITABLE FOR:	
	IN	FS	1						9652.159	FINA4938
	EX	FN	1						9685.152	FINS4939

	IN EX		Nr.	R	S	T		ADATTABILE A: SUITABLE FOR:	
	IN	G	1					4845.249	FIN1660AA
	IN								
	EX	G	1					4845.250	FIN1661SA
EX									

Ricambi non originali per motori. Denominazioni e codici originali, sono riportati a puro titolo di riferimento.

49 - 14

rel. 1511

Non original engine parts. OEMs names and part numbers are for reference purpose only.

LGA 226	Cm³	CILINDRI CYLINDERS	ALESAGGIO BORE	CORSA STROKE	VERSIONE VERSION
	220	1	72	54	

	8180.202		1213.055	1213.055				
FIN4845CGA	FIN4845CGB		FIN3251RT	FIN3251RT				

 ↓ === ↑	ADATTABILE A: SUITABLE FOR:		Nr.	ENGINE KIT	ELECTRIC KIT
	4730.722	FIN6292HG	1		
			1		
			1		

3700.393		2175.156		3730.049			
FIN711AF		FIN725NF		FIN4301FE			

1526.212							
FIN6226KR STD							

LOMBARDINI

Benzina *Petrol*

LKA 226	Cm³	CILINDRI CYLINDERS	ALESAGGIO BORE	CORSA STROKE	VERSIONE VERSION
	220	1	72	54	

	TESTA HEAD		H09		TIPO TYPE	
	A					
	B	24				
	C					
	D					
	E	52				
FIN987PN		E	52	8211.254 FIN599RS00		
8480.102		F	15			8211.255 FIN599RS05
						8211.256 FIN599RS10
	72	6501.566	FIN598PC00			
	72,5	6501.567	FIN598PC05			
	73	6501.568	FIN598PC10			

		Nr.						ADATTABILE A: SUITABLE FOR:	
--	--	------------	--	--	--	--	--	--------------------------------	--

--	--	--	--	--	--	--	--	--	--

MB	2	GABBIA A RULLI - NEEDLE BEARING					3001.082	FIN2810GR
----	---	---------------------------------	--	--	--	--	----------	-----------

--	--	--	--	--	--	--	--	--	--

--	--	--	--	--	--	--	--	--	--

--	--	--	--	--	--	--	--	--	--

--	--	--	--	--	--	--	--	--	--

--	--	--	--	--	--	--	--	--	--

	IN		Nr.	O	P	M	N		ADATTABILE A: SUITABLE FOR:						
	IN								FS	1				9652.159	FINA4938
	EX								FN	1				9685.152	FINS4939

	IN		Nr.	R	S	T		ADATTABILE A: SUITABLE FOR:						
	IN							G	1				4845.249	FIN1660AA
	EX							G	1				4845.250	FIN1661SA
	EX													

Ricambi non originali per motori. Denominazioni e codici originali, sono riportati a puro titolo di riferimento.

Non original engine parts. OEMs names and part numbers are for reference purpose only.

LKA 226	Cm³	CILINDRI CYLINDERS	ALESAGGIO BORE	CORSA STROKE	VERSIONE VERSION
	220	1	72	54	

	8180.202		1213.055	1213.055				
FIN4845CGA	FIN4845CGB		FIN3251RT	FIN3251RT				

 ↓ === ↑	ADATTABILE A: SUITABLE FOR:		Nr.	ENGINE KIT	ELECTRIC KIT
	4730.722	FIN6292HG	1		
			1		
			1		

3700.393		2175.156		3730.049			
FIN711AF		FIN725NF		FIN4301FE			

1526.212							
FIN6226KR STD							

INTERMOTOR - LOMBARDINI Benzina Petrol

ALTRI ARTICOLI

OTHERS ITEMS

POS.	ARTICOLO	ITEM	MOTORE ENGINE	CODICE FINIMPIANTI FINIMPIANTI REF.	ADATTABILE A SUITABLE FOR:
1	Filtro aria	<i>Air cleaner</i>	LGA 184 , LKA 184 LGA 225 , LKA 225	FIN709AF	3750.058
2	Filtro aria	<i>Air cleaner</i>	LGA 226 , LKA 226	FIN710AF	3700.397
3	Filtro aria	<i>Air cleaner</i>	IM 250 , IM 300 , IM 350 IM 359 RETYLING	FIN1101AF	2175.172
4	Biella in alluminio	<i>Aluminium Connecting rod</i>	IM 250 , IM 252 , IM 300 IM 302 , IM 350 , IM 352 IM 359	FIN6206KR 025 FIN6206KR 050	1526.027 1526.028
5	Biella in alluminio	<i>Aluminium Connecting rod</i>	LGA 184 , LKA 184 LGA 225 , LKA 225	FIN6216KR 025 FIN6216KR 050	1526.145 1526.146
6	Biella in alluminio	<i>Aluminium Connecting rod</i>	LGA 226 , LKA 226	FIN6226KR 025 FIN6226KR 050	1526.213 1526.214
7	Serie segmenti 3 2 10 2 22 5	<i>Rings set</i> 3 2 10 2 22 5	IM 350 , IM 352	FIN029RS00 FIN029RS05 FIN029RS10	8210.099 8211.001 8211.002
8					
9					
10					
11					
12					
13					
14					
15					
16					
17					
18					
19					

INTERMOTOR - LOMBARDINI Benzina *Petrol*

ALTRI ARTICOLI

OTHERS ITEMS

POS.	ARTICOLO	ITEM	MOTORE ENGINE	CODICE FINIMPIANTI FINIMPIANTI REF.	ADATTABILE A SUITABLE FOR:
20					
21					
22					
23					
24					
25					
26					
27					
28					
29					
30					
31					
32					
33					
34					
35					
36					
37					
38					
39					
40					

SLANZI

1	DVA 460
3	DVA 920
5	DVA 515
7	DVA 1030
9	DVA 1030 S
11	DVA 1550
13	DVA 1550 S
15	DVA 650
17	DVA 680
19	DVA 1200
21	DVA 1750
23	DVA 1750 S
25	DVA 2350
27	DVA 1500
29	DVA 2200
31	DVA 2900
33	DVA 1800
35	DVA 2700
37	DVA 3600
39	DS 2000
41	DS 3000
43	DS 4000
45	ALTRI ARTICOLI <i>OTHERS ITEMS</i>

Questo catalogo contiene dati ed informazioni provenienti dalla pluriennale esperienza di Finimpianti. Tuttavia non possiamo assumere alcuna responsabilità per eventuali dati errati od incompleti.

Tutti i dati e le informazioni contenute nel presente catalogo sono fornite a puro scopo informativo e senza responsabilità e non potranno dare adito ad alcuna forma di risarcimento.

Visto il continuo sviluppo dei nostri prodotti, Finimpianti si riserva il diritto di apportare modifiche senza preavviso.

Denominazioni, numeri e codici originali sono riportati a puro titolo di riferimento.

All the information and data contained in this catalogue came from the long Finimpianti experience. Nevertheless we can not assume any responsibility for possible mistakes.



All the information and data contained in this catalogue are provide "as is" without any representation or warranty express or implied. Under no circumstances whatsoever shall Finimpianti be liable for any damages whatsoever arising out of the use of the information and data contained in this catalogue.







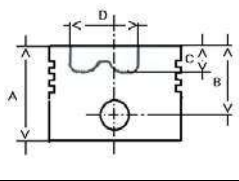

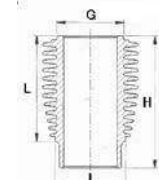
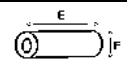
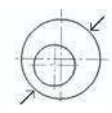
Finimpianti does not warrant the accuracy or completeness of the materials and content contained in this catalogue and reserves the right to correct any errors or omissions at any time without notice and without obligation to the users of this catalogue.

OEM names, codes and part numbers, used in this catalogue, are for reference only.

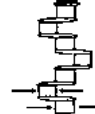
SLANZI

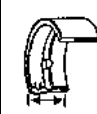
DVA 460	Cm³	CILINDRI CYLINDERS	ALESAGGIO BORE	CORSA STROKE	VERSIONE VERSION
	464	1	82	88	

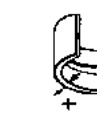
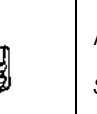
		TESTA HEAD	H17		3	2,5	TIPO TYPE		
		A	94		1	2,5			
		B	54		14	2,5		H	
		C	13,9		17	5		I	
		D	44					L	
	FIN984PN 	E	70						
	8480.065	F	26						
	82	6500.604	FIN687PC00	8211.110	FIN523RS00		2380.324		FIN089SL00
	82,5	6500.605	FIN687PC05	8211.111	FIN523RS05				
	83	6500.667	FIN687PC10	8211.134	FIN523RS10				

		Nr.							ADATTABILE A: SUITABLE FOR:	
---	---	------------	---	---	---	---	---	--	--------------------------------	---

CR	AL	1	47,64	51,34	24,45			STD - 025 - 050 075 - 100	1640.104	FIN961CR STD
----	----	---	-------	-------	-------	--	--	------------------------------	----------	--------------

MB	RP	2	45,05	50,02	30,25			STD - 025 - 050 075 - 100 - BAR	1585.118	FIN995MB STD
----	----	---	-------	-------	-------	--	--	------------------------------------	----------	--------------





--	--	--	--	--	--	--	--	--	--	--



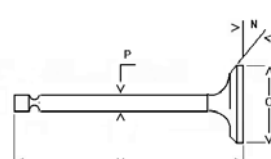

--	--	--	--	--	--	--	--	--	--	--

PB	BM	1	26,00	28,02	32,00			SEMIF.	1585.089	FIN302PB
----	----	---	-------	-------	-------	--	--	--------	----------	----------

--	--	--	--	--	--	--	--	--	--	--

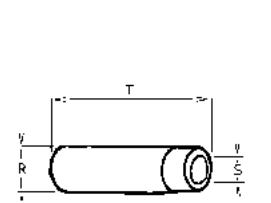
--	--	--	--	--	--	--	--	--	--	--

	IN EX		Nr.	O	P	M	N		ADATTABILE A: SUITABLE FOR:			
	IN		FS	1	36	8	106		45	E1	9652.070	FINA072
	EX		FS	1	31	8	106		45	A1	9685.074	FINS073

	IN EX		Nr.	R	S	T		ADATTABILE A: SUITABLE FOR:			
	IN		G	1	14,05	8,05		46	F	4845.133	FIN605AA
	EX		G	1	14,05	8,05		50	F	4845.128	FIN606SA

Ricambi non originali per motori. Denominazioni e codici originali, sono riportati a puro titolo di riferimento.

SLANZI

DVA 460	Cm³	CILINDRI CYLINDERS	ALESAGGIO BORE	CORSA STROKE	VERSIONE VERSION
	464	1	82	88	

	8180.134	8180.149	1213.256	1213.256	4601.162	4431.116		
FIN811CGA	FIN811CGB	FIN5265SM	FIN3235RT	FIN3235RT	FIN231CO	FIN019CB		

 	ADATTABILE A: SUITABLE FOR:		Nr.	ENGINE KIT	ELECTRIC KIT
	4730.302	FIN6285HG	1	 FIN089SL00	
			1	 FIN687PC00	
			1	 FIN5265SM	
				FIN2458KIT	

3700.238	9710.099	5496.133		2175.064	2175.072		
FIN700AF	FIN678PF	FIN1081NF		FIN684FE	FIN1095OF		

6585.054	6590.158	5010.010	6531.279	6578.135	9672.031		
FIN551FP	FIN624JP	FIN560NH	FIN154NO	FIN1225E	FIN016DV		

1157.153	7362.228						
FIN553VA	FIN238VR						

Ricambi non originali per motori. Denominazioni e codici originali, sono riportati a puro titolo di riferimento.



2 - 15







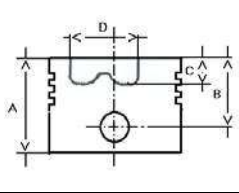

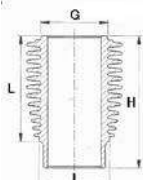
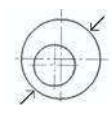
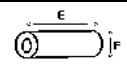
rel. 1511

Non original engine parts. OEMs names and part numbers are for reference purpose only.

SLANZI

DVA 920	Cm³	CILINDRI CYLINDERS	ALESAGGIO BORE	CORSA STROKE	VERSIONE VERSION
	928	2	82	88	

		TESTA HEAD	H17		3	2,5	TIPO TYPE		
					1	2,5			
	FIN984PN 8480.065		A	94					
			B	54					
			C	13,9	14	2,5			
			D	44	17	5			
			E	70					
			F	26					
	82	6500.604	FIN687PC00		8211.110	FIN523RS00	2380.324		FIN089SL00
	82,5	6500.605	FIN687PC05		8211.111	FIN523RS05			
	83	6500.667	FIN687PC10		8211.134	FIN523RS10			

		Nr.							ADATTABILE A: SUITABLE FOR:	
---	---	------------	---	---	---	---	---	--	--------------------------------	---

CR	AL	2	47,64	51,34	24,45			STD - 025 - 050 075 - 100	1640.104	FIN961CR STD
----	----	---	-------	-------	-------	--	--	------------------------------	----------	--------------

MB	RP	1	51,96	57,02	30,25			BAR	1585.097	FINR965MB STD
----	----	---	-------	-------	-------	--	--	-----	----------	---------------





MB	AL	1	55,45	59,08	25,00			STD - 025 - 050 BAR	1611.172	FINR960CR STD
----	----	---	-------	-------	-------	--	--	------------------------	----------	---------------



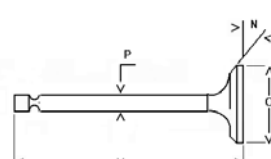

MB	RP	1	57,95	63,02	25,25			BAR	1585.100	FINR4763MB STD
----	----	---	-------	-------	-------	--	--	-----	----------	----------------

PB	BM	2	26,00	28,02	32,00			SEMIF.	1585.089	FIN302PB
----	----	---	-------	-------	-------	--	--	--------	----------	----------

--	--	--	--	--	--	--	--	--	--	--

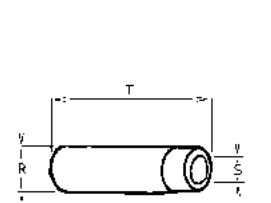
--	--	--	--	--	--	--	--	--	--	--

	IN EX		Nr.	O	P	M	N		ADATTABILE A: SUITABLE FOR:									
									IN	FS	2	36	8	106	45	E1	9652.070	FINA072
									EX	FS	2	31	8	106	45	A1	9685.074	FINS073

	IN EX		Nr.	R	S	T		ADATTABILE A: SUITABLE FOR:								
								IN	G	2	14,05	8,05	46	F	4845.133	FIN605AA
								EX	G	2	14,05	8,05	50	F	4845.128	FIN606SA

Ricambi non originali per motori. Denominazioni e codici originali, sono riportati a puro titolo di riferimento.

3 - 15

rel. 1511

Non original engine parts. OEMs names and part numbers are for reference purpose only.

SLANZI

DVA 920	Cm³	CILINDRI CYLINDERS	ALESAGGIO BORE	CORSA STROKE	VERSIONE VERSION
	928	2	82	88	

	8180.136	8180.153	1213.257	1213.262	4601.064	4431.116		
FIN802CGA	FIN802CGB	FIN525SM	FIN3230RT	FIN3231RT	FIN209CO	FIN019CB		

 	ADATTABILE A: SUITABLE FOR:		Nr.	ENGINE KIT	ELECTRIC KIT
	4730.302	FIN6285HG	1	 FIN089SL00	
			1	 FIN687PC00	
			1	 FIN5265SM	
				FIN2458KIT	

3700.213	6727.027	5496.132		2175.066	2175.072		
FIN331AF	FIN679PF	FIN1018NF		FIN683FE	FIN1095OF		

6585.055	6590.139	5010.010	6531.279	6578.135	9672.031		
FIN550FP	FIN625JP	FIN560NH	FIN154NO	FIN1225E	FIN016DV		

1157.153	7362.228						
FIN553VA	FIN238VR						

Ricambi non originali per motori. Denominazioni e codici originali, sono riportati a puro titolo di riferimento.





4 - 15





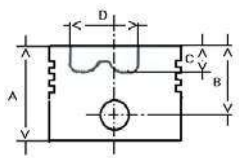

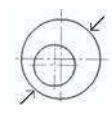
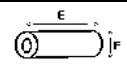

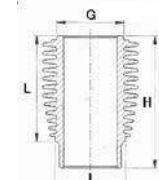
rel. 1511

Non original engine parts. OEMs names and part numbers are for reference purpose only.

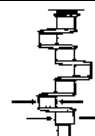
SLANZI

DVA 515	Cm³	CILINDRI CYLINDERS	ALESAGGIO BORE	CORSA STROKE	VERSIONE VERSION
	511	1	86	88	

		TESTA HEAD	H02		3	2,5	TIPO TYPE	A	
		A	88,5		10	2,5		G	99,90
		B	54		22	5		H	170
		C	14,3					I	93,85
	FIN622PN	E	71				2380.305	L	132,30
	8480.057	F	26					FIN087SL00	
	86	6500.546	FIN222PC00	8211.091	FIN091RS00				
	86,5	6500.547	FIN222PC05	8211.092	FIN091RS05				
	87	6500.686	FIN222PC10	8211.135	FIN091RS10				

		Nr.						ADATTABILE A: SUITABLE FOR:	
---	---	------------	---	---	---	---	---	--------------------------------	---

CR	AL	1	47,64	51,34	24,45		STD - 025 - 050 075 - 100	1640.104	FIN961CR STD
----	----	---	-------	-------	-------	--	------------------------------	----------	--------------

MB	RP	2	45,05	50,02	30,25		STD - 025 - 050 075 - 100 - BAR	1585.118	FIN995MB STD
----	----	---	-------	-------	-------	--	------------------------------------	----------	--------------





--	--	--	--	--	--	--	--	--	--



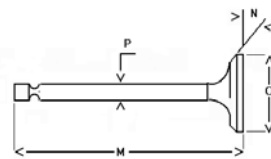

--	--	--	--	--	--	--	--	--	--

PB	BM	1	26,00	28,02	32,00		SEMIF.	1585.089	FIN302PB
----	----	---	-------	-------	-------	--	--------	----------	----------

--	--	--	--	--	--	--	--	--	--

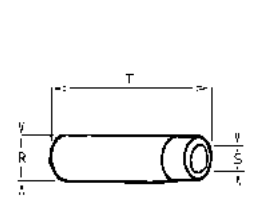
--	--	--	--	--	--	--	--	--	--

	IN EX		Nr.	O	P	M	N		ADATTABILE A: SUITABLE FOR:			
	IN		FS	1	36	8	106		45	E1	9652.070	FINA072
	EX		FS	1	31	8	106		45	A1	9685.074	FINS073

	IN EX		Nr.	R	S	T		ADATTABILE A: SUITABLE FOR:			
	IN		G	1	14,05	8,05		46	F	4845.133	FIN605AA
	EX		G	1	14,05	8,05		50	F	4845.128	FIN606SA

Ricambi non originali per motori. Denominazioni e codici originali, sono riportati a puro titolo di riferimento.

5 - 15

rel. 1511

Non original engine parts. OEMs names and part numbers are for reference purpose only.

SLANZI

DVA 515	Cm³	CILINDRI CYLINDERS	ALESAGGIO BORE	CORSA STROKE	VERSIONE VERSION
	511	1	86	88	

	8180.130	8180.150	1213.256	1213.256	4601.162	4431.116		
FIN814CGA	FIN814CGB	FIN5278SM	FIN3235RT	FIN3235RT	FIN231CO	FIN019CB		

 	ADATTABILE A: SUITABLE FOR:		Nr.	ENGINE KIT	ELECTRIC KIT
	4730.294	FIN6286HG	1	 FIN087SL00	
			1	 FIN222PC00	
			1	 FIN5278SM	
				FIN2284KIT	

3700.238	9710.099	5496.133		2175.064	2175.072		
FIN700AF	FIN678PF	FIN1081NF		FIN684FE	FIN1095OF		

6585.054	6590.158	5010.010	6531.279	6578.135	9672.031		
FIN551FP	FIN624JP	FIN560NH	FIN154NO	FIN1225E	FIN016DV		

1157.153	7362.228						
FIN553VA	FIN238VR						

Ricambi non originali per motori. Denominazioni e codici originali, sono riportati a puro titolo di riferimento.



6 - 15







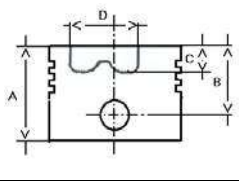

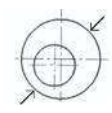
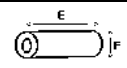
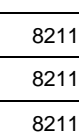
rel. 1511

Non original engine parts. OEMs names and part numbers are for reference purpose only.

SLANZI

DVA 1030	Cm³	CILINDRI CYLINDERS	ALESAGGIO BORE	CORSA STROKE	VERSIONE VERSION
	1022	2	86	88	

		TESTA HEAD	H02		3	2,5	TIPO TYPE	A	
		A	88,5		10	2,5		G	99,90
		B	54		22	5	H	170	
		C	14,3				I	93,85	
	FIN622PN	E	71				L	132,30	
	8480.057	F	26						
	86	6500.546	FIN222PC00	8211.091	FIN091RS00		2380.305	FIN087SL00	
	86,5	6500.547	FIN222PC05	8211.092	FIN091RS05				
	87	6500.686	FIN222PC10	8211.135	FIN091RS10				

		Nr.						ADATTABILE A: SUITABLE FOR:	
---	---	------------	---	---	---	---	---	--------------------------------	---

CR	AL	2	47,64	51,34	24,45		STD - 025 - 050 075 - 100	1640.104	FIN961CR STD
----	----	---	-------	-------	-------	--	------------------------------	----------	--------------

MB	RP	1	51,96	57,02	30,25		BAR	1585.097	FINR965MB STD
----	----	---	-------	-------	-------	--	-----	----------	---------------





MB	AL	1	55,45	59,08	25,00		STD - 025 - 050 BAR	1611.172	FINR960CR STD
----	----	---	-------	-------	-------	--	------------------------	----------	---------------



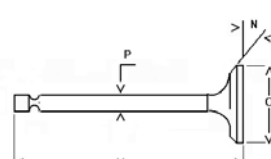

MB	RP	1	57,95	63,02	25,25		BAR	1585.100	FINR4763MB STD
----	----	---	-------	-------	-------	--	-----	----------	----------------

PB	BM	2	26,00	28,02	32,00		SEMIF.	1585.089	FIN302PB
----	----	---	-------	-------	-------	--	--------	----------	----------

--	--	--	--	--	--	--	--	--	--

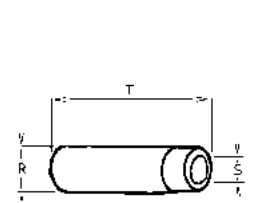
--	--	--	--	--	--	--	--	--	--

	IN EX		Nr.	O	P	M	N		ADATTABILE A: SUITABLE FOR:	
	IN	FS	2	36	8	106	45	E1	9652.070	FINA072
	EX	FS	2	31	8	106	45	A1	9685.074	FINS073

	IN EX		Nr.	R	S	T		ADATTABILE A: SUITABLE FOR:	
	IN	G	2	14,05	8,05	46	F	4845.133	FIN605AA
	EX	G	2	14,05	8,05	50	F	4845.128	FIN606SA

Ricambi non originali per motori. Denominazioni e codici originali, sono riportati a puro titolo di riferimento.

7 - 15

rel. 1511

Non original engine parts. OEMs names and part numbers are for reference purpose only.

SLANZI

DVA 1030	Cm³	CILINDRI CYLINDERS	ALESAGGIO BORE	CORSA STROKE	VERSIONE VERSION
	1022	2	86	88	

	8180.096	8180.106	1213.257	1213.262	4601.064	4431.116		
FIN803CGA	FIN803CGB	FIN526SM	FIN3230RT	FIN3231RT	FIN209CO	FIN019CB		

 	ADATTABILE A: SUITABLE FOR:		Nr.	ENGINE KIT	ELECTRIC KIT
	4730.294	FIN6286HG	1	 FIN087SL00	
			1	 FIN222PC00	
			1	 FIN5278SM	
				FIN2284KIT	

3700.213	6727.027	5496.132		2175.064	2175.072		
FIN331AF	FIN679PF	FIN1018NF		FIN684FE	FIN1095OF		

6585.055	6590.139	5010.010	6531.279	6578.135	9672.031		
FIN550FP	FIN625JP	FIN560NH	FIN154NO	FIN1225E	FIN016DV		

1157.153	7362.228						
FIN553VA	FIN238VR						

Ricambi non originali per motori. Denominazioni e codici originali, sono riportati a puro titolo di riferimento.





8 - 15





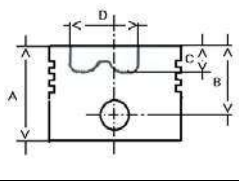

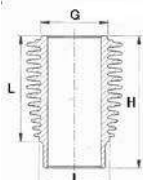

rel. 1511

Non original engine parts. OEMs names and part numbers are for reference purpose only.

SLANZI

DVA 1030 S	Cm³	CILINDRI CYLINDERS	ALESAGGIO BORE	CORSA STROKE	VERSIONE VERSION
	1022	2	86	88	

		TESTA HEAD	H18		3	2,5	TIPO TYPE		G	H	I	L
		A	88,5		10	2,5						
		B	54		22	5						
		C	12,2									
		D	49,3									
	FIN622PN	E	71									
	8480.057	F	26									
	86	6500.552	FIN2431PC00	8211.093	FIN091RS00							
	86,5	6500.553	FIN2431PC05	8211.094	FIN091RS05							
	87		FIN2431PC10		FIN091RS10							

		Nr.						ADATTABILE A: SUITABLE FOR:	
---	---	------------	---	---	---	---	---	--------------------------------	---

CR	AL	2	47,64	51,34	24,45		STD - 025 - 050 075 - 100	1640.104	FIN961CR STD
----	----	---	-------	-------	-------	--	------------------------------	----------	--------------

MB	RP	1	51,96	57,02	30,25		BAR	1585.097	FINR965MB STD
----	----	---	-------	-------	-------	--	-----	----------	---------------





MB	AL	1	55,45	59,08	25,00		STD - 025 - 050 BAR	1611.172	FINR960CR STD
----	----	---	-------	-------	-------	--	------------------------	----------	---------------



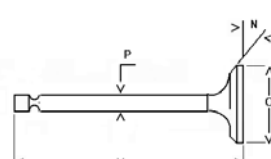

MB	RP	1	57,95	63,02	25,25		BAR	1585.100	FINR4763MB STD
----	----	---	-------	-------	-------	--	-----	----------	----------------

PB	BM	2	26,00	28,02	32,00		SEMIF.	1585.089	FIN302PB
----	----	---	-------	-------	-------	--	--------	----------	----------

--	--	--	--	--	--	--	--	--	--

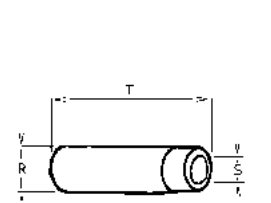
--	--	--	--	--	--	--	--	--	--

	IN EX		Nr.	O	P	M	N		ADATTABILE A: SUITABLE FOR:			
	IN		FS	2	38,5	8	114		45	E1	9652.071	FINA099
	EX		FN	2	33	8	114		45	A1	9685.075	FINS098

	IN EX		Nr.	R	S	T		ADATTABILE A: SUITABLE FOR:			
	IN		G	2	14,05	8,05		51	L	4845.129	FIN1448ASA
	EX		G	2	14,05	8,05		51	L	4845.129	FIN1448ASA

Ricambi non originali per motori. Denominazioni e codici originali, sono riportati a puro titolo di riferimento.

9 - 15

rel. 1511

Non original engine parts. OEMs names and part numbers are for reference purpose only.

SLANZI

DVA 1030 S	Cm³	CILINDRI CYLINDERS	ALESAGGIO BORE	CORSA STROKE	VERSIONE VERSION
	1022	2	86	88	

	8180.096	8180.109	1213.257	1213.262	4601.064	4431.116		
FIN815CGA	FIN815CGB	FIN528SM	FIN3230RT	FIN3231RT	FIN209CO	FIN019CB		

 ADATTABILE A: SUITABLE FOR:	 FIN6112HG	Nr.	ENGINE KIT	ELECTRIC KIT
		1		
		1		
		1		

3700.213	6727.027	5496.132		2175.064	2175.072		
FIN331AF	FIN679PF	FIN1018NF		FIN684FE	FIN1095OF		

6585.055	6590.139	5010.012	6531.281	6578.135	9672.031		
FIN550FP	FIN625JP	FIN564NH	FIN091NO	FIN1225E	FIN016DV		

1157.153	7362.228						
FIN553VA	FIN238VR						

Ricambi non originali per motori. Denominazioni e codici originali, sono riportati a puro titolo di riferimento.



10 - 15







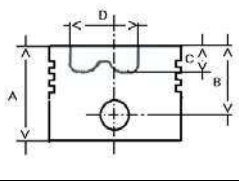

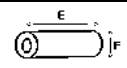
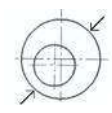
rel. 1511

Non original engine parts. OEMs names and part numbers are for reference purpose only.

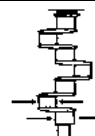
SLANZI

DVA 1550	Cm³	CILINDRI CYLINDERS	ALESAGGIO BORE	CORSA STROKE	VERSIONE VERSION
	1533	3	86	88	

		TESTA HEAD	H02		3	2,5	TIPO TYPE	A	
		A	88,5		10	2,5		G	99,90
		B	54					H	170
		C	14,3					I	93,85
		D	46					L	132,30
	FIN622PN 	E	71						
	8480.057	F	26						
	86	6500.546	FIN222PC00	8211.091	FIN091RS00	2380.305		FIN087SL00	
	86,5	6500.547	FIN222PC05	8211.092	FIN091RS05				
	87	6500.686	FIN222PC10	8211.135	FIN091RS10				

		Nr.						ADATTABILE A: SUITABLE FOR:	
---	---	------------	---	---	---	---	---	--------------------------------	---

CR	AL	3	53,03	56,73	24,50		STD - 025 - 050 075 - 100	1640.107	FIN967CR STD
----	----	---	-------	-------	-------	--	------------------------------	----------	--------------

MB	RP	3	59,95	63,67	25,53		STD - 025 - 050 075 - 100	1611.163	FIN968MB STD
----	----	---	-------	-------	-------	--	------------------------------	----------	--------------





MB	AM	1	60,00	88,00	26,00		STD - 025 - 050 BAR	8675.172	FIN996MB STD
----	----	---	-------	-------	-------	--	------------------------	----------	--------------



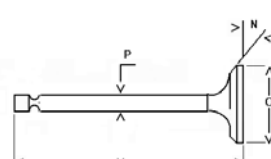

--	--	--	--	--	--	--	--	--	--

PB	BM	3	26,00	28,02	32,00		SEMIF.	1585.089	FIN302PB
----	----	---	-------	-------	-------	--	--------	----------	----------

TW	AL	1	69,21	85,85	2,36		STD - 010	1257.048	FIN013TWS STD
----	----	---	-------	-------	------	--	-----------	----------	---------------

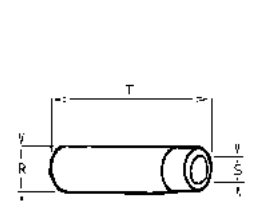
--	--	--	--	--	--	--	--	--	--

	IN EX		Nr.	O	P	M	N		ADATTABILE A: SUITABLE FOR:			
	IN		FS	3	36	8	106		45	E1	9652.070	FINA072
	EX		FS	3	31	8	106		45	A1	9685.074	FINS073

	IN EX		Nr.	R	S	T		ADATTABILE A: SUITABLE FOR:			
	IN		G	3	14,05	8,05		46	F	4845.133	FIN605AA
	EX		G	3	14,05	8,05		50	F	4845.128	FIN606SA

Ricambi non originali per motori. Denominazioni e codici originali, sono riportati a puro titolo di riferimento.

11 - 15

rel. 1511

Non original engine parts. OEMs names and part numbers are for reference purpose only.

SLANZI

DVA 1550	Cm³	CILINDRI CYLINDERS	ALESAGGIO BORE	CORSA STROKE	VERSIONE VERSION
	1533	3	86	88	

	8180.140	8180.154	1213.267	1213.258	4601.079	4431.116		
FIN812CGA	FIN812CGB	FIN5481SM	FIN3232RT	FIN892RT	FIN769CO	FIN019CB		

 ADATTABILE A: SUITABLE FOR:	 FIN6286HG	Nr.	ENGINE KIT	ELECTRIC KIT
		1	 FIN087SL00	
		1	 FIN222PC00	
		1	 FIN5278SM	
		FIN2284KIT		

3700.236	6727.030			2175.083	2175.090		
FIN332AF	FIN682PF			FIN4247FE	FIN4248OF		

				4336.049			
				FIN087OP			

6585.062	6590.142	5010.012	6531.281	6578.135	9672.031		
FIN552FP	FIN626JP	FIN564NH	FIN091NO	FIN1225E	FIN016DV		

Ricambi non originali per motori. Denominazioni e codici originali, sono riportati a puro titolo di riferimento.



12 - 15





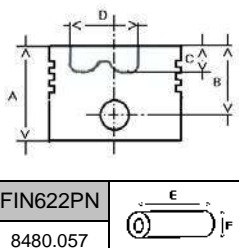

rel. 1511

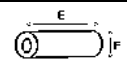
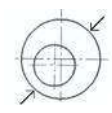
Non original engine parts. OEMs names and part numbers are for reference purpose only.

SLANZI

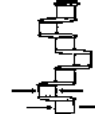
DVA 1550 S	Cm³	CILINDRI CYLINDERS	ALESAGGIO BORE	CORSA STROKE	VERSIONE VERSION
	1533	3	86	88	

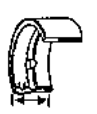
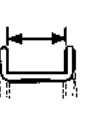
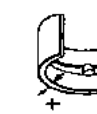
		TESTA HEAD	H18		3	2,5	TIPO TYPE		
		A	88,5		10	2,5		G	
		B	54		22	5		H	
		C	12,2					I	
		D	49,3					L	
		E	71						
FIN622PN				8211.093	FIN091RS00				
8480.057				8211.094	FIN091RS05				
						FIN091RS10			
	86	6500.552	FIN2431PC00						
	86,5	6500.553	FIN2431PC05						
	87		FIN2431PC10						

		Nr.						ADATTABILE A: SUITABLE FOR:	
---	---	------------	---	---	---	---	---	--------------------------------	---

CR	AL	3	53,03	56,73	24,50		STD - 025 - 050 075 - 100	1640.107	FIN967CR STD
----	----	---	-------	-------	-------	--	------------------------------	----------	--------------

MB	RP	3	59,95	63,67	25,53		STD - 025 - 050 075 - 100	1611.163	FIN968MB STD
----	----	---	-------	-------	-------	--	------------------------------	----------	--------------





MB	AM	1	60,00	88,00	26,00		STD - 025 - 050 BAR	8675.172	FIN996MB STD
----	----	---	-------	-------	-------	--	------------------------	----------	--------------



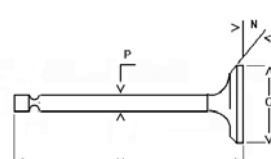

--	--	--	--	--	--	--	--	--	--

PB	BM	3	26,00	28,02	32,00		SEMIF.	1585.089	FIN302PB
----	----	---	-------	-------	-------	--	--------	----------	----------

TWS	AL	1	69,21	85,85	2,36		STD - 010	1257.048	FIN013TWS STD
-----	----	---	-------	-------	------	--	-----------	----------	---------------

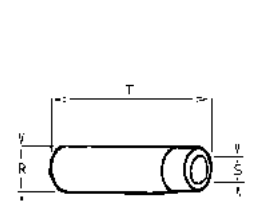
--	--	--	--	--	--	--	--	--	--

	IN EX		Nr.	O	P	M	N		ADATTABILE A: SUITABLE FOR:			
	IN		FS	3	38,5	8	114		45	E1	9652.071	FINA099
	EX		FN	3	33	8	114		45	A1	9685.075	FINS098

	IN EX		Nr.	R	S	T		ADATTABILE A: SUITABLE FOR:			
	IN		G	3	14,05	8,05		51	L	4845.129	FIN1448ASA
	EX		G	3	14,05	8,05		51	L	4845.129	FIN1448ASA

Ricambi non originali per motori. Denominazioni e codici originali, sono riportati a puro titolo di riferimento.

13 - 15

rel. 1511

Non original engine parts. OEMs names and part numbers are for reference purpose only.

SLANZI

DVA 1550 S	Cm³	CILINDRI CYLINDERS	ALESAGGIO BORE	CORSA STROKE	VERSIONE VERSION
	1533	3	86	88	

	8180.097	8180.108	1213.267	1213.258	4601.079	4431.116		
FIN4823CGA	FIN4823CGB	FIN527SM	FIN3232RT	FIN892RT	FIN769CO	FIN019CB		

 ADATTABILE A: SUITABLE FOR:	 FIN6112HG	Nr.		ENGINE KIT		ELECTRIC KIT	
		1					
		1					
		1					
4730.296							

3700.215		5496.134		2175.065	2175.071		
FIN388AF		FIN1012NF		FIN342FE	FIN436OF		

				4336.049			
				FIN087OP			

6585.062	6590.142	5010.012	6531.281	6578.135	9672.031		
FIN552FP	FIN626JP	FIN564NH	FIN091NO	FIN1225E	FIN016DV		

Ricambi non originali per motori. Denominazioni e codici originali, sono riportati a puro titolo di riferimento.



14 - 15







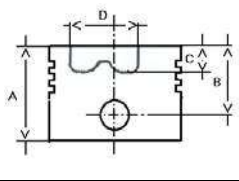

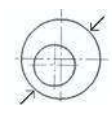
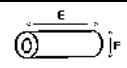
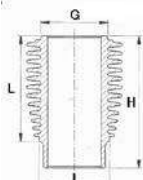
rel. 1511

Non original engine parts. OEMs names and part numbers are for reference purpose only.

SLANZI

DVA 650	Cm³	CILINDRI CYLINDERS	ALESAGGIO BORE	CORSA STROKE	VERSIONE VERSION
	636	1	90	110	

		TESTA HEAD	A			3	3	TIPO TYPE		
			B	55		10	3		G	
	FIN985PN 	E	78	10	3	17	5		H	
	8480.067	F	28	17	5	17	5		I	
	90	6500.589	FIN1692PC00	8211.116	FIN405RS00				L	
	90,5	6500.590	FIN1692PC05	8211.117	FIN405RS05					
	91	6500.591	FIN1692PC10	8211.118	FIN405RS10					

		Nr.							ADATTABILE A: SUITABLE FOR:	
---	---	------------	---	---	---	---	---	--	--------------------------------	---

CR	AL	1	57,12	60,84	27,00			STD - 025 - 050 075 - 100	1640.092	FIN959CR STD
----	----	---	-------	-------	-------	--	--	------------------------------	----------	--------------

MB	RP	1	55,00	70,00	28,00			BAR	1611.114	FINR963MB STD
----	----	---	-------	-------	-------	--	--	-----	----------	---------------





MB	RP	1	65,01	75,03	40,00	32,00		BAR		FINR757MB STD
----	----	---	-------	-------	-------	-------	--	-----	--	---------------



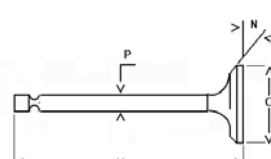

--	--	--	--	--	--	--	--	--	--	--

--	--	--	--	--	--	--	--	--	--	--

--	--	--	--	--	--	--	--	--	--	--

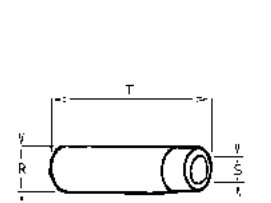
--	--	--	--	--	--	--	--	--	--	--

	IN EX		Nr.	O	P	M	N		ADATTABILE A: SUITABLE FOR:			
	IN		FS	1	40	9	111		45	E3	9652.087	FINA084
	EX		FS	1	40	9	111		45	A3	9685.087	FINS085

	IN EX		Nr.	R	S	T		ADATTABILE A: SUITABLE FOR:			
	IN		G	1	15,03	9,03		50	F	4845.149	FIN613AA
	EX		G	1	15,03	9,03		50	F	4845.136	FIN614SA

Ricambi non originali per motori. Denominazioni e codici originali, sono riportati a puro titolo di riferimento.

15 - 15
rel. 1511

Non original engine parts. OEMs names and part numbers are for reference purpose only.

SLANZI

DVA 650	Cm³	CILINDRI CYLINDERS	ALESAGGIO BORE	CORSA STROKE	VERSIONE VERSION
	636	1	90	110	

			1210.039	1212.050				
			FIN976RT	FIN3238RT				

 	ADATTABILE A: SUITABLE FOR:		Nr.	ENGINE KIT	ELECTRIC KIT
			1		
			1		
			1		

				2175.076	2175.085		
				FIN603FE	FIN1097OF		

Ricambi non originali per motori. Denominazioni e codici originali, sono riportati a puro titolo di riferimento.



16 - 15







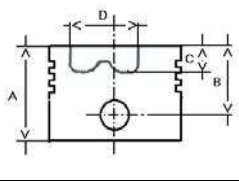

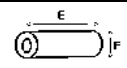
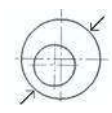
rel. 1511

Non original engine parts. OEMs names and part numbers are for reference purpose only.

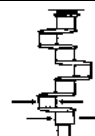
SLANZI

DVA 680	Cm³	CILINDRI CYLINDERS	ALESAGGIO BORE	CORSA STROKE	VERSIONE VERSION
	665	1	92	100	

		TESTA HEAD	A			3	2,5	TIPO TYPE		
			B	55		10	2,5		G	
			C	18,5		10	2,5		H	
			D	49		22	5		I	
			E	78					L	
			F	28						
	FIN985PN 									
	8480.067									
	92	6500.609	FIN221PC00		8211.119	FIN090RS00				
	92,5	6500.610	FIN221PC05		8211.120	FIN090RS05				
	93	6500.611	FIN221PC10		8211.121	FIN090RS10				

		Nr.						ADATTABILE A: SUITABLE FOR:	
---	---	------------	---	---	---	---	---	--------------------------------	---

CR	AL	1	57,12	60,84	27,00		STD - 025 - 050 075 - 100	1640.092	FIN959CR STD
----	----	---	-------	-------	-------	--	------------------------------	----------	--------------

MB	RP	1	55,00	70,00	28,00		BAR	1611.114	FINR963MB STD
----	----	---	-------	-------	-------	--	-----	----------	---------------





MB	RP	1	65,01	75,03	40,00	32,00	BAR		FINR757MB STD
----	----	---	-------	-------	-------	-------	-----	--	---------------



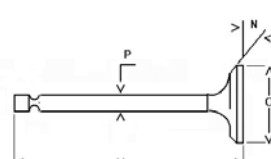

--	--	--	--	--	--	--	--	--	--

--	--	--	--	--	--	--	--	--	--

--	--	--	--	--	--	--	--	--	--

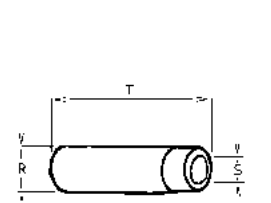
--	--	--	--	--	--	--	--	--	--

	IN EX		Nr.	O	P	M	N		ADATTABILE A: SUITABLE FOR:								
	IN								FS	1	40	9	111	45	E3	9652.087	FINA084
	EX								FS	1	40	9	111	45	A3	9685.087	FINS085

	IN EX		Nr.	R	S	T		ADATTABILE A: SUITABLE FOR:							
	IN							G	1	15,03	9,03	50	F	4845.149	FIN613AA
	EX							G	1	15,03	9,03	50	F	4845.136	FIN614SA

Ricambi non originali per motori. Denominazioni e codici originali, sono riportati a puro titolo di riferimento.

17 - 15

rel. 1511

Non original engine parts. OEMs names and part numbers are for reference purpose only.

SLANZI

DVA 680	Cm³	CILINDRI CYLINDERS	ALESAGGIO BORE	CORSA STROKE	VERSIONE VERSION
	665	1	92	100	

			LV	LD			IN	EX
			1210.039	1212.050				
	FIN4824CGB		FIN976RT	FIN3238RT				

 	ADATTABILE A: SUITABLE FOR:		Nr.	ENGINE KIT	ELECTRIC KIT
	4730.293	FIN6113HG	1		
			1		
			1		

3700.233		5496.135		2175.076	2175.087		
FIN703AF		FIN722NF		FIN603FE	FIN1096OF		

Ricambi non originali per motori. Denominazioni e codici originali, sono riportati a puro titolo di riferimento.





18 - 15





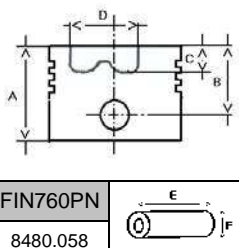

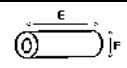
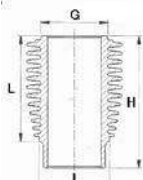

rel. 1511

Non original engine parts. OEMs names and part numbers are for reference purpose only.

SLANZI

DVA 1200	Cm³	CILINDRI CYLINDERS	ALESAGGIO BORE	CORSA STROKE	VERSIONE VERSION
		2	92	100	

		TESTA HEAD	H03		3	2,5	TIPO TYPE	A	
		A	93		10	2,5			
		B	54		22	5			
		C	14						
		D	50						
		E	70						
FIN760PN		F	26					G	106
8480.058								H	170
								I	100
	92	6500.548	FIN223PC00	8211.095	FIN092RS00	2380.307		L	132,20
	92,5	6500.549	FIN223PC05	8211.096	FIN092RS05			FIN223SL00	
	93	6500.690	FIN223PC10	8211.137	FIN092RS10				

		Nr.						ADATTABILE A: SUITABLE FOR:	
---	---	------------	---	---	---	---	---	--------------------------------	---

CR	AL	2	47,64	51,34	24,45		STD - 025 - 050 075 - 100	1640.104	FIN961CR STD
----	----	---	-------	-------	-------	--	------------------------------	----------	--------------

MB	RP	1	51,96	57,02	30,25		BAR	1585.097	FINR965MB STD
----	----	---	-------	-------	-------	--	-----	----------	---------------





MB	AL	1	55,45	59,08	25,00		STD - 025 - 050 BAR	1611.172	FINR960CR STD
----	----	---	-------	-------	-------	--	------------------------	----------	---------------



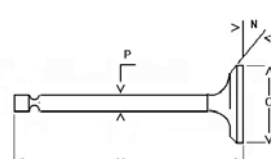

MB	RP	1	57,95	63,02	25,25		BAR	1585.100	FINR4763MB STD
----	----	---	-------	-------	-------	--	-----	----------	----------------

PB	BM	2	26,00	28,02	32,00		SEMIF.	1585.089	FIN302PB
----	----	---	-------	-------	-------	--	--------	----------	----------

--	--	--	--	--	--	--	--	--	--

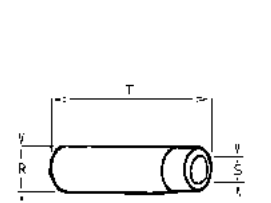
--	--	--	--	--	--	--	--	--	--

	IN EX		Nr.	O	P	M	N		ADATTABILE A: SUITABLE FOR:				
	IN		FS	2	38,5	8	114		45		E1	9652.071	FINA099
	EX		FN	2	33	8	114		45		A1	9685.075	FINS098

	IN EX		Nr.	R	S	T		ADATTABILE A: SUITABLE FOR:				
	IN		G	2	14,05	8,05		51		L	4845.129	FIN1448ASA
	EX		G	2	14,05	8,05		51		L	4845.129	FIN1448ASA

Ricambi non originali per motori. Denominazioni e codici originali, sono riportati a puro titolo di riferimento.

19 - 15

rel. 1511

Non original engine parts. OEMs names and part numbers are for reference purpose only.

SLANZI

DVA 1200	Cm³	CILINDRI CYLINDERS	ALESAGGIO BORE	CORSA STROKE	VERSIONE VERSION
		2	92	100	

			1213.257	1213.262	4601.064	4431.116		
FIN4825CGA	FIN4825CGB	FIN5484SM	FIN3230RT	FIN3231RT	FIN209CO	FIN019CB		

 ADATTABILE A: SUITABLE FOR:	 FIN6113HG	Nr.	ENGINE KIT	ELECTRIC KIT
		1	 FIN223SL00	
		1	 FIN223PC00	
		1	 FIN5284SM	
			FIN2063KIT	

3700.256		5496.134		2175.064	2175.072		
FIN701AF		FIN1012NF		FIN684FE	FIN1095OF		

6585.055			6531.281	6578.135	9672.031		
FIN550FP			FIN091NO	FIN1225E	FIN016DV		

	7362.228						
	FIN238VR						

Ricambi non originali per motori. Denominazioni e codici originali, sono riportati a puro titolo di riferimento.



20 - 15







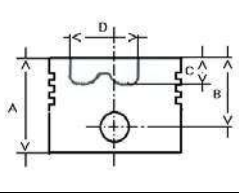

rel. 1511

Non original engine parts. OEMs names and part numbers are for reference purpose only.

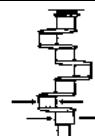
SLANZI

DVA 1750	Cm³	CILINDRI CYLINDERS	ALESAGGIO BORE	CORSA STROKE	VERSIONE VERSION
	1755	3	92	100	

		TESTA HEAD	H03		3	2,5	TIPO TYPE	A	
		A	93		10	2,5		G	106
		B	54		22	5		H	170
		C	14					I	100
		D	50					L	132,20
	FIN760PN	E	70					2380.307	
	8480.058	F	26					FIN223SL00	
	92	6500.548	FIN223PC00	8211.095	FIN092RS00				
	92,5	6500.549	FIN223PC05	8211.096	FIN092RS05				
	93	6500.690	FIN223PC10	8211.137	FIN092RS10				

		Nr.						ADATTABILE A: SUITABLE FOR:	
---	---	------------	---	---	---	---	---	--	---

CR	AL	3	53,03	56,73	24,50		STD - 025 - 050 075 - 100	1640.107	FIN967CR STD
----	----	---	-------	-------	-------	--	------------------------------	----------	--------------

MB	RP	3	59,95	63,67	25,53		STD - 025 - 050 075 - 100	1611.163	FIN968MB STD
----	----	---	-------	-------	-------	--	------------------------------	----------	--------------





MB	AM	1	60,00	88,00	26,00		STD - 025 - 050 BAR	8675.172	FIN996MB STD
----	----	---	-------	-------	-------	--	------------------------	----------	--------------



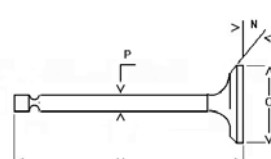

--	--	--	--	--	--	--	--	--	--

PB	BM	3	26,00	28,02	32,00		SEMIF.	1585.089	FIN302PB
----	----	---	-------	-------	-------	--	--------	----------	----------

TWS	AL	1	69,21	85,85	2,36		STD - 010	1257.048	FIN013TWS STD
-----	----	---	-------	-------	------	--	-----------	----------	---------------

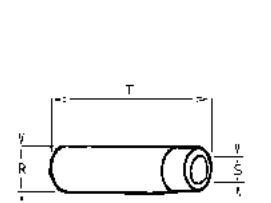
--	--	--	--	--	--	--	--	--	--

	IN EX		Nr.	O	P	M	N		ADATTABILE A: SUITABLE FOR:	
	IN	FS	3	38,5	8	114	45	E1	9652.071	FINA099
	EX	FN	3	33	8	114	45	A1	9685.075	FINS098

	IN EX		Nr.	R	S	T		ADATTABILE A: SUITABLE FOR:	
	IN	G	3	14,05	8,05	51	L	4845.129	FIN1448ASA
	EX	G	3	14,05	8,05	51	L	4845.129	FIN1448ASA

Ricambi non originali per motori. Denominazioni e codici originali, sono riportati a puro titolo di riferimento.

21 - 15

rel. 1511

Non original engine parts. OEMs names and part numbers are for reference purpose only.

SLANZI

DVA 1750	Cm³	CILINDRI CYLINDERS	ALESAGGIO BORE	CORSA STROKE	VERSIONE VERSION
	1755	3	92	100	

	8180.098	8180.108	1213.267	1213.258	4601.079			
FIN813CGA	FIN813CGB	FIN527SM	FIN3232RT	FIN892RT	FIN769CO			

 	ADATTABILE A: SUITABLE FOR:		Nr.	ENGINE KIT	ELECTRIC KIT
	4730.293	FIN6113HG	1	 FIN223SL00	
			1	 FIN223PC00	
			1	 FIN5486SM	
				FIN2055KIT	

3700.215	6727.030	5496.134		2175.065	2175.071		
FIN388AF	FIN682PF	FIN1012NF		FIN342FE	FIN436OF		

				4336.049			
				FIN087OP			

6585.054	6590.142	5010.012	6531.281	6578.135	9672.031		
FIN551FP	FIN626JP	FIN564NH	FIN091NO	FIN1225E	FIN016DV		

Ricambi non originali per motori. Denominazioni e codici originali, sono riportati a puro titolo di riferimento.



22 - 15







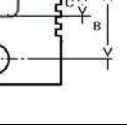

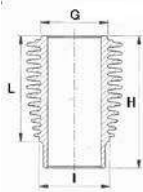
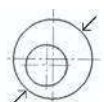
rel. 1511

Non original engine parts. OEMs names and part numbers are for reference purpose only.

SLANZI

DVA 1750 S	Cm³	CILINDRI CYLINDERS	ALESAGGIO BORE	CORSA STROKE	VERSIONE VERSION
	1755	3	92	100	

		TESTA HEAD	H03		3	2,5	TIPO TYPE	A			
					10	2,5					
					22	5					
										G	106
										H	170
										I	100
		L	132,20								
		92	6500.548	FIN223PC00	8211.095	FIN092RS00	2380.307		FIN223SL00		
		92,5	6500.549	FIN223PC05	8211.096	FIN092RS05					
		93	6500.690	FIN223PC10	8211.137	FIN092RS10					

		Nr.						ADATTABILE A: SUITABLE FOR:	
---	---	------------	---	---	---	---	---	--------------------------------	---

CR	AL	3	53,03	56,73	24,50		STD - 025 - 050 075 - 100	1640.107	FIN967CR STD
----	----	---	-------	-------	-------	--	------------------------------	----------	--------------

MB	RP	3	59,95	63,67	25,53		STD - 025 - 050 075 - 100	1611.163	FIN968MB STD
----	----	---	-------	-------	-------	--	------------------------------	----------	--------------





MB	AM	1	60,00	88,00	26,00		STD - 025 - 050 BAR	8675.172	FIN996MB STD
----	----	---	-------	-------	-------	--	------------------------	----------	--------------



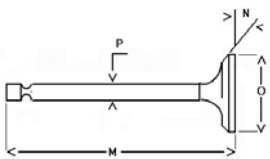

--	--	--	--	--	--	--	--	--	--

PB	BM	3	26,00	28,02	32,00		SEMIF.	1585.089	FIN302PB
----	----	---	-------	-------	-------	--	--------	----------	----------

TWS	AL	1	69,21	85,85	2,36		STD - 010	1257.048	FIN013TWS STD
-----	----	---	-------	-------	------	--	-----------	----------	---------------

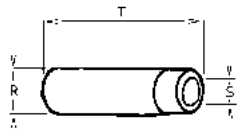
--	--	--	--	--	--	--	--	--	--

	IN EX		Nr.	O	P	M	N		ADATTABILE A: SUITABLE FOR:									
									IN	FS	3	38,5	8	114	45	E1	9652.071	FINA099
									EX	FN	3	33	8	114	45	A1	9685.075	FINS098

	IN EX		Nr.	R	S	T		ADATTABILE A: SUITABLE FOR:								
								IN	G	3	14,05	8,05	51	L	4845.129	FIN1448ASA
								EX	G	3	14,05	8,05	51	L	4845.129	FIN1448ASA

Ricambi non originali per motori. Denominazioni e codici originali, sono riportati a puro titolo di riferimento.

23 - 15

rel. 1511

Non original engine parts. OEMs names and part numbers are for reference purpose only.

SLANZI

DVA 1750 S	Cm³	CILINDRI CYLINDERS	ALESAGGIO BORE	CORSA STROKE	VERSIONE VERSION
	1755	3	92	100	

	8180.098	8180.108	1213.267	1213.258	4601.079			
FIN813CGA	FIN813CGB	FIN527SM	FIN3232RT	FIN892RT	FIN769CO			

 	ADATTABILE A: SUITABLE FOR:		Nr.	ENGINE KIT	ELECTRIC KIT
	4730.293	FIN6113HG	1	 FIN223SL00	
			1	 FIN223PC00	
			1	 FIN5486SM	
				FIN2055KIT	

3700.221		5496.146		2175.065	2175.071		
FIN402AF		FIN1013NF		FIN342FE	FIN436OF		

				4336.049			
				FIN087OP			

6585.062	6590.142	5010.012	6531.281	6578.135	9672.031		
FIN552FP	FIN626JP	FIN564NH	FIN091NO	FIN1225E	FIN016DV		

Ricambi non originali per motori. Denominazioni e codici originali, sono riportati a puro titolo di riferimento.



24 - 15







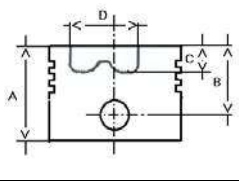

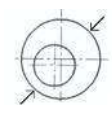
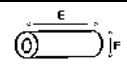
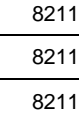
rel. 1511

Non original engine parts. OEMs names and part numbers are for reference purpose only.

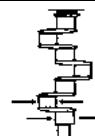
SLANZI

DVA 2350	Cm³	CILINDRI CYLINDERS	ALESAGGIO BORE	CORSA STROKE	VERSIONE VERSION
		4	92	100	

		TESTA HEAD	H03		3	2,5	TIPO TYPE	A	
		A	93		10	2,5		G	106
	FIN760PN		E	70		22	5	H	170
	8480.058		F	26		8211.095	FIN092RS00	I	100
	92	6500.548	FIN223PC00		8211.096	FIN092RS05		L	132,20
	92,5	6500.549	FIN223PC05		8211.137	FIN092RS10		2380.307	
	93	6500.690	FIN223PC10				FIN223SL00		

		Nr.						ADATTABILE A: SUITABLE FOR:	
---	---	------------	---	---	---	---	---	--------------------------------	---

CR	AL	4	53,03	56,73	24,50		STD - 025 - 050 075 - 100	1640.107	FIN967CR STD
----	----	---	-------	-------	-------	--	------------------------------	----------	--------------

MB	RP	4	59,95	63,67	25,53		STD - 025 - 050 075 - 100	1611.163	FIN968MB STD
----	----	---	-------	-------	-------	--	------------------------------	----------	--------------





MB	AM	1	60,00	88,00	26,00		STD - 025 - 050 BAR	8675.172	FIN996MB STD
----	----	---	-------	-------	-------	--	------------------------	----------	--------------



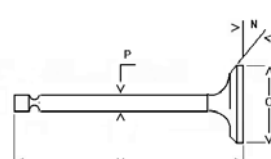

--	--	--	--	--	--	--	--	--	--

PB	BM	4	26,00	28,02	32,00		SEMIF.	1585.089	FIN302PB
----	----	---	-------	-------	-------	--	--------	----------	----------

TWS	AL	1	69,21	85,85	2,36		STD - 010	1257.048	FIN013TWS STD
-----	----	---	-------	-------	------	--	-----------	----------	---------------

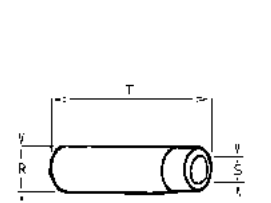
--	--	--	--	--	--	--	--	--	--

	IN EX		Nr.	O	P	M	N		ADATTABILE A: SUITABLE FOR:			
	IN		FS	4	38,5	8	114		45	E1	9652.071	FINA099
	EX		FN	4	33	8	114		45	A1	9685.075	FINS098

	IN EX		Nr.	R	S	T		ADATTABILE A: SUITABLE FOR:			
	IN		G	4	14,05	8,05		51	L	4845.129	FIN1448ASA
	EX		G	4	14,05	8,05		51	L	4845.129	FIN1448ASA

Ricambi non originali per motori. Denominazioni e codici originali, sono riportati a puro titolo di riferimento.

25 - 15

rel. 1511

Non original engine parts. OEMs names and part numbers are for reference purpose only.

SLANZI

DVA 2350	Cm³	CILINDRI CYLINDERS	ALESAGGIO BORE	CORSA STROKE	VERSIONE VERSION
		4	92	100	

	8180.100	8180.113	1213.267	1213.258				
FIN816CGA	FIN816CGB	FIN5488SM	FIN3232RT	FIN892RT				

 	ADATTABILE A: SUITABLE FOR:		Nr.	ENGINE KIT	ELECTRIC KIT
	4730.293	FIN6113HG	1	 FIN223SL00	
			1	 FIN223PC00	
			1	 FIN5486SM	
				FIN2055KIT	

3700.221		5496.146		2175.067	2175.071		
FIN402AF		FIN1013NF		FIN1027FE	FIN436OF		

6585.054	6590.145	5010.012	6531.281	6578.135	9672.031		
FIN551FP	FIN634JP	FIN564NH	FIN091NO	FIN1225E	FIN016DV		

Ricambi non originali per motori. Denominazioni e codici originali, sono riportati a puro titolo di riferimento.



26 - 15







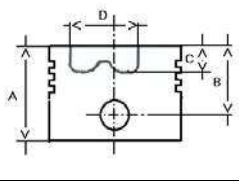

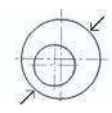
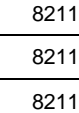
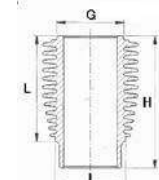
rel. 1511

Non original engine parts. OEMs names and part numbers are for reference purpose only.

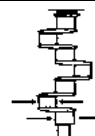
SLANZI

DVA 1500	Cm³	CILINDRI CYLINDERS	ALESAGGIO BORE	CORSA STROKE	VERSIONE VERSION
	1447	2	96	100	

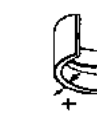
		TESTA HEAD	H17		3	2,5	TIPO TYPE	A	
		A	106		1	2,5		G	112
	FIN985PN	E	78		14	2,5		H	192
	8480.067	F	28		17	5,5		I	105
	96	6500.615	FIN685PC00	8211.122	FIN521RS00		L	154,70	
	96,5	6500.616	FIN685PC05	8211.123	FIN521RS05		2380.328		FIN685SL00
	97	6500.685	FIN685PC10	8211.136	FIN521RS10				

		Nr.						ADATTABILE A: SUITABLE FOR:	
---	---	------------	---	---	---	---	---	--	---

CR	AL	2	57,12	60,84	27,00		STD - 025 - 050 075 - 100	1640.092	FIN959CR STD
----	----	---	-------	-------	-------	--	------------------------------	----------	--------------

MB	AL	2	58,00	63,04	30,25		BAR	1585.124	FIN964MB STD
----	----	---	-------	-------	-------	--	-----	----------	--------------





MB	AL	1	62,98	66,68	31,88		STD - 025 - 050 075 - 100	1611.101	FIN993MB STD
----	----	---	-------	-------	-------	--	------------------------------	----------	--------------



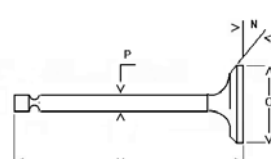

--	--	--	--	--	--	--	--	--	--

PB	BM	2	28,00	30,02	34,00		SEMIF.	1585.090	FIN334PB
----	----	---	-------	-------	-------	--	--------	----------	----------

TWS	AL	2	69,21	85,85	2,36		STD - 010	1257.048	FIN013TWS STD
-----	----	---	-------	-------	------	--	-----------	----------	---------------

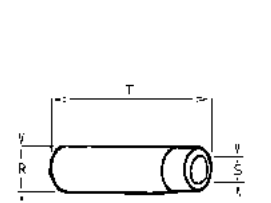
--	--	--	--	--	--	--	--	--	--

	IN EX		Nr.	O	P	M	N		ADATTABILE A: SUITABLE FOR:			
	IN		FS	2	40	9	125		45	E3	9652.088	FINA074
	EX		FS	2	34	9	125		45	A3	9685.091	FINS075

	IN EX		Nr.	R	S	T		ADATTABILE A: SUITABLE FOR:			
	IN		G	2	15,03	9,03		66	F	4845.150	FIN601AA
	EX		G	2	15,03	9,03		61	F	4845.145	FIN602SA

Ricambi non originali per motori. Denominazioni e codici originali, sono riportati a puro titolo di riferimento.

27 - 15

rel. 1511

Non original engine parts. OEMs names and part numbers are for reference purpose only.

SLANZI

DVA 1500	Cm³	CILINDRI CYLINDERS	ALESAGGIO BORE	CORSA STROKE	VERSIONE VERSION
	1447	2	96	100	

	8180.141	8180.155	1210.039	1213.266	4601.071	1200.198		
FIN804CGA	FIN804CGB	FIN524SM	FIN976RT	FIN3233RT	FIN210CO	FIN018CB		

 	ADATTABILE A: SUITABLE FOR:		<table border="1"> <tr> <th>Nr.</th> <th>ENGINE KIT</th> </tr> <tr> <td>1</td> <td> FIN685SL00</td> </tr> <tr> <td>1</td> <td> FIN685PC00</td> </tr> <tr> <td>1</td> <td> FIN5279SM</td> </tr> <tr> <td colspan="2">FIN2146KIT</td> </tr> </table>	Nr.	ENGINE KIT	1	 FIN685SL00	1	 FIN685PC00	1	 FIN5279SM	FIN2146KIT		<table border="1"> <tr> <th colspan="2">ELECTRIC KIT</th> </tr> <tr> <td colspan="2"> </td> </tr> </table>		ELECTRIC KIT			
	Nr.	ENGINE KIT																	
	1	 FIN685SL00																	
	1	 FIN685PC00																	
1	 FIN5279SM																		
FIN2146KIT																			
ELECTRIC KIT																			
	4730.303	FIN6287HG																	

3700.233		5496.135		2175.076	2175.088		
FIN703AF		FIN722NF		FIN603FE	FIN1093OF		

6585.064	6590.139	5010.014	6531.283	6578.135	9672.031		
FIN839FP	FIN625JP	FIN565NH	FIN092NO	FIN1225E	FIN016DV		

Ricambi non originali per motori. Denominazioni e codici originali, sono riportati a puro titolo di riferimento.



28 - 15







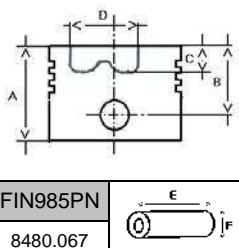

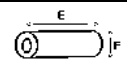
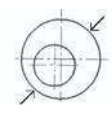
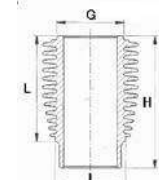
rel. 1511

Non original engine parts. OEMs names and part numbers are for reference purpose only.

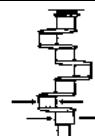
SLANZI

DVA 2200	Cm³	CILINDRI CYLINDERS	ALESAGGIO BORE	CORSA STROKE	VERSIONE VERSION
	2170	3	96	100	

		TESTA HEAD	H17		3	2,5	TIPO TYPE	A	
		A	106		1	2,5		G	112
		B	61		14	2,5		H	192
		C	18,6		17	5,5		I	105
		D	52					L	154,7
	FIN985PN 	E	78						
	8480.067	F	28						
	96	6500.615	FIN685PC00	8211.122	FIN521RS00		2380.328		FIN685SL00
	96,5	6500.616	FIN685PC05	8211.123	FIN521RS05				
	97	6500.685	FIN685PC10	8211.136	FIN521RS10				

		Nr.						ADATTABILE A: SUITABLE FOR:	
---	---	------------	---	---	---	---	---	--------------------------------	---

CR	AL	3	57,12	60,84	27,00		STD - 025 - 050 075 - 100	1640.092	FIN959CR STD
----	----	---	-------	-------	-------	--	------------------------------	----------	--------------

MB	AL	3	62,98	66,68	31,88		STD - 025 - 050 075 - 100	1611.101	FIN993MB STD
----	----	---	-------	-------	-------	--	------------------------------	----------	--------------





MB	AL	1	70,00	75,00	34,13		BAR	1585.128	FIN994MB STD
----	----	---	-------	-------	-------	--	-----	----------	--------------



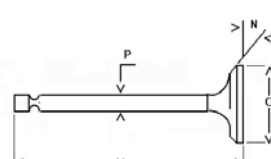

--	--	--	--	--	--	--	--	--	--

PB	BM	3	28,00	30,02	34,00		SEMIF.	1585.090	FIN334PB
----	----	---	-------	-------	-------	--	--------	----------	----------

TWS	AL	2	69,21	85,85	2,36		STD - 010	1257.048	FIN013TWS STD
-----	----	---	-------	-------	------	--	-----------	----------	---------------

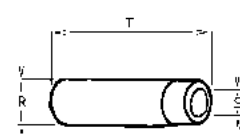
--	--	--	--	--	--	--	--	--	--

	IN EX		Nr.	O	P	M	N		ADATTABILE A: SUITABLE FOR:			
	IN		FS	3	40	9	125		45	E3	9652.088	FINA074
	EX		FS	3	34	9	125		45	A3	9685.091	FINS075

	IN EX		Nr.	R	S	T		ADATTABILE A: SUITABLE FOR:			
	IN		G	3	15,03	9,03		66	F	4845.150	FIN601AA
	EX		G	3	15,03	9,03		61	F	4845.145	FIN602SA

Ricambi non originali per motori. Denominazioni e codici originali, sono riportati a puro titolo di riferimento.

29 - 15

rel. 1511

Non original engine parts. OEMs names and part numbers are for reference purpose only.

SLANZI

DVA 2200	Cm³	CILINDRI CYLINDERS	ALESAGGIO BORE	CORSA STROKE	VERSIONE VERSION
	2170	3	96	100	

			1210.050	1210.050		1200.198		
		FIN5493SM	FIN3236RT	FIN3236RT		FIN018CB		

 	ADATTABILE A: SUITABLE FOR:		Nr.	ENGINE KIT	ELECTRIC KIT
	4730.303	FIN6287HG	1	 FIN685SL00	
			1	 FIN685PC00	
			1	 FIN5279SM	
				FIN2146KIT	

				2175.080	2175.089		
				FIN604FE	FIN1094OF		

6585.064							
FIN839FP							

Ricambi non originali per motori. Denominazioni e codici originali, sono riportati a puro titolo di riferimento.



30 - 15







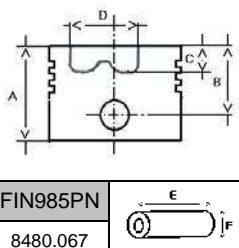

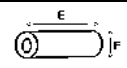
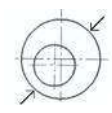
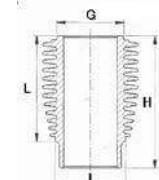
rel. 1511

Non original engine parts. OEMs names and part numbers are for reference purpose only.

SLANZI

DVA 2900	Cm³	CILINDRI CYLINDERS	ALESAGGIO BORE	CORSA STROKE	VERSIONE VERSION
	2893	4	96	100	

		TESTA HEAD	H17		3	2,5	TIPO TYPE	A	
		A	106		1	2,5		G	112
		B	61		14	2,5		H	192
		C	18,6		17	5,5		I	105
		D	52					L	154,7
	FIN985PN 	E	78						
	8480.067	F	28						
	96	6500.615	FIN685PC00	8211.122	FIN521RS00		2380.328		FIN685SL00
	96,5	6500.616	FIN685PC05	8211.123	FIN521RS05				
	97	6500.685	FIN685PC10	8211.136	FIN521RS10				

		Nr.						ADATTABILE A: SUITABLE FOR:	
---	---	------------	---	---	---	---	---	--------------------------------	---

CR	AL	4	57,12	60,84	27,00		STD - 025 - 050 075 - 100	1640.092	FIN959CR STD
----	----	---	-------	-------	-------	--	------------------------------	----------	--------------

MB	AL	4	62,98	66,68	31,88		STD - 025 - 050 075 - 100	1611.101	FIN993MB STD
----	----	---	-------	-------	-------	--	------------------------------	----------	--------------





MB	AL	1	70,00	75,00	34,13		BAR	1585.128	FIN994MB STD
----	----	---	-------	-------	-------	--	-----	----------	--------------



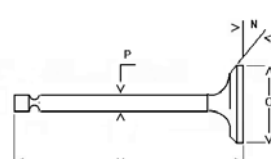

--	--	--	--	--	--	--	--	--	--

PB	BM	4	28,00	30,02	34,00		SEMIF.	1585.090	FIN334PB
----	----	---	-------	-------	-------	--	--------	----------	----------

TWS	AL	2	69,21	85,85	2,36		STD - 010	1257.048	FIN013TWS STD
-----	----	---	-------	-------	------	--	-----------	----------	---------------

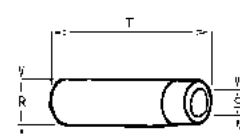
--	--	--	--	--	--	--	--	--	--

	IN EX		Nr.	O	P	M	N		ADATTABILE A: SUITABLE FOR:			
	IN		FS	4	40	9	125		45	E3	9652.088	FINA074
	EX		FS	4	34	9	125		45	A3	9685.091	FINS075

	IN EX		Nr.	R	S	T		ADATTABILE A: SUITABLE FOR:			
	IN		G	4	15,03	9,03		66	F	4845.150	FIN601AA
	EX		G	4	15,03	9,03		61	F	4845.145	FIN602SA

Ricambi non originali per motori. Denominazioni e codici originali, sono riportati a puro titolo di riferimento.

31 - 15

rel. 1511

Non original engine parts. OEMs names and part numbers are for reference purpose only.

SLANZI

DVA 2900	Cm³	CILINDRI CYLINDERS	ALESAGGIO BORE	CORSA STROKE	VERSIONE VERSION
	2893	4	96	100	

		8180.157	1210.050	1210.050		1200.198		
		FIN5494SM	FIN3236RT	FIN3236RT		FIN018CB		

 	ADATTABILE A: SUITABLE FOR:		Nr.	ENGINE KIT	ELECTRIC KIT
	4730.303	FIN6287HG	1	 FIN685SL00	
			1	 FIN685PC00	
			1	 FIN5279SM	
				FIN2146KIT	

3700.235		5496.134		2175.080	2175.089		
FIN699AF		FIN1012NF		FIN604FE	FIN1094OF		

6585.064							
FIN839FP							

Ricambi non originali per motori. Denominazioni e codici originali, sono riportati a puro titolo di riferimento.



32 - 15







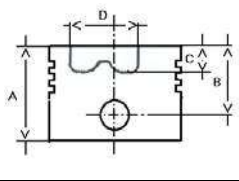

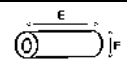
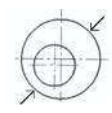
rel. 1511

Non original engine parts. OEMs names and part numbers are for reference purpose only.

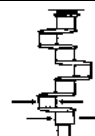
SLANZI

DVA 1800	Cm³	CILINDRI CYLINDERS	ALESAGGIO BORE	CORSA STROKE	VERSIONE VERSION
	1792	2	100	114	

		TESTA HEAD	A			3	2,5	TIPO TYPE		
			B	63		10	2,5		G	
			C	20,7		22	5		H	
			D	58,5					I	
			E	85					L	
			F	32						
	FIN625PN 									
	8480.071									
	100	6500.621	FIN225PC00		8211.131	FIN094RS00				
	100,5	6500.622	FIN225PC05		8211.132	FIN094RS05				
	101		FIN225PC10			FIN094RS10				

		Nr.						ADATTABILE A: SUITABLE FOR:	
---	---	------------	---	---	---	---	---	--------------------------------	---

CR	AL	2						STD - 025 - 050	1640.113	FIN4114CR STD
----	----	---	--	--	--	--	--	-----------------	----------	---------------

MB	RP	1	75,00	78,60	25,20			BAR	1585.102	FIN966MB STD
----	----	---	-------	-------	-------	--	--	-----	----------	--------------





MB	AL	2	70,00	74,30	30,00			STD - 025 - 050	1611.166	FIN969MB STD
----	----	---	-------	-------	-------	--	--	-----------------	----------	--------------



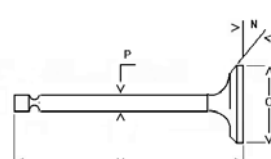

--	--	--	--	--	--	--	--	--	--	--

PB	BM	2	32,00	34,00	33,00			SEMIF.	1585.117	FIN817PB
----	----	---	-------	-------	-------	--	--	--------	----------	----------

TWS	AL	2						STD - 010	1257.051	FIN917TWS STD
-----	----	---	--	--	--	--	--	-----------	----------	---------------

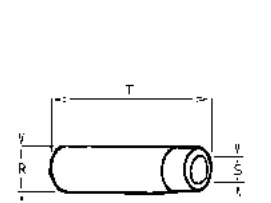
--	--	--	--	--	--	--	--	--	--	--

	IN EX		Nr.	O	P	M	N		ADATTABILE A: SUITABLE FOR:	
	IN	FS	2	44	9	123	45	A3	9652.068	FINA138
	EX	FN	2	38	9	123	45	A3	9685.076	FINS139

	IN EX		Nr.	R	S	T		ADATTABILE A: SUITABLE FOR:	
	IN		2					4845.131	FIN1449ASA
	EX		2					4845.131	FIN1449ASA

Ricambi non originali per motori. Denominazioni e codici originali, sono riportati a puro titolo di riferimento.

33 - 15

rel. 1511

Non original engine parts. OEMs names and part numbers are for reference purpose only.

SLANZI

DVA 1800	Cm³	CILINDRI CYLINDERS	ALESAGGIO BORE	CORSA STROKE	VERSIONE VERSION
	1792	2	100	114	

	8180.146	8180.158	1213.265	1213.259	4775.339			
FIN820CGA	FIN820CGB	FIN532SM	FIN3245RT	FIN3246RT	FIN780CO			

 ADATTABILE A: SUITABLE FOR:	 FIN6248HG	Nr.		ENGINE KIT		ELECTRIC KIT	
		1					
		1					
		1					



3700.218		5496.136		2175.065	2175.070		
FIN705AF		FIN1083NF		FIN342FE	FIN1099OF		







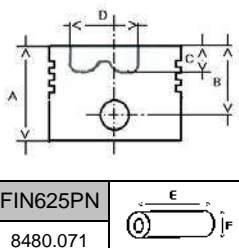
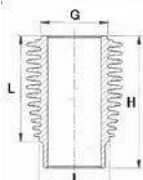
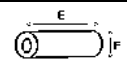

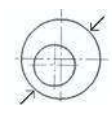
6585.064	6590.165	5010.014	6531.283	6578.159	9672.031		
FIN839FP	FIN628JP	FIN565NH	FIN092NO	FIN068E	FIN016DV		

Ricambi non originali per motori. Denominazioni e codici originali, sono riportati a puro titolo di riferimento.

SLANZI

DVA 2700	Cm³	CILINDRI CYLINDERS	ALESAGGIO BORE	CORSA STROKE	VERSIONE VERSION
	2686	3	100	114	

		TESTA HEAD	A	3	2,5	TIPO TYPE		G
			B					10
FIN625PN 8480.071		C 20,7 D 58,5 E 85 F 32		22	5			I
	100	6500.621	FIN225PC00	8211.131	FIN094RS00			
	100,5	6500.622	FIN225PC05	8211.132	FIN094RS05			
	101		FIN225PC10		FIN094RS10			

		Nr.						ADATTABILE A: SUITABLE FOR:	
---	---	------------	---	---	---	---	---	--------------------------------	---

CR	AL	3						STD - 025 - 050	1640.113	FIN4114CR STD
----	----	---	--	--	--	--	--	-----------------	----------	---------------

MB	RP	1	75,00	78,60	25,20			BAR	1585.102	FIN966MB STD
----	----	---	-------	-------	-------	--	--	-----	----------	--------------





MB	AL	3	70,00	74,30	30,00			STD - 025 - 050	1611.166	FIN969MB STD
----	----	---	-------	-------	-------	--	--	-----------------	----------	--------------



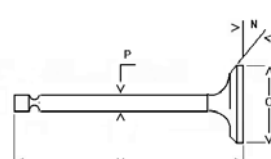

--	--	--	--	--	--	--	--	--	--	--

PB	BM	3	32,00	34,00	33,00			SEMIF.	1585.117	FIN817PB
----	----	---	-------	-------	-------	--	--	--------	----------	----------

TWS	AL	2						STD - 010	1257.051	FIN917TWS STD
-----	----	---	--	--	--	--	--	-----------	----------	---------------

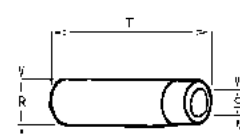
--	--	--	--	--	--	--	--	--	--	--

	IN EX		Nr.	O	P	M	N		ADATTABILE A: SUITABLE FOR:								
	IN								FS	3	44	9	123	45	A3	9652.068	FINA138
	EX								FN	3	38	9	123	45	A3	9685.076	FINS139

	IN EX		Nr.	R	S	T		ADATTABILE A: SUITABLE FOR:							
	IN								3					4845.131	FIN1449ASA
	EX								3					4845.131	FIN1449ASA

Ricambi non originali per motori. Denominazioni e codici originali, sono riportati a puro titolo di riferimento.

35 - 15
rel. 1511

Non original engine parts. OEMs names and part numbers are for reference purpose only.

SLANZI

DVA 2700	Cm³	CILINDRI CYLINDERS	ALESAGGIO BORE	CORSA STROKE	VERSIONE VERSION
	2686	3	100	114	

	8180.147	8180.159	1213.265	1213.259	4775.340			
FIN821CGA	FIN821CGB	FIN533SM	FIN3245RT	FIN3246RT	FIN781CO			

 	ADATTABILE A: SUITABLE FOR:		Nr.	ENGINE KIT	ELECTRIC KIT
	4730.304	FIN6248HG	1		
			1		
			1		

3700.218		5496.136		2175.067	2175.069		
FIN705AF		FIN1083NF		FIN1027FE	FIN1098OF		

6585.064	6590.176	5010.014	6531.283	6578.159	9672.031		
FIN839FP	FIN629JP	FIN565NH	FIN092NO	FIN068E	FIN016DV		

Ricambi non originali per motori. Denominazioni e codici originali, sono riportati a puro titolo di riferimento.



36 - 15







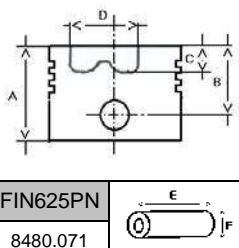

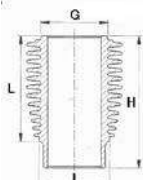
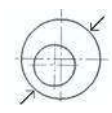
rel. 1511

Non original engine parts. OEMs names and part numbers are for reference purpose only.

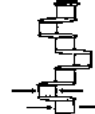
SLANZI

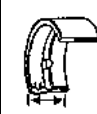
DVA 3600	Cm³	CILINDRI CYLINDERS	ALESAGGIO BORE	CORSA STROKE	VERSIONE VERSION
		4	100	114	

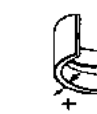
		TESTA HEAD A B 63 C 20,7 D 58,5 E 85 F 32		3 2,5 10 2,5 22 5	TIPO TYPE 	G	
						H	
	100	6500.621	FIN225PC00	8211.131	FIN094RS00		
	100,5	6500.622	FIN225PC05	8211.132	FIN094RS05		
	101		FIN225PC10		FIN094RS10		

		Nr.						ADATTABILE A: SUITABLE FOR:	
---	---	------------	---	---	---	---	---	--------------------------------	---

CR	AL	4						STD - 025 - 050	1640.113	FIN4114CR STD
----	----	---	--	--	--	--	--	-----------------	----------	---------------

MB	RP	1	75,00	78,60	25,20			BAR	1585.102	FIN966MB STD
----	----	---	-------	-------	-------	--	--	-----	----------	--------------





MB	AL	4	70,00	74,30	30,00			STD - 025 - 050	1611.166	FIN969MB STD
----	----	---	-------	-------	-------	--	--	-----------------	----------	--------------



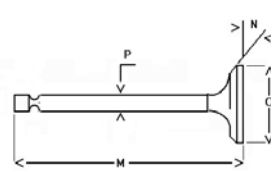

--	--	--	--	--	--	--	--	--	--	--

PB	BM	4	32,00	34,00	33,00			SEMIF.	1585.117	FIN817PB
----	----	---	-------	-------	-------	--	--	--------	----------	----------

TWS	AL	2						STD - 010	1257.051	FIN917TWS STD
-----	----	---	--	--	--	--	--	-----------	----------	---------------

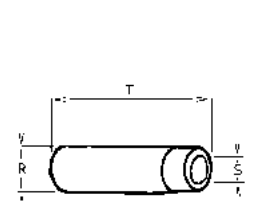
--	--	--	--	--	--	--	--	--	--	--

	IN EX		Nr.	O	P	M	N		ADATTABILE A: SUITABLE FOR:			
	IN		FS	4	44	9	123		45	A3	9652.068	FINA138
	EX		FN	4	38	9	123		45	A3	9685.076	FINS139

	IN EX		Nr.	R	S	T		ADATTABILE A: SUITABLE FOR:			
	IN			4						4845.131	FIN1449ASA
	EX			4						4845.131	FIN1449ASA

Ricambi non originali per motori. Denominazioni e codici originali, sono riportati a puro titolo di riferimento.

37 - 15

rel. 1511

Non original engine parts. OEMs names and part numbers are for reference purpose only.

SLANZI

DVA 3600	Cm³	CILINDRI CYLINDERS	ALESAGGIO BORE	CORSA STROKE	VERSIONE VERSION
		4	100	114	

	8180.148	8180.160	1213.265	1213.259	4775.341			
FIN882CGA	FIN882CGB	FIN534SM	FIN3245RT	FIN3246RT	FIN782CO			

 	ADATTABILE A: SUITABLE FOR:		Nr.	ENGINE KIT	ELECTRIC KIT
	4730.304	FIN6248HG	1		
			1		
			1		

3700.219		5496.137		2175.067	2175.069		
FIN706AF		FIN1085NF		FIN1027FE	FIN1098OF		

6585.064	6590.176	5010.014	6531.283	6578.159	9672.031		
FIN839FP	FIN629JP	FIN565NH	FIN092NO	FIN068E	FIN016DV		

Ricambi non originali per motori. Denominazioni e codici originali, sono riportati a puro titolo di riferimento.





38 - 15





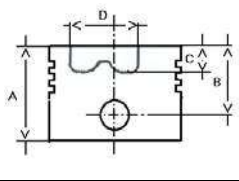

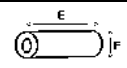

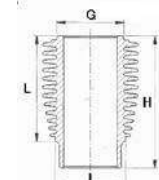
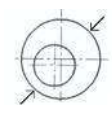
rel. 1511

Non original engine parts. OEMs names and part numbers are for reference purpose only.

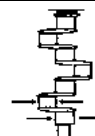
SLANZI

DS 2000	Cm³	CILINDRI CYLINDERS	ALESAGGIO BORE	CORSA STROKE	VERSIONE VERSION
		2	105		

		TESTA HEAD	A		3	2,5	TIPO TYPE	A	
			B		63	10		2,5	G
	FIN626PN	C	16,9		22	5		H	
		D	68,2					I	
	105	6500.550	FIN591PC00	8211.097	FIN592RS00	2380.308	L		
	105,5	6500.551	FIN591PC05	8211.098	FIN592RS05		FIN593SL00		
	106		FIN591PC10		FIN592RS10				

		Nr.						ADATTABILE A: SUITABLE FOR:	
---	---	------------	---	---	---	---	---	--------------------------------	---

CR	AL	2					STD - 025 - 050	1640.113	FIN4114CR STD
----	----	---	--	--	--	--	-----------------	----------	---------------

MB	RP	1	75,00	78,60	25,20		BAR	1585.102	FIN966MB STD
----	----	---	-------	-------	-------	--	-----	----------	--------------





MB	AL	2	70,00	74,30	30,00		STD - 025 - 050	1611.166	FIN969MB STD
----	----	---	-------	-------	-------	--	-----------------	----------	--------------



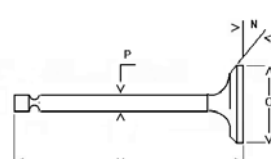

--	--	--	--	--	--	--	--	--	--

PB	BM	2					SEMIF.	1585.091	FIN335PB
----	----	---	--	--	--	--	--------	----------	----------

TWS	AL	2					STD - 010	1257.051	FIN917TWS STD
-----	----	---	--	--	--	--	-----------	----------	---------------

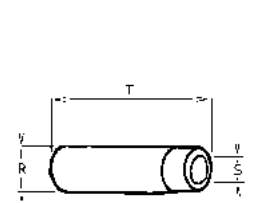
--	--	--	--	--	--	--	--	--	--

	IN EX		Nr.	O	P	M	N		ADATTABILE A: SUITABLE FOR:	
	IN		2						9652.069	FINA4936
	EX		2						9685.077	FINS4937

	IN EX		Nr.	R	S	T		ADATTABILE A: SUITABLE FOR:	
	IN		2					4845.131	FIN1449ASA
	EX		2					4845.131	FIN1449ASA

Ricambi non originali per motori. Denominazioni e codici originali, sono riportati a puro titolo di riferimento.

39 - 15

rel. 1511

Non original engine parts. OEMs names and part numbers are for reference purpose only.

SLANZI

DS 2000	Cm³	CILINDRI CYLINDERS	ALESAGGIO BORE	CORSA STROKE	VERSIONE VERSION
		2	105		

	8180.102	8180.110	1213.265	1213.259				
FIN817CGA	FIN817CGB	FIN535SM	FIN3245RT	FIN3246RT				

 	ADATTABILE A: SUITABLE FOR:		Nr.	ENGINE KIT	ELECTRIC KIT
	4730.295	FIN6249HG	1	 FIN593SL00	
			1	 FIN591PC00	
			1	 FIN538SM	
				FIN2147KIT	

3700.218		5496.136		2175.065	2175.070		
FIN705AF		FIN1083NF		FIN342FE	FIN1099OF		

6585.064	6590.165	5010.014	6531.283	6578.159	9672.031		
FIN839FP	FIN628JP	FIN565NH	FIN092NO	FIN068E	FIN016DV		

Ricambi non originali per motori. Denominazioni e codici originali, sono riportati a puro titolo di riferimento.





40 - 15





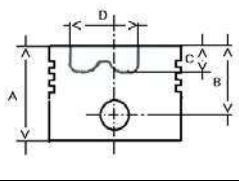

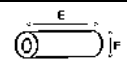
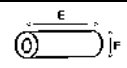

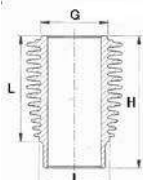
rel. 1511

Non original engine parts. OEMs names and part numbers are for reference purpose only.

SLANZI

DS 3000	Cm³	CILINDRI CYLINDERS	ALESAGGIO BORE	CORSA STROKE	VERSIONE VERSION
		3	105		

		TESTA HEAD	A		3	2,5	TIPO TYPE	A	
			B		63	10		2,5	G
	FIN626PN	C	16,9		22	5	H		
		D	68,2				I		
	105	6500.550	FIN591PC00	8211.097	FIN592RS00		L		
	105,5	6500.551	FIN591PC05	8211.098	FIN592RS05		2380.308	FIN593SL00	
	106		FIN591PC10		FIN592RS10				

		Nr.							ADATTABILE A: SUITABLE FOR:	
---	---	------------	---	---	---	---	---	--	--------------------------------	---

CR	AL	3						STD - 025 - 050	1640.113	FIN4114CR STD
----	----	---	--	--	--	--	--	-----------------	----------	---------------

MB	RP	1	75,00	78,60	25,20			BAR	1585.102	FIN966MB STD
----	----	---	-------	-------	-------	--	--	-----	----------	--------------





MB	AL	3	70,00	74,30	30,00			STD - 025 - 050	1611.166	FIN969MB STD
----	----	---	-------	-------	-------	--	--	-----------------	----------	--------------



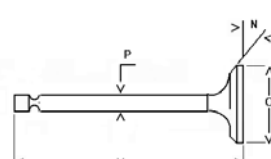

--	--	--	--	--	--	--	--	--	--	--

PB	BM	3						SEMIF.	1585.091	FIN335PB
----	----	---	--	--	--	--	--	--------	----------	----------

TWS	AL	2						STD - 010	1257.051	FIN917TWS STD
-----	----	---	--	--	--	--	--	-----------	----------	---------------

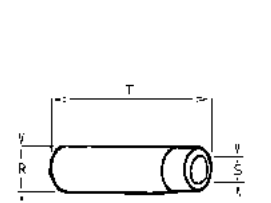
--	--	--	--	--	--	--	--	--	--	--

	IN EX		Nr.	O	P	M	N		ADATTABILE A: SUITABLE FOR:							
									IN	3					9652.069	FINA4936
									EX	3					9685.077	FINS4937

	IN EX		Nr.	R	S	T		ADATTABILE A: SUITABLE FOR:							
								IN	3					4845.131	FIN1449ASA
								EX	3					4845.131	FIN1449ASA

Ricambi non originali per motori. Denominazioni e codici originali, sono riportati a puro titolo di riferimento.

41 - 15

rel. 1511

Non original engine parts. OEMs names and part numbers are for reference purpose only.

SLANZI

DS 3000	Cm³	CILINDRI CYLINDERS	ALESAGGIO BORE	CORSA STROKE	VERSIONE VERSION
		3	105		

	8180.103	8180.111	1213.265	1213.259				
FIN818CGA	FIN818CGB	FIN536SM	FIN3245RT	FIN3246RT				

 	ADATTABILE A: SUITABLE FOR:		Nr.	ENGINE KIT	ELECTRIC KIT
	4730.295	FIN6249HG	1	 FIN593SL00	
			1	 FIN591PC00	
			1	 FIN538SM	
				FIN2147KIT	

3700.218		5496.136		2175.067	2175.069		
FIN705AF		FIN1083NF		FIN1027FE	FIN1098OF		

6585.064	6590.176	5010.014	6531.283	6578.159	9672.031		
FIN839FP	FIN629JP	FIN565NH	FIN092NO	FIN068E	FIN016DV		

Ricambi non originali per motori. Denominazioni e codici originali, sono riportati a puro titolo di riferimento.



42 - 15







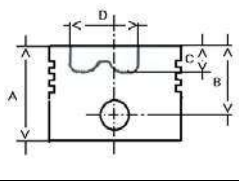

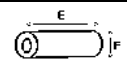
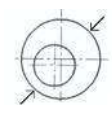
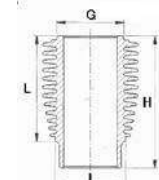
rel. 1511

Non original engine parts. OEMs names and part numbers are for reference purpose only.

SLANZI

DS 4000	Cm³	CILINDRI CYLINDERS	ALESAGGIO BORE	CORSA STROKE	VERSIONE VERSION
		4	105		

		TESTA HEAD	A		3	2,5	TIPO TYPE	A	
			B		63	10		2,5	G
FIN626PN		C	16,9		22	5	H		
		D	68,2				I		
	105	6500.550	FIN591PC00	8211.097	FIN592RS00		L		
	105,5	6500.551	FIN591PC05	8211.098	FIN592RS05		2380.308	FIN593SL00	
	106		FIN591PC10		FIN592RS10				

		Nr.						ADATTABILE A: SUITABLE FOR:	
---	---	------------	---	---	---	---	---	--------------------------------	---

CR	AL	4					STD - 025 - 050	1640.113	FIN4114CR STD
----	----	---	--	--	--	--	-----------------	----------	---------------

MB	RP	1	75,00	78,60	25,20		BAR	1585.102	FIN966MB STD
----	----	---	-------	-------	-------	--	-----	----------	--------------





MB	AL	4	70,00	74,30	30,00		STD - 025 - 050	1611.166	FIN969MB STD
----	----	---	-------	-------	-------	--	-----------------	----------	--------------



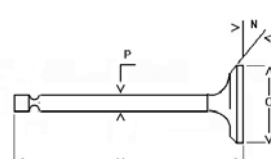

--	--	--	--	--	--	--	--	--	--

PB	BM	4					SEMIF.	1585.091	FIN335PB
----	----	---	--	--	--	--	--------	----------	----------

TWS	AL	2					STD - 010	1257.051	FIN917TWS STD
-----	----	---	--	--	--	--	-----------	----------	---------------

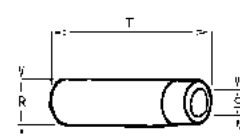
--	--	--	--	--	--	--	--	--	--

	IN EX		Nr.	O	P	M	N		ADATTABILE A: SUITABLE FOR:	
	IN		4						9652.069	FINA4936
	EX		4						9685.077	FINS4937

	IN EX		Nr.	R	S	T		ADATTABILE A: SUITABLE FOR:	
	IN		4					4845.131	FIN1449ASA
	EX		4					4845.131	FIN1449ASA

Ricambi non originali per motori. Denominazioni e codici originali, sono riportati a puro titolo di riferimento.

43 - 15

rel. 1511

Non original engine parts. OEMs names and part numbers are for reference purpose only.

SLANZI

DS 4000	Cm³	CILINDRI CYLINDERS	ALESAGGIO BORE	CORSA STROKE	VERSIONE VERSION
		4	105		

	8180.104	8180.112	1213.265	1213.259				
FIN819CGA	FIN819CGB	FIN537SM	FIN3245RT	FIN3246RT				

 	ADATTABILE A: SUITABLE FOR:		Nr.	ENGINE KIT	ELECTRIC KIT
	4730.295	FIN6249HG	1	 FIN593SL00	
			1	 FIN591PC00	
			1	 FIN538SM	
				FIN2147KIT	

3700.219		5496.137		2175.067	2175.069		
FIN706AF		FIN1085NF		FIN1027FE	FIN1098OF		

6585.064	6590.176	5010.014	6531.283	6578.159	9672.031		
FIN839FP	FIN629JP	FIN565NH	FIN092NO	FIN068E	FIN016DV		

Ricambi non originali per motori. Denominazioni e codici originali, sono riportati a puro titolo di riferimento.

44 - 15

rel. 1511

Non original engine parts. OEMs names and part numbers are for reference purpose only.

SLANZI

ALTRI ARTICOLI

OTHERS ITEMS

POS.	ARTICOLO	ITEM	MOTORE ENGINE	CODICE FINIMPIANTI FINIMPIANTI REF.	ADATTABILE A SUITABLE FOR:
1	Anello tubo protezione	<i>Guard tube seal</i>	DVA 460 , DVA 515 DVA 1030 , DVA 1030 S DVA 1200 , DVA 1750	FIN085AP	4740.031
2	Anello tubo protezione	<i>Guard tube seal</i>	DVA 1030 S , DVA 1200	FIN086AP	1200.060
3	Anello tubo protezione	<i>Guard tube seal</i>	DVA 1550 DVA 1550 S DVA 1750 DVA 1750 S	FIN087AP	4740.034
4	Anello tubo protezione	<i>Guard tube seal</i>	DVA 1500	FIN088AP	1200.047
5	Filtro aria	<i>Air cleaner</i>	DVA 920	FIN724AF	2175.073
6	Filtro olio	<i>Oil filter</i>	DVA 1500	FIN436OF	2175.071
7	Filtro olio	<i>Oil filter</i>	DVA 1750	FIN4260OF	2175.091
8	Filtro combustibile	<i>Fuel filter element</i>	DVA 1500	FIN342FE	2175.065
9	Filtro combustibile	<i>Fuel filter element</i>	DVA 2900	FIN605FE	2175.084
10	Filtro combustibile	<i>Fuel filter element</i>	DVA 920	FIN684FE	2175.064
11	Kit paraolio	<i>Seal kit</i>	DVA 920 , DVA 1030 DVA 1030 S , DVA 1200	FIN803RTS (FIN3230RT + FIN3231RT)	
12	Kit paraolio	<i>Seal kit</i>	DVA 1550 , DVA 1550 S DVA 1750 , DVA 1750 S DVA 2350	FIN604RTS (FIN3232RT + FIN892RT)	
13					
14					
15					
16					
17					
18					
19					
21					
22					

Ricambi non originali per motori. Denominazioni e codici originali, sono riportati a puro titolo di riferimento.

45 - 15

rel. 1511

Non original engine parts. OEMs names and part numbers are for reference purpose only.

SLANZI

ALTRI ARTICOLI

OTHERS ITEMS

POS.	ARTICOLO	<i>ITEM</i>	MOTORE <i>ENGINE</i>	CODICE FINIMPIANTI <i>FINIMPIANTI REF.</i>	ADATTABILE A <i>SUITABLE FOR:</i>
23					
24					
25					
26					
27					
28					
29					
30					
31					
32					
33					
34					
35					
36					
37					
38					
39					
40					
41					

ACME

1	ALN 290 W
3	ALN 330 W
5	AD 108
7	AD 110
9	AD 114/A
11	AD 114
13	AD 112
15	AD 116
17	ADN 37
19	ADN 37 W
21	ADN 43
23	ADN 43 W
25	ADN 45 1°SERIE
27	ADN 45 2260000 ←
29	ADN 45 W 2260001 →
31	ADN 48
33	ADN 48 2260000 ←
35	ADN 48 W 2260001 →
37	ADN 54 1°SERIE
39	ADN 54 2260000 ←
41	ADN 54 W 2260001 →
43	ADN 60 1°SERIE
45	ADN 60 2260000 ←
47	ADN 60 W 2260001 →
49	ADX 300
51	ADX 370
53	ADX 600
55	ADX 740
57	ADX 742
59	VT 88 W
61	AL 480
63	ALTRI ARTICOLI <i>OTHERS ITEMS</i>

Questo catalogo contiene dati ed informazioni provenienti dalla pluriennale esperienza di Finimpianti. Tuttavia non possiamo assumere alcuna responsabilità per eventuali dati errati od incompleti.

Tutti i dati e le informazioni contenute nel presente catalogo sono fornite a puro scopo informativo e senza responsabilità e non potranno dare adito ad alcuna forma di risarcimento.

Visto il continuo sviluppo dei nostri prodotti, Finimpianti si riserva il diritto di apportare modifiche senza preavviso.

Denominazioni, numeri e codici originali sono riportati a puro titolo di riferimento.

All the information and data contained in this catalogue came from the long Finimpianti experience. Nevertheless we can not assume any responsibility for possible mistakes.





All the information and data contained in this catalogue are provide "as is" without any representation or warranty express or implied. Under no circumstances whatsoever shall Finimpianti be liable for any damages whatsoever arising out of the use of the information and data contained in this catalogue.





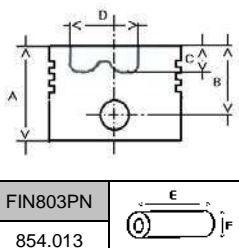

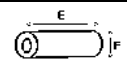

Finimpianti does not warrant the accuracy or completeness of the materials and content contained in this catalogue and reserves the right to correct any errors or omissions at any time without notice and without obligation to the users of this catalogue.

OEM names, codes and part numbers, used in this catalogue, are for reference only.

ACME

ALN 290 W	Cm³	CILINDRI CYLINDERS	ALESAGGIO BORE	CORSA STROKE	VERSIONE VERSION
	287	1	75	65	

		TESTA HEAD	H09		3	2	TIPO TYPE	<table border="1"> <tr><td>G</td><td></td></tr> <tr><td>H</td><td></td></tr> <tr><td>I</td><td></td></tr> <tr><td>L</td><td></td></tr> </table>	G		H		I		L	
		G														
		H														
		I														
		L														
		A	59,5		10	2										
B	29,5	22	4													
C																
D																
FIN803PN		E	55													
854.013		F	17													
	75	A2037	FIN708PC00	A2033	FIN709RS00											
	75,5	A2038	FIN708PC05	A2034	FIN709RS05											
	76	A2039	FIN708PC10	A2035	FIN709RS10											

		Nr.						ADATTABILE A: SUITABLE FOR:	
---	---	------------	---	---	---	---	---	--------------------------------	---

--	--	--	--	--	--	--	--	--	--

MB		2	CUSCINETTO A SFERA – BALL BEARING				304.046	FIN6026BR
----	--	---	-----------------------------------	--	--	--	---------	-----------





--	--	--	--	--	--	--	--	--	--



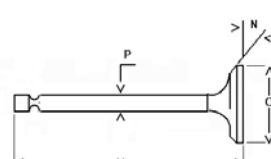

--	--	--	--	--	--	--	--	--	--

--	--	--	--	--	--	--	--	--	--

--	--	--	--	--	--	--	--	--	--

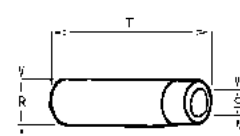
--	--	--	--	--	--	--	--	--	--

	IN EX		Nr.	O	P	M	N		ADATTABILE A: SUITABLE FOR:			
	IN		FS	1	31	7	94		45	A33	960.027	FINA098
	EX		FN	1	27	7	94		45	A33	960.127	FINS148

	IN EX		Nr.	R	S	T		ADATTABILE A: SUITABLE FOR:			
	IN			1					B0430	FIN012AA	
	IN										
	EX			1						B0429	FIN013SA
EX											

ACME

ALN 290 W	Cm³	CILINDRI CYLINDERS	ALESAGGIO BORE	CORSA STROKE	VERSIONE VERSION
	287	1	75	65	



	A2413		054.027	054.016				
FIN4004CGA	FIN4004CGB		FIN526RT	FIN3215RT				







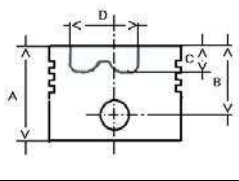

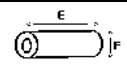
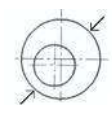
 	ADATTABILE A: SUITABLE FOR:		Nr.	ENGINE KIT	ELECTRIC KIT
	449.105	FIN722HG	1		
			1		
			1		

387.177	059.167	359.116					
FIN2315AF	FIN1412PF	FIN1218NF					

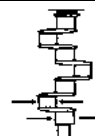
ACME

ALN 330 W	Cm³	CILINDRI CYLINDERS	ALESAGGIO BORE	CORSA STROKE	VERSIONE VERSION
	327	1	80	65	

		TESTA HEAD	H09		3	2	TIPO TYPE	<table border="1"> <tr><td>G</td><td></td></tr> <tr><td>H</td><td></td></tr> <tr><td>I</td><td></td></tr> <tr><td>L</td><td></td></tr> </table>	G		H		I		L	
		G														
		H														
		I														
		L														
		A	58,5		10	2										
B	29,5	22	4													
C																
D																
FIN803PN		E	55													
854.013		F	17													
	80	A2406	FIN713PC00	A2409	FIN2300RS00											
	80,5	A2407	FIN713PC05	A2410	FIN2300RS05											
	81	A2408	FIN713PC10	A2411	FIN2300RS10											

		Nr.						ADATTABILE A: SUITABLE FOR:	
---	---	------------	---	---	---	---	---	--------------------------------	---

--	--	--	--	--	--	--	--	--	--

MB		2	CUSCINETTO A SFERA – BALL BEARING					304.046	FIN6026BR
----	--	---	-----------------------------------	--	--	--	--	---------	-----------





--	--	--	--	--	--	--	--	--	--

--	--	--	--	--	--	--	--	--	--

--	--	--	--	--	--	--	--	--	--

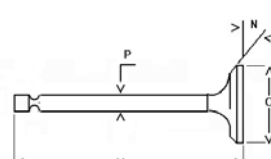
--	--	--	--	--	--	--	--	--	--

--	--	--	--	--	--	--	--	--	--

	IN EX		Nr.	O	P	M	N		ADATTABILE A: SUITABLE FOR:			
	IN		FS	1	31	7	94		45	A33	960.027	FINA098
	EX		FN	1	27	7	94		45	A33	960.127	FINS148

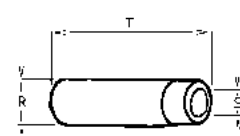
	IN EX		Nr.	R	S	T		ADATTABILE A: SUITABLE FOR:			
	IN			1					B0430	FIN012AA	
	IN										
	EX			1						B0429	FIN013SA
EX											

Ricambi non originali per motori. Denominazioni e codici originali, sono riportati a puro titolo di riferimento.

3 - 16

rel. 1511

Non original engine parts. OEMs names and part numbers are for reference purpose only.

ACME

ALN 330 W	Cm³	CILINDRI CYLINDERS	ALESAGGIO BORE	CORSA STROKE	VERSIONE VERSION
	327	1	80	65	



	A2413		054.027	054.016				
FIN4004CGA	FIN4004CGB		FIN526RT	FIN3215RT				







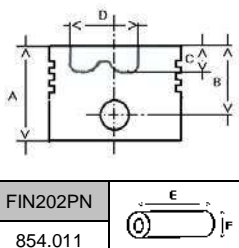

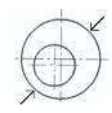
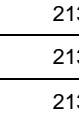
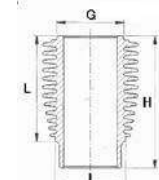
 	ADATTABILE A: SUITABLE FOR:		Nr.	ENGINE KIT	ELECTRIC KIT
	449.105	FIN722HG	1		
			1		
			1		

387.177	059.167	359.116					
FIN2315AF	FIN1412PF	FIN1218NF					

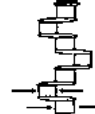
ACME

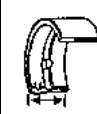
AD 108	Cm³	CILINDRI CYLINDERS	ALESAGGIO BORE	CORSA STROKE	VERSIONE VERSION
	482	1	85	85	

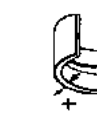
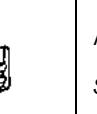
		TESTA HEAD	H43		3	2,5	TIPO TYPE	A	
		A	88		10	2,5			
	FIN202PN	E	74		10	2,5		G	105
	854.011	F	25		22	5		H	165,5
	85	2130	FIN192PC00	2135	FIN069RS00			I	98
	85,5	2131	FIN192PC05	2136	FIN069RS05		203.010	L	122,4
	86	2132	FIN192PC10	2137	FIN069RS10			FIN489SL00	

		Nr.							ADATTABILE A: SUITABLE FOR:	
---	---	------------	---	---	---	---	---	--	--------------------------------	---

CR	AL	1	45,00	48,01	24,12		STD - 025 - 050 - 075 - 100 - BAR	316.036	FIN036CR STD
----	----	---	-------	-------	-------	--	-----------------------------------	---------	--------------

MB	ALL	2	42,09	50,03	40,20		STD - 025 - 050 - 075 - 100 - BAR - BAR EM1	310.016	FIN016MB STD
----	-----	---	-------	-------	-------	--	---	---------	--------------





--	--	--	--	--	--	--	--	--	--



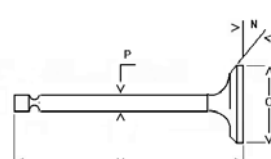

--	--	--	--	--	--	--	--	--	--

PB	BM	1	25,02	28,02	27,50		SEMIF.	316.041	FIN141PB
----	----	---	-------	-------	-------	--	--------	---------	----------

--	--	--	--	--	--	--	--	--	--

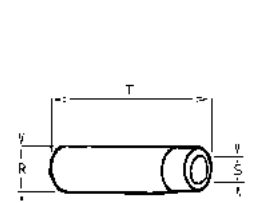
--	--	--	--	--	--	--	--	--	--

	IN EX		Nr.	O	P	M	N		ADATTABILE A: SUITABLE FOR:			
	IN		FS	1	35	9	105		45	E1	960.016	FINA116
	EX		FN	1	35	9	105		45	A1	960.015	FINS117

	IN EX		Nr.	R	S	T		ADATTABILE A: SUITABLE FOR:			
	IN		G	1	15,03	9,04		45	L	464.039	FIN203AA
	IN		G		15,13	9,04		45	L		FIN203AB
	EX		G	1	15,03	9,04		45	L	464.040	FIN204SA
	EX		G		15,13	9,04		45	L		FIN204SB

Ricambi non originali per motori. Denominazioni e codici originali, sono riportati a puro titolo di riferimento.

5 - 16

rel. 1511

Non original engine parts. OEMs names and part numbers are for reference purpose only.

ACME

AD 108	Cm³	CILINDRI CYLINDERS	ALESAGGIO BORE	CORSA STROKE	VERSIONE VERSION
	482	1	85	85	

	A2119	A2393	054.015	054.016	447.076	447.079	448.014	447.081
FIN108CGA	FIN108CGB	FIN082SM	FIN3216RT	FIN3215RT	FIN206CO	FIN281CB	FIN503IG	FIN503IG

 	ADATTABILE A: SUITABLE FOR:		Nr.	ENGINE KIT	ELECTRIC KIT
	447.078	FIN6380HG	1	 FIN489SL00	
			1	 FIN192PC00	
			1	 FIN082SM	
				FIN0902KIT	

387.039		359.013		391.012	175.005		
FIN2208AF		FIN1033NF		FIN4227FE	FIN4225OF		

2117				2122			
FIN1065KR				FIN022OP			



	656.003	2123	644.007	660.003	956.005		
	FIN708JP	FIN561NH	FIN114NO	FIN074E	FIN016DV		







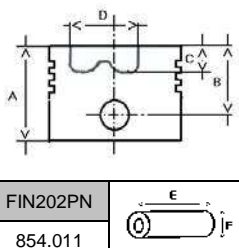

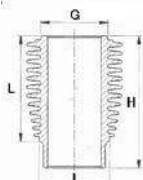
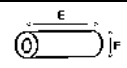
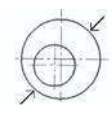
			526.066				
			FIN113SI				

Ricambi non originali per motori. Denominazioni e codici originali, sono riportati a puro titolo di riferimento.

ACME

AD 110	Cm³	CILINDRI CYLINDERS	ALESAGGIO BORE	CORSA STROKE	VERSIONE VERSION
	482	1	85	85	

		TESTA HEAD	H43		3	2,5	TIPO TYPE	A	
		A	88		10	2,5			G
FIN202PN		B	50	10	2,5	H	165,5		
854.011		C	12	22	5	I	98		
		D	44			L	122,4		
	85	2130	FIN192PC00	2135	FIN069RS00	203.010		FIN489SL00	
	85,5	2131	FIN192PC05	2136	FIN069RS05				
	86	2132	FIN192PC10	2137	FIN069RS10				

		Nr.						ADATTABILE A: SUITABLE FOR:	
---	---	------------	---	---	---	---	---	--------------------------------	---

CR	AL	1	45,00	48,01	24,12		STD - 025 - 050 - 075 - 100 - BAR	316.036	FIN036CR STD
----	----	---	-------	-------	-------	--	-----------------------------------	---------	--------------

MB	ALL	2	42,09	50,03	40,20		STD - 025 - 050 - 075 - 100 - BAR - BAR EM1	310.016	FIN016MB STD
----	-----	---	-------	-------	-------	--	---	---------	--------------





--	--	--	--	--	--	--	--	--	--



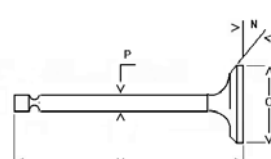

--	--	--	--	--	--	--	--	--	--

PB	BM	1	25,02	28,02	27,50		SEMIF.	316.041	FIN141PB
----	----	---	-------	-------	-------	--	--------	---------	----------

--	--	--	--	--	--	--	--	--	--

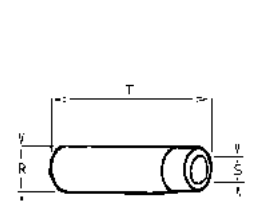
--	--	--	--	--	--	--	--	--	--

	IN EX		Nr.	O	P	M	N		ADATTABILE A: SUITABLE FOR:			
	IN		FS	1	35	9	105		45	E1	960.016	FINA116
	EX		FN	1	35	9	105		45	A1	960.015	FINS117

	IN EX		Nr.	R	S	T		ADATTABILE A: SUITABLE FOR:			
	IN		G	1	15,03	9,04		45	L	464.039	FIN203AA
	IN		G		15,13	9,04		45	L		FIN203AB
	EX		G	1	15,03	9,04		45	L	464.040	FIN204SA
	EX		G		15,13	9,04		45	L		FIN204SB

Ricambi non originali per motori. Denominazioni e codici originali, sono riportati a puro titolo di riferimento.

7 - 16

rel. 1511

Non original engine parts. OEMs names and part numbers are for reference purpose only.

ACME

AD 110	Cm³	CILINDRI CYLINDERS	ALESAGGIO BORE	CORSA STROKE	VERSIONE VERSION
	482	1	85	85	

	A2119	A2393	054.015	054.016	447.076	447.079	448.014	447.081
FIN108CGA	FIN108CGB	FIN082SM	FIN3216RT	FIN3215RT	FIN206CO	FIN281CB	FIN503IG	FIN503IG

 ADATTABILE A: SUITABLE FOR:	 FIN6380HG	Nr.	ENGINE KIT	ELECTRIC KIT
		1	 FIN489SL00	
		1	 FIN192PC00	
		1	 FIN082SM	
		FIN0902KIT		

387.039		359.013		391.012	175.005		
FIN2208AF		FIN1033NF		FIN4227FE	FIN4225OF		

2117				2122			
FIN1065KR				FIN022OP			



	656.003	2123	644.007	660.003	956.005		
	FIN708JP	FIN561NH	FIN114NO	FIN074E	FIN016DV		







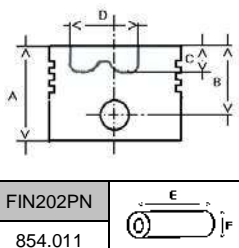

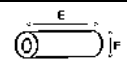
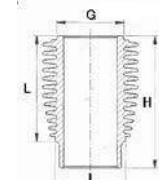
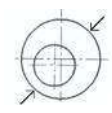
			526.066				
			FIN113SI				

Ricambi non originali per motori. Denominazioni e codici originali, sono riportati a puro titolo di riferimento.

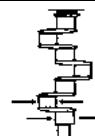
ACME

AD 114/A	Cm³	CILINDRI CYLINDERS	ALESAGGIO BORE	CORSA STROKE	VERSIONE VERSION
	482	1	85	85	

		TESTA HEAD	H43		3	2,5	TIPO TYPE	A	
		A	88		10	2,5			
FIN202PN 854.011		B	50	10 22	10	2,5		G	105
		C	12		10	2,5		H	165,5
	85 2130	D	44	2135 FIN069RS00 2136 FIN069RS05 2137 FIN069RS10	203.010	FIN489SL00	I	98	
		E	74				2136 FIN069RS05 2137 FIN069RS10	L	122,4
		F	25					FIN489SL00	

		Nr.						ADATTABILE A: SUITABLE FOR:	
---	---	------------	---	---	---	---	---	--------------------------------	---

CR	AL	1	45,00	48,01	24,12		STD - 025 - 050 - 075 - 100 - BAR	316.036	FIN036CR STD
----	----	---	-------	-------	-------	--	-----------------------------------	---------	--------------

MB	ALL	2	42,09	50,03	40,20		STD - 025 - 050 - 075 - 100 - BAR - BAR EM1	310.016	FIN016MB STD
----	-----	---	-------	-------	-------	--	---	---------	--------------





--	--	--	--	--	--	--	--	--	--



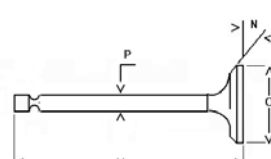

--	--	--	--	--	--	--	--	--	--

PB	BM	1	25,02	28,02	27,50		SEMIF.	316.041	FIN141PB
----	----	---	-------	-------	-------	--	--------	---------	----------

--	--	--	--	--	--	--	--	--	--

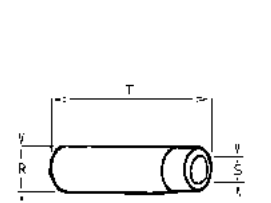
--	--	--	--	--	--	--	--	--	--

	IN EX		Nr.	O	P	M	N		ADATTABILE A: SUITABLE FOR:			
	IN		FS	1	35	9	105		45	E1	960.016	FINA116
	EX		FN	1	35	9	105		45	A1	960.015	FINS117

	IN EX		Nr.	R	S	T		ADATTABILE A: SUITABLE FOR:			
	IN		G	1	15,03	9,04		45	L	464.039	FIN203AA
	IN		G		15,13	9,04		45	L		FIN203AB
	EX		G	1	15,03	9,04		45	L	464.040	FIN204SA
EX	G		15,13	9,04	45	L		FIN204SB			

Ricambi non originali per motori. Denominazioni e codici originali, sono riportati a puro titolo di riferimento.

ACME

AD 114 / A	Cm³	CILINDRI CYLINDERS	ALESAGGIO BORE	CORSA STROKE	VERSIONE VERSION
	482	1	85	85	

	A2119	A2393	054.015	054.016	447.076	447.079	448.014	447.081
FIN108CGA	FIN108CGB	FIN082SM	FIN3216RT	FIN3215RT	FIN206CO	FIN281CB	FIN503IG	FIN503IG

 	ADATTABILE A: SUITABLE FOR:		Nr.	ENGINE KIT	ELECTRIC KIT
	447.078	FIN6380HG	1	 FIN489SL00	
			1	 FIN192PC00	
			1	 FIN082SM	
				FIN0902KIT	

387.039		359.013		391.012	175.005		
FIN2208AF		FIN1033NF		FIN4227FE	FIN4225OF		

2117				2122			
FIN1065KR				FIN022OP			

	656.003	2123	644.007	660.003	956.005		
	FIN708JP	FIN561NH	FIN114NO	FIN074E	FIN016DV		

			526.066				
			FIN113SI				





Ricambi non originali per motori. Denominazioni e codici originali, sono riportati a puro titolo di riferimento.





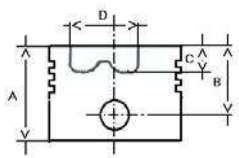

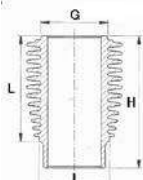
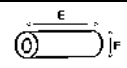

10 - 16
rel. 1511

Non original engine parts. OEMs names and part numbers are for reference purpose only.

ACME

AD 114	Cm³	CILINDRI CYLINDERS	ALESAGGIO BORE	CORSA STROKE	VERSIONE VERSION
		1	90		

		TESTA HEAD	H14		3	2,5	TIPO TYPE	A	
		A	85		1	2,5			G
FIN202PN		B	50	10	2,5	H	165,6		
854.011		C	15	22	5	I	98		
		D	43			L	122,4		
	90	2144	FIN195PC00	2149	FIN071RS00	203.012		FIN028SL00	
	90,5	2145	FIN195PC05	2150	FIN071RS05				
	91	2146	FIN195PC10	2151	FIN071RS10				

		Nr.						ADATTABILE A: SUITABLE FOR:	
---	---	------------	---	---	---	---	---	--------------------------------	---

CR	AL	1	45,00	48,01	24,12		STD - 025 - 050 - 075 - 100 - BAR	316.036	FIN036CR STD
----	----	---	-------	-------	-------	--	-----------------------------------	---------	--------------

MB	ALL	2	42,09	50,03	40,20		STD - 025 - 050 - 075 - 100 - BAR - BAR EM1	310.016	FIN016MB STD
----	-----	---	-------	-------	-------	--	---	---------	--------------





--	--	--	--	--	--	--	--	--	--



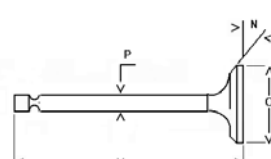

--	--	--	--	--	--	--	--	--	--

PB	BM	1	25,02	28,02	27,50		SEMIF.	316.041	FIN141PB
----	----	---	-------	-------	-------	--	--------	---------	----------

--	--	--	--	--	--	--	--	--	--

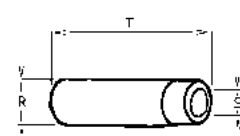
--	--	--	--	--	--	--	--	--	--

	IN EX		Nr.	O	P	M	N		ADATTABILE A: SUITABLE FOR:			
	IN		FS	1	37	9	105		45	E1	960.019	FINA118
	EX		FN	1	35	9	105		45	A1	960.015	FINS117

	IN EX		Nr.	R	S	T		ADATTABILE A: SUITABLE FOR:			
	IN		G	1	15,03	9,04		45	L	464.004	FIN203AA
	IN		G		15,13	9,04		45	L		FIN203AB
	EX		G	1	15,03	9,04		45	L	464.007	FIN204SA
	EX	G		15,13	9,04	45	L		FIN204SB		

Ricambi non originali per motori. Denominazioni e codici originali, sono riportati a puro titolo di riferimento.

11 - 16

rel. 1511

Non original engine parts. OEMs names and part numbers are for reference purpose only.

ACME

AD 114	Cm³	CILINDRI CYLINDERS	ALESAGGIO BORE	CORSA STROKE	VERSIONE VERSION
		1	90		

	A2140	A2394	054.015	054.016	447.076	447.079	448.014	447.081
FIN110CGA	FIN110CGB	FIN084SM	FIN3216RT	FIN3215RT	FIN206CO	FIN281CB	FIN503IG	FIN503IG

 	ADATTABILE A: SUITABLE FOR:		Nr.	ENGINE KIT	ELECTRIC KIT
	448.008	FIN6241HG	1	 FIN028SL00	
			1	 FIN195PC00	
			1	 FIN084SM	
				FIN012KIT	

387.039		359.013		391.012	175.005		
FIN2208AF		FIN1033NF		FIN4227FE	FIN4225OF		

2117				2122			
FIN1065KR				FIN022OP			

	656.003	2123	644.007	660.003	956.005		
	FIN708JP	FIN561NH	FIN114NO	FIN074E	FIN016DV		

			526.066				
			FIN113SI				

Ricambi non originali per motori. Denominazioni e codici originali, sono riportati a puro titolo di riferimento.



12 - 16







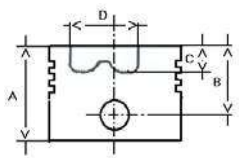

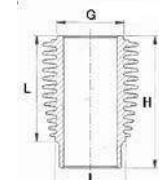
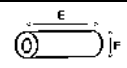
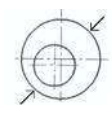
rel. 1511

Non original engine parts. OEMs names and part numbers are for reference purpose only.

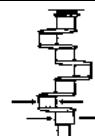
ACME

AD 112	Cm³	CILINDRI CYLINDERS	ALESAGGIO BORE	CORSA STROKE	VERSIONE VERSION
		1	90		

		TESTA HEAD	H14		3	2,5	TIPO TYPE	A	
		A	85		1	2,5			G
FIN202PN		B	50	10	2,5	H	165,6		
854.011		C	15	22	5	I	98		
		D	43			L	122,4		
	90	2144	FIN195PC00	2149	FIN071RS00	203.012		FIN028SL00	
	90,5	2145	FIN195PC05	2150	FIN071RS05				
	91	2146	FIN195PC10	2151	FIN071RS10				

		Nr.						ADATTABILE A: SUITABLE FOR:	
---	---	------------	---	---	---	---	---	--------------------------------	---

CR	AL	1	45,00	48,01	24,12		STD - 025 - 050 - 075 - 100 - BAR	316.036	FIN036CR STD
----	----	---	-------	-------	-------	--	-----------------------------------	---------	--------------

MB	ALL	2	42,09	50,03	40,20		STD - 025 - 050 - 075 - 100 - BAR - BAR EM1	310.016	FIN016MB STD
----	-----	---	-------	-------	-------	--	---	---------	--------------





--	--	--	--	--	--	--	--	--	--



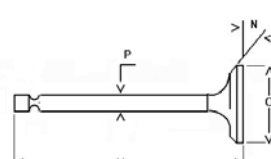

--	--	--	--	--	--	--	--	--	--

PB	BM	1	25,02	28,02	27,50		SEMIF.	316.041	FIN141PB
----	----	---	-------	-------	-------	--	--------	---------	----------

--	--	--	--	--	--	--	--	--	--

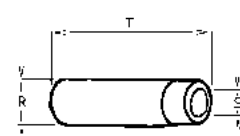
--	--	--	--	--	--	--	--	--	--

	IN EX		Nr.	O	P	M	N		ADATTABILE A: SUITABLE FOR:			
	IN		FS	1	37	9	105		45	E1	960.019	FINA118
	EX		FN	1	35	9	105		45	A1	960.015	FINS117

	IN EX		Nr.	R	S	T		ADATTABILE A: SUITABLE FOR:			
	IN		G	1	15,03	9,04		45	L	464.004	FIN203AA
	IN		G		15,13	9,04		45	L		FIN203AB
	EX		G	1	15,03	9,04		45	L	464.007	FIN204SA
	EX		G		15,13	9,04		45	L		FIN204SB

Ricambi non originali per motori. Denominazioni e codici originali, sono riportati a puro titolo di riferimento.

13 - 16

rel. 1511

Non original engine parts. OEMs names and part numbers are for reference purpose only.

ACME

AD 112	Cm³	CILINDRI CYLINDERS	ALESAGGIO BORE	CORSA STROKE	VERSIONE VERSION
		1	90		

	A2140	A2394	054.015	054.016	447.076	447.079	448.014	447.081
FIN110CGA	FIN110CGB	FIN084SM	FIN3216RT	FIN3215RT	FIN206CO	FIN281CB	FIN503IG	FIN503IG

 	ADATTABILE A: SUITABLE FOR:		Nr.	ENGINE KIT	ELECTRIC KIT
	448.008	FIN6241HG	1	 FIN028SL00	
			1	 FIN195PC00	
			1	 FIN084SM	
				FIN012KIT	

387.039		359.013		391.012	175.005		
FIN2208AF		FIN1033NF		FIN4227FE	FIN4225OF		

2117				2122			
FIN1065KR				FIN022OP			

	656.003	2123	644.007	660.003	956.005		
	FIN708JP	FIN561NH	FIN114NO	FIN074E	FIN016DV		

			526.066				
			FIN113SI				

Ricambi non originali per motori. Denominazioni e codici originali, sono riportati a puro titolo di riferimento.



14 - 16







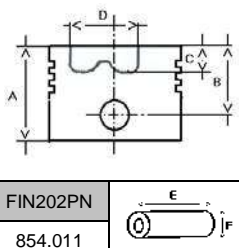

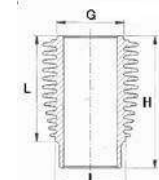
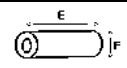
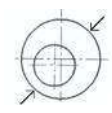
rel. 1511

Non original engine parts. OEMs names and part numbers are for reference purpose only.

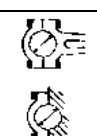
ACME

AD 116	Cm³	CILINDRI CYLINDERS	ALESAGGIO BORE	CORSA STROKE	VERSIONE VERSION
		1	92		

		TESTA HEAD	H14		3	2,5	TIPO TYPE	A	
		A	100		10	2,5			G
FIN202PN		B	50	10	2,5	H	165,6		
854.011		C	15	22	5	I	98		
		D	44,2			L	122,4		
	92	2205	FIN199PC00	2153	FIN074RS00	203.013		FIN031SL00	
	92,5	2209	FIN199PC05	2206	FIN074RS05				
	93	2210	FIN199PC10	2207	FIN074RS10				

		Nr.							ADATTABILE A: SUITABLE FOR:	
---	---	------------	---	---	---	---	---	--	--------------------------------	---

CR	AL	1	45,00	48,01	24,12			STD - 025 - 050 - 075 - 100 - BAR	316.036	FIN036CR STD
----	----	---	-------	-------	-------	--	--	-----------------------------------	---------	--------------

MB	ALL	2	42,09	50,03	40,20			STD - 025 - 050 - 075 - 100 - BAR - BAR EM1	310.016	FIN016MB STD
----	-----	---	-------	-------	-------	--	--	---	---------	--------------





--	--	--	--	--	--	--	--	--	--	--



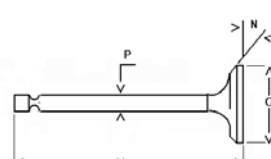

--	--	--	--	--	--	--	--	--	--	--

PB	BM	1	25,02	28,02	27,50			SEMIF.	316.041	FIN141PB
----	----	---	-------	-------	-------	--	--	--------	---------	----------

--	--	--	--	--	--	--	--	--	--	--

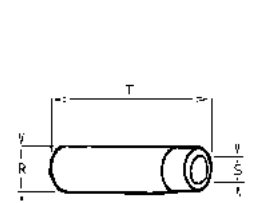
--	--	--	--	--	--	--	--	--	--	--

	IN EX		Nr.	O	P	M	N		ADATTABILE A: SUITABLE FOR:			
	IN		FS	1	37	9	105		45	E1	960.019	FINA118
	EX		FN	1	35	9	105		45	A1	960.015	FINS117

	IN EX		Nr.	R	S	T		ADATTABILE A: SUITABLE FOR:			
	IN		G	1	15,03	9,04		45	L	464.004	FIN203AA
	IN		G		15,13	9,04		45	L		FIN203AB
	EX		G	1	15,03	9,04		45	L	464.007	FIN204SA
	EX	G		15,13	9,04	45	L		FIN204SB		

Ricambi non originali per motori. Denominazioni e codici originali, sono riportati a puro titolo di riferimento.

15 - 16

rel. 1511

Non original engine parts. OEMs names and part numbers are for reference purpose only.

ACME

AD 116	Cm³	CILINDRI CYLINDERS	ALESAGGIO BORE	CORSA STROKE	VERSIONE VERSION
		1	92		

	A2140	A2394	054.015	054.016	447.076	447.079	448.014	447.081
FIN110CGA	FIN110CGB	FIN084SM	FIN3216RT	FIN3215RT	FIN206CO	FIN281CB	FIN503IG	FIN503IG

 	ADATTABILE A: SUITABLE FOR:		Nr.	ENGINE KIT	ELECTRIC KIT
	448.008	FIN6241HG	1	 FIN031SL00	
			1	 FIN199PC00	
			1	 FIN084SM	
				FIN3348KIT	

387.039		359.013		391.012	175.005		
FIN2208AF		FIN1033NF		FIN4227FE	FIN4225OF		

2117				2122			
FIN1065KR				FIN022OP			

	656.003	2123	644.007	660.003	956.005		
	FIN708JP	FIN561NH	FIN114NO	FIN074E	FIN016DV		

			526.066				
			FIN113SI				



Ricambi non originali per motori. Denominazioni e codici originali, sono riportati a puro titolo di riferimento.







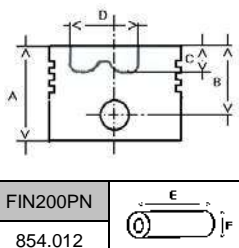

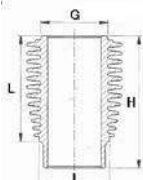
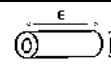
16 - 16
rel. 1511

Non original engine parts. OEMs names and part numbers are for reference purpose only.

ACME

ADN 37	Cm³	CILINDRI CYLINDERS	ALESAGGIO BORE	CORSA STROKE	VERSIONE VERSION
	377	1	80	75	2260000 ←

		TESTA HEAD	H27		3	2,5	TIPO TYPE	A		
		A	88		10	2,5			G	105
		B	40		23	4			H	133,9
		C	11,9						I	98
		D	40,7						L	79,9
		E	67,5						203.019	
FIN200PN				2340	FIN067RS00					
854.012				2341	FIN067RS05					
				2342	FIN067RS10					

		Nr.						ADATTABILE A: SUITABLE FOR:	
---	---	------------	---	---	---	---	---	--------------------------------	---

CR	AL	1	40,05	43,66	24,38		STD - 025 - 050 - 075 - 100	316.043	FIN043CR STD
----	----	---	-------	-------	-------	--	-----------------------------	---------	--------------

MB	ALL	2	42,09	50,03	40,20		STD - 025 - 050 - 075 - 100 - BAR - BAR EM1	310.016	FIN016MB STD
----	-----	---	-------	-------	-------	--	---	---------	--------------





--	--	--	--	--	--	--	--	--	--



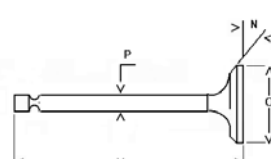

--	--	--	--	--	--	--	--	--	--

PB	BM	1	22,00	24,02	27,00		SEMIF.	316.110	FIN112PB
----	----	---	-------	-------	-------	--	--------	---------	----------

--	--	--	--	--	--	--	--	--	--

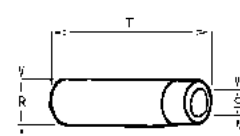
--	--	--	--	--	--	--	--	--	--

	IN EX		Nr.	O	P	M	N		ADATTABILE A: SUITABLE FOR:			
	IN		FS	1	30,5	9	105		45	E1	960.022	FINA106
	EX		FN	1	30,5	9	105		45	A1	960.023	FINS107

	IN EX		Nr.	R	S	T		ADATTABILE A: SUITABLE FOR:			
	IN		G	1	15,03	9,04		45	L	464.039	FIN203AA
	IN		G		15,13	9,04		45	L		FIN203AB
	EX		G	1	15,03	9,04		45	L	464.040	FIN204SA
	EX		G		15,13	9,04		45	L		FIN204SB

Ricambi non originali per motori. Denominazioni e codici originali, sono riportati a puro titolo di riferimento.

17 - 16

rel. 1511

Non original engine parts. OEMs names and part numbers are for reference purpose only.

ACME

ADN 37	Cm³	CILINDRI CYLINDERS	ALESAGGIO BORE	CORSA STROKE	VERSIONE VERSION
	377	1	80	75	2260000 ←

	A2491	A2856	054.131	054.016	447.076	447.079	448.014	448.014
FIN4585CGA	FIN4585CGB	FIN079SM	FIN3216RT	FIN3215RT	FIN206CO	FIN281CB	FIN503IG	FIN503IG

 	ADATTABILE A: SUITABLE FOR:		Nr.	ENGINE KIT	ELECTRIC KIT
	449.002	FIN6240HG	1	 FIN025SL00	
			1	 FIN489PC00	
			1	 FIN079SM	
				FIN0858KIT	

387.136	059.132	359.117		391.012	175.005		
FIN2500AF	FIN5300PF	FIN1200NF		FIN4227FE	FIN4225OF		

A2546				2122			
FIN1060KR				FIN022OP			

	656.010	2123	644.007	660.008	956.005		
	FIN760JP	FIN561NH	FIN114NO	FIN069E	FIN016DV		

696.119		890.002					
FIN038PU	FIN003CN	FIN303ST					

Ricambi non originali per motori. Denominazioni e codici originali, sono riportati a puro titolo di riferimento.



18 - 16







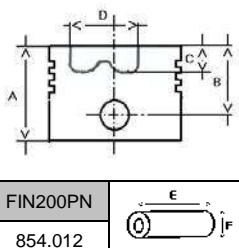

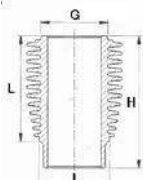
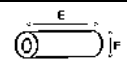
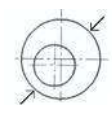
rel. 1511

Non original engine parts. OEMs names and part numbers are for reference purpose only.

ACME

ADN 37 W	Cm³	CILINDRI CYLINDERS	ALESAGGIO BORE	CORSA STROKE	VERSIONE VERSION
	377	1	80	75	22600001 →

		TESTA HEAD	H08		3	2,5	TIPO TYPE	A		
		A	75		10	2,5			G	105
		B	40		23	4			H	133,9
		C	12						I	98
		D	40,5						L	79,9
		E	67,5							
FIN200PN										
854.012										
	80	B0345	FIN190PC00	2340	FIN067RS00		203.019	FIN025SL00		
	80,5	B0346	FIN190PC05	2341	FIN067RS05					
	81	B0347	FIN190PC10	2342	FIN067RS10					

		Nr.						ADATTABILE A: SUITABLE FOR:	
---	---	------------	---	---	---	---	---	--------------------------------	---

CR	AL	1	40,00	43,67	22,00		STD - 025 - 050 - 075 - 100	316.134	FIN111CR STD
----	----	---	-------	-------	-------	--	-----------------------------	---------	--------------

MB	ALL	2	42,09	50,03	40,20		STD - 025 - 050 - 075 - 100 - BAR - BAR EM1	310.016	FIN016MB STD
----	-----	---	-------	-------	-------	--	---	---------	--------------





--	--	--	--	--	--	--	--	--	--



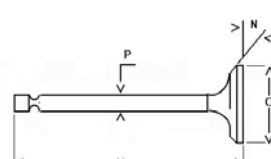

--	--	--	--	--	--	--	--	--	--

PB	BM	1	22,00	24,02	27,00		SEMIF.	316.110	FIN112PB
----	----	---	-------	-------	-------	--	--------	---------	----------

--	--	--	--	--	--	--	--	--	--

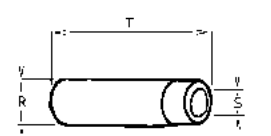
--	--	--	--	--	--	--	--	--	--

	IN EX		Nr.	O	P	M	N		ADATTABILE A: SUITABLE FOR:			
	IN		FN	1	35	8	87,5		45	A1	960.136	FINA5002
	EX		FN	1	30	8	87,5		45	A1	960.137	FINS5003

	IN EX		Nr.	R	S	T		ADATTABILE A: SUITABLE FOR:				
	IN		G	1						464.134	FIN010AA	
	IN											
	EX		G	1							464.133	FIN011SA
	EX											

Ricambi non originali per motori. Denominazioni e codici originali, sono riportati a puro titolo di riferimento.

19 - 16

rel. 1511

Non original engine parts. OEMs names and part numbers are for reference purpose only.

ACME

ADN 37 W	Cm³	CILINDRI CYLINDERS	ALESAGGIO BORE	CORSA STROKE	VERSIONE VERSION
	377	1	80	75	22600001 →

	A2491	A2856	054.131	054.016	447.076	447.079	448.014	448.014
FIN4585CGA	FIN4585CGB	FIN079SM	FIN3216RT	FIN3215RT	FIN206CO	FIN281CB	FIN503IG	FIN503IG

 	ADATTABILE A: SUITABLE FOR:		Nr.	ENGINE KIT	ELECTRIC KIT
	449.002	FIN6240HG	1	 FIN025SL00	
			1	 FIN190PC00	
			1	 FIN079SM	
				FIN0850KIT	

387.186	059.159	359.137	359.138	391.012	175.005		
FIN2501AF	FIN5301PF	FIN1201NF	FIN053CFA	FIN4227FE	FIN4225OF		

				2122			
				FIN022OP			

652.108	656.104	475.118	644.112	660.101	956.109		
FIN652FP	FIN761JP	FIN562NH	FIN402NO	FIN430E	FIN102DV		

696.119		890.002					
FIN038PU	FIN003CN	FIN303ST					

Ricambi non originali per motori. Denominazioni e codici originali, sono riportati a puro titolo di riferimento.

20 - 16







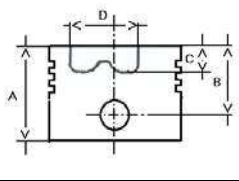
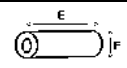
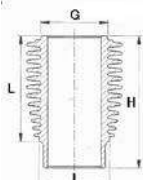
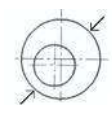

rel. 1511

Non original engine parts. OEMs names and part numbers are for reference purpose only.

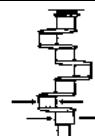
ACME

ADN 43	Cm³	CILINDRI CYLINDERS	ALESAGGIO BORE	CORSA STROKE	VERSIONE VERSION
	426	1	85	75	2260000 ←

		TESTA HEAD	A	3	2	TIPO TYPE	A		
			B	10	2		G		
	FIN200PN	C	12,5	23	4		H		
	854.012	D	40,7				I		
	85	E	67,5	A2552	FIN005RS00	203.127	L		
	85,5	F	22	A2579	FIN005RS05		FIN509SL00		
	86			A2580	FIN005RS10				

		Nr.							ADATTABILE A: SUITABLE FOR:	
---	---	------------	---	---	---	---	---	--	--------------------------------	---

CR	AL	1	40,00	43,67	22,00			STD - 025 - 050 - 075 - 100	316.134	FIN111CR STD
----	----	---	-------	-------	-------	--	--	-----------------------------	---------	--------------

MB	ALL	2	42,09	50,03	40,20			STD - 025 - 050 - 075 - 100 - BAR - BAR EM1	310.016	FIN016MB STD
----	-----	---	-------	-------	-------	--	--	---	---------	--------------





--	--	--	--	--	--	--	--	--	--	--



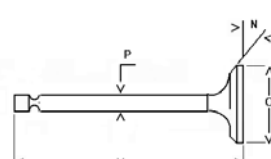

--	--	--	--	--	--	--	--	--	--	--

PB	BM	1	22,00	24,02	27,00			SEMIF.	316.110	FIN112PB
----	----	---	-------	-------	-------	--	--	--------	---------	----------

--	--	--	--	--	--	--	--	--	--	--

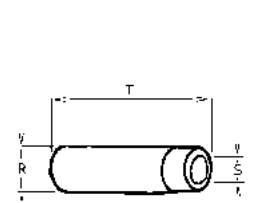
--	--	--	--	--	--	--	--	--	--	--

	IN EX		Nr.	O	P	M	N		ADATTABILE A: SUITABLE FOR:								
	IN								FS	1	35	9	105	45	E1	960.016	FINA116
	EX								FN	1	35	9	105	45	A1	960.015	FINS117

	IN EX		Nr.	R	S	T		ADATTABILE A: SUITABLE FOR:							
	IN							G	1	15,03	9,04	45	L	464.039	FIN203AA
	IN							G		15,13	9,04	45	L		FIN203AB
	EX							G	1	15,03	9,04	45	L	464.040	FIN204SA
EX	G		15,13	9,04	45	L		FIN204SB							

Ricambi non originali per motori. Denominazioni e codici originali, sono riportati a puro titolo di riferimento.

21 - 16

rel. 1511

Non original engine parts. OEMs names and part numbers are for reference purpose only.

ACME

ADN 43	Cm³	CILINDRI CYLINDERS	ALESAGGIO BORE	CORSA STROKE	VERSIONE VERSION
	426	1	85	75	2260000 ←

	A2119	A2394	054.131	054.016	447.076	447.079	448.014	448.014
FIN108CGA	FIN108CGB	FIN084SM	FIN3216RT	FIN3215RT	FIN206CO	FIN281CB	FIN503IG	FIN503IG

 	ADATTABILE A: SUITABLE FOR:		Nr.	ENGINE KIT	ELECTRIC KIT
	447.078	FIN6241HG	1	 FIN509SL00	
			1	 FIN108PC00	
			1	 FIN084SM	
				FIN004KIT	

387.186	059.159	359.137	359.138	391.012	175.005		
FIN2501AF	FIN5301PF	FIN1201NF	FIN053CFA	FIN4227FE	FIN4225OF		

				2122			
				FIN022OP			

	656.104	475.118	644.102	660.101	956.109		
	FIN761JP	FIN562NH	FIN114NO	FIN430E	FIN102DV		







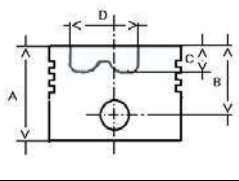
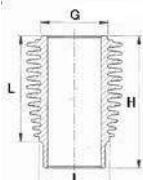
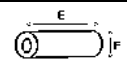
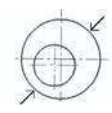

696.119		890.002					
FIN038PU	FIN003CN	FIN303ST					

Ricambi non originali per motori. Denominazioni e codici originali, sono riportati a puro titolo di riferimento.

ACME

ADN 43 W	Cm³	CILINDRI CYLINDERS	ALESAGGIO BORE	CORSA STROKE	VERSIONE VERSION
	426	1	85	75	22600001 →

		TESTA HEAD	A	3	2	TIPO TYPE	A		
			B	10	2			G	
			C	23	4			H	
			D					I	
			E					L	
			F						
FIN200PN			A2552	FIN005RS00	203.127	FIN509SL00			
854.012			A2579	FIN005RS05					
			A2580	FIN005RS10					
	85	B0349	FIN109PC00						
	85,5	B0350	FIN109PC05						
	86	B0351	FIN109PC10						

		Nr.						ADATTABILE A: SUITABLE FOR:	
---	---	------------	---	---	---	---	---	--------------------------------	---

CR	AL	1	40,00	43,67	22,00		STD - 025 - 050 - 075 - 100	316.134	FIN111CR STD
----	----	---	-------	-------	-------	--	-----------------------------	---------	--------------

MB	ALL	2	42,09	50,03	40,20		STD - 025 - 050 - 075 - 100 - BAR - BAR EM1	310.016	FIN016MB STD
----	-----	---	-------	-------	-------	--	---	---------	--------------





--	--	--	--	--	--	--	--	--	--



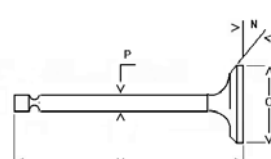

--	--	--	--	--	--	--	--	--	--

PB	BM	1	22,00	24,02	27,00		SEMIF.	316.110	FIN112PB
----	----	---	-------	-------	-------	--	--------	---------	----------

--	--	--	--	--	--	--	--	--	--

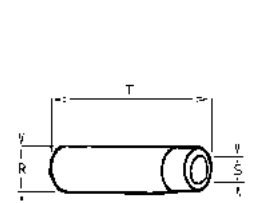
--	--	--	--	--	--	--	--	--	--

	IN EX		Nr.	O	P	M	N		ADATTABILE A: SUITABLE FOR:			
	IN		FN	1	35	8	87,5		45	A1	960.136	FINA5002
	EX		FN	1	30	8	87,5		45	A1	960.137	FINS5003

	IN EX		Nr.	R	S	T		ADATTABILE A: SUITABLE FOR:				
	IN		G	1						464.134	FIN010AA	
	IN											
	EX		G	1							464.133	FIN011SA
EX												

Ricambi non originali per motori. Denominazioni e codici originali, sono riportati a puro titolo di riferimento.

23 - 16

rel. 1511

Non original engine parts. OEMs names and part numbers are for reference purpose only.

ADN 43 W	Cm³	CILINDRI CYLINDERS	ALESAGGIO BORE	CORSA STROKE	VERSIONE VERSION
	426	1	85	75	22600001 →

	A2119	A2394	054.131	054.016	447.076	447.079	448.014	448.014
FIN108CGA	FIN108CGB	FIN084SM	FIN3216RT	FIN3215RT	FIN206CO	FIN281CB	FIN503IG	FIN503IG

 	ADATTABILE A: SUITABLE FOR:		Nr.	ENGINE KIT	ELECTRIC KIT
	447.078	FIN6241HG	1	 FIN509SL00	
			1	 FIN109PC00	
			1	 FIN084SM	
				FIN005KIT	

387.186	059.159	359.137	359.138	391.012	175.005		
FIN2501AF	FIN5301PF	FIN1201NF	FIN053CFA	FIN4227FE	FIN4225OF		





				2122			
				FIN022OP			





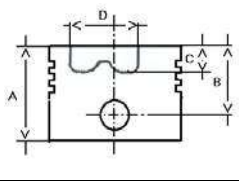

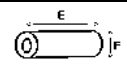
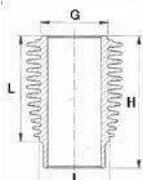

652.108	656.104	475.118	644.112	660.101	956.109		
FIN652FP	FIN761JP	FIN562NH	FIN402NO	FIN430E	FIN102DV		

696.119		890.002					
FIN038PU	FIN003CN	FIN303ST					

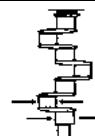
ACME

ADN 45	Cm³	CILINDRI CYLINDERS	ALESAGGIO BORE	CORSA STROKE	VERSIONE VERSION
		1	82		1° SERIE

		TESTA HEAD	A	40		3	2,5	TIPO TYPE	A	
			B	11,8		10	2,5			
			C	46		18	4			
			D	67,5		18	4			
			E	22						
			F							
FIN200PN								G		
854.012								H		
									I	
									L	
	82	A2485	FIN105PC00	A2480	FIN867RS00					
	82,5	A2486	FIN105PC05	A2481	FIN867RS05					
	83	A2487	FIN105PC10	A2482	FIN867RS10					
						203.124		FIN510SL00		

		Nr.							ADATTABILE A: SUITABLE FOR:	
---	---	------------	---	---	---	---	---	--	--------------------------------	---

CR	AL	1	45,00	48,01	24,12			STD - 025 - 050 - 075 - 100 - BAR	316.036	FIN036CR STD
----	----	---	-------	-------	-------	--	--	-----------------------------------	---------	--------------

MB	ALL	2	42,09	50,03	40,20			STD - 025 - 050 - 075 - 100 - BAR - BAR EM1	310.016	FIN016MB STD
----	-----	---	-------	-------	-------	--	--	---	---------	--------------





--	--	--	--	--	--	--	--	--	--	--



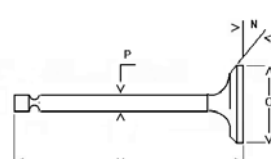

--	--	--	--	--	--	--	--	--	--	--

PB	BM	1	25,02	28,02	27,50			SEMIF.	316.041	FIN141PB
----	----	---	-------	-------	-------	--	--	--------	---------	----------

--	--	--	--	--	--	--	--	--	--	--

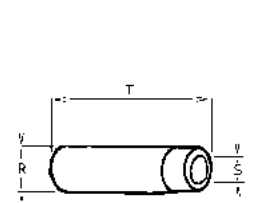
--	--	--	--	--	--	--	--	--	--	--

	IN EX		Nr.	O	P	M	N		ADATTABILE A: SUITABLE FOR:			
	IN		FS	1	30,5	9	105		45	E1	960.022	FINA106
	EX		FN	1	30,5	9	105		45	A1	960.023	FINS107

	IN EX		Nr.	R	S	T		ADATTABILE A: SUITABLE FOR:			
	IN		G	1	15,03	9,04		45	L	464.039	FIN203AA
	IN		G		15,13	9,04		45	L		FIN203AB
	EX		G	1	15,03	9,04		45	L	464.040	FIN204SA
	EX		G		15,13	9,04		45	L		FIN204SB

Ricambi non originali per motori. Denominazioni e codici originali, sono riportati a puro titolo di riferimento.

25 - 16

rel. 1511

Non original engine parts. OEMs names and part numbers are for reference purpose only.

ACME

ADN 45	Cm³	CILINDRI CYLINDERS	ALESAGGIO BORE	CORSA STROKE	VERSIONE VERSION
		1	82		1 SERIE

	A2119	A2394	054.015	054.016	447.076	447.079	448.014	448.014
FIN108CGA	FIN108CGB	FIN084SM	FIN3216RT	FIN3215RT	FIN206CO	FIN281CB	FIN503IG	FIN503IG

 	ADATTABILE A: SUITABLE FOR:		Nr.	ENGINE KIT	ELECTRIC KIT
	447.078	FIN6241HG	1	 FIN510SL00	
			1	 FIN105PC00	
			1	 FIN084SM	
				FIN006KIT	

387.136	059.132	359.117		391.012	175.005		
FIN2500AF	FIN5300PF	FIN1200NF		FIN4227FE	FIN4225OF		

100.109				2122			
FIN1065KR				FIN022OP			

	656.003	2123	644.007	660.003	956.005		
	FIN708JP	FIN561NH	FIN114NO	FIN074E	FIN016DV		

		890.002					
		FIN303ST					

Ricambi non originali per motori. Denominazioni e codici originali, sono riportati a puro titolo di riferimento.

26 - 16







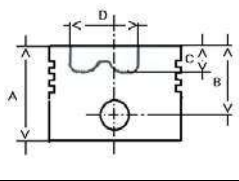
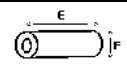
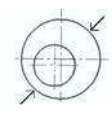

rel. 1511

Non original engine parts. OEMs names and part numbers are for reference purpose only.

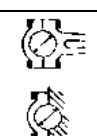
ACME

ADN 45	Cm³	CILINDRI CYLINDERS	ALESAGGIO BORE	CORSA STROKE	VERSIONE VERSION
		1	82		2260000 ←

		TESTA HEAD	A	3	2	TIPO TYPE	A	
			B	10	2		G	
FIN248PN 854.113		C	22	4	H			
		D			I			
	82 A2595	E			L			
		82,5			203.124		FIN510SL00	
		83						

		Nr.							ADATTABILE A: SUITABLE FOR:	
---	---	------------	---	---	---	---	---	--	--------------------------------	---

CR	RP	1	45,00	48,02	23,00		STD - 025 - 050	316.126	FIN134CR STD
----	----	---	-------	-------	-------	--	-----------------	---------	--------------

MB	ALL	2	42,09	50,03	40,20		STD - 025 - 050 - 075 - 100 - BAR - BAR EM1	310.016	FIN016MB STD
----	-----	---	-------	-------	-------	--	---	---------	--------------





--	--	--	--	--	--	--	--	--	--



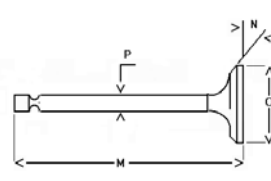

--	--	--	--	--	--	--	--	--	--

PB	BM	1	25,02	28,02	27,50		SEMIF.	316.041	FIN141PB
----	----	---	-------	-------	-------	--	--------	---------	----------

--	--	--	--	--	--	--	--	--	--

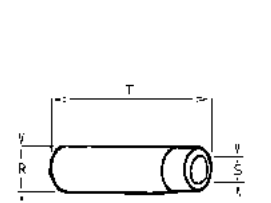
--	--	--	--	--	--	--	--	--	--

		Nr.	O	P	M	N		ADATTABILE A: SUITABLE FOR:									
								IN	FS	1	33	9	105	45	E1	960.115	FINA151
								EX	FN	1	30,5	9	105	45	A1	960.023	FINS107

		Nr.	R	S	T		ADATTABILE A: SUITABLE FOR:								
							IN	G	1	15,03	9,04	45	L	464.039	FIN203AA
							IN	G		15,13	9,04	45	L		FIN203AB
							EX	G	1	15,03	9,04	45	L	464.040	FIN204SA
EX	G		15,13	9,04	45	L		FIN204SB							

Ricambi non originali per motori. Denominazioni e codici originali, sono riportati a puro titolo di riferimento.

27 - 16

rel. 1511

Non original engine parts. OEMs names and part numbers are for reference purpose only.

ACME

ADN 45	Cm³	CILINDRI CYLINDERS	ALESAGGIO BORE	CORSA STROKE	VERSIONE VERSION
		1	82		2260000 ←

	A2119	A2394	054.131	054.016	447.076	447.079	448.014	448.014
FIN108CGA	FIN108CGB	FIN084SM	FIN3216RT	FIN3215RT	FIN206CO	FIN281CB	FIN503IG	FIN503IG

 	ADATTABILE A: SUITABLE FOR:		Nr.	ENGINE KIT	ELECTRIC KIT
	447.078	FIN6241HG	1	 FIN510SL00	
			1	 FIN880PC00	
			1	 FIN084SM	
				FIN007KIT	

387.186	059.159	359.137	359.138	391.012	175.005		
FIN2501AF	FIN5301PF	FIN1201NF	FIN053CFA	FIN4227FE	FIN4225OF		

2117				2122			
FIN1065KR				FIN022OP			

652.108	656.104	475.118	644.102	660.101	956.109		
FIN652FP	FIN761JP	FIN562NH	FIN114NO	FIN430E	FIN102DV		

		890.002					
		FIN303ST					

Ricambi non originali per motori. Denominazioni e codici originali, sono riportati a puro titolo di riferimento.



28 - 16







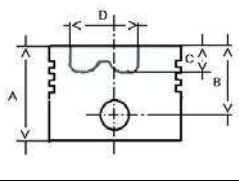
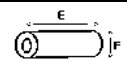

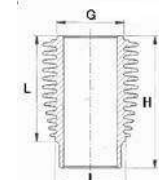
rel. 1511

Non original engine parts. OEMs names and part numbers are for reference purpose only.

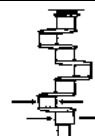
ACME

ADN 45 W	Cm³	CILINDRI CYLINDERS	ALESAGGIO BORE	CORSA STROKE	VERSIONE VERSION
		1	82		22600001 →

		TESTA HEAD	A	50				TIPO TYPE A
			B	11,8				
FIN248PN	854.113							
82	B0353	FIN106PC00	A2591	FIN004RS00				
82,5	B0354	FIN106PC05	A2592	FIN004RS05				
83	B0355	FIN106PC10	A2593	FIN004RS10				
							203.124	FIN510SL00

		Nr.						ADATTABILE A: SUITABLE FOR:	
---	---	------------	---	---	---	---	---	--------------------------------	---

CR	RP	1	45,00	48,02	23,00		STD - 025 - 050	316.126	FIN134CR STD
----	----	---	-------	-------	-------	--	-----------------	---------	--------------

MB	ALL	2	42,09	50,03	40,20		STD - 025 - 050 - 075 - 100 - BAR - BAR EM1	310.016	FIN016MB STD
----	-----	---	-------	-------	-------	--	---	---------	--------------





--	--	--	--	--	--	--	--	--	--

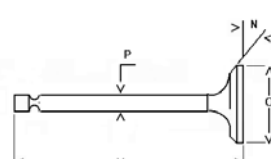

--	--	--	--	--	--	--	--	--	--

PB	BM	1	25,02	28,02	27,50		SEMIF.	316.041	FIN141PB
----	----	---	-------	-------	-------	--	--------	---------	----------

--	--	--	--	--	--	--	--	--	--

--	--	--	--	--	--	--	--	--	--

	IN EX		Nr.	O	P	M	N		ADATTABILE A: SUITABLE FOR:			
	IN		FN	1	35	8	87,5		45	A1	960.136	FINA5002
	EX		FN	1	30	8	87,5		45	A1	960.137	FINS5003

	IN EX		Nr.	R	S	T		ADATTABILE A: SUITABLE FOR:				
	IN		G	1						464.134	FIN010AA	
	IN											
	EX		G	1							464.133	FIN011SA
EX												

Ricambi non originali per motori. Denominazioni e codici originali, sono riportati a puro titolo di riferimento.

29 - 16

rel. 1511

Non original engine parts. OEMs names and part numbers are for reference purpose only.

ACME

ADN 45 W	Cm³	CILINDRI CYLINDERS	ALESAGGIO BORE	CORSA STROKE	VERSIONE VERSION
		1	82		22600001 →

	A2119	A2394	054.131	054.016	447.076	447.079	448.014	448.014
FIN108CGA	FIN108CGB	FIN084SM	FIN3216RT	FIN3215RT	FIN206CO	FIN281CB	FIN503IG	FIN503IG

 ADATTABILE A: SUITABLE FOR:	 FIN6241HG	Nr.	ENGINE KIT	ELECTRIC KIT
		1	 FIN510SL00	
		1	 FIN106PC00	
		1	 FIN084SM FIN008KIT	

387.186	059.159	359.137	359.138	391.012	175.005		
FIN2501AF	FIN5301PF	FIN1201NF	FIN053CFA	FIN4227FE	FIN4225OF		

2117				2122			
FIN1065KR				FIN022OP			

652.108	656.104	475.118	644.112	660.101	956.109		
FIN652FP	FIN761JP	FIN562NH	FIN402NO	FIN430E	FIN102DV		

		890.002					
		FIN303ST					

Ricambi non originali per motori. Denominazioni e codici originali, sono riportati a puro titolo di riferimento.







30 - 16



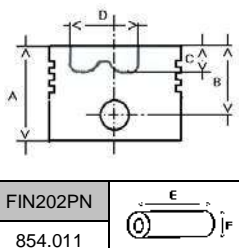

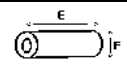

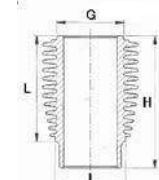
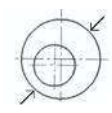

rel. 1511

Non original engine parts. OEMs names and part numbers are for reference purpose only.

ACME

ADN 48	Cm³	CILINDRI CYLINDERS	ALESAGGIO BORE	CORSA STROKE	VERSIONE VERSION
		1	85		1° SERIE

		TESTA HEAD	H43		3	2,5	TIPO TYPE	A		
		A	88		10	2,5				
FIN202PN 854.011		B	50		10	2,5		G	105	
		C	12		22	5		H	165,5	
	85 2130	D	44	2135 FIN069RS00	203.010			I	98	
		E	74					2136 FIN069RS05	L	122,4
		F	25						2137 FIN069RS10	FIN489SL00
85,5 2131	FIN192PC00									
86 2132	FIN192PC05									
		FIN192PC10								

		Nr.						ADATTABILE A: SUITABLE FOR:	
--	---	------------	---	---	---	---	---	--------------------------------	---

CR	AL	1	45,00	48,01	24,12		STD - 025 - 050 - 075 - 100 - BAR	316.036	FIN036CR STD
----	----	---	-------	-------	-------	--	-----------------------------------	---------	--------------

MB	ALL	2	42,09	50,03	40,20		STD - 025 - 050 - 075 - 100 - BAR - BAR EM1	310.016	FIN016MB STD
----	-----	---	-------	-------	-------	--	---	---------	--------------





--	--	--	--	--	--	--	--	--	--



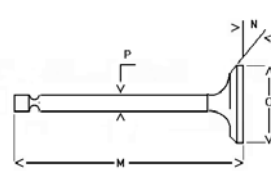

--	--	--	--	--	--	--	--	--	--

PB	BM	1	25,02	28,02	27,50		SEMIF.	316.041	FIN141PB
----	----	---	-------	-------	-------	--	--------	---------	----------

--	--	--	--	--	--	--	--	--	--

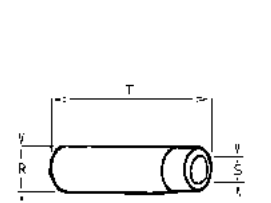
--	--	--	--	--	--	--	--	--	--

	IN EX		Nr.	O	P	M	N		ADATTABILE A: SUITABLE FOR:			
	IN		FS	1	35	9	105		45	E1	960.016	FINA116
	EX		FN	1	35	9	105		45	A1	960.015	FINS117

	IN EX		Nr.	R	S	T		ADATTABILE A: SUITABLE FOR:			
	IN		G	1	15,03	9,04		45	L	464.039	FIN203AA
	IN		G		15,13	9,04		45	L		FIN203AB
	EX		G	1	15,03	9,04		45	L	464.040	FIN204SA
EX	G		15,13	9,04	45	L		FIN204SB			

Ricambi non originali per motori. Denominazioni e codici originali, sono riportati a puro titolo di riferimento.

31 - 16

rel. 1511

Non original engine parts. OEMs names and part numbers are for reference purpose only.

ACME

ADN 48	Cm³	CILINDRI CYLINDERS	ALESAGGIO BORE	CORSA STROKE	VERSIONE VERSION
		1	85		1 SERIE

	A2119	A2393	054.015	054.016	447.076	447.079	448.014	448.014
FIN108CGA	FIN108CGB	FIN082SM	FIN3216RT	FIN3215RT	FIN206CO	FIN281CB	FIN503IG	FIN503IG

 ↓ === ↑	ADATTABILE A: SUITABLE FOR:		Nr.	ENGINE KIT	ELECTRIC KIT
	447.078	FIN6241HG	1	 FIN489SL00	
			1	 FIN192PC00	
			1	 FIN082SM	
				FIN0902KIT	

387.039		359.013		391.012	175.005		
FIN2208AF		FIN1033NF		FIN4227FE	FIN4225OF		

2117				2122			
FIN1065KR				FIN022OP			

	656.003	2123	644.007	660.003	956.005		
	FIN708JP	FIN561NH	FIN114NO	FIN074E	FIN016DV		







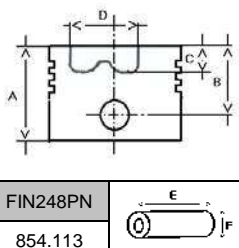
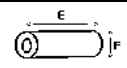
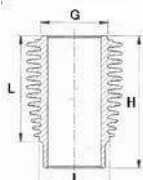

		890.002					
		FIN303ST					

Ricambi non originali per motori. Denominazioni e codici originali, sono riportati a puro titolo di riferimento.

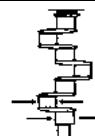
ACME

ADN 48	Cm³	CILINDRI CYLINDERS	ALESAGGIO BORE	CORSA STROKE	VERSIONE VERSION
		1	85		2260000 ←

		TESTA HEAD	A	3	2	TIPO TYPE	A	
			B	10	2		G	105
FIN248PN		C	23	4		H	165,5	
854.113		E				I	98	
85	A2674	F			203.010	L	122,4	
85,5		FIN110PC00	A2552	FIN005RS00		FIN489SL00		
86		FIN110PC05	A2579	FIN005RS05				
		FIN110PC10	A2580	FIN005RS10				

		Nr.						ADATTABILE A: SUITABLE FOR:	
---	---	------------	---	---	---	---	---	--------------------------------	---

CR	RP	1	45,00	48,02	23,00		STD - 025 - 050	316.126	FIN134CR STD
----	----	---	-------	-------	-------	--	-----------------	---------	--------------

MB	ALL	2	42,09	50,03	40,20		STD - 025 - 050 - 075 - 100 - BAR - BAR EM1	310.016	FIN016MB STD
----	-----	---	-------	-------	-------	--	---	---------	--------------





--	--	--	--	--	--	--	--	--	--



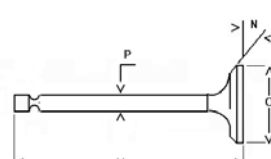

--	--	--	--	--	--	--	--	--	--

PB	BM	1	25,02	28,02	27,50		SEMIF.	316.041	FIN141PB
----	----	---	-------	-------	-------	--	--------	---------	----------

--	--	--	--	--	--	--	--	--	--

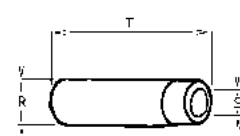
--	--	--	--	--	--	--	--	--	--

	IN EX		Nr.	O	P	M	N		ADATTABILE A: SUITABLE FOR:			
	IN		FS	1	35	9	105		45	E1	960.016	FINA116
	EX		FN	1	35	9	105		45	A1	960.015	FINS117

	IN EX		Nr.	R	S	T		ADATTABILE A: SUITABLE FOR:			
	IN		G	1	15,03	9,04		45	L	464.039	FIN203AA
	IN		G		15,13	9,04		45	L		FIN203AB
	EX		G	1	15,03	9,04		45	L	464.040	FIN204SA
	EX		G		15,13	9,04		45	L		FIN204SB

Ricambi non originali per motori. Denominazioni e codici originali, sono riportati a puro titolo di riferimento.

33 - 16
rel. 1511

Non original engine parts. OEMs names and part numbers are for reference purpose only.

ACME

ADN 48	Cm³	CILINDRI CYLINDERS	ALESAGGIO BORE	CORSA STROKE	VERSIONE VERSION
		1	85		2260000 ←

	A2119	A2393	054.131	054.016	447.076	447.079	448.014	448.014
FIN108CGA	FIN108CGB	FIN082SM	FIN3216RT	FIN3215RT	FIN206CO	FIN281CB	FIN503IG	FIN503IG

 	ADATTABILE A: SUITABLE FOR:		Nr.	ENGINE KIT	ELECTRIC KIT
	447.078	FIN6241HG	1	 FIN489SL00	
			1	 FIN110PC00	
			1	 FIN082SM	
				FIN010KIT	

387.186	059.159	359.137	359.138	391.012	175.005		
FIN2501AF	FIN5301PF	FIN1201NF	FIN053CFA	FIN4227FE	FIN4225OF		

2117				2122			
FIN1065KR				FIN022OP			

652.108	656.109	475.118	644.112	660.102	956.109		
FIN652FP	FIN765JP	FIN562NH	FIN402NO	FIN440E	FIN102DV		

		890.002					
		FIN303ST					

Ricambi non originali per motori. Denominazioni e codici originali, sono riportati a puro titolo di riferimento.

34 - 16







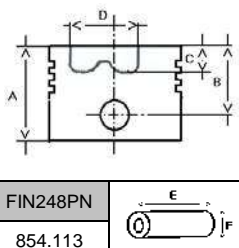
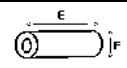
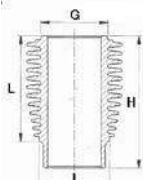
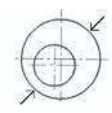

rel. 1511

Non original engine parts. OEMs names and part numbers are for reference purpose only.

ACME

ADN 48 W	Cm³	CILINDRI CYLINDERS	ALESAGGIO BORE	CORSA STROKE	VERSIONE VERSION
		1	85		22600001 →

		TESTA HEAD	A	3	2	TIPO TYPE	A		
			B	10	2		G	105	
	FIN248PN	C	14	23	4		H	165,5	
	854.113	D	42,5				I	98	
	85	B0357	FIN111PC00	A2552	FIN005RS00	203.010	L	122,4	
	85,5	B0358	FIN111PC05	A2579	FIN005RS05		FIN489SL00		
	86	B0359	FIN111PC10	A2580	FIN005RS10				

		Nr.						ADATTABILE A: SUITABLE FOR:	
---	---	------------	---	---	---	---	---	--	---

CR	RP	1	45,00	48,02	23,00		STD - 025 - 050	316.126	FIN134CR STD
----	----	---	-------	-------	-------	--	-----------------	---------	--------------

MB	ALL	2	42,09	50,03	40,20		STD - 025 - 050 - 075 - 100 - BAR - BAR EM1	310.016	FIN016MB STD
----	-----	---	-------	-------	-------	--	---	---------	--------------





--	--	--	--	--	--	--	--	--	--



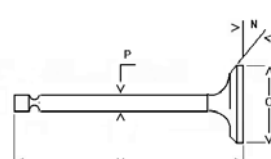

--	--	--	--	--	--	--	--	--	--

PB	BM	1	25,02	28,02	27,50		SEMIF.	316.041	FIN141PB
----	----	---	-------	-------	-------	--	--------	---------	----------

--	--	--	--	--	--	--	--	--	--

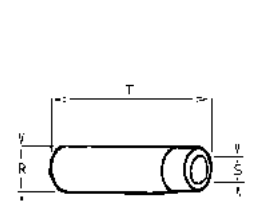
--	--	--	--	--	--	--	--	--	--

	IN EX		Nr.	O	P	M	N		ADATTABILE A: SUITABLE FOR:			
	IN		FN	1	35	8	87,5		45	A1	960.136	FINA5002
	EX		FN	1	30	8	87,5		45	A1	960.137	FINS5003

	IN EX		Nr.	R	S	T		ADATTABILE A: SUITABLE FOR:				
	IN		G	1		8				464.134	FIN010AA	
	IN		G			8						
	EX		G	1		8				464.133	FIN011SA	
	EX	G			8							

Ricambi non originali per motori. Denominazioni e codici originali, sono riportati a puro titolo di riferimento.

35 - 16

rel. 1511

Non original engine parts. OEMs names and part numbers are for reference purpose only.

ACME

ADN 48 W	Cm³	CILINDRI CYLINDERS	ALESAGGIO BORE	CORSA STROKE	VERSIONE VERSION
		1	85		22600001 →

	A2119	A2393	054.131	054.016	447.076	447.079	448.014	448.014
FIN108CGA	FIN108CGB	FIN082SM	FIN3216RT	FIN3215RT	FIN206CO	FIN281CB	FIN503IG	FIN503IG

 	ADATTABILE A: SUITABLE FOR:		Nr.	ENGINE KIT	ELECTRIC KIT
	447.078	FIN6241HG	1	 FIN489SL00	
			1	 FIN111PC00	
			1	 FIN082SM	
				FIN011KIT	

387.186	059.159	359.137	359.138	391.012	175.005		
FIN2501AF	FIN5301PF	FIN1201NF	FIN053CFA	FIN4227FE	FIN4225OF		

2117				2122			
FIN1065KR				FIN022OP			

652.108	656.109	475.118	644.112	660.102	956.109		
FIN652FP	FIN765JP	FIN562NH	FIN402NO	FIN440E	FIN102DV		

		890.002					
		FIN303ST					

Ricambi non originali per motori. Denominazioni e codici originali, sono riportati a puro titolo di riferimento.





36 - 16





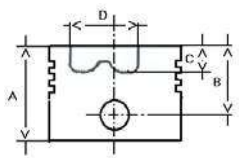

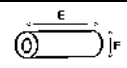

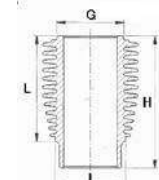
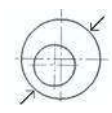
rel. 1511

Non original engine parts. OEMs names and part numbers are for reference purpose only.

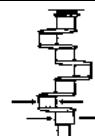
ACME

ADN 54	Cm³	CILINDRI CYLINDERS	ALESAGGIO BORE	CORSA STROKE	VERSIONE VERSION
	540	1	90	85	1° SERIE

		TESTA HEAD	H14		3	2,5	TIPO TYPE	A	
		A	85		1	2,5			
FIN202PN 854.011		B	50		10	2,5		G	105
		C	15		22	5		H	165,6
	FIN195PC00 FIN195PC05 FIN195PC10	E	74	2149	FIN071RS00		203.012	I	98
		F	25	2150	FIN071RS05			L	122,4
		90	2144	2151	FIN071RS10			FIN028SL00	
90,5	2145								
91	2146								

		Nr.						ADATTABILE A: SUITABLE FOR:	
---	---	------------	---	---	---	---	---	--------------------------------	---

CR	AL	1	45,00	48,01	24,12		STD - 025 - 050 - 075 - 100 - BAR	316.036	FIN036CR STD
----	----	---	-------	-------	-------	--	-----------------------------------	---------	--------------

MB	ALL	2	42,09	50,03	40,20		STD - 025 - 050 - 075 - 100 - BAR - BAR EM1	310.016	FIN016MB STD
----	-----	---	-------	-------	-------	--	---	---------	--------------





--	--	--	--	--	--	--	--	--	--



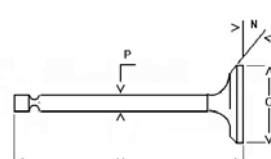

--	--	--	--	--	--	--	--	--	--

PB	BM	1	25,02	28,02	27,5		SEMIF.	316.041	FIN141PB
----	----	---	-------	-------	------	--	--------	---------	----------

--	--	--	--	--	--	--	--	--	--

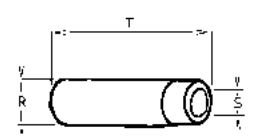
--	--	--	--	--	--	--	--	--	--

	IN EX		Nr.	O	P	M	N		ADATTABILE A: SUITABLE FOR:				
	IN		FS	1	37,6	9	105		45		E1	960.045	FINA124
	EX		FN	1	37	9	105		45		A1	960.046	FINS125

	IN EX		Nr.	R	S	T		ADATTABILE A: SUITABLE FOR:				
	IN		G	1	15,03	9,04		45		L	464.039	FIN203AA
	IN		G		15,13	9,04		45		L		FIN203AB
	EX		G	1	15,03	9,04		45		L	464.040	FIN204SA
	EX		G		15,13	9,04		45		L		FIN204SB

Ricambi non originali per motori. Denominazioni e codici originali, sono riportati a puro titolo di riferimento.

37 - 16

rel. 1511

Non original engine parts. OEMs names and part numbers are for reference purpose only.

ACME

ADN 54	Cm³	CILINDRI CYLINDERS	ALESAGGIO BORE	CORSA STROKE	VERSIONE VERSION
	540	1	90	85	1 SERIE

	A2140	A2394	054.015	054.016	447.076	447.079	448.014	448.014
FIN110CGA	FIN110CGB	FIN084SM	FIN3216RT	FIN3215RT	FIN206CO	FIN281CB	FIN503IG	FIN503IG

 ↓ ADATTABILE A: SUITABLE FOR: ↑			Nr.	ENGINE KIT	ELECTRIC KIT
	448.008	FIN6241HG	1	 FIN028SL00	
			1	 FIN195PC00	
			1	 FIN084SM	
				FIN012KIT	

387.039		359.013		391.012	175.005		
FIN2208AF		FIN1033NF		FIN4227FE	FIN4225OF		

2117				2122			
FIN1065KR				FIN022OP			

	656.003	2123	644.007	660.003	956.005		
	FIN708JP	FIN561NH	FIN114NO	FIN074E	FIN016DV		

		890.002					
		FIN303ST					

Ricambi non originali per motori. Denominazioni e codici originali, sono riportati a puro titolo di riferimento.



38 - 16







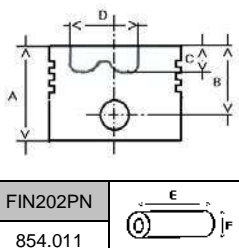
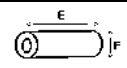

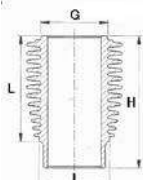
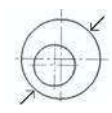
rel. 1511

Non original engine parts. OEMs names and part numbers are for reference purpose only.

ACME

ADN 54	Cm³	CILINDRI CYLINDERS	ALESAGGIO BORE	CORSA STROKE	VERSIONE VERSION
	540	1	90	85	2260000 ←

		TESTA HEAD	A	3	2	TIPO TYPE	A		
			B				50	10	2
	FIN202PN	C	15		22	4		H	165,6
	854.011	F	25					A2670	FIN007RS00
	90	A2678	FIN113PC00	A2671	FIN007RS05	203.012	FIN028SL00	L	122,4
	90,5		FIN113PC05	A2672	FIN007RS10				
	91		FIN113PC10						

		Nr.						ADATTABILE A: SUITABLE FOR:	
---	---	------------	---	---	---	---	---	--------------------------------	---

CR	RP	1	45,00	48,02	23,00		STD - 025 - 050	316.126	FIN134CR STD
----	----	---	-------	-------	-------	--	-----------------	---------	--------------

MB	ALL	2	42,09	50,03	40,20		STD - 025 - 050 - 075 - 100 - BAR - BAR EM1	310.016	FIN016MB STD
----	-----	---	-------	-------	-------	--	---	---------	--------------





--	--	--	--	--	--	--	--	--	--



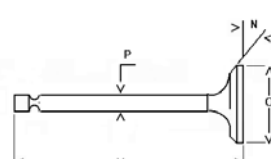

--	--	--	--	--	--	--	--	--	--

PB	BM	1	25,02	28,02	27,50		SEMIF.	316.041	FIN141PB
----	----	---	-------	-------	-------	--	--------	---------	----------

--	--	--	--	--	--	--	--	--	--

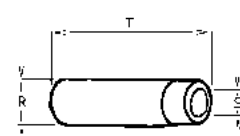
--	--	--	--	--	--	--	--	--	--

	IN EX		Nr.	O	P	M	N		ADATTABILE A: SUITABLE FOR:			
	IN		FS	1	37,6	9	105		45	E1	960.045	FINA124
	EX		FN	1	37	9	105		45	A1	960.046	FINS125

	IN EX		Nr.	R	S	T		ADATTABILE A: SUITABLE FOR:			
	IN		G	1	15,03	9,04		45	L	464.039	FIN203AA
	IN		G		15,13	9,04		45	L		FIN203AB
	EX		G	1	15,03	9,04		45	L	464.040	FIN204SA
EX	G		15,13	9,04	45	L			FIN204SB		

Ricambi non originali per motori. Denominazioni e codici originali, sono riportati a puro titolo di riferimento.

39 - 16

rel. 1511

Non original engine parts. OEMs names and part numbers are for reference purpose only.

ACME

ADN 54	Cm³	CILINDRI CYLINDERS	ALESAGGIO BORE	CORSA STROKE	VERSIONE VERSION
	540	1	90	85	2260000 ←

	A2140	A2394	054.131	054.016	447.076	447.079	448.014	448.014
FIN110CGA	FIN110CGB	FIN084SM	FIN3216RT	FIN3215RT	FIN206CO	FIN281CB	FIN503IG	FIN503IG

 	ADATTABILE A: SUITABLE FOR:		Nr.	ENGINE KIT	ELECTRIC KIT
	448.008	FIN6241HG	1	 FIN028SL00	
			1	 FIN113PC00	
			1	 FIN084SM	
				FIN013KIT	

387.186	059.159	359.137	359.138	391.012	175.005		
FIN2501AF	FIN5301PF	FIN1201NF	FIN053CFA	FIN4227FE	FIN4225OF		

2117				2122			
FIN1065KR				FIN022OP			

652.108	656.109	475.118	644.112	660.112	956.109		
FIN652FP	FIN765JP	FIN562NH	FIN402NO	FIN402E	FIN102DV		

		890.002					
		FIN303ST					

Ricambi non originali per motori. Denominazioni e codici originali, sono riportati a puro titolo di riferimento.



40 - 16







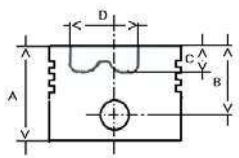
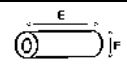
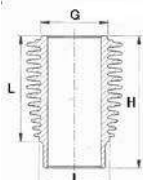

rel. 1511

Non original engine parts. OEMs names and part numbers are for reference purpose only.

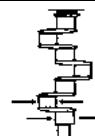
ACME

ADN 54 W	Cm³	CILINDRI CYLINDERS	ALESAGGIO BORE	CORSA STROKE	VERSIONE VERSION
	540	1	90	85	22600001 →

		TESTA HEAD	A	3	2	TIPO TYPE	A	
			B	10	2		G	105
	FIN202PN	C	15	22	4		H	165,6
	854.011	D	43				I	98
	90	B0361	FIN114PC00	A2670	FIN007RS00	203.012	L	122,4
	90,5	B0362	FIN114PC05	A2671	FIN007RS05		FIN028SL00	
	91	B0363	FIN114PC10	A2672	FIN007RS10			

		Nr.						ADATTABILE A: SUITABLE FOR:	
---	---	------------	---	---	---	---	---	--------------------------------	---

CR	RP	1	45,00	48,02	23,00		STD - 025 - 050	316.126	FIN134CR STD
----	----	---	-------	-------	-------	--	-----------------	---------	--------------

MB	ALL	2	42,09	50,03	40,20		STD - 025 - 050 - 075 - 100 - BAR - BAR EM1	310.016	FIN016MB STD
----	-----	---	-------	-------	-------	--	---	---------	--------------





--	--	--	--	--	--	--	--	--	--



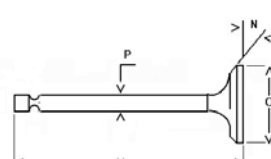

--	--	--	--	--	--	--	--	--	--

PB	BM	1	25,02	28,02	27,50		SEMIF.	316.041	FIN141PB
----	----	---	-------	-------	-------	--	--------	---------	----------

--	--	--	--	--	--	--	--	--	--

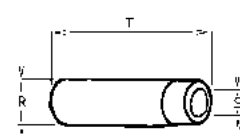
--	--	--	--	--	--	--	--	--	--

	IN EX		Nr.	O	P	M	N		ADATTABILE A: SUITABLE FOR:								
	IN								FS	1	38,5	8	87,5	45	A1	960.128	FINA5000
	EX								FN	1	37	8	87,5	45	A1	960.129	FINS5001

	IN EX		Nr.	R	S	T		ADATTABILE A: SUITABLE FOR:								
	IN							G	1					464.134	FIN010AA	
	IN															
	EX							G	1					464.133	FIN011SA	
EX																

Ricambi non originali per motori. Denominazioni e codici originali, sono riportati a puro titolo di riferimento.

41 - 16

rel. 1511

Non original engine parts. OEMs names and part numbers are for reference purpose only.

ACME

ADN 54 W	Cm³	CILINDRI CYLINDERS	ALESAGGIO BORE	CORSA STROKE	VERSIONE VERSION
	540	1	90	85	22600001 →

	A2140	A2394	054.131	054.016	447.076	447.079	448.014	448.014
FIN110CGA	FIN110CGB	FIN084SM	FIN3216RT	FIN3215RT	FIN206CO	FIN281CB	FIN503IG	FIN503IG

 	ADATTABILE A: SUITABLE FOR:		Nr.	ENGINE KIT	ELECTRIC KIT
	448.008	FIN6241HG	1	 FIN028SL00	
			1	 FIN114PC00	
			1	 FIN084SM	
				FIN014KIT	

387.186	059.159	359.137	359.138	391.012	175.005		
FIN2501AF	FIN5301PF	FIN1201NF	FIN053CFA	FIN4227FE	FIN4225OF		

2117				2122			
FIN1065KR				FIN022OP			

652.108	656.109	475.118	644.112	660.102	956.109		
FIN652FP	FIN765JP	FIN562NH	FIN402NO	FIN440E	FIN102DV		

		890.002					
		FIN303ST					

Ricambi non originali per motori. Denominazioni e codici originali, sono riportati a puro titolo di riferimento.



42 - 16







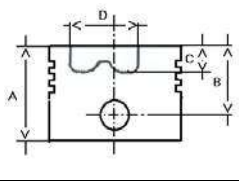

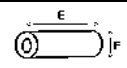
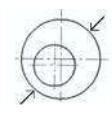
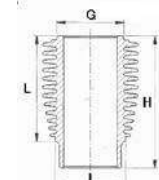
rel. 1511

Non original engine parts. OEMs names and part numbers are for reference purpose only.

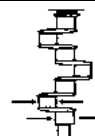
ACME

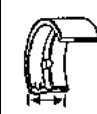
ADN 60	Cm³	CILINDRI CYLINDERS	ALESAGGIO BORE	CORSA STROKE	VERSIONE VERSION
		1	95		1 SERIE

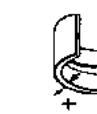
		TESTA HEAD			<table border="1"> <tr><td>3</td><td>2,5</td></tr> <tr><td>1</td><td>2,5</td></tr> <tr><td>10</td><td>2,5</td></tr> <tr><td>21</td><td>5,5</td></tr> </table>	3	2,5	1	2,5	10	2,5	21	5,5	TIPO TYPE	<table border="1"> <tr><td colspan="2">A</td></tr> <tr><td>G</td><td>105</td></tr> <tr><td>H</td><td>165,6</td></tr> <tr><td>I</td><td>100</td></tr> <tr><td>L</td><td>122,4</td></tr> </table>		A		G	105	H	165,6	I	100	L	122,4
		3	2,5																							
		1	2,5																							
		10	2,5																							
21	5,5																									
A																										
G	105																									
H	165,6																									
I	100																									
L	122,4																									
FIN202PN		A																								
854.011		B	50																							
		C	17																							
		D	42																							
		E	74																							
		F	25																							
				2461	FIN076RS00																					
	95	2458	FIN115PC00				203.042	FIN033SL00																		
	95,5	2459	FIN115PC05																							
	96	2460	FIN115PC10																							

		Nr.							ADATTABILE A: SUITABLE FOR:	
---	---	------------	---	---	---	---	---	--	--------------------------------	---

CR	AL	1	45,00	48,01	24,12				STD - 025 - 050 - 075 - 100 - BAR	316.036	FIN036CR STD
----	----	---	-------	-------	-------	--	--	--	-----------------------------------	---------	--------------

MB	ALL	2	42,09	50,03	40,20				STD - 025 - 050 - 075 - 100 - BAR - BAR EM1	310.016	FIN016MB STD
----	-----	---	-------	-------	-------	--	--	--	---	---------	--------------





--	--	--	--	--	--	--	--	--	--	--	--



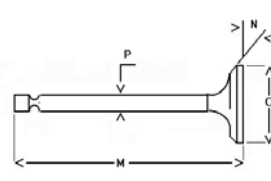

--	--	--	--	--	--	--	--	--	--	--	--

PB	BM	1	25,02	28,02	27,50				SEMIF.	316.041	FIN141PB
----	----	---	-------	-------	-------	--	--	--	--------	---------	----------

--	--	--	--	--	--	--	--	--	--	--	--

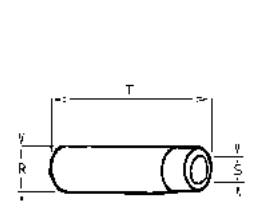
--	--	--	--	--	--	--	--	--	--	--	--

	IN EX		Nr.	O	P	M	N		ADATTABILE A: SUITABLE FOR:				
	IN		FS	1	37,6	9	105		45		E1	960.045	FINA124
	EX		FN	1	37	9	105		45		A1	960.046	FINS125

	IN EX		Nr.	R	S	T		ADATTABILE A: SUITABLE FOR:				
	IN		G	1	15,03	9,04		45		L	464.039	FIN203AA
	IN		G		15,13	9,04		45		L		FIN203AB
	EX		G	1	15,03	9,04		45		L	464.040	FIN204SA
	EX	G		15,13	9,04	45	L		FIN204SB			

Ricambi non originali per motori. Denominazioni e codici originali, sono riportati a puro titolo di riferimento.

43 - 16

rel. 1511

Non original engine parts. OEMs names and part numbers are for reference purpose only.

ACME

ADN 60	Cm³	CILINDRI CYLINDERS	ALESAGGIO BORE	CORSA STROKE	VERSIONE VERSION
		1	95		1 SERIE

	A2482	A2483	054.015	054.016	447.076	447.079	448.014	448.014
FIN115CGA	FIN115CGB	FIN089SM	FIN3216RT	FIN3215RT	FIN206CO	FIN281CB	FIN503IG	FIN503IG

 	ADATTABILE A: SUITABLE FOR:		Nr.	ENGINE KIT	ELECTRIC KIT
	449.052	FIN625HG	1	 FIN033SL00	
			1	 FIN115PC00	
			1	 FIN082SM	
				FIN015KIT	

387.039		359.013		391.012	175.005		
FIN2208AF		FIN1033NF		FIN4227FE	FIN4225OF		

2117				2122			
FIN1065KR				FIN022OP			



	656.003	2123	644.007	660.003	956.005		
	FIN708JP	FIN561NH	FIN114NO	FIN074E	FIN016DV		







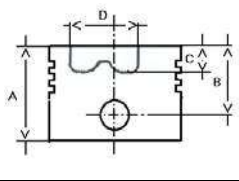

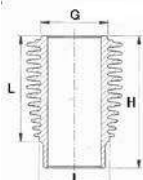
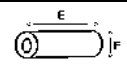
		890.002					
		FIN303ST					

Ricambi non originali per motori. Denominazioni e codici originali, sono riportati a puro titolo di riferimento.

ACME

ADN 60	Cm³	CILINDRI CYLINDERS	ALESAGGIO BORE	CORSA STROKE	VERSIONE VERSION
		1	95		2260000 ←

		TESTA HEAD				TIPO TYPE		A	
		A				G	105		
		B				H	165,6		
		C				I	100		
		D				L	122,4		
		FIN202PN 854.011				E 74 F 25			
95	A2716	FIN012PC00	A2685	FIN154RS00	203.042	FIN033SL00			

		Nr.						ADATTABILE A: SUITABLE FOR:	
---	---	------------	---	---	---	---	---	--------------------------------	---

CR	RP	1	45,00	48,02	23,00		STD - 025 - 050	316.126	FIN134CR STD
----	----	---	-------	-------	-------	--	-----------------	---------	--------------

MB	ALL	2	42,09	50,03	40,20		STD - 025 - 050 - 075 - 100 - BAR - BAR EM1	310.016	FIN016MB STD
----	-----	---	-------	-------	-------	--	---	---------	--------------





--	--	--	--	--	--	--	--	--	--



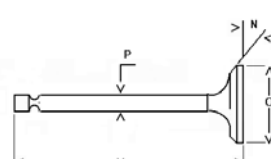

--	--	--	--	--	--	--	--	--	--

PB	BM	1	25,02	28,02	27,50		SEMIF.	316.041	FIN141PB
----	----	---	-------	-------	-------	--	--------	---------	----------

--	--	--	--	--	--	--	--	--	--

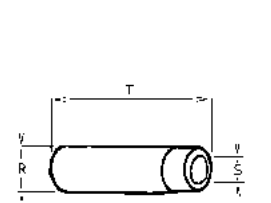
--	--	--	--	--	--	--	--	--	--

	IN EX		Nr.	O	P	M	N		ADATTABILE A: SUITABLE FOR:	
	IN	FS	1	37,6	9	105	45	E1	960.045	FINA124
	EX	FN	1	37	9	105	45	A1	960.046	FINS125

	IN EX		Nr.	R	S	T		ADATTABILE A: SUITABLE FOR:	
	IN	G	1	15,03	9,04	45	L	464.039	FIN203AA
	IN	G		15,13	9,04	45	L		FIN203AB
	EX	G	1	15,03	9,04	45	L	464.040	FIN204SA
	EX	G		15,13	9,04	45	L		FIN204SB

Ricambi non originali per motori. Denominazioni e codici originali, sono riportati a puro titolo di riferimento.

45 - 16
rel. 1511

Non original engine parts. OEMs names and part numbers are for reference purpose only.

ACME

ADN 60	Cm³	CILINDRI CYLINDERS	ALESAGGIO BORE	CORSA STROKE	VERSIONE VERSION
		1	95		2260000 ←

	A2490		054.131	054.016	447.076	447.079	448.014	448.014
FIN752CGA	FIN752CGB		FIN3216RT	FIN3215RT	FIN206CO	FIN281CB	FIN503IG	FIN503IG

 	ADATTABILE A: SUITABLE FOR:		Nr.	ENGINE KIT	ELECTRIC KIT
	449.052	FIN625HG	1		
			1		
			1		

387.186	059.159	359.137	359.138	391.012	175.005		
FIN2501AF	FIN5301PF	FIN1201NF	FIN053CFA	FIN4227FE	FIN4225OF		

2117				2122			
FIN1065KR				FIN022OP			

652.108	656.109	475.118	644.112	660.102	956.109		
FIN652FP	FIN765JP	FIN562NH	FIN402NO	FIN440E	FIN102DV		

		890.002					
		FIN303ST					

Ricambi non originali per motori. Denominazioni e codici originali, sono riportati a puro titolo di riferimento.



46 - 16







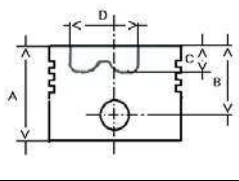

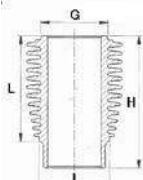
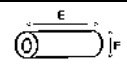
rel. 1511

Non original engine parts. OEMs names and part numbers are for reference purpose only.

ACME

ADN 60 W	Cm³	CILINDRI CYLINDERS	ALESAGGIO BORE	CORSA STROKE	VERSIONE VERSION
		1	95		22600001 →

		TESTA HEAD				A	
		A				G	105
		B				H	165,6
		C				I	100
		D				L	122,4
		FIN202PN 854.011				E 74 F 25	
95	B0389	FIN011PC00	A2685	FIN154RS00	203.042	FIN033SL00	

		Nr.						ADATTABILE A: SUITABLE FOR:	
---	---	------------	---	---	---	---	---	--------------------------------	---

CR	RP	1	45,00	48,02	23,00		STD - 025 - 050	316.126	FIN134CR STD
----	----	---	-------	-------	-------	--	-----------------	---------	--------------

MB	ALL	2	42,09	50,03	40,20		STD - 025 - 050 - 075 - 100 - BAR - BAR EM1	310.016	FIN016MB STD
----	-----	---	-------	-------	-------	--	---	---------	--------------





--	--	--	--	--	--	--	--	--	--



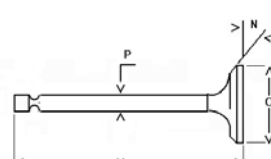

--	--	--	--	--	--	--	--	--	--

PB	BM	1	25,02	28,02	27,50		SEMIF.	316.041	FIN141PB
----	----	---	-------	-------	-------	--	--------	---------	----------

--	--	--	--	--	--	--	--	--	--

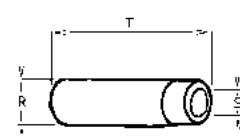
--	--	--	--	--	--	--	--	--	--

	IN EX		Nr.	O	P	M	N		ADATTABILE A: SUITABLE FOR:	
	IN	FS	1	38,5	8	87,5	45	A1	960.128	FINA5000
	EX	FN	1	37	8	87,5	45	A1	960.129	FINS5001

	IN EX		Nr.	R	S	T		ADATTABILE A: SUITABLE FOR:	
	IN	G	1					464.134	FIN010AA
	IN								
	EX	G	1					464.133	FIN011SA

Ricambi non originali per motori. Denominazioni e codici originali, sono riportati a puro titolo di riferimento.

47 - 16

rel. 1511

Non original engine parts. OEMs names and part numbers are for reference purpose only.

ACME

ADN 60 W	Cm³	CILINDRI CYLINDERS	ALESAGGIO BORE	CORSA STROKE	VERSIONE VERSION
		1	95		22600001 →

	A2490		054.131	054.016	447.076	447.079	448.014	448.014
FIN752CGA	FIN752CGB		FIN3216RT	FIN3215RT	FIN206CO	FIN281CB	FIN503IG	FIN503IG

 	ADATTABILE A: SUITABLE FOR:		Nr.	ENGINE KIT	ELECTRIC KIT
	449.052	FIN625HG	1		
			1		
			1		

387.186	059.159	359.137	359.138	391.012	175.005		
FIN2501AF	FIN5301PF	FIN1201NF	FIN053CFA	FIN4227FE	FIN4225OF		

2117				2122			
FIN1065KR				FIN022OP			

652.108	656.109	475.118	644.112	660.102	956.109		
FIN652FP	FIN765JP	FIN562NH	FIN402NO	FIN440E	FIN102DV		

		890.002					
		FIN303ST					

Ricambi non originali per motori. Denominazioni e codici originali, sono riportati a puro titolo di riferimento.



48 - 16







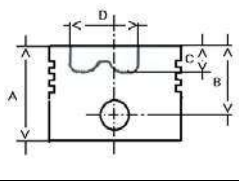
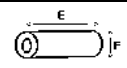

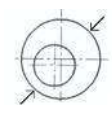
rel. 1511

Non original engine parts. OEMs names and part numbers are for reference purpose only.

ACME

ADX 300	Cm³	CILINDRI CYLINDERS	ALESAGGIO BORE	CORSA STROKE	VERSIONE VERSION
		1	74		

		TESTA HEAD	A	3	2	TIPO TYPE	A	
			B	10	2		G	
FIN802PN		C		22	4	H		
854.119		D				I		
		E				L		
	74	A2813	FIN102PC00	A2816	FIN002RS00	203.129		FIN490SL00
	74,5	A2814	FIN102PC05	A2817	FIN002RS05			
75	A2815	FIN102PC10	A2818	FIN002RS10				

		Nr.						ADATTABILE A: SUITABLE FOR:	
---	---	------------	---	---	---	---	---	--------------------------------	---

CR	AL	1	40,00	43,67	22,00		STD - 025 - 050 - 075 - 100	316.134	FIN111CR STD
----	----	---	-------	-------	-------	--	-----------------------------	---------	--------------

MB	RP	1	40,00	44,02	28,00		STD - 025 - 050 - BAR	310.104	FIN104MB STD
----	----	---	-------	-------	-------	--	-----------------------	---------	--------------





MB	RP	1	40,00	44,02	34,50		STD - 025 - 050 - BAR	310.105	FIN105MB STD
----	----	---	-------	-------	-------	--	-----------------------	---------	--------------



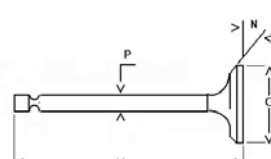

--	--	--	--	--	--	--	--	--	--

PB	BM	1	22,00	24,02	27,00		SEMIF.	316.110	FIN112PB
----	----	---	-------	-------	-------	--	--------	---------	----------

--	--	--	--	--	--	--	--	--	--

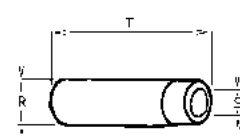
--	--	--	--	--	--	--	--	--	--

	IN EX		Nr.	O	P	M	N		ADATTABILE A: SUITABLE FOR:								
	IN								FS	1	32	7	87,5	45	A1	960.118	FINA149
	EX								FN	1	27	7	87,5	45	A1	960.119	FINS150

	IN EX		Nr.	R	S	T		ADATTABILE A: SUITABLE FOR:							
	IN							G	1				B0038	FIN014AA	
	IN														
	EX							G	1				B0039	FIN015SA	
EX															

Ricambi non originali per motori. Denominazioni e codici originali, sono riportati a puro titolo di riferimento.

49 - 16

rel. 1511

Non original engine parts. OEMs names and part numbers are for reference purpose only.

ACME

ADX 300	Cm³	CILINDRI CYLINDERS	ALESAGGIO BORE	CORSA STROKE	VERSIONE VERSION
		1	74		

	A2424		054.016	054.130				
FIN627CGA	FIN627CGB		FIN3215RT	FIN527RT				

 ADATTABILE A: SUITABLE FOR:	 FIN725HG	Nr.	ENGINE KIT	ELECTRIC KIT
		1		
		1		
		1		

387.168	359.144	359.151	175.020	175.005		
FIN2320AF	FIN1226NF	FIN082CFA	FIN4232FE	FIN4225OF		

	656.105	644.104	660.104	956.109			
	FIN714JP	FIN405NO	FIN450E	FIN102DV			

	656.105	644.104	660.104	956.109			
	FIN714JP	FIN405NO	FIN450E	FIN102DV			

	656.105	644.104	660.104	956.109			
	FIN714JP	FIN405NO	FIN450E	FIN102DV			

	656.105	644.104	660.104	956.109			
	FIN714JP	FIN405NO	FIN450E	FIN102DV			

Ricambi non originali per motori. Denominazioni e codici originali, sono riportati a puro titolo di riferimento.



50 - 16







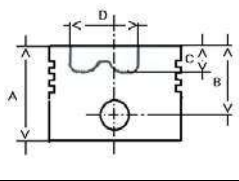

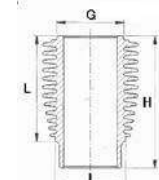
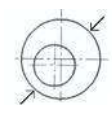
rel. 1511

Non original engine parts. OEMs names and part numbers are for reference purpose only.

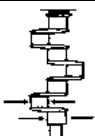
ACME

ADX 370	Cm³	CILINDRI CYLINDERS	ALESAGGIO BORE	CORSA STROKE	VERSIONE VERSION
		1	82		

		TESTA HEAD	A		3	2	TIPO TYPE	A			
			B		40	10		2		G	
			C		11	22		4		H	
			D		42					I	
			E		67,5					L	
			F		22						
	FIN200PN			B0104	FIN004RS00	203.130	FIN491SL00				
	854.012			B0105	FIN004RS05						
				B0106	FIN004RS10						

		Nr.						ADATTABILE A: SUITABLE FOR:	
---	---	------------	---	---	---	---	---	--------------------------------	---

CR	AL	1	40,00	43,67	22,00		STD - 025 - 050 - 075 - 100	316.134	FIN111CR STD
----	----	---	-------	-------	-------	--	-----------------------------	---------	--------------

MB	RP	1	40,00	44,02	28,00		STD - 025 - 050 - BAR	310.104	FIN104MB STD
----	----	---	-------	-------	-------	--	-----------------------	---------	--------------





MB	RP	1	40,00	44,02	34,50		STD - 025 - 050 - BAR	310.105	FIN105MB STD
----	----	---	-------	-------	-------	--	-----------------------	---------	--------------

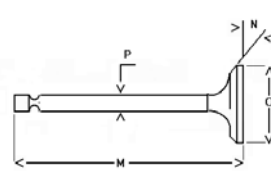

--	--	--	--	--	--	--	--	--	--

PB	BM	1	22,00	24,02	27,00		SEMIF.	316.110	FIN112PB
----	----	---	-------	-------	-------	--	--------	---------	----------

--	--	--	--	--	--	--	--	--	--

--	--	--	--	--	--	--	--	--	--

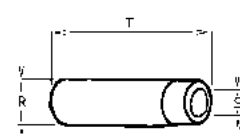
	IN EX		Nr.	O	P	M	N		ADATTABILE A: SUITABLE FOR:			
	IN		FS	1	32	7	87,5		45	A1	960.118	FINA149
	EX		FN	1	27	7	87,5		45	A1	960.119	FINS150

	IN EX		Nr.	R	S	T		ADATTABILE A: SUITABLE FOR:			
	IN		G	1					B0038	FIN014AA	
	IN										
	EX		G	1					B0039	FIN015SA	
EX											

Ricambi non originali per motori. Denominazioni e codici originali, sono riportati a puro titolo di riferimento.

51 - 16

rel. 1511

Non original engine parts. OEMs names and part numbers are for reference purpose only.

ACME

ADX 370	Cm³	CILINDRI CYLINDERS	ALESAGGIO BORE	CORSA STROKE	VERSIONE VERSION
		1	82		

	B0023		054.016	054.130				
FIN628CGA	FIN628CGB		FIN3215RT	FIN527RT				

 ADATTABILE A: SUITABLE FOR:	 FIN726HG	Nr.	ENGINE KIT	ELECTRIC KIT
		1		
		1		
		1		
449.174				

387.168	359.144	359.151	175.020	175.005		
FIN2320AF	FIN1226NF	FIN082CFA	FIN4232FE	FIN4225OF		

	656.105	644.104	660.104	956.109			
	FIN714JP	FIN405NO	FIN450E	FIN102DV			

	656.105	644.104	660.104	956.109			
	FIN714JP	FIN405NO	FIN450E	FIN102DV			

	656.105	644.104	660.104	956.109			
	FIN714JP	FIN405NO	FIN450E	FIN102DV			

	656.105	644.104	660.104	956.109			
	FIN714JP	FIN405NO	FIN450E	FIN102DV			

Ricambi non originali per motori. Denominazioni e codici originali, sono riportati a puro titolo di riferimento.



52 - 16







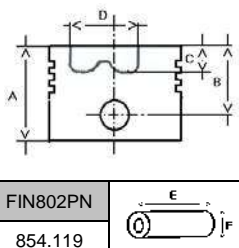
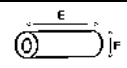

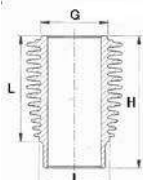
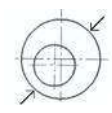
rel. 1511

Non original engine parts. OEMs names and part numbers are for reference purpose only.

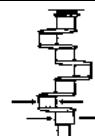
ACME

ADX 600	Cm³	CILINDRI CYLINDERS	ALESAGGIO BORE	CORSA STROKE	VERSIONE VERSION
	602	2	74	70	

		TESTA HEAD	A	3	2	TIPO TYPE	A		
			B	10	2		G		
FIN802PN 854.119		C 9,5 D 38 E 62 F 22					H		
								I	
	74	A2813	FIN102PC00	A2816	FIN002RS00	203.129	L		
	74,5	A2814	FIN102PC05	A2817	FIN002RS05		FIN490SL00		
	75	A2815	FIN102PC10	A2818	FIN002RS10				

		Nr.						ADATTABILE A: SUITABLE FOR:	
---	---	------------	---	---	---	---	---	--------------------------------	---

CR	AL	2	40,00	43,67	22,00		STD - 025 - 050 - 075 - 100	316.134	FIN111CR STD
----	----	---	-------	-------	-------	--	-----------------------------	---------	--------------

MB	RP	1	40,00	44,02	28,00		STD - 025 - 050 - BAR	310.104	FIN104MB STD
----	----	---	-------	-------	-------	--	-----------------------	---------	--------------





MB	RP	1	40,00	44,02	34,50		STD - 025 - 050 - BAR	310.105	FIN105MB STD
----	----	---	-------	-------	-------	--	-----------------------	---------	--------------



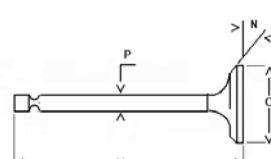

MB	AL	1	40,00	43,67	22,00		STD - 025 - 050 - 075 - 100	316.134	FIN111CR STD
----	----	---	-------	-------	-------	--	-----------------------------	---------	--------------

PB	BM	2	22,00	24,02	27,00		SEMIF.	316.110	FIN112PB
----	----	---	-------	-------	-------	--	--------	---------	----------

--	--	--	--	--	--	--	--	--	--

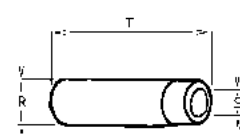
--	--	--	--	--	--	--	--	--	--

	IN EX		Nr.	O	P	M	N		ADATTABILE A: SUITABLE FOR:				
	IN		FS	2	32	7	87,5		45		A1	960.118	FINA149
	EX		FN	2	27	7	87,5		45		A1	960.119	FINS150

	IN EX		Nr.	R	S	T		ADATTABILE A: SUITABLE FOR:				
	IN		G	2						B0038	FIN014AA	
	IN											
	EX		G	2							B0039	FIN015SA
EX												

Ricambi non originali per motori. Denominazioni e codici originali, sono riportati a puro titolo di riferimento.

ACME

ADX 600	Cm³	CILINDRI CYLINDERS	ALESAGGIO BORE	CORSA STROKE	VERSIONE VERSION
	602	2	74	70	

	B0108		054.016	054.130				
FIN629CGA	FIN629CGB		FIN3215RT	FIN527RT				

 	ADATTABILE A: SUITABLE FOR:		Nr.	ENGINE KIT	ELECTRIC KIT
	449.173	FIN725HG	1		
			1		
			1		

387.168	359.144	359.151	175.020	175.005		
FIN2320AF	FIN1226NF	FIN082CFA	FIN4232FE	FIN4225OF		

652.108	656.105	644.104	660.104	956.109		
FIN652FP	FIN714JP	FIN405NO	FIN450E	FIN102DV		

652.108	656.105	644.104	660.104	956.109		
FIN652FP	FIN714JP	FIN405NO	FIN450E	FIN102DV		

652.108	656.105	644.104	660.104	956.109		
FIN652FP	FIN714JP	FIN405NO	FIN450E	FIN102DV		

652.108	656.105	644.104	660.104	956.109		
FIN652FP	FIN714JP	FIN405NO	FIN450E	FIN102DV		

Ricambi non originali per motori. Denominazioni e codici originali, sono riportati a puro titolo di riferimento.



54 - 16







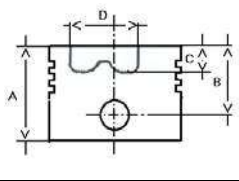

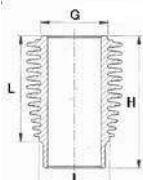
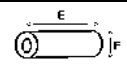
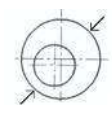
rel. 1511

Non original engine parts. OEMs names and part numbers are for reference purpose only.

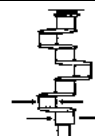
ACME

ADX 740	Cm³	CILINDRI CYLINDERS	ALESAGGIO BORE	CORSA STROKE	VERSIONE VERSION
	740	2	82	70	

		TESTA HEAD	A		3	2	TIPO TYPE	A			
			B		40	10		2		G	
			C		11	22		4		H	
			D		42			I			
			E		67,5			L			
			FIN200PN			F		22			
854.012											
	82	B0100	FIN107PC00	B0104	FIN004RS00	203.130	FIN491SL00				
	82,5	B0101	FIN107PC05	B0105	FIN004RS05						
	83	B0102	FIN107PC10	B0106	FIN004RS10						

		Nr.						ADATTABILE A: SUITABLE FOR:	
---	---	------------	---	---	---	---	---	--------------------------------	---

CR	AL	2	40,00	43,67	22,00		STD - 025 - 050 - 075 - 100	316.134	FIN111CR STD
----	----	---	-------	-------	-------	--	-----------------------------	---------	--------------

MB	RP	1	40,00	44,02	28,00		STD - 025 - 050 - BAR	310.104	FIN104MB STD
----	----	---	-------	-------	-------	--	-----------------------	---------	--------------





MB	RP	1	40,00	44,02	34,50		STD - 025 - 050 - BAR	310.105	FIN105MB STD
----	----	---	-------	-------	-------	--	-----------------------	---------	--------------



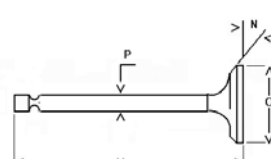

MB	AL	1	40,00	43,67	22,00		STD - 025 - 050 - 075 - 100	316.134	FIN111CR STD
----	----	---	-------	-------	-------	--	-----------------------------	---------	--------------

PB	BM	2	22,00	24,02	27,00		SEMIF.	316.110	FIN112PB
----	----	---	-------	-------	-------	--	--------	---------	----------

--	--	--	--	--	--	--	--	--	--

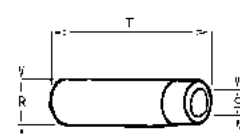
--	--	--	--	--	--	--	--	--	--

	IN EX		Nr.	O	P	M	N		ADATTABILE A: SUITABLE FOR:								
	IN								FS	2	32	7	87,5	45	A1	960.118	FINA149
	EX								FN	2	27	7	87,5	45	A1	960.119	FINS150

	IN EX		Nr.	R	S	T		ADATTABILE A: SUITABLE FOR:								
	IN							G	2					B0038	FIN014AA	
	IN															
	EX							G	2						B0039	FIN015SA
EX																

Ricambi non originali per motori. Denominazioni e codici originali, sono riportati a puro titolo di riferimento.

55 - 16

rel. 1511

Non original engine parts. OEMs names and part numbers are for reference purpose only.

ACME

ADX 740	Cm³	CILINDRI CYLINDERS	ALESAGGIO BORE	CORSA STROKE	VERSIONE VERSION
	740	2	82	70	

	B0109		054.016	054.130				
FIN630CGA	FIN630CGB		FIN3215RT	FIN527RT				

 	ADATTABILE A: SUITABLE FOR:		Nr.	ENGINE KIT	ELECTRIC KIT
	449.174	FIN726HG	1		
			1		
			1		





387.168		359.144	359.151	175.020	175.005		
FIN2320AF		FIN1226NF	FIN082CFA	FIN4232FE	FIN4225OF		





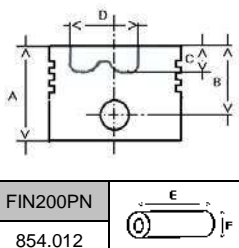

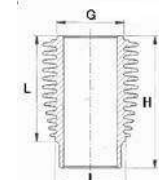
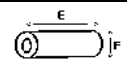

652.108	656.105		644.104	660.104	956.109		
FIN652FP	FIN714JP		FIN405NO	FIN450E	FIN102DV		

Ricambi non originali per motori. Denominazioni e codici originali, sono riportati a puro titolo di riferimento.

ACME

ADX 742	Cm³	CILINDRI CYLINDERS	ALESAGGIO BORE	CORSA STROKE	VERSIONE VERSION
	740	2	82	70	

		TESTA HEAD			3	2	TIPO TYPE	A		
		A			10	2				
		B	40		22	4			G	
		C	11						H	
		D	42						I	
		E	67,5						L	
FIN200PN		F	22							
854.012										
	82	B0100	FIN107PC00	B0104	FIN004RS00	203.130	FIN491SL00			
	82,5	B0101	FIN107PC05	B0105	FIN004RS05					
	83	B0102	FIN107PC10	B0106	FIN004RS10					

		Nr.						ADATTABILE A: SUITABLE FOR:	
---	---	------------	---	---	---	---	---	--------------------------------	---

CR	AL	2	40,00	43,67	22,00		STD - 025 - 050 - 075 - 100	316.134	FIN111CR STD
----	----	---	-------	-------	-------	--	-----------------------------	---------	--------------

MB	RP	1	40,00	44,02	28,00		STD - 025 - 050 - BAR	310.104	FIN104MB STD
----	----	---	-------	-------	-------	--	-----------------------	---------	--------------





MB	RP	1	40,00	44,02	34,50		STD - 025 - 050 - BAR	310.105	FIN105MB STD
----	----	---	-------	-------	-------	--	-----------------------	---------	--------------



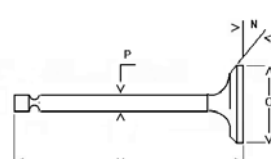

MB	AL	1	40,00	43,67	22,00		STD - 025 - 050 - 075 - 100	316.134	FIN111CR STD
----	----	---	-------	-------	-------	--	-----------------------------	---------	--------------

PB	BM	2	22,00	24,02	27,00		SEMIF.	316.110	FIN112PB
----	----	---	-------	-------	-------	--	--------	---------	----------

--	--	--	--	--	--	--	--	--	--

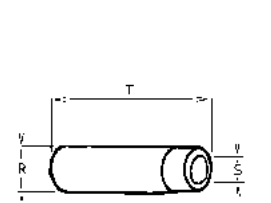
--	--	--	--	--	--	--	--	--	--

	IN EX		Nr.	O	P	M	N		ADATTABILE A: SUITABLE FOR:			
	IN		FS	2	32	7	87,5		45	A1	960.118	FINA149
	EX		FN	2	27	7	87,5		45	A1	960.119	FINS150

	IN EX		Nr.	R	S	T		ADATTABILE A: SUITABLE FOR:			
	IN		G	2					B0038	FIN014AA	
	IN										
	EX		G	2						B0039	FIN015SA
EX											

Ricambi non originali per motori. Denominazioni e codici originali, sono riportati a puro titolo di riferimento.

57 - 16

rel. 1511

Non original engine parts. OEMs names and part numbers are for reference purpose only.

ACME

ADX 742	Cm³	CILINDRI CYLINDERS	ALESAGGIO BORE	CORSA STROKE	VERSIONE VERSION
	740	2	82	70	

	B0109		054.016	054.130				
FIN630CGA	FIN630CGB		FIN3215RT	FIN527RT				

 	ADATTABILE A: SUITABLE FOR:		Nr.	ENGINE KIT	ELECTRIC KIT
	449.174	FIN726HG	1		
			1		
			1		

387.168		359.144	359.151	391.012	175.005		
FIN2320AF		FIN1226NF	FIN082CFA	FIN4227FE	FIN4225OF		

652.108	656.105		644.104	660.104	956.109		
FIN652FP	FIN714JP		FIN405NO	FIN450E	FIN102DV		

Ricambi non originali per motori. Denominazioni e codici originali, sono riportati a puro titolo di riferimento.



58 - 16







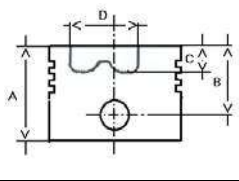

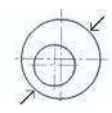
rel. 1511

Non original engine parts. OEMs names and part numbers are for reference purpose only.

ACME

VT 88 W	Cm³	CILINDRI CYLINDERS	ALESAGGIO BORE	CORSA STROKE	VERSIONE VERSION
		1	88		

		TESTA HEAD			3	2,5	TIPO TYPE	
		A			10	2,5		
		B	32		18	4		G
		C			18	4		H
		D						I
	FIN612PN	E	65					L
	854.103	F	20					
	88	A2402	FIN112PC00	A2398	FIN006RS00			
	88,5	A2403	FIN112PC05	A2399	FIN006RS05			
	89	A2404	FIN112PC10	A2400	FIN006RS10			

		Nr.						ADATTABILE A: SUITABLE FOR:	
---	---	------------	---	---	---	---	---	--------------------------------	---

CR		1	GABBIA A RULLI - NEEDLE BEARING				304.111	FIN6411GR
----	--	---	---------------------------------	--	--	--	---------	-----------

MB		1	CUSCINETTO A SFERA - BALL BEARING				304.046	FIN6026BR
----	--	---	-----------------------------------	--	--	--	---------	-----------





MB		1	CUSCINETTO A SFERA - BALL BEARING				304.101	FIN7026BR
----	--	---	-----------------------------------	--	--	--	---------	-----------



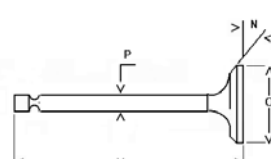

--	--	--	--	--	--	--	--	--

PB	BR	1				SEMIF.	316.102	FIN102PB
----	----	---	--	--	--	--------	---------	----------

--	--	--	--	--	--	--	--	--

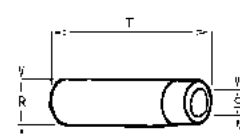
--	--	--	--	--	--	--	--	--

	IN EX		Nr.	O	P	M	N		ADATTABILE A: SUITABLE FOR:			
	IN		FN	1	38	9	114		45	A1	960.104	FINA102
	EX		FN	1	34	9	114		45	A1	960.105	FINS103

	IN EX		Nr.	R	S	T		ADATTABILE A: SUITABLE FOR:				
	IN		G	1	15,05	9,05		55	L	464.109	FIN307AA	
	IN											
	EX		B	1	15,05	9,05		55	L	464.107	FIN308SA	
EX												

Ricambi non originali per motori. Denominazioni e codici originali, sono riportati a puro titolo di riferimento.

59 - 16
rel. 1511

Non original engine parts. OEMs names and part numbers are for reference purpose only.

ACME

VT 88 W	Cm³	CILINDRI CYLINDERS	ALESAGGIO BORE	CORSA STROKE	VERSIONE VERSION
		1	88		

	A2337		054.027	054.016				
FIN4003CGA	FIN4003CGB		FIN526RT	FIN3215RT				

 	ADATTABILE A: SUITABLE FOR:		Nr.	ENGINE KIT	ELECTRIC KIT
	449.143	FIN788HG	1		
			1		
			1		

387.142							
FIN2340AF							

Ricambi non originali per motori. Denominazioni e codici originali, sono riportati a puro titolo di riferimento.



60 - 16







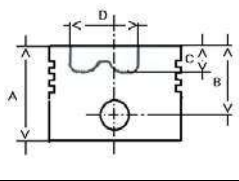
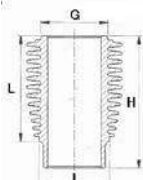
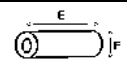

rel. 1511

Non original engine parts. OEMs names and part numbers are for reference purpose only.

ACME

AL 480	Cm³	CILINDRI CYLINDERS	ALESAGGIO BORE	CORSA STROKE	VERSIONE VERSION
	480	1	88	79	U.T.

		TESTA HEAD	A	3	2,5	TIPO TYPE		G
			B					
	FIN612PN	E	65		18	4	I	L
	854.103	F	20					
	88	A2402	FIN112PC00	A2398	FIN006RS00			
	88,5	A2403	FIN112PC05	A2399	FIN006RS05			
	89	A2404	FIN112PC10	A2400	FIN006RS10			

		Nr.							ADATTABILE A: SUITABLE FOR:	
---	---	------------	---	---	---	---	---	--	--------------------------------	---

CR		1	GABBIA A RULLI - NEEDLE BEARING					304.111	FIN6411GR
----	--	---	---------------------------------	--	--	--	--	---------	-----------

MB		1	CUSCINETTO A SFERA - BALL BEARING					304.046	FIN6026BR
----	--	---	-----------------------------------	--	--	--	--	---------	-----------





MB		1	CUSCINETTO A SFERA - BALL BEARING					304.101	FIN7026BR
----	--	---	-----------------------------------	--	--	--	--	---------	-----------



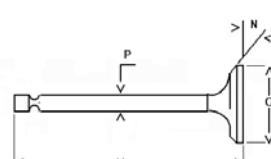

--	--	--	--	--	--	--	--	--	--

PB	BR	1					SEMIF.	316.102	FIN102PB
----	----	---	--	--	--	--	--------	---------	----------

--	--	--	--	--	--	--	--	--	--

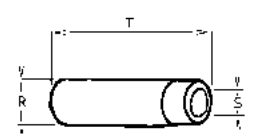
--	--	--	--	--	--	--	--	--	--

	IN EX		Nr.	O	P	M	N		ADATTABILE A: SUITABLE FOR:								
	IN								FS	1	40	8	114	45	A1	960.103	FINA100
	EX								FN	1	36	8	114	45	A1	960.102	FINS101

	IN EX		Nr.	R	S	T		ADATTABILE A: SUITABLE FOR:								
	IN							G	1	13,05	8,05	46,5	F	464.104	FIN301ASA	
	IN															
	EX							G	1	13,05	8,05	46,5	F	464.104	FIN301ASA	
EX																

Ricambi non originali per motori. Denominazioni e codici originali, sono riportati a puro titolo di riferimento.

61 - 16

rel. 1511

Non original engine parts. OEMs names and part numbers are for reference purpose only.

ACME

AL 480	Cm³	CILINDRI CYLINDERS	ALESAGGIO BORE	CORSA STROKE	VERSIONE VERSION
	480	1	88	79	U.T.

	A2336		054.027	054.016				
FIN4002CGA	FIN4002CGB		FIN526RT	FIN3215RT				

 	ADATTABILE A: SUITABLE FOR:		Nr.	ENGINE KIT	ELECTRIC KIT
	449.148	FIN789HG	1		
			1		
			1		

387.142							
FIN2340AF							

Ricambi non originali per motori. Denominazioni e codici originali, sono riportati a puro titolo di riferimento.

ALTRI ARTICOLI

OTHERS ITEMS

POS.	ARTICOLO	ITEM	MOTORE ENGINE	CODICE FINIMPIANTI FINIMPIANTI REF.	ADATTABILE A SUITABLE FOR:
1	Filtro aria	<i>Air cleaner</i>	ALN 290W , ALN 330W	FIN2316AF	359.121
2	Filtro combustibile	<i>Fuel filter element</i>	ADN 37W , ADN 43 ADN 43W , ADN 45 ADN 45W , ADN 48 ADN 48W , ADN 54 ADN 54W , ADN 60 ADN 60W	FIN4232FE	175.020
3	Filtro combustibile	<i>Fuel filter element</i>	ADX 300 , ADX 370 ADX 600 , ADX 740	FIN4260FE	175.102
4	Anello asta bilanciere	<i>Guard tube seal</i>	ADN 37 , ADN 37W ADN 60 , ADN 60W AD 108 , AD 110 AD 114 , AD 114/A AD 112 , AD 116	FIN082AP	579.010
5	Cappuccio Valvola	<i>Valve cap</i>	ADN 37 , ADN 37W ADN 60 , ADN 60W	FIN119CV	054.139
6	Kit paraolio	<i>Seal kit</i>	VT 88 W , AL 480	FIN3589RTS (FIN526RT + FIN3215RT)	A2335
7	Kit paraolio	<i>Seal kit</i>	ALN 290 W , ALN 330 W	FIN3589RTS (FIN526RT + FIN3215RT)	2289
8	Kit paraolio	<i>Seal kit</i>	ADX 300 , ADX 370	FIN3590RTS (FIN3215RT + FIN527RT)	B0005
9	Kit paraolio	<i>Seal kit</i>	AD 108 , AD 110 AD 114 / A , AD 114 AD 112 , AD 116 ADN 37 , ADN 37 W ADN 43 , ADN 43 W ADN 45 , ADN 45 W ADN 48 , ADN 48 W ADN 54 , ADN 54 W ADN 60 , ADN 60 W	FIN3217RTS (FIN3216RT + FIN3215RT)	A2155
10	Serie segmenti 3 2 10 2 22 4	<i>Rings set</i> 3 2 10 2 22 4	VT 88 W , AL 480	FIN4752RS00 FIN4752RS05 FIN4752RS10	
11	Serie guarnizioni motore con anelli di tenuta	<i>Gasket set with seal rings</i>	AL 480	FIN4007CGA	
12	Serie guarnizioni motore senza anelli di tenuta	<i>Gasket set without seal rings</i>	AL 480	FIN4007CGB	
13	Guarnizione testa	<i>Head gasket</i>	AL 480	FIN790HG	
14					
15					
16					

ALTRI ARTICOLI

OTHERS ITEMS

POS.	ARTICOLO	<i>ITEM</i>	MOTORE <i>ENGINE</i>	CODICE FINIMPIANTI <i>FINIMPIANTI REF.</i>	ADATTABILE A <i>SUITABLE FOR:</i>
17					
18					
19					
20					
21					
22					
23					
24					
25					
26					
27					
28					
29					
30					
31					
32					
33					
34					
35					
36					

SERIE MC – RF RUGGERINI MC – RF SERIES	
1	MC 70
3	MC 71
5	RF 80
7	RF 81
9	RF 88
11	RF 90
13	RF 91
15	RF 100
17	RF 120
19	RF 121
21	RF 130
23	RF 140
25	RF 148
27	ALTRI ARTICOLI <i>OTHERS ITEMS</i>

Questo catalogo contiene dati ed informazioni provenienti dalla pluriennale esperienza di Finimpianti. Tuttavia non possiamo assumere alcuna responsabilità per eventuali dati errati od incompleti.

Tutti i dati e le informazioni contenute nel presente catalogo sono fornite a puro scopo informativo e senza responsabilità e non potranno dare adito ad alcuna forma di risarcimento.

Visto il continuo sviluppo dei nostri prodotti, Finimpianti si riserva il diritto di apportare modifiche senza preavviso.

Denominazioni, numeri e codici originali sono riportati a puro titolo di riferimento.

All the information and data contained in this catalogue came from the long Finimpianti experience. Nevertheless we can not assume any responsibility for possible mistakes.



All the information and data contained in this catalogue are provide "as is" without any representation or warranty express or implied. Under no circumstances whatsoever shall Finimpianti be liable for any damages whatsoever arising out of the use of the information and data contained in this catalogue.







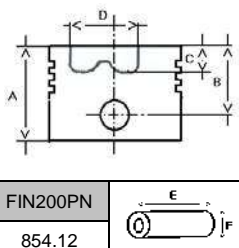

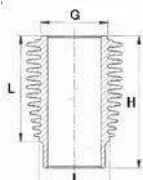
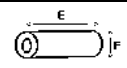
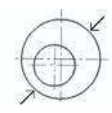
Finimpianti does not warrant the accuracy or completeness of the materials and content contained in this catalogue and reserves the right to correct any errors or omissions at any time without notice and without obligation to the users of this catalogue.

OEM names, codes and part numbers, used in this catalogue, are for reference only.

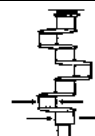
RUGGERINI

MC 70	Cm³	CILINDRI CYLINDERS	ALESAGGIO BORE	CORSA STROKE	VERSIONE VERSION
	377	1	80	75	

		TESTA HEAD	H08		3	2,5	TIPO TYPE	A		
		A	75		10	2,5			G	105
		B	40		23	4			H	133,90
		C	12						I	98
		D	40,5						L	79,90
		E	67,5							
FIN200PN										
854.12										
	80	A2077	FIN190PC00	2340	FIN067RS00		203.19	FIN025SL00		
	80,5	A2078	FIN190PC05	2341	FIN067RS05					
	81	A2079	FIN190PC10	2342	FIN067RS10					

		Nr.						ADATTABILE A: SUITABLE FOR:	
---	---	------------	---	---	---	---	---	--------------------------------	---

CR	AL	1	40,05	43,66	24,38		STD - 025 - 050 - 075 - 100	A2639	FIN043CR STD
----	----	---	-------	-------	-------	--	-----------------------------	-------	--------------

MB	ALL	2	42,09	50,03	40,20		STD - 025 - 050 - 075 - 100 - BAR - BAR EM1	310.16	FIN016MB STD
----	-----	---	-------	-------	-------	--	---	--------	--------------





--	--	--	--	--	--	--	--	--	--



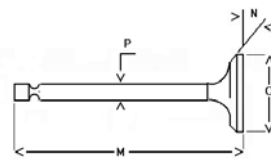

--	--	--	--	--	--	--	--	--	--

--	--	--	--	--	--	--	--	--	--

--	--	--	--	--	--	--	--	--	--

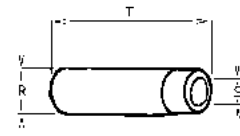
--	--	--	--	--	--	--	--	--	--

	IN EX		Nr.	O	P	M	N		ADATTABILE A: SUITABLE FOR:			
	IN		FS	1	33	7	95		45	A1	960.49	FINA027
	EX		FN	1	30	7	95		45	A1	960.50	FINS028

	IN EX		Nr.	R	S	T		ADATTABILE A: SUITABLE FOR:			
	IN		G	1	13,05	7,03		39	I	464.77	FIN208ASA
	IN		G		13,15	7,03		39	I	464.59	FIN208ASB
	EX		G	1	13,05	7,03		39	I	464.77	FIN208ASA
	EX		G		13,15	7,03		39	I	464.59	FIN208ASB

Ricambi non originali per motori. Denominazioni e codici originali, sono riportati a puro titolo di riferimento.

RUGGERINI

MC 70	Cm³	CILINDRI CYLINDERS	ALESAGGIO BORE	CORSA STROKE	VERSIONE VERSION
	377	1	80	75	

	2329	2856			447.76	447.79	448.14	448.14
FIN105CGA	FIN105CGB	FIN079SM	FIN3216RT	FIN3215RT	FIN206CO	FIN281CB	FIN503IG	FIN503IG

 ADATTABILE A: SUITABLE FOR:		Nr.	ENGINE KIT	ELECTRIC KIT
	449.83	1	 FIN025SL00	
		1	 FIN190PC00	
		1	 FIN079SM	
		A2391	FIN0850KIT	

388.36	060.06	359.30		175.32	175.05		
FIN2210AF	FIN5012PF	FIN1030NF		FIN020FE	FIN4225OF		

100.36	2912			2122			
FIN1060KR	FIN080CK			FIN022OP			

	656.41	644.51	644.52	660.20	956.51		
	FIN701JP	FIN503NH	FIN051NO	FIN059E	FIN098DV		





696.78							
FIN038PU	FIN003CN						





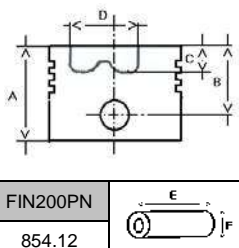

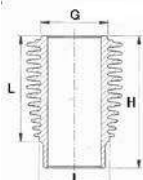

			527.44				
			FIN112SI				

Ricambi non originali per motori. Denominazioni e codici originali, sono riportati a puro titolo di riferimento.

RUGGERINI

MC 71	Cm³	CILINDRI CYLINDERS	ALESAGGIO BORE	CORSA STROKE	VERSIONE VERSION
	377	1	80	75	

		TESTA HEAD	H08		3	2,5	TIPO TYPE	A		
		A	75		10	2,5			G	105
		B	40		23	4			H	133,90
		C	12						I	98
		D	40,5						L	79,90
		E	67,5						203.19	
F	22									
	80	A2077	FIN190PC00	2340	FIN067RS00					
	80,5	A2078	FIN190PC05	2341	FIN067RS05					
	81	A2079	FIN190PC10	2342	FIN067RS10					

		Nr.						ADATTABILE A: SUITABLE FOR:	
---	---	------------	---	---	---	---	---	--------------------------------	---

CR	AL	1	40,05	43,66	24,38		STD - 025 - 050 - 075 - 100	A2639	FIN043CR STD
----	----	---	-------	-------	-------	--	-----------------------------	-------	--------------

MB	ALL	2	42,09	50,03	40,20		STD - 025 - 050 - 075 - 100 - BAR - BAR EM1	310.16	FIN016MB STD
----	-----	---	-------	-------	-------	--	---	--------	--------------





--	--	--	--	--	--	--	--	--	--



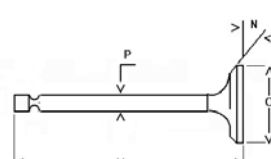

--	--	--	--	--	--	--	--	--	--

--	--	--	--	--	--	--	--	--	--

--	--	--	--	--	--	--	--	--	--

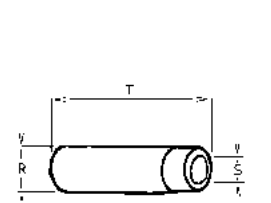
--	--	--	--	--	--	--	--	--	--

	IN EX		Nr.	O	P	M	N		ADATTABILE A: SUITABLE FOR:			
	IN		FS	1	33	7	95		45	A1	960.49	FINA027
	EX		FN	1	30	7	95		45	A1	960.50	FINS028

	IN EX		Nr.	R	S	T		ADATTABILE A: SUITABLE FOR:			
	IN		G	1	13,05	7,03		39	I	464.77	FIN208ASA
	IN		G		13,15	7,03		39	I	464.59	FIN208ASB
	EX		G	1	13,05	7,03		39	I	464.77	FIN208ASA
EX	G		13,15	7,03	39	I	464.59	FIN208ASB			

Ricambi non originali per motori. Denominazioni e codici originali, sono riportati a puro titolo di riferimento.

RUGGERINI

MC 71	Cm³	CILINDRI CYLINDERS	ALESAGGIO BORE	CORSA STROKE	VERSIONE VERSION
	377	1	80	75	

	2329	2856			447.76	447.79	448.14	448.14
FIN105CGA	FIN105CGB	FIN079SM	FIN3216RT	FIN3215RT	FIN206CO	FIN281CB	FIN503IG	FIN503IG

 	ADATTABILE A: SUITABLE FOR:		Nr.	ENGINE KIT	ELECTRIC KIT
	449.83	FIN6240HG	1	 FIN025SL00	
			1	 FIN190PC00	
			1	 FIN079SM	
			A2391	FIN0850KIT	

388.36	060.06	359.30		175.32	175.05		
FIN2210AF	FIN5012PF	FIN1030NF		FIN020FE	FIN4225OF		

100.36	2912			2122			
FIN1060KR	FIN080CK			FIN022OP			

	656.41	644.51	644.52	660.20	956.51		
	FIN701JP	FIN503NH	FIN051NO	FIN059E	FIN098DV		

696.78							
FIN038PU	FIN003CN						

			527.44				
			FIN112SI				

Ricambi non originali per motori. Denominazioni e codici originali, sono riportati a puro titolo di riferimento.

4 - 17

rel. 1511

Non original engine parts. OEMs names and part numbers are for reference purpose only.

RUGGERINI

RF 80	Cm³	CILINDRI CYLINDERS	ALESAGGIO BORE	CORSA STROKE	VERSIONE VERSION
	377	1	80	75	

		TESTA HEAD	H08			TIPO TYPE	A		
		A	75					G	105
		B	40					H	133,90
		C	12					I	98
		D	40,5					L	79,90
		E	67,5					203.19	
854.12	F	22							
	80	A2077	FIN190PC00	2340	FIN067RS00				
	80,5	A2078	FIN190PC05	2341	FIN067RS05				
	81	A2079	FIN190PC10	2342	FIN067RS10				

		Nr.							ADATTABILE A: SUITABLE FOR:	
--	--	------------	--	--	--	--	--	--	--------------------------------	--

CR	AL	1	40,05	43,66	24,38			STD - 025 - 050 - 075 - 100	A2639	FIN043CR STD
----	----	---	-------	-------	-------	--	--	-----------------------------	-------	--------------

MB	RP	2	42,09	50,03	26,00			STD - 025 - 050	311.01	FIN001MB STD
----	----	---	-------	-------	-------	--	--	-----------------	--------	--------------

MB	ALL	2	42,09	50,03	40,20			STD - 025 - 050 - 075 - 100 - BAR - BAR EM1	310.16	FIN016MB STD
----	-----	---	-------	-------	-------	--	--	---	--------	--------------

<div style="border: 1px solid black; padding: 5px; display: inline-block;"> SOLUZIONE ALTERNATIVA FIN016MB = FIN001MB + FIN002TW ALTERNATIVE SOLUTION </div>										

TW	AL	1	50,00	63,00	3,00			STD	060.39	FIN002TW STD
----	----	---	-------	-------	------	--	--	-----	--------	--------------

--	--	--	--	--	--	--	--	--	--	--

	IN EX		Nr.	O	P	M	N		ADATTABILE A: SUITABLE FOR:			
	IN		FS	1	33	7	95		45	A1	960.49	FINA027
	EX		FN	1	30	7	95		45	A1	960.50	FINS028

	IN EX		Nr.	R	S	T		ADATTABILE A: SUITABLE FOR:			
	IN		G	1	13,05	7,03		39	I	464.77	FIN208ASA
	IN		G		13,15	7,03		39	I	464.59	FIN208ASB
	EX		G	1	13,05	7,03		39	I	464.77	FIN208ASA
	EX	G		13,15	7,03	39	I	464.59	FIN208ASB		

Ricambi non originali per motori. Denominazioni e codici originali, sono riportati a puro titolo di riferimento.

RUGGERINI

RF 80	Cm³	CILINDRI CYLINDERS	ALESAGGIO BORE	CORSA STROKE	VERSIONE VERSION
	377	1	80	75	

	2329	2856			447.76	447.79	448.14	448.14
FIN105CGA	FIN105CGB	FIN079SM	FIN3216RT	FIN3215RT	FIN206CO	FIN281CB	FIN503IG	FIN503IG

 	ADATTABILE A: SUITABLE FOR:		Nr.	ENGINE KIT	ELECTRIC KIT
	449.83	FIN6240HG	1	 FIN025SL00	
			1	 FIN190PC00	
			1	 FIN079SM	
			A2391		

388.40	060.06	359.30	060.13	175.32	175.05		894.21
FIN290AF	FIN5012PF	FIN1030NF	FIN600CFA	FIN020FE	FIN4225OF		FIN023SF

100.36	2912			A2417			
FIN1060KR	FIN080CK			FIN028OP			

	656.41	644.38	644.37	660.20	956.51		
	FIN701JP	FIN502NH	FIN051NO	FIN059E	FIN098DV		

696.32							
FIN032PU	FIN003CN						

014.09	730.13	563.50	527.44				
FIN323VA	FIN238VR	FIN142TL	FIN112SI				

Ricambi non originali per motori. Denominazioni e codici originali, sono riportati a puro titolo di riferimento.



6 - 17







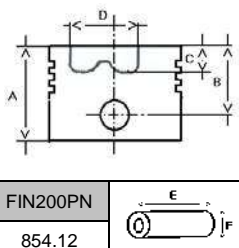

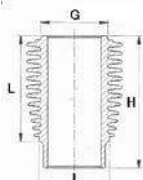
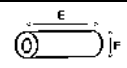
rel. 1511

Non original engine parts. OEMs names and part numbers are for reference purpose only.

RUGGERINI

RF 81	Cm³	CILINDRI CYLINDERS	ALESAGGIO BORE	CORSA STROKE	VERSIONE VERSION
	377	1	80	75	

		TESTA HEAD	H08			TIPO TYPE A
		A 75 B 40 C 12 D 40,5 E 67,5 F 22	3 2,5 10 2,5 23 4			
FIN200PN 854.12		80 A2077 80,5 A2078 81 A2079	FIN190PC00 FIN190PC05 FIN190PC10	2340 2341 2342	FIN067RS00 FIN067RS05 FIN067RS10	203.19 FIN025SL00

		Nr.						ADATTABILE A: SUITABLE FOR:	
---	---	------------	---	---	---	---	---	--------------------------------	---

CR	AL	1	40,05	43,66	24,38		STD - 025 - 050 - 075 - 100	A2639	FIN043CR STD
----	----	---	-------	-------	-------	--	-----------------------------	-------	--------------





MB	RP	2	42,09	50,03	26,00		STD - 025 - 050	311.01	FIN001MB STD
----	----	---	-------	-------	-------	--	-----------------	--------	--------------



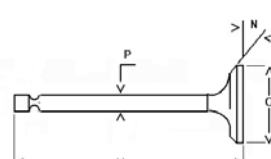

MB	ALL	2	42,09	50,03	40,20		STD - 025 - 050 - 075 - 100 - BAR - BAR EM1	310.16	FIN016MB STD
----	-----	---	-------	-------	-------	--	---	--------	--------------

SOLUZIONE ALTERNATIVA FIN016MB = FIN001MB + FIN002TW ALTERNATIVE SOLUTION									

TW	AL	1	50,00	63,00	3,00		STD	060.39	FIN002TW STD
----	----	---	-------	-------	------	--	-----	--------	--------------

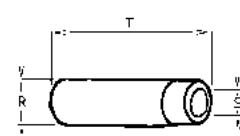
--	--	--	--	--	--	--	--	--	--

	IN EX		Nr.	O	P	M	N		ADATTABILE A: SUITABLE FOR:			
	IN		FS	1	33	7	95		45	A1	960.49	FINA027
	EX		FN	1	30	7	95		45	A1	960.50	FINS028

	IN EX		Nr.	R	S	T		ADATTABILE A: SUITABLE FOR:			
	IN		G	1	13,05	7,03		39	I	464.77	FIN208ASA
	IN		G		13,15	7,03		39	I	464.59	FIN208ASB
	EX		G	1	13,05	7,03		39	I	464.77	FIN208ASA
EX	G		13,15	7,03	39	I	464.59	FIN208ASB			

Ricambi non originali per motori. Denominazioni e codici originali, sono riportati a puro titolo di riferimento.

7 - 17

rel. 1511

Non original engine parts. OEMs names and part numbers are for reference purpose only.

RUGGERINI

RF 81	Cm³	CILINDRI CYLINDERS	ALESAGGIO BORE	CORSA STROKE	VERSIONE VERSION
	377	1	80	75	

	2329	2856			447.76	447.79	448.14	448.14
FIN105CGA	FIN105CGB	FIN079SM	FIN3216RT	FIN3215RT	FIN206CO	FIN281CB	FIN503IG	FIN503IG

 	ADATTABILE A: SUITABLE FOR:		Nr.	ENGINE KIT	ELECTRIC KIT
	449.83	FIN6240HG	1	 FIN025SL00	
			1	 FIN190PC00	
			1	 FIN079SM	
			A2391	FIN0850KIT	

388.40	060.06	359.30	060.13	175.32	175.05		894.21
FIN290AF	FIN5012PF	FIN1030NF	FIN600CFA	FIN020FE	FIN4225OF		FIN023SF

100.36	2912			A2417			
FIN1060KR	FIN080CK			FIN028OP			

	656.41	644.38	644.37	660.20	956.51		
	FIN701JP	FIN502NH	FIN051NO	FIN059E	FIN098DV		





696.32							
FIN032PU	FIN003CN						





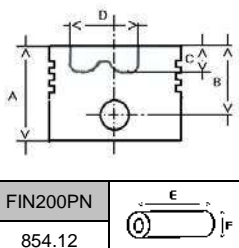

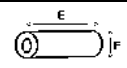
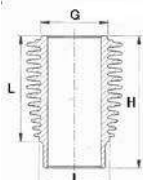

014.09	730.13	563.50	527.44				
FIN323VA	FIN238VR	FIN142TL	FIN112SI				

Ricambi non originali per motori. Denominazioni e codici originali, sono riportati a puro titolo di riferimento.

RUGGERINI

RF 88	Cm³	CILINDRI CYLINDERS	ALESAGGIO BORE	CORSA STROKE	VERSIONE VERSION
	377	1	80	75	

		TESTA HEAD	H08		3	2,5	TIPO TYPE	A	
		A	75		10	2,5			
		B	40		23	4			
		C	12						
		D	40,5						
		E	67,5						
FIN200PN		F	22					G	105
854.12						H		133,90	
								I	98
	80	A2077	FIN190PC00	2340	FIN067RS00	203.19		L	79,90
	80,5	A2078	FIN190PC05	2341	FIN067RS05			FIN025SL00	
	81	A2079	FIN190PC10	2342	FIN067RS10				

		Nr.						ADATTABILE A: SUITABLE FOR:	
---	---	------------	---	---	---	---	---	--------------------------------	---

CR	AL	1	40,05	43,66	24,38		STD - 025 - 050 - 075 - 100	A2639	FIN043CR STD
----	----	---	-------	-------	-------	--	-----------------------------	-------	--------------

MB	ALL	2	42,09	50,03	40,20		STD - 025 - 050 - 075 - 100 - BAR - BAR EM1	310.16	FIN016MB STD
----	-----	---	-------	-------	-------	--	---	--------	--------------





--	--	--	--	--	--	--	--	--	--



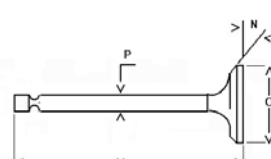

--	--	--	--	--	--	--	--	--	--

--	--	--	--	--	--	--	--	--	--

--	--	--	--	--	--	--	--	--	--

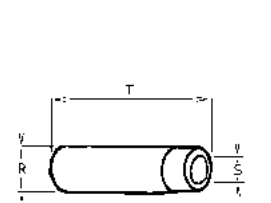
--	--	--	--	--	--	--	--	--	--

	IN EX		Nr.	O	P	M	N		ADATTABILE A: SUITABLE FOR:				
	IN		FS	1	33	7	95		45		A1	960.49	FINA027
	EX		FN	1	30	7	95		45		A1	960.50	FINS028

	IN EX		Nr.	R	S	T		ADATTABILE A: SUITABLE FOR:				
	IN		G	1	13,05	7,03		39		I	464.77	FIN208ASA
	IN		G		13,15	7,03		39		I	464.59	FIN208ASB
	EX		G	1	13,05	7,03		39		I	464.77	FIN208ASA
	EX	G		13,15	7,03	39	I	464.59	FIN208ASB			

Ricambi non originali per motori. Denominazioni e codici originali, sono riportati a puro titolo di riferimento.

RUGGERINI

RF 88	Cm³	CILINDRI CYLINDERS	ALESAGGIO BORE	CORSA STROKE	VERSIONE VERSION
	377	1	80	75	

	2329	2856			447.76	447.79	448.14	448.14
FIN105CGA	FIN105CGB	FIN079SM	FIN3216RT	FIN3215RT	FIN206CO	FIN281CB	FIN503IG	FIN503IG

 	ADATTABILE A: SUITABLE FOR:		Nr.	ENGINE KIT	ELECTRIC KIT
	449.83	FIN6240HG	1	 FIN025SL00	
			1	 FIN190PC00	
			1	 FIN079SM	
			A2391	FIN0850KIT	

388.40	060.06	359.30	060.13	175.23	175.05		
FIN290AF	FIN5012PF	FIN1030NF	FIN600CFA	FIN4231FE	FIN4225OF		

100.36	2912			2122			
FIN1060KR	FIN080CK			FIN022OP			

	656.41	644.51	644.37	660.20	956.51		
	FIN701JP	FIN503NH	FIN051NO	FIN059E	FIN098DV		

696.78							
FIN038PU	FIN003CN						

			526.66				
			FIN113SI				

Ricambi non originali per motori. Denominazioni e codici originali, sono riportati a puro titolo di riferimento.

10 - 17
rel. 1511

Non original engine parts. OEMs names and part numbers are for reference purpose only.

RUGGERINI

RF 90	Cm³	CILINDRI CYLINDERS	ALESAGGIO BORE	CORSA STROKE	VERSIONE VERSION
	477	1	90	75	

		TESTA HEAD H13 A 80 B 40 C 14,7 D 40,3 E 64 F 22		3 2	TIPO TYPE A
				10 2	
	FIN201PN 854.17			23 4	
	90 A2153 90,5 A2154 91 A2155			FIN197PC00 FIN197PC05 FIN197PC10	

		Nr.							ADATTABILE A: SUITABLE FOR:	
--	--	------------	--	--	--	--	--	--	--------------------------------	--

CR	AL	1	40,05	43,66	24,38			STD - 025 - 050 - 075 - 100	A2639	FIN043CR STD
----	----	---	-------	-------	-------	--	--	-----------------------------	-------	--------------

MB	RP	2	42,09	50,03	26,00			STD - 025 - 050	311.01	FIN001MB STD
----	----	---	-------	-------	-------	--	--	-----------------	--------	--------------

MB	ALL	2	42,09	50,03	40,20			STD - 025 - 050 - 075 - 100 - BAR - BAR EM1	310.16	FIN016MB STD
----	-----	---	-------	-------	-------	--	--	---	--------	--------------

SOLUZIONE ALTERNATIVA FIN016MB = FIN001MB + FIN002TW ALTERNATIVE SOLUTION										

TW	AL	1	50,00	63,00	3,00			STD	060.39	FIN002TW STD
----	----	---	-------	-------	------	--	--	-----	--------	--------------

--	--	--	--	--	--	--	--	--	--	--

	IN EX		Nr.	O	P	M	N		ADATTABILE A: SUITABLE FOR:								
	IN								FS	1	39	7	95	45	A1	960.56	FINA160
	EX								FN	1	36	7	95	45	A1	960.55	FINS161

	IN EX		Nr.	R	S	T		ADATTABILE A: SUITABLE FOR:							
	IN							G	1	13,05	7,03	39	I	464.77	FIN208ASA
	IN							G		13,15	7,03	39	I	464.59	FIN208ASB
	EX							G	1	13,05	7,03	39	I	464.77	FIN208ASA
EX	G		13,15	7,03	39	I	464.59	FIN208ASB							

Ricambi non originali per motori. Denominazioni e codici originali, sono riportati a puro titolo di riferimento.

RUGGERINI

RF 90	Cm³	CILINDRI CYLINDERS	ALESAGGIO BORE	CORSA STROKE	VERSIONE VERSION
	477	1	90	75	

	2140	2394			447.76	447.79	448.14	448.14
FIN110CGA	FIN110CGB	FIN084SM	FIN3216RT	FIN3215RT	FIN206CO	FIN281CB	FIN503IG	FIN503IG

 	ADATTABILE A: SUITABLE FOR:		Nr.	ENGINE KIT	ELECTRIC KIT
	448.08	FIN6241HG	1	 FIN029SL00	
			1	 FIN197PC00	
			1	 FIN084SM	
			A2392		

388.29	059.90	359.26	060.48	175.32	175.05		894.21
FIN290AF	FIN090PF	FIN821NF	FIN840CFA	FIN020FE	FIN4225OF		FIN023SF

100.36	2912			A2417			
FIN1060KR	FIN080CK			FIN028OP			

	656.41	644.38	644.37	660.20	956.51		
	FIN701JP	FIN502NH	FIN051NO	FIN059E	FIN098DV		

696.78							
FIN038PU	FIN003CN						

014.09	730.13	563.50	527.44				
FIN323VA	FIN238VR	FIN142TL	FIN112SI				

Ricambi non originali per motori. Denominazioni e codici originali, sono riportati a puro titolo di riferimento.







12 - 17



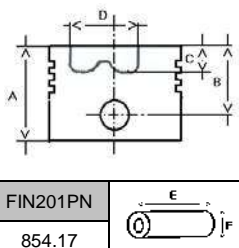

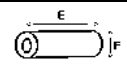

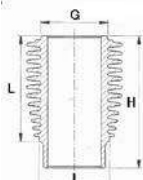

rel. 1511

Non original engine parts. OEMs names and part numbers are for reference purpose only.

RUGGERINI

RF 91	Cm³	CILINDRI CYLINDERS	ALESAGGIO BORE	CORSA STROKE	VERSIONE VERSION
	477	1	90	75	

		TESTA HEAD	H13		3	2	TIPO TYPE	A	
		A	80		10	2			
FIN201PN 854.17		E	64		23	4		G	105
		F	22			A2157		FIN072RS00	H
90	A2153	FIN197PC00	A2158	FIN072RS05		I	98	203.71	L
90,5	A2154	FIN197PC05	A2159	FIN072RS10	L	79,90	FIN029SL00		
91	A2155	FIN197PC10							

		Nr.						ADATTABILE A: SUITABLE FOR:	
--	---	------------	---	---	---	---	---	--------------------------------	---

CR	AL	1	40,05	43,66	24,38		STD - 025 - 050 - 075 - 100	A2639	FIN043CR STD
----	----	---	-------	-------	-------	--	-----------------------------	-------	--------------





MB	RP	2	42,09	50,03	26,00		STD - 025 - 050	311.01	FIN001MB STD
----	----	---	-------	-------	-------	--	-----------------	--------	--------------



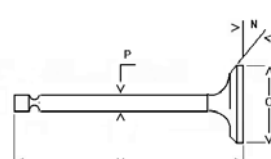

MB	ALL	2	42,09	50,03	40,20		STD - 025 - 050 - 075 - 100 - BAR - BAR EM1	310.16	FIN016MB STD
----	-----	---	-------	-------	-------	--	---	--------	--------------

SOLUZIONE ALTERNATIVA FIN016MB = FIN001MB + FIN002TW ALTERNATIVE SOLUTION									

TW	AL	1	50,00	63,00	3,00		STD	060.39	FIN002TW STD
----	----	---	-------	-------	------	--	-----	--------	--------------

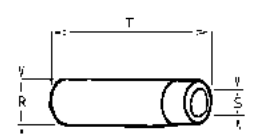
--	--	--	--	--	--	--	--	--	--

	IN EX		Nr.	O	P	M	N		ADATTABILE A: SUITABLE FOR:			
	IN		FS	1	39	7	95		45	A1	960.56	FINA160
	EX		FN	1	36	7	95		45	A1	960.55	FINS161

	IN EX		Nr.	R	S	T		ADATTABILE A: SUITABLE FOR:			
	IN		G	1	13,05	7,03		39	I	464.77	FIN208ASA
	IN		G		13,15	7,03		39	I	464.59	FIN208ASB
	EX		G	1	13,05	7,03		39	I	464.77	FIN208ASA
EX	G		13,15	7,03	39	I	464.59	FIN208ASB			

Ricambi non originali per motori. Denominazioni e codici originali, sono riportati a puro titolo di riferimento.

13 - 17
rel. 1511

Non original engine parts. OEMs names and part numbers are for reference purpose only.

RUGGERINI

RF 91	Cm³	CILINDRI CYLINDERS	ALESAGGIO BORE	CORSA STROKE	VERSIONE VERSION
	477	1	90	75	

	2140	2394			447.76	447.79	448.14	448.14
FIN110CGA	FIN110CGB	FIN084SM	FIN3216RT	FIN3215RT	FIN206CO	FIN281CB	FIN503IG	FIN503IG

	ADATTABILE A: SUITABLE FOR:		Nr.	ENGINE KIT	ELECTRIC KIT
	448.08	FIN6241HG	1	FIN029SL00	
			1	FIN197PC00	
			1	FIN084SM	
			A2392	FIN0910KIT	

388.29	059.90	359.26	060.48	175.32	175.05		894.21
FIN290AF	FIN090PF	FIN821NF	FIN840CFA	FIN020FE	FIN4225OF		FIN023SF

100.36	2912			A2417			
FIN1060KR	FIN080CK			FIN028OP			

	656.41	644.38	644.37	660.20	956.51		
	FIN701JP	FIN502NH	FIN051NO	FIN059E	FIN098DV		

696.78							
FIN038PU	FIN003CN						

014.09	730.13	563.50	527.44				
FIN323VA	FIN238VR	FIN142TL	FIN112SI				



Ricambi non originali per motori. Denominazioni e codici originali, sono riportati a puro titolo di riferimento.







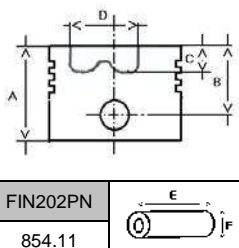

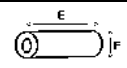
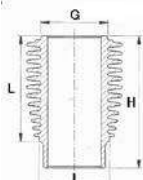
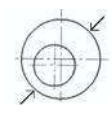
14 - 17
rel. 1511

Non original engine parts. OEMs names and part numbers are for reference purpose only.

RUGGERINI

RF 100	Cm³	CILINDRI CYLINDERS	ALESAGGIO BORE	CORSA STROKE	VERSIONE VERSION
		1	85		

		TESTA HEAD	H43		3	2,5	TIPO TYPE	A	
		A	88		10	2,5			
FIN202PN 854.11		B	50		10	2,5		G	105
		C	12		22	5		H	165,5
		D	44				203.10	I	98
		E	74		2135	FIN069RS00		L	122,4
		F	25		2136	FIN069RS05		FIN489SL00	
		85	2130	FIN192PC00	2137	FIN069RS10			
		85,5	2131	FIN192PC05					
		86	2132	FIN192PC10					

		Nr.						ADATTABILE A: SUITABLE FOR:	
--	---	------------	---	---	---	---	---	--------------------------------	---

CR	AL	1	45,00	48,01	24,12		STD - 025 - 050 - 075 - 100 - BAR	316.36	FIN036CR STD
----	----	---	-------	-------	-------	--	-----------------------------------	--------	--------------

MB	ALL	2	42,09	50,03	40,20		STD - 025 - 050 - 075 - 100 - BAR - BAR EM1	310.16	FIN016MB STD
----	-----	---	-------	-------	-------	--	---	--------	--------------





--	--	--	--	--	--	--	--	--	--



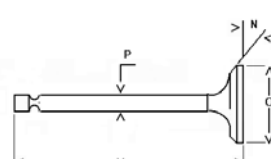

--	--	--	--	--	--	--	--	--	--

PB	BM	1	25,02	28,02	27,50		SEMIF.	316.41	FIN141PB
----	----	---	-------	-------	-------	--	--------	--------	----------

--	--	--	--	--	--	--	--	--	--

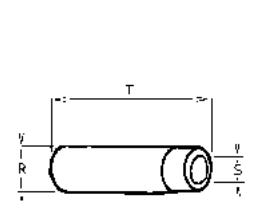
--	--	--	--	--	--	--	--	--	--

	IN EX		Nr.	O	P	M	N		ADATTABILE A: SUITABLE FOR:			
	IN		FS	1	35	9	105		45	E1	960.16	FINA116
	EX		FN	1	35	9	105		45	A1	960.15	FINS117

	IN EX		Nr.	R	S	T		ADATTABILE A: SUITABLE FOR:			
	IN		G	1	15,03	9,04		45	L	464.39	FIN203AA
	IN		G		15,13	9,04		45	L	464.25	FIN203AB
	EX		G	1	15,03	9,04		45	L	464.40	FIN204SA
				15,13	9,04	45	L	464.35	FIN204SB		

Ricambi non originali per motori. Denominazioni e codici originali, sono riportati a puro titolo di riferimento.

15 - 17
rel. 1511

Non original engine parts. OEMs names and part numbers are for reference purpose only.

RUGGERINI

RF 100	Cm³	CILINDRI CYLINDERS	ALESAGGIO BORE	CORSA STROKE	VERSIONE VERSION
		1	85		

	2119	2393			447.76	447.79	448.14	448.14
FIN108CGA	FIN108CGB	FIN082SM	FIN3216RT	FIN3215RT	FIN206CO	FIN281CB	FIN503IG	FIN503IG

 ADATTABILE A: SUITABLE FOR:		Nr. ENGINE KIT	ELECTRIC KIT 				
	447.78			FIN6380HG	1		FIN489SL00
					1		FIN192PC00
					1		FIN082SM
			FIN0902KIT				

387.92	059.73	359.24		175.23	175.05		
FIN2212AF	FIN5014PF	FIN1035NF		FIN4231FE	FIN4225OF		

100.23	2955			2122			
FIN1065KR	FIN085CK			FIN022OP			

	656.42	644.32	644.34	660.17	956.05		
	FIN702JP	FIN504NH	FIN098NO	FIN011E	FIN016DV		

696.54							
FIN052PU	FIN003CN						

			526.66				
			FIN113SI				

Ricambi non originali per motori. Denominazioni e codici originali, sono riportati a puro titolo di riferimento.

RUGGERINI

RF 120	Cm³	CILINDRI CYLINDERS	ALESAGGIO BORE	CORSA STROKE	VERSIONE VERSION
	540	1	90	85	

		TESTA HEAD	H29		3	2	TIPO TYPE	A	
		A	85		10	2			
		B	50		23	4			
		C	17						
		D	42						
		E	74						
FIN202PN		F	25	A2157	FIN072RS00		G	105	
854.11				A2158	FIN072RS05		H	165,6	
				A2159	FIN072RS10		I	98	
					L		122,4		
	90	A2099	FIN196PC00			203.12		FIN028SL00	
	90,5	A2100	FIN196PC05						
	91	A2101	FIN196PC10						

		Nr.						ADATTABILE A: SUITABLE FOR:	
--	--	------------	--	--	--	--	--	--------------------------------	--

CR	AL	1	45,00	48,00	24,12		STD - 025 - 050 - 075 - 100	316.70	FIN2260CR STD
----	----	---	-------	-------	-------	--	-----------------------------	--------	---------------

MB	RP	2	42,09	50,03	26,00		STD - 025 - 050	311.01	FIN001MB STD
----	----	---	-------	-------	-------	--	-----------------	--------	--------------

MB	ALL	2	42,09	50,03	40,20		STD - 025 - 050 - 075 - 100 - BAR - BAR EM1	310.16	FIN016MB STD
----	-----	---	-------	-------	-------	--	---	--------	--------------

SOLUZIONE ALTERNATIVA FIN016MB = FIN001MB + FIN002TW ALTERNATIVE SOLUTION									
--	--	--	--	--	--	--	--	--	--

PB	BM	1	25,02	28,02	27,50		SEMIF.	316.41	FIN141PB
----	----	---	-------	-------	-------	--	--------	--------	----------

TW	AL	1	50,00	63,00	3,00		STD	060.39	FIN002TW STD
----	----	---	-------	-------	------	--	-----	--------	--------------

--	--	--	--	--	--	--	--	--	--

	IN EX		Nr.	O	P	M	N		ADATTABILE A: SUITABLE FOR:			
	IN		FS	1	39	7	95		45	A1	960.56	FINA160
	EX		FN	1	36	7	95		45	A1	960.55	FINS161

	IN EX		Nr.	R	S	T		ADATTABILE A: SUITABLE FOR:			
	IN		G	1	13,05	7,03		39	I	464.77	FIN208ASA
	IN		G		13,15	7,03		39	I	464.59	FIN208ASB
	EX		G	1	13,05	7,03		39	I	464.77	FIN208ASA
	EX	G		13,15	7,03	39	I	464.59	FIN208ASB		

Ricambi non originali per motori. Denominazioni e codici originali, sono riportati a puro titolo di riferimento.

17 - 17

rel. 1511

Non original engine parts. OEMs names and part numbers are for reference purpose only.

RUGGERINI

RF 120	Cm³	CILINDRI CYLINDERS	ALESAGGIO BORE	CORSA STROKE	VERSIONE VERSION
	540	1	90	85	

	2140	2394			447.76	447.79	448.14	448.14
FIN110CGA	FIN110CGB	FIN084SM	FIN3216RT	FIN3215RT	FIN206CO	FIN281CB	FIN503IG	FIN503IG

 	ADATTABILE A: SUITABLE FOR:		Nr.	ENGINE KIT	ELECTRIC KIT
	448.08	FIN6241HG	1	 FIN028SL00	
			1	 FIN196PC00	
			1	 FIN084SM	
			A2394	FIN0927KIT	

388.29	059.90	359.26	060.48	175.23	175.05		894.21
FIN290AF	FIN090PF	FIN821NF	FIN840CFA	FIN4231FE	FIN4225OF		FIN023SF

100.23	2955			A2417			
FIN1065KR	FIN085CK			FIN028OP			

	656.42	644.38	644.37	660.17	956.27		
	FIN702JP	FIN502NH	FIN051NO	FIN011E	FIN016DV		

696.54							
FIN052PU	FIN003CN						

014.09	730.13	563.50	527.44				
FIN323VA	FIN238VR	FIN142TL	FIN112SI				

Ricambi non originali per motori. Denominazioni e codici originali, sono riportati a puro titolo di riferimento.

18 - 17
rel. 1511

Non original engine parts. OEMs names and part numbers are for reference purpose only.

RUGGERINI

RF 121	Cm³	CILINDRI CYLINDERS	ALESAGGIO BORE	CORSA STROKE	VERSIONE VERSION
	540	1	90	85	

		TESTA HEAD	A	85			TIPO TYPE	A	
			B	50				G	105
			C	17				H	165,6
			D	42				I	98
			E	74				L	122,4
			F	25				203.12	
	90	A2099	FIN196PC00		A2157	FIN072RS00			
	90,5	A2100	FIN196PC05			A2158	FIN072RS05		
	91	A2101	FIN196PC10			A2159	FIN072RS10		

		Nr.							ADATTABILE A: SUITABLE FOR:	
--	--	------------	--	--	--	--	--	--	--------------------------------	--

CR	AL	1	45,00	48,00	24,12		STD - 025 - 050 - 075 - 100	316.70	FIN2260CR STD
----	----	---	-------	-------	-------	--	-----------------------------	--------	---------------

MB	RP	2	42,09	50,03	26,00		STD - 025 - 050	311.01	FIN001MB STD
----	----	---	-------	-------	-------	--	-----------------	--------	--------------

MB	ALL	2	42,09	50,03	40,20		STD - 025 - 050 - 075 - 100 - BAR - BAR EM1	310.16	FIN016MB STD
----	-----	---	-------	-------	-------	--	---	--------	--------------

SOLUZIONE ALTERNATIVA FIN016MB = FIN001MB + FIN002TW ALTERNATIVE SOLUTION									
--	--	--	--	--	--	--	--	--	--

PB	BM	1	25,02	28,02	27,50		SEMIF.	316.41	FIN141PB
----	----	---	-------	-------	-------	--	--------	--------	----------

TW	AL	1	50,00	63,00	3,00		STD	060.39	FIN002TW STD
----	----	---	-------	-------	------	--	-----	--------	--------------

--	--	--	--	--	--	--	--	--	--

	IN EX		Nr.	O	P	M	N		ADATTABILE A: SUITABLE FOR:								
	IN								FS	1	39	7	95	45	A1	960.56	FINA160
	EX								FN	1	36	7	95	45	A1	960.55	FINS161

	IN EX		Nr.	R	S	T		ADATTABILE A: SUITABLE FOR:							
	IN							G	1	13,05	7,03	39	I	464.77	FIN208ASA
	IN							G		13,15	7,03	39	I	464.59	FIN208ASB
	EX							G	1	13,05	7,03	39	I	464.77	FIN208ASA
	EX							G		13,15	7,03	39	I	464.59	FIN208ASB

Ricambi non originali per motori. Denominazioni e codici originali, sono riportati a puro titolo di riferimento.

19 - 17
rel. 1511

Non original engine parts. OEMs names and part numbers are for reference purpose only.

RUGGERINI

RF 121	Cm³	CILINDRI CYLINDERS	ALESAGGIO BORE	CORSA STROKE	VERSIONE VERSION
	540	1	90	85	

	2140	2394			447.76	447.79	448.14	448.14
FIN110CGA	FIN110CGB	FIN084SM	FIN3216RT	FIN3215RT	FIN206CO	FIN281CB	FIN503IG	FIN503IG

 	ADATTABILE A: SUITABLE FOR:		Nr.	ENGINE KIT	ELECTRIC KIT
	448.08	FIN6241HG	1	 FIN028SL00	
			1	 FIN196PC00	
			1	 FIN084SM	
			A2394	FIN0927KIT	

388.29	059.90	359.26	060.48	175.23	175.05		894.21
FIN290AF	FIN090PF	FIN821NF	FIN840CFA	FIN4231FE	FIN4225OF		FIN023SF

100.23	2955			A2417			
FIN1065KR	FIN085CK			FIN028OP			

	656.42	644.38	644.37	660.17	956.27		
	FIN702JP	FIN502NH	FIN051NO	FIN011E	FIN016DV		

696.54							
FIN052PU	FIN003CN						

014.09	730.13	563.50	527.44				
FIN323VA	FIN238VR	FIN142TL	FIN112SI				

Ricambi non originali per motori. Denominazioni e codici originali, sono riportati a puro titolo di riferimento.

20 - 17
rel. 1511

Non original engine parts. OEMs names and part numbers are for reference purpose only.

RUGGERINI

RF 130	Cm³	CILINDRI CYLINDERS	ALESAGGIO BORE	CORSA STROKE	VERSIONE VERSION
		1	92	85	

		TESTA HEAD	A	50	3	2,5	TIPO TYPE	A	
			B	16,7		10		2,5	G
		E	74	22	5		H	165,6	
		F	25					I	98
92	A2103	FIN200PC00	2274	FIN074RS00	203.13		L	122,4	
92,5	A2104	FIN200PC05	2275	FIN074RS05			FIN031SL00		
93	A2105	FIN200PC10	2276	FIN074RS10					

		Nr.						ADATTABILE A: SUITABLE FOR:	
--	--	------------	--	--	--	--	--	--------------------------------	--

CR	AL	1	45,00	48,01	24,12		STD - 025 - 050 - 075 - 100 - BAR	316.36	FIN036CR STD
----	----	---	-------	-------	-------	--	--------------------------------------	--------	--------------

MB	ALL	2	42,09	50,03	40,20		STD - 025 - 050 - 075 - 100 - BAR - BAR EM1	310.16	FIN016MB STD
----	-----	---	-------	-------	-------	--	---	--------	--------------

--	--	--	--	--	--	--	--	--	--

--	--	--	--	--	--	--	--	--	--

PB	BM	1	25,02	28,02	27,50		SEMIF.	316.41	FIN141PB
----	----	---	-------	-------	-------	--	--------	--------	----------

--	--	--	--	--	--	--	--	--	--

--	--	--	--	--	--	--	--	--	--

	IN EX		Nr.	O	P	M	N		ADATTABILE A: SUITABLE FOR:								
	IN								FS	1	39	7	95	45	A1	960.56	FINA160
	EX								FN	1	36	7	95	45	A1	960.55	FINS161

	IN EX		Nr.	R	S	T		ADATTABILE A: SUITABLE FOR:							
	IN							G	1	13,05	7,03	39	I	464.77	FIN208ASA
	IN							G		13,15	7,03	39	I	464.59	FIN208ASB
	EX							G	1	13,05	7,03	39	I	464.77	FIN208ASA
EX	G		13,15	7,03	39	I	464.59	FIN208ASB							

Ricambi non originali per motori. Denominazioni e codici originali, sono riportati a puro titolo di riferimento.

RUGGERINI

RF 130	Cm³	CILINDRI CYLINDERS	ALESAGGIO BORE	CORSA STROKE	VERSIONE VERSION
		1	92	85	

	2140	2394			447.76	447.79	448.14	448.14
FIN110CGA	FIN110CGB	FIN084SM	FIN3216RT	FIN3215RT	FIN206CO	FIN281CB	FIN503IG	FIN503IG

 	ADATTABILE A: SUITABLE FOR:		Nr.	ENGINE KIT	ELECTRIC KIT
	448.08	FIN6241HG	1	 FIN031SL00	
			1	 FIN200PC00	
			1	 FIN084SM	
				FIN3246KIT	

388.40	060.06	359.30	060.13	175.23	175.05		
FIN290AF	FIN090PF	FIN1030NF	FIN600CFA	FIN4231FE	FIN4225OF		

100.23				2122			
FIN1065KR				FIN022OP			

	656.42	644.38	644.37	660.17	956.27		
	FIN702JP	FIN502NH	FIN051NO	FIN011E	FIN016DV		

696.54							
FIN052PU	FIN003CN						

			526.66				
			FIN113SI				

Ricambi non originali per motori. Denominazioni e codici originali, sono riportati a puro titolo di riferimento.

22 - 17
rel. 1511

Non original engine parts. OEMs names and part numbers are for reference purpose only.

RUGGERINI

RF 140	Cm³	CILINDRI CYLINDERS	ALESAGGIO BORE	CORSA STROKE	VERSIONE VERSION
	602	1	95	85	

		TESTA HEAD	H13			TIPO TYPE	A		
		A	95					G	105
		B	50					H	165,6
		C	16,8					I	100
		D	41,6					L	122,4
		E	74					203.42	
FIN202PN		F	25	2495	FIN076RS00				
854.11		95	A2107	FIN203PC00	2496	FIN076RS05			
		95,5	A2108	FIN203PC05	2497	FIN076RS10			
		96	A2109	FIN203PC10					

		Nr.							ADATTABILE A: SUITABLE FOR:	
--	--	------------	--	--	--	--	--	--	--------------------------------	--

CR	AL	1	45,00	48,00	24,12		STD - 025 - 050 - 075 - 100	316.70	FIN2260CR STD
----	----	---	-------	-------	-------	--	-----------------------------	--------	---------------

MB	RP	2	42,09	50,03	26,00		STD - 025 - 050	311.01	FIN001MB STD
----	----	---	-------	-------	-------	--	-----------------	--------	--------------

MB	ALL	2	42,09	50,03	40,20		STD - 025 - 050 - 075 - 100 - BAR - BAR EM1	310.16	FIN016MB STD
----	-----	---	-------	-------	-------	--	---	--------	--------------

SOLUZIONE ALTERNATIVA FIN016MB = FIN001MB + FIN002TW ALTERNATIVE SOLUTION									
--	--	--	--	--	--	--	--	--	--

PB	BM	1	25,02	28,02	27,50		SEMIF.	316.41	FIN141PB
----	----	---	-------	-------	-------	--	--------	--------	----------

TW	AL	1	50,00	63,00	3,00		STD	060.39	FIN002TW STD
----	----	---	-------	-------	------	--	-----	--------	--------------

--	--	--	--	--	--	--	--	--	--

	IN EX		Nr.	O	P	M	N		ADATTABILE A: SUITABLE FOR:								
	IN								FS	1	39	7	95	45	A1	960.56	FINA160
	EX								FN	1	36	7	95	45	A1	960.55	FINS161

	IN EX		Nr.	R	S	T		ADATTABILE A: SUITABLE FOR:							
	IN							G	1	13,05	7,03	39	I	464.77	FIN208ASA
	IN							G		13,15	7,03	39	I	464.59	FIN208ASB
	EX							G	1	13,05	7,03	39	I	464.77	FIN208ASA
EX	G		13,15	7,03	39	I	464.59	FIN208ASB							

Ricambi non originali per motori. Denominazioni e codici originali, sono riportati a puro titolo di riferimento.

23 - 17
rel. 1511

Non original engine parts. OEMs names and part numbers are for reference purpose only.

RUGGERINI

RF 140	Cm³	CILINDRI CYLINDERS	ALESAGGIO BORE	CORSA STROKE	VERSIONE VERSION
	602	1	95	85	

	2482	2483			447.76	447.79	448.14	448.14
FIN115CGA	FIN115CGB	FIN089SM	FIN3216RT	FIN3215RT	FIN206CO	FIN281CB	FIN503IG	FIN503IG

 	ADATTABILE A: SUITABLE FOR:		Nr.	ENGINE KIT	ELECTRIC KIT
	449.52	FIN625HG	1	 FIN033SL00	
			1	 FIN203PC00	
			1	 FIN089SM	
			A2403	FIN0951KIT	

388.29	059.90	359.26	060.48	175.23	175.05		894.21
FIN290AF	FIN5013PF	FIN821NF	FIN840CFA	FIN4231FE	FIN4225OF		FIN023SF

100.23				A2417			
FIN1065KR				FIN028OP			

	656.42	644.38	644.37	660.17	956.27		
	FIN702JP	FIN502NH	FIN051NO	FIN011E	FIN016DV		

696.54							
FIN052PU	FIN003CN						

014.09	730.13	563.50	526.66				
FIN323VA	FIN238VR	FIN142TL	FIN113SI				





Ricambi non originali per motori. Denominazioni e codici originali, sono riportati a puro titolo di riferimento.





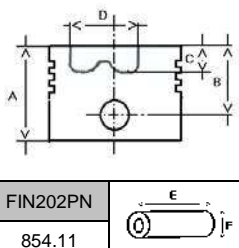

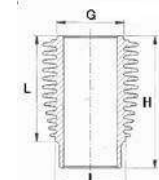
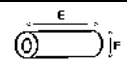

24 - 17
rel. 1511

Non original engine parts. OEMs names and part numbers are for reference purpose only.

RUGGERINI

RF 148	Cm³	CILINDRI CYLINDERS	ALESAGGIO BORE	CORSA STROKE	VERSIONE VERSION
	602	1	95	85	

		TESTA HEAD	H13		3	2,5	TIPO TYPE	A	
		A	95		10	2,5			G
FIN202PN		B	50	10	2,5	H	165,6		
854.11		C	16,8	21	5,5	I	100		
		D	41,6			L	122,4		
		E	74						
		F	25						
	95	A2107	FIN203PC00	2495	FIN076RS00	203.42	FIN033SL00		
	95,5	A2108	FIN203PC05	2496	FIN076RS05				
	96	A2109	FIN203PC10	2497	FIN076RS10				

		Nr.						ADATTABILE A: SUITABLE FOR:	
--	---	------------	---	---	---	---	---	--------------------------------	---

CR	AL	1	45,00	48,01	24,12		STD - 025 - 050 - 075 - 100 - BAR	316.36	FIN036CR STD
----	----	---	-------	-------	-------	--	-----------------------------------	--------	--------------

MB	ALL	2	42,09	50,03	40,20		STD - 025 - 050 - 075 - 100 - BAR - BAR EM1	310.16	FIN016MB STD
----	-----	---	-------	-------	-------	--	---	--------	--------------





--	--	--	--	--	--	--	--	--	--



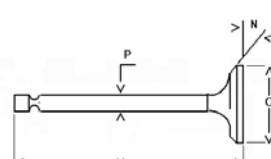

--	--	--	--	--	--	--	--	--	--

PB	BM	1	25,02	28,02	27,50		SEMIF.	316.41	FIN141PB
----	----	---	-------	-------	-------	--	--------	--------	----------

--	--	--	--	--	--	--	--	--	--

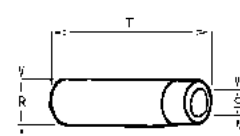
--	--	--	--	--	--	--	--	--	--

	IN EX		Nr.	O	P	M	N		ADATTABILE A: SUITABLE FOR:			
	IN		FS	1	39	7	95		45	A1	960.56	FINA160
	EX		FN	1	36	7	95		45	A1	960.55	FINS161

	IN EX		Nr.	R	S	T		ADATTABILE A: SUITABLE FOR:			
	IN		G	1	13,05	7,03		39	I	464.77	FIN208ASA
	IN		G		13,15	7,03		39	I	464.59	FIN208ASB
	EX		G	1	13,05	7,03		39	I	464.77	FIN208ASA
	EX	G		13,15	7,03	39	I	464.59	FIN208ASB		

Ricambi non originali per motori. Denominazioni e codici originali, sono riportati a puro titolo di riferimento.

25 - 17
rel. 1511

Non original engine parts. OEMs names and part numbers are for reference purpose only.

RUGGERINI

RF 148	Cm³	CILINDRI CYLINDERS	ALESAGGIO BORE	CORSA STROKE	VERSIONE VERSION
	602	1	95	85	

	2482	2483			447.76	447.79	448.14	448.14
FIN115CGA	FIN115CGB	FIN089SM	FIN3216RT	FIN3215RT	FIN206CO	FIN281CB	FIN503IG	FIN503IG

 	ADATTABILE A: SUITABLE FOR:		Nr.	ENGINE KIT	ELECTRIC KIT
	449.52	FIN625HG	1	 FIN033SL00	
			1	 FIN203PC00	
			1	 FIN089SM	
			A2403	FIN0951KIT	

388.40		359.30		175.23	175.05		
FIN290AF		FIN1030NF		FIN4231FE	FIN4225OF		

100.23				2122			
FIN1065KR				FIN022OP			

	656.42	644.51	644.52	660.17	956.27		
	FIN702JP	FIN503NH	FIN051NO	FIN011E	FIN016DV		

696.54							
FIN052PU	FIN003CN						

			526.66				
			FIN113SI				

Ricambi non originali per motori. Denominazioni e codici originali, sono riportati a puro titolo di riferimento.

26 - 17
rel. 1511

Non original engine parts. OEMs names and part numbers are for reference purpose only.

RUGGERINI

MC – RF

ALTRI ARTICOLI

OTHERS ITEMS

POS.	ARTICOLO	ITEM	MOTORE ENGINE	CODICE FINIMPIANTI FINIMPIANTI REF.	ADATTABILE A SUITABLE FOR:
1	Cartuccia filtro combustibile	<i>Fuel filter cartridge</i>	RF 120 , RF 121, RF 140	FIN4226FE	175.28
2	Anello asta bilanciere	<i>Guard tube seal</i>	All models	FIN082AP	579.10
3	Cappuccio Valvola	<i>Valve cap</i>	All models	FIN119CV	451.25
4	Kit anelli di tenuta	<i>Seal rings kit</i>	All models	FIN3217RTS (FIN3215RT + FIN3216RT)	2118
5					
6					
7					
8					
9					
10					
11					
12					
13					
14					
15					
16					
17					
18					
19					
21					
22					

RUGGERINI

MC – RF

ALTRI ARTICOLI

OTHERS ITEMS

POS.	ARTICOLO	ITEM	MOTORE ENGINE	CODICE FINIMPIANTI FINIMPIANTI REF.	ADATTABILE A SUITABLE FOR:
23					
24					
25					
26					
27					
28					
29					
30					
31					
32					
33					
34					
35					
36					
37					
38					
39					
40					
41					

SERIE RD RUGGERINI <i>RD SERIES</i>	
1	RD 80
3	RD 81
5	RD 180
7	RD 181
9	RD 188
11	RD 850
13	RD 901/A
15	RD 200
17	RD 201
19	RD 208
21	RD 900
23	RD 901
25	RD 901/AD
27	RD 210
29	RD 211
31	RD 218
33	RD 220
35	RD 901/2
37	RD 920
39	RD 920 L
41	RD 240
43	RD 248
45	RD 92/2
47	RD 92/2 L
49	RD 950
51	RD 950 L
53	RD 270
55	RD 278
57	RD 952
59	RD 290
61	SP 420
63	ALTRI ARTICOLI <i>OTHERS ITEMS</i>

Questo catalogo contiene dati ed informazioni provenienti dalla pluriennale esperienza di Finimpianti. Tuttavia non possiamo assumere alcuna responsabilità per eventuali dati errati od incompleti.

Tutti i dati e le informazioni contenute nel presente catalogo sono fornite a puro scopo informativo e senza responsabilità e non potranno dare adito ad alcuna forma di risarcimento.

Visto il continuo sviluppo dei nostri prodotti, Finimpianti si riserva il diritto di apportare modifiche senza preavviso.

Denominazioni, numeri e codici originali sono riportati a puro titolo di riferimento.

All the information and data contained in this catalogue came from the long Finimpianti experience. Nevertheless we can not assume any responsibility for possible mistakes.





All the information and data contained in this catalogue are provide "as is" without any representation or warranty express or implied. Under no circumstances whatsoever shall Finimpianti be liable for any damages whatsoever arising out of the use of the information and data contained in this catalogue.





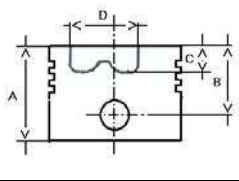

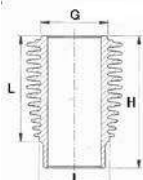

Finimpianti does not warrant the accuracy or completeness of the materials and content contained in this catalogue and reserves the right to correct any errors or omissions at any time without notice and without obligation to the users of this catalogue.

OEM names, codes and part numbers, used in this catalogue, are for reference only.

RUGGERINI

RD 80	Cm³	CILINDRI CYLINDERS	ALESAGGIO BORE	CORSA STROKE	VERSIONE VERSION
	377	1	80	75	

		TESTA HEAD	H27		3	2,5	TIPO TYPE	A	
					10	2,5			
					23	4			
									
					2340	FIN067RS00			
					2341	FIN067RS05			
2342	FIN067RS10	203.19	FIN025SL00						
	80	2336	FIN489PC00	88			G	105	
	80,5	2337	FIN489PC05	40			H	133,9	
	81	2338	FIN489PC10	11,9			I	98	
				40,7			L	79,9	
				67,5					
				22					

		Nr.						ADATTABILE A: SUITABLE FOR:	
---	---	------------	---	---	---	---	---	--------------------------------	---

CR	AL	1	40,05	43,66	24,38		STD - 025 - 050 - 075 - 100	A2639	FIN043CR STD
----	----	---	-------	-------	-------	--	-----------------------------	-------	--------------

MB	ALL	2	42,09	50,03	40,20		STD - 025 - 050 - 075 - 100 - BAR - BAR EM1	310.16	FIN016MB STD
----	-----	---	-------	-------	-------	--	---	--------	--------------





--	--	--	--	--	--	--	--	--	--



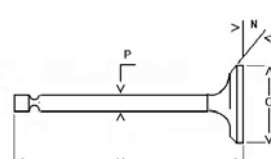

--	--	--	--	--	--	--	--	--	--

--	--	--	--	--	--	--	--	--	--

--	--	--	--	--	--	--	--	--	--

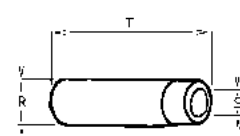
--	--	--	--	--	--	--	--	--	--

	IN EX		Nr.	O	P	M	N		ADATTABILE A: SUITABLE FOR:			
	IN		FS	1	30,5	9	105		45	E1	960.22	FINA106
	EX		FN	1	30,5	9	105		45	A1	960.23	FINS107

	IN EX		Nr.	R	S	T		ADATTABILE A: SUITABLE FOR:			
	IN		G	1	15,03	9,04		45	L	464.39	FIN203AA
	IN		G		15,13	9,04		45	L	464.25	FIN203AB
	EX		G	1	15,03	9,04		45	L	464.40	FIN204SA
	EX		G		15,13	9,04		45	L	464.35	FIN204SB

Ricambi non originali per motori. Denominazioni e codici originali, sono riportati a puro titolo di riferimento.

RUGGERINI

RD 80	Cm³	CILINDRI CYLINDERS	ALESAGGIO BORE	CORSA STROKE	VERSIONE VERSION
	377	1	80	75	

	2329	2856			447.76	447.79	448.14	448.14
FIN105CGA	FIN105CGB	FIN079SM	FIN3216RT	FIN3215RT	FIN206CO	FIN281CB	FIN503IG	FIN503IG

 	ADATTABILE A: SUITABLE FOR:		Nr.	ENGINE KIT	ELECTRIC KIT
	449.83	FIN6240HG	1	 FIN025SL00	
			1	 FIN489PC00	
			1	 FIN079SM	
				FIN0858KIT	

387.39		359.13		175.20	175.05		
FIN2208AF		FIN1033NF		FIN4232FE	FIN4225OF		

100.36				2122			
FIN1060KR				FIN022OP			

	656.23		644.07	660.14	956.05		
	FIN704JP		FIN114NO	FIN6284E	FIN016DV		

696.32		890.02					
FIN032PU	FIN003CN	FIN303ST					

			526.66				
			FIN113SI				

Ricambi non originali per motori. Denominazioni e codici originali, sono riportati a puro titolo di riferimento.





2 - 18





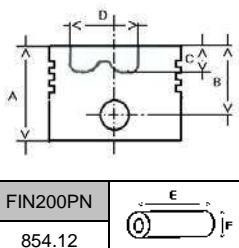

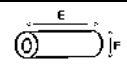
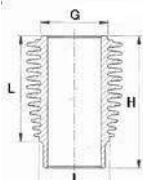

rel. 1511

Non original engine parts. OEMs names and part numbers are for reference purpose only.

RUGGERINI

RD 81	Cm³	CILINDRI CYLINDERS	ALESAGGIO BORE	CORSA STROKE	VERSIONE VERSION
	377	1	80	75	

		TESTA HEAD	H27		3	2,5	TIPO TYPE	A	
		A	88		10	2,5			
		B	40		23	4			
		C	11,9						
		D	40,7						
		E	67,5						
FIN200PN		F	22	2340	FIN067RS00		G	105	
854.12				2341	FIN067RS05		H	133,9	
				2342	FIN067RS10		I	98	
							L	79,9	
		80	2336	FIN489PC00	203.19		FIN025SL00		
		80,5	2337	FIN489PC05					
		81	2338	FIN489PC10					

		Nr.						ADATTABILE A: SUITABLE FOR:	
---	---	------------	---	---	---	---	---	--------------------------------	---

CR	AL	1	40,05	43,66	24,38		STD - 025 - 050 - 075 - 100	A2639	FIN043CR STD
----	----	---	-------	-------	-------	--	-----------------------------	-------	--------------

MB	ALL	2	42,09	50,03	40,20		STD - 025 - 050 - 075 - 100 - BAR - BAR EM1	310.16	FIN016MB STD
----	-----	---	-------	-------	-------	--	---	--------	--------------





--	--	--	--	--	--	--	--	--	--



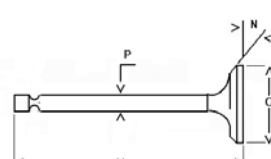

--	--	--	--	--	--	--	--	--	--

--	--	--	--	--	--	--	--	--	--

--	--	--	--	--	--	--	--	--	--

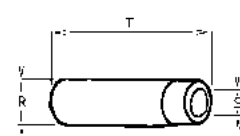
--	--	--	--	--	--	--	--	--	--

	IN EX		Nr.	O	P	M	N		ADATTABILE A: SUITABLE FOR:			
	IN		FS	1	30,5	9	105		45	E1	960.22	FINA106
	EX		FN	1	30,5	9	105		45	A1	960.23	FINS107

	IN EX		Nr.	R	S	T		ADATTABILE A: SUITABLE FOR:			
	IN		G	1	15,03	9,04		45	L	464.39	FIN203AA
	IN		G		15,13	9,04		45	L	464.25	FIN203AB
	EX		G	1	15,03	9,04		45	L	464.40	FIN204SA
EX	G		15,13	9,04	45	L	464.35	FIN204SB			

Ricambi non originali per motori. Denominazioni e codici originali, sono riportati a puro titolo di riferimento.

3 - 18

rel. 1511

Non original engine parts. OEMs names and part numbers are for reference purpose only.

RUGGERINI

RD 81	Cm³	CILINDRI CYLINDERS	ALESAGGIO BORE	CORSA STROKE	VERSIONE VERSION
	377	1	80	75	

	2329	2856			447.76	447.79	448.14	448.14
FIN105CGA	FIN105CGB	FIN079SM	FIN3216RT	FIN3215RT	FIN206CO	FIN281CB	FIN503IG	FIN503IG

 	ADATTABILE A: SUITABLE FOR:		Nr.	ENGINE KIT	ELECTRIC KIT
	449.83	FIN6240HG	1	 FIN025SL00	
			1	 FIN489PC00	
			1	 FIN079SM	
				FIN0858KIT	

387.39		359.13		175.20	175.05		
FIN2208AF		FIN1033NF		FIN4232FE	FIN4225OF		

100.36				2122			
FIN1060KR				FIN022OP			

	656.23		644.07	660.14	956.05		
	FIN704JP		FIN114NO	FIN6284E	FIN016DV		

696.32		890.02					
FIN032PU	FIN003CN	FIN303ST					

			526.66				
			FIN113SI				

Ricambi non originali per motori. Denominazioni e codici originali, sono riportati a puro titolo di riferimento.





4 - 18





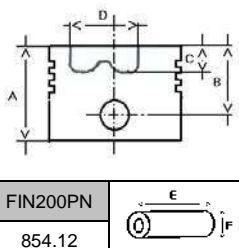

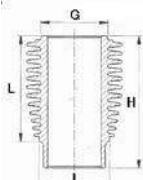
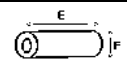

rel. 1511

Non original engine parts. OEMs names and part numbers are for reference purpose only.

RUGGERINI

RD 180	Cm³	CILINDRI CYLINDERS	ALESAGGIO BORE	CORSA STROKE	VERSIONE VERSION
	754	2	80	75	

		TESTA HEAD	H08		3	2,5	TIPO TYPE	A		
		A	75		10	2,5			G	114
		B	40		23	4			H	135,2
		C	12,5						I	98
		D	40,7						L	89,2
		E	67,5							
FIN200PN	854.12		F	22						
	80	A2012	FIN488PC00	2340	FIN067RS00	203.52	FIN488SL00			
	80,5	A2013	FIN488PC05	2341	FIN067RS05					
	81	A2014	FIN488PC10	2342	FIN067RS10					

		Nr.						ADATTABILE A: SUITABLE FOR:	
---	---	------------	---	---	---	---	---	--------------------------------	---

CR	AL	2	45,00	48,01	24,12		STD - 025 - 050 - 075 - 100 - BAR	316.36	FIN036CR STD
----	----	---	-------	-------	-------	--	--------------------------------------	--------	--------------

MB	AL	3	45,00	47,98	24,12		STD - 025 - 050 - 075 - 100 - BAR	310.31	FIN031MB STD
----	----	---	-------	-------	-------	--	--------------------------------------	--------	--------------





--	--	--	--	--	--	--	--	--	--



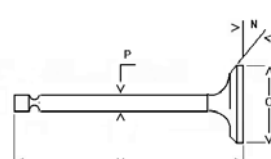

--	--	--	--	--	--	--	--	--	--

--	--	--	--	--	--	--	--	--	--

--	--	--	--	--	--	--	--	--	--

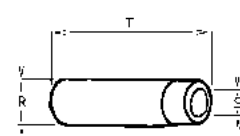
--	--	--	--	--	--	--	--	--	--

	IN EX		Nr.	O	P	M	N		ADATTABILE A: SUITABLE FOR:			
	IN		FS	2	33	7	95		45	A1	960.49	FINA027
	EX		FN	2	30	7	95		45	A1	960.50	FINS028

	IN EX		Nr.	R	S	T		ADATTABILE A: SUITABLE FOR:			
	IN		G	2	13,05	7,03		39	I	464.47	FIN208ASA
	IN		G		13,15	7,03		39	I	464.48	FIN208ASB
	EX		G	2	13,05	7,03		39	I	464.47	FIN208ASA
	EX		G		13,15	7,03		39	I	464.48	FIN208ASB

Ricambi non originali per motori. Denominazioni e codici originali, sono riportati a puro titolo di riferimento.

5 - 18

rel. 1511

Non original engine parts. OEMs names and part numbers are for reference purpose only.

RUGGERINI

RD 180	Cm³	CILINDRI CYLINDERS	ALESAGGIO BORE	CORSA STROKE	VERSIONE VERSION
	754	2	80	75	

	2932	2931			448.86	448.53	448.14	450.13
FIN4451CGA	FIN4451CGB	FIN5241SM	FIN3218RT	FIN3218RT	FIN221CO	FIN704CB	FIN503IG	FIN504EG

 ADATTABILE A: SUITABLE FOR:	 FIN6352HG	Nr.	ENGINE KIT	ELECTRIC KIT
		1	 FIN488SL00	
		1	 FIN488PC00	
		1	 FIN5250SM	
			FIN2035KIT	

388.54		359.26		175.23	175.24		
FIN458AF		FIN821NF		FIN4231FE	FIN102OF		

				2321			
				FIN480OP			

652.12	656.28	644.27	644.28	660.16	956.51		
FIN681FP	FIN221JP	FIN522NH	FIN051NO	FIN059E	FIN351DV		

	FIN003CN						

014.41	730.34	5840.142					
FIN140VA	FIN298VR	FIN142TL					

Ricambi non originali per motori. Denominazioni e codici originali, sono riportati a puro titolo di riferimento.



6 - 18







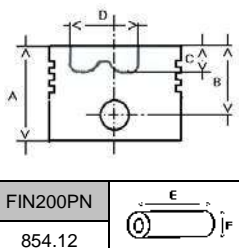

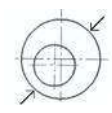
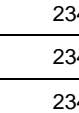
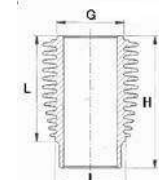
rel. 1511

Non original engine parts. OEMs names and part numbers are for reference purpose only.

RUGGERINI

RD 181	Cm³	CILINDRI CYLINDERS	ALESAGGIO BORE	CORSA STROKE	VERSIONE VERSION
	754	2	80	75	

		TESTA HEAD	H08		3	2,5	TIPO TYPE	A	
		A	75		10	2,5			
	FIN200PN	E	67,5		23	4		G	114
	854.12	F	22		2340	FIN067RS00		H	135,2
	80	A2012	FIN488PC00					I	98
	80,5	A2013	FIN488PC05		2341	FIN067RS05		L	89,2
	81	A2014	FIN488PC10		2342	FIN067RS10	203.52	FIN488SL00	

		Nr.						ADATTABILE A: SUITABLE FOR:	
---	---	------------	---	---	---	---	---	--------------------------------	---

CR	AL	2	45,00	48,01	24,12		STD - 025 - 050 - 075 - 100 - BAR	316.36	FIN036CR STD
----	----	---	-------	-------	-------	--	--------------------------------------	--------	--------------

MB	AL	3	45,00	47,98	24,12		STD - 025 - 050 - 075 - 100 - BAR	310.31	FIN031MB STD
----	----	---	-------	-------	-------	--	--------------------------------------	--------	--------------





--	--	--	--	--	--	--	--	--	--



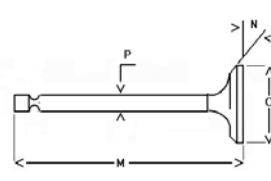

--	--	--	--	--	--	--	--	--	--

--	--	--	--	--	--	--	--	--	--

--	--	--	--	--	--	--	--	--	--

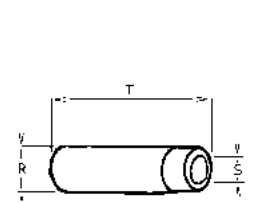
--	--	--	--	--	--	--	--	--	--

	IN EX		Nr.	O	P	M	N		ADATTABILE A: SUITABLE FOR:			
	IN		FS	2	33	7	95		45	A1	960.49	FINA027
	EX		FN	2	30	7	95		45	A1	960.50	FINS028

	IN EX		Nr.	R	S	T		ADATTABILE A: SUITABLE FOR:			
	IN		G	2	13,05	7,03		39	I	464.47	FIN208ASA
	IN		G		13,15	7,03		39	I	464.48	FIN208ASB
	EX		G	2	13,05	7,03		39	I	464.47	FIN208ASA
	EX	G		13,15	7,03	39	I	464.48	FIN208ASB		

Ricambi non originali per motori. Denominazioni e codici originali, sono riportati a puro titolo di riferimento.

7 - 18

rel. 1511

Non original engine parts. OEMs names and part numbers are for reference purpose only.

RUGGERINI

RD 181	Cm³	CILINDRI CYLINDERS	ALESAGGIO BORE	CORSA STROKE	VERSIONE VERSION
	754	2	80	75	

	2932	2931			448.86	448.53	448.14	450.13
FIN4451CGA	FIN4451CGB	FIN5241SM	FIN3218RT	FIN3218RT	FIN221CO	FIN704CB	FIN503IG	FIN504EG

 ADATTABILE A: SUITABLE FOR:	 FIN6352HG	Nr.	ENGINE KIT	ELECTRIC KIT
		1	 FIN488SL00	
		1	 FIN488PC00	
		1	 FIN5250SM	
			FIN2035KIT	

388.54		359.26		175.23	175.24		
FIN458AF		FIN821NF		FIN4231FE	FIN102OF		

				2321			
				FIN480OP			

652.12	656.28	644.27	644.28	660.16	956.51		
FIN681FP	FIN221JP	FIN522NH	FIN051NO	FIN059E	FIN351DV		

	FIN003CN						

014.41	730.34	5840.142					
FIN140VA	FIN298VR	FIN142TL					

Ricambi non originali per motori. Denominazioni e codici originali, sono riportati a puro titolo di riferimento.

8 - 18

rel. 1511

Non original engine parts. OEMs names and part numbers are for reference purpose only.

RUGGERINI

RD 188	Cm³	CILINDRI CYLINDERS	ALESAGGIO BORE	CORSA STROKE	VERSIONE VERSION
	754	2	80	75	

		TESTA HEAD	H08			TIPO TYPE	A		
		A	75					G	114
		B	40					H	135,2
		C	12,5					I	98
		D	40,7					L	89,2
		E	67,5					203.52	
FIN200PN 854.12		F	22						
	80	A2012	FIN488PC00	2340	FIN067RS00				
	80,5	A2013	FIN488PC05	2341	FIN067RS05				
	81	A2014	FIN488PC10	2342	FIN067RS10				

		Nr.							ADATTABILE A: SUITABLE FOR:	
--	--	------------	--	--	--	--	--	--	--------------------------------	--

CR	AL	2	45,00	48,01	24,12			STD - 025 - 050 - 075 - 100 - BAR	316.36	FIN036CR STD
----	----	---	-------	-------	-------	--	--	-----------------------------------	--------	--------------

MB	AL	3	45,00	47,98	24,12			STD - 025 - 050 - 075 - 100 - BAR	310.31	FIN031MB STD
----	----	---	-------	-------	-------	--	--	-----------------------------------	--------	--------------

--	--	--	--	--	--	--	--	--	--	--

--	--	--	--	--	--	--	--	--	--	--

--	--	--	--	--	--	--	--	--	--	--

--	--	--	--	--	--	--	--	--	--	--

--	--	--	--	--	--	--	--	--	--	--

	IN EX		Nr.	O	P	M	N		ADATTABILE A: SUITABLE FOR:			
	IN		FS	2	33	7	95		45	A1	960.49	FINA027
	EX		FN	2	30	7	95		45	A1	960.50	FINS028

	IN EX		Nr.	R	S	T		ADATTABILE A: SUITABLE FOR:			
	IN		G	2	13,05	7,03		39	I	464.47	FIN208ASA
	IN		G		13,15	7,03		39	I	464.48	FIN208ASB
	EX		G	2	13,05	7,03		39	I	464.47	FIN208ASA
	EX		G		13,15	7,03		39	I	464.48	FIN208ASB

Ricambi non originali per motori. Denominazioni e codici originali, sono riportati a puro titolo di riferimento.

RUGGERINI

RD 188	Cm³	CILINDRI CYLINDERS	ALESAGGIO BORE	CORSA STROKE	VERSIONE VERSION
	754	2	80	75	

	2932	2931			448.86	448.53	448.14	450.13
FIN4451CGA	FIN4451CGB	FIN5241SM	FIN3218RT	FIN3218RT	FIN221CO	FIN704CB	FIN503IG	FIN504EG

 ADATTABILE A: SUITABLE FOR:		Nr.	ENGINE KIT	ELECTRIC KIT
	450.18	1	 FIN488SL00	
		1	 FIN488PC00	
		1	 FIN5250SM	
			FIN2035KIT	

388.54		359.26		175.23	175.24		
FIN458AF		FIN821NF		FIN4231FE	FIN102OF		

				2321			
				FIN480OP			

652.12	656.28	644.27	644.28	660.16	956.51		
FIN681FP	FIN221JP	FIN522NH	FIN051NO	FIN059E	FIN351DV		

	FIN003CN						

014.41	730.34	5840.142					
FIN140VA	FIN298VR	FIN142TL					

Ricambi non originali per motori. Denominazioni e codici originali, sono riportati a puro titolo di riferimento.



10 - 18







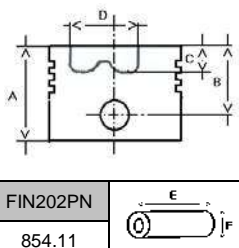

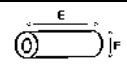
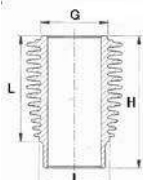
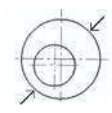
rel. 1511

Non original engine parts. OEMs names and part numbers are for reference purpose only.

RUGGERINI

RD 850	Cm³	CILINDRI CYLINDERS	ALESAGGIO BORE	CORSA STROKE	VERSIONE VERSION
	482	1	85	85	

		TESTA HEAD	H43		3	2,5	TIPO TYPE	A			
		A	88		10	2,5					
		B	50		10	2,5					
		C	12		22	5					
		D	44								
		E	74								
FIN202PN		F	25					G	105		
854.11						H		165,6			
						I		98			
							L	122,4			
	85	2130	FIN192PC00		2135	FIN069RS00		203.10		FIN489SL00	
	85,5	2131	FIN192PC05		2136	FIN069RS05					
	86	2132	FIN192PC10		2137	FIN069RS10					

		Nr.							ADATTABILE A: SUITABLE FOR:	
--	---	------------	---	---	---	---	---	--	--------------------------------	---

CR	AL	1	45,00	48,01	24,12			STD - 025 - 050 - 075 - 100 - BAR	316.36	FIN036CR STD
----	----	---	-------	-------	-------	--	--	-----------------------------------	--------	--------------

MB	ALL	2	42,09	50,03	40,20			STD - 025 - 050 - 075 - 100 - BAR - BAR EM1	310.16	FIN016MB STD
----	-----	---	-------	-------	-------	--	--	---	--------	--------------





--	--	--	--	--	--	--	--	--	--	--



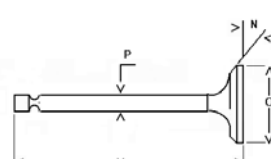

--	--	--	--	--	--	--	--	--	--	--

PB	BM	1	25,02	28,02	27,50			SEMIF.	316.41	FIN141PB
----	----	---	-------	-------	-------	--	--	--------	--------	----------

--	--	--	--	--	--	--	--	--	--	--

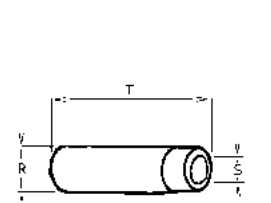
--	--	--	--	--	--	--	--	--	--	--

	IN EX		Nr.	O	P	M	N		ADATTABILE A: SUITABLE FOR:				
	IN		FS	1	35	9	105		45		E1	960.16	FINA116
	EX		FN	1	35	9	105		45		A1	960.15	FINS117

	IN EX		Nr.	R	S	T		ADATTABILE A: SUITABLE FOR:				
	IN		G	1	15,03	9,04		45		L	464.39	FIN203AA
	IN		G		15,13	9,04		45		L	464.25	FIN203AB
	EX		G	1	15,03	9,04		45		L	464.40	FIN204SA
	EX		G		15,13	9,04		45		L	464.35	FIN204SB

Ricambi non originali per motori. Denominazioni e codici originali, sono riportati a puro titolo di riferimento.

11 - 18

rel. 1511

Non original engine parts. OEMs names and part numbers are for reference purpose only.

RUGGERINI

RD 850	Cm³	CILINDRI CYLINDERS	ALESAGGIO BORE	CORSA STROKE	VERSIONE VERSION
	482	1	85	85	

	2119	2393			447.76	447.79	448.14	448.14
FIN108CGA	FIN108CGB	FIN082SM	FIN3216RT	FIN3215RT	FIN206CO	FIN281CB	FIN503IG	FIN503IG

 ADATTABILE A: SUITABLE FOR:		Nr. ENGINE KIT	ELECTRIC KIT 				
	447.78			FIN6380HG	1		FIN489SL00
					1		FIN192PC00
					1		FIN082SM
			FIN0902KIT				

387.39		359.13		175.20	175.05		
FIN2208AF		FIN1033NF		FIN4232FE	FIN4225OF		

100.23				2122			
FIN1065KR				FIN022OP			

	653.03		644.07	660.07	956.05		
	FIN708JP		FIN114NO	FIN074E	FIN016DV		

696.54		890.02					
FIN052PU	FIN003CN	FIN303ST					

			526.66				
			FIN113SI				

Ricambi non originali per motori. Denominazioni e codici originali, sono riportati a puro titolo di riferimento.



12 - 18







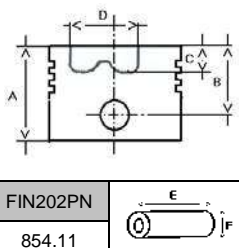

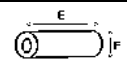
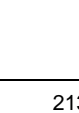
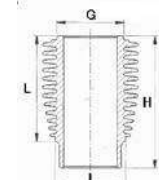
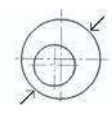
rel. 1511

Non original engine parts. OEMs names and part numbers are for reference purpose only.

RUGGERINI

RD 901/A	Cm³	CILINDRI CYLINDERS	ALESAGGIO BORE	CORSA STROKE	VERSIONE VERSION
	482	1	85	85	

		TESTA HEAD	H43		3	2,5	TIPO TYPE	A	
		A	88		10	2,5			
FIN202PN 854.11		B	50		10	2,5		G	105
		C	12		22	5		H	165,6
	85 2130	E	74	2135 FIN069RS00	2136 FIN069RS05	2137 FIN069RS10	203.10	I	98
		D	44					FIN489SL00	
		F	25						
	85,5 2131						L	122,4	
	86 2132								

		Nr.							ADATTABILE A: SUITABLE FOR:	
--	---	------------	---	---	---	---	---	--	--------------------------------	---

CR	AL	1	45,00	48,01	24,12			STD - 025 - 050 - 075 - 100 - BAR	316.36	FIN036CR STD
----	----	---	-------	-------	-------	--	--	-----------------------------------	--------	--------------

MB	ALL	2	42,09	50,03	40,20			STD - 025 - 050 - 075 - 100 - BAR - BAR EM1	310.16	FIN016MB STD
----	-----	---	-------	-------	-------	--	--	---	--------	--------------





--	--	--	--	--	--	--	--	--	--	--



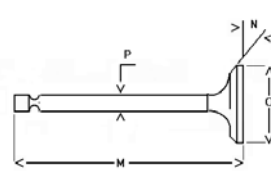

--	--	--	--	--	--	--	--	--	--	--

PB	BM	1	25,02	28,02	27,50			SEMIF.	316.41	FIN141PB
----	----	---	-------	-------	-------	--	--	--------	--------	----------

--	--	--	--	--	--	--	--	--	--	--

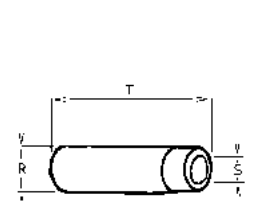
--	--	--	--	--	--	--	--	--	--	--

	IN EX		Nr.	O	P	M	N		ADATTABILE A: SUITABLE FOR:				
	IN		FS	1	35	9	105		45		E1	960.16	FINA116
	EX		FN	1	35	9	105		45		A1	960.15	FINS117

	IN EX		Nr.	R	S	T		ADATTABILE A: SUITABLE FOR:				
	IN		G	1	15,03	9,04		45		L	464.39	FIN203AA
	IN		G		15,13	9,04		45		L	464.25	FIN203AB
	EX		G	1	15,03	9,04		45		L	464.40	FIN204SA
	EX		G		15,13	9,04		45		L	464.35	FIN204SB

Ricambi non originali per motori. Denominazioni e codici originali, sono riportati a puro titolo di riferimento.

13 - 18

rel. 1511

Non original engine parts. OEMs names and part numbers are for reference purpose only.

RUGGERINI

RD 901/A	Cm³	CILINDRI CYLINDERS	ALESAGGIO BORE	CORSA STROKE	VERSIONE VERSION
		1	85		

	2119	2393			447.76	447.79	448.14	448.14
FIN108CGA	FIN108CGB	FIN082SM	FIN3216RT	FIN3215RT	FIN206CO	FIN281CB	FIN503IG	FIN503IG

 	ADATTABILE A: SUITABLE FOR:		Nr.	ENGINE KIT	ELECTRIC KIT
	447.78	FIN6380HG	1	 FIN489SL00	
			1	 FIN192PC00	
			1	 FIN082SM	
				FIN0902KIT	

387.39		359.13		175.20	175.05		
FIN2208AF		FIN1033NF		FIN4232FE	FIN4225OF		

100.23				2122			
FIN1065KR				FIN022OP			

	653.03		644.07	660.07	956.05		
	FIN708JP		FIN114NO	FIN074E	FIN016DV		

696.54		890.02					
FIN052PU	FIN003CN	FIN303ST					

			526.66				
			FIN113SI				

Ricambi non originali per motori. Denominazioni e codici originali, sono riportati a puro titolo di riferimento.





14 - 18





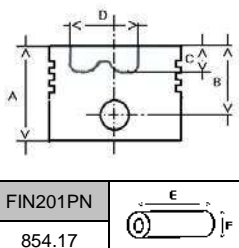

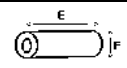
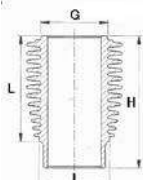

rel. 1511

Non original engine parts. OEMs names and part numbers are for reference purpose only.

RUGGERINI

RD 200	Cm³	CILINDRI CYLINDERS	ALESAGGIO BORE	CORSA STROKE	VERSIONE VERSION
	851	2	85	75	

		TESTA HEAD	H13		3	2	TIPO TYPE	A	
		A	70		10	2			
FIN201PN 854.17		E	64	A2277	FIN070RS00		G	114	
		F	22				FIN070RS05	H	135,2
	85	A2293	FIN194PC00	2992	FIN070RS05	203.65	I	98	
	85,5	A2147	FIN194PC05	2993	FIN070RS10		L	89,2	
	86	A2148	FIN194PC10				FIN026SL00		

		Nr.						ADATTABILE A: SUITABLE FOR:	
---	---	------------	---	---	---	---	---	--------------------------------	---

CR	AL	2	45,00	48,01	24,12		STD - 025 - 050 - 075 - 100	316.70	FIN2260CR STD
----	----	---	-------	-------	-------	--	-----------------------------	--------	---------------

MB	AL	3	45,00	47,98	24,12		STD - 025 - 050 - 075 - 100 - BAR	310.31	FIN031MB STD
----	----	---	-------	-------	-------	--	-----------------------------------	--------	--------------





--	--	--	--	--	--	--	--	--	--



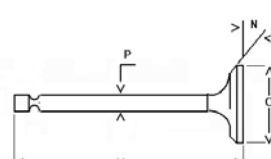

--	--	--	--	--	--	--	--	--	--

--	--	--	--	--	--	--	--	--	--

--	--	--	--	--	--	--	--	--	--

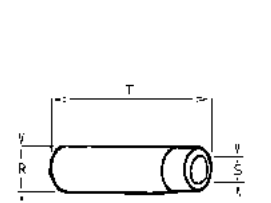
--	--	--	--	--	--	--	--	--	--

	IN EX		Nr.	O	P	M	N		ADATTABILE A: SUITABLE FOR:			
	IN		FS	2	33	7	95		45	A1	960.49	FINA027
	EX		FN	2	30	7	95		45	A1	960.50	FINS028

	IN EX		Nr.	R	S	T		ADATTABILE A: SUITABLE FOR:			
	IN		G	2	13,05	7,03		39	I	464.77	FIN208ASA
	IN		G		13,15	7,03		39	I	464.59	FIN208ASB
	EX		G	2	13,05	7,03		39	I	464.77	FIN208ASA
	EX	G		13,15	7,03	39	I	464.59	FIN208ASB		

Ricambi non originali per motori. Denominazioni e codici originali, sono riportati a puro titolo di riferimento.

15 - 18

rel. 1511

Non original engine parts. OEMs names and part numbers are for reference purpose only.

RUGGERINI

RD 200	Cm³	CILINDRI CYLINDERS	ALESAGGIO BORE	CORSA STROKE	VERSIONE VERSION
	851	2	85	75	

	2984	2983			448.86	448.53	448.14	450.13
FIN109CGA	FIN109CGB	FIN083SM	FIN3218RT	FIN3218RT	FIN221CO	FIN704CB	FIN503IG	FIN504EG

 ADATTABILE A: SUITABLE FOR:		<table border="1"> <thead> <tr> <th>Nr.</th> <th>ENGINE KIT</th> </tr> </thead> <tbody> <tr> <td>1</td> <td> FIN026SL00</td> </tr> <tr> <td>1</td> <td> FIN194PC00</td> </tr> <tr> <td>1</td> <td> FIN5251SM</td> </tr> <tr> <td></td> <td>FIN2130KIT</td> </tr> </tbody> </table>	Nr.	ENGINE KIT	1	FIN026SL00	1	FIN194PC00	1	FIN5251SM		FIN2130KIT	<table border="1"> <thead> <tr> <th>ELECTRIC KIT</th> </tr> </thead> <tbody> <tr> <td></td> </tr> </tbody> </table>	ELECTRIC KIT	
	Nr.		ENGINE KIT												
	1		FIN026SL00												
	1		FIN194PC00												
1	FIN5251SM														
	FIN2130KIT														
ELECTRIC KIT															
450.45	FIN6353HG														

388.54	359.26	175.23	175.24
FIN458AF	FIN821NF	FIN4231FE	FIN102OF

2321
FIN480OP

652.12	656.28	644.27	644.28	660.16	956.51
FIN681FP	FIN221JP	FIN522NH	FIN051NO	FIN059E	FIN351DV

FIN003CN

014.41	730.34	5840.142
FIN140VA	FIN298VR	FIN142TL

Ricambi non originali per motori. Denominazioni e codici originali, sono riportati a puro titolo di riferimento.





16 - 18





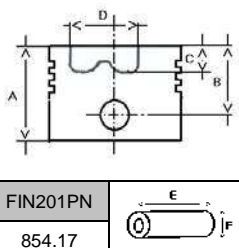

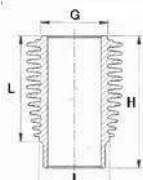
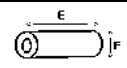
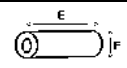
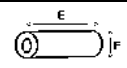

rel. 1511

Non original engine parts. OEMs names and part numbers are for reference purpose only.

RUGGERINI

RD 201	Cm³	CILINDRI CYLINDERS	ALESAGGIO BORE	CORSA STROKE	VERSIONE VERSION
	851	2	85	75	

		TESTA HEAD	H13		3	2	TIPO TYPE	A	
		A	70		10	2			G
FIN201PN		B	40		22	4	H		135,2
854.17		C	13		E	64		I	98
	D	42,6	F	22	A2277	FIN070RS00		L	89,2
	85	A2293	FIN194PC00	A2992	FIN070RS05	203.65		FIN026SL00	
	85,5	A2147	FIN194PC05	2993	FIN070RS10				
86	A2148	FIN194PC10							

		Nr.						ADATTABILE A: SUITABLE FOR:	
---	---	------------	---	---	---	---	---	--------------------------------	---

CR	AL	2	45,00	48,01	24,12		STD - 025 - 050 - 075 - 100	316.70	FIN2260CR STD
----	----	---	-------	-------	-------	--	-----------------------------	--------	---------------

MB	AL	3	45,00	47,98	24,12		STD - 025 - 050 - 075 - 100 - BAR	310.31	FIN031MB STD
----	----	---	-------	-------	-------	--	-----------------------------------	--------	--------------





--	--	--	--	--	--	--	--	--	--



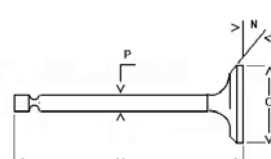

--	--	--	--	--	--	--	--	--	--

--	--	--	--	--	--	--	--	--	--

--	--	--	--	--	--	--	--	--	--

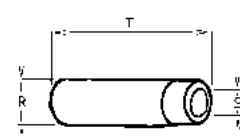
--	--	--	--	--	--	--	--	--	--

	IN EX		Nr.	O	P	M	N		ADATTABILE A: SUITABLE FOR:			
	IN		FS	2	33	7	95		45	A1	960.49	FINA027
	EX		FN	2	30	7	95		45	A1	960.50	FINS028

	IN EX		Nr.	R	S	T		ADATTABILE A: SUITABLE FOR:			
	IN		G	2	13,05	7,03		39	I	464.77	FIN208ASA
	IN		G		13,15	7,03		39	I	464.59	FIN208ASB
	EX		G	2	13,05	7,03		39	I	464.77	FIN208ASA
EX	G		13,15	7,03	39	I	464.59	FIN208ASB			

Ricambi non originali per motori. Denominazioni e codici originali, sono riportati a puro titolo di riferimento.

17 - 18

rel. 1511

Non original engine parts. OEMs names and part numbers are for reference purpose only.

RUGGERINI

RD 201	Cm³	CILINDRI CYLINDERS	ALESAGGIO BORE	CORSA STROKE	VERSIONE VERSION
	851	2	85	75	

	2984	2983			448.86	448.53	448.14	450.13
FIN109CGA	FIN109CGB	FIN083SM	FIN3218RT	FIN3218RT	FIN221CO	FIN704CB	FIN503IG	FIN504EG

 ADATTABILE A: SUITABLE FOR:		Nr. ENGINE KIT	 FIN026SL00	ELECTRIC KIT 		
	450.45				1	 FIN194PC00
					1	 FIN5251SM
						FIN2130KIT

388.54	359.26	175.23	175.24
FIN458AF	FIN821NF	FIN4231FE	FIN102OF

2321
FIN480OP

652.12	656.28	644.27	644.28	660.16	956.51
FIN681FP	FIN221JP	FIN522NH	FIN051NO	FIN059E	FIN351DV

FIN003CN

014.41	730.34	5840.142
FIN140VA	FIN298VR	FIN142TL

Ricambi non originali per motori. Denominazioni e codici originali, sono riportati a puro titolo di riferimento.



18 - 18







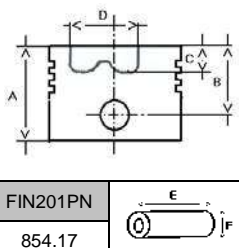

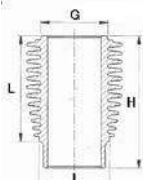
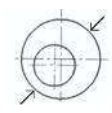
rel. 1511

Non original engine parts. OEMs names and part numbers are for reference purpose only.

RUGGERINI

RD 208	Cm³	CILINDRI CYLINDERS	ALESAGGIO BORE	CORSA STROKE	VERSIONE VERSION
	851	2	85	75	

		TESTA HEAD	H13		3	2	TIPO TYPE	A	
		A	70		10	2			
		B	40		22	4		G	114
		C	13					H	135,2
		D	42,6					I	98
		E	64					L	89,2
		F	22				203.65		FIN026SL00
		85	2987	FIN194PC00	A2052	FIN070RS00			
		85,5	2988	FIN194PC05	2992	FIN070RS05			
		86	2989	FIN194PC10	2993	FIN070RS10			

		Nr.						ADATTABILE A: SUITABLE FOR:	
---	---	------------	---	---	---	---	---	--------------------------------	---

CR	AL	2	45,00	48,01	24,12		STD - 025 - 050 - 075 - 100 - BAR	316.36	FIN036CR STD
----	----	---	-------	-------	-------	--	-----------------------------------	--------	--------------

MB	AL	3	45,00	47,98	24,12		STD - 025 - 050 - 075 - 100 - BAR	310.31	FIN031MB STD
----	----	---	-------	-------	-------	--	-----------------------------------	--------	--------------





--	--	--	--	--	--	--	--	--	--



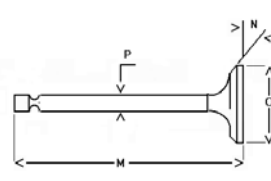

--	--	--	--	--	--	--	--	--	--

PB	BM	2	25,02	28,02	27,50		SEMIF.	316.41	FIN141PB
----	----	---	-------	-------	-------	--	--------	--------	----------

--	--	--	--	--	--	--	--	--	--

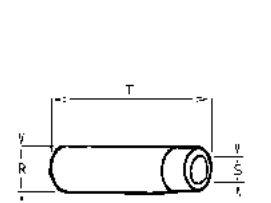
--	--	--	--	--	--	--	--	--	--

	IN EX		Nr.	O	P	M	N		ADATTABILE A: SUITABLE FOR:			
	IN		FS	2	33	7	95		45	A1	960.49	FINA027
	EX		FN	2	30	7	95		45	A1	960.50	FINS028

	IN EX		Nr.	R	S	T		ADATTABILE A: SUITABLE FOR:			
	IN		G	2	13,05	7,03		39	I	464.47	FIN208ASA
	IN		G		13,15	7,03		39	I	464.48	FIN208ASB
	EX		G	2	13,05	7,03		39	I	464.47	FIN208ASA
	EX	G		13,15	7,03	39	I	464.48	FIN208ASB		

Ricambi non originali per motori. Denominazioni e codici originali, sono riportati a puro titolo di riferimento.

19 - 18

rel. 1511

Non original engine parts. OEMs names and part numbers are for reference purpose only.

RUGGERINI

RD 208	Cm³	CILINDRI CYLINDERS	ALESAGGIO BORE	CORSA STROKE	VERSIONE VERSION
	851	2	85	75	

	2984	2983			448.86	448.53	448.14	450.13
FIN109CGA	FIN109CGB	FIN083SM	FIN3218RT	FIN3218RT	FIN221CO	FIN704CB	FIN503IG	FIN504EG

 ADATTABILE A: SUITABLE FOR:	 FIN6353HG	Nr.	ENGINE KIT	ELECTRIC KIT
		1	 FIN026SL00	
		1	 FIN194PC00	
		1	 FIN5251SM	
			FIN2130KIT	

388.54		359.26		175.23	175.24		
FIN458AF		FIN821NF		FIN4231FE	FIN102OF		

				2321			
				FIN480OP			

652.12	656.28	644.27	644.28	660.16	956.51		
FIN681FP	FIN221JP	FIN522NH	FIN051NO	FIN059E	FIN351DV		

	FIN003CN						

014.41	730.34	5840.142					
FIN140VA	FIN298VR	FIN142TL					

Ricambi non originali per motori. Denominazioni e codici originali, sono riportati a puro titolo di riferimento.



20 - 18







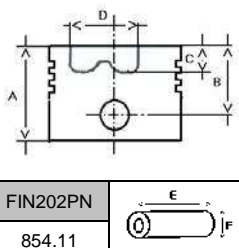

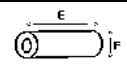
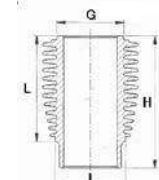
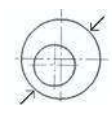
rel. 1511

Non original engine parts. OEMs names and part numbers are for reference purpose only.

RUGGERINI

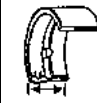
RD 900	Cm³	CILINDRI CYLINDERS	ALESAGGIO BORE	CORSA STROKE	VERSIONE VERSION
		1	90		

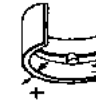
		TESTA HEAD	H14		3	2,5	TIPO TYPE	A	
		A	85		1	2,5			
		B	50		10	2,5			
		C	15		22	5			
		D	43						
		E	74						
FIN202PN		F	25					G	105
854.11						H		165,6	
						I		98	
	90	2144	FIN195PC00		2149	FIN071RS00		L	122,4
	90,5	2145	FIN195PC05		2150	FIN071RS05		203.12	
	91	2146	FIN195PC10		2151	FIN071RS10		FIN028SL00	

		Nr.						ADATTABILE A: SUITABLE FOR:	
---	---	------------	---	---	---	---	---	--------------------------------	---

CR	AL	1	45,00	48,01	24,12		STD - 025 - 050 - 075 - 100 - BAR	316.36	FIN036CR STD
----	----	---	-------	-------	-------	--	-----------------------------------	--------	--------------

MB	ALL	2	42,09	50,03	40,20		STD - 025 - 050 - 075 - 100 - BAR - BAR EM1	310.16	FIN016MB STD
----	-----	---	-------	-------	-------	--	---	--------	--------------





--	--	--	--	--	--	--	--	--	--



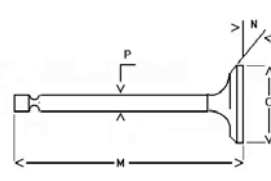

--	--	--	--	--	--	--	--	--	--

PB	BM	1	25,02	28,02	27,50		SEMIF.	316.41	FIN141PB
----	----	---	-------	-------	-------	--	--------	--------	----------

--	--	--	--	--	--	--	--	--	--

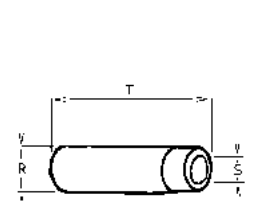
--	--	--	--	--	--	--	--	--	--

	IN EX		Nr.	O	P	M	N		ADATTABILE A: SUITABLE FOR:			
	IN		FS	1	35	9	105		45	E1	960.16	FINA116
	EX		FN	1	35	9	105		45	A1	960.15	FINS117

	IN EX		Nr.	R	S	T		ADATTABILE A: SUITABLE FOR:			
	IN		G	1	15,03	9,04		45	L	464.39	FIN203AA
	IN		G		15,13	9,04		45	L	464.25	FIN203AB
	EX		G	1	15,03	9,04		45	L	464.40	FIN204SA
	EX		G		15,13	9,04		45	L	464.35	FIN204SB

Ricambi non originali per motori. Denominazioni e codici originali, sono riportati a puro titolo di riferimento.

21 - 18

rel. 1511

Non original engine parts. OEMs names and part numbers are for reference purpose only.

RUGGERINI

RD 900	Cm³	CILINDRI CYLINDERS	ALESAGGIO BORE	CORSA STROKE	VERSIONE VERSION
		1	90		

	2119	2393			447.76	447.79	448.14	448.14
FIN110CGA	FIN108CGB	FIN082SM	FIN3216RT	FIN3215RT	FIN206CO	FIN281CB	FIN503IG	FIN503IG

 	ADATTABILE A: SUITABLE FOR:		Nr.	ENGINE KIT	ELECTRIC KIT
	447.78	FIN6380HG	1	 FIN028SL00	
			1	 FIN195PC00	
			1	 FIN082SM	
				FIN3381KIT	

387.39		359.13		175.20	175.05		
FIN2208AF		FIN1033NF		FIN4232FE	FIN4225OF		

100.23				2122			
FIN1065KR				FIN022OP			

	656.03		644.07	660.07	956.05		
	FIN708JP		FIN114NO	FIN074E	FIN016DV		

696.54		890.02					
FIN052PU	FIN003CN	FIN303ST					

			526.66				
			FIN113SI				

Ricambi non originali per motori. Denominazioni e codici originali, sono riportati a puro titolo di riferimento.



22 - 18







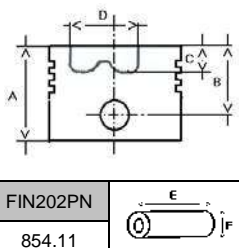

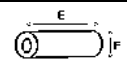
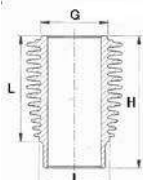
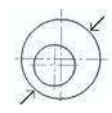
rel. 1511

Non original engine parts. OEMs names and part numbers are for reference purpose only.

RUGGERINI

RD 901	Cm³	CILINDRI CYLINDERS	ALESAGGIO BORE	CORSA STROKE	VERSIONE VERSION
		1	90		

		TESTA HEAD	H14		3	2	TIPO TYPE	A	
		A	85		10	2			
		B	50		23	4			
		C	15						
		D	43						
		E	74						
FIN202PN		F	25					G	105
854.11						H		165,6	
								I	98
	90	A2407	FIN1513PC00	A2157	FIN072RS00	203.12		L	122,4
	90,5	A2408	FIN1513PC05	A2158	FIN072RS05			FIN028SL00	
	91	A2409	FIN1513PC10	A2159	FIN072RS10				

		Nr.						ADATTABILE A: SUITABLE FOR:	
---	---	------------	---	---	---	---	---	--------------------------------	---

CR	AL	1	45,00	48,01	24,12		STD - 025 - 050 - 075 - 100 - BAR	316.36	FIN036CR STD
----	----	---	-------	-------	-------	--	-----------------------------------	--------	--------------

MB	ALL	2	42,09	50,03	40,20		STD - 025 - 050 - 075 - 100 - BAR - BAR EM1	310.16	FIN016MB STD
----	-----	---	-------	-------	-------	--	---	--------	--------------





--	--	--	--	--	--	--	--	--	--



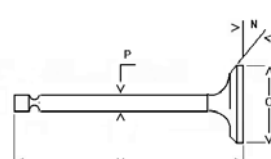

--	--	--	--	--	--	--	--	--	--

PB	BM	1	25,02	28,02	27,50		SEMIF.	316.41	FIN141PB
----	----	---	-------	-------	-------	--	--------	--------	----------

--	--	--	--	--	--	--	--	--	--

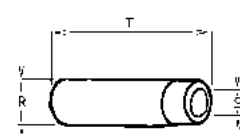
--	--	--	--	--	--	--	--	--	--

	IN EX		Nr.	O	P	M	N		ADATTABILE A: SUITABLE FOR:				
	IN		FS	1	35	9	105		45		E1	960.16	FINA116
	EX		FN	1	35	9	105		45		A1	960.15	FINS117

	IN EX		Nr.	R	S	T		ADATTABILE A: SUITABLE FOR:				
	IN		G	1	15,03	9,04		45		L	464.39	FIN203AA
	IN		G		15,13	9,04		45		L	464.25	FIN203AB
	EX		G	1	15,03	9,04		45		L	464.40	FIN204SA
	EX		G		15,13	9,04		45		L	464.35	FIN204SB

Ricambi non originali per motori. Denominazioni e codici originali, sono riportati a puro titolo di riferimento.

23 - 18

rel. 1511

Non original engine parts. OEMs names and part numbers are for reference purpose only.

RUGGERINI

RD 901	Cm³	CILINDRI CYLINDERS	ALESAGGIO BORE	CORSA STROKE	VERSIONE VERSION
		1	90		

	2119	2393			447.76	447.79	448.14	448.14
FIN110CGA	FIN108CGB	FIN082SM	FIN3216RT	FIN3215RT	FIN206CO	FIN281CB	FIN503IG	FIN503IG

 	ADATTABILE A: SUITABLE FOR:		Nr.	ENGINE KIT	ELECTRIC KIT
	447.78	FIN6380HG	1	 FIN028SL00	
			1	 FIN1513PC00	
			1	 FIN082SM	
				FIN6380KIT	

387.39		359.13		175.20	175.05		
FIN2208AF		FIN1033NF		FIN4232FE	FIN4225OF		

100.23				2122			
FIN1065KR				FIN022OP			

	656.03		644.07	660.07	956.05		
	FIN708JP		FIN114NO	FIN074E	FIN016DV		

696.54		890.02					
FIN052PU	FIN003CN	FIN303ST					

			526.66				
			FIN113SI				

Ricambi non originali per motori. Denominazioni e codici originali, sono riportati a puro titolo di riferimento.



24 - 18







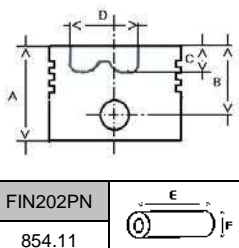

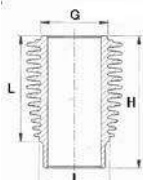
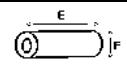
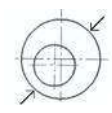
rel. 1511

Non original engine parts. OEMs names and part numbers are for reference purpose only.

RUGGERINI

RD 901 / AD	Cm³	CILINDRI CYLINDERS	ALESAGGIO BORE	CORSA STROKE	VERSIONE VERSION
		1	90		

		TESTA HEAD	H14		3	2	TIPO TYPE	A		
		A	85		10	2			G	105
		B	50		23	4			H	165,6
		C	15						I	98
		D	43						L	122,4
		E	74						203.12	
FIN202PN		F	25	A2157	FIN072RS00					
854.11				A2158	FIN072RS05					
	90	A2407	FIN1513PC00	A2159	FIN072RS10					
	90,5	A2408	FIN1513PC05							
	91	A2409	FIN1513PC10							

		Nr.						ADATTABILE A: SUITABLE FOR:	
---	---	------------	---	---	---	---	---	--------------------------------	---

CR	AL	1	45,00	48,01	24,12		STD - 025 - 050 - 075 - 100 - BAR	316.36	FIN036CR STD
----	----	---	-------	-------	-------	--	-----------------------------------	--------	--------------

MB	ALL	2	42,09	50,03	40,20		STD - 025 - 050 - 075 - 100 - BAR - BAR EM1	310.16	FIN016MB STD
----	-----	---	-------	-------	-------	--	---	--------	--------------





--	--	--	--	--	--	--	--	--	--



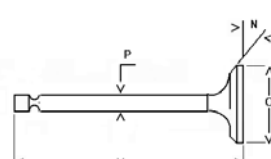

--	--	--	--	--	--	--	--	--	--

PB	BM	1	25,02	28,02	27,50		SEMIF.	316.41	FIN141PB
----	----	---	-------	-------	-------	--	--------	--------	----------

--	--	--	--	--	--	--	--	--	--

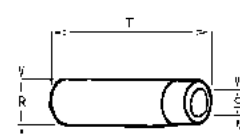
--	--	--	--	--	--	--	--	--	--

	IN EX		Nr.	O	P	M	N		ADATTABILE A: SUITABLE FOR:	
	IN	FS	1	37,6	9	105	45	E1	960.45	FINA124
	EX	FN	1	37	9	105	45	A1	960.46	FINS125

	IN EX		Nr.	R	S	T		ADATTABILE A: SUITABLE FOR:	
	IN	G	1	15,03	9,04	45	L	464.39	FIN203AA
	IN	G		15,13	9,04	45	L	464.25	FIN203AB
	EX	G	1	15,03	9,04	45	L	464.40	FIN204SA
	EX	G		15,13	9,04	45	L	464.35	FIN204SB

Ricambi non originali per motori. Denominazioni e codici originali, sono riportati a puro titolo di riferimento.

25 - 18

rel. 1511

Non original engine parts. OEMs names and part numbers are for reference purpose only.

RUGGERINI

RD 901/AD	Cm³	CILINDRI CYLINDERS	ALESAGGIO BORE	CORSA STROKE	VERSIONE VERSION
		1	90		

	2140	2394			447.76	447.79	448.14	448.14
FIN110CGA	FIN110CGB	FIN084SM	FIN3216RT	FIN3215RT	FIN206CO	FIN281CB	FIN503IG	FIN503IG

 	ADATTABILE A: SUITABLE FOR:		Nr.	ENGINE KIT	ELECTRIC KIT
	448.08	FIN6241HG	1	 FIN028SL00	
			1	 FIN1513PC00	
			1	 FIN084SM	
				FIN0915KIT	

387.39	359.13	175.20	175.05			
FIN2208AF	FIN1033NF	FIN4232FE	FIN4225OF			

100.23	2122					
FIN1065KR	FIN022OP					

656.03	644.07	660.07	956.05			
FIN708JP	FIN114NO	FIN074E	FIN016DV			

	890.02					
FIN003CN	FIN303ST					

		526.66				
		FIN113SI				

Ricambi non originali per motori. Denominazioni e codici originali, sono riportati a puro titolo di riferimento.





26 - 18





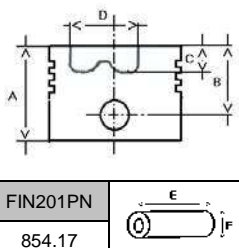

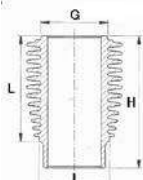

rel. 1511

Non original engine parts. OEMs names and part numbers are for reference purpose only.

RUGGERINI

RD 210	Cm³	CILINDRI CYLINDERS	ALESAGGIO BORE	CORSA STROKE	VERSIONE VERSION
	954	2	90	75	

		TESTA HEAD	H13		3	2	TIPO TYPE	A	
		A	80		10	2			
		B	40		23	4		G	114
		C	12,5					H	135,2
		D	45,2					I	98
		E	64					L	89,2
		F	22				203.73		FIN030SL00
		FIN201PN			A2157	FIN072RS00			
		854.17			A2158	FIN072RS05			
					A2159	FIN072RS10			

		Nr.						ADATTABILE A: SUITABLE FOR:	
---	---	------------	---	---	---	---	---	--------------------------------	---

CR	AL	2	45,00	48,01	24,12		STD - 025 - 050 - 075 - 100	A2638	FIN2260CR STD
----	----	---	-------	-------	-------	--	-----------------------------	-------	---------------

MB	AL	3	45,00	47,98	24,12		STD - 025 - 050 - 075 - 100 - BAR	A2649	FIN031MB STD
----	----	---	-------	-------	-------	--	-----------------------------------	-------	--------------





--	--	--	--	--	--	--	--	--	--



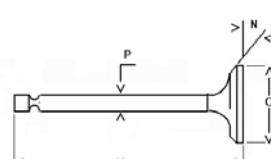

--	--	--	--	--	--	--	--	--	--

--	--	--	--	--	--	--	--	--	--

--	--	--	--	--	--	--	--	--	--

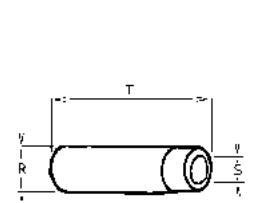
--	--	--	--	--	--	--	--	--	--

	IN EX		Nr.	O	P	M	N		ADATTABILE A: SUITABLE FOR:			
	IN		FS	2	39	7	95		45	A1	960.56	FINA160
	EX		FN	2	36	7	95		45	A1	960.55	FINS161

	IN EX		Nr.	R	S	T		ADATTABILE A: SUITABLE FOR:			
	IN		G	2	13,05	7,03		39	I	464.77	FIN208ASA
	IN		G		13,15	7,03		39	I	464.59	FIN208ASB
	EX		G	2	13,05	7,03		39	I	464.77	FIN208ASA
	EX	G		13,15	7,03	39	I	464.59	FIN208ASB		

Ricambi non originali per motori. Denominazioni e codici originali, sono riportati a puro titolo di riferimento.

27 - 18

rel. 1511

Non original engine parts. OEMs names and part numbers are for reference purpose only.

RUGGERINI

RD 210	Cm³	CILINDRI CYLINDERS	ALESAGGIO BORE	CORSA STROKE	VERSIONE VERSION
	954	2	90	75	

	A2093	A2092			448.86	448.53	448.14	450.13
FIN111CGA	FIN111CGB	FIN085SM	FIN3218RT	FIN3218RT	FIN221CO	FIN704CB	FIN503IG	FIN504EG

 ADATTABILE A: SUITABLE FOR:	 FIN503HG	Nr.	ENGINE KIT	ELECTRIC KIT
		1	 FIN030SL00	
		1	 FIN198PC00	
		1	 FIN5252SM	
		A2398	FIN2132KIT	

388.54		359.26		175.23	175.24		
FIN458AF		FIN821NF		FIN4231FE	FIN102OF		

				2321			
				FIN480OP			

652.12	656.28	644.27	644.28	660.16	956.51		
FIN681FP	FIN221JP	FIN522NH	FIN051NO	FIN059E	FIN351DV		

	FIN003CN						

014.41	730.34	5840.142					
FIN140VA	FIN298VR	FIN142TL					

Ricambi non originali per motori. Denominazioni e codici originali, sono riportati a puro titolo di riferimento.



28 - 18







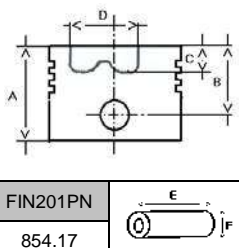

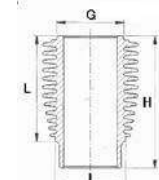
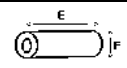
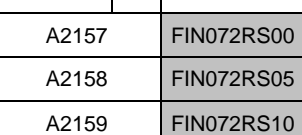
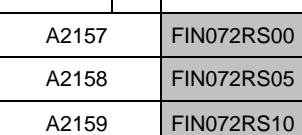
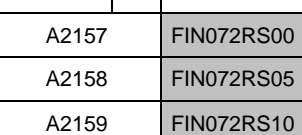
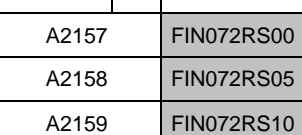
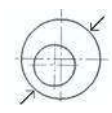
rel. 1511

Non original engine parts. OEMs names and part numbers are for reference purpose only.

RUGGERINI

RD 211	Cm³	CILINDRI CYLINDERS	ALESAGGIO BORE	CORSA STROKE	VERSIONE VERSION
	954	2	90	75	

		TESTA HEAD	H13		3	2	TIPO TYPE	A	
		A	80		10	2			G
FIN201PN		B	40		23	4	H		135,2
854.17		C	12,5					I	98
	90	A2063	FIN198PC00	A2157				FIN072RS00	203.73
	90,5	A2064	FIN198PC05	A2158	FIN072RS05	FIN030SL00			
91	A2065	FIN198PC10	A2159	FIN072RS10					

		Nr.							ADATTABILE A: SUITABLE FOR:	
---	---	------------	---	---	---	---	---	--	--------------------------------	---

CR	AL	2	45,00	48,01	24,12		STD - 025 - 050 - 075 - 100	A2638	FIN2260CR STD
----	----	---	-------	-------	-------	--	-----------------------------	-------	---------------

MB	AL	3	45,00	47,98	24,12		STD - 025 - 050 - 075 - 100 - BAR	A2649	FIN031MB STD
----	----	---	-------	-------	-------	--	-----------------------------------	-------	--------------





--	--	--	--	--	--	--	--	--	--



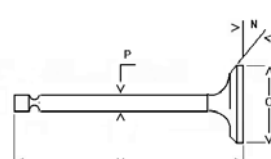

--	--	--	--	--	--	--	--	--	--

--	--	--	--	--	--	--	--	--	--

--	--	--	--	--	--	--	--	--	--

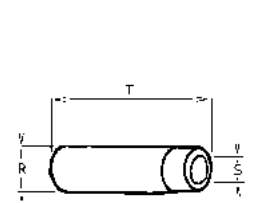
--	--	--	--	--	--	--	--	--	--

	IN EX		Nr.	O	P	M	N		ADATTABILE A: SUITABLE FOR:			
	IN		FS	2	39	7	95		45	A1	960.56	FINA160
	EX		FN	2	36	7	95		45	A1	960.55	FINS161

	IN EX		Nr.	R	S	T		ADATTABILE A: SUITABLE FOR:			
	IN		G	2	13,05	7,03		39	I	464.77	FIN208ASA
	IN		G		13,15	7,03		39	I	464.59	FIN208ASB
	EX		G	2	13,05	7,03		39	I	464.77	FIN208ASA
EX	G		13,15	7,03	39	I	464.59	FIN208ASB			

Ricambi non originali per motori. Denominazioni e codici originali, sono riportati a puro titolo di riferimento.

29 - 18

rel. 1511

Non original engine parts. OEMs names and part numbers are for reference purpose only.

RUGGERINI

RD 211	Cm³	CILINDRI CYLINDERS	ALESAGGIO BORE	CORSA STROKE	VERSIONE VERSION
	954	2	90	75	

	A2093	A2092			448.86	448.53	448.14	450.13
FIN111CGA	FIN111CGB	FIN085SM	FIN3218RT	FIN3218RT	FIN221CO	FIN704CB	FIN503IG	FIN504EG

 ADATTABILE A: SUITABLE FOR:	 FIN503HG	Nr.	ENGINE KIT	ELECTRIC KIT
		1	 FIN030SL00	
		1	 FIN198PC00	
		1	 FIN5252SM	
		A2398		

388.54		359.26		175.23	175.24		
FIN458AF		FIN821NF		FIN4231FE	FIN102OF		

				2321			
				FIN480OP			

652.12	656.28	644.27	644.28	660.16	956.51		
FIN681FP	FIN221JP	FIN522NH	FIN051NO	FIN059E	FIN351DV		

	FIN003CN						

014.41	730.34	5840.142					
FIN140VA	FIN298VR	FIN142TL					

Ricambi non originali per motori. Denominazioni e codici originali, sono riportati a puro titolo di riferimento.





30 - 18





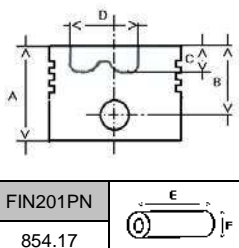

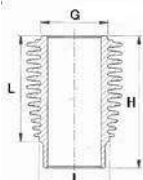
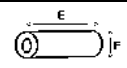
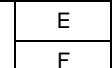

rel. 1511

Non original engine parts. OEMs names and part numbers are for reference purpose only.

RUGGERINI

RD 218	Cm³	CILINDRI CYLINDERS	ALESAGGIO BORE	CORSA STROKE	VERSIONE VERSION
	954	2	90	75	

		TESTA HEAD	H13		3	2	TIPO TYPE	A	
		A	80		10	2			G
FIN201PN		B	40		23	4	H		135,2
854.17		C	12,5		E	64	I	98	
		D	45,2				L	89,2	
	90	A2063	FIN198PC00	A2157	FIN072RS00	203.73	FIN030SL00		
	90,5	A2064	FIN198PC05	A2158	FIN072RS05				
91	A2065	FIN198PC10	A2159	FIN072RS10					

		Nr.						ADATTABILE A: SUITABLE FOR:	
---	---	------------	---	---	---	---	---	--------------------------------	---

CR	AL	2	45,00	48,01	24,12		STD - 025 - 050 - 075 - 100	A2638	FIN2260CR STD
----	----	---	-------	-------	-------	--	-----------------------------	-------	---------------

MB	AL	3	45,00	47,98	24,12		STD - 025 - 050 - 075 - 100 - BAR	A2649	FIN031MB STD
----	----	---	-------	-------	-------	--	-----------------------------------	-------	--------------





--	--	--	--	--	--	--	--	--	--



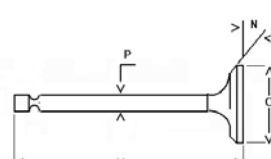

--	--	--	--	--	--	--	--	--	--

--	--	--	--	--	--	--	--	--	--

--	--	--	--	--	--	--	--	--	--

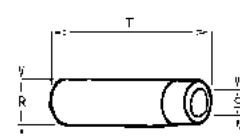
--	--	--	--	--	--	--	--	--	--

	IN EX		Nr.	O	P	M	N		ADATTABILE A: SUITABLE FOR:			
	IN		FS	2	33	7	95		45	A1	960.49	FINA027
	EX		FN	2	30	7	95		45	A1	960.50	FINS028

	IN EX		Nr.	R	S	T		ADATTABILE A: SUITABLE FOR:			
	IN		G	2	13,05	7,03		39	I	464.77	FIN208ASA
	IN		G		13,15	7,03		39	I	464.59	FIN208ASB
	EX		G	2	13,05	7,03		39	I	464.77	FIN208ASA
	EX	G		13,15	7,03	39	I	464.59	FIN208ASB		

Ricambi non originali per motori. Denominazioni e codici originali, sono riportati a puro titolo di riferimento.

31 - 18

rel. 1511

Non original engine parts. OEMs names and part numbers are for reference purpose only.

RUGGERINI

RD 218	Cm³	CILINDRI CYLINDERS	ALESAGGIO BORE	CORSA STROKE	VERSIONE VERSION
	954	2	90	75	

	A2093	A2092			448.86	448.53	448.14	450.13
FIN111CGA	FIN111CGB	FIN085SM	FIN3218RT	FIN3218RT	FIN221CO	FIN704CB	FIN503IG	FIN504EG

 ADATTABILE A: SUITABLE FOR:	 FIN503HG	Nr.	ENGINE KIT	ELECTRIC KIT
		1	 FIN030SL00	
		1	 FIN198PC00	
		1	 FIN5252SM	
		A2398	FIN2132KIT	

388.54		359.26		175.23	175.24		
FIN458AF		FIN821NF		FIN4231FE	FIN102OF		

				2321			
				FIN480OP			

652.12	656.28	644.27	644.28	660.16	956.51		
FIN681FP	FIN221JP	FIN522NH	FIN051NO	FIN059E	FIN351DV		

	FIN003CN						

014.41	730.34	5840.142					
FIN140VA	FIN298VR	FIN142TL					

Ricambi non originali per motori. Denominazioni e codici originali, sono riportati a puro titolo di riferimento.

32 - 18

rel. 1511

Non original engine parts. OEMs names and part numbers are for reference purpose only.

RUGGERINI

RD 220	Cm³	CILINDRI CYLINDERS	ALESAGGIO BORE	CORSA STROKE	VERSIONE VERSION
	1081	2	90	85	

		TESTA HEAD	H14		3	2	TIPO TYPE	A	
		A	85		10	2			
		B	50		23	4			
		C	15						
		D	43						
		E	74						
FIN202PN		F	25				G	105	
854.11							H	165,6	
							I	98	
	90	A2407	FIN1513PC00	A2157	FIN072RS00		203.12	L	122,4
	90,5	A2408	FIN1513PC05	A2158	FIN072RS05			FIN028SL00	
	91	A2409	FIN1513PC10	A2159	FIN072RS10				

		Nr.							ADATTABILE A: SUITABLE FOR:	
--	--	------------	--	--	--	--	--	--	--------------------------------	--

CR	AL	2	45,00	48,01	24,12			STD - 025 - 050 - 075 - 100	A2638	FIN2260CR STD
----	----	---	-------	-------	-------	--	--	-----------------------------	-------	---------------

MB	AL	3	45,00	47,98	24,12			STD - 025 - 050 - 075 - 100 - BAR	A2649	FIN031MB STD
----	----	---	-------	-------	-------	--	--	-----------------------------------	-------	--------------

--	--	--	--	--	--	--	--	--	--	--

--	--	--	--	--	--	--	--	--	--	--

PB	BM	2	25,02	28,02	27,50			SEMIF.	316.41	FIN141PB
----	----	---	-------	-------	-------	--	--	--------	--------	----------

--	--	--	--	--	--	--	--	--	--	--

--	--	--	--	--	--	--	--	--	--	--

	IN EX		Nr.	O	P	M	N		ADATTABILE A: SUITABLE FOR:			
	IN		FN	2	37	7	105		45	A1	960.57	FINAS164
	EX		FN	2	37	7	105		45	A1	960.57	FINAS164

	IN EX		Nr.	R	S	T		ADATTABILE A: SUITABLE FOR:			
	IN		G	2	15,05	7,03		44	I	464.76	FIN6518ASA
	IN		G		15,15	7,03		44	I	464.58	FIN6518ASB
	EX		G	2	15,05	7,03		44	I	464.76	FIN6518ASA
	EX		G		15,15	7,03		44	I	464.58	FIN6518ASB

Ricambi non originali per motori. Denominazioni e codici originali, sono riportati a puro titolo di riferimento.

33 - 18

rel. 1511

Non original engine parts. OEMs names and part numbers are for reference purpose only.

RUGGERINI

RD 220	Cm³	CILINDRI CYLINDERS	ALESAGGIO BORE	CORSA STROKE	VERSIONE VERSION
	1081	2	90	85	

	2319	2400			448.86	448.53	448.52	448.51
FIN112CGA	FIN112CGB	FIN086SM	FIN3218RT	FIN3218RT	FIN221CO	FIN704CB	FIN622IG	FIN623EG

 	ADATTABILE A: SUITABLE FOR:		Nr.	ENGINE KIT	ELECTRIC KIT
	448.08	FIN6241HG	1	 FIN028SL00	
			1	 FIN1513PC00	
			1	 FIN5253SM	
				FIN2131KIT	

388.37		359.25		175.19	175.24		
FIN2330AF		FIN1051NF		FIN4240FE	FIN102OF		

100.23				2321			
FIN1065KR				FIN480OP			

652.12	656.29	644.43	644.46	660.17	956.27		
FIN681FP	FIN223JP	FIN524NH	FIN179NO	FIN011E	FIN016DV		

	FIN003CN						

014.09	730.13	5840.089					
FIN323VA	FIN238VR	FIN225TL					

Ricambi non originali per motori. Denominazioni e codici originali, sono riportati a puro titolo di riferimento.



34 - 18







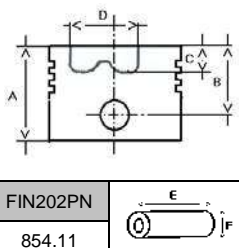

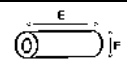
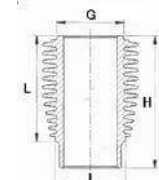
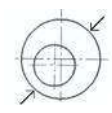
rel. 1511

Non original engine parts. OEMs names and part numbers are for reference purpose only.

RUGGERINI

RD 901 / 2	Cm³	CILINDRI CYLINDERS	ALESAGGIO BORE	CORSA STROKE	VERSIONE VERSION
	1081	2	90	85	

		TESTA HEAD	H14		3	2,5	TIPO TYPE	A	
		A	85		1	2,5		G	105
FIN202PN 854.11		B	50	2149 FIN071RS00	10	2,5		H	165,6
		C	15		2150 FIN071RS05	22		5	I
	90 2144 FIN195PC00	D	43	2151 FIN071RS10				L	122,4
		E	74				203.12	FIN028SL00	
		F	25						

		Nr.						ADATTABILE A: SUITABLE FOR:	
---	---	------------	---	---	---	---	---	--------------------------------	---

CR	AL	2	45,00	48,01	24,12		STD - 025 - 050 - 075 - 100 - BAR	316.36	FIN036CR STD
----	----	---	-------	-------	-------	--	-----------------------------------	--------	--------------

MB	AL	3	45,00	47,98	24,12		STD - 025 - 050 - 075 - 100 - BAR	310.31	FIN031MB STD
----	----	---	-------	-------	-------	--	-----------------------------------	--------	--------------





--	--	--	--	--	--	--	--	--	--



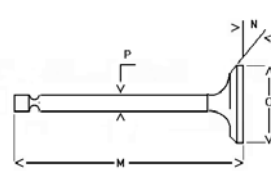

--	--	--	--	--	--	--	--	--	--

PB	BM	2	25,02	28,02	27,50		SEMIF.	316.41	FIN141PB
----	----	---	-------	-------	-------	--	--------	--------	----------

--	--	--	--	--	--	--	--	--	--

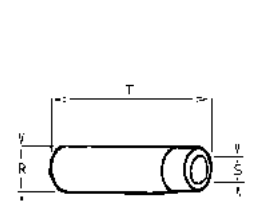
--	--	--	--	--	--	--	--	--	--

	IN EX		Nr.	O	P	M	N		ADATTABILE A: SUITABLE FOR:			
	IN		FS	2	37,6	9	105		45	E1	960.45	FINA124
	EX		FN	2	37	9	105		45	A1	960.46	FINS125

	IN EX		Nr.	R	S	T		ADATTABILE A: SUITABLE FOR:				
	IN		G	2	15,03	9,04		45	L	464.39	FIN203AA	
	IN		G		15,13	9,04		45	L	464.25	FIN203AB	
	EX		G	2	15,03	9,04		45	L	464.40	FIN204SA	
				EX	G		15,13	9,04	45	L	464.35	FIN204SB

Ricambi non originali per motori. Denominazioni e codici originali, sono riportati a puro titolo di riferimento.

35 - 18

rel. 1511

Non original engine parts. OEMs names and part numbers are for reference purpose only.

RUGGERINI

RD 901/2	Cm³	CILINDRI CYLINDERS	ALESAGGIO BORE	CORSA STROKE	VERSIONE VERSION
	1081	2	90	85	

	2319	2400			448.86	448.53	448.52	448.51
FIN112CGA	FIN112CGB	FIN086SM	FIN3218RT	FIN3218RT	FIN221CO	FIN704CB	FIN622IG	FIN623EG

 ADATTABILE A: SUITABLE FOR:		<table border="1"> <thead> <tr> <th>Nr.</th> <th>ENGINE KIT</th> </tr> </thead> <tbody> <tr> <td>1</td> <td> FIN028SL00</td> </tr> <tr> <td>1</td> <td> FIN195PC00</td> </tr> <tr> <td>1</td> <td> FIN5253SM</td> </tr> <tr> <td colspan="2">FIN3380KIT</td> </tr> </tbody> </table>	Nr.	ENGINE KIT	1	 FIN028SL00	1	 FIN195PC00	1	 FIN5253SM	FIN3380KIT		ELECTRIC KIT	
	Nr.		ENGINE KIT											
	1		 FIN028SL00											
	1		 FIN195PC00											
1	 FIN5253SM													
FIN3380KIT														
448.08	FIN6241HG													

388.37		359.25		175.19	175.24		
FIN2330AF		FIN1051NF		FIN4240FE	FIN102OF		

100.23				2321			
FIN1065KR				FIN480OP			

652.12	656.29	644.43	644.46	660.17	956.27		
FIN681FP	FIN223JP	FIN524NH	FIN179NO	FIN011E	FIN016DV		

014.09	730.13	5840.089					
FIN323VA	FIN238VR	FIN225TL					

Ricambi non originali per motori. Denominazioni e codici originali, sono riportati a puro titolo di riferimento.



36 - 18







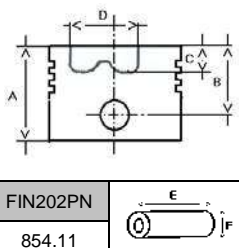

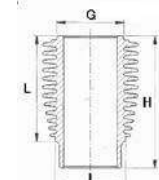
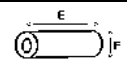
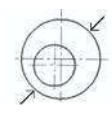
rel. 1511

Non original engine parts. OEMs names and part numbers are for reference purpose only.

RUGGERINI

RD 920	Cm³	CILINDRI CYLINDERS	ALESAGGIO BORE	CORSA STROKE	VERSIONE VERSION
		1	92	85	

		TESTA HEAD	H14		3	2,5	TIPO TYPE	A	
		A	100		10	2,5			G
FIN202PN		B	50	10	2,5	H	165,6		
854.11		C	15	22	5	I	98		
		D	44,2			L	122,4		
		E	74	2274	FIN074RS00	203.13		FIN031SL00	
		F	25	2275	FIN074RS05				
	92	2270	FIN199PC00	2276	FIN074RS10				
	92,5	2271	FIN199PC05						
	93	2272	FIN199PC10						

		Nr.						ADATTABILE A: SUITABLE FOR:	
---	---	------------	---	---	---	---	---	--------------------------------	---

CR	AL	1	45,00	48,01	24,12		STD - 025 - 050 - 075 - 100 - BAR	316.36	FIN036CR STD
----	----	---	-------	-------	-------	--	-----------------------------------	--------	--------------

MB	ALL	2	42,09	50,03	40,20		STD - 025 - 050 - 075 - 100 - BAR - BAR EM1	310.16	FIN016MB STD
----	-----	---	-------	-------	-------	--	---	--------	--------------





--	--	--	--	--	--	--	--	--	--



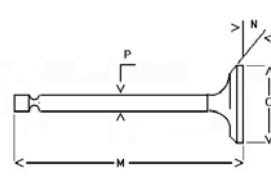

--	--	--	--	--	--	--	--	--	--

PB	BM	1	25,02	28,02	27,50		SEMIF.	316.41	FIN141PB
----	----	---	-------	-------	-------	--	--------	--------	----------

--	--	--	--	--	--	--	--	--	--

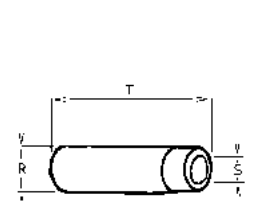
--	--	--	--	--	--	--	--	--	--

	IN EX		Nr.	O	P	M	N		ADATTABILE A: SUITABLE FOR:			
	IN		FS	1	37,6	9	105		45°	E1	960.45	FINA124
	EX		FN	1	37	9	105		45°	A1	960.46	FINS125

	IN EX		Nr.	R	S	T		ADATTABILE A: SUITABLE FOR:			
	IN		G	1	15,03	9,04		45	L	464.39	FIN203AA
	IN		G		15,13	9,04		45	L	464.25	FIN203AB
	EX		G	1	15,03	9,04		45	L	464.40	FIN204SA
	EX	G		15,13	9,04	45	L	464.35	FIN204SB		

Ricambi non originali per motori. Denominazioni e codici originali, sono riportati a puro titolo di riferimento.

37 - 18

rel. 1511

Non original engine parts. OEMs names and part numbers are for reference purpose only.

RUGGERINI

RD 920	Cm³	CILINDRI CYLINDERS	ALESAGGIO BORE	CORSA STROKE	VERSIONE VERSION
		1	92	85	

	2140	2394			447.76	447.79	448.14	448.14
FIN110CGA	FIN110CGB	FIN084SM	FIN3216RT	FIN3215RT	FIN206CO	FIN281CB	FIN503IG	FIN503IG

 	ADATTABILE A: SUITABLE FOR:		Nr.	ENGINE KIT	ELECTRIC KIT
	448.08	FIN6241HG	1	 FIN031SL00	
			1	 FIN199PC00	
			1	 FIN084SM	
				FIN3348KIT	

387.39		359.13		175.20	175.05		
FIN2208AF		FIN1033NF		FIN4232FE	FIN4225OF		

100.23				2122			
FIN1065KR				FIN022OP			

	656.03		644.07	660.07	956.05		
	FIN708JP		FIN114NO	FIN074E	FIN016DV		

696.54		890.02					
FIN052PU	FIN003CN	FIN303ST					

			526.66				
			FIN113SI				

Ricambi non originali per motori. Denominazioni e codici originali, sono riportati a puro titolo di riferimento.



38 - 18







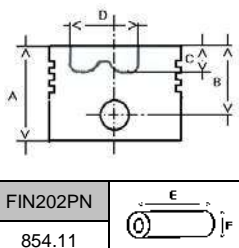

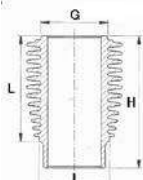
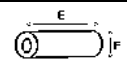
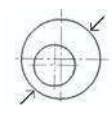
rel. 1511

Non original engine parts. OEMs names and part numbers are for reference purpose only.

RUGGERINI

RD 920 L	Cm³	CILINDRI CYLINDERS	ALESAGGIO BORE	CORSA STROKE	VERSIONE VERSION
		1	92	85	

		TESTA HEAD	H14		3	2,5	TIPO TYPE	A	
		A	100		10	2,5			G
FIN202PN		B	50	10	2,5	H	165,6		L
854.11		C	15	22	5	I	98		
		D	44,2						
		E	74						
		F	25						
	92	2270	FIN199PC00	2274	FIN074RS00	203.13		FIN031SL00	
	92,5	2271	FIN199PC05	2275	FIN074RS05				
	93	2272	FIN199PC10	2276	FIN074RS10				

		Nr.						ADATTABILE A: SUITABLE FOR:	
---	---	------------	---	---	---	---	---	--------------------------------	---

CR	AL	1	45,00	48,01	24,12		STD - 025 - 050 - 075 - 100 - BAR	316.36	FIN036CR STD
----	----	---	-------	-------	-------	--	-----------------------------------	--------	--------------

MB	ALL	2	42,09	50,03	40,20		STD - 025 - 050 - 075 - 100 - BAR - BAR EM1	310.16	FIN016MB STD
----	-----	---	-------	-------	-------	--	---	--------	--------------





--	--	--	--	--	--	--	--	--	--



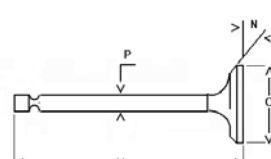

--	--	--	--	--	--	--	--	--	--

PB	BM	1	25,02	28,02	27,50		SEMIF.	316.41	FIN141PB
----	----	---	-------	-------	-------	--	--------	--------	----------

--	--	--	--	--	--	--	--	--	--

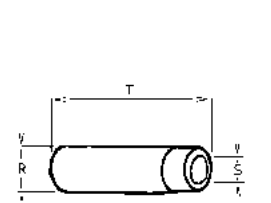
--	--	--	--	--	--	--	--	--	--

	IN EX		Nr.	O	P	M	N		ADATTABILE A: SUITABLE FOR:			
	IN		FS	1	37,6	9	105		45°	E1	960.45	FINA124
	EX		FN	1	37	9	105		45°	A1	960.46	FINS125

	IN EX		Nr.	R	S	T		ADATTABILE A: SUITABLE FOR:			
	IN		G	1	15,03	9,04		45	L	464.39	FIN203AA
	IN		G		15,13	9,04		45	L	464.25	FIN203AB
	EX		G	1	15,03	9,04		45	L	464.40	FIN204SA
	EX	G		15,13	9,04	45	L	464.35	FIN204SB		

Ricambi non originali per motori. Denominazioni e codici originali, sono riportati a puro titolo di riferimento.

39 - 18

rel. 1511

Non original engine parts. OEMs names and part numbers are for reference purpose only.

RUGGERINI

RD 920 L	Cm³	CILINDRI CYLINDERS	ALESAGGIO BORE	CORSA STROKE	VERSIONE VERSION
		1	92	85	

	2140	2394			447.76	447.79	448.14	448.14
FIN110CGA	FIN110CGB	FIN084SM	FIN3216RT	FIN3215RT	FIN206CO	FIN281CB	FIN503IG	FIN503IG

 	ADATTABILE A: SUITABLE FOR:		Nr.	ENGINE KIT	ELECTRIC KIT
	448.08	FIN6241HG	1	 FIN031SL00	
			1	 FIN199PC00	
			1	 FIN084SM	
				FIN3348KIT	

387.39		359.13		175.20	175.05		
FIN2208AF		FIN1033NF		FIN4232FE	FIN4225OF		

100.23				2122			
FIN1065KR				FIN022OP			

	656.14		644.11	660.06	956.05		
	FIN709JP		FIN176NO	FIN068E	FIN016DV		

696.54		890.02					
FIN052PU	FIN003CN	FIN303ST					

			526.66				
			FIN113SI				

Ricambi non originali per motori. Denominazioni e codici originali, sono riportati a puro titolo di riferimento.







40 - 18



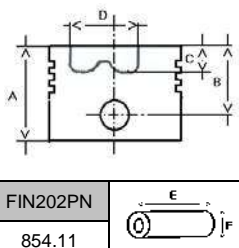

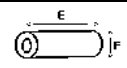

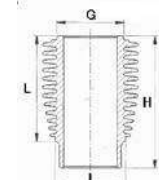
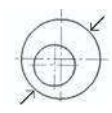
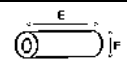

rel. 1511

Non original engine parts. OEMs names and part numbers are for reference purpose only.

RUGGERINI

RD 240	Cm³	CILINDRI CYLINDERS	ALESAGGIO BORE	CORSA STROKE	VERSIONE VERSION
	1130	2	92	85	

		TESTA HEAD	H14		3	2,5	TIPO TYPE	A	
		A	100		10	2,5			
FIN202PN 854.11		B	50		10	2,5		G	105
		C	15		22	5		H	165,6
		D	44,2				203.13	I	98
		E	74		2274	FIN074RS00		L	122,4
		F	25		2275	FIN074RS05		FIN031SL00	
92	2270	FIN199PC00	2276	FIN074RS10					
92,5	2271	FIN199PC05							
93	2272	FIN199PC10							

		Nr.						ADATTABILE A: SUITABLE FOR:	
---	---	------------	---	---	---	---	---	--------------------------------	---

CR	AL	2	45,00	48,01	24,12		STD - 025 - 050 - 075 - 100	A2638	FIN2260CR STD
----	----	---	-------	-------	-------	--	-----------------------------	-------	---------------

MB	AL	3	45,00	47,98	24,12		STD - 025 - 050 - 075 - 100 - BAR	A2649	FIN031MB STD
----	----	---	-------	-------	-------	--	-----------------------------------	-------	--------------





--	--	--	--	--	--	--	--	--	--



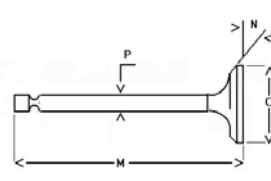

--	--	--	--	--	--	--	--	--	--

PB	BM	2	25,02	28,02	27,50		SEMIF.	316.41	FIN141PB
----	----	---	-------	-------	-------	--	--------	--------	----------

--	--	--	--	--	--	--	--	--	--

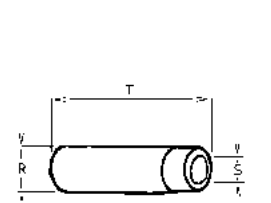
--	--	--	--	--	--	--	--	--	--

	IN EX		Nr.	O	P	M	N		ADATTABILE A: SUITABLE FOR:				
	IN		FN	2	37	7	105		45		A1	960.57	FINAS164
	EX		FN	2	37	7	105		45		A1	960.57	FINAS164

	IN EX		Nr.	R	S	T		ADATTABILE A: SUITABLE FOR:				
	IN		G	2	15,05	7,03		44		I	464.76	FIN6518ASA
	IN		G		15,15	7,03		44		I	464.58	FIN6518ASB
	EX		G	2	15,05	7,03		44		I	464.76	FIN6518ASA
EX	G		15,15	7,03	44	I	464.58	FIN6518ASB				

Ricambi non originali per motori. Denominazioni e codici originali, sono riportati a puro titolo di riferimento.

41 - 18

rel. 1511

Non original engine parts. OEMs names and part numbers are for reference purpose only.

RUGGERINI

RD 240	Cm³	CILINDRI CYLINDERS	ALESAGGIO BORE	CORSA STROKE	VERSIONE VERSION
	1130	2	92	85	

	2319	2400			448.86	448.53	448.52	448.51
FIN112CGA	FIN112CGB	FIN086SM	FIN3218RT	FIN3218RT	FIN221CO	FIN704CB	FIN622IG	FIN623EG

 ADATTABILE A: SUITABLE FOR:	 FIN6241HG	Nr.	ENGINE KIT	ELECTRIC KIT
		1	 FIN031SL00	
		1	 FIN199PC00	
		1	 FIN5253SM	
		FIN0937KIT		

388.37		359.25		175.19	175.24		
FIN2330AF		FIN1051NF		FIN4240FE	FIN102OF		

100.23				2321			
FIN1065KR				FIN480OP			

652.12	656.29	644.43	644.46	660.17	956.27		
FIN681FP	FIN223JP	FIN524NH	FIN179NO	FIN011E	FIN016DV		

	FIN003CN						

014.09	730.13	5840.089					
FIN323VA	FIN238VR	FIN225TL					

Ricambi non originali per motori. Denominazioni e codici originali, sono riportati a puro titolo di riferimento.



42 - 18







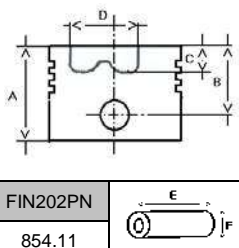

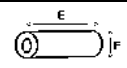
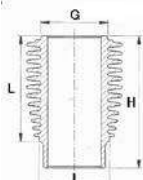
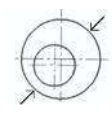
rel. 1511

Non original engine parts. OEMs names and part numbers are for reference purpose only.

RUGGERINI

RD 248	Cm³	CILINDRI CYLINDERS	ALESAGGIO BORE	CORSA STROKE	VERSIONE VERSION
	1130	2	92	85	

		TESTA HEAD	H14		3	2,5	TIPO TYPE	A	
		A	100		10	2,5		G	105
FIN202PN 854.11		B	50	2274	FIN074RS00		H	165,6	
		C	15				2275	FIN074RS05	I
	92	2270	FIN199PC00	2276	FIN074RS10	203.13	L	122,4	
			92,5				2271	FIN199PC05	FIN031SL00
	93	2272	FIN199PC10						

		Nr.						ADATTABILE A: SUITABLE FOR:	
---	---	------------	---	---	---	---	--	--------------------------------	---

CR	AL	2	45,00	48,01	24,12		STD - 025 - 050 - 075 - 100 - BAR	316.36	FIN036CR STD
----	----	---	-------	-------	-------	--	-----------------------------------	--------	--------------

MB	AL	3	45,00	47,98	24,12		STD - 025 - 050 - 075 - 100 - BAR	A2649	FIN031MB STD
----	----	---	-------	-------	-------	--	-----------------------------------	-------	--------------





--	--	--	--	--	--	--	--	--	--



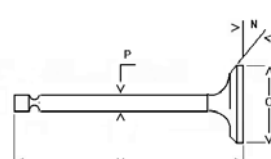

--	--	--	--	--	--	--	--	--	--

PB	BM	2	25,02	28,02	27,50		SEMIF.	316.41	FIN141PB
----	----	---	-------	-------	-------	--	--------	--------	----------

--	--	--	--	--	--	--	--	--	--

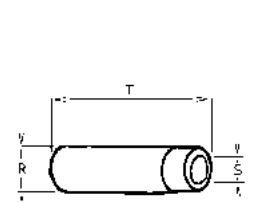
--	--	--	--	--	--	--	--	--	--

	IN EX		Nr.	O	P	M	N		ADATTABILE A: SUITABLE FOR:			
	IN		FS	2	37,6	9	105		45	E1	960.45	FINA124
	EX		FN	2	37	9	105		45	A1	960.46	FINS125

	IN EX		Nr.	R	S	T		ADATTABILE A: SUITABLE FOR:			
	IN		G	2	15,03	9,04		45	L	464.39	FIN203AA
	IN		G		15,13	9,04		45	L	464.25	FIN203AB
	EX		G	2	15,03	9,04		45	L	464.40	FIN204SA
	EX		G		15,13	9,04		45	L	464.35	FIN204SB

Ricambi non originali per motori. Denominazioni e codici originali, sono riportati a puro titolo di riferimento.

43 - 18

rel. 1511

Non original engine parts. OEMs names and part numbers are for reference purpose only.

RUGGERINI

RD 248	Cm³	CILINDRI CYLINDERS	ALESAGGIO BORE	CORSA STROKE	VERSIONE VERSION
	1130	2	92	85	

	2319	2400			448.86	448.53	448.52	448.51
FIN112CGA	FIN112CGB	FIN086SM	FIN3218RT	FIN3218RT	FIN221CO	FIN704CB	FIN622IG	FIN623EG

 ADATTABILE A: SUITABLE FOR:	 FIN6241HG	Nr.	ENGINE KIT	ELECTRIC KIT
		1	 FIN031SL00	
		1	 FIN199PC00	
		1	 FIN5253SM	
			FIN0937KIT	

388.37		359.25		175.19	175.24		
FIN2330AF		FIN1051NF		FIN4240FE	FIN102OF		

100.23				2321			
FIN1065KR				FIN480OP			

652.12	656.29	644.43	644.46	660.17	956.27		
FIN681FP	FIN223JP	FIN524NH	FIN179NO	FIN011E	FIN016DV		

696.78							
FIN038PU	FIN003CN						

014.09	730.13	5840.089					
FIN323VA	FIN238VR	FIN225TL					

Ricambi non originali per motori. Denominazioni e codici originali, sono riportati a puro titolo di riferimento.



44 - 18







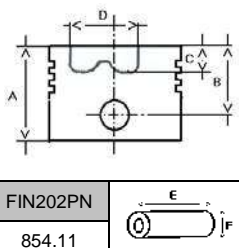

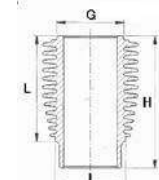
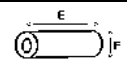
rel. 1511

Non original engine parts. OEMs names and part numbers are for reference purpose only.

RUGGERINI

RD 92 / 2	Cm³	CILINDRI CYLINDERS	ALESAGGIO BORE	CORSA STROKE	VERSIONE VERSION
	1130	2	92	85	

		TESTA HEAD	H14		3	2,5	TIPO TYPE	A	
		A	100		10	2,5			G
B	50	10	2,5	H	165,6				
C	15	22	5	I	98				
D	44,2			L	122,4				
FIN202PN		E	74	2274	FIN074RS00		203.13		FIN031SL00
854.11		F	25	2275	FIN074RS05				
92	2270	FIN199PC00		2276	FIN074RS10				
92,5	2271	FIN199PC05							
93	2272	FIN199PC10							

		Nr.						ADATTABILE A: SUITABLE FOR:	
--	---	------------	---	---	---	---	---	--------------------------------	---

CR	AL	2	45,00	48,01	24,12		STD - 025 - 050 - 075 - 100 - BAR	316.36	FIN036CR STD
----	----	---	-------	-------	-------	--	-----------------------------------	--------	--------------

MB	ALL	3	45,00	47,98	24,12		STD - 025 - 050 - 075 - 100 - BAR	310.31	FIN031MB STD
----	-----	---	-------	-------	-------	--	-----------------------------------	--------	--------------





--	--	--	--	--	--	--	--	--	--



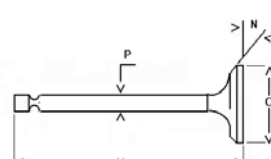

--	--	--	--	--	--	--	--	--	--

PB	BM	2	25,02	28,02	27,50		SEMIF.	316.41	FIN141PB
----	----	---	-------	-------	-------	--	--------	--------	----------

--	--	--	--	--	--	--	--	--	--

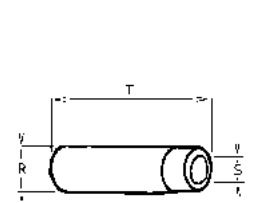
--	--	--	--	--	--	--	--	--	--

	IN EX		Nr.	O	P	M	N		ADATTABILE A: SUITABLE FOR:			
	IN		FS	2	37,6	9	105		45°	E1	960.45	FINA124
	EX		FN	2	37	9	105		45°	A1	960.46	FINS125

	IN EX		Nr.	R	S	T		ADATTABILE A: SUITABLE FOR:			
	IN		G	2	15,03	9,04		45	L	464.39	FIN203AA
	IN		G		15,13	9,04		45	L	464.25	FIN203AB
	EX		G	2	15,03	9,04		45	L	464.40	FIN204SA
	EX		G		15,13	9,04		45	L	464.35	FIN204SB

Ricambi non originali per motori. Denominazioni e codici originali, sono riportati a puro titolo di riferimento.

45 - 18

rel. 1511

Non original engine parts. OEMs names and part numbers are for reference purpose only.

RUGGERINI

RD 92/2	Cm³	CILINDRI CYLINDERS	ALESAGGIO BORE	CORSA STROKE	VERSIONE VERSION
	1130	2	92	85	

	2319	2400			448.86	448.53	448.52	448.51
FIN112CGA	FIN112CGB	FIN086SM	FIN3218RT	FIN3218RT	FIN221CO	FIN704CB	FIN622IG	FIN623EG

 ADATTABILE A: SUITABLE FOR:		<table border="1"> <tr> <th>Nr.</th> <th>ENGINE KIT</th> </tr> <tr> <td>1</td> <td> FIN031SL00</td> </tr> <tr> <td>1</td> <td> FIN199PC00</td> </tr> <tr> <td>1</td> <td> FIN5253SM</td> </tr> <tr> <td colspan="2">FIN0937KIT</td> </tr> </table>	Nr.	ENGINE KIT	1	 FIN031SL00	1	 FIN199PC00	1	 FIN5253SM	FIN0937KIT		<table border="1"> <tr> <th colspan="2">ELECTRIC KIT</th> </tr> <tr> <td colspan="2"> </td> </tr> </table>		ELECTRIC KIT			
	Nr.		ENGINE KIT															
	1		 FIN031SL00															
	1		 FIN199PC00															
1	 FIN5253SM																	
FIN0937KIT																		
ELECTRIC KIT																		
448.08	FIN6241HG																	

388.37		359.25		175.19	175.24		
FIN2330AF		FIN1051NF		FIN4240FE	FIN102OF		

100.23				2321			
FIN1065KR				FIN480OP			

652.12	656.29	644.43	644.46	660.17	956.27		
FIN681FP	FIN223JP	FIN524NH	FIN179NO	FIN011E	FIN016DV		

014.09	730.13	5840.089					
FIN323VA	FIN238VR	FIN225TL					

Ricambi non originali per motori. Denominazioni e codici originali, sono riportati a puro titolo di riferimento.



46 - 18







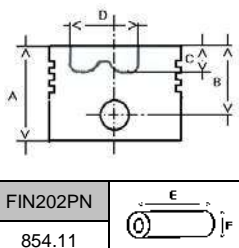

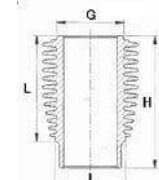
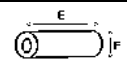
rel. 1511

Non original engine parts. OEMs names and part numbers are for reference purpose only.

RUGGERINI

RD 92 / 2 L	Cm³	CILINDRI CYLINDERS	ALESAGGIO BORE	CORSA STROKE	VERSIONE VERSION
	1130	2	92	85	

		TESTA HEAD	H14		3	2,5	TIPO TYPE	A	
		A	100		10	2,5			G
B	50	10	2,5	H	165,6				
C	15	22	5	I	98				
D	44,2			L	122,4				
FIN202PN		E	74	2274	FIN074RS00		203.13		FIN031SL00
854.11		F	25	2275	FIN074RS05				
92	2270	FIN199PC00		2276	FIN074RS10				
92,5	2271	FIN199PC05							
93	2272	FIN199PC10							

		Nr.						ADATTABILE A: SUITABLE FOR:	
---	---	------------	---	---	---	---	---	--------------------------------	---

CR	AL	2	45,00	48,01	24,12		STD - 025 - 050 - 075 - 100 - BAR	316.36	FIN036CR STD
----	----	---	-------	-------	-------	--	--------------------------------------	--------	--------------

MB	ALL	3	45,00	47,98	24,12		STD - 025 - 050 - 075 - 100 - BAR	310.31	FIN031MB STD
----	-----	---	-------	-------	-------	--	--------------------------------------	--------	--------------





--	--	--	--	--	--	--	--	--	--



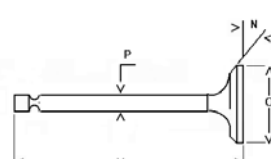

--	--	--	--	--	--	--	--	--	--

PB	BM	2	25,02	28,02	27,50		SEMIF.	316.41	FIN141PB
----	----	---	-------	-------	-------	--	--------	--------	----------

--	--	--	--	--	--	--	--	--	--

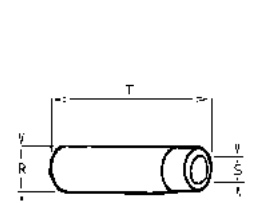
--	--	--	--	--	--	--	--	--	--

	IN EX		Nr.	O	P	M	N		ADATTABILE A: SUITABLE FOR:				
	IN		FS	2	37,6	9	105		45°		E1	960.45	FINA124
	EX		FN	2	37	9	105		45°		A1	960.46	FINS125

	IN EX		Nr.	R	S	T		ADATTABILE A: SUITABLE FOR:				
	IN		G	2	15,03	9,04		45		L	464.39	FIN203AA
	IN		G		15,13	9,04		45		L	464.25	FIN203AB
	EX		G	2	15,03	9,04		45		L	464.40	FIN204SA
	EX		G		15,13	9,04		45		L	464.35	FIN204SB

Ricambi non originali per motori. Denominazioni e codici originali, sono riportati a puro titolo di riferimento.

47 - 18

rel. 1511

Non original engine parts. OEMs names and part numbers are for reference purpose only.

RUGGERINI

RD 92/2 L	Cm³	CILINDRI CYLINDERS	ALESAGGIO BORE	CORSA STROKE	VERSIONE VERSION
	1130	2	92	85	

	2319	2400			448.86	448.53	448.52	448.51
FIN112CGA	FIN112CGB	FIN086SM	FIN3218RT	FIN3218RT	FIN221CO	FIN704CB	FIN622IG	FIN623EG

 	ADATTABILE A: SUITABLE FOR:		Nr.	ENGINE KIT	ELECTRIC KIT
	448.08	FIN6241HG	1	 FIN031SL00	
			1	 FIN199PC00	
			1	 FIN5253SM	
				FIN0937KIT	

388.37		359.25		175.19	175.24		
FIN2330AF		FIN1051NF		FIN4240FE	FIN102OF		

100.23				2321			
FIN1065KR				FIN480OP			

652.12	656.15		644.26	660.06	956.27		
FIN681FP	FIN234JP		FIN114NO	FIN068E	FIN016DV		

	730.13						
	FIN238VR						

Ricambi non originali per motori. Denominazioni e codici originali, sono riportati a puro titolo di riferimento.







48 - 18



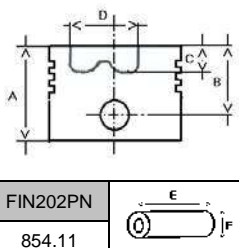

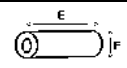

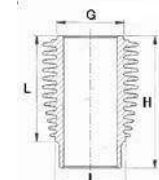

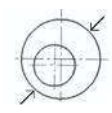
rel. 1511

Non original engine parts. OEMs names and part numbers are for reference purpose only.

RUGGERINI

RD 950	Cm³	CILINDRI CYLINDERS	ALESAGGIO BORE	CORSA STROKE	VERSIONE VERSION
		1	95	95	

		TESTA HEAD	H27		3	2,5	TIPO TYPE	A	
		A	95		1	2,5			
FIN202PN 854.11		B	50		10	2,5		G	105
		C	16,8			21		5,5	H
		D	43					I	100
		E	74		2495	FIN076RS00	L	122,4	
		F	25		2496	FIN076RS05			
95	2492	FIN202PC00	2497	FIN076RS10					
95,5	2493	FIN202PC05							
96	2494	FIN202PC10			203.42	FIN033SL00			

		Nr.						ADATTABILE A: SUITABLE FOR:	
---	---	------------	---	---	---	---	---	--------------------------------	---

CR	AL	1	45,00	48,01	24,12		STD - 025 - 050 - 075 - 100 - BAR	316.36	FIN036CR STD
----	----	---	-------	-------	-------	--	-----------------------------------	--------	--------------

MB	ALL	2	42,09	50,03	40,20		STD - 025 - 050 - 075 - 100 - BAR - BAR EM1	310.16	FIN016MB STD
----	-----	---	-------	-------	-------	--	---	--------	--------------





--	--	--	--	--	--	--	--	--	--



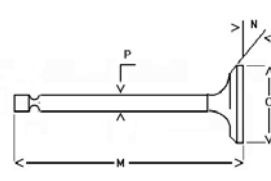

--	--	--	--	--	--	--	--	--	--

PB	BM	1	25,02	28,02	27,50		SEMIF.	316.41	FIN141PB
----	----	---	-------	-------	-------	--	--------	--------	----------

--	--	--	--	--	--	--	--	--	--

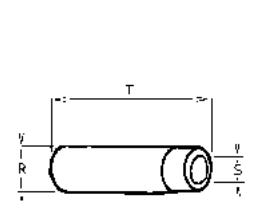
--	--	--	--	--	--	--	--	--	--

	IN EX		Nr.	O	P	M	N		ADATTABILE A: SUITABLE FOR:	
	IN	FS	1	37,6	9	105	45°	E1	960.45	FINA124
	EX	FN	1	37	9	105	45°	A1	960.46	FINS125

	IN EX		Nr.	R	S	T		ADATTABILE A: SUITABLE FOR:	
	IN	G	1	15,03	9,04	45	L	464.39	FIN203AA
	IN	G		15,13	9,04	45	L	464.25	FIN203AB
	EX	G	1	15,03	9,04	45	L	464.40	FIN204SA
EX	G		15,13	9,04	45	L	464.35	FIN204SB	

Ricambi non originali per motori. Denominazioni e codici originali, sono riportati a puro titolo di riferimento.

49 - 18

rel. 1511

Non original engine parts. OEMs names and part numbers are for reference purpose only.

RUGGERINI

RD 950	Cm³	CILINDRI CYLINDERS	ALESAGGIO BORE	CORSA STROKE	VERSIONE VERSION
		1	95	95	

	2482	2483			447.76	447.79	448.14	448.14
FIN115CGA	FIN115CGB	FIN089SM	FIN3216RT	FIN3215RT	FIN206CO	FIN281CB	FIN503IG	FIN503IG

 	ADATTABILE A: SUITABLE FOR:		Nr.	ENGINE KIT	ELECTRIC KIT
	449.52	FIN625HG	1	 FIN033SL00	
			1	 FIN202PC00	
			1	 FIN089SM	
				FIN3245KIT	

387.56		359.13		175.20	175.05		
FIN2214AF		FIN1033NF		FIN4232FE	FIN4225OF		

100.23				2122			
FIN1065KR				FIN022OP			

	653.03		644.07	660.07	956.05		
	FIN703JP		FIN114NO	FIN074E	FIN016DV		

696.54		890.02					
FIN052PU	FIN003CN	FIN303ST					

			526.66				
			FIN113SI				

Ricambi non originali per motori. Denominazioni e codici originali, sono riportati a puro titolo di riferimento.



50 - 18







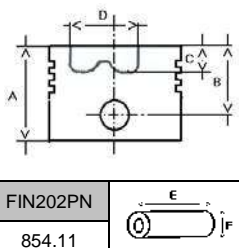

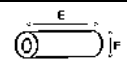
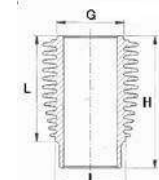
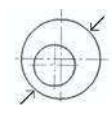
rel. 1511

Non original engine parts. OEMs names and part numbers are for reference purpose only.

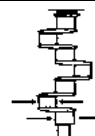
RUGGERINI

RD 950 L	Cm³	CILINDRI CYLINDERS	ALESAGGIO BORE	CORSA STROKE	VERSIONE VERSION
		1	95	95	

		TESTA HEAD	H27		3	2,5	TIPO TYPE	A	
		A	95		1	2,5			
		B	50		10	2,5			
		C	16,8		21	5,5			
		D	43						
		E	74						
FIN202PN		F	25					G	105
854.11								H	165,6
								I	100
	95	2492	FIN202PC00		2495	FIN076RS00	203.42	L	122,4
	95,5	2493	FIN202PC05		2496	FIN076RS05		FIN033SL00	
	96	2494	FIN202PC10		2497	FIN076RS10			

		Nr.							ADATTABILE A: SUITABLE FOR:	
---	---	------------	---	---	---	---	---	--	--------------------------------	---

CR	AL	1	45,00	48,01	24,12			STD - 025 - 050 - 075 - 100 - BAR	316.36	FIN036CR STD
----	----	---	-------	-------	-------	--	--	-----------------------------------	--------	--------------

MB	ALL	2	42,09	50,03	40,20			STD - 025 - 050 - 075 - 100 - BAR - BAR EM1	310.16	FIN016MB STD
----	-----	---	-------	-------	-------	--	--	---	--------	--------------





--	--	--	--	--	--	--	--	--	--	--



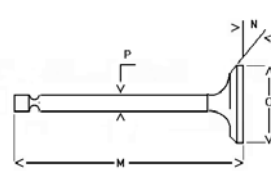

--	--	--	--	--	--	--	--	--	--	--

PB	BM	1	25,02	28,02	27,50			SEMIF.	316.41	FIN141PB
----	----	---	-------	-------	-------	--	--	--------	--------	----------

--	--	--	--	--	--	--	--	--	--	--

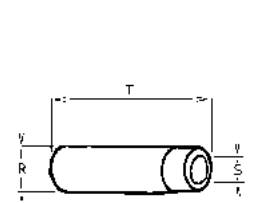
--	--	--	--	--	--	--	--	--	--	--

	IN EX		Nr.	O	P	M	N		ADATTABILE A: SUITABLE FOR:				
	IN		FS	1	37,6	9	105		45°		E1	960.45	FINA124
	EX		FN	1	37	9	105		45°		A1	960.46	FINS125

	IN EX		Nr.	R	S	T		ADATTABILE A: SUITABLE FOR:				
	IN		G	1	15,03	9,04		45		L	464.39	FIN203AA
	IN		G		15,13	9,04		45		L	464.25	FIN203AB
	EX		G	1	15,03	9,04		45		L	464.40	FIN204SA
	EX		G		15,13	9,04		45		L	464.35	FIN204SB

Ricambi non originali per motori. Denominazioni e codici originali, sono riportati a puro titolo di riferimento.

51 - 18

rel. 1511

Non original engine parts. OEMs names and part numbers are for reference purpose only.

RUGGERINI

RD 950 L	Cm³	CILINDRI CYLINDERS	ALESAGGIO BORE	CORSA STROKE	VERSIONE VERSION
		1	95	95	

	2482	2483			447.76	447.79	448.14	448.14
FIN115CGA	FIN115CGB	FIN089SM	FIN3216RT	FIN3215RT	FIN206CO	FIN281CB	FIN503IG	FIN503IG

 	ADATTABILE A: SUITABLE FOR:		Nr.	ENGINE KIT	ELECTRIC KIT
	449.52	FIN625HG	1	 FIN033SL00	
			1	 FIN202PC00	
			1	 FIN089SM	
				FIN3245KIT	

387.56		359.13		175.20	175.05		
FIN2214AF		FIN1033NF		FIN4232FE	FIN4225OF		

100.23				2122			
FIN1065KR				FIN022OP			

	656.14		644.11	660.06	956.05		
	FIN709JP		FIN176NO	FIN068E	FIN016DV		

696.54		890.02					
FIN052PU	FIN003CN	FIN303ST					

			526.66				
			FIN113SI				

Ricambi non originali per motori. Denominazioni e codici originali, sono riportati a puro titolo di riferimento.



52 - 18







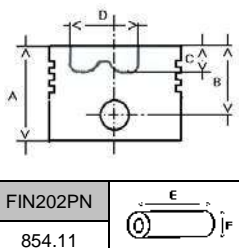

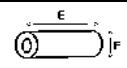
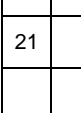
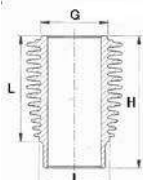
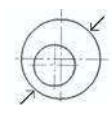
rel. 1511

Non original engine parts. OEMs names and part numbers are for reference purpose only.

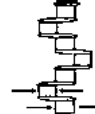
RUGGERINI

RD 270	Cm³	CILINDRI CYLINDERS	ALESAGGIO BORE	CORSA STROKE	VERSIONE VERSION
	1205	2	95	85	

		TESTA HEAD	H27		3	2,5	TIPO TYPE	A				
		A	95		1	2,5						
FIN202PN 854.11		B	50		10	2,5		G	105			
		C	16,8		21	5,5		H	165,6			
		D	43	2495		FIN076RS00	20368		I	100		
		E	74						2496	FIN076RS05	L	122,4
		F	25								2497	FIN076RS10
95	2492	FIN202PC00										
95,5	2493	FIN202PC05										
96	2494	FIN202PC10										

		Nr.						ADATTABILE A: SUITABLE FOR:	
---	---	------------	---	---	---	---	---	--------------------------------	---

CR	AL	2	45	48,01	24,12		STD - 025 - 050 - 075 - 100	A2638	FIN2260CR STD
----	----	---	----	-------	-------	--	-----------------------------	-------	---------------

MB	AL	3	45,00	47,98	24,12		STD - 025 - 050 - 075 - 100 - BAR	A2649	FIN031MB STD
----	----	---	-------	-------	-------	--	-----------------------------------	-------	--------------





--	--	--	--	--	--	--	--	--	--



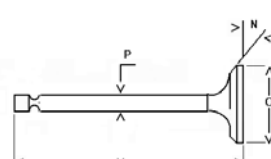

--	--	--	--	--	--	--	--	--	--

PB	BM	2	25,02	28,02	27,50		SEMIF.	316.41	FIN141PB
----	----	---	-------	-------	-------	--	--------	--------	----------

--	--	--	--	--	--	--	--	--	--

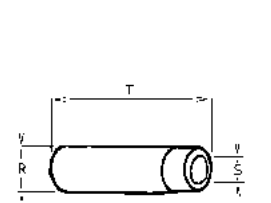
--	--	--	--	--	--	--	--	--	--

	IN EX		Nr.	O	P	M	N		ADATTABILE A: SUITABLE FOR:				
	IN		FN	2	37	7	105		45°		A1	960.57	FINAS164
	EX		FN	2	37	7	105		45°		A1	960.57	FINAS164

	IN EX		Nr.	R	S	T		ADATTABILE A: SUITABLE FOR:				
	IN		G	2	15,05	7,05		44		I	464.76	FIN6518ASA
	IN		G		15,15	7,05		44		I	464.58	FIN6518ASB
	EX		G	2	15,05	7,05		44		I	464.76	FIN6518ASA
EX	G		15,15	7,05	44	I	464.58	FIN6518ASB				

Ricambi non originali per motori. Denominazioni e codici originali, sono riportati a puro titolo di riferimento.

53 - 18

rel. 1511

Non original engine parts. OEMs names and part numbers are for reference purpose only.

RUGGERINI

RD 270	Cm³	CILINDRI CYLINDERS	ALESAGGIO BORE	CORSA STROKE	VERSIONE VERSION
	1205	2	95	85	

	2472	2473			448.86	448.53	448.52	448.51
FIN114CGA	FIN114CGB	FIN088SM	FIN3218RT	FIN3218RT	FIN221CO	FIN704CB	FIN622IG	FIN623EG

 	ADATTABILE A: SUITABLE FOR:		Nr.	ENGINE KIT	ELECTRIC KIT
	449.52	FIN625HG	1	 FIN032SL00	
			1	 FIN202PC00	
			1	 FIN5254SM	
				FIN2134KIT	

388.37		359.25		175.19	175.24		
FIN2330AF		FIN1051NF		FIN4240FE	FIN102OF		

100.23				2321			
FIN1065KR				FIN480OP			

652.12	656.29	644.43	644.46	660.17	956.27		
FIN681FP	FIN223JP	FIN524NH	FIN179NO	FIN011E	FIN016DV		

	FIN003CN						

014.09	730.13	5840.089					
FIN323VA	FIN238VR	FIN225TL					

Ricambi non originali per motori. Denominazioni e codici originali, sono riportati a puro titolo di riferimento.







54 - 18



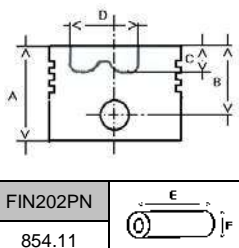

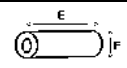

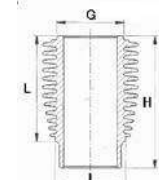
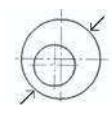
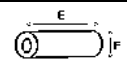

rel. 1511

Non original engine parts. OEMs names and part numbers are for reference purpose only.

RUGGERINI

RD 278	Cm³	CILINDRI CYLINDERS	ALESAGGIO BORE	CORSA STROKE	VERSIONE VERSION
	1205	2	95	85	

		TESTA HEAD	H27		3	2,5	TIPO TYPE	A	
		A	95		1	2,5			
FIN202PN 854.11		B	50		10	2,5		G	105
		C	16,8		21	5,5		H	165,6
		D	43				20368	I	100
		E	74		2495	FIN076RS00		L	122,4
		F	25		2496	FIN076RS05		FIN032SL00	
95	2492	FIN202PC00	2497	FIN076RS10					
95,5	2493	FIN202PC05							
96	2494	FIN202PC10							

		Nr.						ADATTABILE A: SUITABLE FOR:	
---	---	------------	---	---	---	---	---	--	---

CR	AL	2	45	48,01	24,12		STD - 025 - 050 - 075 - 100	A2638	FIN2260CR STD
----	----	---	----	-------	-------	--	-----------------------------	-------	---------------

MB	AL	3	45,00	47,98	24,12		STD - 025 - 050 - 075 - 100 - BAR	A2649	FIN031MB STD
----	----	---	-------	-------	-------	--	-----------------------------------	-------	--------------





--	--	--	--	--	--	--	--	--	--



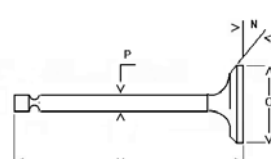

--	--	--	--	--	--	--	--	--	--

PB	BM	2	25,02	28,02	27,50		SEMIF.	316.41	FIN141PB
----	----	---	-------	-------	-------	--	--------	--------	----------

--	--	--	--	--	--	--	--	--	--

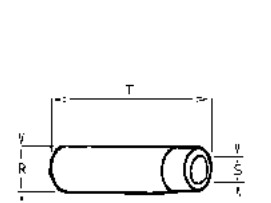
--	--	--	--	--	--	--	--	--	--

	IN EX		Nr.	O	P	M	N		ADATTABILE A: SUITABLE FOR:				
	IN		FN	2	37	7	105		45°		A1	960.57	FINAS164
	EX		FN	2	37	7	105		45°		A1	960.57	FINAS164

	IN EX		Nr.	R	S	T		ADATTABILE A: SUITABLE FOR:				
	IN		G	2	15,05	7,05		44		I	464.76	FIN6518ASA
	IN		G		15,15	7,05		44		I	464.58	FIN6518ASB
	EX		G	2	15,05	7,05		44		I	464.76	FIN6518ASA
EX	G		15,15	7,05	44	I	464.58	FIN6518ASB				

Ricambi non originali per motori. Denominazioni e codici originali, sono riportati a puro titolo di riferimento.

55 - 18
rel. 1511

Non original engine parts. OEMs names and part numbers are for reference purpose only.

RUGGERINI

RD 278	Cm³	CILINDRI CYLINDERS	ALESAGGIO BORE	CORSA STROKE	VERSIONE VERSION
	1205	2	95	85	

	2472	2473			448.86	448.53	448.52	448.51
FIN114CGA	FIN114CGB	FIN088SM	FIN3218RT	FIN3218RT	FIN221CO	FIN704CB	FIN622IG	FIN623EG

 	ADATTABILE A: SUITABLE FOR:		Nr.	ENGINE KIT	ELECTRIC KIT
	449.52	FIN625HG	1	 FIN032SL00	
			1	 FIN202PC00	
			1	 FIN5254SM	
				FIN2134KIT	

388.37		359.25		175.19	175.24		
FIN2330AF		FIN1051NF		FIN4240FE	FIN102OF		

100.23				2321			
FIN1065KR				FIN480OP			

652.12		644.43	644.46	660.18	956.27		
FIN681FP		FIN524NH	FIN179NO	FIN087E	FIN016DV		

	FIN003CN						

014.09	730.13	5840.089					
FIN323VA	FIN238VR	FIN225TL					

Ricambi non originali per motori. Denominazioni e codici originali, sono riportati a puro titolo di riferimento.



56 - 18







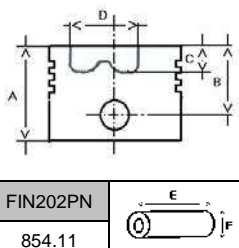

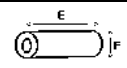
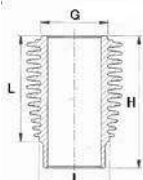
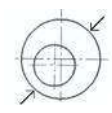
rel. 1511

Non original engine parts. OEMs names and part numbers are for reference purpose only.

RUGGERINI

RD 952	Cm³	CILINDRI CYLINDERS	ALESAGGIO BORE	CORSA STROKE	VERSIONE VERSION
	1205	2	95	85	

		TESTA HEAD	H27		3	2,5	TIPO TYPE	A	
		A	95		1	2,5			
		B	50		10	2,5			
		C	16,8		21	5,5			
		D	43						
		E	74						
FIN202PN		F	25				G	105	
854.11							H	165,6	
							I	100	
	95	2492	FIN202PC00		2495	FIN076RS00	L	122,4	
	95,5	2493	FIN202PC05		2496	FIN076RS05	20368		
	96	2494	FIN202PC10		2497	FIN076RS10	FIN032SL00		

		Nr.						ADATTABILE A: SUITABLE FOR:	
---	---	------------	---	---	---	---	---	--------------------------------	---

CR	AL	2	45,00	48,01	24,12		STD - 025 - 050 - 075 - 100 - BAR	316.36	FIN036CR STD
----	----	---	-------	-------	-------	--	-----------------------------------	--------	--------------

MB	AL	3	45,00	47,98	24,12		STD - 025 - 050 - 075 - 100 - BAR	A2649	FIN031MB STD
----	----	---	-------	-------	-------	--	-----------------------------------	-------	--------------





--	--	--	--	--	--	--	--	--	--



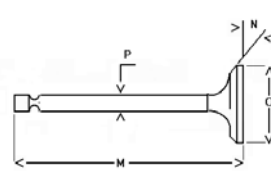

--	--	--	--	--	--	--	--	--	--

PB	BM	2	25,02	28,02	27,50		SEMIF.	316.41	FIN141PB
----	----	---	-------	-------	-------	--	--------	--------	----------

--	--	--	--	--	--	--	--	--	--

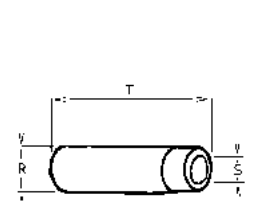
--	--	--	--	--	--	--	--	--	--

	IN EX		Nr.	O	P	M	N		ADATTABILE A: SUITABLE FOR:			
	IN		FS	2	37,6	9	105		45°	E1	960.45	FINA124
	EX		FN	2	37	9	105		45°	A1	960.46	FINS125

	IN EX		Nr.	R	S	T		ADATTABILE A: SUITABLE FOR:			
	IN		G	2	15,03	9,04		45	L	464.39	FIN203AA
	IN		G		15,13	9,04		45	L	464.25	FIN203AB
	EX		G	2	15,03	9,04		45	L	464.40	FIN204SA
	EX		G		15,13	9,04		45	L	464.35	FIN204SB

Ricambi non originali per motori. Denominazioni e codici originali, sono riportati a puro titolo di riferimento.

57 - 18

rel. 1511

Non original engine parts. OEMs names and part numbers are for reference purpose only.

RUGGERINI

RD 952	Cm³	CILINDRI CYLINDERS	ALESAGGIO BORE	CORSA STROKE	VERSIONE VERSION
	1205	2	95	85	

	2472	2473			448.86	448.53	448.52	448.51
FIN114CGA	FIN114CGB	FIN088SM	FIN3218RT	FIN3218RT	FIN221CO	FIN704CB	FIN622IG	FIN623EG

 	ADATTABILE A: SUITABLE FOR:		Nr.	ENGINE KIT	ELECTRIC KIT
	449.52	FIN625HG	1	 FIN032SL00	
			1	 FIN202PC00	
			1	 FIN5254SM	
				FIN2134KIT	

388.37		359.25		175.19	175.24		
FIN2330AF		FIN1051NF		FIN4240FE	FIN102OF		

100.23				2321			
FIN1065KR				FIN480OP			

652.12	656.29	644.43	644.46	660.17	956.27		
FIN681FP	FIN223JP	FIN524NH	FIN179NO	FIN011E	FIN016DV		

	FIN003CN						

014.09	730.13	5840.089					
FIN323VA	FIN238VR	FIN225TL					

Ricambi non originali per motori. Denominazioni e codici originali, sono riportati a puro titolo di riferimento.





58 - 18





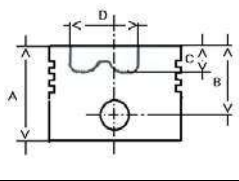

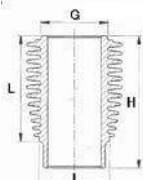
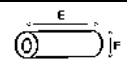

rel. 1511

Non original engine parts. OEMs names and part numbers are for reference purpose only.

RUGGERINI

RD 290	Cm³	CILINDRI CYLINDERS	ALESAGGIO BORE	CORSA STROKE	VERSIONE VERSION
	1248	2	95	88	

		TESTA HEAD	H08		3	2,5	TIPO TYPE	A	
		A	88,5		10	2,5			G
FIN468PN		B	52		22	5	H		161
0084800290		C	17		E	70	I	102,9	
		D	48,46				L	122,3	
		E	70	0082112090	FIN051RS00	0023805460		FIN173SL00	
		F	25	0082112100	FIN051RS05				
				0082112110	FIN051RS10				

		Nr.						ADATTABILE A: SUITABLE FOR:	
---	---	------------	---	---	---	---	---	--------------------------------	---

CR	AL	2	45,50	48,60	21,00		STD - 025 - 050 - 075 - 100 - BAR	0016400590	FIN059CR STD
----	----	---	-------	-------	-------	--	-----------------------------------	------------	--------------

MB	RP	2	55,00	60,00	34,00		STD - 025 - 050 - 075 - 100 - BAR - BAR EM1	0016111600	FIN161MB STD
----	----	---	-------	-------	-------	--	---	------------	--------------





MB	AL	1	55,35	59,09	21,00		STD - 025 - 050 - 075 - 100	0016100820	FIN082MB STD
----	----	---	-------	-------	-------	--	-----------------------------	------------	--------------



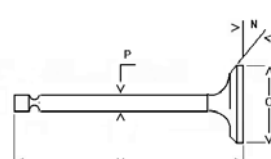

--	--	--	--	--	--	--	--	--	--

PB	BM	2	25,00	28,00	27,50		SEMIF.	0016300140	FIN014PB
----	----	---	-------	-------	-------	--	--------	------------	----------

--	--	--	--	--	--	--	--	--	--

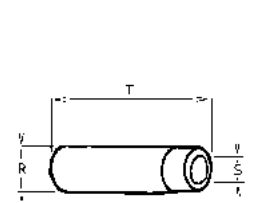
--	--	--	--	--	--	--	--	--	--

	IN EX		Nr.	O	P	M	N		ADATTABILE A: SUITABLE FOR:			
	IN		FS	2	39	8	102		45°	A9	0096521530	FINA2293
	EX		FSN	2	32,5	8	102		45°	A9	0096851460	FINS2294

	IN EX		Nr.	R	S	T		ADATTABILE A: SUITABLE FOR:			
	IN		G	2	14,06	8,05		53,5	L	0048452470	FIN6600AA
	IN		G		14,26	8,05		53,5	L		FIN6600AB
	EX		G	2	14,06	8,05		42	L	0048452480	FIN941SA
	EX		G		14,26	8,05		42	L		FIN941SB

Ricambi non originali per motori. Denominazioni e codici originali, sono riportati a puro titolo di riferimento.

59 - 18

rel. 1511

Non original engine parts. OEMs names and part numbers are for reference purpose only.

RUGGERINI

RD 290	Cm³	CILINDRI CYLINDERS	ALESAGGIO BORE	CORSA STROKE	VERSIONE VERSION
	1248	2	95	88	

	0082050990	0081850220	0012133180	0012133210	0046010410	0044000610	0044200200	0045000790
FIN4609CGA	FIN4609CGB	FIN723SM	FIN852RT	FIN854RT	FIN076CO	FIN677CB	FIN476IG	FIN370EG

 ↓ === ↑ 0,65 mm 0,7 mm	ADATTABILE A: SUITABLE FOR:		Nr.	ENGINE KIT	ELECTRIC KIT
	0,65 mm	0047301930	1	 FIN173SL00	
	0,7 mm	0047300850	1	 FIN173PC00	
			1	 FIN5255SM	
				FIN2083KIT	

0037004070		0054960740	0054961820	0021750460	0021750400		
FIN326AF		FIN074NF	FIN281CFA	FIN346FE	FIN440OF		

				0066050370			
				FIN037OP			

0065850960		0066150180	0065312650		0096720120		
FIN690FP		FIN018NH	FIN107NO		FIN016DV		

			0090430250				
			FIN025TS				

0011571540	0073622980		0054610470				
FIN554VA	FIN298VR		FIN047SI				

Ricambi non originali per motori. Denominazioni e codici originali, sono riportati a puro titolo di riferimento.



60 - 18







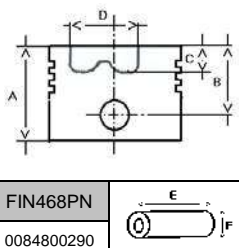

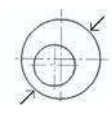
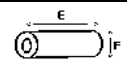
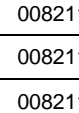
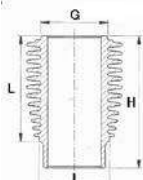
rel. 1511

Non original engine parts. OEMs names and part numbers are for reference purpose only.

RUGGERINI

SP 420	Cm³	CILINDRI CYLINDERS	ALESAGGIO BORE	CORSA STROKE	VERSIONE VERSION
	1870	3	95	88	

		TESTA HEAD	H08		3	2,5	TIPO TYPE	A	
					10	2,5			
	FIN468PN 0084800290		E 70 F 25		22	5		G 108 H 161 I 102,9 L 122,3	
	95 0065002720 FIN173PC00 95,5 0065002730 FIN173PC05 96 0065002740 FIN173PC10	0082112090 FIN051RS00 0082112100 FIN051RS05 0082112110 FIN051RS10	0023805460 FIN173SL00						

		Nr.						ADATTABILE A: SUITABLE FOR:	
---	---	------------	---	---	---	---	---	--	---

CR	AL	3	45,50	48,60	21,00		STD - 025 - 050 - 075 - 100 - BAR	0016400590	FIN059CR STD
----	----	---	-------	-------	-------	--	-----------------------------------	------------	--------------

MB	RP	1	80,80	85,96	28,00		STD - 025 - 050 - BAR	0016110890	FIN089MB STD
----	----	---	-------	-------	-------	--	-----------------------	------------	--------------





MB	RP	2	55,35	60,15	21,00		STD - 025 - 050 - BAR		FIN083MB STD
----	----	---	-------	-------	-------	--	-----------------------	--	--------------



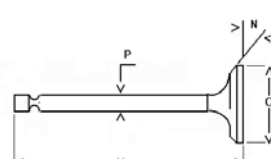

MB	RP	1					STD - 025 - 050	0016110820	FIN076MB STD
----	----	---	--	--	--	--	-----------------	------------	--------------

PB	BM	3	25,00	28,00	27,50		SEMIF.	0016300140	FIN014PB
----	----	---	-------	-------	-------	--	--------	------------	----------

--	--	--	--	--	--	--	--	--	--

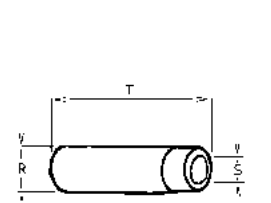
CS	RP	1					STD - 025 - 050	0016000620	FIN062CS STD
----	----	---	--	--	--	--	-----------------	------------	--------------

	IN EX		Nr.	O	P	M	N		ADATTABILE A: SUITABLE FOR:								
	IN								FS	3	39	8	102	45°	A9	0096521530	FINA2293
	EX								FSN	3	32,5	8	102	45°	A9	0096851460	FINS2294

	IN EX		Nr.	R	S	T		ADATTABILE A: SUITABLE FOR:							
	IN							G	3	14,06	8,05	53,5	L	0048452470	FIN6600AA
	IN							G		14,26	8,05	53,5	L		FIN6600AB
	EX							G	3	14,06	8,05	42	L	0048452480	FIN941SA
	EX							G		14,26	8,05	42	L		FIN941SB

Ricambi non originali per motori. Denominazioni e codici originali, sono riportati a puro titolo di riferimento.

61 - 18

rel. 1511

Non original engine parts. OEMs names and part numbers are for reference purpose only.

RUGGERINI

SP 420	Cm³	CILINDRI CYLINDERS	ALESAGGIO BORE	CORSA STROKE	VERSIONE VERSION
	1870	3	95	88	

	0082051010	0081850220	0012133490	0012133510	0046010450	0044000610	0044200200	0045000790
FIN078CGA	FIN078CGB	FIN723SM	FIN940RT	FIN856RT	FIN045CO	FIN677CB	FIN476IG	FIN370EG

 ↓ === ↑	ADATTABILE A: SUITABLE FOR:		Nr.	ENGINE KIT	ELECTRIC KIT
	0,65 mm	0047301930	1	 FIN173SL00	
	0,7 mm	0047300850	1	 FIN173PC00	
			1	 FIN5255SM	
				FIN2083KIT	

		0054960740	0054961820	0021750460	0021750400		
		FIN074NF	FIN281CFA	FIN346FE	FIN440OF		

0065850790	0065900590		0065315070		0096720120		
FIN970FP	FIN059JP		FIN268NO		FIN016DV		

			0090430250				
			FIN025TS				

0011571580	0073622280						
FIN358VA	FIN238VR						

Ricambi non originali per motori. Denominazioni e codici originali, sono riportati a puro titolo di riferimento.

62 - 18

rel. 1511

Non original engine parts. OEMs names and part numbers are for reference purpose only.

RUGGERINI

RD

ALTRI ARTICOLI

OTHERS ITEMS

POS.	ARTICOLO	ITEM	MOTORE ENGINE	CODICE FINIMPIANTI FINIMPIANTI REF.	ADATTABILE A SUITABLE FOR:
1	Cartuccia filtro olio	<i>Oil filter cartridge</i>	RD 180 , RD 181 RD 188 , RD 200 RD 201 , RD 208 RD 210 , RD 211 RD 218 , RD 220 RD 240 , RD 270 RD 278	FIN4242OF	175.31
2	Cartuccia filtro olio	<i>Oil filter cartridge</i>	RD 180 , RD 181 RD 188 , RD 200 RD 201 , RD 208 RD 210 , RD 211 RD 218 , RD 220 RD 240 , RD 270 RD 278	FIN4243OF	175.25
3	Cappuccio Valvola	<i>Valve cap</i>	All models	FIN119CV	451.25
4	Anello asta bilanciere	<i>Guard tube seal</i>	All models	FIN084AP	579.46
5	Kit anelli di tenuta	<i>Seal rings kit</i>	RD 80 , RD 81 , RD 850 RD 901/A , RD 900 RD 901 , RD 901/AD RD 920 , RD 920 L RD 950 , RD 950 L	FIN3217RTS (FIN3215RT + FIN3216RT)	2118
6	Kit anelli di tenuta	<i>Seal rings kit</i>	RD 180 , RD 181 RD 188 , RD 200 RD 201 , RD 208 RD 210 , RD 211 RD 218 , RD 220 RD 901/2 , RD 240 RD 248 , RD 92/2 RD 92/2 L , RD 270 RD 278 , RD 952	FIN3222RTS (FIN3218RT + FIN3218RT)	2312
7	Massa filtrante metallica	<i>Metallic filtering element</i>	RD 218 , RD 220 RD 901/2 , RD 240 RD 248 , RD 92/2 RD 92/2 L , RD 270 RD 278 , RD 952	FIN1148NF	670.15
8	Pistone completo (come FIN489PC ma A=75)	<i>Piston assembly (same as FIN489PC but A=75)</i>	RD 80 , RD 81	FIN490PC00	
9	Pistone completo (come FIN489PC ma A=75)	<i>Piston assembly (same as FIN489PC but A=75)</i>	RD 80 , RD 81	FIN490PC05	
10	Pistone completo (come FIN489PC ma A=75)	<i>Piston assembly (same as FIN489PC but A=75)</i>	RD 80 , RD 81	FIN490PC10	
11					
12					
13					
14					

RUGGERINI

RD

ALTRI ARTICOLI

OTHERS ITEMS

POS.	ARTICOLO	<i>ITEM</i>	MOTORE <i>ENGINE</i>	CODICE FINIMPIANTI <i>FINIMPIANTI REF.</i>	ADATTABILE A <i>SUITABLE FOR:</i>
15					
16					
17					
18					
19					
20					
21					
22					
23					
24					
25					
26					
27					
28					
29					
30					
31					
32					
33					
34					

GRUPPO MD RUGGERINI <i>FAMILY MD</i>	
1	MD 75.0
3	MD 75.1
5	MD 150
7	MD 151
9	MD 300
11	MD 301
13	MD 85.0
15	MD 85.1
17	MD 95.0
19	MD 95.1
21	MD 170
23	MD 171
25	MD 190
27	MD 191
29	MD 350
31	MD 351
33	ALTRI ARTICOLI <i>OTHERS ITEMS</i>

Questo catalogo contiene dati ed informazioni provenienti dalla pluriennale esperienza di Finimpianti. Tuttavia non possiamo assumere alcuna responsabilità per eventuali dati errati od incompleti.

Tutti i dati e le informazioni contenute nel presente catalogo sono fornite a puro scopo informativo e senza responsabilità e non potranno dare adito ad alcuna forma di risarcimento.

Visto il continuo sviluppo dei nostri prodotti, Finimpianti si riserva il diritto di apportare modifiche senza preavviso.

Denominazioni, numeri e codici originali sono riportati a puro titolo di riferimento.

All the information and data contained in this catalogue came from the long Finimpianti experience. Nevertheless we can not assume any responsibility for possible mistakes.



All the information and data contained in this catalogue are provide "as is" without any representation or warranty express or implied. Under no circumstances whatsoever shall Finimpianti be liable for any damages whatsoever arising out of the use of the information and data contained in this catalogue.







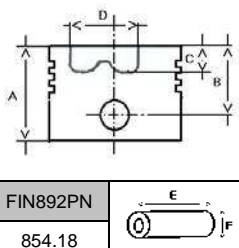

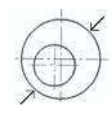
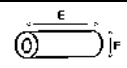
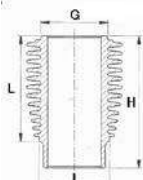
Finimpianti does not warrant the accuracy or completeness of the materials and content contained in this catalogue and reserves the right to correct any errors or omissions at any time without notice and without obligation to the users of this catalogue.

OEM names, codes and part numbers, used in this catalogue, are for reference only.

RUGGERINI

MD 75.0	Cm³	CILINDRI CYLINDERS	ALESAGGIO BORE	CORSA STROKE	VERSIONE VERSION
		1	80		

		TESTA HEAD	H08		3	2	TIPO TYPE	A	
					10	2			
					22	3			
	FIN892PN		A	64	A2132	FIN068RS00		G	
	854.18		E	60				H	
			F	20				I	
								L	
	80	A2098	FIN191PC00				203.98	FIN703SL00	
	80,5		FIN191PC05						
	81		FIN191PC10						

		Nr.						ADATTABILE A: SUITABLE FOR:	
---	---	------------	---	---	---	---	---	--------------------------------	---

CR	AL	1	40,00	43,66	22,00		STD - 025 - 050 075 - 100	A2637	FIN057CR STD
----	----	---	-------	-------	-------	--	------------------------------	-------	--------------

MB	AL	2	45,00	49,85	24,00		STD - 025 - 050 BAR	310.77	FIN077MB STD
----	----	---	-------	-------	-------	--	------------------------	--------	--------------





--	--	--	--	--	--	--	--	--	--



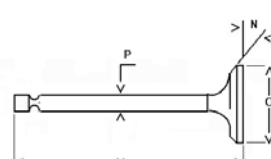

--	--	--	--	--	--	--	--	--	--

--	--	--	--	--	--	--	--	--	--

TW	AL	2	51,00	65,00	2,36		STD	060.17	FIN177TW STD
----	----	---	-------	-------	------	--	-----	--------	--------------

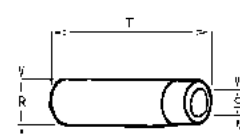
--	--	--	--	--	--	--	--	--	--

	IN EX		Nr.	O	P	M	N		ADATTABILE A: SUITABLE FOR:									
									IN	FS	1	35	7	84,5	45	A1	960.53	FINA158
									EX	FN	1	31	7	84,5	45	A1	960.54	FINS159

	IN EX		Nr.	R	S	T		ADATTABILE A: SUITABLE FOR:								
								IN	G	1	13,05	7,03	39	I	464.56	FIN208ASA
								IN	G		13,15	7,03	39	I	464.59	FIN208ASB
								IN	G	1	13,05	7,03	39	I	464.56	FIN208ASA
								IN	G		13,15	7,03	39	I	464.59	FIN208ASB

Ricambi non originali per motori. Denominazioni e codici originali, sono riportati a puro titolo di riferimento.

RUGGERINI

MD 75.0	Cm³	CILINDRI CYLINDERS	ALESAGGIO BORE	CORSA STROKE	VERSIONE VERSION
		1	80		

	A2226	A2225			451.32	451.31	450.35	451.24
FIN106CGA	FIN106CGB	FIN080SM	FIN3219RT	FIN3218RT	FIN211CO	FIN703CB	FIN508IG	FIN506EG

 ADATTABILE A: SUITABLE FOR:	 FIN6351HG	Nr.	ENGINE KIT	ELECTRIC KIT
		1	 FIN703SL00	
		1	 FIN191PC00	
		1	 FIN080SM	
		A2342	FIN2424KIT	

388.72	670.14	359.29		175.32	175.05		
FIN823AF	FIN614PF	FIN902NF		FIN020FE	FIN4225OF		

				A2143			
				FIN243OP			

652.37	656.60	644.47	644.66	660.24	956.43		
FIN620FP	FIN260JP	FIN518NH	FIN050NO	FIN420E	FIN340DV		



696.78							
FIN038PU	FIN003CN						







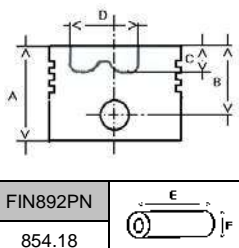

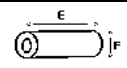
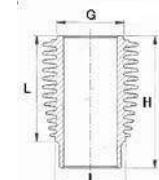
014.39	730.34	5840.142					
FIN930VA	FIN298VR	FIN142TL					

Ricambi non originali per motori. Denominazioni e codici originali, sono riportati a puro titolo di riferimento.

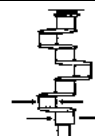
RUGGERINI

MD 75.1	Cm³	CILINDRI CYLINDERS	ALESAGGIO BORE	CORSA STROKE	VERSIONE VERSION
		1	80		

		TESTA HEAD	H08		3	2	TIPO TYPE	A	
					10	2			
					22	3			
	FIN892PN 854.18		A	64	A2132	FIN068RS00		G	
			B	36		FIN068RS05		H	
			C	10		FIN068RS10		I	
			D	41,8				L	
	80	A2098	FIN191PC00			203.98	FIN703SL00		
	80,5		FIN191PC05						
	81		FIN191PC10						

		Nr.						ADATTABILE A: SUITABLE FOR:	
---	---	------------	---	---	---	---	---	--------------------------------	---

CR	AL	1	40,00	43,66	22,00		STD - 025 - 050 075 - 100	A2637	FIN057CR STD
----	----	---	-------	-------	-------	--	------------------------------	-------	--------------

MB	AL	2	45,00	49,85	24,00		STD - 025 - 050 BAR	310.77	FIN077MB STD
----	----	---	-------	-------	-------	--	------------------------	--------	--------------





--	--	--	--	--	--	--	--	--	--



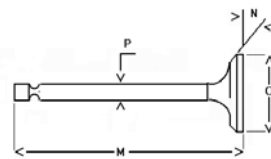

--	--	--	--	--	--	--	--	--	--

--	--	--	--	--	--	--	--	--	--

TW	AL	2	51,00	65,00	2,36		STD	060.17	FIN177TW STD
----	----	---	-------	-------	------	--	-----	--------	--------------

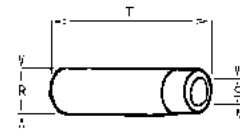
--	--	--	--	--	--	--	--	--	--

	IN EX		Nr.	O	P	M	N		ADATTABILE A: SUITABLE FOR:									
									IN	FS	1	35	7	84,5	45	A1	960.53	FINA158
									EX	FN	1	31	7	84,5	45	A1	960.54	FINS159

	IN EX		Nr.	R	S	T		ADATTABILE A: SUITABLE FOR:								
								IN	G	1	13,05	7,03	39	I	464.56	FIN208ASA
								IN	G		13,15	7,03	39	I	464.59	FIN208ASB
								IN	G	1	13,05	7,03	39	I	464.56	FIN208ASA
								IN	G		13,15	7,03	39	I	464.59	FIN208ASB

Ricambi non originali per motori. Denominazioni e codici originali, sono riportati a puro titolo di riferimento.

RUGGERINI

MD 75.1	Cm³	CILINDRI CYLINDERS	ALESAGGIO BORE	CORSA STROKE	VERSIONE VERSION
		1	80		

	A2226	A2225			451.32	451.31	450.35	451.24
FIN106CGA	FIN106CGB	FIN080SM	FIN3219RT	FIN3218RT	FIN211CO	FIN703CB	FIN508IG	FIN506EG

 	ADATTABILE A: SUITABLE FOR:		Nr.	ENGINE KIT	ELECTRIC KIT
	450.72	FIN6351HG	1	 FIN703SL00	
			1	 FIN191PC00	
			1	 FIN080SM	
			A2342	FIN2424KIT	

388.72	670.14	359.29		175.32	175.05		
FIN823AF	FIN614PF	FIN902NF		FIN020FE	FIN4225OF		

				A2143			
				FIN243OP			

652.37	656.60	644.47	644.66	660.24	956.43		
FIN620FP	FIN260JP	FIN518NH	FIN050NO	FIN420E	FIN340DV		





696.78							
FIN038PU	FIN003CN						





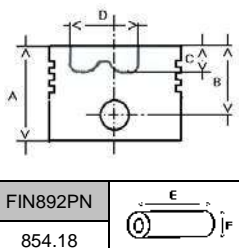

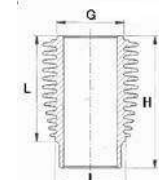
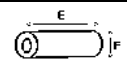

014.39	730.34	5840.142					
FIN930VA	FIN298VR	FIN142TL					

Ricambi non originali per motori. Denominazioni e codici originali, sono riportati a puro titolo di riferimento.

RUGGERINI

MD 150	Cm³	CILINDRI CYLINDERS	ALESAGGIO BORE	CORSA STROKE	VERSIONE VERSION
	654	2	80	65	

		TESTA HEAD	H08		3	2	TIPO TYPE	A		
		A	64		10	2			G	
		B	36		22	3			H	
		C	10						I	
		D	41,8						L	
		E	60							
FIN892PN				A2132	FIN068RS00	203.98	FIN703SL00			
854.18					FIN068RS05					
					FIN068RS10					
	80	A2128	FIN191PC00							
	80,5		FIN191PC05							
	81		FIN191PC10							

		Nr.						ADATTABILE A: SUITABLE FOR:	
---	---	------------	---	---	---	---	---	--------------------------------	---

CR	AL	2	40,00	43,66	22,00		STD - 025 - 050 075 - 100	A2637	FIN057CR STD
----	----	---	-------	-------	-------	--	------------------------------	-------	--------------

MB	AL	2	45,00	49,85	24,00		STD - 025 - 050 BAR	310.77	FIN077MB STD
----	----	---	-------	-------	-------	--	------------------------	--------	--------------





MB	AL	1	45,00	47,98	24,12		STD - 025 - 050 - 075 - 100 - BAR	310.31	FIN031MB STD
----	----	---	-------	-------	-------	--	--------------------------------------	--------	--------------



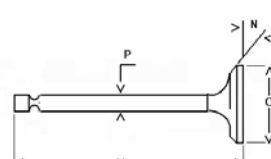

--	--	--	--	--	--	--	--	--	--

--	--	--	--	--	--	--	--	--	--

--	--	--	--	--	--	--	--	--	--

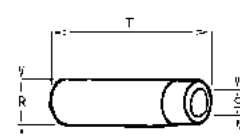
--	--	--	--	--	--	--	--	--	--

	IN EX		Nr.	O	P	M	N		ADATTABILE A: SUITABLE FOR:			
	IN		FS	2	35	7	84,5		45	A1	960.53	FINA158
	EX		FN	2	31	7	84,5		45	A1	960.54	FINS159

	IN EX		Nr.	R	S	T		ADATTABILE A: SUITABLE FOR:			
	IN		G	2	13,05	7,03		39	I	464.56	FIN208ASA
	IN		G		13,15	7,03		39	I	464.59	FIN208ASB
	IN		G	2	13,05	7,03		39	I	464.56	FIN208ASA
	IN		G		13,15	7,03		39	I	464.59	FIN208ASB

Ricambi non originali per motori. Denominazioni e codici originali, sono riportati a puro titolo di riferimento.

5 - 19

rel. 1511

Non original engine parts. OEMs names and part numbers are for reference purpose only.

RUGGERINI

MD 150	Cm³	CILINDRI CYLINDERS	ALESAGGIO BORE	CORSA STROKE	VERSIONE VERSION
	654	2	80	65	

	A2142	A2141			450.60	451.31	450.35	450.96
FIN107CGA	FIN107CGB	FIN081SM	FIN3219RT	FIN3218RT	FIN707CO	FIN703CB	FIN508IG	FIN613EG

 	ADATTABILE A: SUITABLE FOR:		Nr.	ENGINE KIT	ELECTRIC KIT
	450.72	FIN6351HG	1	 FIN703SL00	
			1	 FIN191PC00	
			1	 FIN080SM	
			A2342	FIN2424KIT	

388.48	670.14	359.29		175.32	175.05		
FIN822AF	FIN614PF	FIN902NF		FIN020FE	FIN4225OF		

				A2143			
				FIN243OP			

652.26	656.60	644.47	644.66	660.24	956.43		
FIN626FP	FIN260JP	FIN518NH	FIN050NO	FIN420E	FIN340DV		

696.78							
FIN038PU	FIN003CN						

014.39	730.34	563.54					
FIN930VA	FIN298VR	FIN708TL					

Ricambi non originali per motori. Denominazioni e codici originali, sono riportati a puro titolo di riferimento.





6 - 19





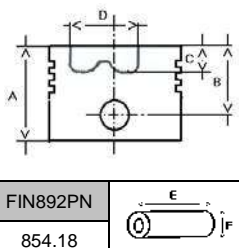

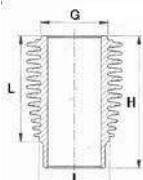
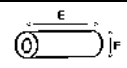

rel. 1511

Non original engine parts. OEMs names and part numbers are for reference purpose only.

RUGGERINI

MD 151	Cm³	CILINDRI CYLINDERS	ALESAGGIO BORE	CORSA STROKE	VERSIONE VERSION
	654	2	80	65	

		TESTA HEAD	H08		3	2	TIPO TYPE	A		
		A	64		10	2			G	
		B	36		22	3			H	
		C	10						I	
		D	41,8						L	
		E	60							
FIN892PN				A2132	FIN068RS00	203.98	FIN703SL00			
854.18					FIN068RS05					
					FIN068RS10					
	80	A2128	FIN191PC00							
	80,5		FIN191PC05							
	81		FIN191PC10							

		Nr.						ADATTABILE A: SUITABLE FOR:	
--	---	------------	---	---	---	---	---	--------------------------------	---

CR	AL	2	40,00	43,66	22,00		STD - 025 - 050 075 - 100	A2637	FIN057CR STD
----	----	---	-------	-------	-------	--	------------------------------	-------	--------------

MB	AL	2	45,00	49,85	24,00		STD - 025 - 050 BAR	310.77	FIN077MB STD
----	----	---	-------	-------	-------	--	------------------------	--------	--------------





MB	AL	1	45,00	47,98	24,12		STD - 025 - 050 - 075 - 100 - BAR	310.31	FIN031MB STD
----	----	---	-------	-------	-------	--	--------------------------------------	--------	--------------



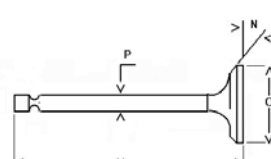

--	--	--	--	--	--	--	--	--	--

--	--	--	--	--	--	--	--	--	--

--	--	--	--	--	--	--	--	--	--

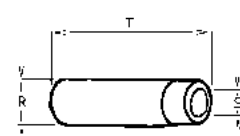
--	--	--	--	--	--	--	--	--	--

	IN EX		Nr.	O	P	M	N		ADATTABILE A: SUITABLE FOR:			
	IN		FS	2	35	7	84,5		45	A1	960.53	FINA158
	EX		FN	2	31	7	84,5		45	A1	960.54	FINS159

	IN EX		Nr.	R	S	T		ADATTABILE A: SUITABLE FOR:			
	IN		G	2	13,05	7,03		39	I	464.56	FIN208ASA
	IN		G		13,15	7,03		39	I	464.59	FIN208ASB
	IN		G	2	13,05	7,03		39	I	464.56	FIN208ASA
	IN		G		13,15	7,03		39	I	464.59	FIN208ASB

Ricambi non originali per motori. Denominazioni e codici originali, sono riportati a puro titolo di riferimento.

7 - 19

rel. 1511

Non original engine parts. OEMs names and part numbers are for reference purpose only.

RUGGERINI

MD 151	Cm³	CILINDRI CYLINDERS	ALESAGGIO BORE	CORSA STROKE	VERSIONE VERSION
	654	2	80	65	

	A2142	A2141			450.60	451.31	450.35	450.96
FIN107CGA	FIN107CGB	FIN081SM	FIN3219RT	FIN3218RT	FIN707CO	FIN703CB	FIN508IG	FIN613EG

 	ADATTABILE A: SUITABLE FOR:		Nr.	ENGINE KIT	ELECTRIC KIT
	450.72	FIN6351HG	1	 FIN703SL00	
			1	 FIN191PC00	
			1	 FIN080SM	
			A2342	FIN2424KIT	

388.48	670.14	359.29		175.32	175.05		
FIN822AF	FIN614PF	FIN902NF		FIN020FE	FIN4225OF		

				A2143			
				FIN243OP			

652.26	656.60	644.47	644.66	660.24	956.43		
FIN626FP	FIN260JP	FIN518NH	FIN050NO	FIN420E	FIN340DV		

696.78							
FIN038PU	FIN003CN						

014.39	730.34	563.54					
FIN930VA	FIN298VR	FIN708TL					

Ricambi non originali per motori. Denominazioni e codici originali, sono riportati a puro titolo di riferimento.





8 - 19





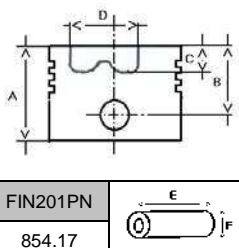

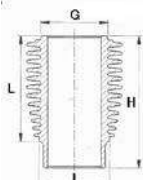

rel. 1511

Non original engine parts. OEMs names and part numbers are for reference purpose only.

RUGGERINI

MD 300	Cm³	CILINDRI CYLINDERS	ALESAGGIO BORE	CORSA STROKE	VERSIONE VERSION
	1387	3	80	92	

		TESTA HEAD	H08		3	2,5	TIPO TYPE	A		
		A	75		10	2,5				
		B	40		23	4		G	93	
		C	13,8					H	155,4	
		D	41,3					I	92	
		E	64					L	115,4	
		F	22				203.85		FIN1980SL00	
		FIN201PN			A2285	FIN067RS00				
		854.17				2341	FIN067RS05			
						2342	FIN067RS10			

		Nr.						ADATTABILE A: SUITABLE FOR:	
--	---	------------	---	---	---	---	---	--------------------------------	---

CR	AL	3	45,00	48,01	24,12		STD - 025 - 050 - 075 - 100	316.70	FIN2260CR STD
----	----	---	-------	-------	-------	--	-----------------------------	--------	---------------

MB	AL	2	50,00	53,00	23,10		STD - 025 - 050 BAR	311.03	FINR1551MB STD
----	----	---	-------	-------	-------	--	---------------------	--------	----------------





MB	AL	2	50,00	54,85	23,10		STD - 025 - 050	311.02	FINR1552MB STD
----	----	---	-------	-------	-------	--	-----------------	--------	----------------



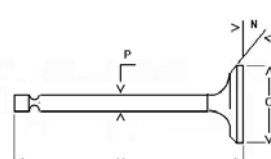

--	--	--	--	--	--	--	--	--	--

--	--	--	--	--	--	--	--	--	--

TW	AL	2	58,50	72,00	2,36		STD	060.16	FIN176TW STD
----	----	---	-------	-------	------	--	-----	--------	--------------

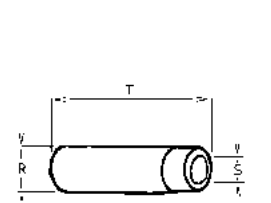
--	--	--	--	--	--	--	--	--	--

	IN EX		Nr.	O	P	M	N		ADATTABILE A: SUITABLE FOR:			
	IN		FS	3	37,5	7	84,5		45	A1	960.58	FINA156
	EX		FN	3	33	7	84,5		45	A1	960.59	FINS157

	IN EX		Nr.	R	S	T		ADATTABILE A: SUITABLE FOR:			
	IN		G	3	13,05	7,03		39	I	464.56	FIN208ASA
	IN		G		13,15	7,03		39	I	464.59	FIN208ASB
	IN		G	3	13,05	7,03		39	I	464.56	FIN208ASA
								464.59	FIN208ASB		

Ricambi non originali per motori. Denominazioni e codici originali, sono riportati a puro titolo di riferimento.

9 - 19

rel. 1511

Non original engine parts. OEMs names and part numbers are for reference purpose only.

RUGGERINI

MD 300	Cm³	CILINDRI CYLINDERS	ALESAGGIO BORE	CORSA STROKE	VERSIONE VERSION
	1387	3	80	92	

	A2287	A2288	A2207		451.17	451.31	451.27	451.24
FIN4462CGA	FIN4462CGB	FIN5248SM	FIN3240RT		FIN220CO	FIN703CB	FIN501IG	FIN506EG

 ADATTABILE A: SUITABLE FOR:	 FIN6351HG	Nr.	ENGINE KIT	ELECTRIC KIT
		1	 FIN1980SL00	
		1	 FIN487PC00	
		1	 FIN5246SM	
		A2286	FIN2036KIT	

388.78		359.25		175.19	175.24		
FIN378AF		FIN1051NF		FIN4240FE	FIN102OF		



652.12	656.60	644.47	644.66	660.24	956.43		
FIN681FP	FIN260JP	FIN518NH	FIN050NO	FIN420E	FIN340DV		







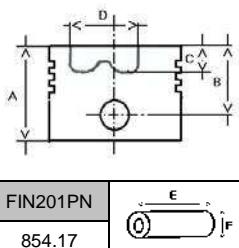

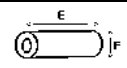
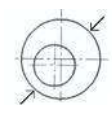
014.35	730.54	563.61					
FIN530VA	FIN492VR	FIN220TL					

Ricambi non originali per motori. Denominazioni e codici originali, sono riportati a puro titolo di riferimento.

RUGGERINI

MD 301	Cm³	CILINDRI CYLINDERS	ALESAGGIO BORE	CORSA STROKE	VERSIONE VERSION
	1387	3	80	92	

		TESTA HEAD	H08		<table border="1"> <tr><td>3</td><td>2,5</td></tr> <tr><td>10</td><td>2,5</td></tr> <tr><td>23</td><td>4</td></tr> </table>	3	2,5	10	2,5	23	4	TIPO TYPE	A	
		3	2,5											
10	2,5													
23	4													
FIN201PN		A	G	93										
854.17		B	40			H	155,4							
		C	13,8			I	92							
		D	41,3			L	115,4							
		E	64			203.85		FIN1980SL00						
		F	22											
	80	A2284	FIN487PC00	A2285	FIN067RS00									
	80,5		FIN487PC05	2341	FIN067RS05									
	81		FIN487PC10	2342	FIN067RS10									

		Nr.						ADATTABILE A: SUITABLE FOR:	
---	---	------------	---	---	---	---	---	--------------------------------	---

CR	AL	3	45,00	48,01	24,12		STD - 025 - 050 - 075 - 100	316.70	FIN2260CR STD
----	----	---	-------	-------	-------	--	-----------------------------	--------	---------------

MB	AL	2	50,00	53,00	23,10		STD - 025 - 050 BAR	311.03	FINR1551MB STD
----	----	---	-------	-------	-------	--	---------------------	--------	----------------





MB	AL	2	50,00	54,85	23,10		STD - 025 - 050	311.02	FINR1552MB STD
----	----	---	-------	-------	-------	--	-----------------	--------	----------------



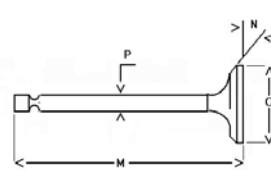

--	--	--	--	--	--	--	--	--	--

--	--	--	--	--	--	--	--	--	--

TW	AL	2	58,50	72,00	2,36		STD	060.16	FIN176TW STD
----	----	---	-------	-------	------	--	-----	--------	--------------

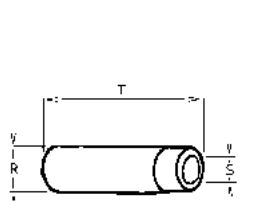
--	--	--	--	--	--	--	--	--	--

	IN EX		Nr.	O	P	M	N		ADATTABILE A: SUITABLE FOR:			
	IN		FS	3	37,5	7	84,5		45	A1	960.58	FINA156
	EX		FN	3	33	7	84,5		45	A1	960.59	FINS157

	IN EX		Nr.	R	S	T		ADATTABILE A: SUITABLE FOR:			
	IN		G	3	13,05	7,03		39	I	464.56	FIN208ASA
	IN		G		13,15	7,03		39	I	464.59	FIN208ASB
	IN		G	3	13,05	7,03		39	I	464.56	FIN208ASA
	IN		G		13,15	7,03		39	I	464.59	FIN208ASB

Ricambi non originali per motori. Denominazioni e codici originali, sono riportati a puro titolo di riferimento.

11 - 19

rel. 1511

Non original engine parts. OEMs names and part numbers are for reference purpose only.

RUGGERINI

MD 301	Cm³	CILINDRI CYLINDERS	ALESAGGIO BORE	CORSA STROKE	VERSIONE VERSION
	1387	3	80	92	

	A2287	A2288	A2207		451.17	451.31	451.27	451.24
FIN4462CGA	FIN4462CGB	FIN5248SM	FIN3240RT		FIN220CO	FIN703CB	FIN501IG	FIN506EG

 ADATTABILE A: SUITABLE FOR:	 FIN6351HG	Nr.	ENGINE KIT	ELECTRIC KIT
		1	 FIN1980SL00	
		1	 FIN487PC00	
		1	 FIN5246SM	
		A2286	FIN2036KIT	

388.78		359.25		175.19	175.24		
FIN378AF		FIN1051NF		FIN4240FE	FIN102OF		





652.12	656.60	644.47	644.66	660.24	956.43		
FIN681FP	FIN260JP	FIN518NH	FIN050NO	FIN420E	FIN340DV		





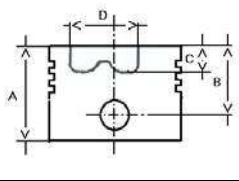

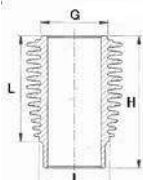

014.35	730.54	563.61					
FIN530VA	FIN492VR	FIN220TL					

Ricambi non originali per motori. Denominazioni e codici originali, sono riportati a puro titolo di riferimento.

RUGGERINI

MD 85.0	Cm³	CILINDRI CYLINDERS	ALESAGGIO BORE	CORSA STROKE	VERSIONE VERSION
		1	85		

		TESTA HEAD			3	2	TIPO TYPE	A	
		A			10	2			
		B			22	4		G	93
		C						H	134,4
		D						I	92
		E	64					L	97,4
		F	22						
	FIN201PN								
	854.17								
	85	A2267	FIN029PC00	A2052	FIN070RS00				
	85,5		FIN029PC05	2992	FIN070RS05				
	86		FIN029PC10	2993	FIN070RS10				
							203.83	FIN027SL00	

		Nr.							ADATTABILE A: SUITABLE FOR:	
---	---	------------	---	---	---	---	---	--	--------------------------------	---

CR	AL	1	40,00	43,66	22,00			STD - 025 - 050 075 - 100	316.57	FIN057CR STD
----	----	---	-------	-------	-------	--	--	------------------------------	--------	--------------

MB	AL	2	45,00	49,85	24,00			STD - 025 - 050 BAR	310.77	FIN077MB STD
----	----	---	-------	-------	-------	--	--	------------------------	--------	--------------





--	--	--	--	--	--	--	--	--	--	--



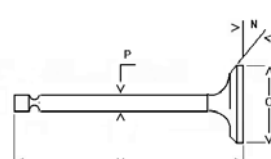

--	--	--	--	--	--	--	--	--	--	--

--	--	--	--	--	--	--	--	--	--	--

TW	AL	2	51,00	65,00	2,36			STD	060.17	FIN177TW STD
----	----	---	-------	-------	------	--	--	-----	--------	--------------

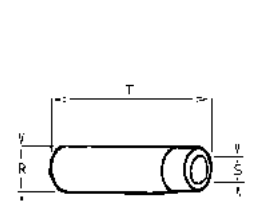
--	--	--	--	--	--	--	--	--	--	--

	IN EX		Nr.	O	P	M	N		ADATTABILE A: SUITABLE FOR:				
	IN		FS	1	35	7	84,5		45		A1	960.53	FINA158
	EX		FN	1	31	7	84,5		45		A1	960.54	FINS159

	IN EX		Nr.	R	S	T		ADATTABILE A: SUITABLE FOR:				
	IN		G	1	13,05	7,03		39		I	464.56	FIN208ASA
	IN		G		13,15	7,03		39		I	464.59	FIN208ASB
	IN		G	1	13,05	7,03		39		I	464.56	FIN208ASA
	IN		G		13,15	7,03		39		I	464.59	FIN208ASB

Ricambi non originali per motori. Denominazioni e codici originali, sono riportati a puro titolo di riferimento.

13 - 19
rel. 1511

Non original engine parts. OEMs names and part numbers are for reference purpose only.

RUGGERINI

MD 85.0	Cm³	CILINDRI CYLINDERS	ALESAGGIO BORE	CORSA STROKE	VERSIONE VERSION
		1	85		

	A2228	A2227			451.32	451.31	450.35	450.96
FIN4450CGA	FIN4450CGB	FIN5240SM	FIN3219RT	FIN3218RT	FIN211CO	FIN703CB	FIN508IG	FIN613EG

 ADATTABILE A: SUITABLE FOR:		Nr.	ENGINE KIT	ELECTRIC KIT 	
	451.15	FIN508HG	1		 FIN027SL00
			1		 FIN029PC00
			1		 FIN5240SM
			A2268		FIN3251KIT

388.72	670.14	359.29		175.32	175.05		
FIN823AF	FIN614PF	FIN902NF		FIN020FE	FIN4225OF		

				A2143			
				FIN243OP			

652.37	656.60	644.47	644.66	660.24	956.43		
FIN620FP	FIN260JP	FIN518NH	FIN050NO	FIN420E	FIN340DV		





696.78							
FIN038PU	FIN003CN						





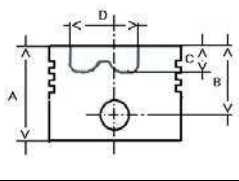

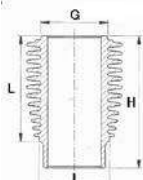

014.39	730.34	5840.142					
FIN930VA	FIN298VR	FIN142TL					

Ricambi non originali per motori. Denominazioni e codici originali, sono riportati a puro titolo di riferimento.

RUGGERINI

MD 85.1	Cm³	CILINDRI CYLINDERS	ALESAGGIO BORE	CORSA STROKE	VERSIONE VERSION
		1	85		

		TESTA HEAD			3	2	TIPO TYPE	A	
		A			10	2			
		B			22	4			
		C							
	FIN201PN		E	64				G	93
	854.17		F	22				H	134,4
								I	92
								L	97,4
	85	A2267	FIN029PC00		A2052	FIN070RS00	203.83	FIN027SL00	
	85,5		FIN029PC05		2992	FIN070RS05			
	86		FIN029PC10		2993	FIN070RS10			

		Nr.						ADATTABILE A: SUITABLE FOR:	
---	---	------------	---	---	---	---	---	--------------------------------	---

CR	AL	1	40,00	43,66	22,00		STD - 025 - 050 075 - 100	316.57	FIN057CR STD
----	----	---	-------	-------	-------	--	------------------------------	--------	--------------

MB	AL	2	45,00	49,85	24,00		STD - 025 - 050 BAR	310.77	FIN077MB STD
----	----	---	-------	-------	-------	--	------------------------	--------	--------------





--	--	--	--	--	--	--	--	--	--



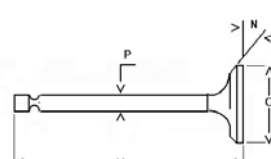

--	--	--	--	--	--	--	--	--	--

--	--	--	--	--	--	--	--	--	--

TW	AL	2	51,00	65,00	2,36		STD	060.17	FIN177TW STD
----	----	---	-------	-------	------	--	-----	--------	--------------

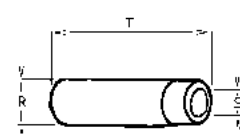
--	--	--	--	--	--	--	--	--	--

	IN EX		Nr.	O	P	M	N		ADATTABILE A: SUITABLE FOR:			
	IN		FS	1	35	7	84,5		45	A1	960.53	FINA158
	EX		FN	1	31	7	84,5		45	A1	960.54	FINS159

	IN EX		Nr.	R	S	T		ADATTABILE A: SUITABLE FOR:			
	IN		G	1	13,05	7,03		39	I	464.56	FIN208ASA
	IN		G		13,15	7,03		39	I	464.59	FIN208ASB
	IN		G	1	13,05	7,03		39	I	464.56	FIN208ASA
	IN		G		13,15	7,03		39	I	464.59	FIN208ASB

Ricambi non originali per motori. Denominazioni e codici originali, sono riportati a puro titolo di riferimento.

15 - 19

rel. 1511

Non original engine parts. OEMs names and part numbers are for reference purpose only.

RUGGERINI

MD 85.1	Cm³	CILINDRI CYLINDERS	ALESAGGIO BORE	CORSA STROKE	VERSIONE VERSION
		1	85		

	A2228	A2227			451.32	451.31	450.35	450.96
FIN4450CGA	FIN4450CGB	FIN5240SM	FIN3219RT	FIN3218RT	FIN211CO	FIN703CB	FIN508IG	FIN613EG

 	ADATTABILE A: SUITABLE FOR:		Nr.	ENGINE KIT	ELECTRIC KIT
	451.15	FIN508HG	1	 FIN027SL00	
			1	 FIN029PC00	
			1	 FIN5240SM	
			A2268	FIN3251KIT	

388.72	670.14	359.29		175.32	175.05		
FIN823AF	FIN614PF	FIN902NF		FIN020FE	FIN4225OF		

				A2143			
				FIN243OP			

652.37	656.60	644.47	644.66	660.24	956.43		
FIN620FP	FIN260JP	FIN518NH	FIN050NO	FIN420E	FIN340DV		

696.78							
FIN038PU	FIN003CN						

014.39	730.34	5840.142					
FIN930VA	FIN298VR	FIN142TL					

Ricambi non originali per motori. Denominazioni e codici originali, sono riportati a puro titolo di riferimento.



16 - 19







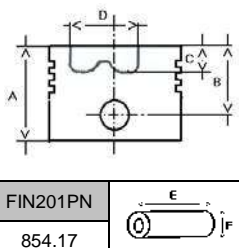

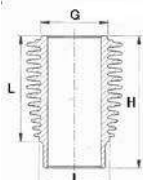
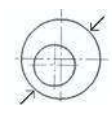
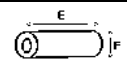
rel. 1511

Non original engine parts. OEMs names and part numbers are for reference purpose only.

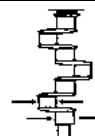
RUGGERINI

MD 95.0	Cm³	CILINDRI CYLINDERS	ALESAGGIO BORE	CORSA STROKE	VERSIONE VERSION
	426	1	85	75	

		TESTA HEAD	H13		3	2	TIPO TYPE	A		
		A	70		10	2			G	93
		B	40		22	4			H	134,4
		C	13						I	92
		D	42,6						L	97,4
		E	64						203.83	
F	22									
	FIN201PN			A2052	FIN070RS00					
	854.17		85	A2146	2992	FIN070RS05				
			85,5	A2147	2993	FIN070RS10				
		86	A2148	FIN194PC00						
				FIN194PC05						
				FIN194PC10						

		Nr.						ADATTABILE A: SUITABLE FOR:	
---	---	------------	---	---	---	---	---	--------------------------------	---

CR	AL	1	40,00	43,66	22,00		STD - 025 - 050 075 - 100	A2637	FIN057CR STD
----	----	---	-------	-------	-------	--	------------------------------	-------	--------------

MB	AL	2	45,00	49,85	24,00		STD - 025 - 050 BAR	310.77	FIN077MB STD
----	----	---	-------	-------	-------	--	------------------------	--------	--------------





--	--	--	--	--	--	--	--	--	--



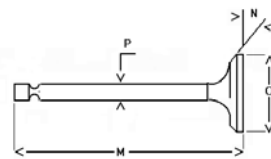

--	--	--	--	--	--	--	--	--	--

--	--	--	--	--	--	--	--	--	--

TW	AL	2	51,00	65,00	2,36		STD	060.17	FIN177TW STD
----	----	---	-------	-------	------	--	-----	--------	--------------

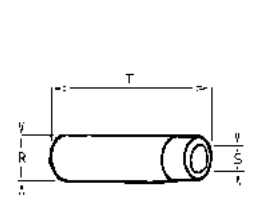
--	--	--	--	--	--	--	--	--	--

	IN EX		Nr.	O	P	M	N		ADATTABILE A: SUITABLE FOR:			
	IN		FS	1	35	7	84,5		45	A1	960.53	FINA158
	EX		FN	1	31	7	84,5		45	A1	960.54	FINS159

	IN EX		Nr.	R	S	T		ADATTABILE A: SUITABLE FOR:			
	IN		G	1	13,05	7,03		39	I	464.56	FIN208ASA
	IN		G		13,15	7,03		39	I	464.59	FIN208ASB
	IN		G	1	13,05	7,03		39	I	464.56	FIN208ASA
	IN		G		13,15	7,03		39	I	464.59	FIN208ASB

Ricambi non originali per motori. Denominazioni e codici originali, sono riportati a puro titolo di riferimento.

17 - 19

rel. 1511

Non original engine parts. OEMs names and part numbers are for reference purpose only.

RUGGERINI

MD 95.0	Cm³	CILINDRI CYLINDERS	ALESAGGIO BORE	CORSA STROKE	VERSIONE VERSION
	426	1	85	75	

	A2228	A2227			451.32	451.31	450.35	450.96
FIN4450CGA	FIN4450CGB	FIN5240SM	FIN3219RT	FIN3218RT	FIN211CO	FIN703CB	FIN508IG	FIN613EG

 ADATTABILE A: SUITABLE FOR:	 FIN508HG	Nr.	ENGINE KIT	ELECTRIC KIT
		1	 FIN027SL00	
		1	 FIN194PC00	
		1	 FIN5240SM	
		A2242		

388.72	670.14	359.29		175.32	175.05		
FIN823AF	FIN614PF	FIN902NF		FIN020FE	FIN4225OF		

				A2143			
				FIN243OP			

652.37	656.60	644.47	644.66	660.24	956.43		
FIN620FP	FIN260JP	FIN518NH	FIN050NO	FIN420E	FIN340DV		





696.78							
FIN038PU	FIN003CN						





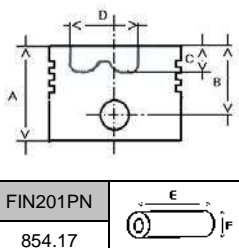

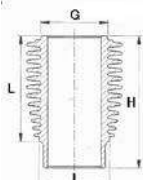

014.39	730.34	5840.142					
FIN930VA	FIN298VR	FIN142TL					

Ricambi non originali per motori. Denominazioni e codici originali, sono riportati a puro titolo di riferimento.

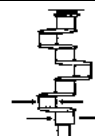
RUGGERINI

MD 95.1	Cm³	CILINDRI CYLINDERS	ALESAGGIO BORE	CORSA STROKE	VERSIONE VERSION
	426	1	85	75	

		TESTA HEAD	H13		3	2	TIPO TYPE	A	
		A	70		10	2			
		B	40		22	4		G	93
		C	13					H	134,4
		D	42,6					I	92
		E	64					L	97,4
		F	22				203.83		FIN027SL00
	85	A2146	FIN194PC00		A2052	FIN070RS00			
	85,5	A2147	FIN194PC05		2992	FIN070RS05			
	86	A2148	FIN194PC10		2993	FIN070RS10			

		Nr.						ADATTABILE A: SUITABLE FOR:	
---	---	------------	---	---	---	---	---	--------------------------------	---

CR	AL	1	40,00	43,66	22,00		STD - 025 - 050 075 - 100	A2637	FIN057CR STD
----	----	---	-------	-------	-------	--	------------------------------	-------	--------------

MB	AL	2	45,00	49,85	24,00		STD - 025 - 050 BAR	310.77	FIN077MB STD
----	----	---	-------	-------	-------	--	------------------------	--------	--------------





--	--	--	--	--	--	--	--	--	--



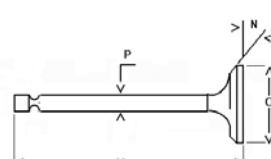

--	--	--	--	--	--	--	--	--	--

--	--	--	--	--	--	--	--	--	--

TW	AL	2	51,00	65,00	2,36		STD	060.17	FIN177TW STD
----	----	---	-------	-------	------	--	-----	--------	--------------

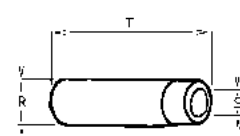
--	--	--	--	--	--	--	--	--	--

	IN EX		Nr.	O	P	M	N		ADATTABILE A: SUITABLE FOR:			
	IN		FS	1	35	7	84,5		45	A1	960.53	FINA158
	EX		FN	1	31	7	84,5		45	A1	960.54	FINS159

	IN EX		Nr.	R	S	T		ADATTABILE A: SUITABLE FOR:			
	IN		G	1	13,05	7,03		39	I	464.56	FIN208ASA
	IN		G		13,15	7,03		39	I	464.59	FIN208ASB
	IN		G	1	13,05	7,03		39	I	464.56	FIN208ASA
									464.59	FIN208ASB	

Ricambi non originali per motori. Denominazioni e codici originali, sono riportati a puro titolo di riferimento.

19 - 19
rel. 1511

Non original engine parts. OEMs names and part numbers are for reference purpose only.

RUGGERINI

MD 95.1	Cm³	CILINDRI CYLINDERS	ALESAGGIO BORE	CORSA STROKE	VERSIONE VERSION
	426	1	85	75	

	A2228	A2227			451.32	451.31	450.35	450.96
FIN4450CGA	FIN4450CGB	FIN5240SM	FIN3219RT	FIN3218RT	FIN211CO	FIN703CB	FIN508IG	FIN613EG

 	ADATTABILE A: SUITABLE FOR:		Nr.	ENGINE KIT	ELECTRIC KIT
	451.15	FIN508HG	1	 FIN027SL00	
			1	 FIN194PC00	
			1	 FIN5240SM	
			A2242	FIN0887KIT	

388.72	670.14	359.29		175.32	175.05		
FIN823AF	FIN614PF	FIN902NF		FIN020FE	FIN4225OF		

				A2143			
				FIN243OP			

652.37	656.60	644.47	644.66	660.24	956.43		
FIN620FP	FIN260JP	FIN518NH	FIN050NO	FIN420E	FIN340DV		

696.78							
FIN038PU	FIN003CN						

014.39	730.34	5840.142					
FIN930VA	FIN298VR	FIN142TL					

Ricambi non originali per motori. Denominazioni e codici originali, sono riportati a puro titolo di riferimento.



20 - 19







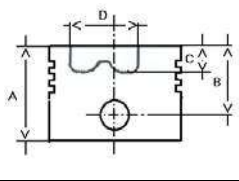

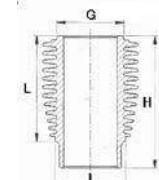
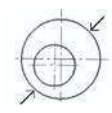
rel. 1511

Non original engine parts. OEMs names and part numbers are for reference purpose only.

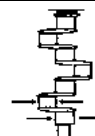
RUGGERINI

MD 170	Cm³	CILINDRI CYLINDERS	ALESAGGIO BORE	CORSA STROKE	VERSIONE VERSION
	737	2	85	65	

		TESTA HEAD			3	2	TIPO TYPE	A	
		A			10	2			
		B			22	4			
		C							
	FIN201PN		E 64					G	93
	854.17		F 22					H	134,4
								I	92
								L	97,4
	85	A2267	FIN029PC00	A2052	FIN070RS00		203.83	FIN027SL00	
	85,5		FIN029PC05	2992	FIN070RS05				
	86		FIN029PC10	2993	FIN070RS10				

		Nr.						ADATTABILE A: SUITABLE FOR:	
---	---	------------	---	---	---	---	---	--	---

CR	AL	2	40,00	43,66	22,00		STD - 025 - 050	A2637	FIN057CR STD
----	----	---	-------	-------	-------	--	-----------------	-------	--------------

MB	AL	2	45,00	49,85	24,00		STD - 025 - 050 BAR	310.77	FIN077MB STD
----	----	---	-------	-------	-------	--	------------------------	--------	--------------





MB	AL	1	45,00	47,98	24,12		STD - 025 - 050 075 - 100 - BAR	310.31	FIN031MB STD
----	----	---	-------	-------	-------	--	------------------------------------	--------	--------------



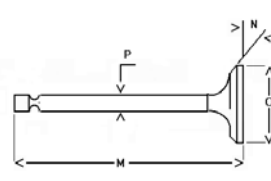

--	--	--	--	--	--	--	--	--	--

--	--	--	--	--	--	--	--	--	--

TW	AL	2	51,00	65,00	2,36		STD	060.17	FIN177TW STD
----	----	---	-------	-------	------	--	-----	--------	--------------

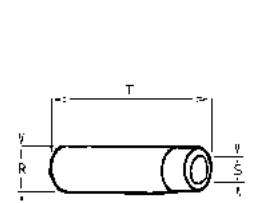
--	--	--	--	--	--	--	--	--	--

	IN EX		Nr.	O	P	M	N		ADATTABILE A: SUITABLE FOR:			
	IN		FS	2	37,5	7	84,5		45	A1	960.58	FINA156
	EX		FN	2	33	7	84,5		45	A1	960.59	FINS157

	IN EX		Nr.	R	S	T		ADATTABILE A: SUITABLE FOR:			
	IN		G	2	13,05	7,03		39	I	464.56	FIN208ASA
	IN		G		13,15	7,03		39	I	464.59	FIN208ASB
	IN		G	2	13,05	7,03		39	I	464.56	FIN208ASA
	IN		G		13,15	7,03		39	I	464.59	FIN208ASB

Ricambi non originali per motori. Denominazioni e codici originali, sono riportati a puro titolo di riferimento.

21 - 19

rel. 1511

Non original engine parts. OEMs names and part numbers are for reference purpose only.

RUGGERINI

MD 170	Cm³	CILINDRI CYLINDERS	ALESAGGIO BORE	CORSA STROKE	VERSIONE VERSION
	737	2	85	65	

	A2291	A2292			450.60	451.31	450.35	451.24
FIN4452CGA	FIN4452CGB	FIN5242SM	FIN3219RT	FIN3218RT	FIN707CO	FIN703CB	FIN508IG	FIN506EG

 ADATTABILE A: SUITABLE FOR:	 FIN508HG	Nr.	ENGINE KIT	ELECTRIC KIT
		1	 FIN027SL00	
		1	 FIN029PC00	
		1	 FIN5240SM	
		A2268	FIN3251KIT	

388.48	670.14	359.29		175.32	175.05		
FIN822AF	FIN614PF	FIN902NF		FIN020FE	FIN4225OF		

				A2143			
				FIN243OP			

652.26	656.60	644.54	644.55	660.24	956.43		
FIN626FP	FIN260JP	FIN520NH	FIN248NO	FIN420E	FIN340DV		

	FIN003CN						

014.39	730.34	563.54					
FIN930VA	FIN298VR	FIN708TL					

Ricambi non originali per motori. Denominazioni e codici originali, sono riportati a puro titolo di riferimento.

RUGGERINI

MD 171	Cm³	CILINDRI CYLINDERS	ALESAGGIO BORE	CORSA STROKE	VERSIONE VERSION
	737	2	85	65	

		TESTA HEAD	A	3	2	TIPO TYPE	A			
			B				10	2	G	93
			C				22	4	H	134,4
			D						I	92
		FIN201PN		E	A2052	FIN070RS00		L	97,4	
		854.17		F				22	203.83	FIN027SL00
	85	A2267	FIN029PC00	2992	FIN070RS05					
	85,5		FIN029PC05	2993	FIN070RS10					
	86		FIN029PC10							

		Nr.							ADATTABILE A: SUITABLE FOR:	
--	--	------------	--	--	--	--	--	--	--------------------------------	--

CR	AL	2	40,00	43,66	22,00		STD - 025 - 050	A2637	FIN057CR STD
----	----	---	-------	-------	-------	--	-----------------	-------	--------------

MB	AL	2	45,00	49,85	24,00		STD - 025 - 050 BAR	310.77	FIN077MB STD
----	----	---	-------	-------	-------	--	------------------------	--------	--------------

MB	AL	1	45,00	47,98	24,12		STD - 025 - 050 075 - 100 - BAR	310.31	FIN031MB STD
----	----	---	-------	-------	-------	--	------------------------------------	--------	--------------

--	--	--	--	--	--	--	--	--	--

--	--	--	--	--	--	--	--	--	--

TW	AL	2	51,00	65,00	2,36		STD	060.17	FIN177TW STD
----	----	---	-------	-------	------	--	-----	--------	--------------

--	--	--	--	--	--	--	--	--	--

	IN EX		Nr.	O	P	M	N		ADATTABILE A: SUITABLE FOR:								
	IN								FS	2	37,5	7	84,5	45	A1	960.58	FINA156
	EX								FN	2	33	7	84,5	45	A1	960.59	FINS157

	IN EX		Nr.	R	S	T		ADATTABILE A: SUITABLE FOR:							
	IN							G	2	13,05	7,03	39	I	464.56	FIN208ASA
	IN							G		13,15	7,03	39	I	464.59	FIN208ASB
	IN							G	2	13,05	7,03	39	I	464.56	FIN208ASA
	IN							G		13,15	7,03	39	I	464.59	FIN208ASB

Ricambi non originali per motori. Denominazioni e codici originali, sono riportati a puro titolo di riferimento.

RUGGERINI

MD 171	Cm³	CILINDRI CYLINDERS	ALESAGGIO BORE	CORSA STROKE	VERSIONE VERSION
	737	2	85	65	

	A2291	A2292			450.60	451.31	450.35	451.24
FIN4452CGA	FIN4452CGB	FIN5242SM	FIN3219RT	FIN3218RT	FIN707CO	FIN703CB	FIN508IG	FIN506EG

 ↓ === ↑	ADATTABILE A: SUITABLE FOR:		Nr.	ENGINE KIT	ELECTRIC KIT
	451.15	FIN508HG	1	 FIN027SL00	
			1	 FIN029PC00	
			1	 FIN5240SM	
			A2268	FIN3251KIT	

388.48	670.14	359.29		175.32	175.05		
FIN822AF	FIN614PF	FIN902NF		FIN020FE	FIN4225OF		

				A2143			
				FIN243OP			

652.26	656.60	644.54	644.55	660.24	956.43		
FIN626FP	FIN260JP	FIN520NH	FIN248NO	FIN420E	FIN340DV		

	FIN003CN						

014.39	730.34	563.54					
FIN930VA	FIN298VR	FIN708TL					

Ricambi non originali per motori. Denominazioni e codici originali, sono riportati a puro titolo di riferimento.



24 - 19







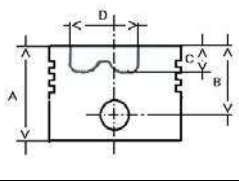
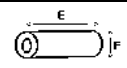

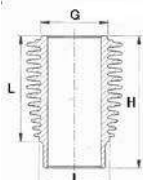
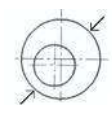
rel. 1511

Non original engine parts. OEMs names and part numbers are for reference purpose only.

RUGGERINI

MD 190	Cm³	CILINDRI CYLINDERS	ALESAGGIO BORE	CORSA STROKE	VERSIONE VERSION
	851	2	85	75	

		TESTA HEAD	A	3	2	TIPO TYPE	A	
			B				10	2
	FIN201PN	E	22	4			H	134,4
	854.17	F					A2052	FIN070RS00
	85	A2146	FIN194PC00	2992	FIN070RS05	203.83	L	97,4
	85,5	A2147	FIN194PC05	2993	FIN070RS10		FIN027SL00	
	86	A2148	FIN194PC10					

		Nr.						ADATTABILE A: SUITABLE FOR:	
--	---	------------	---	---	---	---	---	--	---

CR	AL	2	40,00	43,66	22,00		STD - 025 - 050 075 - 100	A2637	FIN057CR STD
----	----	---	-------	-------	-------	--	------------------------------	-------	--------------

MB	AL	2	45,00	49,85	24,00		STD - 025 - 050 BAR	310.77	FIN077MB STD
----	----	---	-------	-------	-------	--	------------------------	--------	--------------





MB	AL	1	45,00	47,98	24,12		STD - 025 - 050 - 075 - 100 - BAR	310.31	FIN031MB STD
----	----	---	-------	-------	-------	--	--------------------------------------	--------	--------------



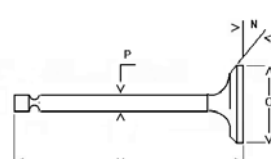

--	--	--	--	--	--	--	--	--	--

--	--	--	--	--	--	--	--	--	--

--	--	--	--	--	--	--	--	--	--

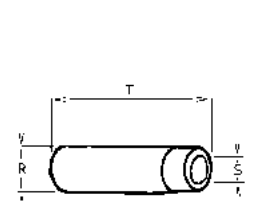
--	--	--	--	--	--	--	--	--	--

	IN EX		Nr.	O	P	M	N		ADATTABILE A: SUITABLE FOR:								
	IN								FS	2	35	7	84,5	45	A1	960.53	FINA158
	EX								FN	2	31	7	84,5	45	A1	960.54	FINS159

	IN EX		Nr.	R	S	T		ADATTABILE A: SUITABLE FOR:							
	IN							G	2	13,05	7,03	39	I	464.56	FIN208ASA
	IN							G		13,15	7,03	39	I	464.59	FIN208ASB
	IN							G	2	13,05	7,03	39	I	464.56	FIN208ASA

Ricambi non originali per motori. Denominazioni e codici originali, sono riportati a puro titolo di riferimento.

25 - 19
rel. 1511

Non original engine parts. OEMs names and part numbers are for reference purpose only.

RUGGERINI

MD 190	Cm³	CILINDRI CYLINDERS	ALESAGGIO BORE	CORSA STROKE	VERSIONE VERSION
	851	2	85	75	

	A2291	A2292			450.60	451.31	450.35	450.96
FIN4452CGA	FIN4452CGB	FIN5242SM	FIN3219RT	FIN3218RT	FIN707CO	FIN703CB	FIN508IG	FIN613EG

 ADATTABILE A: SUITABLE FOR:		Nr.	ENGINE KIT	ELECTRIC KIT
	451.15	1	 FIN027SL00	
		1	 FIN194PC00	
		1	 FIN5240SM	
		A2242		

388.48	670.14	359.29		175.32	175.25		
FIN822AF	FIN614PF	FIN902NF		FIN020FE	FIN4243OF		

				A2143			
				FIN243OP			

652.26	656.60	644.47	644.66	660.24	956.43		
FIN626FP	FIN260JP	FIN518NH	FIN050NO	FIN420E	FIN340DV		

	FIN003CN						

014.39	730.34	563.54					
FIN930VA	FIN298VR	FIN708TL					

Ricambi non originali per motori. Denominazioni e codici originali, sono riportati a puro titolo di riferimento.



26 - 19







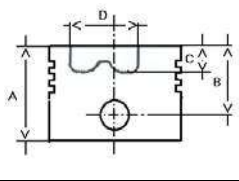

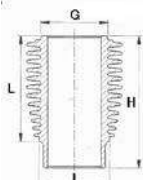
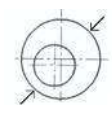
rel. 1511

Non original engine parts. OEMs names and part numbers are for reference purpose only.

RUGGERINI

MD 191	Cm³	CILINDRI CYLINDERS	ALESAGGIO BORE	CORSA STROKE	VERSIONE VERSION
	851	2	85	75	

		TESTA HEAD A B C D E F		3	2	TIPO TYPE 	A	
				10	2		G	93
	FIN201PN						H	134,4
	854.17						I	92
							L	97,4
	85	A2146	FIN194PC00	A2052	FIN070RS00	203.83	FIN027SL00	
	85,5	A2147	FIN194PC05	2992	FIN070RS05			
	86	A2148	FIN194PC10	2993	FIN070RS10			

		Nr.							ADATTABILE A: SUITABLE FOR:	
--	---	------------	---	---	---	---	---	--	--------------------------------	---

CR	AL	2	40,00	43,66	22,00			STD - 025 - 050 075 - 100	A2637	FIN057CR STD
----	----	---	-------	-------	-------	--	--	------------------------------	-------	--------------

MB	AL	2	45,00	49,85	24,00			STD - 025 - 050 BAR	310.77	FIN077MB STD
----	----	---	-------	-------	-------	--	--	------------------------	--------	--------------



MB	AL	1	45,00	47,98	24,12			STD - 025 - 050 - 075 - 100 - BAR	310.31	FIN031MB STD
----	----	---	-------	-------	-------	--	--	--------------------------------------	--------	--------------



--	--	--	--	--	--	--	--	--	--	--

--	--	--	--	--	--	--	--	--	--	--

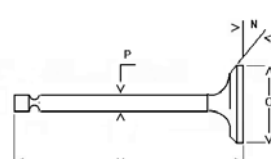
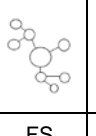
--	--	--	--	--	--	--	--	--	--	--

--	--	--	--	--	--	--	--	--	--	--

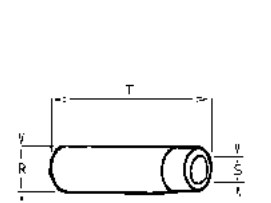
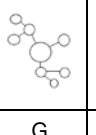
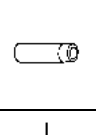
	IN EX		Nr.	O	P	M	N		ADATTABILE A: SUITABLE FOR:								
	IN								FS	2	35	7	84,5	45	A1	960.53	FINA158
	EX								FN	2	31	7	84,5	45	A1	960.54	FINS159

	IN EX		Nr.	R	S	T		ADATTABILE A: SUITABLE FOR:							
	IN							G	2	13,05	7,03	39	I	464.56	FIN208ASA
	IN							G		13,15	7,03	39	I	464.59	FIN208ASB
	IN							G	2	13,05	7,03	39	I	464.56	FIN208ASA
	IN	G		13,15	7,03	39	I	464.59	FIN208ASB						

Ricambi non originali per motori. Denominazioni e codici originali, sono riportati a puro titolo di riferimento.

27 - 19

rel. 1511

Non original engine parts. OEMs names and part numbers are for reference purpose only.

RUGGERINI

MD 191	Cm³	CILINDRI CYLINDERS	ALESAGGIO BORE	CORSA STROKE	VERSIONE VERSION
	851	2	85	75	

	A2291	A2292			450.60	451.31	450.35	450.96
FIN4452CGA	FIN4452CGB	FIN5242SM	FIN3219RT	FIN3218RT	FIN707CO	FIN703CB	FIN508IG	FIN613EG

 ↓ === ↑	ADATTABILE A: SUITABLE FOR:		Nr.	ENGINE KIT	ELECTRIC KIT
	451.15	FIN508HG	1	 FIN027SL00	
			1	 FIN194PC00	
			1	 FIN5240SM	
			A2242		

388.48	670.14	359.29		175.32	175.25		
FIN822AF	FIN614PF	FIN902NF		FIN020FE	FIN4243OF		

				A2143			
				FIN243OP			

652.26	656.60	644.47	644.66	660.24	956.43		
FIN626FP	FIN260JP	FIN518NH	FIN050NO	FIN420E	FIN340DV		

	FIN003CN						

014.39	730.34	563.54					
FIN930VA	FIN298VR	FIN708TL					

Ricambi non originali per motori. Denominazioni e codici originali, sono riportati a puro titolo di riferimento.





28 - 19





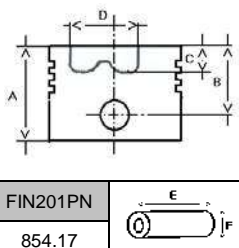

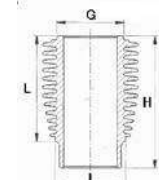

rel. 1511

Non original engine parts. OEMs names and part numbers are for reference purpose only.

RUGGERINI

MD 350	Cm³	CILINDRI CYLINDERS	ALESAGGIO BORE	CORSA STROKE	VERSIONE VERSION
	1566	3	85	92	

		TESTA HEAD	H03		3	2	TIPO TYPE	A	
					10	2			
					22	4		G	93
								H	155,4
								I	92
								L	115,4
	85	A2276	FIN701PC00	A2052	FIN070RS00	203.79		FIN710SL00	
	85,5		FIN701PC05	2992	FIN070RS05				
	86		FIN701PC10	2993	FIN070RS10				

		Nr.						ADATTABILE A: SUITABLE FOR:	
--	---	------------	---	---	---	---	---	--------------------------------	---

CR	AL	3	45,00	48,01	24,12		STD - 025 - 050 - 075 - 100	316.70	FIN2260CR STD
----	----	---	-------	-------	-------	--	-----------------------------	--------	---------------

MB	AL	2	50,00	53,00	23,10		STD - 025 - 050 BAR	311.03	FINR1551MB STD
----	----	---	-------	-------	-------	--	---------------------	--------	----------------





MB	AL	2	50,00	54,85	23,10		STD - 025 - 050	311.02	FINR1552MB STD
----	----	---	-------	-------	-------	--	-----------------	--------	----------------



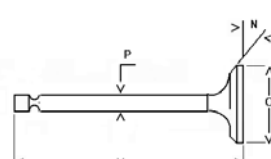

--	--	--	--	--	--	--	--	--	--

--	--	--	--	--	--	--	--	--	--

TW	AL	2	58,50	72,00	2,36		STD	060.16	FIN176TW STD
----	----	---	-------	-------	------	--	-----	--------	--------------

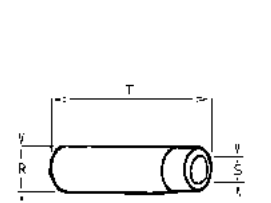
--	--	--	--	--	--	--	--	--	--

	IN EX		Nr.	O	P	M	N		ADATTABILE A: SUITABLE FOR:									
									IN	FS	3	37,5	7	84,5	45	A1	960.58	FINA156
									EX	FN	3	33	7	84,5	45	A1	960.59	FINS157

	IN EX		Nr.	R	S	T		ADATTABILE A: SUITABLE FOR:								
								IN	G	3	13,05	7,03	39	I	464.56	FIN208ASA
								IN	G		13,15	7,03	39	I	464.59	FIN208ASB
								IN	G	3	13,05	7,03	39	I	464.56	FIN208ASA
								464.59	FIN208ASB							

Ricambi non originali per motori. Denominazioni e codici originali, sono riportati a puro titolo di riferimento.

29 - 19

rel. 1511

Non original engine parts. OEMs names and part numbers are for reference purpose only.

RUGGERINI

MD 350	Cm³	CILINDRI CYLINDERS	ALESAGGIO BORE	CORSA STROKE	VERSIONE VERSION
	1566	3	85	92	

	A2273	A2274	A2207		451.17	451.31	451.27	451.24
FIN303CGA	FIN303CGB	FIN403SM	FIN3240RT		FIN220CO	FIN703CB	FIN501IG	FIN506EG

 ADATTABILE A: SUITABLE FOR:	 FIN508HG	Nr.	ENGINE KIT	ELECTRIC KIT
		1	 FIN701SL00	
		1	 FIN701PC00	
		1	 FIN402SM	
		A2278	FIN2422KIT	

388.78		359.25		175.19	175.24		
FIN378AF		FIN1051NF		FIN4240FE	FIN102OF		

652.12	656.60	644.47	644.66	660.24	956.43		
FIN681FP	FIN260JP	FIN518NH	FIN050NO	FIN420E	FIN340DV		

014.35	730.54	563.61					
FIN530VA	FIN492VR	FIN220TL					

Ricambi non originali per motori. Denominazioni e codici originali, sono riportati a puro titolo di riferimento.





30 - 19





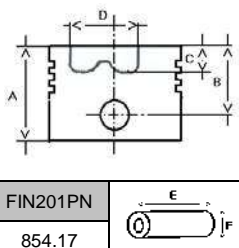

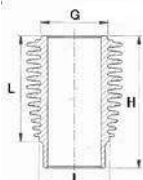

rel. 1511

Non original engine parts. OEMs names and part numbers are for reference purpose only.

RUGGERINI

MD 351	Cm³	CILINDRI CYLINDERS	ALESAGGIO BORE	CORSA STROKE	VERSIONE VERSION
	1566	3	85	92	

		TESTA HEAD	H03		3	2	TIPO TYPE	A	
					10	2			
					22	4			
									
					G	93			
					H	155,4			
I	92								
L	115,4								
		85	A2276	FIN701PC00	A2052	FIN070RS00	203.79	FIN710SL00	
		85,5		FIN701PC05	2992	FIN070RS05			
		86		FIN701PC10	2993	FIN070RS10			

		Nr.						ADATTABILE A: SUITABLE FOR:	
---	---	------------	---	---	---	---	---	--------------------------------	---

CR	AL	3	45,00	48,01	24,12		STD - 025 - 050 - 075 - 100	316.70	FIN2260CR STD
----	----	---	-------	-------	-------	--	-----------------------------	--------	---------------

MB	AL	2	50,00	53,00	23,10		STD - 025 - 050 BAR	311.03	FINR1551MB STD
----	----	---	-------	-------	-------	--	---------------------	--------	----------------





MB	AL	2	50,00	54,85	23,10		STD - 025 - 050	311.02	FINR1552MB STD
----	----	---	-------	-------	-------	--	-----------------	--------	----------------



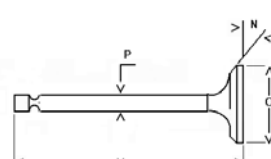

--	--	--	--	--	--	--	--	--	--

--	--	--	--	--	--	--	--	--	--

TW	AL	2	58,50	72,00	2,36		STD	060.16	FIN176TW STD
----	----	---	-------	-------	------	--	-----	--------	--------------

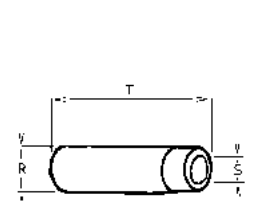
--	--	--	--	--	--	--	--	--	--

	IN EX		Nr.	O	P	M	N		ADATTABILE A: SUITABLE FOR:									
									IN	FS	3	37,5	7	84,5	45	A1	960.58	FINA156
									EX	FN	3	33	7	84,5	45	A1	960.59	FINS157

	IN EX		Nr.	R	S	T		ADATTABILE A: SUITABLE FOR:								
								IN	G	3	13,05	7,03	39	I	464.56	FIN208ASA
								IN	G		13,15	7,03	39	I	464.59	FIN208ASB
								IN	G	3	13,05	7,03	39	I	464.56	FIN208ASA
								IN	G		13,15	7,03	39	I	464.59	FIN208ASB

Ricambi non originali per motori. Denominazioni e codici originali, sono riportati a puro titolo di riferimento.

31 - 19
rel. 1511

Non original engine parts. OEMs names and part numbers are for reference purpose only.

RUGGERINI

MD 351	Cm³	CILINDRI CYLINDERS	ALESAGGIO BORE	CORSA STROKE	VERSIONE VERSION
	1566	3	85	92	

	A2273	A2274	A2207		451.17	451.31	451.27	451.24
FIN303CGA	FIN303CGB	FIN403SM	FIN3240RT		FIN220CO	FIN703CB	FIN501IG	FIN506EG

 ADATTABILE A: SUITABLE FOR:	 FIN508HG	Nr.	ENGINE KIT	ELECTRIC KIT
		1	 FIN701SL00	
		1	 FIN701PC00	
		1	 FIN402SM	
		A2278	FIN2422KIT	

388.78		359.25		175.19	175.24		
FIN378AF		FIN1051NF		FIN4240FE	FIN102OF		

652.12	656.60	644.47	644.66	660.24	956.43		
FIN681FP	FIN260JP	FIN518NH	FIN050NO	FIN420E	FIN340DV		

014.35	730.54	563.61					
FIN530VA	FIN492VR	FIN220TL					

Ricambi non originali per motori. Denominazioni e codici originali, sono riportati a puro titolo di riferimento.

RUGGERINI

MD

ALTRI ARTICOLI

OTHERS ITEMS

POS.	ARTICOLO	ITEM	MOTORE ENGINE	CODICE FINIMPIANTI FINIMPIANTI REF.	ADATTABILE A SUITABLE FOR:
1	Kit paraolio	Seal kit	MD 75.0 , MD 75.1 MD 150 , MD 151 MD 85.0 , MD 85.1 MD 95.0 , MD 95.1 MD 170 , MD 171 MD 190 , MD 191	FIN3220RTS (FIN3218RT + FIN3219RT)	A2125
2	Cartuccia filtro olio (76 mm)	Oil filter cartridge (76 mm)	All models	FIN4243OF	175.25
3	Guarnizione aspirazione	Inlet gasket	MD 150 , MD 151 MD 170 , MD 171 MD 190 , MD 191	FIN503IG	448.14
4	Anello asta bilanciere	Guard tube seal	All models	FIN086AP	579.12
5	Cappuccio Valvola	Valve cap	All models	FIN119CV	451.25
6					
7					
8					
9					
10					
11					
12					
13					
14					
15					
16					
17					
18					
19					
20					

RUGGERINI

MD

ALTRI ARTICOLI

OTHERS ITEMS

POS.	ARTICOLO	ITEM	MOTORE ENGINE	CODICE FINIMPIANTI FINIMPIANTI REF.	ADATTABILE A SUITABLE FOR:
21					
22					
23					
24					
25					
26					
27					
28					
29					
30					
31					
32					
33					
34					
35					
36					
37					
38					
39					
40					

**GRUPPO RY
RUGGERINI
FAMILY RY**

1	RY 50
3	RY 70
5	RY 85.0
7	RY 85.1
9	RY 75
11	RY 103
13	RY 100
15	RY 101
17	RY 110
19	RY 120
21	RY 121
23	RY 125
25	ALTRI ARTICOLI <i>OTHERS ITEMS</i>

Questo catalogo contiene dati ed informazioni provenienti dalla pluriennale esperienza di Finimpianti. Tuttavia non possiamo assumere alcuna responsabilità per eventuali dati errati od incompleti.

Tutti i dati e le informazioni contenute nel presente catalogo sono fornite a puro scopo informativo e senza responsabilità e non potranno dare adito ad alcuna forma di risarcimento.

Visto il continuo sviluppo dei nostri prodotti, Finimpianti si riserva il diritto di apportare modifiche senza preavviso.

Denominazioni, numeri e codici originali sono riportati a puro titolo di riferimento.

All the information and data contained in this catalogue came from the long Finimpianti experience. Nevertheless we can not assume any responsibility for possible mistakes.



All the information and data contained in this catalogue are provide "as is" without any representation or warranty express or implied. Under no circumstances whatsoever shall Finimpianti be liable for any damages whatsoever arising out of the use of the information and data contained in this catalogue.







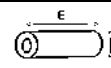
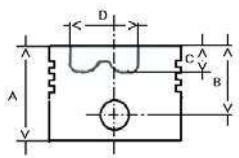

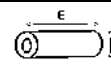
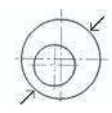
Finimpianti does not warrant the accuracy or completeness of the materials and content contained in this catalogue and reserves the right to correct any errors or omissions at any time without notice and without obligation to the users of this catalogue.

OEM names, codes and part numbers, used in this catalogue, are for reference only.

RUGGERINI

RY 50	Cm³	CILINDRI CYLINDERS	ALESAGGIO BORE	CORSA STROKE	VERSIONE VERSION
	224	1	69	80	

			TESTA HEAD	H03		3	2	TIPO TYPE	<table border="1"> <tr><td>G</td><td></td></tr> <tr><td>H</td><td></td></tr> <tr><td>I</td><td></td></tr> <tr><td>L</td><td></td></tr> </table>	G		H		I		L	
			G														
			H														
			I														
			L														
			A	65		10	1,5										
B	36	22	2														
C	11,9																
D	28,3																
E	44																
F	20																
FIN499PN				0082112510	FIN2340RS00												
0084800990				0082112520	FIN2340RS05												
				0082112530	FIN2340RS10												
		69	0065015380	FIN1630PC00													
		69,5	0065015390	FIN1630PC05													
		70	0065015400	FIN1630PC10													

		Nr.							ADATTABILE A: SUITABLE FOR:	
---	---	------------	---	---	---	---	---	---	--------------------------------	---

--	--	--	--	--	--	--	--	--	--	--

MB	RP	1	35,00	39,00	22,50			STD - 025 - 050 075 - 100 - BAR	0016111960	FIN3229MB STD
----	----	---	-------	-------	-------	--	--	------------------------------------	------------	---------------





--	--	--	--	--	--	--	--	--	--	--



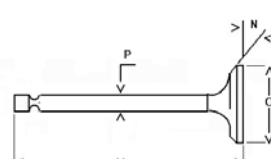

--	--	--	--	--	--	--	--	--	--	--

--	--	--	--	--	--	--	--	--	--	--

--	--	--	--	--	--	--	--	--	--	--

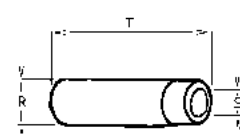
--	--	--	--	--	--	--	--	--	--	--

	IN EX		Nr.	O	P	M	N		ADATTABILE A: SUITABLE FOR:			
	IN		FS	1	31,5	6	82		45	A1	0096521480	FINA6110
	EX		FSN	1	27,5	6	82		45	A1	0096851510	FINS6111

	IN EX		Nr.	R	S	T		ADATTABILE A: SUITABLE FOR:			
	IN			1						0048452400	FIN6620AA
	IN										FIN6620AB
	EX			1						0048452410	FIN6621SA
	EX										FIN6621SB

Ricambi non originali per motori. Denominazioni e codici originali, sono riportati a puro titolo di riferimento.

1 - 20

rel. 1511

Non original engine parts. OEMs names and part numbers are for reference purpose only.

RUGGERINI

RY 50	Cm³	CILINDRI CYLINDERS	ALESAGGIO BORE	CORSA STROKE	VERSIONE VERSION
	224	1	69	80	

	0082051040		0012133610	0012133450		0044000580	0045000670	0045011290
FIN4331CGA	FIN4331CGB		FIN1007RT	FIN1006RT		FIN682CB	FIN470IG	FIN921EG

 ↓ === ↑ 1,0 mm 1,2 mm	ADATTABILE A: SUITABLE FOR:		Nr.	ENGINE KIT	ELECTRIC KIT
	0047306070	FIN350HG	1		
	0047306090	FIN351HG	1		
			1		

0037003740	0013010530	0054963420	0054962200	0037300960	0021751810		
FIN473AF	FIN253PF	FIN071NF	FIN022CFA	FIN396FE	FIN171OF		

				0066050900			
				FIN090OP			



0065850960							
FIN690FP							







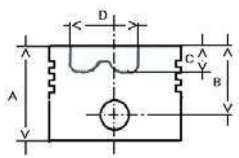

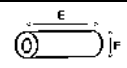
0085650780	0073622980						
FIN870VA	FIN298VR						

Ricambi non originali per motori. Denominazioni e codici originali, sono riportati a puro titolo di riferimento.

RUGGERINI

RY 70	Cm³	CILINDRI CYLINDERS	ALESAGGIO BORE	CORSA STROKE	VERSIONE VERSION
	315	1	78	66	

		TESTA HEAD	H03		3	2	TIPO TYPE	<table border="1"> <tr><td>G</td><td></td></tr> <tr><td>H</td><td></td></tr> <tr><td>I</td><td></td></tr> <tr><td>L</td><td></td></tr> </table>	G		H		I		L	
		G														
		H														
		I														
		L														
		A	72		10	2										
B	38	22	3													
C	12															
D	35,6															
E	54															
F	20															
FIN482PN		78	0065012500	FIN182PC00	0082112270	FIN059RS00										
0084800890		78,5	0065012510	FIN182PC05	0082112280	FIN059RS05										
		79	0065012520	FIN182PC10	0082112290	FIN059RS10										

		Nr.						ADATTABILE A: SUITABLE FOR:	
---	---	------------	---	---	---	---	---	--------------------------------	---

--	--	--	--	--	--	--	--	--	--

MB	RP	1	40,00	44,02	27,00		STD - 025 - 050 075 - 100 - BAR	0016111850	FIN3230MB STD
----	----	---	-------	-------	-------	--	------------------------------------	------------	---------------





--	--	--	--	--	--	--	--	--	--



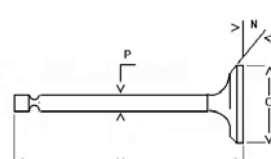

--	--	--	--	--	--	--	--	--	--

--	--	--	--	--	--	--	--	--	--

--	--	--	--	--	--	--	--	--	--

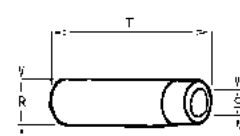
--	--	--	--	--	--	--	--	--	--

	IN EX		Nr.	O	P	M	N		ADATTABILE A: SUITABLE FOR:			
	IN		FS	1	36	7	91		45	A1	0096521300	FINA1568
	EX		FSN	1	32	7	91		45	A1	0096851330	FINS1569

	IN EX		Nr.	R	S	T		ADATTABILE A: SUITABLE FOR:			
	IN		G	1	11,05	7,03		40	I	0048452180	FIN6625AA
	IN		G		11,15	7,03		40	I		FIN6625AB
	EX		G	1	11,05	7,03		31	I	0048452190	FIN6626SA
	EX		G		11,15	7,03		31	I		FIN6626SB

Ricambi non originali per motori. Denominazioni e codici originali, sono riportati a puro titolo di riferimento.

3 - 20

rel. 1511

Non original engine parts. OEMs names and part numbers are for reference purpose only.

RUGGERINI

RY 70	Cm³	CILINDRI CYLINDERS	ALESAGGIO BORE	CORSA STROKE	VERSIONE VERSION
	315	1	78	66	

	0082051050		0012133610	0012133450		0044000580	0045000670	0045011300
FIN909CGA	FIN909CGB		FIN1007RT	FIN1006RT		FIN682CB	FIN470IG	FIN382EG

 ↓ === ↑	ADATTABILE A: SUITABLE FOR:		Nr.	ENGINE KIT	ELECTRIC KIT
	1,0 mm	0047306520	1		
	1,2 mm	0047306560	1		
	1,0 mm	0047304740	1		
1,2 mm	0047304760	FIN353HG			

0037003740	0013010530	0054963420	0054962200	0021750450	0021751550		
FIN473AF	FIN253PF	FIN071NF	FIN022CFA	FIN345FE	FIN429OF		

	0010508550			0066050900			
	FIN585CK			FIN090OP			





0065850960			0065314350				
FIN690FP			FIN410NO				





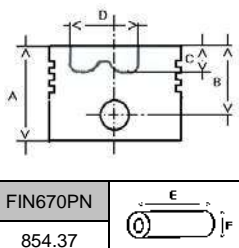

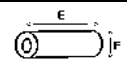
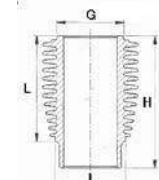

0085650780	0073622980						
FIN870VA	FIN298VR						

Ricambi non originali per motori. Denominazioni e codici originali, sono riportati a puro titolo di riferimento.

RUGGERINI

RY 85.0	Cm³	CILINDRI CYLINDERS	ALESAGGIO BORE	CORSA STROKE	VERSIONE VERSION
	382	1	80	76	

		TESTA HEAD			<table border="1"> <tr><td>3</td><td>2</td></tr> <tr><td>10</td><td>2</td></tr> <tr><td>22</td><td>3</td></tr> </table>	3	2	10	2	22	3	TIPO TYPE	A	
		3	2											
10	2													
22	3													
FIN670PN		A			G									
854.37		E	36			H								
	80	A2614	FIN705PC00	A2132	FIN068RS00	204.16	FIN724SL00							
	80,5		FIN705PC05		FIN068RS05									
	81		FIN705PC10		FIN068RS10									

		Nr.						ADATTABILE A: SUITABLE FOR:	
--	---	------------	---	---	---	---	---	--------------------------------	---

CR	AL	1	40,00	43,66	22,00		STD - 025 - 050 075 - 100	A2637	FIN057CR STD
----	----	---	-------	-------	-------	--	------------------------------	-------	--------------

MB	RP	2					STD - 025 - 050 BAR	311.19	FIN002MB STD
----	----	---	--	--	--	--	------------------------	--------	--------------





--	--	--	--	--	--	--	--	--	--



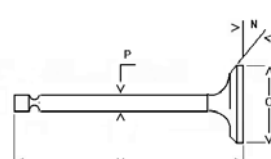

--	--	--	--	--	--	--	--	--	--

TW	AL	1					STD	060.88	FIN178TW STD
----	----	---	--	--	--	--	-----	--------	--------------

--	--	--	--	--	--	--	--	--	--

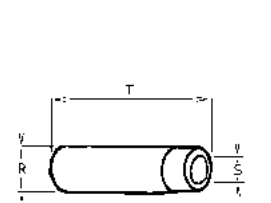
--	--	--	--	--	--	--	--	--	--

	IN EX		Nr.	O	P	M	N		ADATTABILE A: SUITABLE FOR:			
	IN		FS	1	35	7	84,5		45	A1	960.53	FINA158
	EX		FN	1	31	7	84,5		45	A1	960.54	FINS159

	IN EX		Nr.	R	S	T		ADATTABILE A: SUITABLE FOR:			
	IN		G	1	13,05	7,03		39	I	464.77	FIN208ASA
	IN		G		13,15	7,03		39	I	464.59	FIN208ASB
	EX		G	1	13,05	7,03		39	I	464.77	FIN208ASA
EX	G		13,15	7,03	39	I	464.59	FIN208ASB			

Ricambi non originali per motori. Denominazioni e codici originali, sono riportati a puro titolo di riferimento.

5 - 20

rel. 1511

Non original engine parts. OEMs names and part numbers are for reference purpose only.

RUGGERINI

RY 85.0	Cm³	CILINDRI CYLINDERS	ALESAGGIO BORE	CORSA STROKE	VERSIONE VERSION
	382	1	80	76	

	A2611	A2608				453.76	453.23	451.24
FIN307CGA	FIN307CGB	FIN5264SM	FIN3241RT	FIN3241RT		FIN705CB	FIN505IG	FIN506EG

 ↓ === ↑	ADATTABILE A: SUITABLE FOR:		Nr.	ENGINE KIT	ELECTRIC KIT
	0,8 mm	453.33	1	 FIN724SL00	
	1,0 mm	453.35	1	 FIN705PC00	
	1,1 mm	453.36	1	 FIN5264SM	
			A2624	FIN2427KIT	

389.20	059.72	359.24		391.44	175.05		
FIN291AF	FIN091PF	FIN1035NF		FIN640FE	FIN4225OF		





652.41	656.76	644.86	644.89		956.68		
FIN645FP	FIN248JP	FIN767NH	FIN582NO		FIN666DV		





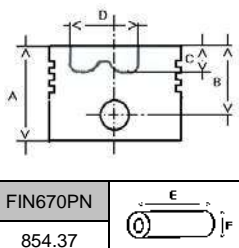
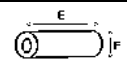

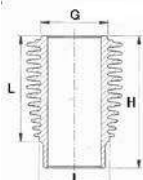

014.39	730.34	563.78					
FIN930VA	FIN298VR	FIN403TL					

Ricambi non originali per motori. Denominazioni e codici originali, sono riportati a puro titolo di riferimento.

RUGGERINI

RY 85.1	Cm³	CILINDRI CYLINDERS	ALESAGGIO BORE	CORSA STROKE	VERSIONE VERSION
	382	1	80	76	

		TESTA HEAD	A	36				A
			B	10,5				
FIN670PN		E	67					
854.37		F	22					
	80	A2614	FIN705PC00	A2132	FIN068RS00	204.16	FIN724SL00	
	80,5		FIN705PC05		FIN068RS05			
	81		FIN705PC10		FIN068RS10			

		Nr.							ADATTABILE A: SUITABLE FOR:	
--	---	------------	---	---	---	---	---	--	--------------------------------	---

CR	AL	1	40,00	43,66	22,00			STD - 025 - 050 075 - 100	A2637	FIN057CR STD
----	----	---	-------	-------	-------	--	--	------------------------------	-------	--------------

MB	RP	2						STD - 025 - 050 BAR	311.19	FIN002MB STD
----	----	---	--	--	--	--	--	------------------------	--------	--------------





--	--	--	--	--	--	--	--	--	--	--



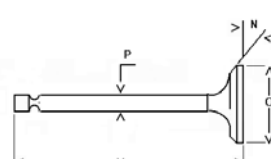

--	--	--	--	--	--	--	--	--	--	--

TW	AL	1						STD	060.88	FIN178TW STD
----	----	---	--	--	--	--	--	-----	--------	--------------

--	--	--	--	--	--	--	--	--	--	--

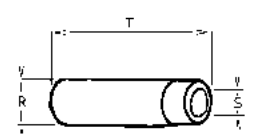
--	--	--	--	--	--	--	--	--	--	--

	IN EX		Nr.	O	P	M	N		ADATTABILE A: SUITABLE FOR:			
	IN		FS	1	35	7	84,5		45	A1	960.53	FINA158
	EX		FN	1	31	7	84,5		45	A1	960.54	FINS159

	IN EX		Nr.	R	S	T		ADATTABILE A: SUITABLE FOR:			
	IN		G	1	13,05	7,03		39	I	464.77	FIN208ASA
	IN		G		13,15	7,03		39	I	464.59	FIN208ASB
	EX		G	1	13,05	7,03		39	I	464.77	FIN208ASA
EX	G		13,15	7,03	39	I	464.59	FIN208ASB			

Ricambi non originali per motori. Denominazioni e codici originali, sono riportati a puro titolo di riferimento.

7 - 20

rel. 1511

Non original engine parts. OEMs names and part numbers are for reference purpose only.

RUGGERINI

RY 85.1	Cm³	CILINDRI CYLINDERS	ALESAGGIO BORE	CORSA STROKE	VERSIONE VERSION
	382	1	80	76	

	A2611	A2608				453.76	453.23	451.24
FIN307CGA	FIN307CGB	FIN5264SM	FIN3241RT	FIN3241RT		FIN705CB	FIN505IG	FIN506EG

 ↓ === ↑	ADATTABILE A: SUITABLE FOR:		Nr.	ENGINE KIT	ELECTRIC KIT
	0,8 mm	453.33	1	 FIN724SL00	
	1,0 mm	453.35	1	 FIN705PC00	
	1,1 mm	453.36	1	 FIN5264SM	
			A2624	FIN2427KIT	

389.20	059.72	359.24		391.44	175.05		
FIN291AF	FIN091PF	FIN1035NF		FIN640FE	FIN4225OF		

652.41	656.76	644.86	644.89		956.68		
FIN645FP	FIN248JP	FIN767NH	FIN582NO		FIN666DV		

014.39	730.34	563.78					
FIN930VA	FIN298VR	FIN403TL					

Ricambi non originali per motori. Denominazioni e codici originali, sono riportati a puro titolo di riferimento.





8 - 20





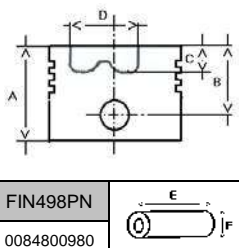

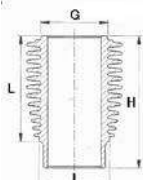

rel. 1511

Non original engine parts. OEMs names and part numbers are for reference purpose only.

RUGGERINI

RY 75	Cm³	CILINDRI CYLINDERS	ALESAGGIO BORE	CORSA STROKE	VERSIONE VERSION
	349	1	82	66	

		TESTA HEAD	H03		3	2	TIPO TYPE		G	H	I	L
		A	70,1		10	1,5						
		B	38,1		22	2						
		C	11,5									
		D	39,5									
		E	48									
		F	22									
	FIN498PN											
	0084800980											
	82	0065014870	FIN1632PC00	0082112390	FIN2606RS00							
	82,5	0065014880	FIN1632PC05	0082112400	FIN2606RS05							
	83	0065014890	FIN1632PC10	0082112410	FIN2606RS10							

		Nr.						ADATTABILE A: SUITABLE FOR:	
---	---	------------	---	---	---	---	---	--------------------------------	---

--	--	--	--	--	--	--	--	--	--

MB	RP	1	40,00	44,02	27,00		STD - 025 - 050 075 - 100 - BAR	0016111850	FIN3230MB STD
----	----	---	-------	-------	-------	--	------------------------------------	------------	---------------





--	--	--	--	--	--	--	--	--	--



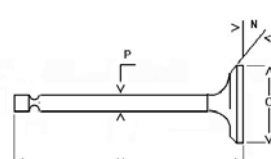

--	--	--	--	--	--	--	--	--	--

--	--	--	--	--	--	--	--	--	--

--	--	--	--	--	--	--	--	--	--

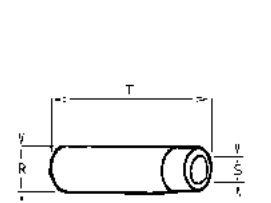
--	--	--	--	--	--	--	--	--	--

	IN EX		Nr.	O	P	M	N		ADATTABILE A: SUITABLE FOR:	
	IN	FS	1	36	7	91	45	A1	0096521300	FINA1568
	EX	FSN	1	32	7	91	45	A1	0096851330	FINS1569

	IN EX		Nr.	R	S	T		ADATTABILE A: SUITABLE FOR:	
	IN	G	1	11,05	7,03	40	I	0048452180	FIN6625AA
	IN	G		11,15	7,03	40	I		FIN6625AB
	EX	G	1	11,05	7,03	31	I	0048452190	FIN6626SA
	EX	G		11,15	7,03	31	I		FIN6626SB

Ricambi non originali per motori. Denominazioni e codici originali, sono riportati a puro titolo di riferimento.

9 - 20

rel. 1511

Non original engine parts. OEMs names and part numbers are for reference purpose only.

RUGGERINI

RY 75	Cm³	CILINDRI CYLINDERS	ALESAGGIO BORE	CORSA STROKE	VERSIONE VERSION
	349	1	82	66	

	8180.199		0012133610	0012133450		0044000580	0045000670	0045000790
FIN4330CGA	FIN4330CGB		FIN1007RT	FIN1006RT		FIN682CB	FIN470IG	FIN370EG

 ↓ === ↑	ADATTABILE A: SUITABLE FOR:		Nr.	ENGINE KIT	ELECTRIC KIT
	1,0 mm	0047307480	1		
	1,2 mm	0047307500	1		
	1,0 mm	0047307350	1		
1,2 mm	0047307370	FIN355HG			

0037003740	0013010530	0054960710	0054963330	0021750450	0021751550		
FIN473AF	FIN253PF	FIN071NF	FIN022CFA	FIN345FE	FIN429OF		

	0010508550			0066050900			
	FIN585CK			FIN090OP			

0065850950			0065314470				
FIN066FP			FIN411NO				

0085650780	0073622980						
FIN870VA	FIN298VR						

Ricambi non originali per motori. Denominazioni e codici originali, sono riportati a puro titolo di riferimento.





10 - 20





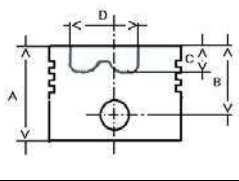

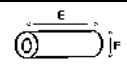

rel. 1511

Non original engine parts. OEMs names and part numbers are for reference purpose only.

RUGGERINI

RY 103	Cm³	CILINDRI CYLINDERS	ALESAGGIO BORE	CORSA STROKE	VERSIONE VERSION
	401	1	82	76	

		TESTA HEAD			3	2	TIPO TYPE	
		A	73		10	1,5		G
		B	41		22	2		H
		C						I
		D						L
		E	53					
0084801030		F	23					
	82	0065017690	FIN1682PC00	0082112390	FIN2606RS00			
	82,5	0065017700	FIN1682PC05	0082112400	FIN2606RS05			
	83	0065017710	FIN1682PC10	0082112410	FIN2606RS10			

		Nr.							ADATTABILE A: SUITABLE FOR:	
---	---	------------	---	---	---	---	---	---	--------------------------------	---

--	--	--	--	--	--	--	--	--	--	--

MB	RP	1						STD - 025 - 050 075 - 100 - BAR	0016112090	FIN3228MB STD
----	----	---	--	--	--	--	--	------------------------------------	------------	---------------





--	--	--	--	--	--	--	--	--	--	--



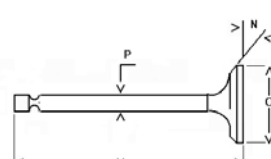

--	--	--	--	--	--	--	--	--	--	--

--	--	--	--	--	--	--	--	--	--	--

--	--	--	--	--	--	--	--	--	--	--

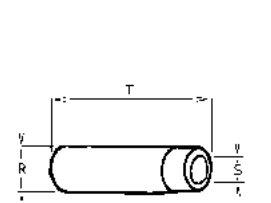
--	--	--	--	--	--	--	--	--	--	--

	IN EX		Nr.	O	P	M	N		ADATTABILE A: SUITABLE FOR:	
	IN		1						0096521630	FINA6115
	EX		1						0096851550	FINS6116

	IN EX		Nr.	R	S	T		ADATTABILE A: SUITABLE FOR:	
	IN	G	1	11,05	7,03	40	I	0048452180	FIN6625AA
	IN	G		11,15	7,03	40	I		FIN6625AB
	EX	G	1	11,05	7,03	31	I	0048452190	FIN6626SA
	EX	G		11,15	7,03	31	I		FIN6626SB

Ricambi non originali per motori. Denominazioni e codici originali, sono riportati a puro titolo di riferimento.

11 - 20

rel. 1511

Non original engine parts. OEMs names and part numbers are for reference purpose only.

RUGGERINI

RY 103	Cm³	CILINDRI CYLINDERS	ALESAGGIO BORE	CORSA STROKE	VERSIONE VERSION
	401	1	82	76	

	0082051250		0012133960	0012133900		0044000580	0045000670	0045011130
FIN4334CGA	FIN4334CGB		FIN830RT	FIN831RT		FIN682CB	FIN470IG	FIN382EG

 ↓ === ↑	ADATTABILE A: SUITABLE FOR:		Nr.	ENGINE KIT	ELECTRIC KIT
	1,0 mm	0047307510	1		
	1,2 mm	0047307530	1		
	1,0 mm	0047307590	1		
1,2 mm	0047307610	FIN359HG			

0037003740	0013010530	0054960710	0054963330	0037300960	0021751550		
FIN473AF	FIN253PF	FIN071NF	FIN022CFA	FIN396FE	FIN429OF		

				0066050900			
				FIN090OP			

0065851030							
FIN301FP							

0085650780	0073622550						
FIN870VA	FIN255VR						

Ricambi non originali per motori. Denominazioni e codici originali, sono riportati a puro titolo di riferimento.



12 - 20







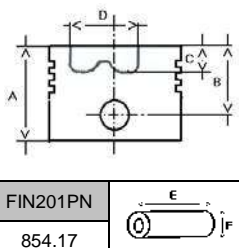

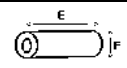
rel. 1511

Non original engine parts. OEMs names and part numbers are for reference purpose only.

RUGGERINI

RY 100	Cm³	CILINDRI CYLINDERS	ALESAGGIO BORE	CORSA STROKE	VERSIONE VERSION
	431	1	85	76	

		TESTA HEAD				TIPO TYPE	A	
		A					G	
		B	36				H	
		C	11,6				I	
		D	50,4				L	
		E	64					
FIN201PN		F	22	A2617	FIN403RS00	204.17	FIN723SL00	
854.17		85	A2615	FIN704PC00				

		Nr.						ADATTABILE A: SUITABLE FOR:	
---	---	------------	---	---	---	---	---	--------------------------------	---

CR	AL	1	40,00	43,66	22,00		STD - 025 - 050 075 - 100	A2637	FIN057CR STD
----	----	---	-------	-------	-------	--	------------------------------	-------	--------------

MB	RP	2					STD - 025 - 050 BAR	311.19	FIN002MB STD
----	----	---	--	--	--	--	------------------------	--------	--------------





--	--	--	--	--	--	--	--	--	--



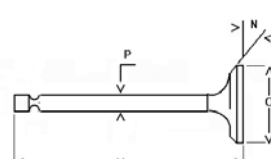

--	--	--	--	--	--	--	--	--	--

TW	AL	1					STD	060.88	FIN178TW STD
----	----	---	--	--	--	--	-----	--------	--------------

--	--	--	--	--	--	--	--	--	--

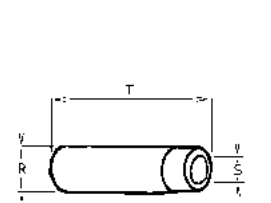
--	--	--	--	--	--	--	--	--	--

	IN EX		Nr.	O	P	M	N		ADATTABILE A: SUITABLE FOR:			
	IN		FS	1	37,5	7	84,5		45	A1	960.58	FINA156
	EX		FN	1	33	7	84,5		45	A1	960.59	FINS157

	IN EX		Nr.	R	S	T		ADATTABILE A: SUITABLE FOR:			
	IN		G	1	13,05	7,03		39	I	464.77	FIN208ASA
	IN		G		13,15	7,03		39	I	464.59	FIN208ASB
	EX		G	1	13,05	7,03		39	I	464.77	FIN208ASA
	EX		G		13,15	7,03		39	I	464.59	FIN208ASB

Ricambi non originali per motori. Denominazioni e codici originali, sono riportati a puro titolo di riferimento.

13 - 20

rel. 1511

Non original engine parts. OEMs names and part numbers are for reference purpose only.

RUGGERINI

RY 100	Cm³	CILINDRI CYLINDERS	ALESAGGIO BORE	CORSA STROKE	VERSIONE VERSION
	431	1	85	76	

	A2612	A2609				453.76	453.23	451.24
FIN306CGA	FIN306CGB	FIN5263SM	FIN3241RT	FIN3241RT		FIN705CB	FIN505IG	FIN506EG

 ↓ === ↑	ADATTABILE A: SUITABLE FOR:		Nr.	ENGINE KIT	ELECTRIC KIT
	0,8 mm	435.37	1	 FIN723SL00	
	1,0 mm	453.39	1	 FIN704PC00	
	1,1 mm	453.40	1	 FIN5263SM	
			A2625	FIN2426KIT	

389.20	059.72	359.24		391.44	175.05		
FIN291AF	FIN091PF	FIN1035NF		FIN640FE	FIN4225OF		

652.41	656.76	644.84	644.85		956.68		
FIN645FP	FIN248JP	FIN764NH	FIN581NO		FIN666DV		

014.39	730.34	563.78					
FIN930VA	FIN298VR	FIN403TL					

Ricambi non originali per motori. Denominazioni e codici originali, sono riportati a puro titolo di riferimento.





14 - 20





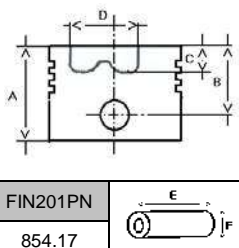

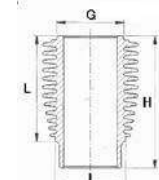
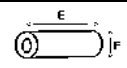

rel. 1511

Non original engine parts. OEMs names and part numbers are for reference purpose only.

RUGGERINI

RY 101	Cm³	CILINDRI CYLINDERS	ALESAGGIO BORE	CORSA STROKE	VERSIONE VERSION
	431	1	85	76	

		TESTA HEAD				A	
		A				G	
		B	36			H	
		C	11,6			I	
		D	50,4			L	
		E	64			FIN723SL00	
FIN201PN		FIN704PC00					
854.17		A2617	FIN403RS00				
	85	A2615			204.17		

		Nr.						ADATTABILE A: SUITABLE FOR:	
--	---	------------	---	---	---	---	---	--------------------------------	---

CR	AL	1	40,00	43,66	22,00			STD - 025 - 050 075 - 100	A2637	FIN057CR STD
----	----	---	-------	-------	-------	--	--	------------------------------	-------	--------------

MB	RP	2						STD - 025 - 050 BAR	311.19	FIN002MB STD
----	----	---	--	--	--	--	--	------------------------	--------	--------------





--	--	--	--	--	--	--	--	--	--	--



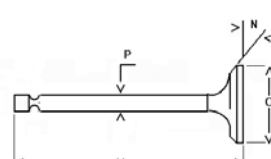

--	--	--	--	--	--	--	--	--	--	--

TW	AL	1						STD	060.88	FIN178TW STD
----	----	---	--	--	--	--	--	-----	--------	--------------

--	--	--	--	--	--	--	--	--	--	--

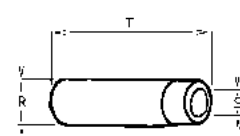
--	--	--	--	--	--	--	--	--	--	--

	IN EX		Nr.	O	P	M	N		ADATTABILE A: SUITABLE FOR:			
	IN		FS	1	37,5	7	84,5		45	A1	960.58	FINA156
	EX		FN	1	33	7	84,5		45	A1	960.59	FINS157

	IN EX		Nr.	R	S	T		ADATTABILE A: SUITABLE FOR:			
	IN		G	1	13,05	7,03		39	I	464.77	FIN208ASA
	IN		G		13,15	7,03		39	I	464.59	FIN208ASB
	EX		G	1	13,05	7,03		39	I	464.77	FIN208ASA
	EX		G		13,15	7,03		39	I	464.59	FIN208ASB

Ricambi non originali per motori. Denominazioni e codici originali, sono riportati a puro titolo di riferimento.

15 - 20
rel. 1511

Non original engine parts. OEMs names and part numbers are for reference purpose only.

RUGGERINI

RY 101	Cm³	CILINDRI CYLINDERS	ALESAGGIO BORE	CORSA STROKE	VERSIONE VERSION
	431	1	85	76	

	A2612	A2609				453.76	453.23	451.24
FIN306CGA	FIN306CGB	FIN5263SM	FIN3241RT	FIN3241RT		FIN705CB	FIN505IG	FIN506EG

 ↓ === ↑	ADATTABILE A: SUITABLE FOR:		Nr.	ENGINE KIT	ELECTRIC KIT
	0,8 mm	435.37	1	 FIN723SL00	
	1,0 mm	453.39	1	 FIN704PC00	
	1,1 mm	453.40	1	 FIN5263SM	
			A2625	FIN2426KIT	

389.20	059.72	359.24		391.44	175.05		
FIN291AF	FIN091PF	FIN1035NF		FIN640FE	FIN4225OF		

652.41	656.76	644.84	644.85		956.68		
FIN645FP	FIN248JP	FIN764NH	FIN581NO		FIN666DV		

014.39	730.34	563.78					
FIN930VA	FIN298VR	FIN403TL					

Ricambi non originali per motori. Denominazioni e codici originali, sono riportati a puro titolo di riferimento.



16 - 20







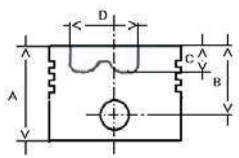

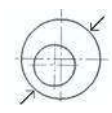
rel. 1511

Non original engine parts. OEMs names and part numbers are for reference purpose only.

RUGGERINI

RY 110	Cm³	CILINDRI CYLINDERS	ALESAGGIO BORE	CORSA STROKE	VERSIONE VERSION
	442	1	86	76	

		TESTA HEAD			3	2	TIPO TYPE	
		A	73		10	1,5		
		B	41		22	2,5		
		C						
		D						
	FIN503PN	E	53					
	0084801030	F	23					
	86	0065018910	FIN881PC00	0082112600	FIN2670RS00			
	86,5	0065018920	FIN881PC05	0082112610	FIN2670RS05			
	87	0065018930	FIN881PC10	0082112620	FIN2670RS10			

		Nr.						ADATTABILE A: SUITABLE FOR:	
---	---	------------	---	---	---	---	---	--------------------------------	---

--	--	--	--	--	--	--	--	--	--

MB	RP	1					STD - 025 - 050 - 075 - 100 - BAR	0016112090	FIN3228MB STD
----	----	---	--	--	--	--	--------------------------------------	------------	---------------





--	--	--	--	--	--	--	--	--	--



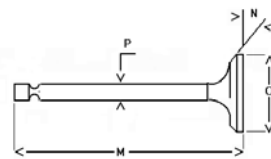

--	--	--	--	--	--	--	--	--	--

--	--	--	--	--	--	--	--	--	--

--	--	--	--	--	--	--	--	--	--

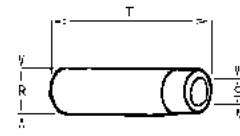
--	--	--	--	--	--	--	--	--	--

	IN EX		Nr.	O	P	M	N		ADATTABILE A: SUITABLE FOR:	
	IN		1						0096521630	FINA6115
	EX		1						0096851550	FINS6116

	IN EX		Nr.	R	S	T		ADATTABILE A: SUITABLE FOR:	
	IN	G	1	11,05	7,03	40	I	0048452180	FIN6625AA
	IN	G		11,15	7,03	40	I		FIN6625AB
	EX	G	1	11,05	7,03	31	I	0048452190	FIN6626SA
	EX	G		11,15	7,03	31	I		FIN6626SB

Ricambi non originali per motori. Denominazioni e codici originali, sono riportati a puro titolo di riferimento.

17 - 20

rel. 1511

Non original engine parts. OEMs names and part numbers are for reference purpose only.

RUGGERINI

RY 110	Cm³	CILINDRI CYLINDERS	ALESAGGIO BORE	CORSA STROKE	VERSIONE VERSION
	442	1	86	76	

	0082051250		0012133960	0012133900		0044000580	0045000670	0045011130
FIN4334CGA	FIN4334CGB		FIN830RT	FIN831RT		FIN682CB	FIN470IG	FIN382EG

 ADATTABILE A: SUITABLE FOR:		Nr.	ENGINE KIT	ELECTRIC KIT 		
	1,0 mm	0047307540	FIN360HG		1	
	1,2 mm	0047307560	FIN361HG		1	
	1,0 mm	0047307620	FIN362HG		1	
1,2 mm	0047307640	FIN363HG				

0037003740	0013010530	0054960710	0054963330	0037300960	0021751550		
FIN473AF	FIN253PF	FIN071NF	FIN022CFA	FIN396FE	FIN429OF		

				0066050900			
				FIN090OP			



0065851030							
FIN301FP							







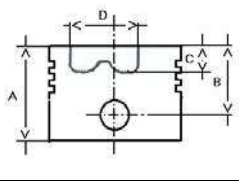

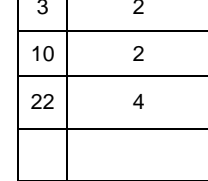
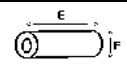
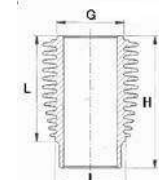
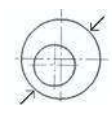
0085650780	0073622550						
FIN870VA	FIN255VR						

Ricambi non originali per motori. Denominazioni e codici originali, sono riportati a puro titolo di riferimento.

RUGGERINI

RY 120	Cm³	CILINDRI CYLINDERS	ALESAGGIO BORE	CORSA STROKE	VERSIONE VERSION
	505	1	87	85	

		TESTA HEAD				TIPO TYPE	A		
		A							
		B	40						
		C							
		D							
		E	67,5						
FIN200PN		F	22	A2618	FIN402RS00 FIN402RS05 FIN402RS10		G		
854.12								H	
								I	
	87	A2616	FIN703PC00			204.14	FIN702SL00		
	87,5		FIN703PC05						
	88		FIN703PC10						

		Nr.						ADATTABILE A: SUITABLE FOR:	
---	---	------------	---	---	---	---	---	--	---

CR	AL	1	40,05	43,66	24,38		STD - 025 - 050 - 075 - 100	A2628	FIN043CR STD
----	----	---	-------	-------	-------	--	-----------------------------	-------	--------------

MB	RP	2					STD - 025 - 050 BAR	311.19	FIN002MB STD
----	----	---	--	--	--	--	---------------------	--------	--------------





--	--	--	--	--	--	--	--	--	--



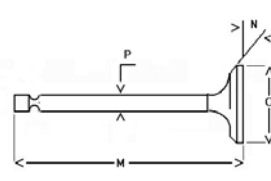

--	--	--	--	--	--	--	--	--	--

TW	AL	1					STD	060.88	FIN178TW STD
----	----	---	--	--	--	--	-----	--------	--------------

--	--	--	--	--	--	--	--	--	--

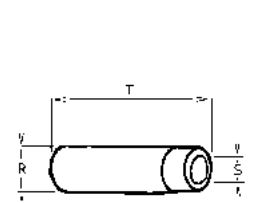
--	--	--	--	--	--	--	--	--	--

	IN EX		Nr.	O	P	M	N		ADATTABILE A: SUITABLE FOR:				
	IN		FS	1	37,5	7	84,5		45		A1	960.58	FINA156
	EX		FN	1	33	7	84,5		45		A1	960.59	FINS157

	IN EX		Nr.	R	S	T		ADATTABILE A: SUITABLE FOR:				
	IN		G	1	13,05	7,03		39		I	464.77	FIN208ASA
	IN		G		13,15	7,03		39		I	464.59	FIN208ASB
	EX		G	1	13,05	7,03		39		I	464.77	FIN208ASA
	EX		G		13,15	7,03		39		I	464.59	FIN208ASB

Ricambi non originali per motori. Denominazioni e codici originali, sono riportati a puro titolo di riferimento.

19 - 20

rel. 1511

Non original engine parts. OEMs names and part numbers are for reference purpose only.

RUGGERINI

RY 120	Cm³	CILINDRI CYLINDERS	ALESAGGIO BORE	CORSA STROKE	VERSIONE VERSION
	505	1	87	85	

	A2613	A2610				453.76	453.23	451.24
FIN305CGA	FIN305CGB	FIN5262SM	FIN3241RT	FIN3241RT		FIN705CB	FIN505IG	FIN506EG

 ↓ === ↑	ADATTABILE A: SUITABLE FOR:		Nr.	ENGINE KIT	ELECTRIC KIT
	0,8 mm	453.28	1	 FIN702SL00	
	1,0 mm	453.30	1	 FIN703PC00	
	1,1 mm	453.31	1	 FIN5262SM	
			A2626	FIN2423KIT	

388.29	059.90	359.26	060.48	391.44	175.05		
FIN290AF	FIN090PF	FIN821NF	FIN840CFA	FIN640FE	FIN4225OF		

652.41	656.76	644.87	644.88		956.68		
FIN645FP	FIN248JP	FIN765NH	FIN580NO		FIN666DV		

014.39	730.34	563.78					
FIN930VA	FIN298VR	FIN403TL					

Ricambi non originali per motori. Denominazioni e codici originali, sono riportati a puro titolo di riferimento.

20 - 20

rel. 1511

Non original engine parts. OEMs names and part numbers are for reference purpose only.

RUGGERINI

RY 121	Cm³	CILINDRI CYLINDERS	ALESAGGIO BORE	CORSA STROKE	VERSIONE VERSION
	505	1	87	85	

		TESTA HEAD				TIPO TYPE		A			
		A					G				
		B	40				H				
		C					I				
		D					L				
		E	67,5								
FIN200PN											
854.12											
	87	A2616	FIN703PC00		A2618	FIN402RS00		204.14		FIN702SL00	
	87,5		FIN703PC05			FIN402RS05					
	88		FIN703PC10			FIN402RS10					

		Nr.								ADATTABILE A: SUITABLE FOR:	
--	--	------------	--	--	--	--	--	--	--	--------------------------------	--

CR	AL	1	40,05	43,66	24,38				STD - 025 - 050 - 075 - 100	A2628	FIN043CR STD
----	----	---	-------	-------	-------	--	--	--	-----------------------------	-------	--------------

MB	RP	2							STD - 025 - 050 BAR	311.19	FIN002MB STD
----	----	---	--	--	--	--	--	--	---------------------	--------	--------------

--	--	--	--	--	--	--	--	--	--	--	--

--	--	--	--	--	--	--	--	--	--	--	--

TW	AL	1							STD	060.88	FIN178TW STD
----	----	---	--	--	--	--	--	--	-----	--------	--------------

--	--	--	--	--	--	--	--	--	--	--	--

--	--	--	--	--	--	--	--	--	--	--	--

	IN EX		Nr.	O	P	M	N		ADATTABILE A: SUITABLE FOR:	
	IN	FS	1	37,5	7	84,5	45	A1	960.58	FINA156
	EX	FN	1	33	7	84,5	45	A1	960.59	FINS157

	IN EX		Nr.	R	S	T		ADATTABILE A: SUITABLE FOR:	
	IN	G	1	13,05	7,03	39	I	464.77	FIN208ASA
	IN	G		13,15	7,03	39	I	464.59	FIN208ASB
	EX	G	1	13,05	7,03	39	I	464.77	FIN208ASA
	EX	G		13,15	7,03	39	I	464.59	FIN208ASB

Ricambi non originali per motori. Denominazioni e codici originali, sono riportati a puro titolo di riferimento.

21 - 20
rel. 1511

Non original engine parts. OEMs names and part numbers are for reference purpose only.

RUGGERINI

RY 121	Cm³	CILINDRI CYLINDERS	ALESAGGIO BORE	CORSA STROKE	VERSIONE VERSION
	505	1	87	85	

	A2613	A2610				453.76	453.23	451.24
FIN305CGA	FIN305CGB	FIN5262SM	FIN3241RT	FIN3241RT		FIN705CB	FIN505IG	FIN506EG

 ↓ === ↑	ADATTABILE A: SUITABLE FOR:		Nr.	ENGINE KIT	ELECTRIC KIT
	0,8 mm	453.28	1	 FIN702SL00	
	1,0 mm	453.30	1	 FIN703PC00	
	1,1 mm	453.31	1	 FIN5262SM	
			A2626	FIN2423KIT	

388.29	059.90	359.26	060.48	391.44	175.05		
FIN290AF	FIN090PF	FIN821NF	FIN840CFA	FIN640FE	FIN4225OF		

652.41	656.76	644.87	644.88		956.68		
FIN645FP	FIN248JP	FIN765NH	FIN580NO		FIN666DV		

014.39	730.34	563.78					
FIN930VA	FIN298VR	FIN403TL					

Ricambi non originali per motori. Denominazioni e codici originali, sono riportati a puro titolo di riferimento.

22 - 20

rel. 1511

Non original engine parts. OEMs names and part numbers are for reference purpose only.

RUGGERINI

RY 125	Cm³	CILINDRI CYLINDERS	ALESAGGIO BORE	CORSA STROKE	VERSIONE VERSION
	505	1	87	85	

		TESTA HEAD				TIPO TYPE A	
		A					
		B	40				
		C					
		D					
		E	67,5				
FIN200PN		F	22	A2618	FIN402RS00	G	
854.12					FIN402RS05	H	
					FIN402RS10	I	
	87	A2616	FIN703PC00			L	
	87,5		FIN703PC05				
	88		FIN703PC10				
						204.14	FIN702SL00

		Nr.						ADATTABILE A: SUITABLE FOR:	
--	--	------------	--	--	--	--	--	--------------------------------	--

CR	AL	1	40,05	43,66	24,38		STD - 025 - 050 - 075 - 100	A2628	FIN043CR STD
----	----	---	-------	-------	-------	--	-----------------------------	-------	--------------

MB	RP	2					STD - 025 - 050 BAR	311.19	FIN002MB STD
----	----	---	--	--	--	--	---------------------	--------	--------------

--	--	--	--	--	--	--	--	--	--

--	--	--	--	--	--	--	--	--	--

TW	AL	1					STD	060.88	FIN178TW STD
----	----	---	--	--	--	--	-----	--------	--------------

--	--	--	--	--	--	--	--	--	--

--	--	--	--	--	--	--	--	--	--

	IN EX		Nr.	O	P	M	N		ADATTABILE A: SUITABLE FOR:				
	IN		FS	1	37,5	7	84,5		45		A1	960.58	FINA156
	EX		FN	1	33	7	84,5		45		A1	960.59	FINS157

	IN EX		Nr.	R	S	T		ADATTABILE A: SUITABLE FOR:				
	IN		G	1	13,05	7,03		39		I	464.77	FIN208ASA
	IN		G		13,15	7,03		39		I	464.59	FIN208ASB
	EX		G	1	13,05	7,03		39		I	464.77	FIN208ASA
	EX	G		13,15	7,03	39	I	464.59	FIN208ASB			

Ricambi non originali per motori. Denominazioni e codici originali, sono riportati a puro titolo di riferimento.

23 - 20
rel. 1511

Non original engine parts. OEMs names and part numbers are for reference purpose only.

RUGGERINI

RY 125	Cm³	CILINDRI CYLINDERS	ALESAGGIO BORE	CORSA STROKE	VERSIONE VERSION
	505	1	87	85	

	A2613	A2610				453.76	453.23	451.24
FIN305CGA	FIN305CGB	FIN5262SM	FIN3241RT	FIN3241RT		FIN705CB	FIN505IG	FIN506EG

 ↓ === ↑	ADATTABILE A: SUITABLE FOR:		Nr.	ENGINE KIT	ELECTRIC KIT
	0,8 mm	453.28	1	 FIN702SL00	
	1,0 mm	453.30	1	 FIN703PC00	
	1,1 mm	453.31	1	 FIN5262SM	
			A2626	FIN2423KIT	

388.29	059.90	359.26	060.48	391.44	0021751950		
FIN290AF	FIN090PF	FIN821NF	FIN840CFA	FIN640FE	FIN4225OF		

652.41	656.76	644.84	644.88		956.68		
FIN645FP	FIN248JP	FIN764NH	FIN580NO		FIN666DV		

014.39	730.34	563.78					
FIN930VA	FIN298VR	FIN403TL					

Ricambi non originali per motori. Denominazioni e codici originali, sono riportati a puro titolo di riferimento.

24 - 20

rel. 1511

Non original engine parts. OEMs names and part numbers are for reference purpose only.

RUGGERINI

RY

ALTRI ARTICOLI

OTHERS ITEMS

POS.	ARTICOLO	ITEM	MOTORE ENGINE	CODICE FINIMPIANTI FINIMPIANTI REF.	ADATTABILE A SUITABLE FOR:
1	Cartuccia filtro combustibile	<i>Fuel filter cartridge</i>	RY 50	FIN345FE	0021750450
2	Cartuccia filtro combustibile	<i>Fuel filter cartridge</i>	RY 70	FIN396FE	3730.096
3	Cartuccia filtro combustibile	<i>Fuel filter cartridge</i>	RY 85.0 , RY 85.1 RY 100 , RY 101	FIN641FE	391.40
4	Cartuccia filtro aria	<i>Air cleaner cartridge</i>	RY 85.0 , RY 85.1 RY 100 , RY 101 RY 120 , RY 121	FIN275AF	175.52
5	Guarnizione aspirazione	<i>Inlet gasket</i>	RY 85.0 , RY 85.1 RY 100 , RY 101	FIN503IG	448.14
6	Cartuccia filtro olio	<i>Oil filter cartridge</i>	All models	FIN4228OF	395.15
7	Kit anelli di tenuta	<i>Seal rings kit</i>	RY 85.0 , RY 85.1 RY 100 , RY 101 RY 120 , RY 121 RY 125	FIN3223RTS (FIN3241RT + FIN3241RT)	054.12
8					
9					
10					
11					
12					
13					
14					
15					
16					
17					
18					
19					
21					

RUGGERINI

RY

ALTRI ARTICOLI

OTHERS ITEMS

POS.	ARTICOLO	ITEM	MOTORE ENGINE	CODICE FINIMPIANTI FINIMPIANTI REF.	ADATTABILE A SUITABLE FOR:
22					
23					
24					
25					
26					
27					
28					
29					
30					
31					
32					
33					
34					
35					
36					
37					
38					
39					
40					

GRUPPO CRD – P – RP RUGGERINI FAMILY CRD – P – RP	
1	CRD 951
3	CRD 951 / 2
5	CRD 100
7	CRD 100 / 2
9	P 101
11	P 101 L
13	P 101 / 2
15	P 101 / 2L
17	P 105 / 2
19	P 105 / 2R
21	P 105 / 2L
23	RP 280
25	RP 170
27	RP 178
29	RP 320
31	RP 328
33	RP 360
35	RP 368
37	RP 380
39	RP 388
41	ALTRI ARTICOLI <i>OTHERS ITEMS</i>

Questo catalogo contiene dati ed informazioni provenienti dalla pluriennale esperienza di Finimpianti. Tuttavia non possiamo assumere alcuna responsabilità per eventuali dati errati od incompleti.

Tutti i dati e le informazioni contenute nel presente catalogo sono fornite a puro scopo informativo e senza responsabilità e non potranno dare adito ad alcuna forma di risarcimento.

Visto il continuo sviluppo dei nostri prodotti, Finimpianti si riserva il diritto di apportare modifiche senza preavviso.

Denominazioni, numeri e codici originali sono riportati a puro titolo di riferimento.

All the information and data contained in this catalogue came from the long Finimpianti experience. Nevertheless we can not assume any responsibility for possible mistakes.





All the information and data contained in this catalogue are provide "as is" without any representation or warranty express or implied. Under no circumstances whatsoever shall Finimpianti be liable for any damages whatsoever arising out of the use of the information and data contained in this catalogue.





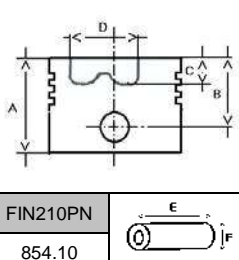

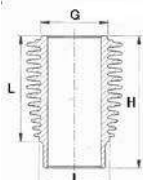

Finimpianti does not warrant the accuracy or completeness of the materials and content contained in this catalogue and reserves the right to correct any errors or omissions at any time without notice and without obligation to the users of this catalogue.

OEM names, codes and part numbers, used in this catalogue, are for reference only.

RUGGERINI

CRD 951	Cm³	CILINDRI CYLINDERS	ALESAGGIO BORE	CORSA STROKE	VERSIONE VERSION
	673	1	95	95	

		TESTA HEAD	H14		3	2,5	TIPO TYPE		G	H	I	L	
					1	2,5							
	FIN210PN	E	F	E	84	F	28	2175	FIN075RS00	2176	FIN075RS05	2177	FIN075RS10
	854.10								95		2170		FIN201PC00

		Nr.							ADATTABILE A: SUITABLE FOR:	
---	---	------------	---	---	---	---	---	--	--------------------------------	---

CR	AL	1	58,74	62,42	24,71		STD - 025 - 050 - 075 - 100	316.30	FIN030CR STD
----	----	---	-------	-------	-------	--	-----------------------------	--------	--------------

MB	ALL	1	50,00	65,03	34,00		STD - 025 - 050 - 075 - 100 - BAR - BAR EM1	310.21	FIN021MB STD
----	-----	---	-------	-------	-------	--	---	--------	--------------





MB	ALL	1	45,00	56,02	53,00		STD - 025 - 050 - 075 - 100 - BAR - BAR EM1	310.26	FIN026MB STD
----	-----	---	-------	-------	-------	--	---	--------	--------------



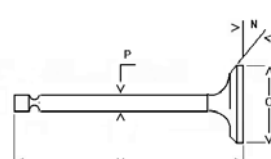

--	--	--	--	--	--	--	--	--	--

--	--	--	--	--	--	--	--	--	--

PB	BM	1	28,02	32,02	30,25		SEMIF.	316.35	FIN035PB
----	----	---	-------	-------	-------	--	--------	--------	----------

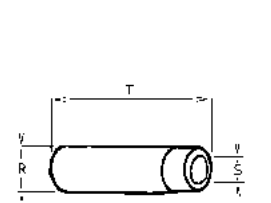
--	--	--	--	--	--	--	--	--	--

	IN EX		Nr.	O	P	M	N		ADATTABILE A: SUITABLE FOR:									
									IN	FS	1	37,8	9	119	45	E1	960.13	FINA119
									EX	FN	1	37,8	9	119	45	A1	960.18	FINS120

	IN EX		Nr.	R	S	T		ADATTABILE A: SUITABLE FOR:								
								IN	G	1	15,03	9,04	55	L	464.42	FIN201AA
								IN	G		15,13	9,04	55	L	464.30	FIN201AB
								EX	G	1	15,03	9,06	55	L	464.41	FIN202SA
								EX	G		15,13	9,06	55	L	464.20	FIN202SB

Ricambi non originali per motori. Denominazioni e codici originali, sono riportati a puro titolo di riferimento.

1 - 21

rel. 1511

Non original engine parts. OEMs names and part numbers are for reference purpose only.

RUGGERINI

CRD 951	Cm³	CILINDRI CYLINDERS	ALESAGGIO BORE	CORSA STROKE	VERSIONE VERSION
	673	1	95	95	

	2166	2396			448.15	447.60	448.06	448.06
FIN113CGA	FIN113CGB	FIN087SM	FIN3224RT	FIN3223RT	FIN207CO	FIN285CB	FIN610IG	FIN610IG

 ADATTABILE A: SUITABLE FOR:	 FIN629HG	Nr.		ENGINE KIT		ELECTRIC KIT	
		1					
		1					
		1					



387.62		359.16		175.20			
FIN2220AF		FIN1040NF		FIN4232FE			







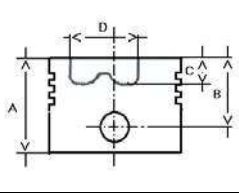

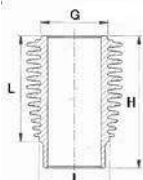
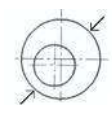
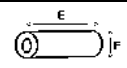
	656.42	644.43	644.46	660.17	956.27		
	FIN702JP	FIN524NH	FIN179NO	FIN011E	FIN016DV		

Ricambi non originali per motori. Denominazioni e codici originali, sono riportati a puro titolo di riferimento.

RUGGERINI

CRD 951/2	Cm³	CILINDRI CYLINDERS	ALESAGGIO BORE	CORSA STROKE	VERSIONE VERSION
	1346	2	95	95	

		TESTA HEAD	H14		3	2,5	TIPO TYPE		G	H	I	L		
					1	2,5								
	FIN210PN		A	111	2175	FIN075RS00	2176	FIN075RS05	2177	FIN075RS10				
	854.10		E	84							F	28		
	95	2170	FIN201PC00											
	95,5	2171	FIN201PC05											
	96	2172	FIN201PC10											

		Nr.							ADATTABILE A: SUITABLE FOR:	
---	---	------------	---	---	---	---	---	--	--------------------------------	---

CR	AL	2	58,74	62,42	24,71		STD - 025 - 050 - 075 - 100	316.30	FIN030CR STD
----	----	---	-------	-------	-------	--	-----------------------------	--------	--------------

MB	ALL	1	50,00	65,03	34,00		STD - 025 - 050 - 075 - 100 - BAR - BAR EM1	310.21	FIN021MB STD
----	-----	---	-------	-------	-------	--	---	--------	--------------





MB	ALL	1	45,00	56,02	53,00		STD - 025 - 050 - 075 - 100 - BAR - BAR EM1	310.26	FIN026MB STD
----	-----	---	-------	-------	-------	--	---	--------	--------------



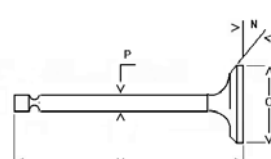

MB	ALL	1	58,74	62,42	36,00		STD - 025 - 050 - 075 - 100	310.06	FIN006MB STD
----	-----	---	-------	-------	-------	--	-----------------------------	--------	--------------

--	--	--	--	--	--	--	--	--	--

PB	BM	2	28,02	32,02	30,25		SEMIF.	316.35	FIN035PB
----	----	---	-------	-------	-------	--	--------	--------	----------

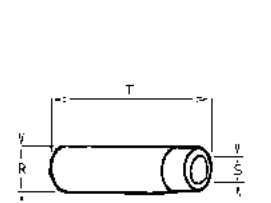
--	--	--	--	--	--	--	--	--	--

	IN EX		Nr.	O	P	M	N		ADATTABILE A: SUITABLE FOR:			
	IN		FS	2	37,8	9	119		45	E1	960.13	FINA119
	EX		FN	2	37,8	9	119		45	A1	960.18	FINS120

	IN EX		Nr.	R	S	T		ADATTABILE A: SUITABLE FOR:			
	IN		G	2	15,03	9,04		55	L	464.42	FIN201AA
	IN		G		15,13	9,04		55	L	464.30	FIN201AB
	EX		G	2	15,03	9,06		55	L	464.41	FIN202SA
	EX		G		15,13	9,06		55	L	464.20	FIN202SB

Ricambi non originali per motori. Denominazioni e codici originali, sono riportati a puro titolo di riferimento.

3 - 21

rel. 1511

Non original engine parts. OEMs names and part numbers are for reference purpose only.

RUGGERINI

CRD 951/2	Cm³	CILINDRI CYLINDERS	ALESAGGIO BORE	CORSA STROKE	VERSIONE VERSION
	1346	2	95	95	

	2203	2398			447.73	447.60	448.06	448.06
FIN2284CGA	FIN2284CGB	FIN2182SM	FIN3224RT	FIN3216RT	FIN208CO	FIN285CB	FIN610IG	FIN610IG

 	ADATTABILE A: SUITABLE FOR:		Nr.	ENGINE KIT	ELECTRIC KIT
	447.54	FIN629HG	1		
			1		
			1		

387.62		359.16		175.19	175.22		
FIN2220AF		FIN1040NF		FIN4240FE	FIN4245OF		

				2197			
				FIN438OP			



	656.49	644.43	644.46	660.17	956.27		
	FIN711JP	FIN524NH	FIN179NO	FIN011E	FIN016DV		







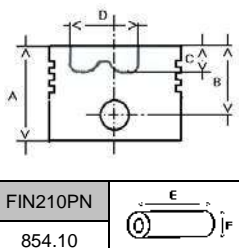

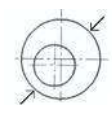
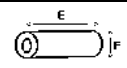
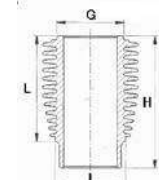
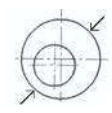
014.18	730.13	563.02					
FIN698VA	FIN238VR	FIN734TL					

Ricambi non originali per motori. Denominazioni e codici originali, sono riportati a puro titolo di riferimento.

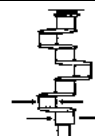
RUGGERINI

CRD 100	Cm³	CILINDRI CYLINDERS	ALESAGGIO BORE	CORSA STROKE	VERSIONE VERSION
	746	1	100	95	

		TESTA HEAD	H14		3	2,5	TIPO TYPE	A	
		A	130		1	2,5			
	FIN210PN		B	55	10	2,5		G	118
	854.10		C	17,5	22	5		H	195,4
	100	2183	D	49			I	108	
	100,5	2184	E	84	2188	FIN077RS00	L	145,4	
	101	2185	F	28	2189	FIN077RS05	203.11		FIN034SL00
					2190	FIN077RS10			

		Nr.						ADATTABILE A: SUITABLE FOR:	
---	---	------------	---	---	---	---	---	--------------------------------	---

CR	AL	1	58,74	62,42	24,71		STD - 025 - 050 - 075 - 100	316.30	FIN030CR STD
----	----	---	-------	-------	-------	--	-----------------------------	--------	--------------

MB	ALL	1	50,00	65,03	34,00		STD - 025 - 050 - 075 - 100 - BAR - BAR EM1	310.21	FIN021MB STD
----	-----	---	-------	-------	-------	--	---	--------	--------------





MB	ALL	1	45,00	56,02	53,00		STD - 025 - 050 - 075 - 100 - BAR - BAR EM1	310.26	FIN026MB STD
----	-----	---	-------	-------	-------	--	---	--------	--------------



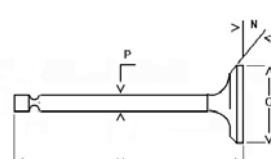

--	--	--	--	--	--	--	--	--	--

--	--	--	--	--	--	--	--	--	--

PB	BM	1	28,02	32,02	30,25		SEMIF.	316.35	FIN035PB
----	----	---	-------	-------	-------	--	--------	--------	----------

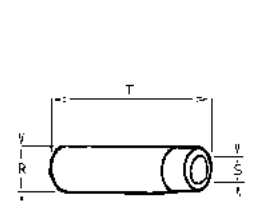
--	--	--	--	--	--	--	--	--	--

	IN EX		Nr.	O	P	M	N		ADATTABILE A: SUITABLE FOR:			
	IN		FS	1	42,5	9	119		45	E1	960.20	FINA122
	EX		FN	1	40	9	119		45	A1	960.21	FINS123

	IN EX		Nr.	R	S	T		ADATTABILE A: SUITABLE FOR:			
	IN		G	1	15,03	9,04		55	L	464.42	FIN201AA
	IN		G		15,13	9,04		55	L	464.30	FIN201AB
	EX		G	1	15,03	9,06		55	L	464.41	FIN202SA
	EX		G		15,13	9,06		55	L	464.20	FIN202SB

Ricambi non originali per motori. Denominazioni e codici originali, sono riportati a puro titolo di riferimento.

5 - 21

rel. 1511

Non original engine parts. OEMs names and part numbers are for reference purpose only.

RUGGERINI

CRD 100	Cm³	CILINDRI CYLINDERS	ALESAGGIO BORE	CORSA STROKE	VERSIONE VERSION
	746	1	100	95	

	2180	2395			448.15	447.60	448.06	448.06
FIN116CGA	FIN116CGB	FIN090SM	FIN3224RT	FIN3223RT	FIN207CO	FIN285CB	FIN610IG	FIN610IG

 ↓ === ↑	ADATTABILE A: SUITABLE FOR:		Nr.	ENGINE KIT	ELECTRIC KIT
	447.85	FIN626HG	1	 FIN034SL00	
			1	 FIN204PC00	
			1	 FIN090SM	
				FIN0965KIT	

387.62		359.16		175.20			
FIN2220AF		FIN1040NF		FIN4232FE			



	FIN089CK						







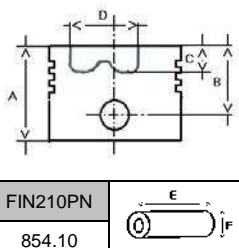

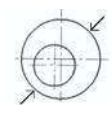
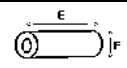
	656.42	644.43	644.46	660.17	956.27		
	FIN702JP	FIN524NH	FIN179NO	FIN011E	FIN016DV		

Ricambi non originali per motori. Denominazioni e codici originali, sono riportati a puro titolo di riferimento.

RUGGERINI

CRD 100/2	Cm³	CILINDRI CYLINDERS	ALESAGGIO BORE	CORSA STROKE	VERSIONE VERSION
	1492	2	100	95	

		TESTA HEAD	H14		3	2,5	TIPO TYPE	A	
		A	130		1	2,5		G	118
	FIN210PN 854.10		B	55	10	2,5	H	195,4	
			C	17,5	22	5	I	108	
			D	49			L	145,4	
			E	84	2188	FIN077RS00	203.11		FIN034SL00
			F	28	2189	FIN077RS05			
	100	2183	FIN204PC00		2190	FIN077RS10			
	100,5	2184	FIN204PC05						
	101	2185	FIN204PC10						

		Nr.						ADATTABILE A: SUITABLE FOR:	
---	---	------------	---	---	---	---	---	--------------------------------	---

CR	AL	2	58,74	62,42	24,71		STD - 025 - 050 - 075 - 100	316.30	FIN030CR STD
----	----	---	-------	-------	-------	--	-----------------------------	--------	--------------

MB	ALL	1	50,00	65,03	34,00		STD - 025 - 050 - 075 - 100 - BAR - BAR EM1	310.21	FIN021MB STD
----	-----	---	-------	-------	-------	--	---	--------	--------------





MB	ALL	1	45,00	56,02	53,00		STD - 025 - 050 - 075 - 100 - BAR - BAR EM1	310.26	FIN026MB STD
----	-----	---	-------	-------	-------	--	---	--------	--------------



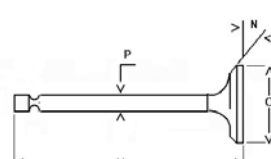

MB	ALL	1	58,74	62,42	36,00		STD - 025 - 050 - 075 - 100	310.06	FIN006MB STD
----	-----	---	-------	-------	-------	--	-----------------------------	--------	--------------

--	--	--	--	--	--	--	--	--	--

PB	BM	2	28,02	32,02	30,25		SEMIF.	316.35	FIN035PB
----	----	---	-------	-------	-------	--	--------	--------	----------

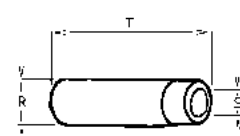
--	--	--	--	--	--	--	--	--	--

	IN EX		Nr.	O	P	M	N		ADATTABILE A: SUITABLE FOR:			
	IN		FS	2	42,5	9	119		45	E1	960.20	FINA122
	EX		FN	2	40	9	119		45	A1	960.21	FINS123

	IN EX		Nr.	R	S	T		ADATTABILE A: SUITABLE FOR:			
	IN		G	2	15,03	9,04		55	L	464.42	FIN201AA
	IN		G		15,13	9,04		55	L	464.30	FIN201AB
	EX		G	2	15,03	9,06		55	L	464.41	FIN202SA
	EX		G		15,13	9,06		55	L	464.20	FIN202SB

Ricambi non originali per motori. Denominazioni e codici originali, sono riportati a puro titolo di riferimento.

7 - 21

rel. 1511

Non original engine parts. OEMs names and part numbers are for reference purpose only.

RUGGERINI

CRD 100/2	Cm³	CILINDRI CYLINDERS	ALESAGGIO BORE	CORSA STROKE	VERSIONE VERSION
	1492	2	100	95	

	2204	2397			447.73	447.60	448.06	448.06
FIN117CGA	FIN117CGB	FIN091SM	FIN3224RT	FIN3216RT	FIN208CO	FIN285CB	FIN610IG	FIN610IG

 	ADATTABILE A: SUITABLE FOR:		Nr.	ENGINE KIT	ELECTRIC KIT
	447.85	FIN626HG	1	 FIN034SL00	
			1	 FIN204PC00	
			1	 FIN090SM FIN0965KIT	

387.62		359.16		175.19	175.22		
FIN2220AF		FIN1040NF		FIN4240FE	FIN4245OF		

				2197			
				FIN438OP			





	656.49	644.43	644.46	660.17	956.27		
	FIN711JP	FIN524NH	FIN179NO	FIN011E	FIN016DV		





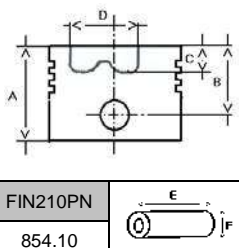

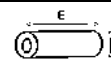

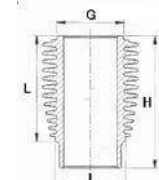
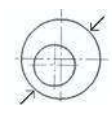
014.18	730.13	563.02					
FIN698VA	FIN238VR	FIN734TL					

Ricambi non originali per motori. Denominazioni e codici originali, sono riportati a puro titolo di riferimento.

RUGGERINI

P 101	Cm³	CILINDRI CYLINDERS	ALESAGGIO BORE	CORSA STROKE	VERSIONE VERSION
	746	1	100	95	

		TESTA HEAD	H14		3	2,5	TIPO TYPE	A	
		A	130		1	2,5			
	FIN210PN	E	84		10	2,5		G	118
	854.10	F	28		22	5		H	195,4
	100	2183	FIN204PC00	2188	FIN077RS00	203.11	FIN034SL00	I	108
	100,5	2184	FIN204PC05	2189	FIN077RS05			L	145,4
	101	2185	FIN204PC10	2190	FIN077RS10				

		Nr.						ADATTABILE A: SUITABLE FOR:	
---	---	------------	---	---	---	---	---	--------------------------------	---

CR	AL	1	58,74	62,42	24,71		STD - 025 - 050 - 075 - 100	316.30	FIN030CR STD
----	----	---	-------	-------	-------	--	-----------------------------	--------	--------------

MB	ALL	1	50,00	65,03	34,00		STD - 025 - 050 - 075 - 100 - BAR - BAR EM1	310.21	FIN021MB STD
----	-----	---	-------	-------	-------	--	---	--------	--------------





MB	ALL	1	45,00	56,02	53,00		STD - 025 - 050 - 075 - 100 - BAR - BAR EM1	310.26	FIN026MB STD
----	-----	---	-------	-------	-------	--	---	--------	--------------



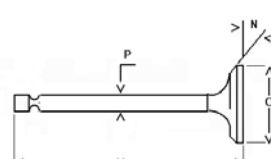

--	--	--	--	--	--	--	--	--	--

--	--	--	--	--	--	--	--	--	--

PB	BM	1	28,02	32,02	30,25		SEMIF.	316.35	FIN035PB
----	----	---	-------	-------	-------	--	--------	--------	----------

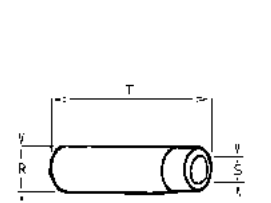
--	--	--	--	--	--	--	--	--	--

	IN EX		Nr.	O	P	M	N		ADATTABILE A: SUITABLE FOR:			
	IN		FS	1	42,5	9	119		45	E1	960.20	FINA122
	EX		FN	1	40	9	119		45	A1	960.21	FINS123

	IN EX		Nr.	R	S	T		ADATTABILE A: SUITABLE FOR:			
	IN		G	1	15,03	9,04		55	L	464.42	FIN201AA
	IN		G		15,13	9,04		55	L	464.30	FIN201AB
	EX		G	1	15,03	9,06		55	L	464.41	FIN202SA
	EX		G		15,13	9,06		55	L	464.20	FIN202SB

Ricambi non originali per motori. Denominazioni e codici originali, sono riportati a puro titolo di riferimento.

9 - 21

rel. 1511

Non original engine parts. OEMs names and part numbers are for reference purpose only.

RUGGERINI

P 101	Cm³	CILINDRI CYLINDERS	ALESAGGIO BORE	CORSA STROKE	VERSIONE VERSION
	746	1	100	95	

	2180	2395			448.15	447.60	448.06	448.06
FIN116CGA	FIN116CGB	FIN090SM	FIN3224RT	FIN3223RT	FIN207CO	FIN285CB	FIN610IG	FIN610IG

 ADATTABILE A: SUITABLE FOR:		Nr. ENGINE KIT	ELECTRIC KIT 				
	447.85			FIN626HG	1		FIN034SL00
					1		FIN204PC00
					1		FIN090SM
			FIN0965KIT				

387.62		359.16		175.20			
FIN2220AF		FIN1040NF		FIN4232FE			



	656.42	644.43	644.46	660.17	956.27		
	FIN702JP	FIN524NH	FIN179NO	FIN011E	FIN016DV		







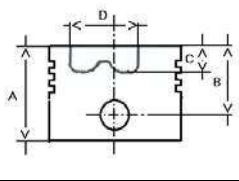

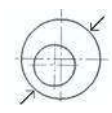
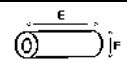
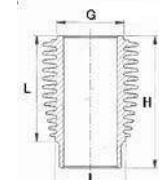
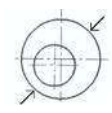
Ricambi non originali per motori. Denominazioni e codici originali, sono riportati a puro titolo di riferimento.

Non original engine parts. OEMs names and part numbers are for reference purpose only.

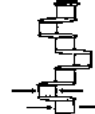
RUGGERINI

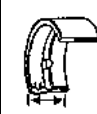
P 101 L	Cm³	CILINDRI CYLINDERS	ALESAGGIO BORE	CORSA STROKE	VERSIONE VERSION
	746	1	100	95	

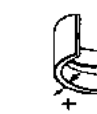
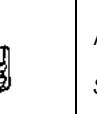
		TESTA HEAD	H14		3	2,5	TIPO TYPE	A	
		A	130		1	2,5			
	FIN210PN		B	55	10	2,5		G	118
	854.10		C	17,5	22	5		H	195,4
	100	2183	D	49			I	108	
	100,5	2184	E	84	2188	FIN077RS00	L	145,4	
	101	2185	F	28	2189	FIN077RS05	203.11		FIN034SL00
					2190	FIN077RS10			

		Nr.							ADATTABILE A: SUITABLE FOR:	
---	---	------------	---	---	---	---	---	--	--------------------------------	---

CR	AL	1	58,74	62,42	24,71			STD - 025 - 050 - 075 - 100	316.30	FIN030CR STD
----	----	---	-------	-------	-------	--	--	-----------------------------	--------	--------------

MB	ALL	1	50,00	65,03	34,00			STD - 025 - 050 - 075 - 100 - BAR - BAR EM1	310.21	FIN021MB STD
----	-----	---	-------	-------	-------	--	--	---	--------	--------------





MB	ALL	1	45,00	56,02	53,00			STD - 025 - 050 - 075 - 100 - BAR - BAR EM1	310.26	FIN026MB STD
----	-----	---	-------	-------	-------	--	--	---	--------	--------------



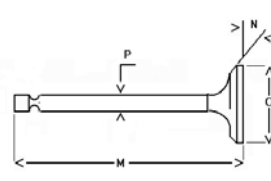

--	--	--	--	--	--	--	--	--	--	--

--	--	--	--	--	--	--	--	--	--	--

PB	BM	1	28,02	32,02	30,25			SEMIF.	316.35	FIN035PB
----	----	---	-------	-------	-------	--	--	--------	--------	----------

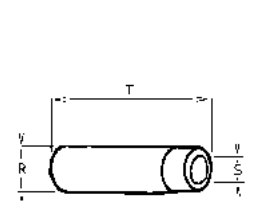
--	--	--	--	--	--	--	--	--	--	--

	IN EX		Nr.	O	P	M	N		ADATTABILE A: SUITABLE FOR:				
	IN		FS	1	42,5	9	119		45		E1	960.20	FINA122
	EX		FN	1	40	9	119		45		A1	960.21	FINS123

	IN EX		Nr.	R	S	T		ADATTABILE A: SUITABLE FOR:										
	IN		G	1	15,03	9,04		55		L	464.42	FIN201AA						
	IN		G		15,13	9,04		55		L	464.30	FIN201AB						
	EX		G	1	15,03	9,06		55		L	464.41	FIN202SA						
										EX	G		15,13	9,06	55	L	464.20	FIN202SB

Ricambi non originali per motori. Denominazioni e codici originali, sono riportati a puro titolo di riferimento.

11 - 21

rel. 1511

Non original engine parts. OEMs names and part numbers are for reference purpose only.

RUGGERINI

P 101 L	Cm³	CILINDRI CYLINDERS	ALESAGGIO BORE	CORSA STROKE	VERSIONE VERSION
	746	1	100	95	

	2180	2395			448.15	447.60	448.06	448.06
FIN116CGA	FIN116CGB	FIN090SM	FIN3224RT	FIN3223RT	FIN207CO	FIN285CB	FIN610IG	FIN610IG

 	ADATTABILE A: SUITABLE FOR:		Nr.	ENGINE KIT	ELECTRIC KIT
	447.85	FIN626HG	1	 FIN034SL00	
			1	 FIN204PC00	
			1	 FIN090SM	
				FIN0965KIT	

387.62		359.16		175.20			
FIN2220AF		FIN1040NF		FIN4232FE			

	656.42	644.43	644.46	660.17	956.27		
	FIN702JP	FIN524NH	FIN179NO	FIN011E	FIN016DV		

Ricambi non originali per motori. Denominazioni e codici originali, sono riportati a puro titolo di riferimento.



12 - 21







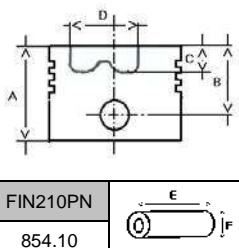

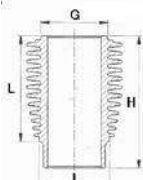
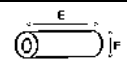
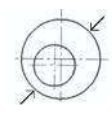
rel. 1511

Non original engine parts. OEMs names and part numbers are for reference purpose only.

RUGGERINI

P 101/2	Cm³	CILINDRI CYLINDERS	ALESAGGIO BORE	CORSA STROKE	VERSIONE VERSION
	1492	2	100	95	

		TESTA HEAD	H14		3	2,5	TIPO TYPE	A		
		A	130		1	2,5			G	118
		B	55		10	2,5			H	195,4
		C	17,5		22	5			I	108
		D	49						L	145,4
		E	84							
FIN210PN		E	84							
854.10		F	28							
	100	2183	FIN204PC00	2188	FIN077RS00	203.11	FIN034SL00			
	100,5	2184	FIN204PC05	2189	FIN077RS05					
	101	2185	FIN204PC10	2190	FIN077RS10					

		Nr.						ADATTABILE A: SUITABLE FOR:	
---	---	------------	---	---	---	---	---	--------------------------------	---

CR	AL	2	58,74	62,42	24,71		STD - 025 - 050 - 075 - 100	316.30	FIN030CR STD
----	----	---	-------	-------	-------	--	-----------------------------	--------	--------------

MB	ALL	1	50,00	65,03	34,00		STD - 025 - 050 - 075 - 100 - BAR - BAR EM1	310.21	FIN021MB STD
----	-----	---	-------	-------	-------	--	---	--------	--------------





MB	ALL	1	45,00	56,02	53,00		STD - 025 - 050 - 075 - 100 - BAR - BAR EM1	310.26	FIN026MB STD
----	-----	---	-------	-------	-------	--	---	--------	--------------



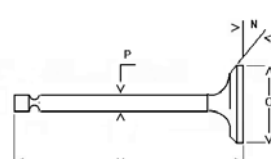

MB	ALL	1	58,74	62,42	36,00		STD - 025 - 050 - 075 - 100	310.06	FIN006MB STD
----	-----	---	-------	-------	-------	--	-----------------------------	--------	--------------

--	--	--	--	--	--	--	--	--	--

PB	BM	2	28,02	32,02	30,25		SEMIF.	316.35	FIN035PB
----	----	---	-------	-------	-------	--	--------	--------	----------

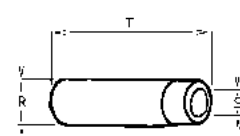
--	--	--	--	--	--	--	--	--	--

	IN EX		Nr.	O	P	M	N		ADATTABILE A: SUITABLE FOR:			
	IN		FS	2	42,5	9	119		45	E1	960.20	FINA122
	EX		FN	2	40	9	119		45	A1	960.21	FINS123

	IN EX		Nr.	R	S	T		ADATTABILE A: SUITABLE FOR:			
	IN		G	2	15,03	9,04		55	L	464.42	FIN201AA
	IN		G		15,13	9,04		55	L	464.30	FIN201AB
	EX		G	2	15,03	9,06		55	L	464.41	FIN202SA
	EX		G		15,13	9,06		55	L	464.20	FIN202SB

Ricambi non originali per motori. Denominazioni e codici originali, sono riportati a puro titolo di riferimento.

13 - 21

rel. 1511

Non original engine parts. OEMs names and part numbers are for reference purpose only.

RUGGERINI

P 101/2	Cm³	CILINDRI CYLINDERS	ALESAGGIO BORE	CORSA STROKE	VERSIONE VERSION
	1492	2	100	95	

	2204	2397			447.73	447.60	448.06	448.06
FIN117CGA	FIN117CGB	FIN091SM	FIN3224RT	FIN3216RT	FIN208CO	FIN285CB	FIN610IG	FIN610IG

 ADATTABILE A: SUITABLE FOR:	 FIN626HG	Nr.	ENGINE KIT	ELECTRIC KIT
		1	 FIN034SL00	
		1	 FIN204PC00	
		1	 FIN090SM FIN0965KIT	

387.62		359.16		175.19	175.22		
FIN2220AF		FIN1040NF		FIN4240FE	FIN4245OF		

				2197			
				FIN438OP			



	656.49	644.43	644.46	660.17	956.27		
	FIN711JP	FIN524NH	FIN179NO	FIN011E	FIN016DV		







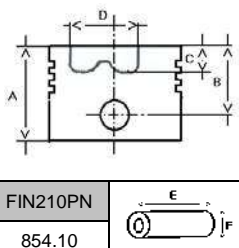

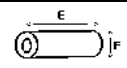
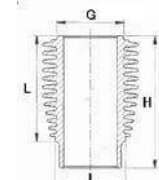
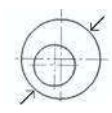
014.18	730.13	563.02					
FIN698VA	FIN238VR	FIN734TL					

Ricambi non originali per motori. Denominazioni e codici originali, sono riportati a puro titolo di riferimento.

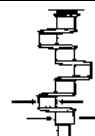
RUGGERINI

P 101/2 L	Cm³	CILINDRI CYLINDERS	ALESAGGIO BORE	CORSA STROKE	VERSIONE VERSION
	1492	2	100	95	

		TESTA HEAD	H14		3	2,5	TIPO TYPE	A	
		A	130		1	2,5			
		B	55		10	2,5			
		C	17,5		22	5			
		D	49						
		E	84						
FIN210PN		F	28					G	118
854.10								H	195,4
								I	108
	100	2183	FIN204PC00	2188	FIN077RS00	203.11	L	145,4	
	100,5	2184	FIN204PC05	2189	FIN077RS05		FIN034SL00		
	101	2185	FIN204PC10	2190	FIN077RS10				

		Nr.						ADATTABILE A: SUITABLE FOR:	
---	---	------------	---	---	---	---	---	--------------------------------	---

CR	AL	2	58,74	62,42	24,71		STD - 025 - 050 - 075 - 100	316.30	FIN030CR STD
----	----	---	-------	-------	-------	--	-----------------------------	--------	--------------

MB	ALL	1	50,00	65,03	34,00		STD - 025 - 050 - 075 - 100 - BAR - BAR EM1	310.21	FIN021MB STD
----	-----	---	-------	-------	-------	--	---	--------	--------------





MB	ALL	1	45,00	56,02	53,00		STD - 025 - 050 - 075 - 100 - BAR - BAR EM1	310.26	FIN026MB STD
----	-----	---	-------	-------	-------	--	---	--------	--------------



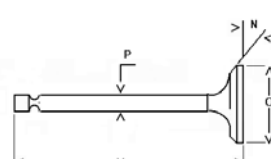

MB	ALL	1	58,74	62,42	36,00		STD - 025 - 050 - 075 - 100	310.06	FIN006MB STD
----	-----	---	-------	-------	-------	--	-----------------------------	--------	--------------

--	--	--	--	--	--	--	--	--	--

PB	BM	2	28,02	32,02	30,25		SEMIF.	316.35	FIN035PB
----	----	---	-------	-------	-------	--	--------	--------	----------

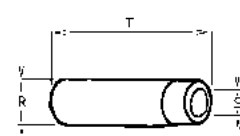
--	--	--	--	--	--	--	--	--	--

	IN EX		Nr.	O	P	M	N		ADATTABILE A: SUITABLE FOR:				
	IN		FS	2	42,5	9	119		45		E1	960.20	FINA122
	EX		FN	2	40	9	119		45		A1	960.21	FINS123

	IN EX		Nr.	R	S	T		ADATTABILE A: SUITABLE FOR:				
	IN		G	2	15,03	9,04		55		L	464.42	FIN201AA
	IN		G		15,13	9,04		55		L	464.30	FIN201AB
	EX		G	2	15,03	9,06		55		L	464.41	FIN202SA
	EX		G		15,13	9,06		55		L	464.20	FIN202SB

Ricambi non originali per motori. Denominazioni e codici originali, sono riportati a puro titolo di riferimento.

15 - 21

rel. 1511

Non original engine parts. OEMs names and part numbers are for reference purpose only.

RUGGERINI

P 101/2 L	Cm³	CILINDRI CYLINDERS	ALESAGGIO BORE	CORSA STROKE	VERSIONE VERSION
	1492	2	100	95	

	2204	2397			447.73	447.60	448.06	448.06
FIN117CGA	FIN117CGB	FIN091SM	FIN3224RT	FIN3216RT	FIN208CO	FIN285CB	FIN610IG	FIN610IG

 ADATTABILE A: SUITABLE FOR:		<table border="1"> <thead> <tr> <th>Nr.</th> <th>ENGINE KIT</th> </tr> </thead> <tbody> <tr> <td>1</td> <td> FIN034SL00</td> </tr> <tr> <td>1</td> <td> FIN204PC00</td> </tr> <tr> <td>1</td> <td> FIN090SM</td> </tr> <tr> <td></td> <td>FIN0965KIT</td> </tr> </tbody> </table>	Nr.	ENGINE KIT	1	 FIN034SL00	1	 FIN204PC00	1	 FIN090SM		FIN0965KIT	ELECTRIC KIT	
	Nr.		ENGINE KIT											
	1		 FIN034SL00											
	1		 FIN204PC00											
1	 FIN090SM													
	FIN0965KIT													
447.85	FIN626HG													

387.62		359.16			175.19	175.22	
FIN2220AF		FIN1040NF			FIN4240FE	FIN4245OF	

				2197			
				FIN438OP			





	656.49	644.43	644.46	660.17	956.27		
	FIN711JP	FIN524NH	FIN179NO	FIN011E	FIN016DV		





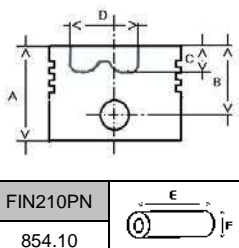

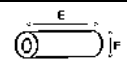
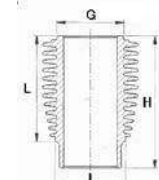

014.18	730.13	563.02					
FIN698VA	FIN238VR	FIN734TL					

Ricambi non originali per motori. Denominazioni e codici originali, sono riportati a puro titolo di riferimento.

RUGGERINI

P 105/2	Cm³	CILINDRI CYLINDERS	ALESAGGIO BORE	CORSA STROKE	VERSIONE VERSION
	1732	2	105	100	

		TESTA HEAD	H14		3	2,5	TIPO TYPE	A	
		A	105		1	2,5			
		B	55		10	2,5			
		C	18		22	5			
		D	53,7						
		E	84						
FIN210PN		F	28					G	118
854.10								H	197,2
								I	112
	105	2347	FIN205PC00	2351	FIN078RS00	203.47	L	148	FIN035SL00
	105,5	2348	FIN205PC05	2352	FIN078RS05				
	106	2349	FIN205PC10	2353	FIN078RS10				

		Nr.						ADATTABILE A: SUITABLE FOR:	
---	---	------------	---	---	---	---	---	--------------------------------	---

CR	AL	2	58,74	62,42	24,71		STD - 025 - 050 - 075 - 100	316.30	FIN030CR STD
----	----	---	-------	-------	-------	--	-----------------------------	--------	--------------

MB	ALL	1	50,00	65,03	34,00		STD - 025 - 050 - 075 - 100 - BAR - BAR EM1	310.21	FIN021MB STD
----	-----	---	-------	-------	-------	--	---	--------	--------------





MB	ALL	1	45,00	56,02	53,00		STD - 025 - 050 - 075 - 100 - BAR - BAR EM1	310.26	FIN026MB STD
----	-----	---	-------	-------	-------	--	---	--------	--------------



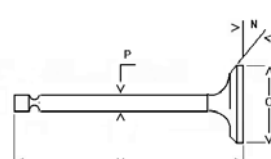

MB	ALL	1	58,74	62,42	36,00		STD - 025 - 050 - 075 - 100	310.06	FIN006MB STD
----	-----	---	-------	-------	-------	--	-----------------------------	--------	--------------

--	--	--	--	--	--	--	--	--	--

PB	BM	2	28,02	32,02	30,25		SEMIF.	316.35	FIN035PB
----	----	---	-------	-------	-------	--	--------	--------	----------

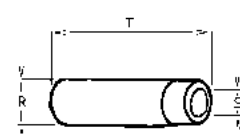
--	--	--	--	--	--	--	--	--	--

	IN EX		Nr.	O	P	M	N		ADATTABILE A: SUITABLE FOR:				
	IN		FS	2	42,5	9	119		45		E1	960.20	FINA122
	EX		FN	2	40	9	119		45		A1	960.21	FINS123

	IN EX		Nr.	R	S	T		ADATTABILE A: SUITABLE FOR:				
	IN		G	2	15,03	9,04		55		L	464.42	FIN201AA
	IN		G		15,13	9,04		55		L	464.30	FIN201AB
	EX		G	2	15,03	9,06		55		L	464.41	FIN202SA
	EX		G		15,13	9,06		55		L	464.20	FIN202SB

Ricambi non originali per motori. Denominazioni e codici originali, sono riportati a puro titolo di riferimento.

17 - 21

rel. 1511

Non original engine parts. OEMs names and part numbers are for reference purpose only.

RUGGERINI

P 105/2	Cm³	CILINDRI CYLINDERS	ALESAGGIO BORE	CORSA STROKE	VERSIONE VERSION
	1732	2	105	100	

	2357	2399			447.73	447.60	448.06	448.06
FIN680CGA	FIN680CGB	FIN285SM	FIN3224RT	FIN3216RT	FIN208CO	FIN285CB	FIN610IG	FIN610IG

 ADATTABILE A: SUITABLE FOR:		Nr.	ENGINE KIT	ELECTRIC KIT
	448.96	1	 FIN035SL00	
		1	 FIN205PC00	
		1	 FIN284SM	
			FIN2038KIT	

387.62		359.16		175.19	175.22		
FIN2220AF		FIN1040NF		FIN4240FE	FIN4245OF		

				2197			
				FIN438OP			





	656.34	644.43	644.46	660.18	956.32		
	FIN712JP	FIN524NH	FIN179NO	FIN087E	FIN099DV		





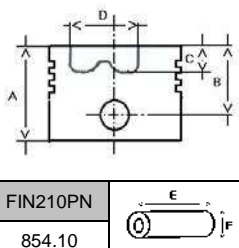

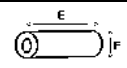
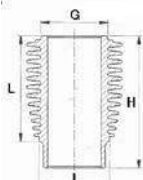

014.18	730.13	563.02					
FIN698VA	FIN238VR	FIN734TL					

Ricambi non originali per motori. Denominazioni e codici originali, sono riportati a puro titolo di riferimento.

RUGGERINI

P 105/2 R	Cm³	CILINDRI CYLINDERS	ALESAGGIO BORE	CORSA STROKE	VERSIONE VERSION
	1732	2	105	100	

		TESTA HEAD	H14		3	2,5	TIPO TYPE	A		
		A	105		1	2,5				
		B	55		10	2,5				
		C	18		22	5				
		D	53,7							
		E	84							
FIN210PN		F	28					G	118	
854.10								H	197,2	
									I	112
									L	148
								203.47		FIN035SL00
	105	2347	FIN205PC00		2351	FIN078RS00				
	105,5	2348	FIN205PC05		2352	FIN078RS05				
	106	2349	FIN205PC10		2353	FIN078RS10				

		Nr.							ADATTABILE A: SUITABLE FOR:	
---	---	------------	---	---	---	---	---	---	--------------------------------	---

CR	AL	2	58,74	62,42	24,71		STD - 025 - 050 - 075 - 100	316.30	FIN030CR STD
----	----	---	-------	-------	-------	--	-----------------------------	--------	--------------

MB	ALL	1	50,00	65,03	34,00		STD - 025 - 050 - 075 - 100 - BAR - BAR EM1	310.21	FIN021MB STD
----	-----	---	-------	-------	-------	--	---	--------	--------------





MB	ALL	1	45,00	56,02	53,00		STD - 025 - 050 - 075 - 100 - BAR - BAR EM1	310.26	FIN026MB STD
----	-----	---	-------	-------	-------	--	---	--------	--------------



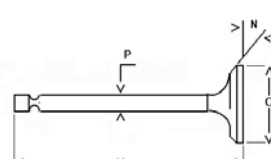

MB	ALL	1	58,74	62,42	36,00		STD - 025 - 050 - 075 - 100	310.06	FIN006MB STD
----	-----	---	-------	-------	-------	--	-----------------------------	--------	--------------

--	--	--	--	--	--	--	--	--	--

PB	BM	2	28,02	32,02	30,25		SEMIF.	316.35	FIN035PB
----	----	---	-------	-------	-------	--	--------	--------	----------

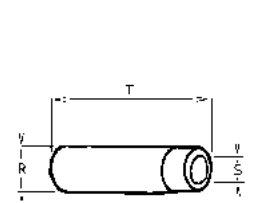
--	--	--	--	--	--	--	--	--	--

	IN EX		Nr.	O	P	M	N		ADATTABILE A: SUITABLE FOR:				
	IN		FS	2	42,5	9	119		45		E1	960.20	FINA122
	EX		FN	2	40	9	119		45		A1	960.21	FINS123

	IN EX		Nr.	R	S	T		ADATTABILE A: SUITABLE FOR:				
	IN		G	2	15,03	9,04		55		L	464.42	FIN201AA
	IN		G		15,13	9,04		55		L	464.30	FIN201AB
	EX		G	2	15,03	9,06		55		L	464.41	FIN202SA
	EX		G		15,13	9,06		55		L	464.20	FIN202SB

Ricambi non originali per motori. Denominazioni e codici originali, sono riportati a puro titolo di riferimento.

19 - 21

rel. 1511

Non original engine parts. OEMs names and part numbers are for reference purpose only.

RUGGERINI

P 105/2 R	Cm³	CILINDRI CYLINDERS	ALESAGGIO BORE	CORSA STROKE	VERSIONE VERSION
	1732	2	105	100	

	2357	2399			447.73	447.60	448.06	448.06
FIN680CGA	FIN680CGB	FIN285SM	FIN3224RT	FIN3216RT	FIN208CO	FIN285CB	FIN610IG	FIN610IG

 ADATTABILE A: SUITABLE FOR:		Nr.	ENGINE KIT	ELECTRIC KIT
	448.96	1	 FIN035SL00	
		1	 FIN205PC00	
		1	 FIN284SM	
			FIN2038KIT	

387.62		359.16		175.19	175.22		
FIN2220AF		FIN1040NF		FIN4240FE	FIN4245OF		

				2197			
				FIN438OP			





	656.34	644.43	644.46	660.18	956.32		
	FIN712JP	FIN524NH	FIN179NO	FIN087E	FIN099DV		





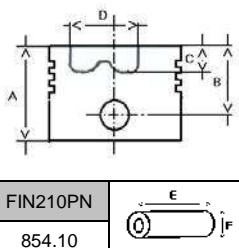

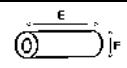
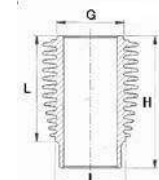

014.18	730.13	563.02					
FIN698VA	FIN238VR	FIN734TL					

Ricambi non originali per motori. Denominazioni e codici originali, sono riportati a puro titolo di riferimento.

RUGGERINI

P 105/2 L	Cm³	CILINDRI CYLINDERS	ALESAGGIO BORE	CORSA STROKE	VERSIONE VERSION
	1732	2	105	100	

		TESTA HEAD	H14		3	2,5	TIPO TYPE	A	
		A	105		1	2,5			
		B	55		10	2,5			
		C	18		22	5			
		D	53,7						
		E	84						
FIN210PN		F	28					G	118
854.10								H	197,2
								I	112
	105	2347	FIN205PC00	2351	FIN078RS00	203.47	L	148	
	105,5	2348	FIN205PC05	2352	FIN078RS05		FIN035SL00		
	106	2349	FIN205PC10	2353	FIN078RS10				

		Nr.						ADATTABILE A: SUITABLE FOR:	
---	---	------------	---	---	---	---	---	--------------------------------	---

CR	AL	2	58,74	62,42	24,71		STD - 025 - 050 075 - 100	316.30	FIN030CR STD
----	----	---	-------	-------	-------	--	------------------------------	--------	--------------

MB	ALL	1	50,00	65,03	34,00		STD - 025 - 050 075 - 100 - BAR BAR EM1	310.21	FIN021MB STD
----	-----	---	-------	-------	-------	--	---	--------	--------------





MB	ALL	1	45,00	56,02	53,00		STD - 025 - 050 075 - 100 - BAR BAR EM1	310.26	FIN026MB STD
----	-----	---	-------	-------	-------	--	---	--------	--------------



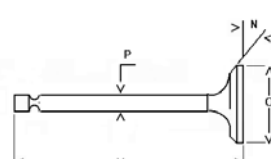

MB	ALL	1	58,74	62,42	36,00		STD - 025 - 050 075 - 100	310.06	FIN006MB STD
----	-----	---	-------	-------	-------	--	------------------------------	--------	--------------

--	--	--	--	--	--	--	--	--	--

PB	BM	2	28,02	32,02	30,25		SEMIF.	316.35	FIN035PB
----	----	---	-------	-------	-------	--	--------	--------	----------

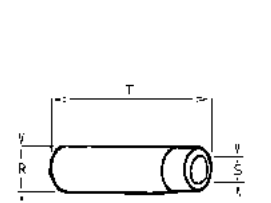
--	--	--	--	--	--	--	--	--	--

	IN EX		Nr.	O	P	M	N		ADATTABILE A: SUITABLE FOR:				
	IN		FS	2	42,5	9	119		45		E1	960.20	FINA122
	EX		FN	2	40	9	119		45		A1	960.21	FINS123

	IN EX		Nr.	R	S	T		ADATTABILE A: SUITABLE FOR:				
	IN		G	2	15,03	9,04		55		L	464.42	FIN201AA
	IN		G		15,13	9,04		55		L	464.30	FIN201AB
	EX		G	2	15,03	9,06		55		L	464.41	FIN202SA
	EX		G		15,13	9,06		55		L	464.20	FIN202SB

Ricambi non originali per motori. Denominazioni e codici originali, sono riportati a puro titolo di riferimento.

21 - 21

rel. 1511

Non original engine parts. OEMs names and part numbers are for reference purpose only.

RUGGERINI

P 105/2 L	Cm³	CILINDRI CYLINDERS	ALESAGGIO BORE	CORSA STROKE	VERSIONE VERSION
	1732	2	105	100	

	2357	2399			447.73	447.60	448.06	448.06
FIN680CGA	FIN680CGB	FIN285SM	FIN3224RT	FIN3216RT	FIN208CO	FIN285CB	FIN610IG	FIN610IG

 ADATTABILE A: SUITABLE FOR:		Nr.	ENGINE KIT	ELECTRIC KIT
	448.96	1	 FIN035SL00	
		1	 FIN205PC00	
		1	 FIN284SM	
			FIN2038KIT	

387.62		359.16		175.19	175.22		
FIN2220AF		FIN1040NF		FIN4240FE	FIN4245OF		

				2197			
				FIN438OP			

	656.34	644.43	644.46	660.18	956.32		
	FIN712JP	FIN524NH	FIN179NO	FIN087E	FIN099DV		





014.18	730.13	563.02					
FIN698VA	FIN238VR	FIN734TL					





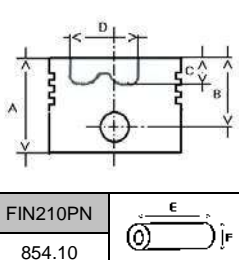

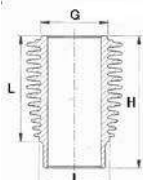

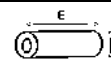
Ricambi non originali per motori. Denominazioni e codici originali, sono riportati a puro titolo di riferimento.

Non original engine parts. OEMs names and part numbers are for reference purpose only.

RUGGERINI

RP 280	Cm³	CILINDRI CYLINDERS	ALESAGGIO BORE	CORSA STROKE	VERSIONE VERSION
	1346	2	95	95	

		TESTA HEAD	H14		3	2,5	TIPO TYPE		G	H	I	L		
					1	2,5								
	FIN210PN		A	111	2175	FIN075RS00	2176	FIN075RS05	2177	FIN075RS10				
	854.10		E	84							F	28		
95	2170	FIN201PC00												
95,5	2171	FIN201PC05												
96	2172	FIN201PC10												

		Nr.							ADATTABILE A: SUITABLE FOR:	
---	---	------------	---	---	---	---	---	--	--------------------------------	---

CR	AL	2	58,74	62,42	24,71		STD - 025 - 050 - 075 - 100	316.30	FIN030CR STD
----	----	---	-------	-------	-------	--	-----------------------------	--------	--------------

MB	ALL	1	50,00	65,03	34,00		STD - 025 - 050 - 075 - 100 - BAR - BAR EM1	310.21	FIN021MB STD
----	-----	---	-------	-------	-------	--	---	--------	--------------





MB	ALL	1	45,00	56,02	53,00		STD - 025 - 050 - 075 - 100 - BAR - BAR EM1	310.26	FIN026MB STD
----	-----	---	-------	-------	-------	--	---	--------	--------------



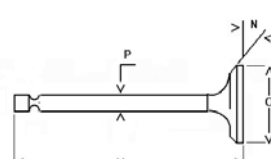

MB	ALL	1	58,74	62,42	36,00		STD - 025 - 050 - 075 - 100	310.06	FIN006MB STD
----	-----	---	-------	-------	-------	--	-----------------------------	--------	--------------

--	--	--	--	--	--	--	--	--	--

PB	BM	2	28,02	32,02	30,25		SEMIF.	316.35	FIN035PB
----	----	---	-------	-------	-------	--	--------	--------	----------

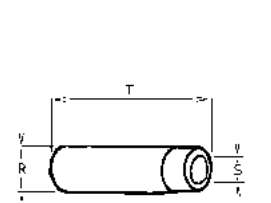
--	--	--	--	--	--	--	--	--	--

	IN EX		Nr.	O	P	M	N		ADATTABILE A: SUITABLE FOR:								
	IN								FS	2	37,8	9	119	45	E1	960.13	FINA119
	EX								FN	2	37,8	9	119	45	A1	960.18	FINS120

	IN EX		Nr.	R	S	T		ADATTABILE A: SUITABLE FOR:							
	IN							G	2	15,03	9,04	55	L	464.42	FIN201AA
	IN							G		15,13	9,04	55	L	464.30	FIN201AB
	EX							G	2	15,03	9,06	55	L	464.41	FIN202SA
	EX							G		15,13	9,06	55	L	464.20	FIN202SB

Ricambi non originali per motori. Denominazioni e codici originali, sono riportati a puro titolo di riferimento.

23 - 21

rel. 1511

Non original engine parts. OEMs names and part numbers are for reference purpose only.

RUGGERINI

RP 280	Cm³	CILINDRI CYLINDERS	ALESAGGIO BORE	CORSA STROKE	VERSIONE VERSION
	1346	2	95	95	

	2203	2398			447.73	447.60	448.06	448.06
FIN2284CGA	FIN2284CGB	FIN2182SM	FIN3224RT	FIN3216RT	FIN208CO	FIN285CB	FIN610IG	FIN610IG

 ADATTABILE A: SUITABLE FOR:	 FIN629HG	Nr.		ENGINE KIT		ELECTRIC KIT	
		1					
		1					
		1					
447.54							

387.62		359.16		175.19	175.22		
FIN2220AF		FIN1040NF		FIN4240FE	FIN4245OF		

				2197			
				FIN438OP			





	656.49	644.43	644.46	660.17	956.27		
	FIN711JP	FIN524NH	FIN179NO	FIN011E	FIN016DV		





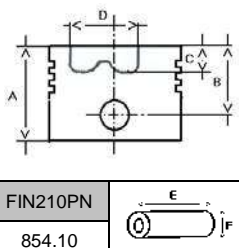

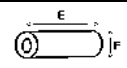
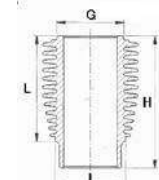

014.18	730.13	563.02					
FIN698VA	FIN238VR	FIN734TL					

Ricambi non originali per motori. Denominazioni e codici originali, sono riportati a puro titolo di riferimento.

RUGGERINI

RP 170	Cm³	CILINDRI CYLINDERS	ALESAGGIO BORE	CORSA STROKE	VERSIONE VERSION
	746	1	100	95	

		TESTA HEAD	H14		3	2,5	TIPO TYPE	A	
		A	130		1	2,5			
		B	55		10	2,5			
		C	17,5		22	5			
		D	49						
		E	84						
FIN210PN		F	28					G	118
854.10								H	195,4
								I	108
	100	2183	FIN204PC00	2188	FIN077RS00	203.11	L	145,4	
	100,5	2184	FIN204PC05	2189	FIN077RS05		FIN034SL00		
	101	2185	FIN204PC10	2190	FIN077RS10				

		Nr.							ADATTABILE A: SUITABLE FOR:	
---	---	------------	---	---	---	---	---	--	--------------------------------	---

CR	AL	1	58,74	62,42	24,71			STD - 025 - 050 - 075 - 100	316.30	FIN030CR STD
----	----	---	-------	-------	-------	--	--	-----------------------------	--------	--------------

MB	ALL	1	50,00	65,03	34,00			STD - 025 - 050 - 075 - 100 - BAR - BAR EM1	310.21	FIN021MB STD
----	-----	---	-------	-------	-------	--	--	---	--------	--------------





MB	ALL	1	45,00	56,02	53,00			STD - 025 - 050 - 075 - 100 - BAR - BAR EM1	310.26	FIN026MB STD
----	-----	---	-------	-------	-------	--	--	---	--------	--------------



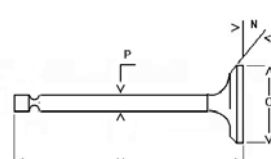

--	--	--	--	--	--	--	--	--	--	--

--	--	--	--	--	--	--	--	--	--	--

PB	BM	1	28,02	32,02	30,25			SEMIF.	316.35	FIN035PB
----	----	---	-------	-------	-------	--	--	--------	--------	----------

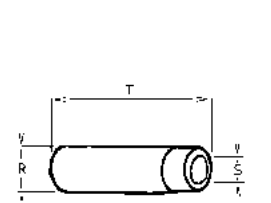
--	--	--	--	--	--	--	--	--	--	--

	IN EX		Nr.	O	P	M	N		ADATTABILE A: SUITABLE FOR:				
	IN		FS	1	42,5	9	119		45		E1	960.20	FINA122
	EX		FN	1	40	9	119		45		A1	960.21	FINS123

	IN EX		Nr.	R	S	T		ADATTABILE A: SUITABLE FOR:				
	IN		G	1	15,03	9,04		55		L	464.42	FIN201AA
	IN		G		15,13	9,04		55		L	464.30	FIN201AB
	EX		G	1	15,03	9,06		55		L	464.41	FIN202SA
	EX		G		15,13	9,06		55		L	464.20	FIN202SB

Ricambi non originali per motori. Denominazioni e codici originali, sono riportati a puro titolo di riferimento.

25 - 21

rel. 1511

Non original engine parts. OEMs names and part numbers are for reference purpose only.

RUGGERINI

RP 170	Cm³	CILINDRI CYLINDERS	ALESAGGIO BORE	CORSA STROKE	VERSIONE VERSION
	746	1	100	95	

	2180	2395			448.15	447.60	448.06	448.06
FIN116CGA	FIN116CGB	FIN090SM	FIN3224RT	FIN3223RT	FIN207CO	FIN285CB	FIN610IG	FIN610IG

 ADATTABILE A: SUITABLE FOR:		Nr.	ENGINE KIT	ELECTRIC KIT
	447.85	1	 FIN034SL00	
		1	 FIN204PC00	
		1	 FIN090SM	
			FIN0965KIT	

387.62		359.16		175.20			
FIN2220AF		FIN1040NF		FIN4232FE			

	FIN089CK						



	656.42	644.43	644.46	660.17	956.27		
	FIN702JP	FIN524NH	FIN179NO	FIN011E	FIN016DV		







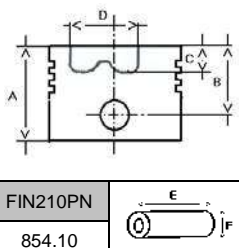

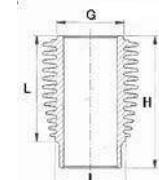
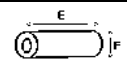
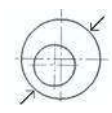
Ricambi non originali per motori. Denominazioni e codici originali, sono riportati a puro titolo di riferimento.

Non original engine parts. OEMs names and part numbers are for reference purpose only.

RUGGERINI

RP 178	Cm³	CILINDRI CYLINDERS	ALESAGGIO BORE	CORSA STROKE	VERSIONE VERSION
	746	1	100	95	

		TESTA HEAD	H14		3	2,5	TIPO TYPE	A		
		A	130		1	2,5			G	118
		B	55		10	2,5			H	195,4
		C	17,5		22	5			I	108
		D	49						L	145,4
		E	84							
FIN210PN				2188	FIN077RS00	203.11		FIN034SL00		
854.10				2189	FIN077RS05					
				2190	FIN077RS10					
	100	2183	FIN204PC00							
	100,5	2184	FIN204PC05							
	101	2185	FIN204PC10							

		Nr.							ADATTABILE A: SUITABLE FOR:	
---	---	------------	---	---	---	---	---	--	--------------------------------	---

CR	AL	1	58,74	62,42	24,71			STD - 025 - 050 - 075 - 100	316.30	FIN030CR STD
----	----	---	-------	-------	-------	--	--	-----------------------------	--------	--------------

MB	ALL	1	50,00	65,03	34,00			STD - 025 - 050 - 075 - 100 - BAR - BAR EM1	310.21	FIN021MB STD
----	-----	---	-------	-------	-------	--	--	---	--------	--------------





MB	ALL	1	45,00	56,02	53,00			STD - 025 - 050 - 075 - 100 - BAR - BAR EM1	310.26	FIN026MB STD
----	-----	---	-------	-------	-------	--	--	---	--------	--------------



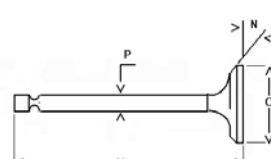

--	--	--	--	--	--	--	--	--	--	--

--	--	--	--	--	--	--	--	--	--	--

PB	BM	1	28,02	32,02	30,25			SEMIF.	316.35	FIN035PB
----	----	---	-------	-------	-------	--	--	--------	--------	----------

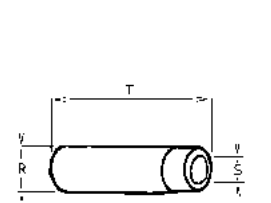
--	--	--	--	--	--	--	--	--	--	--

	IN EX		Nr.	O	P	M	N		ADATTABILE A: SUITABLE FOR:			
	IN		FS	1	42,5	9	119		45	E1	960.20	FINA122
	EX		FN	1	40	9	119		45	A1	960.21	FINS123

	IN EX		Nr.	R	S	T		ADATTABILE A: SUITABLE FOR:			
	IN		G	1	15,03	9,04		55	L	464.42	FIN201AA
	IN		G		15,13	9,04		55	L	464.30	FIN201AB
	EX		G	1	15,03	9,06		55	L	464.41	FIN202SA
	EX		G		15,13	9,06		55	L	464.20	FIN202SB

Ricambi non originali per motori. Denominazioni e codici originali, sono riportati a puro titolo di riferimento.

27 - 21

rel. 1511

Non original engine parts. OEMs names and part numbers are for reference purpose only.

RUGGERINI

RP 178	Cm³	CILINDRI CYLINDERS	ALESAGGIO BORE	CORSA STROKE	VERSIONE VERSION
	746	1	100	95	

	2180	2395			448.15	447.60	448.06	448.06
FIN116CGA	FIN116CGB	FIN090SM	FIN3224RT	FIN3223RT	FIN207CO	FIN285CB	FIN610IG	FIN610IG

 ADATTABILE A: SUITABLE FOR:		Nr. ENGINE KIT	ELECTRIC KIT 		
	447.85			1	 FIN034SL00
				1	 FIN204PC00
				1	 FIN090SM
		FIN0965KIT			

387.62	359.16	175.20
FIN2220AF	FIN1040NF	FIN4232FE

FIN710JP	FIN524NH	FIN179NO	FIN087E	FIN016DV

FIN2220AF	FIN1040NF	FIN4232FE



FIN2220AF	FIN1040NF	FIN4232FE







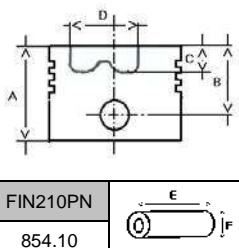

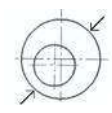
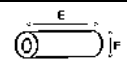
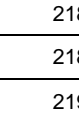
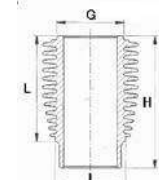
FIN2220AF	FIN1040NF	FIN4232FE

Ricambi non originali per motori. Denominazioni e codici originali, sono riportati a puro titolo di riferimento.

RUGGERINI

RP 320	Cm³	CILINDRI CYLINDERS	ALESAGGIO BORE	CORSA STROKE	VERSIONE VERSION
	1492	2	100	95	

		TESTA HEAD	H14		3	2,5	TIPO TYPE	A		
		A	130		1	2,5				
	FIN210PN		E	84		10	2,5		G	118
	854.10		F	28		22	5		H	195,4
	100	2183	FIN204PC00		2188	FIN077RS00		I	108	
	100,5	2184	FIN204PC05		2189	FIN077RS05		L	145,4	
	101	2185	FIN204PC10		2190	FIN077RS10		203.11		FIN034SL00

		Nr.						ADATTABILE A: SUITABLE FOR:	
---	---	------------	---	---	---	---	---	--------------------------------	---

CR	AL	2	58,74	62,42	24,71		STD - 025 - 050 - 075 - 100	316.30	FIN030CR STD
----	----	---	-------	-------	-------	--	-----------------------------	--------	--------------

MB	ALL	1	50,00	65,03	34,00		STD - 025 - 050 - 075 - 100 - BAR - BAR EM1	310.21	FIN021MB STD
----	-----	---	-------	-------	-------	--	---	--------	--------------





MB	ALL	1	45,00	56,02	53,00		STD - 025 - 050 - 075 - 100 - BAR - BAR EM1	310.26	FIN026MB STD
----	-----	---	-------	-------	-------	--	---	--------	--------------

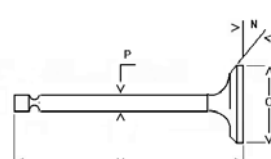

MB	ALL	1	58,74	62,42	36,00		STD - 025 - 050 - 075 - 100	310.06	FIN006MB STD
----	-----	---	-------	-------	-------	--	-----------------------------	--------	--------------

--	--	--	--	--	--	--	--	--	--

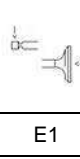
PB	BM	2	28,02	32,02	30,25		SEMIF.	316.35	FIN035PB
----	----	---	-------	-------	-------	--	--------	--------	----------

--	--	--	--	--	--	--	--	--	--

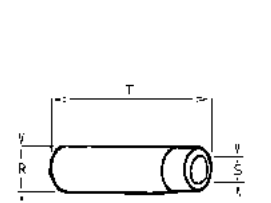
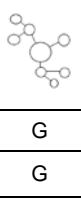
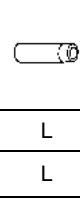
	IN EX		Nr.	O	P	M	N		ADATTABILE A: SUITABLE FOR:			
	IN		FS	2	42,5	9	119		45	E1	960.20	FINA122
	EX		FN	2	40	9	119		45	A1	960.21	FINS123

	IN EX		Nr.	R	S	T		ADATTABILE A: SUITABLE FOR:			
	IN		G	2	15,03	9,04		55	L	464.42	FIN201AA
	IN		G		15,13	9,04		55	L	464.30	FIN201AB
	EX		G	2	15,03	9,06		55	L	464.41	FIN202SA
	EX		G		15,13	9,06		55	L	464.20	FIN202SB

Ricambi non originali per motori. Denominazioni e codici originali, sono riportati a puro titolo di riferimento.

29 - 21

rel. 1511

Non original engine parts. OEMs names and part numbers are for reference purpose only.

RUGGERINI

RP 320	Cm³	CILINDRI CYLINDERS	ALESAGGIO BORE	CORSA STROKE	VERSIONE VERSION
	1492	2	100	95	

	2204	2397			447.73	447.60	448.06	448.06
FIN117CGA	FIN117CGB	FIN091SM	FIN3224RT	FIN3216RT	FIN208CO	FIN285CB	FIN610IG	FIN610IG

 ADATTABILE A: SUITABLE FOR:		<table border="1"> <tr> <th>Nr.</th> <th>ENGINE KIT</th> </tr> <tr> <td>1</td> <td> FIN034SL00</td> </tr> <tr> <td>1</td> <td> FIN204PC00</td> </tr> <tr> <td>1</td> <td> FIN090SM</td> </tr> <tr> <td></td> <td>FIN0965KIT</td> </tr> </table>	Nr.	ENGINE KIT	1	 FIN034SL00	1	 FIN204PC00	1	 FIN090SM		FIN0965KIT	ELECTRIC KIT	
	Nr.		ENGINE KIT											
	1		 FIN034SL00											
	1		 FIN204PC00											
1	 FIN090SM													
	FIN0965KIT													
447.85	FIN626HG													

387.62		359.16		175.19	175.22		
FIN2220AF		FIN1040NF		FIN4240FE	FIN4245OF		

				2197			
				FIN438OP			

	656.49	644.43	644.46	660.17	956.27		
	FIN711JP	FIN524NH	FIN179NO	FIN011E	FIN016DV		

014.18	730.13	563.02					
FIN698VA	FIN238VR	FIN734TL					

Ricambi non originali per motori. Denominazioni e codici originali, sono riportati a puro titolo di riferimento.



30 - 21







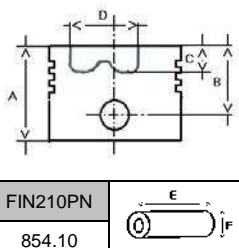

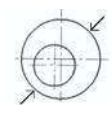
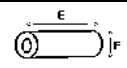
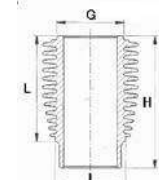
rel. 1511

Non original engine parts. OEMs names and part numbers are for reference purpose only.

RUGGERINI

RP 328	Cm³	CILINDRI CYLINDERS	ALESAGGIO BORE	CORSA STROKE	VERSIONE VERSION
	1492	2	100	95	

		TESTA HEAD	H14		3	2,5	TIPO TYPE	A	
		A	130		1	2,5		G	118
	FIN210PN		B	55	10	2,5		H	195,4
	854.10		C	17,5	22	5		I	108
			D	49			L	145,4	
			E	84			203.11	FIN034SL00	
			F	28					
	100	2183	FIN204PC00		2188	FIN077RS00			
	100,5	2184	FIN204PC05		2189	FIN077RS05			
	101	2185	FIN204PC10		2190	FIN077RS10			

		Nr.						ADATTABILE A: SUITABLE FOR:	
---	---	------------	---	---	---	---	---	--------------------------------	---

CR	AL	2	58,74	62,42	24,71		STD - 025 - 050 - 075 - 100	316.30	FIN030CR STD
----	----	---	-------	-------	-------	--	-----------------------------	--------	--------------

MB	ALL	1	50,00	65,03	34,00		STD - 025 - 050 - 075 - 100 - BAR - BAR EM1	310.21	FIN021MB STD
----	-----	---	-------	-------	-------	--	---	--------	--------------





MB	ALL	1	45,00	56,02	53,00		STD - 025 - 050 - 075 - 100 - BAR - BAR EM1	310.26	FIN026MB STD
----	-----	---	-------	-------	-------	--	---	--------	--------------



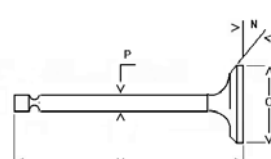

MB	ALL	1	58,74	62,42	36,00		STD - 025 - 050 - 075 - 100	310.06	FIN006MB STD
----	-----	---	-------	-------	-------	--	-----------------------------	--------	--------------

--	--	--	--	--	--	--	--	--	--

PB	BM	2	28,02	32,02	30,25		SEMIF.	316.35	FIN035PB
----	----	---	-------	-------	-------	--	--------	--------	----------

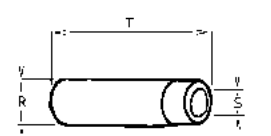
--	--	--	--	--	--	--	--	--	--

	IN EX		Nr.	O	P	M	N		ADATTABILE A: SUITABLE FOR:			
	IN		FS	2	42,5	9	119		45	E1	960.20	FINA122
	EX		FN	2	40	9	119		45	A1	960.21	FINS123

	IN EX		Nr.	R	S	T		ADATTABILE A: SUITABLE FOR:			
	IN		G	2	15,03	9,04		55	L	464.42	FIN201AA
	IN		G		15,13	9,04		55	L	464.30	FIN201AB
	EX		G	2	15,03	9,06		55	L	464.41	FIN202SA
	EX		G		15,13	9,06		55	L	464.20	FIN202SB

Ricambi non originali per motori. Denominazioni e codici originali, sono riportati a puro titolo di riferimento.

31 - 21

rel. 1511

Non original engine parts. OEMs names and part numbers are for reference purpose only.

RUGGERINI

RP 328	Cm³	CILINDRI CYLINDERS	ALESAGGIO BORE	CORSA STROKE	VERSIONE VERSION
	1492	2	100	95	

	2204	2397			447.73	447.60	448.06	448.06
FIN117CGA	FIN117CGB	FIN091SM	FIN3224RT	FIN3216RT	FIN208CO	FIN285CB	FIN610IG	FIN610IG

 ADATTABILE A: SUITABLE FOR:	 FIN626HG	Nr.	ENGINE KIT	ELECTRIC KIT
		1	 FIN034SL00	
		1	 FIN204PC00	
		1	 FIN090SM FIN0965KIT	

387.62		359.16		175.19	175.22		
FIN2220AF		FIN1040NF		FIN4240FE	FIN4245OF		

				2197			
				FIN438OP			

	656.49	644.43	644.46	660.17	956.27		
	FIN711JP	FIN524NH	FIN179NO	FIN011E	FIN016DV		

014.18	730.13	563.02					
FIN698VA	FIN238VR	FIN734TL					

Ricambi non originali per motori. Denominazioni e codici originali, sono riportati a puro titolo di riferimento.

32 - 21

rel. 1511

Non original engine parts. OEMs names and part numbers are for reference purpose only.

RUGGERINI

RP 360	Cm³	CILINDRI CYLINDERS	ALESAGGIO BORE	CORSA STROKE	VERSIONE VERSION
	1732	2	105	100	

		TESTA HEAD	H14		3	2,5	TIPO TYPE	A	
		A	105		1	2,5			
		B	55		10	2,5			
		C	18		22	5			
		D	53,7						
		E	84						
FIN210PN		E	84					G	118
854.10		F	28					H	197,2
								I	112
	105	2347	FIN205PC00	2351	FIN078RS00	203.47		L	148
	105,5	2348	FIN205PC05	2352	FIN078RS05			FIN035SL00	
	106	2349	FIN205PC10	2353	FIN078RS10				

		Nr.							ADATTABILE A: SUITABLE FOR:	
--	--	------------	--	--	--	--	--	--	--------------------------------	--

CR	AL	2	58,74	62,42	24,71			STD - 025 - 050 - 075 - 100	316.30	FIN030CR STD
----	----	---	-------	-------	-------	--	--	-----------------------------	--------	--------------

MB	ALL	1	50,00	65,03	34,00			STD - 025 - 050 - 075 - 100 - BAR - BAR EM1	310.21	FIN021MB STD
----	-----	---	-------	-------	-------	--	--	---	--------	--------------

MB	ALL	1	45,00	56,02	53,00			STD - 025 - 050 - 075 - 100 - BAR - BAR EM1	310.26	FIN026MB STD
----	-----	---	-------	-------	-------	--	--	---	--------	--------------

MB	ALL	1	58,74	62,42	36,00			STD - 025 - 050 - 075 - 100	310.06	FIN006MB STD
----	-----	---	-------	-------	-------	--	--	-----------------------------	--------	--------------

--	--	--	--	--	--	--	--	--	--	--

PB	BM	2	28,02	32,02	30,25			SEMIF.	316.35	FIN035PB
----	----	---	-------	-------	-------	--	--	--------	--------	----------

--	--	--	--	--	--	--	--	--	--	--

	IN EX		Nr.	O	P	M	N		ADATTABILE A: SUITABLE FOR:			
	IN		FS	2	42,5	9	119		45	E1	960.20	FINA122
	EX		FN	2	40	9	119		45	A1	960.21	FINS123

	IN EX		Nr.	R	S	T		ADATTABILE A: SUITABLE FOR:			
	IN		G	2	15,03	9,04		55	L	464.42	FIN201AA
	IN		G		15,13	9,04		55	L	464.30	FIN201AB
	EX		G	2	15,03	9,06		55	L	464.41	FIN202SA
	EX		G		15,13	9,06		55	L	464.20	FIN202SB

Ricambi non originali per motori. Denominazioni e codici originali, sono riportati a puro titolo di riferimento.

33 - 21

rel. 1511

Non original engine parts. OEMs names and part numbers are for reference purpose only.

RUGGERINI

RP 360	Cm³	CILINDRI CYLINDERS	ALESAGGIO BORE	CORSA STROKE	VERSIONE VERSION
	1732	2	105	100	

	2357	2399			447.73	447.60	448.06	448.06
FIN680CGA	FIN680CGB	FIN285SM	FIN3224RT	FIN3216RT	FIN208CO	FIN285CB	FIN610IG	FIN610IG

 ADATTABILE A: SUITABLE FOR:		Nr.	ENGINE KIT	ELECTRIC KIT
	448.96	1	 FIN035SL00	
		1	 FIN205PC00	
		1	 FIN284SM	
			FIN2038KIT	

387.62		359.16		175.19	175.22		
FIN2220AF		FIN1040NF		FIN4240FE	FIN4245OF		

				2197			
				FIN438OP			



	656.34	644.43	644.46	660.18	956.32		
	FIN712JP	FIN524NH	FIN179NO	FIN087E	FIN099DV		







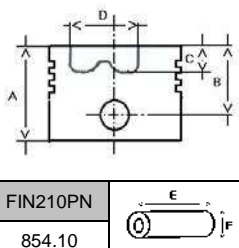

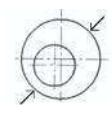
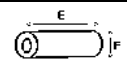
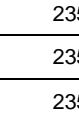
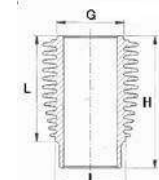
014.18	730.13	563.02					
FIN698VA	FIN238VR	FIN734TL					

Ricambi non originali per motori. Denominazioni e codici originali, sono riportati a puro titolo di riferimento.

RUGGERINI

RP 368	Cm³	CILINDRI CYLINDERS	ALESAGGIO BORE	CORSA STROKE	VERSIONE VERSION
	1732	2	105	100	

		TESTA HEAD	H14		3	2,5	TIPO TYPE	A		
		A	105		1	2,5				
	FIN210PN		E	84		10	2,5		G	118
	854.10		F	28		22	5		H	197,2
	105	2347	FIN205PC00		2351	FIN078RS00		I	112	
	105,5	2348	FIN205PC05		2352	FIN078RS05		L	148	
	106	2349	FIN205PC10		2353	FIN078RS10		203.47		FIN035SL00

		Nr.						ADATTABILE A: SUITABLE FOR:	
---	---	------------	---	---	---	---	---	--------------------------------	---

CR	AL	2	58,74	62,42	24,71		STD - 025 - 050 - 075 - 100	316.30	FIN030CR STD
----	----	---	-------	-------	-------	--	-----------------------------	--------	--------------

MB	ALL	1	50,00	65,03	34,00		STD - 025 - 050 - 075 - 100 - BAR - BAR EM1	310.21	FIN021MB STD
----	-----	---	-------	-------	-------	--	---	--------	--------------





MB	ALL	1	45,00	56,02	53,00		STD - 025 - 050 - 075 - 100 - BAR - BAR EM1	310.26	FIN026MB STD
----	-----	---	-------	-------	-------	--	---	--------	--------------



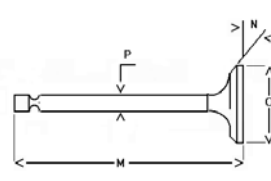

MB	ALL	1	58,74	62,42	36,00		STD - 025 - 050 - 075 - 100	310.06	FIN006MB STD
----	-----	---	-------	-------	-------	--	-----------------------------	--------	--------------

--	--	--	--	--	--	--	--	--	--

PB	BM	2	28,02	32,02	30,25		SEMIF.	316.35	FIN035PB
----	----	---	-------	-------	-------	--	--------	--------	----------

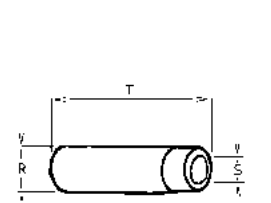
--	--	--	--	--	--	--	--	--	--

	IN EX		Nr.	O	P	M	N		ADATTABILE A: SUITABLE FOR:			
	IN		FS	2	42,5	9	119		45	E1	960.20	FINA122
	EX		FN	2	40	9	119		45	A1	960.21	FINS123

	IN EX		Nr.	R	S	T		ADATTABILE A: SUITABLE FOR:			
	IN		G	2	15,03	9,04		55	L	464.42	FIN201AA
	IN		G		15,13	9,04		55	L	464.30	FIN201AB
	EX		G	2	15,03	9,06		55	L	464.41	FIN202SA
	EX		G		15,13	9,06		55	L	464.20	FIN202SB

Ricambi non originali per motori. Denominazioni e codici originali, sono riportati a puro titolo di riferimento.

35 - 21

rel. 1511

Non original engine parts. OEMs names and part numbers are for reference purpose only.

RUGGERINI

RP 368	Cm³	CILINDRI CYLINDERS	ALESAGGIO BORE	CORSA STROKE	VERSIONE VERSION
	1732	2	105	100	

	2357	2399			447.73	447.60	448.06	448.06
FIN680CGA	FIN680CGB	FIN285SM	FIN3224RT	FIN3216RT	FIN208CO	FIN285CB	FIN610IG	FIN610IG

 ADATTABILE A: SUITABLE FOR:		Nr.	ENGINE KIT	ELECTRIC KIT
	448.96	1	 FIN035SL00	
		1	 FIN205PC00	
		1	 FIN284SM	
			FIN2038KIT	

387.62		359.16		175.19	175.22		
FIN2220AF		FIN1040NF		FIN4240FE	FIN4245OF		

				2197			
				FIN438OP			

	656.34	644.43	644.46	660.18	956.32		
	FIN712JP	FIN524NH	FIN179NO	FIN087E	FIN099DV		

014.18	730.13	563.02					
FIN698VA	FIN238VR	FIN734TL					

Ricambi non originali per motori. Denominazioni e codici originali, sono riportati a puro titolo di riferimento.



36 - 21







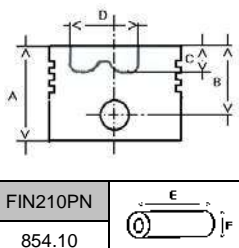

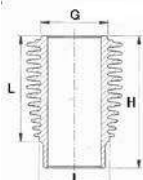
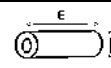
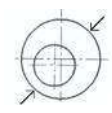
rel. 1511

Non original engine parts. OEMs names and part numbers are for reference purpose only.

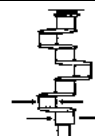
RUGGERINI

RP 380	Cm³	CILINDRI CYLINDERS	ALESAGGIO BORE	CORSA STROKE	VERSIONE VERSION
	1732	2	105	100	

		TESTA HEAD	H14		3	2,5	TIPO TYPE	A		
		A	105		1	2,5			G	118
		B	55		10	2,5			H	197,2
		C	18		22	5			I	112
		D	53,7						L	148
		E	84							
FIN210PN										
854.10										
	105	2347	FIN205PC00	2351	FIN078RS00	203.47	FIN035SL00			
	105,5	2348	FIN205PC05	2352	FIN078RS05					
	106	2349	FIN205PC10	2353	FIN078RS10					

		Nr.						ADATTABILE A: SUITABLE FOR:	
---	---	------------	---	---	---	---	---	--------------------------------	---

CR	AL	2	58,74	62,42	24,71		STD - 025 - 050 - 075 - 100	316.30	FIN030CR STD
----	----	---	-------	-------	-------	--	-----------------------------	--------	--------------

MB	ALL	1	50,00	65,03	34,00		STD - 025 - 050 - 075 - 100 - BAR - BAR EM1	310.21	FIN021MB STD
----	-----	---	-------	-------	-------	--	---	--------	--------------





MB	ALL	1	45,00	56,02	53,00		STD - 025 - 050 - 075 - 100 - BAR - BAR EM1	310.26	FIN026MB STD
----	-----	---	-------	-------	-------	--	---	--------	--------------



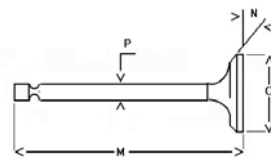

MB	ALL	1	58,74	62,42	36,00		STD - 025 - 050 - 075 - 100	310.06	FIN006MB STD
----	-----	---	-------	-------	-------	--	-----------------------------	--------	--------------

--	--	--	--	--	--	--	--	--	--

PB	BM	2	28,02	32,02	30,25		SEMIF.	316.35	FIN035PB
----	----	---	-------	-------	-------	--	--------	--------	----------

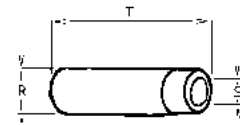
--	--	--	--	--	--	--	--	--	--

	IN EX		Nr.	O	P	M	N		ADATTABILE A: SUITABLE FOR:			
	IN		FS	2	42,5	9	119		45	E1	960.20	FINA122
	EX		FN	2	40	9	119		45	A1	960.21	FINS123

	IN EX		Nr.	R	S	T		ADATTABILE A: SUITABLE FOR:			
	IN		G	2	15,03	9,04		55	L	464.42	FIN201AA
	IN		G		15,13	9,04		55	L	464.30	FIN201AB
	EX		G	2	15,03	9,06		55	L	464.41	FIN202SA
	EX		G		15,13	9,06		55	L	464.20	FIN202SB

Ricambi non originali per motori. Denominazioni e codici originali, sono riportati a puro titolo di riferimento.

37 - 21

rel. 1511

Non original engine parts. OEMs names and part numbers are for reference purpose only.

RUGGERINI

RP 380	Cm³	CILINDRI CYLINDERS	ALESAGGIO BORE	CORSA STROKE	VERSIONE VERSION
	1732	2	105	100	

	2357	2399			447.73	447.60	448.06	448.06
FIN680CGA	FIN680CGB	FIN285SM	FIN3224RT	FIN3216RT	FIN208CO	FIN285CB	FIN610IG	FIN610IG

 	ADATTABILE A: SUITABLE FOR:		Nr.	ENGINE KIT	ELECTRIC KIT
	448.96	FIN628HG	1	 FIN035SL00	
			1	 FIN205PC00	
			1	 FIN284SM	
				FIN2038KIT	

387.62		359.16		175.19	175.22		
FIN2220AF		FIN1040NF		FIN4240FE	FIN4245OF		

				2197			
				FIN438OP			

	656.34	644.43	644.46	660.18	956.32		
	FIN712JP	FIN524NH	FIN179NO	FIN087E	FIN099DV		

014.18	730.13	563.02					
FIN698VA	FIN238VR	FIN734TL					

Ricambi non originali per motori. Denominazioni e codici originali, sono riportati a puro titolo di riferimento.





38 - 21





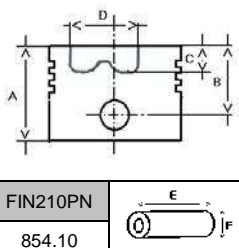

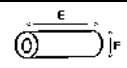
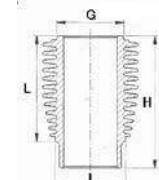

rel. 1511

Non original engine parts. OEMs names and part numbers are for reference purpose only.

RUGGERINI

RP 388	Cm³	CILINDRI CYLINDERS	ALESAGGIO BORE	CORSA STROKE	VERSIONE VERSION
	1732	2	105	100	

		TESTA HEAD	H14		3	2,5	TIPO TYPE	A	
		A	105		1	2,5			
		B	55		10	2,5			
		C	18		22	5			
		D	53,7						
		E	84						
FIN210PN		F	28					G	118
854.10								H	197,2
								I	112
	105	2347	FIN205PC00	2351	FIN078RS00	203.47	L	148	
	105,5	2348	FIN205PC05	2352	FIN078RS05		FIN035SL00		
	106	2349	FIN205PC10	2353	FIN078RS10				

		Nr.							ADATTABILE A: SUITABLE FOR:	
---	---	------------	---	---	---	---	---	--	--------------------------------	---

CR	AL	2	58,74	62,42	24,71			STD - 025 - 050 - 075 - 100	316.30	FIN030CR STD
----	----	---	-------	-------	-------	--	--	-----------------------------	--------	--------------

MB	ALL	1	50,00	65,03	34,00			STD - 025 - 050 - 075 - 100 - BAR - BAR EM1	310.21	FIN021MB STD
----	-----	---	-------	-------	-------	--	--	---	--------	--------------





MB	ALL	1	45,00	56,02	53,00			STD - 025 - 050 - 075 - 100 - BAR - BAR EM1	310.26	FIN026MB STD
----	-----	---	-------	-------	-------	--	--	---	--------	--------------



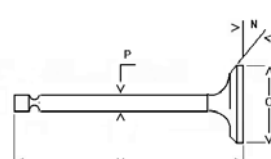

MB	ALL	1	58,74	62,42	36,00			STD - 025 - 050 - 075 - 100	310.06	FIN006MB STD
----	-----	---	-------	-------	-------	--	--	-----------------------------	--------	--------------

--	--	--	--	--	--	--	--	--	--	--

PB	BM	2	28,02	32,02	30,25			SEMIF.	316.35	FIN035PB
----	----	---	-------	-------	-------	--	--	--------	--------	----------

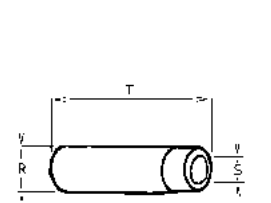
--	--	--	--	--	--	--	--	--	--	--

	IN EX		Nr.	O	P	M	N		ADATTABILE A: SUITABLE FOR:				
	IN		FS	2	42,5	9	119		45		E1	960.20	FINA122
	EX		FN	2	40	9	119		45		A1	960.21	FINS123

	IN EX		Nr.	R	S	T		ADATTABILE A: SUITABLE FOR:				
	IN		G	2	15,03	9,04		55		L	464.42	FIN201AA
	IN		G		15,13	9,04		55		L	464.30	FIN201AB
	EX		G	2	15,03	9,06		55		L	464.41	FIN202SA
	EX		G		15,13	9,06		55		L	464.20	FIN202SB

Ricambi non originali per motori. Denominazioni e codici originali, sono riportati a puro titolo di riferimento.

39 - 21

rel. 1511

Non original engine parts. OEMs names and part numbers are for reference purpose only.

RUGGERINI

RP 388	Cm³	CILINDRI CYLINDERS	ALESAGGIO BORE	CORSA STROKE	VERSIONE VERSION
	1732	2	105	100	

	2357	2399			447.73	447.60	448.06	448.06
FIN680CGA	FIN680CGB	FIN285SM	FIN3224RT	FIN3216RT	FIN208CO	FIN285CB	FIN610IG	FIN610IG

 ADATTABILE A: SUITABLE FOR:		Nr. ENGINE KIT	ELECTRIC KIT 				
	448.96			FIN628HG	1		FIN035SL00
					1		FIN205PC00
					1		FIN284SM
							FIN2038KIT

387.62		359.16		175.19	175.22		
FIN2220AF		FIN1040NF		FIN4240FE	FIN4245OF		

				2197			
				FIN438OP			

	656.34	644.43	644.46	660.18	956.32		
	FIN712JP	FIN524NH	FIN179NO	FIN087E	FIN099DV		

014.18	730.13	563.02					
FIN698VA	FIN238VR	FIN734TL					

Ricambi non originali per motori. Denominazioni e codici originali, sono riportati a puro titolo di riferimento.

40 - 21

rel. 1511

Non original engine parts. OEMs names and part numbers are for reference purpose only.

RUGGERINI

CRD – P – RP

ALTRI ARTICOLI

OTHERS ITEMS

POS.	ARTICOLO	ITEM	MOTORE ENGINE	CODICE FINIMPIANTI FINIMPIANTI REF.	ADATTABILE A SUITABLE FOR:
1	Kit anelli di tenuta	Seal rings kit	CRD 951 , CRD 100 P 101 , P 101L , RP 170 RP 178	FIN3225RTS (FIN3224RT + FIN3223RT)	2161
2	Kit anelli di tenuta	Seal rings kit	CRD 951/2 , CRD 100/2 P 101/2 , P 101/2L P105/2 , P 105/2R P 105/2L , RP 280 RP 320 , RP 328 RP 360 , RP 368 RP 380 , RP 388	FIN3226RTS (FIN3224RT + FIN3216RT)	2202
3	Polverizzatore	Nozzle	RP 170 "CIPA"	FIN176NO	644.08
4	Polverizzatore	Nozzle	RP 178 "CIPA"	FIN114NO	644.26
5	Anello asta bilanciere	Guard tube seal	All models	FIN086AP	579.12
6					
7					
8					
9					
10					
11					
12					
13					
14					
15					
16					
17					
18					
19					

RUGGERINI

CRD – P – RP

ALTRI ARTICOLI

OTHERS ITEMS

POS.	ARTICOLO	<i>ITEM</i>	MOTORE <i>ENGINE</i>	CODICE FINIMPIANTI <i>FINIMPIANTI REF.</i>	ADATTABILE A <i>SUITABLE FOR:</i>
20					
21					
22					
23					
24					
25					
26					
27					
28					
29					
30					
31					
32					
33					
34					
35					
36					
37					
38					

**CODICI FINIMPIANTI
CODICI ORIGINALI**

***FINIMPIANTI REFERENCES
OEM REFERENCES***

Tavole di corrispondenza

Cross references

Finimpianti	OEM	Costruttore-Motore Manufacturer-Engine	Cp.	Pg.
FIN001MB STD	311.01	RUGGERINI RF 90	17	11
FIN001MB STD	311.01	RUGGERINI RF 91	17	13
FIN001MB STD	311.01	RUGGERINI RF 120	17	17
FIN001MB STD	311.01	RUGGERINI RF 121	17	19
FIN001MB STD	311.01	RUGGERINI RF 140	17	23
FIN001MB STD	311.01	RUGGERINI RF 80	17	5
FIN001MB STD	311.01	RUGGERINI RF 81	17	7
FIN002MB STD	311.19	RUGGERINI RY 100	20	13
FIN002MB STD	311.19	RUGGERINI RY 101	20	15
FIN002MB STD	311.19	RUGGERINI RY 120	20	19
FIN002MB STD	311.19	RUGGERINI RY 121	20	21
FIN002MB STD	311.19	RUGGERINI RY 125	20	23
FIN002MB STD	311.19	RUGGERINI RY 85.0	20	5
FIN002MB STD	311.19	RUGGERINI RY 85.1	20	7
FIN002RS00	A2816	ACME ADX 300	16	49
FIN002RS00	A2816	ACME ADX 600	16	53
FIN002RS05	A2817	ACME ADX 300	16	49
FIN002RS05	A2817	ACME ADX 600	16	53
FIN002RS10	A2818	ACME ADX 300	16	49
FIN002RS10	A2818	ACME ADX 600	16	53
FIN002TW STD	060.39	RUGGERINI RF 90	17	11
FIN002TW STD	060.39	RUGGERINI RF 91	17	13
FIN002TW STD	060.39	RUGGERINI RF 120	17	17
FIN002TW STD	060.39	RUGGERINI RF 121	17	19
FIN002TW STD	060.39	RUGGERINI RF 140	17	23
FIN002TW STD	060.39	RUGGERINI RF 80	17	5
FIN002TW STD	060.39	RUGGERINI RF 81	17	7
FIN003CN		ACME ADN 37	16	18
FIN003CN		ACME ADN 37 W	16	20
FIN003CN		ACME ADN 43	16	22
FIN003CN		ACME ADN 43 W	16	24
FIN003CN		RUGGERINI RF 88	17	10
FIN003CN		RUGGERINI RF 90	17	12
FIN003CN		RUGGERINI RF 91	17	14
FIN003CN		RUGGERINI RF 100	17	16
FIN003CN		RUGGERINI RF 120	17	18
FIN003CN		RUGGERINI MC 70	17	2
FIN003CN		RUGGERINI RF 121	17	20
FIN003CN		RUGGERINI RF 130	17	22
FIN003CN		RUGGERINI RF 140	17	24
FIN003CN		RUGGERINI RF 148	17	26
FIN003CN		RUGGERINI MC 71	17	4
FIN003CN		RUGGERINI RF 80	17	6
FIN003CN		RUGGERINI RF 81	17	8
FIN003CN		RUGGERINI RD 188	18	10
FIN003CN		RUGGERINI RD 850	18	12
FIN003CN		RUGGERINI RD 901/A	18	14
FIN003CN		RUGGERINI RD 200	18	16
FIN003CN		RUGGERINI RD 201	18	18
FIN003CN		RUGGERINI RD 80	18	2
FIN003CN		RUGGERINI RD 208	18	20
FIN003CN		RUGGERINI RD 900	18	22
FIN003CN		RUGGERINI RD 901	18	24
FIN003CN		RUGGERINI RD 901/AD	18	26
FIN003CN		RUGGERINI RD 210	18	28
FIN003CN		RUGGERINI RD 211	18	30
FIN003CN		RUGGERINI RD 218	18	32
FIN003CN		RUGGERINI RD 220	18	34
FIN003CN		RUGGERINI RD 920	18	38
FIN003CN		RUGGERINI RD 81	18	4
FIN003CN		RUGGERINI RD 920 L	18	40
FIN003CN		RUGGERINI RD 240	18	42
FIN003CN		RUGGERINI RD 248	18	44
FIN003CN		RUGGERINI RD 950	18	50
FIN003CN		RUGGERINI RD 950 L	18	52
FIN003CN		RUGGERINI RD 270	18	54
FIN003CN		RUGGERINI RD 278	18	56
FIN003CN		RUGGERINI RD 952	18	58
FIN003CN		RUGGERINI RD 180	18	6
FIN003CN		RUGGERINI RD 181	18	8
FIN003CN		RUGGERINI MD 85.0	19	14
FIN003CN		RUGGERINI MD 85.1	19	16
FIN003CN		RUGGERINI MD 95.0	19	18
FIN003CN		RUGGERINI MD 75.0	19	2
FIN003CN		RUGGERINI MD 95.1	19	20
FIN003CN		RUGGERINI MD 170	19	22
FIN003CN		RUGGERINI MD 171	19	24
FIN003CN		RUGGERINI MD 190	19	26
FIN003CN		RUGGERINI MD 191	19	28
FIN003CN		RUGGERINI MD 75.1	19	4
FIN003CN		RUGGERINI MD 150	19	6
FIN003CN		RUGGERINI MD 151	19	8
FIN004KIT		ACME ADN 43	16	22
FIN004RS00	A2591	ACME ADN 45	16	27
FIN004RS00	A2591	ACME ADN 45 W	16	29
FIN004RS00	B0104	ACME ADX 370	16	51
FIN004RS00	B0104	ACME ADX 740	16	55
FIN004RS00	B0104	ACME ADX 742	16	57
FIN004RS05	A2592	ACME ADN 45	16	27
FIN004RS05	A2592	ACME ADN 45 W	16	29
FIN004RS05	B0105	ACME ADX 370	16	51
FIN004RS05	B0105	ACME ADX 740	16	55
FIN004RS05	B0105	ACME ADX 742	16	57
FIN004RS10	A2593	ACME ADN 45	16	27

Finimpianti	OEM	Costruttore-Motore Manufacturer-Engine	Cp.	Pg.
FIN004RS10	A2593	ACME ADN 45 W	16	29
FIN004RS10	B0106	ACME ADX 370	16	51
FIN004RS10	B0106	ACME ADX 740	16	55
FIN004RS10	B0106	ACME ADX 742	16	57
FIN005KIT		ACME ADN 43 W	16	24
FIN005RS00	A2552	ACME ADN 43	16	21
FIN005RS00	A2552	ACME ADN 43 W	16	23
FIN005RS00	A2552	ACME ADN 48	16	33
FIN005RS00	A2552	ACME ADN 48 W	16	35
FIN005RS05	A2579	ACME ADN 43	16	21
FIN005RS05	A2579	ACME ADN 43 W	16	23
FIN005RS05	A2579	ACME ADN 48	16	33
FIN005RS05	A2579	ACME ADN 48 W	16	35
FIN005RS10	A2580	ACME ADN 43	16	21
FIN005RS10	A2580	ACME ADN 43 W	16	23
FIN005RS10	A2580	ACME ADN 48	16	33
FIN005RS10	A2580	ACME ADN 48 W	16	35
FIN006FP	6585.006	INTERMOTOR LA 490	14	38
FIN006FP	6585.006	INTERMOTOR LAP 490	14	40
FIN006KIT		ACME ADN 45	16	26
FIN006MB STD	310.06	RUGGERINI P 101/2	21	13
FIN006MB STD	310.06	RUGGERINI P 101/2 L	21	15
FIN006MB STD	310.06	RUGGERINI P 105/2	21	17
FIN006MB STD	310.06	RUGGERINI P 105/2 R	21	19
FIN006MB STD	310.06	RUGGERINI P 105/2 L	21	21
FIN006MB STD	310.06	RUGGERINI RP 280	21	23
FIN006MB STD	310.06	RUGGERINI RP 320	21	29
FIN006MB STD	310.06	RUGGERINI CRD 951/2	21	3
FIN006MB STD	310.06	RUGGERINI RP 328	21	31
FIN006MB STD	310.06	RUGGERINI RP 360	21	33
FIN006MB STD	310.06	RUGGERINI RP 368	21	35
FIN006MB STD	310.06	RUGGERINI RP 380	21	37
FIN006MB STD	310.06	RUGGERINI RP 388	21	39
FIN006MB STD	310.06	RUGGERINI CRD 100/2	21	7
FIN006RS00	A2398	ACME VT 88 W	16	59
FIN006RS00	A2398	ACME AL 480	16	61
FIN006RS05	A2399	ACME VT 88 W	16	59
FIN006RS05	A2399	ACME AL 480	16	61
FIN006RS10	A2400	ACME VT 88 W	16	59
FIN006RS10	A2400	ACME AL 480	16	61
FIN007KIT		ACME ADN 45	16	28
FIN007RS00	A2670	ACME ADN 54	16	39
FIN007RS00	A2670	ACME ADN 54 W	16	41
FIN007RS05	A2671	ACME ADN 54	16	39
FIN007RS05	A2671	ACME ADN 54 W	16	41
FIN007RS10	A2672	ACME ADN 54	16	39
FIN007RS10	A2672	ACME ADN 54 W	16	41
FIN008KIT		ACME ADN 45 W	16	30
FIN010AA	464.134	ACME ADN 37 W	16	19
FIN010AA	464.134	ACME ADN 43 W	16	23
FIN010AA	464.134	ACME ADN 45 W	16	29
FIN010AA	464.134	ACME ADN 48 W	16	35
FIN010AA	464.134	ACME ADN 54 W	16	41
FIN010AA	464.134	ACME ADN 60 W	16	47
FIN010KIT		ACME ADN 48	16	34
FIN011E	660.17	RUGGERINI RF 100	17	16
FIN011E	660.17	RUGGERINI RF 120	17	18
FIN011E	660.17	RUGGERINI RF 121	17	20
FIN011E	660.17	RUGGERINI RF 130	17	22
FIN011E	660.17	RUGGERINI RF 140	17	24
FIN011E	660.17	RUGGERINI RF 148	17	26
FIN011E	660.17	RUGGERINI RD 220	18	34
FIN011E	660.17	RUGGERINI RD 901/2	18	36
FIN011E	660.17	RUGGERINI RD 240	18	42
FIN011E	660.17	RUGGERINI RD 248	18	44
FIN011E	660.17	RUGGERINI RD 92/2	18	46
FIN011E	660.17	RUGGERINI RD 270	18	54
FIN011E	660.17	RUGGERINI RD 952	18	58
FIN011E	660.17	RUGGERINI P 101	21	10
FIN011E	660.17	RUGGERINI P 101 L	21	12
FIN011E	660.17	RUGGERINI P 101/2	21	14
FIN011E	660.17	RUGGERINI P 101/2 L	21	16
FIN011E	660.17	RUGGERINI CRD 951	21	2
FIN011E	660.17	RUGGERINI RP 280	21	24
FIN011E	660.17	RUGGERINI RP 170	21	26
FIN011E	660.17	RUGGERINI RP 320	21	30
FIN011E	660.17	RUGGERINI RP 328	21	32
FIN011E	660.17	RUGGERINI CRD 951/2	21	4
FIN011E	660.17	RUGGERINI CRD 100	21	6
FIN011E	660.17	RUGGERINI CRD 100/2	21	8
FIN011KIT		ACME ADN 48 W	16	36
FIN011PC00	B0389	ACME ADN 60 W	16	47
FIN011SA	464.133	ACME ADN 37 W	16	19
FIN011SA	464.133	ACME ADN 43 W	16	23
FIN011SA	464.133	ACME ADN 45 W	16	29
FIN011SA	464.133	ACME ADN 48 W	16	35
FIN011SA	464.133	ACME ADN 54 W	16	41
FIN011SA	464.133	ACME ADN 60 W	16	47
FIN012AA	B0430	ACME ALN 290 W	16	1
FIN012AA	B0430	ACME ALN 330 W	16	3
FIN012KIT		ACME AD 114	16	12
FIN012KIT		ACME AD 112	16	14
FIN012KIT		ACME ADN 54	16	38
FIN012PC00	A2716	ACME ADN 60	16	45

Tavole di corrispondenza

Cross references

Finimpianti	OEM	Costruttore-Motore <i>Manufacturer-Engine</i>	Cp.	Pg.
FINO13KIT		ACME ADN 54	16	40
FINO13PC00	2205	ACME AD 116	16	15
FINO13PC05	2209	ACME AD 116	16	15
FINO13PC10	2210	ACME AD 116	16	15
FINO13SA	B0429	ACME ALN 290 W	16	1
FINO13SA	B0429	ACME ALN 330 W	16	3
FINO13TWS STD	1257.048	SLANZI DVA 1550	15	11
FINO13TWS STD	1257.048	SLANZI DVA 1550 S	15	13
FINO13TWS STD	1257.048	SLANZI DVA 1750	15	21
FINO13TWS STD	1257.048	SLANZI DVA 1750 S	15	23
FINO13TWS STD	1257.048	SLANZI DVA 2350	15	25
FINO13TWS STD	1257.048	SLANZI DVA 1500	15	27
FINO13TWS STD	1257.048	SLANZI DVA 2200	15	29
FINO13TWS STD	1257.048	SLANZI DVA 2900	15	31
FINO14AA	B0038	ACME ADX 300	16	49
FINO14AA	B0038	ACME ADX 370	16	51
FINO14AA	B0038	ACME ADX 600	16	53
FINO14AA	B0038	ACME ADX 740	16	55
FINO14AA	B0038	ACME ADX 742	16	57
FINO14KIT		ACME ADN 54 W	16	42
FINO14PB	0016300140	RUGGERINI RD 290	18	59
FINO15KIT		ACME ADN 60	16	44
FINO15SA	B0039	ACME ADX 300	16	49
FINO15SA	B0039	ACME ADX 370	16	51
FINO15SA	B0039	ACME ADX 600	16	53
FINO15SA	B0039	ACME ADX 740	16	55
FINO15SA	B0039	ACME ADX 742	16	57
FINO16DV	0096720120	RUGGERINI RD 290	18	60
FINO16DV	0096720120	RUGGERINI SP 420	18	62
FINO16DV	956.005	ACME AD 114 / A	16	10
FINO16DV	956.005	ACME AD 114	16	12
FINO16DV	956.005	ACME AD 112	16	14
FINO16DV	956.005	ACME AD 116	16	16
FINO16DV	956.005	ACME ADN 37	16	18
FINO16DV	956.005	ACME ADN 45	16	26
FINO16DV	956.005	ACME ADN 48	16	32
FINO16DV	956.005	ACME ADN 54	16	38
FINO16DV	956.005	ACME ADN 60	16	44
FINO16DV	956.005	ACME AD 108	16	6
FINO16DV	956.005	ACME AD 110	16	8
FINO16DV	956.005	RUGGERINI RF 100	17	16
FINO16DV	956.005	RUGGERINI RD 850	18	12
FINO16DV	956.005	RUGGERINI RD 901/A	18	14
FINO16DV	956.005	RUGGERINI RD 80	18	2
FINO16DV	956.005	RUGGERINI RD 900	18	22
FINO16DV	956.005	RUGGERINI RD 901	18	24
FINO16DV	956.005	RUGGERINI RD 901/AD	18	26
FINO16DV	956.005	RUGGERINI RD 920	18	38
FINO16DV	956.005	RUGGERINI RD 81	18	4
FINO16DV	956.005	RUGGERINI RD 920 L	18	40
FINO16DV	956.005	RUGGERINI RD 950	18	50
FINO16DV	956.005	RUGGERINI RD 950 L	18	52
FINO16DV	956.27	RUGGERINI RF 120	17	18
FINO16DV	956.27	RUGGERINI RF 121	17	20
FINO16DV	956.27	RUGGERINI RF 130	17	22
FINO16DV	956.27	RUGGERINI RF 140	17	24
FINO16DV	956.27	RUGGERINI RF 148	17	26
FINO16DV	956.27	RUGGERINI RD 220	18	34
FINO16DV	956.27	RUGGERINI RD 901/2	18	36
FINO16DV	956.27	RUGGERINI RD 240	18	42
FINO16DV	956.27	RUGGERINI RD 248	18	44
FINO16DV	956.27	RUGGERINI RD 92/2	18	46
FINO16DV	956.27	RUGGERINI RD 92/2 L	18	48
FINO16DV	956.27	RUGGERINI RD 270	18	54
FINO16DV	956.27	RUGGERINI RD 278	18	56
FINO16DV	956.27	RUGGERINI RD 952	18	58
FINO16DV	956.27	RUGGERINI P 101	21	10
FINO16DV	956.27	RUGGERINI P 101 L	21	12
FINO16DV	956.27	RUGGERINI P 101/2	21	14
FINO16DV	956.27	RUGGERINI P 101/2 L	21	16
FINO16DV	956.27	RUGGERINI CRD 951	21	2
FINO16DV	956.27	RUGGERINI RP 280	21	24
FINO16DV	956.27	RUGGERINI RP 170	21	26
FINO16DV	956.27	RUGGERINI RP 178	21	28
FINO16DV	956.27	RUGGERINI RP 320	21	30
FINO16DV	956.27	RUGGERINI RP 328	21	32
FINO16DV	956.27	RUGGERINI CRD 951/2	21	4
FINO16DV	956.27	RUGGERINI CRD 100	21	6
FINO16DV	956.27	RUGGERINI CRD 100/2	21	8
FINO16DV	9672.031	SLANZI DVA 1030 S	15	10
FINO16DV	9672.031	SLANZI DVA 1550	15	12
FINO16DV	9672.031	SLANZI DVA 1550 S	15	14
FINO16DV	9672.031	SLANZI DVA 460	15	2
FINO16DV	9672.031	SLANZI DVA 1200	15	20
FINO16DV	9672.031	SLANZI DVA 1750	15	22
FINO16DV	9672.031	SLANZI DVA 1750 S	15	24
FINO16DV	9672.031	SLANZI DVA 2350	15	26
FINO16DV	9672.031	SLANZI DVA 1500	15	28
FINO16DV	9672.031	SLANZI DVA 1800	15	34
FINO16DV	9672.031	SLANZI DVA 2700	15	36
FINO16DV	9672.031	SLANZI DVA 3600	15	38
FINO16DV	9672.031	SLANZI DVA 920	15	4
FINO16DV	9672.031	SLANZI DS 2000	15	40
FINO16DV	9672.031	SLANZI DS 3000	15	42

Finimpianti	OEM	Costruttore-Motore <i>Manufacturer-Engine</i>	Cp.	Pg.
FINO16DV	9672.031	SLANZI DS 4000	15	44
FINO16DV	9672.031	SLANZI DVA 515	15	6
FINO16DV	9672.031	SLANZI DVA 1030	15	8
FINO16MB STD	310.016	ACME AD 114	16	11
FINO16MB STD	310.016	ACME AD 112	16	13
FINO16MB STD	310.016	ACME AD 116	16	15
FINO16MB STD	310.016	ACME ADN 37	16	17
FINO16MB STD	310.016	ACME ADN 37 W	16	19
FINO16MB STD	310.016	ACME ADN 43	16	21
FINO16MB STD	310.016	ACME ADN 43 W	16	23
FINO16MB STD	310.016	ACME ADN 45	16	25
FINO16MB STD	310.016	ACME ADN 45	16	27
FINO16MB STD	310.016	ACME ADN 45 W	16	29
FINO16MB STD	310.016	ACME ADN 48	16	31
FINO16MB STD	310.016	ACME ADN 48	16	33
FINO16MB STD	310.016	ACME ADN 48 W	16	35
FINO16MB STD	310.016	ACME ADN 54	16	37
FINO16MB STD	310.016	ACME ADN 54	16	39
FINO16MB STD	310.016	ACME ADN 54 W	16	41
FINO16MB STD	310.016	ACME ADN 60	16	43
FINO16MB STD	310.016	ACME ADN 60	16	45
FINO16MB STD	310.016	ACME ADN 60 W	16	47
FINO16MB STD	310.016	ACME AD 108	16	5
FINO16MB STD	310.016	ACME AD 110	16	7
FINO16MB STD	310.016	ACME AD 114 / A	16	9
FINO16MB STD	310.16	RUGGERINI MC 70	17	1
FINO16MB STD	310.16	RUGGERINI RF 90	17	11
FINO16MB STD	310.16	RUGGERINI RF 91	17	13
FINO16MB STD	310.16	RUGGERINI RF 100	17	15
FINO16MB STD	310.16	RUGGERINI RF 120	17	17
FINO16MB STD	310.16	RUGGERINI RF 121	17	19
FINO16MB STD	310.16	RUGGERINI RF 130	17	21
FINO16MB STD	310.16	RUGGERINI RF 140	17	23
FINO16MB STD	310.16	RUGGERINI RF 148	17	25
FINO16MB STD	310.16	RUGGERINI MC 71	17	3
FINO16MB STD	310.16	RUGGERINI RF 80	17	5
FINO16MB STD	310.16	RUGGERINI RF 81	17	7
FINO16MB STD	310.16	RUGGERINI RF 88	17	9
FINO16MB STD	310.16	RUGGERINI RD 80	18	1
FINO16MB STD	310.16	RUGGERINI RD 850	18	11
FINO16MB STD	310.16	RUGGERINI RD 901/A	18	13
FINO16MB STD	310.16	RUGGERINI RD 900	18	21
FINO16MB STD	310.16	RUGGERINI RD 901	18	23
FINO16MB STD	310.16	RUGGERINI RD 901/AD	18	25
FINO16MB STD	310.16	RUGGERINI RD 81	18	3
FINO16MB STD	310.16	RUGGERINI RD 920	18	37
FINO16MB STD	310.16	RUGGERINI RD 920 L	18	39
FINO16MB STD	310.16	RUGGERINI RD 950	18	49
FINO16MB STD	310.16	RUGGERINI RD 950 L	18	51
FINO18CB	1200.198	SLANZI DVA 1500	15	28
FINO18CB	1200.198	SLANZI DVA 2200	15	30
FINO18CB	1200.198	SLANZI DVA 2900	15	32
FINO18NH	0066150180	RUGGERINI RD 290	18	60
FINO19CB	4431.116	SLANZI DVA 1030 S	15	10
FINO19CB	4431.116	SLANZI DVA 1550	15	12
FINO19CB	4431.116	SLANZI DVA 1550 S	15	14
FINO19CB	4431.116	SLANZI DVA 460	15	2
FINO19CB	4431.116	SLANZI DVA 1200	15	20
FINO19CB	4431.116	SLANZI DVA 920	15	4
FINO19CB	4431.116	SLANZI DVA 515	15	6
FINO19CB	4431.116	SLANZI DVA 1030	15	8
FINO20FE	175.32	RUGGERINI RF 90	17	12
FINO20FE	175.32	RUGGERINI RF 91	17	14
FINO20FE	175.32	RUGGERINI MC 70	17	2
FINO20FE	175.32	RUGGERINI MC 71	17	4
FINO20FE	175.32	RUGGERINI RF 80	17	6
FINO20FE	175.32	RUGGERINI RF 81	17	8
FINO20FE	175.32	RUGGERINI MD 85.0	19	14
FINO20FE	175.32	RUGGERINI MD 85.1	19	16
FINO20FE	175.32	RUGGERINI MD 95.0	19	18
FINO20FE	175.32	RUGGERINI MD 75.0	19	2
FINO20FE	175.32	RUGGERINI MD 95.1	19	20
FINO20FE	175.32	RUGGERINI MD 170	19	22
FINO20FE	175.32	RUGGERINI MD 171	19	24
FINO20FE	175.32	RUGGERINI MD 190	19	26
FINO20FE	175.32	RUGGERINI MD 191	19	28
FINO20FE	175.32	RUGGERINI MD 75.1	19	4
FINO20FE	175.32	RUGGERINI MD 150	19	6
FINO20FE	175.32	RUGGERINI MD 151	19	8
FINO21MB STD	310.21	RUGGERINI CRD 951	21	1
FINO21MB STD	310.21	RUGGERINI P 101 L	21	11
FINO21MB STD	310.21	RUGGERINI P 101/2	21	13
FINO21MB STD	310.21	RUGGERINI P 101/2 L	21	15
FINO21MB STD	310.21	RUGGERINI P 105/2	21	17
FINO21MB STD	310.21	RUGGERINI P 105/2 R	21	19
FINO21MB STD	310.21	RUGGERINI P 105/2 L	21	21
FINO21MB STD	310.21	RUGGERINI RP 280	21	23
FINO21MB STD	310.21	RUGGERINI RP 170	21	25
FINO21MB STD	310.21	RUGGERINI RP 178	21	27
FINO21MB STD	310.21	RUGGERINI RP 320	21	29
FINO21MB STD	310.21	RUGGERINI CRD 951/2	21	3
FINO21MB STD	310.21	RUGGERINI RP 328	21	31
FINO21MB STD	310.21	RUGGERINI RP 360	21	33
FINO21MB STD	310.21	RUGGERINI RP 368	21	35

Ricambi non originali per motori. Denominazioni e codici originali, sono riportati a puro titolo di riferimento.

2 - A

rel. 1511

Non original engine parts. OEMs names and part numbers are for reference purpose only.

Tavole di corrispondenza

Cross references

Finimpianti	OEM	Costruttore-Motore <i>Manufacturer-Engine</i>	Cp.	Pg.
FIN021MB STD	310.21	RUGGERINI RP 380	21	37
FIN021MB STD	310.21	RUGGERINI RP 388	21	39
FIN021MB STD	310.21	RUGGERINI CRD 100	21	5
FIN021MB STD	310.21	RUGGERINI CRD 100/2	21	7
FIN021MB STD	310.21	RUGGERINI P 101	21	9
FIN022CFA	0054962200	RUGGERINI RY 50	20	2
FIN022CFA	0054962200	RUGGERINI RY 70	20	4
FIN022CFA	0054963330	RUGGERINI RY 75	20	10
FIN022CFA	0054963330	RUGGERINI RY 103	20	12
FIN022CFA	0054963330	RUGGERINI RY 110	20	18
FIN022OP	2122	RUGGERINI RF 88	17	10
FIN022OP	2122	RUGGERINI RF 100	17	16
FIN022OP	2122	RUGGERINI MC 70	17	2
FIN022OP	2122	RUGGERINI RF 130	17	22
FIN022OP	2122	RUGGERINI RF 148	17	26
FIN022OP	2122	RUGGERINI MC 71	17	4
FIN022OP	2122	RUGGERINI RD 850	18	12
FIN022OP	2122	RUGGERINI RD 901/A	18	14
FIN022OP	2122	RUGGERINI RD 80	18	2
FIN022OP	2122	RUGGERINI RD 900	18	22
FIN022OP	2122	RUGGERINI RD 901	18	24
FIN022OP	2122	RUGGERINI RD 901/AD	18	26
FIN022OP	2122	RUGGERINI RD 920	18	38
FIN022OP	2122	RUGGERINI RD 81	18	4
FIN022OP	2122	RUGGERINI RD 920 L	18	40
FIN022OP	2122	RUGGERINI RD 950	18	50
FIN022OP	2122	RUGGERINI RD 950 L	18	52
FIN022OP	2122	ACME AD 114 / A	16	10
FIN022OP	2122	ACME AD 114	16	12
FIN022OP	2122	ACME AD 112	16	14
FIN022OP	2122	ACME AD 116	16	16
FIN022OP	2122	ACME ADN 37	16	18
FIN022OP	2122	ACME ADN 37 W	16	20
FIN022OP	2122	ACME ADN 43	16	22
FIN022OP	2122	ACME ADN 43 W	16	24
FIN022OP	2122	ACME ADN 45	16	26
FIN022OP	2122	ACME ADN 45	16	28
FIN022OP	2122	ACME ADN 45 W	16	30
FIN022OP	2122	ACME ADN 48	16	32
FIN022OP	2122	ACME ADN 48	16	34
FIN022OP	2122	ACME ADN 48 W	16	36
FIN022OP	2122	ACME ADN 54	16	38
FIN022OP	2122	ACME ADN 54	16	40
FIN022OP	2122	ACME ADN 54 W	16	42
FIN022OP	2122	ACME ADN 60	16	44
FIN022OP	2122	ACME ADN 60	16	46
FIN022OP	2122	ACME ADN 60 W	16	48
FIN022OP	2122	ACME AD 108	16	6
FIN022OP	2122	ACME AD 110	16	8
FIN023SF	894.21	RUGGERINI RF 90	17	12
FIN023SF	894.21	RUGGERINI RF 91	17	14
FIN023SF	894.21	RUGGERINI RF 120	17	18
FIN023SF	894.21	RUGGERINI RF 121	17	20
FIN023SF	894.21	RUGGERINI RF 140	17	24
FIN023SF	894.21	RUGGERINI RF 80	17	6
FIN023SF	894.21	RUGGERINI RF 81	17	8
FIN025SL00	203.019	ACME ADN 37	16	17
FIN025SL00	203.019	ACME ADN 37 W	16	19
FIN025SL00	203.19	RUGGERINI MC 70	17	1
FIN025SL00	203.19	RUGGERINI MC 71	17	3
FIN025SL00	203.19	RUGGERINI RF 80	17	5
FIN025SL00	203.19	RUGGERINI RF 81	17	7
FIN025SL00	203.19	RUGGERINI RF 88	17	9
FIN025SL00	203.19	RUGGERINI RD 80	18	1
FIN025SL00	203.19	RUGGERINI RD 81	18	3
FIN025TS	0090430250	RUGGERINI RD 290	18	60
FIN025TS	0090430250	RUGGERINI SP 420	18	62
FIN026MB STD	310.26	RUGGERINI CRD 951	21	1
FIN026MB STD	310.26	RUGGERINI P 101 L	21	11
FIN026MB STD	310.26	RUGGERINI P 101/2	21	13
FIN026MB STD	310.26	RUGGERINI P 101/2 L	21	15
FIN026MB STD	310.26	RUGGERINI P 105/2	21	17
FIN026MB STD	310.26	RUGGERINI P 105/2 R	21	19
FIN026MB STD	310.26	RUGGERINI P 105/2 L	21	21
FIN026MB STD	310.26	RUGGERINI RP 280	21	23
FIN026MB STD	310.26	RUGGERINI RP 170	21	25
FIN026MB STD	310.26	RUGGERINI RP 178	21	27
FIN026MB STD	310.26	RUGGERINI RP 320	21	29
FIN026MB STD	310.26	RUGGERINI CRD 951/2	21	3
FIN026MB STD	310.26	RUGGERINI RP 328	21	31
FIN026MB STD	310.26	RUGGERINI RP 360	21	33
FIN026MB STD	310.26	RUGGERINI RP 368	21	35
FIN026MB STD	310.26	RUGGERINI RP 380	21	37
FIN026MB STD	310.26	RUGGERINI RP 388	21	39
FIN026MB STD	310.26	RUGGERINI CRD 100	21	5
FIN026MB STD	310.26	RUGGERINI CRD 100/2	21	7
FIN026MB STD	310.26	RUGGERINI P 101	21	9
FIN026RS00	8210.096	INTERMOTOR Benzina Petrol IM 250	14	1
FIN026RS00	8210.096	INTERMOTOR Benzina Petrol IM 250	14	3
FIN026RS00	8210.096	INTERMOTOR Benzina Petrol IM 252	14	5

Finimpianti	OEM	Costruttore-Motore <i>Manufacturer-Engine</i>	Cp.	Pg.
FIN026RS00	8210.096	INTERMOTOR Benzina Petrol IM 252	14	7
FIN026RS05	8210.097	INTERMOTOR Benzina Petrol IM 250	14	1
FIN026RS05	8210.097	INTERMOTOR Benzina Petrol IM 250	14	3
FIN026RS05	8210.097	INTERMOTOR Benzina Petrol IM 252	14	5
FIN026RS05	8210.097	INTERMOTOR Benzina Petrol IM 252	14	7
FIN026RS10	8210.098	INTERMOTOR Benzina Petrol IM 250	14	1
FIN026RS10	8210.098	INTERMOTOR Benzina Petrol IM 250	14	3
FIN026RS10	8210.098	INTERMOTOR Benzina Petrol IM 252	14	5
FIN026RS10	8210.098	INTERMOTOR Benzina Petrol IM 252	14	7
FIN026SL00	203.65	RUGGERINI RD 200	18	15
FIN026SL00	203.65	RUGGERINI RD 201	18	17
FIN026SL00	203.65	RUGGERINI RD 208	18	19
FIN027RS00	8210.025	INTERMOTOR Benzina Petrol LA 250	14	29
FIN027RS00	8210.025	INTERMOTOR Benzina Petrol LAP 250	14	31
FIN027RS05	8210.026	INTERMOTOR Benzina Petrol LA 250	14	29
FIN027RS05	8210.026	INTERMOTOR Benzina Petrol LAP 250	14	31
FIN027RS10	8210.027	INTERMOTOR Benzina Petrol LA 250	14	29
FIN027RS10	8210.027	INTERMOTOR Benzina Petrol LAP 250	14	31
FIN027SL00	203.83	RUGGERINI MD 85.0	19	13
FIN027SL00	203.83	RUGGERINI MD 85.1	19	15
FIN027SL00	203.83	RUGGERINI MD 95.0	19	17
FIN027SL00	203.83	RUGGERINI MD 95.1	19	19
FIN027SL00	203.83	RUGGERINI MD 170	19	21
FIN027SL00	203.83	RUGGERINI MD 171	19	23
FIN027SL00	203.83	RUGGERINI MD 190	19	25
FIN027SL00	203.83	RUGGERINI MD 191	19	27
FIN028OP	A2417	RUGGERINI RF 90	17	12
FIN028OP	A2417	RUGGERINI RF 91	17	14
FIN028OP	A2417	RUGGERINI RF 120	17	18
FIN028OP	A2417	RUGGERINI RF 121	17	20
FIN028OP	A2417	RUGGERINI RF 140	17	24
FIN028OP	A2417	RUGGERINI RF 80	17	6
FIN028OP	A2417	RUGGERINI RF 81	17	8
FIN028RS00	8210.077	INTERMOTOR Benzina Petrol IM 300	14	11
FIN028RS00	8210.077	INTERMOTOR Benzina Petrol IM 302	14	13
FIN028RS00	8210.077	INTERMOTOR Benzina Petrol IM 302	14	15
FIN028RS00	8210.077	INTERMOTOR Benzina Petrol LA 300	14	33
FIN028RS00	8210.077	INTERMOTOR Benzina Petrol LAP 300	14	35
FIN028RS00	8210.077	INTERMOTOR Benzina Petrol IM 300	14	9
FIN028RS05	8210.078	INTERMOTOR Benzina Petrol IM 300	14	11
FIN028RS05	8210.078	INTERMOTOR Benzina Petrol IM 302	14	13
FIN028RS05	8210.078	INTERMOTOR Benzina Petrol IM 302	14	15
FIN028RS05	8210.078	INTERMOTOR Benzina Petrol LA 300	14	33
FIN028RS05	8210.078	INTERMOTOR Benzina Petrol LAP 300	14	35
FIN028RS05	8210.078	INTERMOTOR Benzina Petrol IM 300	14	9
FIN028RS10	8210.079	INTERMOTOR Benzina Petrol IM 300	14	11
FIN028RS10	8210.079	INTERMOTOR Benzina Petrol IM 302	14	13
FIN028RS10	8210.079	INTERMOTOR Benzina Petrol IM 302	14	15
FIN028RS10	8210.079	INTERMOTOR Benzina Petrol LA 300	14	33
FIN028RS10	8210.079	INTERMOTOR Benzina Petrol LAP 300	14	35
FIN028RS10	8210.079	INTERMOTOR Benzina Petrol IM 300	14	9
FIN028SL00	203.012	ACME AD 114	16	11
FIN028SL00	203.012	ACME AD 112	16	13
FIN028SL00	203.012	ACME ADN 54	16	37
FIN028SL00	203.012	ACME ADN 54	16	39
FIN028SL00	203.012	ACME ADN 54 W	16	41
FIN028SL00	203.12	RUGGERINI RF 120	17	17
FIN028SL00	203.12	RUGGERINI RF 121	17	19
FIN028SL00	203.12	RUGGERINI RD 900	18	21
FIN028SL00	203.12	RUGGERINI RD 901	18	23
FIN028SL00	203.12	RUGGERINI RD 901/AD	18	25
FIN028SL00	203.12	RUGGERINI RD 220	18	33
FIN028SL00	203.12	RUGGERINI RD 901/2	18	35

Ricambi non originali per motori. Denominazioni e codici originali, sono riportati a puro titolo di riferimento.

3 - A

rel. 1511

Non original engine parts. OEMs names and part numbers are for reference purpose only.

Tavole di corrispondenza

Cross references

Finimpianti	OEM	Costruttore-Motore <i>Manufacturer-Engine</i>	Cp.	Pg.
FIN029PC00	A2267	RUGGERINI MD 85.0	19	13
FIN029PC00	A2267	RUGGERINI MD 85.1	19	15
FIN029PC00	A2267	RUGGERINI MD 170	19	21
FIN029PC00	A2267	RUGGERINI MD 171	19	23
FIN029PC05		RUGGERINI MD 85.0	19	13
FIN029PC05		RUGGERINI MD 85.1	19	15
FIN029PC05		RUGGERINI MD 170	19	21
FIN029PC05		RUGGERINI MD 171	19	23
FIN029PC10		RUGGERINI MD 85.0	19	13
FIN029PC10		RUGGERINI MD 85.1	19	15
FIN029PC10		RUGGERINI MD 170	19	21
FIN029PC10		RUGGERINI MD 171	19	23
FIN029RS00	8210.099	INTERMOTOR IM 350, IM Benzina Petrol 352	14	53
FIN029RS05	8211.001	INTERMOTOR IM 350, IM Benzina Petrol 352	14	53
FIN029RS10	8211.002	INTERMOTOR IM 350, IM Benzina Petrol 352	14	53
FIN029SL00	203.71	RUGGERINI RF 90	17	11
FIN029SL00	203.71	RUGGERINI RF 91	17	13
FIN030CR STD	316.30	RUGGERINI CRD 951	21	1
FIN030CR STD	316.30	RUGGERINI P 101 L	21	11
FIN030CR STD	316.30	RUGGERINI P 101/2	21	13
FIN030CR STD	316.30	RUGGERINI P 101/2 L	21	15
FIN030CR STD	316.30	RUGGERINI P 105/2	21	17
FIN030CR STD	316.30	RUGGERINI P 105/2 R	21	19
FIN030CR STD	316.30	RUGGERINI P 105/2 L	21	21
FIN030CR STD	316.30	RUGGERINI RP 280	21	23
FIN030CR STD	316.30	RUGGERINI RP 170	21	25
FIN030CR STD	316.30	RUGGERINI RP 178	21	27
FIN030CR STD	316.30	RUGGERINI RP 320	21	29
FIN030CR STD	316.30	RUGGERINI CRD 951/2	21	3
FIN030CR STD	316.30	RUGGERINI RP 328	21	31
FIN030CR STD	316.30	RUGGERINI RP 360	21	33
FIN030CR STD	316.30	RUGGERINI RP 368	21	35
FIN030CR STD	316.30	RUGGERINI RP 380	21	37
FIN030CR STD	316.30	RUGGERINI RP 388	21	39
FIN030CR STD	316.30	RUGGERINI CRD 100	21	5
FIN030CR STD	316.30	RUGGERINI CRD 100/2	21	7
FIN030CR STD	316.30	RUGGERINI P 101	21	9
FIN030RS00	8211.197	INTERMOTOR IM 350 Benzina Petrol	14	17
FIN030RS00	8211.197	INTERMOTOR IM 350 Benzina Petrol	14	19
FIN030RS00	8211.197	INTERMOTOR IM 352 Benzina Petrol	14	21
FIN030RS00	8211.197	INTERMOTOR IM 352 Benzina Petrol	14	23
FIN030RS00	8211.197	INTERMOTOR IM 359 Benzina Petrol	14	25
FIN030RS00	8211.197	INTERMOTOR IM 359 Benzina Petrol	14	27
FIN030RS05	8211.198	INTERMOTOR IM 350 Benzina Petrol	14	17
FIN030RS05	8211.198	INTERMOTOR IM 350 Benzina Petrol	14	19
FIN030RS05	8211.198	INTERMOTOR IM 352 Benzina Petrol	14	21
FIN030RS05	8211.198	INTERMOTOR IM 352 Benzina Petrol	14	23
FIN030RS05	8211.198	INTERMOTOR IM 359 Benzina Petrol	14	25
FIN030RS05	8211.198	INTERMOTOR IM 359 Benzina Petrol	14	27
FIN030RS10	8211.199	INTERMOTOR IM 350 Benzina Petrol	14	17
FIN030RS10	8211.199	INTERMOTOR IM 350 Benzina Petrol	14	19
FIN030RS10	8211.199	INTERMOTOR IM 352 Benzina Petrol	14	21
FIN030RS10	8211.199	INTERMOTOR IM 352 Benzina Petrol	14	23
FIN030RS10	8211.199	INTERMOTOR IM 359 Benzina Petrol	14	25
FIN030RS10	8211.199	INTERMOTOR IM 359 Benzina Petrol	14	27
FIN030SL00	203.73	RUGGERINI RD 210	18	27
FIN030SL00	203.73	RUGGERINI RD 211	18	29
FIN030SL00	203.73	RUGGERINI RD 218	18	31
FIN031MB STD	310.31	RUGGERINI RD 200	18	15
FIN031MB STD	310.31	RUGGERINI RD 201	18	17
FIN031MB STD	310.31	RUGGERINI RD 208	18	19
FIN031MB STD	310.31	RUGGERINI RD 901/2	18	35
FIN031MB STD	310.31	RUGGERINI RD 92/2	18	45
FIN031MB STD	310.31	RUGGERINI RD 92/2 L	18	47
FIN031MB STD	310.31	RUGGERINI RD 180	18	5
FIN031MB STD	310.31	RUGGERINI RD 181	18	7
FIN031MB STD	310.31	RUGGERINI RD 188	18	9
FIN031MB STD	310.31	RUGGERINI MD 170	19	21
FIN031MB STD	310.31	RUGGERINI MD 171	19	23
FIN031MB STD	310.31	RUGGERINI MD 190	19	25
FIN031MB STD	310.31	RUGGERINI MD 191	19	27
FIN031MB STD	310.31	RUGGERINI MD 150	19	5
FIN031MB STD	310.31	RUGGERINI MD 151	19	7
FIN031MB STD	A2649	RUGGERINI RD 210	18	27

Finimpianti	OEM	Costruttore-Motore <i>Manufacturer-Engine</i>	Cp.	Pg.
FIN031MB STD	A2649	RUGGERINI RD 211	18	29
FIN031MB STD	A2649	RUGGERINI RD 218	18	31
FIN031MB STD	A2649	RUGGERINI RD 220	18	33
FIN031MB STD	A2649	RUGGERINI RD 240	18	41
FIN031MB STD	A2649	RUGGERINI RD 248	18	43
FIN031MB STD	A2649	RUGGERINI RD 270	18	53
FIN031MB STD	A2649	RUGGERINI RD 278	18	55
FIN031MB STD	A2649	RUGGERINI RD 952	18	57
FIN031SL00	203.013	ACME AD 116	16	15
FIN031SL00	203.13	RUGGERINI RF 130	17	21
FIN031SL00	203.13	RUGGERINI RD 920	18	37
FIN031SL00	203.13	RUGGERINI RD 920 L	18	39
FIN031SL00	203.13	RUGGERINI RD 240	18	41
FIN031SL00	203.13	RUGGERINI RD 248	18	43
FIN031SL00	203.13	RUGGERINI RD 92/2	18	45
FIN031SL00	203.13	RUGGERINI RD 92/2 L	18	47
FIN032PU	696.32	RUGGERINI RF 80	17	6
FIN032PU	696.32	RUGGERINI RF 81	17	8
FIN032PU	696.32	RUGGERINI RD 80	18	2
FIN032PU	696.32	RUGGERINI RD 81	18	4
FIN032SL00	20368	RUGGERINI RD 270	18	53
FIN032SL00	20368	RUGGERINI RD 278	18	55
FIN032SL00	20368	RUGGERINI RD 952	18	57
FIN033SL00	203.042	ACME ADN 60	16	43
FIN033SL00	203.042	ACME ADN 60	16	45
FIN033SL00	203.042	ACME ADN 60 W	16	47
FIN033SL00	203.42	RUGGERINI RF 140	17	23
FIN033SL00	203.42	RUGGERINI RF 148	17	25
FIN033SL00	203.42	RUGGERINI RD 950	18	49
FIN033SL00	203.42	RUGGERINI RD 950 L	18	51
FIN034SL00	203.11	RUGGERINI P 101 L	21	11
FIN034SL00	203.11	RUGGERINI P 101/2	21	13
FIN034SL00	203.11	RUGGERINI P 101/2 L	21	15
FIN034SL00	203.11	RUGGERINI RP 170	21	25
FIN034SL00	203.11	RUGGERINI RP 178	21	27
FIN034SL00	203.11	RUGGERINI RP 320	21	29
FIN034SL00	203.11	RUGGERINI RP 328	21	31
FIN034SL00	203.11	RUGGERINI CRD 100	21	5
FIN034SL00	203.11	RUGGERINI CRD 100/2	21	7
FIN034SL00	203.11	RUGGERINI P 101	21	9
FIN035PB	316.35	RUGGERINI CRD 951	21	1
FIN035PB	316.35	RUGGERINI P 101 L	21	11
FIN035PB	316.35	RUGGERINI P 101/2	21	13
FIN035PB	316.35	RUGGERINI P 101/2 L	21	15
FIN035PB	316.35	RUGGERINI P 105/2	21	17
FIN035PB	316.35	RUGGERINI P 105/2 R	21	19
FIN035PB	316.35	RUGGERINI P 105/2 L	21	21
FIN035PB	316.35	RUGGERINI RP 280	21	23
FIN035PB	316.35	RUGGERINI RP 170	21	25
FIN035PB	316.35	RUGGERINI RP 178	21	27
FIN035PB	316.35	RUGGERINI RP 320	21	29
FIN035PB	316.35	RUGGERINI CRD 951/2	21	3
FIN035PB	316.35	RUGGERINI RP 328	21	31
FIN035PB	316.35	RUGGERINI RP 360	21	33
FIN035PB	316.35	RUGGERINI RP 368	21	35
FIN035PB	316.35	RUGGERINI RP 380	21	37
FIN035PB	316.35	RUGGERINI RP 388	21	39
FIN035PB	316.35	RUGGERINI CRD 100	21	5
FIN035PB	316.35	RUGGERINI CRD 100/2	21	7
FIN035PB	316.35	RUGGERINI P 101	21	9
FIN035SL00	203.47	RUGGERINI P 105/2	21	17
FIN035SL00	203.47	RUGGERINI P 105/2 R	21	19
FIN035SL00	203.47	RUGGERINI P 105/2 L	21	21
FIN035SL00	203.47	RUGGERINI RP 360	21	33
FIN035SL00	203.47	RUGGERINI RP 368	21	35
FIN035SL00	203.47	RUGGERINI RP 380	21	37
FIN035SL00	203.47	RUGGERINI RP 388	21	39
FIN036CR STD	316.036	ACME AD 114	16	11
FIN036CR STD	316.036	ACME AD 112	16	13
FIN036CR STD	316.036	ACME AD 116	16	15
FIN036CR STD	316.036	ACME ADN 45	16	25
FIN036CR STD	316.036	ACME ADN 48	16	31
FIN036CR STD	316.036	ACME ADN 54	16	37
FIN036CR STD	316.036	ACME ADN 60	16	43
FIN036CR STD	316.036	ACME AD 108	16	5
FIN036CR STD	316.036	ACME AD 110	16	7
FIN036CR STD	316.036	ACME AD 114 / A	16	9
FIN036CR STD	316.36	RUGGERINI RF 100	17	15
FIN036CR STD	316.36	RUGGERINI RF 130	17	21
FIN036CR STD	316.36	RUGGERINI RF 148	17	25
FIN036CR STD	316.36	RUGGERINI RD 850	18	11
FIN036CR STD	316.36	RUGGERINI RD 901/A	18	13
FIN036CR STD	316.36	RUGGERINI RD 208	18	19
FIN036CR STD	316.36	RUGGERINI RD 900	18	21
FIN036CR STD	316.36	RUGGERINI RD 901	18	23
FIN036CR STD	316.36	RUGGERINI RD 901/AD	18	25
FIN036CR STD	316.36	RUGGERINI RD 901/2	18	35
FIN036CR STD	316.36	RUGGERINI RD 920	18	37
FIN036CR STD	316.36	RUGGERINI RD 920 L	18	39
FIN036CR STD	316.36	RUGGERINI RD 248	18	43
FIN036CR STD	316.36	RUGGERINI RD 92/2	18	45
FIN036CR STD	316.36	RUGGERINI RD 92/2 L	18	47
FIN036CR STD	316.36	RUGGERINI RD 950	18	49
FIN036CR STD	316.36	RUGGERINI RD 180	18	5

Ricambi non originali per motori. Denominazioni e codici originali, sono riportati a puro titolo di riferimento.

4 - A

rel. 1511

Non original engine parts. OEMs names and part numbers are for reference purpose only.

Tavole di corrispondenza

Cross references

Finimpianti	OEM	Costruttore-Motore <i>Manufacturer-Engine</i>	Cp.	Pg.
FIN036CR STD	316.36	RUGGERINI RD 950 L	18	51
FIN036CR STD	316.36	RUGGERINI RD 952	18	57
FIN036CR STD	316.36	RUGGERINI RD 181	18	7
FIN036CR STD	316.36	RUGGERINI RD 188	18	9
FIN037OP	0066050370	RUGGERINI RD 290	18	60
FIN038PU	696.119	ACME ADN 37	16	18
FIN038PU	696.119	ACME ADN 37 W	16	20
FIN038PU	696.119	ACME ADN 43	16	22
FIN038PU	696.119	ACME ADN 43 W	16	24
FIN038PU	696.78	RUGGERINI RF 88	17	10
FIN038PU	696.78	RUGGERINI RF 90	17	12
FIN038PU	696.78	RUGGERINI RF 91	17	14
FIN038PU	696.78	RUGGERINI MC 70	17	2
FIN038PU	696.78	RUGGERINI MC 71	17	4
FIN038PU	696.78	RUGGERINI RD 248	18	44
FIN038PU	696.78	RUGGERINI MD 85.0	19	14
FIN038PU	696.78	RUGGERINI MD 85.1	19	16
FIN038PU	696.78	RUGGERINI MD 95.0	19	18
FIN038PU	696.78	RUGGERINI MD 75.0	19	2
FIN038PU	696.78	RUGGERINI MD 95.1	19	20
FIN038PU	696.78	RUGGERINI MD 75.1	19	4
FIN038PU	696.78	RUGGERINI MD 150	19	6
FIN038PU	696.78	RUGGERINI MD 151	19	8
FIN043CR STD	316.043	ACME ADN 37	16	17
FIN043CR STD	A2628	RUGGERINI RY 120	20	19
FIN043CR STD	A2628	RUGGERINI RY 121	20	21
FIN043CR STD	A2628	RUGGERINI RY 125	20	23
FIN043CR STD	A2639	RUGGERINI MC 70	17	1
FIN043CR STD	A2639	RUGGERINI RF 90	17	11
FIN043CR STD	A2639	RUGGERINI RF 91	17	13
FIN043CR STD	A2639	RUGGERINI MC 71	17	3
FIN043CR STD	A2639	RUGGERINI RF 80	17	5
FIN043CR STD	A2639	RUGGERINI RF 81	17	7
FIN043CR STD	A2639	RUGGERINI RF 88	17	9
FIN043CR STD	A2639	RUGGERINI RD 80	18	1
FIN043CR STD	A2639	RUGGERINI RD 81	18	3
FIN044RS00	8210.028	INTERMOTOR <i>Benzina Petrol</i> LA 490	14	37
FIN044RS00	8210.028	INTERMOTOR <i>Benzina Petrol</i> LAP 490	14	39
FIN044RS05	8210.029	INTERMOTOR <i>Benzina Petrol</i> LA 490	14	37
FIN044RS05	8210.029	INTERMOTOR <i>Benzina Petrol</i> LAP 490	14	39
FIN044RS10	8210.030	INTERMOTOR <i>Benzina Petrol</i> LA 490	14	37
FIN044RS10	8210.030	INTERMOTOR <i>Benzina Petrol</i> LAP 490	14	39
FIN045SO	0046010450	RUGGERINI SP 420	18	62
FIN047SI	0054610470	RUGGERINI RD 290	18	60
FIN049CGA		INTERMOTOR IM 300	14	10
FIN049CGA		INTERMOTOR IM 300	14	12
FIN049CGA		INTERMOTOR IM 302	14	14
FIN049CGA		INTERMOTOR IM 302	14	16
FIN049CGB	8180.187	INTERMOTOR IM 300	14	10
FIN049CGB	8180.187	INTERMOTOR IM 300	14	12
FIN049CGB	8180.187	INTERMOTOR IM 302	14	14
FIN049CGB	8180.187	INTERMOTOR IM 302	14	16
FIN050NO	644.66	RUGGERINI MD 300	19	10
FIN050NO	644.66	RUGGERINI MD 301	19	12
FIN050NO	644.66	RUGGERINI MD 85.0	19	14
FIN050NO	644.66	RUGGERINI MD 85.1	19	16
FIN050NO	644.66	RUGGERINI MD 95.0	19	18
FIN050NO	644.66	RUGGERINI MD 75.0	19	2
FIN050NO	644.66	RUGGERINI MD 95.1	19	20
FIN050NO	644.66	RUGGERINI MD 190	19	26
FIN050NO	644.66	RUGGERINI MD 191	19	28
FIN050NO	644.66	RUGGERINI MD 350	19	30
FIN050NO	644.66	RUGGERINI MD 351	19	32
FIN050NO	644.66	RUGGERINI MD 75.1	19	4
FIN050NO	644.66	RUGGERINI MD 150	19	6
FIN050NO	644.66	RUGGERINI MD 151	19	8
FIN051NO	644.28	RUGGERINI RD 188	18	10
FIN051NO	644.28	RUGGERINI RD 200	18	16
FIN051NO	644.28	RUGGERINI RD 201	18	18
FIN051NO	644.28	RUGGERINI RD 208	18	20
FIN051NO	644.28	RUGGERINI RD 210	18	28
FIN051NO	644.28	RUGGERINI RD 211	18	30
FIN051NO	644.28	RUGGERINI RD 218	18	32
FIN051NO	644.28	RUGGERINI RD 180	18	6
FIN051NO	644.28	RUGGERINI RD 181	18	8
FIN051NO	644.37	RUGGERINI RF 88	17	10
FIN051NO	644.37	RUGGERINI RF 90	17	12
FIN051NO	644.37	RUGGERINI RF 91	17	14
FIN051NO	644.37	RUGGERINI RF 120	17	18
FIN051NO	644.37	RUGGERINI RF 121	17	20
FIN051NO	644.37	RUGGERINI RF 130	17	22
FIN051NO	644.37	RUGGERINI RF 140	17	24
FIN051NO	644.37	RUGGERINI RF 80	17	6
FIN051NO	644.37	RUGGERINI RF 81	17	8
FIN051NO	644.52	RUGGERINI MC 70	17	2
FIN051NO	644.52	RUGGERINI RF 148	17	26
FIN051NO	644.52	RUGGERINI MC 71	17	4
FIN051RS00	0082112090	RUGGERINI RD 290	18	59

Finimpianti	OEM	Costruttore-Motore <i>Manufacturer-Engine</i>	Cp.	Pg.
FIN051RS00	0082112090	RUGGERINI SP 420	18	61
FIN051RS05	0082112100	RUGGERINI RD 290	18	59
FIN051RS05	0082112100	RUGGERINI SP 420	18	61
FIN051RS10	0082112110	RUGGERINI RD 290	18	59
FIN051RS10	0082112110	RUGGERINI SP 420	18	61
FIN052PU	696.54	RUGGERINI RF 100	17	16
FIN052PU	696.54	RUGGERINI RF 120	17	18
FIN052PU	696.54	RUGGERINI RF 121	17	20
FIN052PU	696.54	RUGGERINI RF 130	17	22
FIN052PU	696.54	RUGGERINI RF 140	17	24
FIN052PU	696.54	RUGGERINI RF 148	17	26
FIN052PU	696.54	RUGGERINI RD 850	18	12
FIN052PU	696.54	RUGGERINI RD 901/A	18	14
FIN052PU	696.54	RUGGERINI RD 900	18	22
FIN052PU	696.54	RUGGERINI RD 901	18	24
FIN052PU	696.54	RUGGERINI RD 920	18	38
FIN052PU	696.54	RUGGERINI RD 920 L	18	40
FIN052PU	696.54	RUGGERINI RD 950	18	50
FIN052PU	696.54	RUGGERINI RD 950 L	18	52
FIN053CFA	359.138	ACME ADN 37 W	16	20
FIN053CFA	359.138	ACME ADN 43	16	22
FIN053CFA	359.138	ACME ADN 43 W	16	24
FIN053CFA	359.138	ACME ADN 45	16	28
FIN053CFA	359.138	ACME ADN 45 W	16	30
FIN053CFA	359.138	ACME ADN 48	16	34
FIN053CFA	359.138	ACME ADN 48 W	16	36
FIN053CFA	359.138	ACME ADN 54	16	40
FIN053CFA	359.138	ACME ADN 54 W	16	42
FIN053CFA	359.138	ACME ADN 60	16	46
FIN053CFA	359.138	ACME ADN 60 W	16	48
FIN057CR STD	316.57	RUGGERINI MD 85.0	19	13
FIN057CR STD	316.57	RUGGERINI MD 85.1	19	15
FIN057CR STD	A2637	RUGGERINI MD 75.0	19	1
FIN057CR STD	A2637	RUGGERINI MD 95.0	19	17
FIN057CR STD	A2637	RUGGERINI MD 95.1	19	19
FIN057CR STD	A2637	RUGGERINI MD 170	19	21
FIN057CR STD	A2637	RUGGERINI MD 171	19	23
FIN057CR STD	A2637	RUGGERINI MD 190	19	25
FIN057CR STD	A2637	RUGGERINI MD 191	19	27
FIN057CR STD	A2637	RUGGERINI MD 75.1	19	3
FIN057CR STD	A2637	RUGGERINI MD 150	19	5
FIN057CR STD	A2637	RUGGERINI MD 151	19	7
FIN057CR STD	A2637	RUGGERINI RY 100	20	13
FIN057CR STD	A2637	RUGGERINI RY 101	20	15
FIN057CR STD	A2637	RUGGERINI RY 85.0	20	5
FIN057CR STD	A2637	RUGGERINI RY 85.1	20	7
FIN057OP	4336.049	SLANZI DVA 1550	15	12
FIN057OP	4336.049	SLANZI DVA 1550 S	15	14
FIN057OP	4336.049	SLANZI DVA 1750	15	22
FIN057OP	4336.049	SLANZI DVA 1750 S	15	24
FIN059CR STD	0016400590	RUGGERINI RD 290	18	59
FIN059CR STD	0016400590	RUGGERINI SP 420	18	61
FIN059E	660.16	RUGGERINI RD 188	18	10
FIN059E	660.16	RUGGERINI RD 200	18	16
FIN059E	660.16	RUGGERINI RD 201	18	18
FIN059E	660.16	RUGGERINI RD 208	18	20
FIN059E	660.16	RUGGERINI RD 210	18	28
FIN059E	660.16	RUGGERINI RD 211	18	30
FIN059E	660.16	RUGGERINI RD 218	18	32
FIN059E	660.16	RUGGERINI RD 180	18	6
FIN059E	660.16	RUGGERINI RD 181	18	8
FIN059E	660.20	RUGGERINI RF 88	17	10
FIN059E	660.20	RUGGERINI RF 90	17	12
FIN059E	660.20	RUGGERINI RF 91	17	14
FIN059E	660.20	RUGGERINI MC 70	17	2
FIN059E	660.20	RUGGERINI MC 71	17	4
FIN059E	660.20	RUGGERINI RF 80	17	6
FIN059E	660.20	RUGGERINI RF 81	17	8
FIN059JP	0065900590	RUGGERINI SP 420	18	62
FIN059RS00	0082112270	RUGGERINI RY 70	20	3
FIN059RS05	0082112280	RUGGERINI RY 70	20	3
FIN059RS10	0082112290	RUGGERINI RY 70	20	3
FIN062CS STD	0016000620	RUGGERINI SP 420	18	61
FIN066FP	0065850950	RUGGERINI RY 75	20	10
FIN067RS00	2340	ACME ADN 37	16	17
FIN067RS00	2340	ACME ADN 37 W	16	19
FIN067RS00	2340	RUGGERINI MC 70	17	1
FIN067RS00	2340	RUGGERINI MC 71	17	3
FIN067RS00	2340	RUGGERINI RF 80	17	5
FIN067RS00	2340	RUGGERINI RF 81	17	7
FIN067RS00	2340	RUGGERINI RF 88	17	9
FIN067RS00	2340	RUGGERINI RD 80	18	1
FIN067RS00	2340	RUGGERINI RD 81	18	3
FIN067RS00	2340	RUGGERINI RD 180	18	5
FIN067RS00	2340	RUGGERINI RD 181	18	7
FIN067RS00	2340	RUGGERINI RD 188	18	9
FIN067RS00	A2285	RUGGERINI MD 301	19	11
FIN067RS00	A2285	RUGGERINI MD 300	19	9
FIN067RS05	2341	ACME ADN 37	16	17
FIN067RS05	2341	ACME ADN 37 W	16	19
FIN067RS05	2341	RUGGERINI MC 70	17	1
FIN067RS05	2341	RUGGERINI MC 71	17	3
FIN067RS05	2341	RUGGERINI RF 80	17	5
FIN067RS05	2341	RUGGERINI RF 81	17	7

Ricambi non originali per motori. Denominazioni e codici originali, sono riportati a puro titolo di riferimento.

Tavole di corrispondenza

Cross references

Finimpianti	OEM	Costruttore-Motore <i>Manufacturer-Engine</i>	Cp.	Pg.
FIN067RS05	2341	RUGGERINI RF 88	17	9
FIN067RS05	2341	RUGGERINI RD 80	18	1
FIN067RS05	2341	RUGGERINI RD 81	18	3
FIN067RS05	2341	RUGGERINI RD 180	18	5
FIN067RS05	2341	RUGGERINI RD 181	18	7
FIN067RS05	2341	RUGGERINI RD 188	18	9
FIN067RS05	2341	RUGGERINI MD 300	19	11
FIN067RS05	2341	RUGGERINI MD 300	19	9
FIN067RS10	2342	ACME ADN 37	16	17
FIN067RS10	2342	ACME ADN 37 W	16	19
FIN067RS10	2342	RUGGERINI MC 70	17	1
FIN067RS10	2342	RUGGERINI MC 71	17	3
FIN067RS10	2342	RUGGERINI RF 80	17	5
FIN067RS10	2342	RUGGERINI RF 81	17	7
FIN067RS10	2342	RUGGERINI RF 88	17	9
FIN067RS10	2342	RUGGERINI RD 80	18	1
FIN067RS10	2342	RUGGERINI RD 81	18	3
FIN067RS10	2342	RUGGERINI RD 180	18	5
FIN067RS10	2342	RUGGERINI RD 181	18	7
FIN067RS10	2342	RUGGERINI RD 188	18	9
FIN067RS10	2342	RUGGERINI MD 301	19	11
FIN067RS10	2342	RUGGERINI MD 300	19	9
FIN068E	6578.159	SLANZI DVA 1800	15	34
FIN068E	6578.159	SLANZI DVA 2700	15	36
FIN068E	6578.159	SLANZI DVA 3600	15	38
FIN068E	6578.159	SLANZI DS 2000	15	40
FIN068E	6578.159	SLANZI DS 3000	15	42
FIN068E	6578.159	SLANZI DS 4000	15	44
FIN068E	660.06	RUGGERINI RD 920 L	18	40
FIN068E	660.06	RUGGERINI RD 92/2 L	18	48
FIN068E	660.06	RUGGERINI RD 950 L	18	52
FIN068RS00	A2132	RUGGERINI MD 75.0	19	1
FIN068RS00	A2132	RUGGERINI MD 75.1	19	3
FIN068RS00	A2132	RUGGERINI MD 150	19	5
FIN068RS00	A2132	RUGGERINI MD 151	19	7
FIN068RS00	A2132	RUGGERINI RY 85.0	20	5
FIN068RS00	A2132	RUGGERINI RY 85.1	20	7
FIN068RS05		RUGGERINI MD 75.0	19	1
FIN068RS05		RUGGERINI MD 75.1	19	3
FIN068RS05		RUGGERINI MD 150	19	5
FIN068RS05		RUGGERINI MD 151	19	7
FIN068RS05		RUGGERINI RY 85.0	20	5
FIN068RS10		RUGGERINI MD 75.1	19	3
FIN068RS10		RUGGERINI MD 150	19	5
FIN068RS10		RUGGERINI MD 151	19	7
FIN068RS10		RUGGERINI RY 85.0	20	5
FIN068RS10		RUGGERINI RY 85.1	20	7
FIN069E	660.008	ACME ADN 37	16	18
FIN069RS00	2135	ACME ADN 48	16	31
FIN069RS00	2135	ACME AD 108	16	5
FIN069RS00	2135	ACME AD 110	16	7
FIN069RS00	2135	ACME AD 114 / A	16	9
FIN069RS00	2135	RUGGERINI RF 100	17	15
FIN069RS00	2135	RUGGERINI RD 850	18	11
FIN069RS00	2135	RUGGERINI RD 901/A	18	13
FIN069RS05	2136	ACME ADN 48	16	31
FIN069RS05	2136	ACME AD 108	16	5
FIN069RS05	2136	ACME AD 110	16	7
FIN069RS05	2136	ACME AD 114 / A	16	9
FIN069RS05	2136	RUGGERINI RF 100	17	15
FIN069RS05	2136	RUGGERINI RD 850	18	11
FIN069RS05	2136	RUGGERINI RD 901/A	18	13
FIN069RS10	2137	ACME ADN 48	16	31
FIN069RS10	2137	ACME AD 108	16	5
FIN069RS10	2137	ACME AD 110	16	7
FIN069RS10	2137	ACME AD 114 / A	16	9
FIN069RS10	2137	RUGGERINI RF 100	17	15
FIN069RS10	2137	RUGGERINI RD 850	18	11
FIN069RS10	2137	RUGGERINI RD 901/A	18	13
FIN070CFA	5496.110	INTERMOTOR LA 490	14	38
FIN070CFA	5496.110	INTERMOTOR LAP 490	14	40
FIN070RS00	A2052	RUGGERINI RD 208	18	19
FIN070RS00	A2052	RUGGERINI MD 85.0	19	13
FIN070RS00	A2052	RUGGERINI MD 85.1	19	15
FIN070RS00	A2052	RUGGERINI MD 95.0	19	17
FIN070RS00	A2052	RUGGERINI MD 95.1	19	19
FIN070RS00	A2052	RUGGERINI MD 170	19	21
FIN070RS00	A2052	RUGGERINI MD 171	19	23
FIN070RS00	A2052	RUGGERINI MD 190	19	25
FIN070RS00	A2052	RUGGERINI MD 191	19	27
FIN070RS00	A2052	RUGGERINI MD 350	19	29
FIN070RS00	A2052	RUGGERINI MD 351	19	31
FIN070RS00	A2277	RUGGERINI RD 200	18	15
FIN070RS00	A2277	RUGGERINI RD 201	18	17
FIN070RS05	2992	RUGGERINI RD 200	18	15
FIN070RS05	2992	RUGGERINI RD 201	18	17
FIN070RS05	2992	RUGGERINI RD 208	18	19
FIN070RS05	2992	RUGGERINI MD 85.0	19	13
FIN070RS05	2992	RUGGERINI MD 85.1	19	15
FIN070RS05	2992	RUGGERINI MD 95.0	19	17
FIN070RS05	2992	RUGGERINI MD 95.1	19	19
FIN070RS05	2992	RUGGERINI MD 170	19	21

Finimpianti	OEM	Costruttore-Motore <i>Manufacturer-Engine</i>	Cp.	Pg.
FIN070RS05	2992	RUGGERINI MD 171	19	23
FIN070RS05	2992	RUGGERINI MD 190	19	25
FIN070RS05	2992	RUGGERINI MD 191	19	27
FIN070RS05	2992	RUGGERINI MD 350	19	29
FIN070RS05	2992	RUGGERINI MD 351	19	31
FIN070RS10	2993	RUGGERINI RD 200	18	15
FIN070RS10	2993	RUGGERINI RD 201	18	17
FIN070RS10	2993	RUGGERINI RD 208	18	19
FIN070RS10	2993	RUGGERINI MD 85.0	19	13
FIN070RS10	2993	RUGGERINI MD 85.1	19	15
FIN070RS10	2993	RUGGERINI MD 95.0	19	17
FIN070RS10	2993	RUGGERINI MD 95.1	19	19
FIN070RS10	2993	RUGGERINI MD 170	19	21
FIN070RS10	2993	RUGGERINI MD 171	19	23
FIN070RS10	2993	RUGGERINI MD 190	19	25
FIN070RS10	2993	RUGGERINI MD 191	19	27
FIN070RS10	2993	RUGGERINI MD 350	19	29
FIN070RS10	2993	RUGGERINI MD 351	19	31
FIN071NF	0054960710	RUGGERINI RY 75	20	10
FIN071NF	0054960710	RUGGERINI RY 103	20	12
FIN071NF	0054960710	RUGGERINI RY 110	20	18
FIN071NF	0054963420	RUGGERINI RY 50	20	2
FIN071NF	0054963420	RUGGERINI RY 70	20	4
FIN071RS00	2149	ACME AD 114	16	11
FIN071RS00	2149	ACME AD 112	16	13
FIN071RS00	2149	ACME ADN 54	16	37
FIN071RS00	2149	RUGGERINI RD 900	18	21
FIN071RS00	2149	RUGGERINI RD 901/2	18	35
FIN071RS05	2150	ACME AD 114	16	11
FIN071RS05	2150	ACME AD 112	16	13
FIN071RS05	2150	ACME ADN 54	16	37
FIN071RS05	2150	RUGGERINI RD 900	18	21
FIN071RS05	2150	RUGGERINI RD 901/2	18	35
FIN071RS10	2151	ACME AD 114	16	11
FIN071RS10	2151	ACME AD 112	16	13
FIN071RS10	2151	ACME ADN 54	16	37
FIN071RS10	2151	RUGGERINI RD 900	18	21
FIN071RS10	2151	RUGGERINI RD 901/2	18	35
FIN072RS00	A2157	RUGGERINI RF 90	17	11
FIN072RS00	A2157	RUGGERINI RF 91	17	13
FIN072RS00	A2157	RUGGERINI RF 120	17	17
FIN072RS00	A2157	RUGGERINI RF 121	17	19
FIN072RS00	A2157	RUGGERINI RD 901	18	23
FIN072RS00	A2157	RUGGERINI RD 901/AD	18	25
FIN072RS00	A2157	RUGGERINI RD 210	18	27
FIN072RS00	A2157	RUGGERINI RD 211	18	29
FIN072RS00	A2157	RUGGERINI RD 218	18	31
FIN072RS00	A2157	RUGGERINI RD 220	18	33
FIN072RS05	A2158	RUGGERINI RF 90	17	11
FIN072RS05	A2158	RUGGERINI RF 91	17	13
FIN072RS05	A2158	RUGGERINI RF 120	17	17
FIN072RS05	A2158	RUGGERINI RF 121	17	19
FIN072RS05	A2158	RUGGERINI RD 901	18	23
FIN072RS05	A2158	RUGGERINI RD 901/AD	18	25
FIN072RS05	A2158	RUGGERINI RD 210	18	27
FIN072RS05	A2158	RUGGERINI RD 211	18	29
FIN072RS05	A2158	RUGGERINI RD 218	18	31
FIN072RS05	A2158	RUGGERINI RD 220	18	33
FIN072RS10	A2159	RUGGERINI RF 90	17	11
FIN072RS10	A2159	RUGGERINI RF 91	17	13
FIN072RS10	A2159	RUGGERINI RF 120	17	17
FIN072RS10	A2159	RUGGERINI RF 121	17	19
FIN072RS10	A2159	RUGGERINI RD 901	18	23
FIN072RS10	A2159	RUGGERINI RD 901/AD	18	25
FIN072RS10	A2159	RUGGERINI RD 210	18	27
FIN072RS10	A2159	RUGGERINI RD 211	18	29
FIN072RS10	A2159	RUGGERINI RD 218	18	31
FIN072RS10	A2159	RUGGERINI RD 220	18	33
FIN074E	660.003	ACME AD 114 / A	16	10
FIN074E	660.003	ACME AD 114	16	12
FIN074E	660.003	ACME AD 112	16	14
FIN074E	660.003	ACME AD 116	16	16
FIN074E	660.003	ACME ADN 45	16	26
FIN074E	660.003	ACME ADN 48	16	32
FIN074E	660.003	ACME ADN 54	16	38
FIN074E	660.003	ACME ADN 60	16	44
FIN074E	660.003	ACME AD 108	16	6
FIN074E	660.003	ACME AD 110	16	8
FIN074E	660.07	RUGGERINI RD 850	18	12
FIN074E	660.07	RUGGERINI RD 901/A	18	14
FIN074E	660.07	RUGGERINI RD 900	18	22
FIN074E	660.07	RUGGERINI RD 901	18	24
FIN074E	660.07	RUGGERINI RD 901/AD	18	26
FIN074E	660.07	RUGGERINI RD 920	18	38
FIN074E	660.07	RUGGERINI RD 950	18	50
FIN074NF	0054960740	RUGGERINI RD 290	18	60
FIN074NF	0054960740	RUGGERINI SP 420	18	62
FIN074RS00	2274	RUGGERINI RF 130	17	21
FIN074RS00	2274	RUGGERINI RD 920	18	37
FIN074RS00	2274	RUGGERINI RD 920 L	18	39
FIN074RS00	2274	RUGGERINI RD 240	18	41
FIN074RS00	2274	RUGGERINI RD 248	18	43
FIN074RS00	2274	RUGGERINI RD 92/2	18	45
FIN074RS00	2274	RUGGERINI RD 92/2 L	18	47

Ricambi non originali per motori. Denominazioni e codici originali, sono riportati a puro titolo di riferimento.

Non original engine parts. OEMs names and part numbers are for reference purpose only.

Tavole di corrispondenza

Cross references

Finimpianti	OEM	Costruttore-Motore Manufacturer-Engine	Cp.	Pg.
FIN074RS05	2275	RUGGERINI RF 130	17	21
FIN074RS05	2275	RUGGERINI RD 920	18	37
FIN074RS05	2275	RUGGERINI RD 920 L	18	39
FIN074RS05	2275	RUGGERINI RD 240	18	41
FIN074RS05	2275	RUGGERINI RD 248	18	43
FIN074RS05	2275	RUGGERINI RD 92/2	18	45
FIN074RS05	2275	RUGGERINI RD 92/2 L	18	47
FIN074RS10	2276	RUGGERINI RF 130	17	21
FIN074RS10	2276	RUGGERINI RD 920	18	37
FIN074RS10	2276	RUGGERINI RD 920 L	18	39
FIN074RS10	2276	RUGGERINI RD 240	18	41
FIN074RS10	2276	RUGGERINI RD 248	18	43
FIN074RS10	2276	RUGGERINI RD 92/2	18	45
FIN074RS10	2276	RUGGERINI RD 92/2 L	18	47
FIN075RS00	2175	RUGGERINI CRD 951	21	1
FIN075RS00	2175	RUGGERINI RP 280	21	23
FIN075RS00	2175	RUGGERINI CRD 951/2	21	3
FIN075RS05	2176	RUGGERINI CRD 951	21	1
FIN075RS05	2176	RUGGERINI RP 280	21	23
FIN075RS05	2176	RUGGERINI CRD 951/2	21	3
FIN075RS10	2177	RUGGERINI CRD 951	21	1
FIN075RS10	2177	RUGGERINI RP 280	21	23
FIN075RS10	2177	RUGGERINI CRD 951/2	21	3
FIN076CO	0046010410	RUGGERINI RD 290	18	60
FIN076MB STD	0016110820	RUGGERINI SP 420	18	61
FIN076RS00	2461	ACME ADN 60	16	43
FIN076RS00	2495	RUGGERINI RF 140	17	23
FIN076RS00	2495	RUGGERINI RF 148	17	25
FIN076RS00	2495	RUGGERINI RD 950	18	49
FIN076RS00	2495	RUGGERINI RD 950 L	18	51
FIN076RS00	2495	RUGGERINI RD 270	18	53
FIN076RS00	2495	RUGGERINI RD 278	18	55
FIN076RS00	2495	RUGGERINI RD 952	18	57
FIN076RS05	2462	ACME ADN 60	16	43
FIN076RS05	2496	RUGGERINI RF 140	17	23
FIN076RS05	2496	RUGGERINI RF 148	17	25
FIN076RS05	2496	RUGGERINI RD 950	18	49
FIN076RS05	2496	RUGGERINI RD 950 L	18	51
FIN076RS05	2496	RUGGERINI RD 270	18	53
FIN076RS05	2496	RUGGERINI RD 278	18	55
FIN076RS05	2496	RUGGERINI RD 952	18	57
FIN076RS10	2463	ACME ADN 60	16	43
FIN076RS10	2497	RUGGERINI RF 140	17	23
FIN076RS10	2497	RUGGERINI RF 148	17	25
FIN076RS10	2497	RUGGERINI RD 950	18	49
FIN076RS10	2497	RUGGERINI RD 950 L	18	51
FIN076RS10	2497	RUGGERINI RD 270	18	53
FIN076RS10	2497	RUGGERINI RD 278	18	55
FIN076RS10	2497	RUGGERINI RD 952	18	57
FIN077MB STD	310.77	RUGGERINI MD 75.0	19	1
FIN077MB STD	310.77	RUGGERINI MD 85.0	19	13
FIN077MB STD	310.77	RUGGERINI MD 85.1	19	15
FIN077MB STD	310.77	RUGGERINI MD 95.0	19	17
FIN077MB STD	310.77	RUGGERINI MD 95.1	19	19
FIN077MB STD	310.77	RUGGERINI MD 170	19	21
FIN077MB STD	310.77	RUGGERINI MD 171	19	23
FIN077MB STD	310.77	RUGGERINI MD 190	19	25
FIN077MB STD	310.77	RUGGERINI MD 191	19	27
FIN077MB STD	310.77	RUGGERINI MD 75.1	19	3
FIN077MB STD	310.77	RUGGERINI MD 150	19	5
FIN077MB STD	310.77	RUGGERINI MD 151	19	7
FIN077RS00	2188	RUGGERINI P 101 L	21	11
FIN077RS00	2188	RUGGERINI P 101/2	21	13
FIN077RS00	2188	RUGGERINI P 101/2 L	21	15
FIN077RS00	2188	RUGGERINI RP 170	21	25
FIN077RS00	2188	RUGGERINI RP 178	21	27
FIN077RS00	2188	RUGGERINI RP 320	21	29
FIN077RS00	2188	RUGGERINI RP 328	21	31
FIN077RS00	2188	RUGGERINI CRD 100	21	5
FIN077RS00	2188	RUGGERINI CRD 100/2	21	7
FIN077RS00	2188	RUGGERINI P 101	21	9
FIN077RS05	2189	RUGGERINI P 101 L	21	11
FIN077RS05	2189	RUGGERINI P 101/2	21	13
FIN077RS05	2189	RUGGERINI P 101/2 L	21	15
FIN077RS05	2189	RUGGERINI RP 170	21	25
FIN077RS05	2189	RUGGERINI RP 178	21	27
FIN077RS05	2189	RUGGERINI RP 320	21	29
FIN077RS05	2189	RUGGERINI RP 328	21	31
FIN077RS05	2189	RUGGERINI CRD 100	21	5
FIN077RS05	2189	RUGGERINI CRD 100/2	21	7
FIN077RS05	2189	RUGGERINI P 101	21	9
FIN077RS10	2190	RUGGERINI P 101 L	21	11
FIN077RS10	2190	RUGGERINI P 101/2	21	13
FIN077RS10	2190	RUGGERINI P 101/2 L	21	15
FIN077RS10	2190	RUGGERINI RP 170	21	25
FIN077RS10	2190	RUGGERINI RP 178	21	27
FIN077RS10	2190	RUGGERINI RP 320	21	29
FIN077RS10	2190	RUGGERINI RP 328	21	31
FIN077RS10	2190	RUGGERINI CRD 100	21	5
FIN077RS10	2190	RUGGERINI CRD 100/2	21	7
FIN077RS10	2190	RUGGERINI P 101	21	9
FIN078CGA		RUGGERINI SP 420	18	62
FIN078CGB	0082051010	RUGGERINI SP 420	18	62
FIN078RS00	2351	RUGGERINI P 105/2	21	17

Finimpianti	OEM	Costruttore-Motore Manufacturer-Engine	Cp.	Pg.
FIN078RS00	2351	RUGGERINI P 105/2 R	21	19
FIN078RS00	2351	RUGGERINI P 105/2 L	21	21
FIN078RS00	2351	RUGGERINI RP 360	21	33
FIN078RS00	2351	RUGGERINI RP 368	21	35
FIN078RS00	2351	RUGGERINI RP 380	21	37
FIN078RS00	2351	RUGGERINI RP 388	21	39
FIN078RS05	2352	RUGGERINI P 105/2	21	17
FIN078RS05	2352	RUGGERINI P 105/2 R	21	19
FIN078RS05	2352	RUGGERINI P 105/2 L	21	21
FIN078RS05	2352	RUGGERINI RP 360	21	33
FIN078RS05	2352	RUGGERINI RP 368	21	35
FIN078RS05	2352	RUGGERINI RP 380	21	37
FIN078RS05	2352	RUGGERINI RP 388	21	39
FIN078RS10	2353	RUGGERINI P 105/2	21	17
FIN078RS10	2353	RUGGERINI P 105/2 R	21	19
FIN078RS10	2353	RUGGERINI P 105/2 L	21	21
FIN078RS10	2353	RUGGERINI RP 360	21	33
FIN078RS10	2353	RUGGERINI RP 368	21	35
FIN078RS10	2353	RUGGERINI RP 380	21	37
FIN078RS10	2353	RUGGERINI RP 388	21	39
FIN079SM	2856	RUGGERINI RF 88	17	10
FIN079SM	2856	RUGGERINI MC 70	17	2
FIN079SM	2856	RUGGERINI MC 71	17	4
FIN079SM	2856	RUGGERINI RF 80	17	6
FIN079SM	2856	RUGGERINI RF 81	17	8
FIN079SM	2856	RUGGERINI RD 80	18	2
FIN079SM	2856	RUGGERINI RD 81	18	4
FIN079SM	A2856	ACME ADN 37	16	18
FIN079SM	A2856	ACME ADN 37 W	16	20
FIN080CK	2912	RUGGERINI RF 88	17	10
FIN080CK	2912	RUGGERINI RF 90	17	12
FIN080CK	2912	RUGGERINI RF 91	17	14
FIN080CK	2912	RUGGERINI MC 70	17	2
FIN080CK	2912	RUGGERINI MC 71	17	4
FIN080CK	2912	RUGGERINI RF 80	17	6
FIN080CK	2912	RUGGERINI RF 81	17	8
FIN080CR STD	1640.030	INTERMOTOR Benzina Petrol LA 490	14	37
FIN080CR STD	1640.030	INTERMOTOR Benzina Petrol LAP 490	14	39
FIN080SM	A2225	RUGGERINI MD 75.0	19	2
FIN080SM	A2225	RUGGERINI MD 75.1	19	4
FIN081SM	A2141	RUGGERINI MD 150	19	6
FIN081SM	A2141	RUGGERINI MD 151	19	8
FIN082AP	579.010	ACME ADN 37, ADN 37W, ADN 60, ADN 60W, AD 108 , AD 110, AD 114 , AD 114/A, AD 112 , AD 116	16	63
FIN082AP	579.10	RUGGERINI MC-RF	17	27
FIN082CFA	359.151	ACME ADX 300	16	50
FIN082CFA	359.151	ACME ADX 370	16	52
FIN082CFA	359.151	ACME ADX 600	16	54
FIN082CFA	359.151	ACME ADX 740	16	56
FIN082CFA	359.151	ACME ADX 742	16	58
FIN082MB STD	0016100820	RUGGERINI RD 290	18	59
FIN082SM	2393	RUGGERINI RF 100	17	16
FIN082SM	2393	RUGGERINI RD 850	18	12
FIN082SM	2393	RUGGERINI RD 901/A	18	14
FIN082SM	2393	RUGGERINI RD 900	18	22
FIN082SM	2393	RUGGERINI RD 901	18	24
FIN082SM	A2393	ACME AD 114 / A	16	10
FIN082SM	A2393	ACME ADN 48	16	32
FIN082SM	A2393	ACME ADN 48	16	34
FIN082SM	A2393	ACME ADN 48 W	16	36
FIN082SM	A2393	ACME AD 108	16	6
FIN082SM	A2393	ACME AD 110	16	8
FIN083MB STD		RUGGERINI SP 420	18	61
FIN083SM	2983	RUGGERINI RD 200	18	16
FIN083SM	2983	RUGGERINI RD 201	18	18
FIN083SM	2983	RUGGERINI RD 208	18	20
FIN084AP	579.46	RUGGERINI RD	18	63
FIN084SM	2394	RUGGERINI RF 90	17	12
FIN084SM	2394	RUGGERINI RF 91	17	14
FIN084SM	2394	RUGGERINI RF 120	17	18
FIN084SM	2394	RUGGERINI RF 121	17	20
FIN084SM	2394	RUGGERINI RF 130	17	22
FIN084SM	2394	RUGGERINI RD 901/AD	18	26
FIN084SM	2394	RUGGERINI RD 920	18	38
FIN084SM	2394	RUGGERINI RD 920 L	18	40
FIN084SM	A2394	ACME AD 114	16	12
FIN084SM	A2394	ACME AD 112	16	14
FIN084SM	A2394	ACME AD 116	16	16
FIN084SM	A2394	ACME ADN 43	16	22
FIN084SM	A2394	ACME ADN 43 W	16	24
FIN084SM	A2394	ACME ADN 45	16	26
FIN084SM	A2394	ACME ADN 45	16	28
FIN084SM	A2394	ACME ADN 45 W	16	30
FIN084SM	A2394	ACME ADN 54	16	38
FIN084SM	A2394	ACME ADN 54	16	40

Tavole di corrispondenza

Cross references

Finimpianti	OEM	Costruttore-Motore Manufacturer-Engine	Cp.	Pg.
FIN084SM	A2394	ACME ADN 54 W	16	42
FIN0850KIT	A2391	RUGGERINI RF 88	17	10
FIN0850KIT	A2391	RUGGERINI MC 70	17	2
FIN0850KIT	A2391	RUGGERINI MC 71	17	4
FIN0850KIT	A2391	RUGGERINI RF 80	17	6
FIN0850KIT	A2391	RUGGERINI RF 81	17	8
FIN0850KIT		ACME ADN 37 W	16	20
FIN0858KIT		ACME ADN 37	16	18
FIN0858KIT		RUGGERINI RD 80	18	2
FIN0858KIT		RUGGERINI RD 81	18	4
FIN085AP	4740.031	SLANZI DVA 460, DVA 515, DVA 1030, DVA 1030 S, DVA 1200, DVA 1750	15	45
FIN085CK	2955	RUGGERINI RF 100	17	16
FIN085CK	2955	RUGGERINI RF 120	17	18
FIN085CK	2955	RUGGERINI RF 121	17	20
FIN085SM	A2092	RUGGERINI RD 210	18	28
FIN085SM	A2092	RUGGERINI RD 211	18	30
FIN085SM	A2092	RUGGERINI RD 218	18	32
FIN086AP	1200.060	SLANZI DVA 1030 S, DVA 1200	15	45
FIN086AP	579.12	RUGGERINI MD	19	33
FIN086AP	579.12	RUGGERINI CRD-P-RP	21	41
FIN086SM	2400	RUGGERINI RD 220	18	34
FIN086SM	2400	RUGGERINI RD 901/2	18	36
FIN086SM	2400	RUGGERINI RD 240	18	42
FIN086SM	2400	RUGGERINI RD 248	18	44
FIN086SM	2400	RUGGERINI RD 92/2	18	46
FIN086SM	2400	RUGGERINI RD 92/2 L	18	48
FIN087AP	4740.034	SLANZI DVA 1550, DVA 1550 S, DVA 1750, DVA 1750 S	15	45
FIN087E	660.18	RUGGERINI RD 278	18	56
FIN087E	660.18	RUGGERINI P 105/2	21	18
FIN087E	660.18	RUGGERINI P 105/2 R	21	20
FIN087E	660.18	RUGGERINI P 105/2 L	21	22
FIN087E	660.18	RUGGERINI RP 178	21	28
FIN087E	660.18	RUGGERINI RP 360	21	34
FIN087E	660.18	RUGGERINI RP 368	21	36
FIN087E	660.18	RUGGERINI RP 380	21	38
FIN087E	660.18	RUGGERINI RP 388	21	40
FIN087SL00	2380.305	SLANZI DVA 1550	15	11
FIN087SL00	2380.305	SLANZI DVA 515	15	5
FIN087SL00	2380.305	SLANZI DVA 1030	15	7
FIN087SM	2396	RUGGERINI CRD 951	21	2
FIN0887KIT	A2242	RUGGERINI MD 95.0	19	18
FIN0887KIT	A2242	RUGGERINI MD 95.1	19	20
FIN0887KIT	A2242	RUGGERINI MD 190	19	26
FIN0887KIT	A2242	RUGGERINI MD 191	19	28
FIN088AP	1200.047	SLANZI DVA 1500	15	45
FIN088SM	2473	RUGGERINI RD 270	18	54
FIN088SM	2473	RUGGERINI RD 278	18	56
FIN088SM	2473	RUGGERINI RD 952	18	58
FIN089MB STD	0016110890	RUGGERINI SP 420	18	61
FIN089SL00	2380.324	SLANZI DVA 460	15	1
FIN089SL00	2380.324	SLANZI DVA 920	15	3
FIN089SM	2483	RUGGERINI RF 140	17	24
FIN089SM	2483	RUGGERINI RF 148	17	26
FIN089SM	2483	RUGGERINI RD 950	18	50
FIN089SM	2483	RUGGERINI RD 950 L	18	52
FIN089SM	A2483	ACME ADN 60	16	44
FIN0902KIT		ACME AD 114 / A	16	10
FIN0902KIT		ACME ADN 48	16	32
FIN0902KIT		ACME AD 108	16	6
FIN0902KIT		ACME AD 110	16	8
FIN0902KIT		RUGGERINI RF 100	17	16
FIN0902KIT		RUGGERINI RD 850	18	12
FIN0902KIT		RUGGERINI RD 901/A	18	14
FIN090OP	0066050900	RUGGERINI RY 75	20	10
FIN090OP	0066050900	RUGGERINI RY 103	20	12
FIN090OP	0066050900	RUGGERINI RY 110	20	18
FIN090OP	0066050900	RUGGERINI RY 50	20	2
FIN090OP	0066050900	RUGGERINI RY 70	20	4
FIN090PF	059.90	RUGGERINI RF 90	17	12
FIN090PF	059.90	RUGGERINI RF 91	17	14
FIN090PF	059.90	RUGGERINI RF 120	17	18
FIN090PF	059.90	RUGGERINI RF 121	17	20
FIN090PF	059.90	RUGGERINI RF 140	17	24
FIN090PF	059.90	RUGGERINI RY 120	20	20
FIN090PF	059.90	RUGGERINI RY 121	20	22
FIN090PF	059.90	RUGGERINI RY 125	20	24
FIN090RS00	8211.119	SLANZI DVA 680	15	17
FIN090RS05	8211.120	SLANZI DVA 680	15	17
FIN090RS10	8211.121	SLANZI DVA 680	15	17
FIN090SM	2395	RUGGERINI P 101	21	10
FIN090SM	2395	RUGGERINI P 101 L	21	12
FIN090SM	2395	RUGGERINI RP 170	21	26
FIN090SM	2395	RUGGERINI RP 178	21	28

Finimpianti	OEM	Costruttore-Motore Manufacturer-Engine	Cp.	Pg.
FIN090SM	2395	RUGGERINI CRD 100	21	6
FIN0910KIT	A2392	RUGGERINI RF 90	17	12
FIN0910KIT	A2392	RUGGERINI RF 91	17	14
FIN0915KIT		RUGGERINI RD 901/AD	18	26
FIN091NO	6531.281	SLANZI DVA 1030 S	15	10
FIN091NO	6531.281	SLANZI DVA 1550	15	12
FIN091NO	6531.281	SLANZI DVA 1550 S	15	14
FIN091NO	6531.281	SLANZI DVA 1200	15	20
FIN091NO	6531.281	SLANZI DVA 1750	15	22
FIN091NO	6531.281	SLANZI DVA 1750 S	15	24
FIN091NO	6531.281	SLANZI DVA 2350	15	26
FIN091PF	059.72	RUGGERINI RY 100	20	14
FIN091PF	059.72	RUGGERINI RY 101	20	16
FIN091PF	059.72	RUGGERINI RY 85.0	20	6
FIN091PF	059.72	RUGGERINI RY 85.1	20	8
FIN091RS00	8211.091	SLANZI DVA 1550	15	11
FIN091RS00	8211.091	SLANZI DVA 515	15	5
FIN091RS00	8211.091	SLANZI DVA 1030	15	7
FIN091RS00	8211.093	SLANZI DVA 1550 S	15	13
FIN091RS00	8211.093	SLANZI DVA 1030 S	15	9
FIN091RS05	8211.092	SLANZI DVA 1550	15	11
FIN091RS05	8211.092	SLANZI DVA 515	15	5
FIN091RS05	8211.092	SLANZI DVA 1030	15	7
FIN091RS05	8211.094	SLANZI DVA 1550 S	15	13
FIN091RS05	8211.094	SLANZI DVA 1030 S	15	9
FIN091RS10	8211.135	SLANZI DVA 1550	15	11
FIN091RS10	8211.135	SLANZI DVA 515	15	5
FIN091RS10	8211.135	SLANZI DVA 1030	15	7
FIN091RS10		SLANZI DVA 1550 S	15	13
FIN091RS10		SLANZI DVA 1030 S	15	9
FIN091SM	2397	RUGGERINI P 101/2	21	14
FIN091SM	2397	RUGGERINI P 101/2 L	21	16
FIN091SM	2397	RUGGERINI RP 320	21	30
FIN091SM	2397	RUGGERINI RP 328	21	32
FIN091SM	2397	RUGGERINI CRD 100/2	21	8
FIN0927KIT	A2394	RUGGERINI RF 120	17	18
FIN0927KIT	A2394	RUGGERINI RF 121	17	20
FIN092NO	6531.283	SLANZI DVA 1500	15	28
FIN092NO	6531.283	SLANZI DVA 1800	15	34
FIN092NO	6531.283	SLANZI DVA 2700	15	36
FIN092NO	6531.283	SLANZI DVA 3600	15	38
FIN092NO	6531.283	SLANZI DS 2000	15	40
FIN092NO	6531.283	SLANZI DS 3000	15	42
FIN092NO	6531.283	SLANZI DS 4000	15	44
FIN092RS00	8211.095	SLANZI DVA 1200	15	19
FIN092RS00	8211.095	SLANZI DVA 1750	15	21
FIN092RS00	8211.095	SLANZI DVA 1750 S	15	23
FIN092RS05	8211.096	SLANZI DVA 2350	15	25
FIN092RS05	8211.096	SLANZI DVA 1200	15	19
FIN092RS05	8211.096	SLANZI DVA 1750	15	21
FIN092RS05	8211.096	SLANZI DVA 1750 S	15	23
FIN092RS05	8211.096	SLANZI DVA 2350	15	25
FIN092RS10	8211.137	SLANZI DVA 1200	15	19
FIN092RS10	8211.137	SLANZI DVA 1750	15	21
FIN092RS10	8211.137	SLANZI DVA 1750 S	15	23
FIN092RS10	8211.137	SLANZI DVA 2350	15	25
FIN0937KIT		RUGGERINI RD 240	18	42
FIN0937KIT		RUGGERINI RD 248	18	44
FIN0937KIT		RUGGERINI RD 92/2	18	46
FIN0937KIT		RUGGERINI RD 92/2 L	18	48
FIN094RS00	8211.131	SLANZI DVA 1800	15	33
FIN094RS00	8211.131	SLANZI DVA 2700	15	35
FIN094RS00	8211.131	SLANZI DVA 3600	15	37
FIN094RS05	8211.132	SLANZI DVA 1800	15	33
FIN094RS05	8211.132	SLANZI DVA 2700	15	35
FIN094RS05	8211.132	SLANZI DVA 3600	15	37
FIN094RS10		SLANZI DVA 1800	15	33
FIN094RS10		SLANZI DVA 2700	15	35
FIN094RS10		SLANZI DVA 3600	15	37
FIN0951KIT	A2403	RUGGERINI RF 140	17	24
FIN0951KIT	A2403	RUGGERINI RF 148	17	26
FIN0965KIT		RUGGERINI P 101	21	10
FIN0965KIT		RUGGERINI P 101 L	21	12
FIN0965KIT		RUGGERINI P 101/2	21	14
FIN0965KIT		RUGGERINI P 101/2 L	21	16
FIN0965KIT		RUGGERINI RP 170	21	26
FIN0965KIT		RUGGERINI RP 178	21	28
FIN0965KIT		RUGGERINI RP 320	21	30
FIN0965KIT		RUGGERINI RP 328	21	32
FIN0965KIT		RUGGERINI CRD 100	21	6
FIN0965KIT		RUGGERINI CRD 100/2	21	8
FIN098DV	956.51	RUGGERINI RF 88	17	10
FIN098DV	956.51	RUGGERINI RF 90	17	12
FIN098DV	956.51	RUGGERINI RF 91	17	14
FIN098DV	956.51	RUGGERINI MC 70	17	2
FIN098DV	956.51	RUGGERINI MC 71	17	4
FIN098DV	956.51	RUGGERINI RF 80	17	6
FIN098DV	956.51	RUGGERINI RF 81	17	8
FIN098NO	644.34	RUGGERINI RF 100	17	16
FIN099DV	956.32	RUGGERINI P 105/2	21	18
FIN099DV	956.32	RUGGERINI P 105/2 R	21	20
FIN099DV	956.32	RUGGERINI P 105/2 L	21	22
FIN099DV	956.32	RUGGERINI RP 360	21	34
FIN099DV	956.32	RUGGERINI RP 368	21	36

Ricambi non originali per motori. Denominazioni e codici originali, sono riportati a puro titolo di riferimento.

8 - A

rel. 1511

Non original engine parts. OEMs names and part numbers are for reference purpose only.

Tavole di corrispondenza

Cross references

Finimpianti	OEM	Costruttore-Motore Manufacturer-Engine	Cp.	Pg.
FIN099DV	956.32	RUGGERINI RP 380	21	38
FIN099DV	956.32	RUGGERINI RP 388	21	40
FIN1003RT	1210.045	INTERMOTOR LA 490	14	38
FIN1003RT	1210.045	INTERMOTOR LAP 490	14	40
FIN1006RT	0012133450	RUGGERINI RY 75	20	10
FIN1006RT	0012133450	RUGGERINI RY 50	20	2
FIN1006RT	0012133450	RUGGERINI RY 70	20	4
FIN1007RT	0012133610	RUGGERINI RY 75	20	10
FIN1007RT	0012133610	RUGGERINI RY 50	20	2
FIN1007RT	0012133610	RUGGERINI RY 70	20	4
FIN1012NF	5496.134	SLANZI DVA 1550 S	15	14
FIN1012NF	5496.134	SLANZI DVA 1200	15	20
FIN1012NF	5496.134	SLANZI DVA 1750	15	22
FIN1012NF	5496.134	SLANZI DVA 2900	15	32
FIN1013NF	5496.146	SLANZI DVA 1750 S	15	24
FIN1013NF	5496.146	SLANZI DVA 2350	15	26
FIN1018NF	5496.132	SLANZI DVA 1030 S	15	10
FIN1018NF	5496.132	SLANZI DVA 920	15	4
FIN1018NF	5496.132	SLANZI DVA 1030	15	8
FIN101AF	3700.101	INTERMOTOR LA 490	14	38
FIN101AF	3700.101	INTERMOTOR LAP 490	14	40
FIN1027FE	2175.067	SLANZI DVA 2350	15	26
FIN1027FE	2175.067	SLANZI DVA 2700	15	36
FIN1027FE	2175.067	SLANZI DVA 3600	15	38
FIN1027FE	2175.067	SLANZI DS 3000	15	42
FIN1027FE	2175.067	SLANZI DS 4000	15	44
FIN102DV	956.109	ACME ADN 37 W	16	20
FIN102DV	956.109	ACME ADN 43	16	22
FIN102DV	956.109	ACME ADN 43 W	16	24
FIN102DV	956.109	ACME ADN 45	16	28
FIN102DV	956.109	ACME ADN 45 W	16	30
FIN102DV	956.109	ACME ADN 48	16	34
FIN102DV	956.109	ACME ADN 48 W	16	36
FIN102DV	956.109	ACME ADN 54	16	40
FIN102DV	956.109	ACME ADN 54 W	16	42
FIN102DV	956.109	ACME ADN 60	16	46
FIN102DV	956.109	ACME ADN 60 W	16	48
FIN102DV	956.109	ACME ADX 300	16	50
FIN102DV	956.109	ACME ADX 370	16	52
FIN102DV	956.109	ACME ADX 600	16	54
FIN102DV	956.109	ACME ADX 740	16	56
FIN102DV	956.109	ACME ADX 742	16	58
FIN102OF	175.24	RUGGERINI RD 188	18	10
FIN102OF	175.24	RUGGERINI RD 200	18	16
FIN102OF	175.24	RUGGERINI RD 201	18	18
FIN102OF	175.24	RUGGERINI RD 208	18	20
FIN102OF	175.24	RUGGERINI RD 210	18	28
FIN102OF	175.24	RUGGERINI RD 211	18	30
FIN102OF	175.24	RUGGERINI RD 218	18	32
FIN102OF	175.24	RUGGERINI RD 220	18	34
FIN102OF	175.24	RUGGERINI RD 240	18	42
FIN102OF	175.24	RUGGERINI RD 248	18	44
FIN102OF	175.24	RUGGERINI RD 92/2	18	46
FIN102OF	175.24	RUGGERINI RD 92/2 L	18	48
FIN102OF	175.24	RUGGERINI RD 270	18	54
FIN102OF	175.24	RUGGERINI RD 278	18	56
FIN102OF	175.24	RUGGERINI RD 952	18	58
FIN102OF	175.24	RUGGERINI RD 180	18	6
FIN102OF	175.24	RUGGERINI RD 181	18	8
FIN102OF	175.24	RUGGERINI MD 300	19	10
FIN102OF	175.24	RUGGERINI MD 301	19	12
FIN102OF	175.24	RUGGERINI MD 350	19	30
FIN102OF	175.24	RUGGERINI MD 351	19	32
FIN102PB	316.102	ACME VT 88 W	16	59
FIN102PB	316.102	ACME AL 480	16	61
FIN102PC00	A2813	ACME ADX 300	16	49
FIN102PC05	A2814	ACME ADX 600	16	49
FIN102PC05	A2814	ACME ADX 600	16	53
FIN102PC10	A2815	ACME ADX 300	16	49
FIN102PC10	A2815	ACME ADX 600	16	53
FIN1030NF	359.30	RUGGERINI RF 88	17	10
FIN1030NF	359.30	RUGGERINI MC 70	17	2
FIN1030NF	359.30	RUGGERINI RF 130	17	22
FIN1030NF	359.30	RUGGERINI RF 148	17	26
FIN1030NF	359.30	RUGGERINI MC 71	17	4
FIN1030NF	359.30	RUGGERINI RF 80	17	6
FIN1030NF	359.30	RUGGERINI RF 81	17	8
FIN1033NF	359.013	ACME AD 114 / A	16	10
FIN1033NF	359.013	ACME AD 114	16	12
FIN1033NF	359.013	ACME AD 112	16	14
FIN1033NF	359.013	ACME AD 116	16	16
FIN1033NF	359.013	ACME ADN 48	16	32
FIN1033NF	359.013	ACME ADN 54	16	38
FIN1033NF	359.013	ACME ADN 60	16	44
FIN1033NF	359.013	ACME AD 108	16	6
FIN1033NF	359.013	ACME AD 110	16	8
FIN1033NF	359.13	RUGGERINI RD 850	18	12
FIN1033NF	359.13	RUGGERINI RD 901/A	18	14
FIN1033NF	359.13	RUGGERINI RD 80	18	2
FIN1033NF	359.13	RUGGERINI RD 900	18	22
FIN1033NF	359.13	RUGGERINI RD 901	18	24
FIN1033NF	359.13	RUGGERINI RD 901/AD	18	26

Finimpianti	OEM	Costruttore-Motore Manufacturer-Engine	Cp.	Pg.
FIN1033NF	359.13	RUGGERINI RD 920	18	38
FIN1033NF	359.13	RUGGERINI RD 81	18	4
FIN1033NF	359.13	RUGGERINI RD 920 L	18	40
FIN1033NF	359.13	RUGGERINI RD 950	18	50
FIN1033NF	359.13	RUGGERINI RD 950 L	18	52
FIN1035NF	359.24	RUGGERINI RF 100	17	16
FIN1035NF	359.24	RUGGERINI RY 100	20	14
FIN1035NF	359.24	RUGGERINI RY 101	20	16
FIN1035NF	359.24	RUGGERINI RY 85.0	20	6
FIN1035NF	359.24	RUGGERINI RY 85.1	20	8
FIN1040NF	359.16	RUGGERINI P 101	21	10
FIN1040NF	359.16	RUGGERINI P 101 L	21	12
FIN1040NF	359.16	RUGGERINI P 101/2	21	14
FIN1040NF	359.16	RUGGERINI P 101/2 L	21	16
FIN1040NF	359.16	RUGGERINI P 105/2	21	18
FIN1040NF	359.16	RUGGERINI CRD 951	21	2
FIN1040NF	359.16	RUGGERINI P 105/2 R	21	20
FIN1040NF	359.16	RUGGERINI P 105/2 L	21	22
FIN1040NF	359.16	RUGGERINI RP 280	21	24
FIN1040NF	359.16	RUGGERINI RP 170	21	26
FIN1040NF	359.16	RUGGERINI RP 178	21	28
FIN1040NF	359.16	RUGGERINI RP 320	21	30
FIN1040NF	359.16	RUGGERINI RP 328	21	32
FIN1040NF	359.16	RUGGERINI RP 360	21	34
FIN1040NF	359.16	RUGGERINI RP 368	21	36
FIN1040NF	359.16	RUGGERINI RP 380	21	38
FIN1040NF	359.16	RUGGERINI CRD 951/2	21	4
FIN1040NF	359.16	RUGGERINI RP 388	21	40
FIN1040NF	359.16	RUGGERINI CRD 100	21	6
FIN1040NF	359.16	RUGGERINI CRD 100/2	21	8
FIN104MB STD	310.104	ACME ADX 300	16	49
FIN104MB STD	310.104	ACME ADX 370	16	51
FIN104MB STD	310.104	ACME ADX 600	16	53
FIN104MB STD	310.104	ACME ADX 740	16	55
FIN104MB STD	310.104	ACME ADX 742	16	57
FIN1051NF	359.25	RUGGERINI RD 220	18	34
FIN1051NF	359.25	RUGGERINI RD 901/2	18	36
FIN1051NF	359.25	RUGGERINI RD 240	18	42
FIN1051NF	359.25	RUGGERINI RD 248	18	44
FIN1051NF	359.25	RUGGERINI RD 92/2	18	46
FIN1051NF	359.25	RUGGERINI RD 92/2 L	18	48
FIN1051NF	359.25	RUGGERINI RD 270	18	54
FIN1051NF	359.25	RUGGERINI RD 278	18	56
FIN1051NF	359.25	RUGGERINI RD 952	18	58
FIN1051NF	359.25	RUGGERINI MD 300	19	10
FIN1051NF	359.25	RUGGERINI MD 301	19	12
FIN1051NF	359.25	RUGGERINI MD 350	19	30
FIN1051NF	359.25	RUGGERINI MD 351	19	32
FIN105CGA		RUGGERINI RF 88	17	10
FIN105CGA		RUGGERINI MC 70	17	2
FIN105CGA		RUGGERINI MC 71	17	4
FIN105CGA		RUGGERINI RF 80	17	6
FIN105CGA		RUGGERINI RF 81	17	8
FIN105CGA		RUGGERINI RD 80	18	2
FIN105CGA		RUGGERINI RD 81	18	4
FIN105CGB	2329	RUGGERINI RF 88	17	10
FIN105CGB	2329	RUGGERINI MC 70	17	2
FIN105CGB	2329	RUGGERINI MC 71	17	4
FIN105CGB	2329	RUGGERINI RF 80	17	6
FIN105CGB	2329	RUGGERINI RF 81	17	8
FIN105CGB	2329	RUGGERINI RD 80	18	2
FIN105CGB	2329	RUGGERINI RD 81	18	4
FIN105MB STD	310.105	ACME ADX 300	16	49
FIN105MB STD	310.105	ACME ADX 370	16	51
FIN105MB STD	310.105	ACME ADX 600	16	53
FIN105MB STD	310.105	ACME ADX 740	16	55
FIN105MB STD	310.105	ACME ADX 742	16	57
FIN105PC00	A2485	ACME ADN 45	16	25
FIN105PC05	A2486	ACME ADN 45	16	25
FIN105PC10	A2487	ACME ADN 45	16	25
FIN1060KR	100.36	RUGGERINI RF 88	17	10
FIN1060KR	100.36	RUGGERINI RF 90	17	12
FIN1060KR	100.36	RUGGERINI RF 91	17	14
FIN1060KR	100.36	RUGGERINI MC 70	17	2
FIN1060KR	100.36	RUGGERINI MC 71	17	4
FIN1060KR	100.36	RUGGERINI RF 80	17	6
FIN1060KR	100.36	RUGGERINI RF 81	17	8
FIN1060KR	100.36	RUGGERINI RD 80	18	2
FIN1060KR	100.36	RUGGERINI RD 81	18	4
FIN1060KR	A2546	ACME ADN 37	16	18
FIN1065KR	100.109	ACME ADN 45	16	26
FIN1065KR	100.23	RUGGERINI RF 100	17	16
FIN1065KR	100.23	RUGGERINI RF 120	17	18
FIN1065KR	100.23	RUGGERINI RF 121	17	20
FIN1065KR	100.23	RUGGERINI RF 130	17	22
FIN1065KR	100.23	RUGGERINI RF 140	17	24
FIN1065KR	100.23	RUGGERINI RF 148	17	26
FIN1065KR	100.23	RUGGERINI RD 850	18	12
FIN1065KR	100.23	RUGGERINI RD 901/A	18	14
FIN1065KR	100.23	RUGGERINI RD 900	18	22
FIN1065KR	100.23	RUGGERINI RD 901	18	24
FIN1065KR	100.23	RUGGERINI RD 901/AD	18	26
FIN1065KR	100.23	RUGGERINI RD 220	18	34
FIN1065KR	100.23	RUGGERINI RD 901/2	18	36

Ricambi non originali per motori. Denominazioni e codici originali, sono riportati a puro titolo di riferimento.

Tavole di corrispondenza

Cross references

Finimpianti	OEM	Costruttore-Motore Manufacturer-Engine	Cp.	Pg.
FIN1065KR	100.23	RUGGERINI RD 920	18	38
FIN1065KR	100.23	RUGGERINI RD 920 L	18	40
FIN1065KR	100.23	RUGGERINI RD 240	18	42
FIN1065KR	100.23	RUGGERINI RD 248	18	44
FIN1065KR	100.23	RUGGERINI RD 92/2	18	46
FIN1065KR	100.23	RUGGERINI RD 92/2 L	18	48
FIN1065KR	100.23	RUGGERINI RD 950	18	50
FIN1065KR	100.23	RUGGERINI RD 950 L	18	52
FIN1065KR	100.23	RUGGERINI RD 270	18	54
FIN1065KR	100.23	RUGGERINI RD 278	18	56
FIN1065KR	100.23	RUGGERINI RD 952	18	58
FIN1065KR	2117	ACME AD 114 / A	16	10
FIN1065KR	2117	ACME AD 114	16	12
FIN1065KR	2117	ACME AD 112	16	14
FIN1065KR	2117	ACME AD 116	16	16
FIN1065KR	2117	ACME ADN 45	16	28
FIN1065KR	2117	ACME ADN 45 W	16	30
FIN1065KR	2117	ACME ADN 48	16	32
FIN1065KR	2117	ACME ADN 48	16	34
FIN1065KR	2117	ACME ADN 48 W	16	36
FIN1065KR	2117	ACME ADN 54	16	38
FIN1065KR	2117	ACME ADN 54	16	40
FIN1065KR	2117	ACME ADN 54 W	16	42
FIN1065KR	2117	ACME ADN 60	16	44
FIN1065KR	2117	ACME ADN 60	16	46
FIN1065KR	2117	ACME ADN 60 W	16	48
FIN1065KR	2117	ACME AD 108	16	6
FIN1065KR	2117	ACME AD 110	16	8
FIN106CGA		RUGGERINI MD 75.0	19	2
FIN106CGA		RUGGERINI MD 75.1	19	4
FIN106CGB	A2226	RUGGERINI MD 75.0	19	2
FIN106CGB	A2226	RUGGERINI MD 75.1	19	4
FIN106PC00	B0353	ACME ADN 45 W	16	29
FIN106PC05	B0354	ACME ADN 45 W	16	29
FIN106PC10	B0355	ACME ADN 45 W	16	29
FIN107CGA		RUGGERINI MD 150	19	6
FIN107CGA		RUGGERINI MD 151	19	8
FIN107CGB	A2142	RUGGERINI MD 150	19	6
FIN107CGB	A2142	RUGGERINI MD 151	19	8
FIN107NO	0065312650	RUGGERINI RD 290	18	60
FIN107PC00	B0100	ACME ADX 370	16	51
FIN107PC00	B0100	ACME ADX 740	16	55
FIN107PC00	B0100	ACME ADX 742	16	57
FIN107PC05	B0101	ACME ADX 370	16	51
FIN107PC05	B0101	ACME ADX 740	16	55
FIN107PC05	B0101	ACME ADX 742	16	57
FIN107PC10	B0102	ACME ADX 370	16	51
FIN107PC10	B0102	ACME ADX 740	16	55
FIN107PC10	B0102	ACME ADX 742	16	57
FIN1081NF	5496.133	SLANZI DVA 460	15	2
FIN1081NF	5496.133	SLANZI DVA 515	15	6
FIN1083NF	5496.136	SLANZI DVA 1800	15	34
FIN1083NF	5496.136	SLANZI DVA 2700	15	36
FIN1083NF	5496.136	SLANZI DS 2000	15	40
FIN1083NF	5496.136	SLANZI DS 3000	15	42
FIN1085NF	5496.137	SLANZI DVA 3600	15	38
FIN1085NF	5496.137	SLANZI DS 4000	15	44
FIN108CGA		ACME AD 114 / A	16	10
FIN108CGA		ACME ADN 43	16	22
FIN108CGA		ACME ADN 43 W	16	24
FIN108CGA		ACME ADN 45	16	26
FIN108CGA		ACME ADN 45	16	28
FIN108CGA		ACME ADN 45 W	16	30
FIN108CGA		ACME ADN 48	16	32
FIN108CGA		ACME ADN 48	16	34
FIN108CGA		ACME ADN 48 W	16	36
FIN108CGA		ACME AD 108	16	6
FIN108CGA		ACME AD 110	16	8
FIN108CGA		RUGGERINI RF 100	17	16
FIN108CGA		RUGGERINI RD 850	18	12
FIN108CGA		RUGGERINI RD 901/A	18	14
FIN108CGB	2119	RUGGERINI RF 100	17	16
FIN108CGB	2119	RUGGERINI RD 850	18	12
FIN108CGB	2119	RUGGERINI RD 901/A	18	14
FIN108CGB	2119	RUGGERINI RD 900	18	22
FIN108CGB	2119	RUGGERINI RD 901	18	24
FIN108CGB	A2119	ACME AD 114 / A	16	10
FIN108CGB	A2119	ACME ADN 43	16	22
FIN108CGB	A2119	ACME ADN 43 W	16	24
FIN108CGB	A2119	ACME ADN 45	16	26
FIN108CGB	A2119	ACME ADN 45	16	28
FIN108CGB	A2119	ACME ADN 45 W	16	30
FIN108CGB	A2119	ACME ADN 48	16	32
FIN108CGB	A2119	ACME ADN 48	16	34
FIN108CGB	A2119	ACME ADN 48 W	16	36
FIN108CGB	A2119	ACME AD 108	16	6
FIN108CGB	A2119	ACME AD 110	16	8
FIN108PC00	A2553	ACME ADN 43	16	21
FIN108PC05		ACME ADN 43	16	21
FIN108PC10		ACME ADN 43	16	21
FIN1093OF	2175.088	SLANZI DVA 1500	15	28
FIN1094OF	2175.089	SLANZI DVA 2200	15	30
FIN1094OF	2175.089	SLANZI DVA 2900	15	32
FIN1095OF	2175.072	SLANZI DVA 1030 S	15	10

Finimpianti	OEM	Costruttore-Motore Manufacturer-Engine	Cp.	Pg.
FIN1095OF	2175.072	SLANZI DVA 460	15	2
FIN1095OF	2175.072	SLANZI DVA 1200	15	20
FIN1095OF	2175.072	SLANZI DVA 920	15	4
FIN1095OF	2175.072	SLANZI DVA 515	15	6
FIN1095OF	2175.072	SLANZI DVA 1030	15	8
FIN1096OF	2175.087	SLANZI DVA 680	15	18
FIN1097OF	2175.085	SLANZI DVA 650	15	16
FIN1098OF	2175.069	SLANZI DVA 2700	15	36
FIN1098OF	2175.069	SLANZI DVA 3600	15	38
FIN1098OF	2175.069	SLANZI DS 3000	15	42
FIN1098OF	2175.069	SLANZI DS 4000	15	44
FIN1099OF	2175.070	SLANZI DVA 1800	15	34
FIN1099OF	2175.070	SLANZI DS 2000	15	40
FIN109CGA		RUGGERINI RD 200	18	16
FIN109CGA		RUGGERINI RD 201	18	18
FIN109CGA		RUGGERINI RD 208	18	20
FIN109CGB	2984	RUGGERINI RD 200	18	16
FIN109CGB	2984	RUGGERINI RD 201	18	18
FIN109CGB	2984	RUGGERINI RD 208	18	20
FIN109PC00	B0349	ACME ADN 43 W	16	23
FIN109PC05	B0350	ACME ADN 43 W	16	23
FIN109PC10	B0351	ACME ADN 43 W	16	23
FIN1100NF	5496.062	INTERMOTOR IM 300	14	10
FIN1100NF	5496.062	INTERMOTOR IM 300	14	12
FIN1100NF	5496.062	INTERMOTOR IM 302	14	14
FIN1100NF	5496.062	INTERMOTOR IM 302	14	16
FIN1100NF	5496.062	INTERMOTOR IM 350	14	18
FIN1100NF	5496.062	INTERMOTOR IM 250	14	2
FIN1100NF	5496.062	INTERMOTOR IM 350	14	20
FIN1100NF	5496.062	INTERMOTOR IM 352	14	22
FIN1100NF	5496.062	INTERMOTOR IM 352	14	24
FIN1100NF	5496.062	INTERMOTOR IM 359	14	26
FIN1100NF	5496.062	INTERMOTOR IM 359	14	28
FIN1100NF	5496.062	INTERMOTOR IM 250	14	4
FIN1100NF	5496.062	INTERMOTOR IM 252	14	6
FIN1100NF	5496.062	INTERMOTOR IM 252	14	8
FIN1101AF	2175.172	INTERMOTOR IM 250, IM 300, IM 350, IM 359 Benzina Petrol REXYLING	14	53
FIN110CGA		ACME AD 114	16	12
FIN110CGA		ACME AD 112	16	14
FIN110CGA		ACME AD 116	16	16
FIN110CGA		ACME ADN 54	16	38
FIN110CGA		ACME ADN 54	16	40
FIN110CGA		ACME ADN 54 W	16	42
FIN110CGA		RUGGERINI RF 90	17	12
FIN110CGA		RUGGERINI RF 91	17	14
FIN110CGA		RUGGERINI RF 120	17	18
FIN110CGA		RUGGERINI RF 121	17	20
FIN110CGA		RUGGERINI RF 130	17	22
FIN110CGA		RUGGERINI RD 900	18	22
FIN110CGA		RUGGERINI RD 901	18	24
FIN110CGA		RUGGERINI RD 901/AD	18	26
FIN110CGA		RUGGERINI RD 920	18	38
FIN110CGA		RUGGERINI RD 920 L	18	40
FIN110CGB	2140	RUGGERINI RF 90	17	12
FIN110CGB	2140	RUGGERINI RF 91	17	14
FIN110CGB	2140	RUGGERINI RF 120	17	18
FIN110CGB	2140	RUGGERINI RF 121	17	20
FIN110CGB	2140	RUGGERINI RF 130	17	22
FIN110CGB	2140	RUGGERINI RD 901/AD	18	26
FIN110CGB	2140	RUGGERINI RD 920	18	38
FIN110CGB	2140	RUGGERINI RD 920 L	18	40
FIN110CGB	A2140	ACME AD 114	16	12
FIN110CGB	A2140	ACME AD 112	16	14
FIN110CGB	A2140	ACME AD 116	16	16
FIN110CGB	A2140	ACME ADN 54	16	38
FIN110CGB	A2140	ACME ADN 54	16	40
FIN110CGB	A2140	ACME ADN 54	16	42
FIN110CGB	A2140	ACME ADN 54 W	16	44
FIN110PC00	A2674	ACME ADN 48	16	33
FIN110PC05		ACME ADN 48	16	33
FIN110PC10		ACME ADN 48	16	33
FIN111CGA		RUGGERINI RD 210	18	28
FIN111CGA		RUGGERINI RD 211	18	30
FIN111CGA		RUGGERINI RD 218	18	32
FIN111CGB	A2093	RUGGERINI RD 210	18	28
FIN111CGB	A2093	RUGGERINI RD 211	18	30
FIN111CGB	A2093	RUGGERINI RD 218	18	32
FIN111CR STD	316.134	ACME ADN 37 W	16	19
FIN111CR STD	316.134	ACME ADN 43	16	21
FIN111CR STD	316.134	ACME ADN 43 W	16	23
FIN111CR STD	316.134	ACME ADX 300	16	49
FIN111CR STD	316.134	ACME ADX 370	16	51
FIN111CR STD	316.134	ACME ADX 600	16	53
FIN111CR STD	316.134	ACME ADX 600	16	53
FIN111CR STD	316.134	ACME ADX 740	16	55
FIN111CR STD	316.134	ACME ADX 740	16	55
FIN111CR STD	316.134	ACME ADX 742	16	57
FIN111CR STD	316.134	ACME ADX 742	16	57
FIN111PC00	B0357	ACME ADN 48 W	16	35
FIN111PC05	B0358	ACME ADN 48 W	16	35
FIN111PC10	B0359	ACME ADN 48 W	16	35
FIN112CGA		RUGGERINI RD 220	18	34

Tavole di corrispondenza

Cross references

Finimpianti	OEM	Costruttore-Motore Manufacturer-Engine	Cp.	Pg.
FIN112CGA		RUGGERINI RD 901/2	18	36
FIN112CGA		RUGGERINI RD 240	18	42
FIN112CGA		RUGGERINI RD 248	18	44
FIN112CGA		RUGGERINI RD 92/2	18	46
FIN112CGA		RUGGERINI RD 92/2 L	18	48
FIN112CGB	2319	RUGGERINI RD 220	18	34
FIN112CGB	2319	RUGGERINI RD 901/2	18	36
FIN112CGB	2319	RUGGERINI RD 240	18	42
FIN112CGB	2319	RUGGERINI RD 248	18	44
FIN112CGB	2319	RUGGERINI RD 92/2	18	46
FIN112CGB	2319	RUGGERINI RD 92/2 L	18	48
FIN112NF	5496.111	INTERMOTOR LA 490	14	38
FIN112NF	5496.111	INTERMOTOR LAP 490	14	40
FIN112PB	316.110	ACME ADN 37	16	17
FIN112PB	316.110	ACME ADN 37 W	16	19
FIN112PB	316.110	ACME ADN 43	16	21
FIN112PB	316.110	ACME ADN 43 W	16	23
FIN112PB	316.110	ACME ADX 300	16	49
FIN112PB	316.110	ACME ADX 370	16	51
FIN112PB	316.110	ACME ADX 600	16	53
FIN112PB	316.110	ACME ADX 740	16	55
FIN112PB	316.110	ACME ADX 742	16	57
FIN112PC00	A2402	ACME VT 88 W	16	59
FIN112PC00	A2402	ACME AL 480	16	61
FIN112PC05	A2403	ACME VT 88 W	16	59
FIN112PC05	A2403	ACME AL 480	16	61
FIN112PC10	A2404	ACME VT 88 W	16	59
FIN112PC10	A2404	ACME AL 480	16	61
FIN112SI	527.44	RUGGERINI RF 90	17	12
FIN112SI	527.44	RUGGERINI RF 91	17	14
FIN112SI	527.44	RUGGERINI RF 120	17	18
FIN112SI	527.44	RUGGERINI MC 70	17	2
FIN112SI	527.44	RUGGERINI RF 121	17	20
FIN112SI	527.44	RUGGERINI MC 71	17	4
FIN112SI	527.44	RUGGERINI RF 80	17	6
FIN112SI	527.44	RUGGERINI RF 81	17	8
FIN113CGA		RUGGERINI CRD 951	21	2
FIN113CGB	2166	RUGGERINI CRD 951	21	2
FIN113PC00	A2678	ACME ADN 54	16	39
FIN113PC05		ACME ADN 54	16	39
FIN113PC10		ACME ADN 54	16	39
FIN113SI	526.066	ACME AD 114 / A	16	10
FIN113SI	526.066	ACME AD 114	16	12
FIN113SI	526.066	ACME AD 112	16	14
FIN113SI	526.066	ACME AD 116	16	16
FIN113SI	526.066	ACME AD 108	16	6
FIN113SI	526.066	ACME AD 110	16	8
FIN113SI	526.66	RUGGERINI RF 88	17	10
FIN113SI	526.66	RUGGERINI RF 100	17	16
FIN113SI	526.66	RUGGERINI RF 130	17	22
FIN113SI	526.66	RUGGERINI RF 140	17	24
FIN113SI	526.66	RUGGERINI RF 148	17	26
FIN113SI	526.66	RUGGERINI RD 850	18	12
FIN113SI	526.66	RUGGERINI RD 901/A	18	14
FIN113SI	526.66	RUGGERINI RD 80	18	2
FIN113SI	526.66	RUGGERINI RD 900	18	22
FIN113SI	526.66	RUGGERINI RD 901	18	24
FIN113SI	526.66	RUGGERINI RD 901/AD	18	26
FIN113SI	526.66	RUGGERINI RD 920	18	38
FIN113SI	526.66	RUGGERINI RD 81	18	4
FIN113SI	526.66	RUGGERINI RD 920 L	18	40
FIN113SI	526.66	RUGGERINI RD 950	18	50
FIN113SI	526.66	RUGGERINI RD 950 L	18	52
FIN1148NF	670.15	RUGGERINI RD 901/2, RD 240, RD 248 , RD 92/2, RD 92/2 L , RD 270, RD 278 , RD 952	18	63
FIN114CGA		RUGGERINI RD 270	18	54
FIN114CGA		RUGGERINI RD 278	18	56
FIN114CGA		RUGGERINI RD 952	18	58
FIN114CGB	2472	RUGGERINI RD 270	18	54
FIN114CGB	2472	RUGGERINI RD 278	18	56
FIN114CGB	2472	RUGGERINI RD 952	18	58
FIN114NO	644.007	ACME AD 114 / A	16	10
FIN114NO	644.007	ACME AD 114	16	12
FIN114NO	644.007	ACME AD 112	16	14
FIN114NO	644.007	ACME AD 116	16	16
FIN114NO	644.007	ACME ADN 37	16	18
FIN114NO	644.007	ACME ADN 45	16	26
FIN114NO	644.007	ACME ADN 48	16	32
FIN114NO	644.007	ACME AD 108	16	6
FIN114NO	644.007	ACME AD 110	16	8
FIN114NO	644.07	RUGGERINI RD 850	18	12
FIN114NO	644.07	RUGGERINI RD 901/A	18	14
FIN114NO	644.07	RUGGERINI RD 80	18	2
FIN114NO	644.07	RUGGERINI RD 900	18	22
FIN114NO	644.07	RUGGERINI RD 901	18	24
FIN114NO	644.07	RUGGERINI RD 901/AD	18	26
FIN114NO	644.07	RUGGERINI RD 920	18	38
FIN114NO	644.07	RUGGERINI RD 81	18	4
FIN114NO	644.07	RUGGERINI RD 950	18	50

Finimpianti	OEM	Costruttore-Motore Manufacturer-Engine	Cp.	Pg.	
FIN114NO	644.102	ACME ADN 43	16	22	
FIN114NO	644.102	ACME ADN 45	16	28	
FIN114NO	644.102	ACME ADN 60 W	16	48	
FIN114NO	644.26	RUGGERINI RD 92/2 L	18	48	
FIN114NO	644.26	RUGGERINI RP 178 "CIPA"	21	41	
FIN114PC00	B0361	ACME ADN 54 W	16	41	
FIN114PC05	B0362	ACME ADN 54 W	16	41	
FIN114PC10	B0363	ACME ADN 54 W	16	41	
FIN115CGA		ACME ADN 60	16	44	
FIN115CGA		RUGGERINI RF 140	17	24	
FIN115CGA		RUGGERINI RF 148	17	26	
FIN115CGA		RUGGERINI RD 950	18	50	
FIN115CGA		RUGGERINI RD 950 L	18	52	
FIN115CGB	2482	RUGGERINI RF 140	17	24	
FIN115CGB	2482	RUGGERINI RF 148	17	26	
FIN115CGB	2482	RUGGERINI RD 950	18	50	
FIN115CGB	2482	RUGGERINI RD 950 L	18	52	
FIN115CGB	A2482	ACME ADN 60	16	44	
FIN115PC00	2458	ACME ADN 60	16	43	
FIN115PC05	2459	ACME ADN 60	16	43	
FIN115PC10	2460	ACME ADN 60	16	43	
FIN116CGA		RUGGERINI P 101	21	10	
FIN116CGA		RUGGERINI P 101 L	21	12	
FIN116CGA		RUGGERINI RP 170	21	26	
FIN116CGA		RUGGERINI RP 178	21	28	
FIN116CGA		RUGGERINI CRD 100	21	6	
FIN116CGB	2180	RUGGERINI P 101	21	10	
FIN116CGB	2180	RUGGERINI P 101 L	21	12	
FIN116CGB	2180	RUGGERINI RP 170	21	26	
FIN116CGB	2180	RUGGERINI RP 178	21	28	
FIN116CGB	2180	RUGGERINI CRD 100	21	6	
FIN117CGA		RUGGERINI P 101/2	21	14	
FIN117CGA		RUGGERINI P 101/2 L	21	16	
FIN117CGA		RUGGERINI RP 320	21	30	
FIN117CGA		RUGGERINI RP 328	21	32	
FIN117CGA		RUGGERINI CRD 100/2	21	8	
FIN117CGB	2204	RUGGERINI P 101/2	21	14	
FIN117CGB	2204	RUGGERINI P 101/2 L	21	16	
FIN117CGB	2204	RUGGERINI RP 320	21	30	
FIN117CGB	2204	RUGGERINI RP 328	21	32	
FIN117CGB	2204	RUGGERINI CRD 100/2	21	8	
FIN119CV	054.139	ACME ADN 37, ADN 37W, ADN 60, ADN 60W	16	63	
FIN119CV	451.25	RUGGERINI MC-RF	17	27	
FIN119CV	451.25	RUGGERINI RD	18	63	
FIN119CV	451.25	RUGGERINI MD	19	33	
FIN1200NF	359.117	ACME ADN 37	16	18	
FIN1200NF	359.117	ACME ADN 45	16	26	
FIN1201NF	359.137	ACME ADN 37 W	16	20	
FIN1201NF	359.137	ACME ADN 43	16	22	
FIN1201NF	359.137	ACME ADN 43 W	16	24	
FIN1201NF	359.137	ACME ADN 45	16	28	
FIN1201NF	359.137	ACME ADN 45 W	16	30	
FIN1201NF	359.137	ACME ADN 48	16	34	
FIN1201NF	359.137	ACME ADN 48 W	16	36	
FIN1201NF	359.137	ACME ADN 54	16	40	
FIN1201NF	359.137	ACME ADN 54 W	16	42	
FIN1201NF	359.137	ACME ADN 60	16	46	
FIN1201NF	359.137	ACME ADN 60 W	16	48	
FIN1218NF	359.116	ACME ALN 290 W	16	2	
FIN1218NF	359.116	ACME ALN 330 W	16	4	
FIN1225E	6578.135	SLANZI DVA 1030 S	15	10	
FIN1225E	6578.135	SLANZI DVA 1550	15	12	
FIN1225E	6578.135	SLANZI DVA 1550 S	15	14	
FIN1225E	6578.135	SLANZI DVA 460	15	2	
FIN1225E	6578.135	SLANZI DVA 1200	15	20	
FIN1225E	6578.135	SLANZI DVA 1750	15	22	
FIN1225E	6578.135	SLANZI DVA 1750 S	15	24	
FIN1225E	6578.135	SLANZI DVA 2350	15	26	
FIN1225E	6578.135	SLANZI DVA 1500	15	28	
FIN1225E	6578.135	SLANZI DVA 920	15	4	
FIN1225E	6578.135	SLANZI DVA 515	15	6	
FIN1225E	6578.135	SLANZI DVA 1030	15	8	
FIN1226NF	359.144	ACME ADX 300	16	50	
FIN1226NF	359.144	ACME ADX 370	16	52	
FIN1226NF	359.144	ACME ADX 600	16	54	
FIN1226NF	359.144	ACME ADX 740	16	56	
FIN1226NF	359.144	ACME ADX 742	16	58	
FIN134CR STD	316.126	ACME ADN 45	16	27	
FIN134CR STD	316.126	ACME ADN 45 W	16	29	
FIN134CR STD	316.126	ACME ADN 48	16	33	
FIN134CR STD	316.126	ACME ADN 48 W	16	35	
FIN134CR STD	316.126	ACME ADN 54	16	39	
FIN134CR STD	316.126	ACME ADN 54 W	16	41	
FIN134CR STD	316.126	ACME ADN 60	16	45	
FIN134CR STD	316.126	ACME ADN 60 W	16	47	
FIN136PC00	6502.080	INTERMOTOR Benzina Petrol	IM 250	14	1
FIN136PC00	6502.080	INTERMOTOR Benzina Petrol	IM 250	14	3

Tavole di corrispondenza

Cross references

Finimpianti	OEM	Costruttore-Motore <i>Manufacturer-Engine</i>	Cp.	Pg.
FIN136PC00	6502.080	INTERMOTOR Benzina <i>Petrol</i>	IM 252	14 5
FIN136PC00	6502.080	INTERMOTOR Benzina <i>Petrol</i>	IM 252	14 7
FIN136PC05	6502.082	INTERMOTOR Benzina <i>Petrol</i>	IM 250	14 1
FIN136PC05	6502.082	INTERMOTOR Benzina <i>Petrol</i>	IM 250	14 3
FIN136PC05	6502.082	INTERMOTOR Benzina <i>Petrol</i>	IM 252	14 5
FIN136PC05	6502.082	INTERMOTOR Benzina <i>Petrol</i>	IM 252	14 7
FIN136PC10	6502.083	INTERMOTOR Benzina <i>Petrol</i>	IM 250	14 1
FIN136PC10	6502.083	INTERMOTOR Benzina <i>Petrol</i>	IM 250	14 3
FIN136PC10	6502.083	INTERMOTOR Benzina <i>Petrol</i>	IM 252	14 5
FIN136PC10	6502.083	INTERMOTOR Benzina <i>Petrol</i>	IM 252	14 7
FIN137PC00	6500.099	INTERMOTOR Benzina <i>Petrol</i>	LA 250	14 29
FIN137PC00	6500.099	INTERMOTOR Benzina <i>Petrol</i>	LAP 250	14 31
FIN137PC05	6501.049	INTERMOTOR Benzina <i>Petrol</i>	LA 250	14 29
FIN137PC05	6501.049	INTERMOTOR Benzina <i>Petrol</i>	LAP 250	14 31
FIN137PC10	6501.050	INTERMOTOR Benzina <i>Petrol</i>	LA 250	14 29
FIN137PC10	6501.050	INTERMOTOR Benzina <i>Petrol</i>	LAP 250	14 31
FIN138PC00	6502.015	INTERMOTOR Benzina <i>Petrol</i>	IM 300	14 11
FIN138PC00	6502.015	INTERMOTOR Benzina <i>Petrol</i>	IM 302	14 13
FIN138PC00	6502.015	INTERMOTOR Benzina <i>Petrol</i>	IM 302	14 15
FIN138PC00	6502.015	INTERMOTOR Benzina <i>Petrol</i>	LA 300	14 33
FIN138PC00	6502.015	INTERMOTOR Benzina <i>Petrol</i>	LAP 300	14 35
FIN138PC00	6502.015	INTERMOTOR Benzina <i>Petrol</i>	IM 300	14 9
FIN138PC05	6502.016	INTERMOTOR Benzina <i>Petrol</i>	IM 300	14 11
FIN138PC05	6502.016	INTERMOTOR Benzina <i>Petrol</i>	IM 302	14 13
FIN138PC05	6502.016	INTERMOTOR Benzina <i>Petrol</i>	IM 302	14 15
FIN138PC05	6502.016	INTERMOTOR Benzina <i>Petrol</i>	LA 300	14 33
FIN138PC05	6502.016	INTERMOTOR Benzina <i>Petrol</i>	LAP 300	14 35
FIN138PC05	6502.016	INTERMOTOR Benzina <i>Petrol</i>	IM 300	14 9
FIN138PC10	6502.017	INTERMOTOR Benzina <i>Petrol</i>	IM 300	14 11
FIN138PC10	6502.017	INTERMOTOR Benzina <i>Petrol</i>	IM 302	14 13
FIN138PC10	6502.017	INTERMOTOR Benzina <i>Petrol</i>	IM 302	14 15
FIN138PC10	6502.017	INTERMOTOR Benzina <i>Petrol</i>	LA 300	14 33
FIN138PC10	6502.017	INTERMOTOR Benzina <i>Petrol</i>	LAP 300	14 35
FIN138PC10	6502.017	INTERMOTOR Benzina <i>Petrol</i>	IM 300	14 9
FIN140PC00	6502.081	INTERMOTOR Benzina <i>Petrol</i>	IM 350	14 17
FIN140PC00	6502.081	INTERMOTOR Benzina <i>Petrol</i>	IM 350	14 19
FIN140PC00	6502.081	INTERMOTOR Benzina <i>Petrol</i>	IM 352	14 21
FIN140PC00	6502.081	INTERMOTOR Benzina <i>Petrol</i>	IM 352	14 23
FIN140PC00	6502.081	INTERMOTOR Benzina <i>Petrol</i>	IM 359	14 25
FIN140PC00	6502.081	INTERMOTOR Benzina <i>Petrol</i>	IM 359	14 27
FIN140PC05	6502.084	INTERMOTOR Benzina <i>Petrol</i>	IM 350	14 17
FIN140PC05	6502.084	INTERMOTOR Benzina <i>Petrol</i>	IM 350	14 19
FIN140PC05	6502.084	INTERMOTOR Benzina <i>Petrol</i>	IM 352	14 21
FIN140PC05	6502.084	INTERMOTOR Benzina <i>Petrol</i>	IM 352	14 23
FIN140PC05	6502.084	INTERMOTOR Benzina <i>Petrol</i>	IM 359	14 25
FIN140PC05	6502.084	INTERMOTOR Benzina <i>Petrol</i>	IM 359	14 27
FIN140PC10	6502.085	INTERMOTOR Benzina <i>Petrol</i>	IM 350	14 17
FIN140PC10	6502.085	INTERMOTOR Benzina <i>Petrol</i>	IM 350	14 19

Finimpianti	OEM	Costruttore-Motore <i>Manufacturer-Engine</i>	Cp.	Pg.
FIN140PC10	6502.085	INTERMOTOR Benzina <i>Petrol</i>	IM 352	14 21
FIN140PC10	6502.085	INTERMOTOR Benzina <i>Petrol</i>	IM 352	14 23
FIN140PC10	6502.085	INTERMOTOR Benzina <i>Petrol</i>	IM 359	14 25
FIN140PC10	6502.085	INTERMOTOR Benzina <i>Petrol</i>	IM 359	14 27
FIN140VA	014.41	RUGGERINI	RD 188	18 10
FIN140VA	014.41	RUGGERINI	RD 200	18 16
FIN140VA	014.41	RUGGERINI	RD 201	18 18
FIN140VA	014.41	RUGGERINI	RD 208	18 20
FIN140VA	014.41	RUGGERINI	RD 210	18 28
FIN140VA	014.41	RUGGERINI	RD 211	18 30
FIN140VA	014.41	RUGGERINI	RD 218	18 32
FIN140VA	014.41	RUGGERINI	RD 180	18 6
FIN140VA	014.41	RUGGERINI	RD 181	18 8
FIN1412PF	059.167	ACME	ALN 290 W	16 2
FIN1412PF	059.167	ACME	ALN 330 W	16 4
FIN141PB	316.041	ACME	AD 114	16 11
FIN141PB	316.041	ACME	AD 112	16 13
FIN141PB	316.041	ACME	AD 116	16 15
FIN141PB	316.041	ACME	ADN 45	16 25
FIN141PB	316.041	ACME	ADN 45	16 27
FIN141PB	316.041	ACME	ADN 45 W	16 29
FIN141PB	316.041	ACME	ADN 48	16 31
FIN141PB	316.041	ACME	ADN 48	16 33
FIN141PB	316.041	ACME	ADN 48 W	16 35
FIN141PB	316.041	ACME	ADN 54	16 37
FIN141PB	316.041	ACME	ADN 54	16 39
FIN141PB	316.041	ACME	ADN 54 W	16 41
FIN141PB	316.041	ACME	ADN 60	16 43
FIN141PB	316.041	ACME	ADN 60	16 45
FIN141PB	316.041	ACME	ADN 60 W	16 47
FIN141PB	316.041	ACME	AD 108	16 5
FIN141PB	316.041	ACME	AD 110	16 7
FIN141PB	316.041	ACME	AD 114 / A	16 9
FIN141PB	316.41	RUGGERINI	RF 100	17 15
FIN141PB	316.41	RUGGERINI	RF 120	17 17
FIN141PB	316.41	RUGGERINI	RF 121	17 19
FIN141PB	316.41	RUGGERINI	RF 130	17 21
FIN141PB	316.41	RUGGERINI	RF 140	17 23
FIN141PB	316.41	RUGGERINI	RF 148	17 25
FIN141PB	316.41	RUGGERINI	RD 850	18 11
FIN141PB	316.41	RUGGERINI	RD 901/A	18 13
FIN141PB	316.41	RUGGERINI	RD 208	18 19
FIN141PB	316.41	RUGGERINI	RD 900	18 21
FIN141PB	316.41	RUGGERINI	RD 901	18 23
FIN141PB	316.41	RUGGERINI	RD 901/AD	18 25
FIN141PB	316.41	RUGGERINI	RD 220	18 33
FIN141PB	316.41	RUGGERINI	RD 901/2	18 35
FIN141PB	316.41	RUGGERINI	RD 920	18 37
FIN141PB	316.41	RUGGERINI	RD 920 L	18 39
FIN141PB	316.41	RUGGERINI	RD 240	18 41
FIN141PB	316.41	RUGGERINI	RD 248	18 43
FIN141PB	316.41	RUGGERINI	RD 92/2	18 45
FIN141PB	316.41	RUGGERINI	RD 92/2 L	18 47
FIN141PB	316.41	RUGGERINI	RD 950	18 49
FIN141PB	316.41	RUGGERINI	RD 950 L	18 51
FIN141PB	316.41	RUGGERINI	RD 270	18 53
FIN141PB	316.41	RUGGERINI	RD 278	18 55
FIN141PB	316.41	RUGGERINI	RD 952	18 57
FIN141PB	316.41	RUGGERINI	SP 420	18 61
FIN142TL	563.50	RUGGERINI	RF 90	17 12
FIN142TL	563.50	RUGGERINI	RF 91	17 14
FIN142TL	563.50	RUGGERINI	RF 120	17 18
FIN142TL	563.50	RUGGERINI	RF 121	17 20
FIN142TL	563.50	RUGGERINI	RF 140	17 24
FIN142TL	563.50	RUGGERINI	RF 80	17 6
FIN142TL	563.50	RUGGERINI	RF 81	17 8
FIN142TL	5840.142	RUGGERINI	RD 188	18 10
FIN142TL	5840.142	RUGGERINI	RD 200	18 16
FIN142TL	5840.142	RUGGERINI	RD 201	18 18
FIN142TL	5840.142	RUGGERINI	RD 208	18 20
FIN142TL	5840.142	RUGGERINI	RD 210	18 28
FIN142TL	5840.142	RUGGERINI	RD 211	18 30
FIN142TL	5840.142	RUGGERINI	RD 218	18 32
FIN142TL	5840.142	RUGGERINI	RD 180	18 6
FIN142TL	5840.142	RUGGERINI	RD 181	18 8
FIN142TL	5840.142	RUGGERINI	MD 85.0	19 14
FIN142TL	5840.142	RUGGERINI	MD 85.1	19 16
FIN142TL	5840.142	RUGGERINI	MD 95.0	19 18
FIN142TL	5840.142	RUGGERINI	MD 75.0	19 2
FIN142TL	5840.142	RUGGERINI	MD 95.1	19 20
FIN142TL	5840.142	RUGGERINI	MD 75.1	19 4
FIN1448ASA	4845.129	SLANZI	DVA 1550 S	15 13
FIN1448ASA	4845.129	SLANZI	DVA 1550 S	15 13
FIN1448ASA	4845.129	SLANZI	DVA 1200	15 19
FIN1448ASA	4845.129	SLANZI	DVA 1200	15 19
FIN1448ASA	4845.129	SLANZI	DVA 1750	15 21
FIN1448ASA	4845.129	SLANZI	DVA 1750	15 21
FIN1448ASA	4845.129	SLANZI	DVA 1750 S	15 23
FIN1448ASA	4845.129	SLANZI	DVA 1750 S	15 23
FIN1448ASA	4845.129	SLANZI	DVA 2350	15 25

Ricambi non originali per motori. Denominazioni e codici originali, sono riportati a puro titolo di riferimento.

12 - A

rel. 1511

Non original engine parts. OEMs names and part numbers are for reference purpose only.

Tavole di corrispondenza

Cross references

Finimpianti	OEM	Costruttore-Motore <i>Manufacturer-Engine</i>	Cp.	Pg.
FIN1448ASA	4845.129	SLANZI DVA 2350	15	25
FIN1448ASA	4845.129	SLANZI DVA 1030 S	15	9
FIN1448ASA	4845.129	SLANZI DVA 1030 S	15	9
FIN1449ASA	4845.131	SLANZI DVA 1800	15	33
FIN1449ASA	4845.131	SLANZI DVA 1800	15	33
FIN1449ASA	4845.131	SLANZI DVA 2700	15	35
FIN1449ASA	4845.131	SLANZI DVA 2700	15	35
FIN1449ASA	4845.131	SLANZI DVA 3600	15	37
FIN1449ASA	4845.131	SLANZI DVA 3600	15	37
FIN1449ASA	4845.131	SLANZI DS 2000	15	39
FIN1449ASA	4845.131	SLANZI DS 2000	15	39
FIN1449ASA	4845.131	SLANZI DS 3000	15	41
FIN1449ASA	4845.131	SLANZI DS 3000	15	41
FIN1449ASA	4845.131	SLANZI DS 4000	15	43
FIN1449ASA	4845.131	SLANZI DS 4000	15	43
FIN1513PC00	A2407	RUGGERINI RD 901	18	23
FIN1513PC00	A2407	RUGGERINI RD 901/AD	18	25
FIN1513PC00	A2407	RUGGERINI RD 220	18	33
FIN1513PC05	A2408	RUGGERINI RD 901	18	23
FIN1513PC05	A2408	RUGGERINI RD 901/AD	18	25
FIN1513PC05	A2408	RUGGERINI RD 220	18	33
FIN1513PC10	A2409	RUGGERINI RD 901	18	23
FIN1513PC10	A2409	RUGGERINI RD 901/AD	18	25
FIN1513PC10	A2409	RUGGERINI RD 220	18	33
FIN154NO	6531.279	SLANZI DVA 460	15	2
FIN154NO	6531.279	SLANZI DVA 920	15	4
FIN154NO	6531.279	SLANZI DVA 515	15	6
FIN154NO	6531.279	SLANZI DVA 1030	15	8
FIN154RS00	A2685	ACME ADN 60	16	45
FIN154RS00	A2685	ACME ADN 60 W	16	47
FIN155RS00	2153	ACME AD 116	16	15
FIN155RS05	2206	ACME AD 116	16	15
FIN155RS10	2207	ACME AD 116	16	15
FIN161MB STD	0016111600	RUGGERINI RD 290	18	59
FIN1630PC00	0065015380	RUGGERINI RY 50	20	1
FIN1630PC05	0065015390	RUGGERINI RY 50	20	1
FIN1630PC10	0065015400	RUGGERINI RY 50	20	1
FIN1632PC00	0065014870	RUGGERINI RY 75	20	9
FIN1632PC05	0065014880	RUGGERINI RY 75	20	9
FIN1632PC10	0065014890	RUGGERINI RY 75	20	9
FIN1657SA	4845.080	LOMBARDINI Benzina Petrol LGA 184	14	41
FIN1657SA	4845.080	LOMBARDINI Benzina Petrol LKA 184	14	43
FIN1657SA	4845.080	LOMBARDINI Benzina Petrol LGA 225	14	45
FIN1657SA	4845.080	LOMBARDINI Benzina Petrol LKA 225	14	47
FIN1658AA	4845.202	LOMBARDINI Benzina Petrol LGA 184	14	41
FIN1658AA	4845.202	LOMBARDINI Benzina Petrol LKA 184	14	43
FIN1658AA	4845.202	LOMBARDINI Benzina Petrol LGA 225	14	45
FIN1658AA	4845.202	LOMBARDINI Benzina Petrol LKA 225	14	47
FIN165PC00	6501.004	INTERMOTOR Benzina Petrol LAP 490	14	39
FIN165PC05	6501.005	INTERMOTOR Benzina Petrol LAP 490	14	39
FIN165PC10	6501.006	INTERMOTOR Benzina Petrol LAP 490	14	39
FIN1660AA	4845.249	LOMBARDINI Benzina Petrol LGA 226	14	49
FIN1660AA	4845.249	LOMBARDINI Benzina Petrol LKA 226	14	51
FIN1661SA	4845.250	LOMBARDINI Benzina Petrol LGA 226	14	49
FIN1661SA	4845.250	LOMBARDINI Benzina Petrol LKA 226	14	51
FIN166PC00	6500.081	INTERMOTOR Benzina Petrol LA 490	14	37
FIN166PC05	6500.082	INTERMOTOR Benzina Petrol LA 490	14	37
FIN166PC10	6500.083	INTERMOTOR Benzina Petrol LA 490	14	37
FIN1682PC00	0065017690	RUGGERINI RY 103	20	11
FIN1682PC05	0065017700	RUGGERINI RY 103	20	11
FIN1682PC10	0065017710	RUGGERINI RY 103	20	11
FIN1692PC00	6500.589	SLANZI DVA 650	15	15
FIN1692PC05	6500.590	SLANZI DVA 650	15	15
FIN1692PC10	6500.591	SLANZI DVA 650	15	15
FIN171OF	0021751810	RUGGERINI RY 50	20	2
FIN173PC00	0065002720	RUGGERINI RD 290	18	59
FIN173PC00	0065002720	RUGGERINI SP 420	18	61
FIN173PC05	0065002730	RUGGERINI RD 290	18	59
FIN173PC05	0065002730	RUGGERINI SP 420	18	61
FIN173PC10	0065002740	RUGGERINI RD 290	18	59
FIN173PC10	0065002740	RUGGERINI SP 420	18	61
FIN173SL00	0023805460	RUGGERINI RD 290	18	59
FIN173SL00	0023805460	RUGGERINI SP 420	18	61
FIN176NO	644.08	RUGGERINI RP 170 "CIPA"	21	41
FIN176NO	644.11	RUGGERINI RD 920 L	18	40
FIN176NO	644.11	RUGGERINI RD 950 L	18	52

Finimpianti	OEM	Costruttore-Motore <i>Manufacturer-Engine</i>	Cp.	Pg.
FIN176TW STD	060.16	RUGGERINI MD 301	19	11
FIN176TW STD	060.16	RUGGERINI MD 350	19	29
FIN176TW STD	060.16	RUGGERINI MD 351	19	31
FIN176TW STD	060.16	RUGGERINI MD 300	19	9
FIN177TW STD	060.17	RUGGERINI MD 75.0	19	1
FIN177TW STD	060.17	RUGGERINI MD 85.0	19	13
FIN177TW STD	060.17	RUGGERINI MD 85.1	19	15
FIN177TW STD	060.17	RUGGERINI MD 95.0	19	17
FIN177TW STD	060.17	RUGGERINI MD 95.1	19	19
FIN177TW STD	060.17	RUGGERINI MD 170	19	21
FIN177TW STD	060.17	RUGGERINI MD 171	19	23
FIN177TW STD	060.17	RUGGERINI MD 75.1	19	3
FIN178TW STD	060.88	RUGGERINI RY 100	20	13
FIN178TW STD	060.88	RUGGERINI RY 101	20	15
FIN178TW STD	060.88	RUGGERINI RY 120	20	19
FIN178TW STD	060.88	RUGGERINI RY 121	20	21
FIN178TW STD	060.88	RUGGERINI RY 125	20	23
FIN178TW STD	060.88	RUGGERINI RY 85.0	20	5
FIN178TW STD	060.88	RUGGERINI RY 85.1	20	7
FIN179NO	644.46	RUGGERINI RD 220	18	34
FIN179NO	644.46	RUGGERINI RD 901/2	18	36
FIN179NO	644.46	RUGGERINI RD 240	18	42
FIN179NO	644.46	RUGGERINI RD 248	18	44
FIN179NO	644.46	RUGGERINI RD 92/2	18	46
FIN179NO	644.46	RUGGERINI RD 270	18	54
FIN179NO	644.46	RUGGERINI RD 278	18	56
FIN179NO	644.46	RUGGERINI RD 952	18	58
FIN179NO	644.46	RUGGERINI P 101	21	10
FIN179NO	644.46	RUGGERINI P 101 L	21	12
FIN179NO	644.46	RUGGERINI P 101/2	21	14
FIN179NO	644.46	RUGGERINI P 101/2 L	21	16
FIN179NO	644.46	RUGGERINI P 105/2	21	18
FIN179NO	644.46	RUGGERINI CRD 951	21	2
FIN179NO	644.46	RUGGERINI P 105/2 R	21	20
FIN179NO	644.46	RUGGERINI P 105/2 L	21	22
FIN179NO	644.46	RUGGERINI RP 280	21	24
FIN179NO	644.46	RUGGERINI RP 170	21	26
FIN179NO	644.46	RUGGERINI RP 178	21	28
FIN179NO	644.46	RUGGERINI RP 320	21	30
FIN179NO	644.46	RUGGERINI RP 328	21	32
FIN179NO	644.46	RUGGERINI RP 360	21	34
FIN179NO	644.46	RUGGERINI RP 368	21	36
FIN179NO	644.46	RUGGERINI RP 380	21	38
FIN179NO	644.46	RUGGERINI CRD 951/2	21	4
FIN179NO	644.46	RUGGERINI RP 388	21	40
FIN179NO	644.46	RUGGERINI CRD 100	21	6
FIN179NO	644.46	RUGGERINI CRD 100/2	21	8
FIN182PC00	0065012500	RUGGERINI RY 70	20	3
FIN182PC05	0065012510	RUGGERINI RY 70	20	3
FIN182PC10	0065012520	RUGGERINI RY 70	20	3
FIN190PC00	A2077	RUGGERINI MC 70	17	1
FIN190PC00	A2077	RUGGERINI MC 71	17	3
FIN190PC00	A2077	RUGGERINI RF 80	17	5
FIN190PC00	A2077	RUGGERINI RF 81	17	7
FIN190PC00	A2077	RUGGERINI RF 88	17	9
FIN190PC00	B0345	ACME ADN 37 W	16	19
FIN190PC05	A2078	RUGGERINI MC 70	17	1
FIN190PC05	A2078	RUGGERINI MC 71	17	3
FIN190PC05	A2078	RUGGERINI RF 80	17	5
FIN190PC05	A2078	RUGGERINI RF 81	17	7
FIN190PC05	A2078	RUGGERINI RF 88	17	9
FIN190PC05	B0346	ACME ADN 37 W	16	19
FIN190PC10	A2079	RUGGERINI MC 70	17	1
FIN190PC10	A2079	RUGGERINI MC 71	17	3
FIN190PC10	A2079	RUGGERINI RF 80	17	5
FIN190PC10	A2079	RUGGERINI RF 81	17	7
FIN190PC10	A2079	RUGGERINI RF 88	17	9
FIN190PC10	B0347	ACME ADN 37 W	16	19
FIN191PC00	A2098	RUGGERINI MD 75.0	19	1
FIN191PC00	A2098	RUGGERINI MD 75.1	19	3
FIN191PC00	A2128	RUGGERINI MD 150	19	5
FIN191PC00	A2128	RUGGERINI MD 151	19	7
FIN191PC05		RUGGERINI MD 75.0	19	1
FIN191PC05		RUGGERINI MD 75.1	19	3
FIN191PC05		RUGGERINI MD 150	19	5
FIN191PC05		RUGGERINI MD 151	19	7
FIN191PC10		RUGGERINI MD 75.0	19	1
FIN191PC10		RUGGERINI MD 75.1	19	3
FIN191PC10		RUGGERINI MD 150	19	5
FIN191PC10		RUGGERINI MD 151	19	7
FIN192PC00	2130	ACME ADN 48	16	31
FIN192PC00	2130	ACME AD 108	16	5
FIN192PC00	2130	ACME AD 110	16	7
FIN192PC00	2130	ACME AD 114 / A	16	9
FIN192PC00	2130	RUGGERINI RF 100	17	15
FIN192PC00	2130	RUGGERINI RD 850	18	11
FIN192PC00	2130	RUGGERINI RD 901/A	18	13
FIN192PC05	2131	ACME ADN 48	16	31
FIN192PC05	2131	ACME AD 108	16	5
FIN192PC05	2131	ACME AD 110	16	7
FIN192PC05	2131	ACME AD 114 / A	16	9
FIN192PC05	2131	ACME AD 114 / A	16	9
FIN192PC05	2131	RUGGERINI RF 100	17	15
FIN192PC05	2131	RUGGERINI RD 850	18	11
FIN192PC05	2131	RUGGERINI RD 901/A	18	13

Ricambi non originali per motori. Denominazioni e codici originali, sono riportati a puro titolo di riferimento.

Non original engine parts. OEMs names and part numbers are for reference purpose only.

Tavole di corrispondenza

Cross references

Finimpianti	OEM	Costruttore-Motore Manufacturer-Engine	Cp.	Pg.
FIN192PC10	2132	ACME ADN 48	16	31
FIN192PC10	2132	ACME AD 108	16	5
FIN192PC10	2132	ACME AD 110	16	7
FIN192PC10	2132	ACME AD 114 / A	16	9
FIN192PC10	2132	RUGGERINI RF 100	17	15
FIN192PC10	2132	RUGGERINI RD 850	18	11
FIN192PC10	2132	RUGGERINI RD 901/A	18	13
FIN194PC00	2987	RUGGERINI RD 208	18	19
FIN194PC00	A2146	RUGGERINI MD 95.0	19	17
FIN194PC00	A2146	RUGGERINI MD 95.1	19	19
FIN194PC00	A2146	RUGGERINI MD 190	19	25
FIN194PC00	A2146	RUGGERINI MD 191	19	27
FIN194PC00	A2293	RUGGERINI RD 200	18	15
FIN194PC00	A2293	RUGGERINI RD 201	18	17
FIN194PC05	2988	RUGGERINI RD 208	18	19
FIN194PC05	A2147	RUGGERINI RD 200	18	15
FIN194PC05	A2147	RUGGERINI MD 95.0	19	17
FIN194PC05	A2147	RUGGERINI MD 95.1	19	19
FIN194PC05	A2147	RUGGERINI MD 190	19	25
FIN194PC05	A2147	RUGGERINI MD 191	19	27
FIN194PC05	A2148	RUGGERINI RD 201	18	17
FIN194PC10	2989	RUGGERINI RD 208	18	19
FIN194PC10	A2148	RUGGERINI RD 200	18	15
FIN194PC10	A2148	RUGGERINI MD 95.0	19	17
FIN194PC10	A2148	RUGGERINI MD 95.1	19	19
FIN194PC10	A2148	RUGGERINI MD 190	19	25
FIN194PC10	A2148	RUGGERINI MD 191	19	27
FIN194PC10	A2149	RUGGERINI RD 201	18	17
FIN195PC00	2144	ACME AD 114	16	11
FIN195PC00	2144	ACME AD 112	16	13
FIN195PC00	2144	ACME ADN 54	16	37
FIN195PC00	2144	RUGGERINI RD 900	18	21
FIN195PC00	2144	RUGGERINI RD 901/2	18	35
FIN195PC05	2145	ACME AD 114	16	11
FIN195PC05	2145	ACME AD 112	16	13
FIN195PC05	2145	ACME ADN 54	16	37
FIN195PC05	2145	RUGGERINI RD 900	18	21
FIN195PC05	2145	RUGGERINI RD 901/2	18	35
FIN195PC10	2146	ACME AD 114	16	11
FIN195PC10	2146	ACME AD 112	16	13
FIN195PC10	2146	ACME ADN 54	16	37
FIN195PC10	2146	RUGGERINI RD 900	18	21
FIN195PC10	2146	RUGGERINI RD 901/2	18	35
FIN196PC00	A2099	RUGGERINI RF 120	17	17
FIN196PC00	A2099	RUGGERINI RF 121	17	19
FIN196PC05	A2100	RUGGERINI RF 120	17	17
FIN196PC05	A2100	RUGGERINI RF 121	17	19
FIN197PC00	A2153	RUGGERINI RF 90	17	11
FIN197PC00	A2153	RUGGERINI RF 91	17	13
FIN197PC05	A2154	RUGGERINI RF 90	17	11
FIN197PC05	A2154	RUGGERINI RF 91	17	13
FIN197PC10	A2155	RUGGERINI RF 90	17	11
FIN197PC10	A2155	RUGGERINI RF 91	17	13
FIN197PC10	A2155	RUGGERINI RF 120	17	17
FIN197PC10	A2155	RUGGERINI RF 121	17	19
FIN1980SL00	203.85	RUGGERINI MD 301	19	11
FIN1980SL00	203.85	RUGGERINI MD 300	19	9
FIN198PC00	A2063	RUGGERINI RD 210	18	27
FIN198PC00	A2063	RUGGERINI RD 211	18	29
FIN198PC00	A2063	RUGGERINI RD 218	18	31
FIN198PC05	A2064	RUGGERINI RD 210	18	27
FIN198PC05	A2064	RUGGERINI RD 211	18	29
FIN198PC05	A2064	RUGGERINI RD 218	18	31
FIN198PC10	A2065	RUGGERINI RD 210	18	27
FIN198PC10	A2065	RUGGERINI RD 211	18	29
FIN198PC10	A2065	RUGGERINI RD 218	18	31
FIN199PC00	2270	RUGGERINI RD 920	18	37
FIN199PC00	2270	RUGGERINI RD 920 L	18	39
FIN199PC00	2270	RUGGERINI RD 240	18	41
FIN199PC00	2270	RUGGERINI RD 248	18	43
FIN199PC00	2270	RUGGERINI RD 92/2	18	45
FIN199PC00	2270	RUGGERINI RD 92/2 L	18	47
FIN199PC05	2271	RUGGERINI RD 920	18	37
FIN199PC05	2271	RUGGERINI RD 920 L	18	39
FIN199PC05	2271	RUGGERINI RD 240	18	41
FIN199PC05	2271	RUGGERINI RD 248	18	43
FIN199PC05	2271	RUGGERINI RD 92/2	18	45
FIN199PC05	2271	RUGGERINI RD 92/2 L	18	47
FIN199PC10	2272	RUGGERINI RD 920	18	37
FIN199PC10	2272	RUGGERINI RD 920 L	18	39
FIN199PC10	2272	RUGGERINI RD 240	18	41
FIN199PC10	2272	RUGGERINI RD 248	18	43
FIN199PC10	2272	RUGGERINI RD 92/2	18	45
FIN199PC10	2272	RUGGERINI RD 92/2 L	18	47
FIN200PC00	A2103	RUGGERINI RF 130	17	21
FIN200PC05	A2104	RUGGERINI RF 130	17	21
FIN200PC10	A2105	RUGGERINI RF 130	17	21
FIN200PN	854.012	ACME ADN 37	16	17
FIN200PN	854.012	ACME ADN 37 W	16	19
FIN200PN	854.012	ACME ADN 43	16	21
FIN200PN	854.012	ACME ADN 43 W	16	23
FIN200PN	854.012	ACME ADN 45	16	25
FIN200PN	854.012	ACME ADX 370	16	51
FIN200PN	854.012	ACME ADX 740	16	55

Finimpianti	OEM	Costruttore-Motore Manufacturer-Engine	Cp.	Pg.
FIN200PN	854.012	ACME ADX 742	16	57
FIN200PN	854.12	RUGGERINI MC 70	17	1
FIN200PN	854.12	RUGGERINI MC 71	17	3
FIN200PN	854.12	RUGGERINI RF 80	17	5
FIN200PN	854.12	RUGGERINI RF 81	17	7
FIN200PN	854.12	RUGGERINI RF 88	17	9
FIN200PN	854.12	RUGGERINI RD 80	18	1
FIN200PN	854.12	RUGGERINI RD 81	18	3
FIN200PN	854.12	RUGGERINI RD 180	18	5
FIN200PN	854.12	RUGGERINI RD 181	18	7
FIN200PN	854.12	RUGGERINI RD 188	18	9
FIN200PN	854.12	RUGGERINI RY 120	20	19
FIN200PN	854.12	RUGGERINI RY 121	20	21
FIN200PN	854.12	RUGGERINI RY 125	20	23
FIN201AA	464.42	RUGGERINI CRD 951	21	1
FIN201AA	464.42	RUGGERINI P 101 L	21	11
FIN201AA	464.42	RUGGERINI P 101/2	21	13
FIN201AA	464.42	RUGGERINI P 101/2 L	21	15
FIN201AA	464.42	RUGGERINI P 105/2	21	17
FIN201AA	464.42	RUGGERINI P 105/2 R	21	19
FIN201AA	464.42	RUGGERINI P 105/2 L	21	21
FIN201AA	464.42	RUGGERINI RP 200	21	23
FIN201AA	464.42	RUGGERINI RP 170	21	25
FIN201AA	464.42	RUGGERINI RP 178	21	27
FIN201AA	464.42	RUGGERINI RP 320	21	29
FIN201AA	464.42	RUGGERINI CRD 951/2	21	3
FIN201AA	464.42	RUGGERINI RP 328	21	31
FIN201AA	464.42	RUGGERINI RP 360	21	33
FIN201AA	464.42	RUGGERINI RP 368	21	35
FIN201AA	464.42	RUGGERINI RP 380	21	37
FIN201AA	464.42	RUGGERINI RP 388	21	39
FIN201AA	464.42	RUGGERINI CRD 100	21	5
FIN201AA	464.42	RUGGERINI CRD 100/2	21	7
FIN201AA	464.42	RUGGERINI P 101	21	9
FIN201PC00	2170	RUGGERINI CRD 951	21	1
FIN201PC00	2170	RUGGERINI RP 280	21	23
FIN201PC00	2170	RUGGERINI CRD 951/2	21	3
FIN201PC05	2171	RUGGERINI CRD 951	21	1
FIN201PC05	2171	RUGGERINI RP 280	21	23
FIN201PC05	2171	RUGGERINI CRD 951/2	21	3
FIN201PC10	2172	RUGGERINI CRD 951	21	1
FIN201PC10	2172	RUGGERINI RP 280	21	23
FIN201PC10	2172	RUGGERINI CRD 951/2	21	3
FIN201PN	854.17	RUGGERINI RF 90	17	11
FIN201PN	854.17	RUGGERINI RF 91	17	13
FIN201PN	854.17	RUGGERINI RD 200	18	15
FIN201PN	854.17	RUGGERINI RD 201	18	17
FIN201PN	854.17	RUGGERINI RD 208	18	19
FIN201PN	854.17	RUGGERINI RD 210	18	27
FIN201PN	854.17	RUGGERINI RD 211	18	29
FIN201PN	854.17	RUGGERINI RD 218	18	31
FIN201PN	854.17	RUGGERINI MD 301	19	11
FIN201PN	854.17	RUGGERINI MD 85.0	19	13
FIN201PN	854.17	RUGGERINI MD 85.1	19	15
FIN201PN	854.17	RUGGERINI MD 95.0	19	17
FIN201PN	854.17	RUGGERINI MD 95.1	19	19
FIN201PN	854.17	RUGGERINI MD 170	19	21
FIN201PN	854.17	RUGGERINI MD 171	19	23
FIN201PN	854.17	RUGGERINI MD 190	19	25
FIN201PN	854.17	RUGGERINI MD 191	19	27
FIN201PN	854.17	RUGGERINI MD 350	19	29
FIN201PN	854.17	RUGGERINI MD 351	19	31
FIN201PN	854.17	RUGGERINI MD 300	19	9
FIN201PN	854.17	RUGGERINI RY 100	20	13
FIN201PN	854.17	RUGGERINI RY 101	20	15
FIN202PC00	2492	RUGGERINI RD 950	18	49
FIN202PC00	2492	RUGGERINI RD 950 L	18	51
FIN202PC00	2492	RUGGERINI RD 270	18	53
FIN202PC00	2492	RUGGERINI RD 278	18	55
FIN202PC00	2492	RUGGERINI RD 952	18	57
FIN202PC05	2493	RUGGERINI RD 950	18	49
FIN202PC05	2493	RUGGERINI RD 950 L	18	51
FIN202PC05	2493	RUGGERINI RD 270	18	53
FIN202PC05	2493	RUGGERINI RD 278	18	55
FIN202PC05	2493	RUGGERINI RD 952	18	57
FIN202PC10	2494	RUGGERINI RD 950	18	49
FIN202PC10	2494	RUGGERINI RD 950 L	18	51
FIN202PC10	2494	RUGGERINI RD 270	18	53
FIN202PC10	2494	RUGGERINI RD 278	18	55
FIN202PC10	2494	RUGGERINI RD 952	18	57
FIN202PN	854.011	ACME AD 114	16	11
FIN202PN	854.011	ACME AD 112	16	13
FIN202PN	854.011	ACME AD 116	16	15
FIN202PN	854.011	ACME ADN 48	16	31
FIN202PN	854.011	ACME ADN 54	16	37
FIN202PN	854.011	ACME ADN 54	16	39
FIN202PN	854.011	ACME ADN 54 W	16	41
FIN202PN	854.011	ACME ADN 60	16	43
FIN202PN	854.011	ACME ADN 60	16	45
FIN202PN	854.011	ACME ADN 60 W	16	47
FIN202PN	854.011	ACME AD 108	16	5
FIN202PN	854.011	ACME AD 110	16	7
FIN202PN	854.011	ACME AD 114 / A	16	9
FIN202PN	854.11	RUGGERINI RF 100	17	15

Tavole di corrispondenza

Cross references

Finimpianti	OEM	Costruttore-Motore <i>Manufacturer-Engine</i>	Cp.	Pg.
FIN202PN	854.11	RUGGERINI RF 120	17	17
FIN202PN	854.11	RUGGERINI RF 121	17	19
FIN202PN	854.11	RUGGERINI RF 130	17	21
FIN202PN	854.11	RUGGERINI RF 140	17	23
FIN202PN	854.11	RUGGERINI RF 148	17	25
FIN202PN	854.11	RUGGERINI RD 850	18	11
FIN202PN	854.11	RUGGERINI RD 901/A	18	13
FIN202PN	854.11	RUGGERINI RD 900	18	21
FIN202PN	854.11	RUGGERINI RD 901	18	23
FIN202PN	854.11	RUGGERINI RD 901/AD	18	25
FIN202PN	854.11	RUGGERINI RD 220	18	33
FIN202PN	854.11	RUGGERINI RD 901/2	18	35
FIN202PN	854.11	RUGGERINI RD 920	18	37
FIN202PN	854.11	RUGGERINI RD 920 L	18	39
FIN202PN	854.11	RUGGERINI RD 240	18	41
FIN202PN	854.11	RUGGERINI RD 248	18	43
FIN202PN	854.11	RUGGERINI RD 92/2	18	45
FIN202PN	854.11	RUGGERINI RD 92/2 L	18	47
FIN202PN	854.11	RUGGERINI RD 950	18	49
FIN202PN	854.11	RUGGERINI RD 950 L	18	51
FIN202PN	854.11	RUGGERINI RD 270	18	53
FIN202PN	854.11	RUGGERINI RD 278	18	55
FIN202PN	854.11	RUGGERINI RD 952	18	57
FIN202SA	464.41	RUGGERINI CRD 951	21	1
FIN202SA	464.41	RUGGERINI P 101 L	21	11
FIN202SA	464.41	RUGGERINI P 101/2	21	13
FIN202SA	464.41	RUGGERINI P 101/2 L	21	15
FIN202SA	464.41	RUGGERINI P 105/2	21	17
FIN202SA	464.41	RUGGERINI P 105/2 R	21	19
FIN202SA	464.41	RUGGERINI P 105/2 L	21	21
FIN202SA	464.41	RUGGERINI RP 280	21	23
FIN202SA	464.41	RUGGERINI RP 170	21	25
FIN202SA	464.41	RUGGERINI RP 178	21	27
FIN202SA	464.41	RUGGERINI RP 320	21	29
FIN202SA	464.41	RUGGERINI CRD 951/2	21	3
FIN202SA	464.41	RUGGERINI RP 328	21	31
FIN202SA	464.41	RUGGERINI RP 360	21	33
FIN202SA	464.41	RUGGERINI RP 368	21	35
FIN202SA	464.41	RUGGERINI RP 380	21	37
FIN202SA	464.41	RUGGERINI RP 388	21	39
FIN202SA	464.41	RUGGERINI CRD 100	21	5
FIN202SA	464.41	RUGGERINI CRD 100/2	21	7
FIN202SA	464.41	RUGGERINI P 101	21	9
FIN2035KIT		RUGGERINI RD 188	18	10
FIN2035KIT		RUGGERINI RD 180	18	6
FIN2035KIT		RUGGERINI RD 181	18	8
FIN2036KIT	A2286	RUGGERINI MD 300	19	10
FIN2036KIT	A2286	RUGGERINI MD 301	19	12
FIN2038KIT		RUGGERINI P 105/2	21	18
FIN2038KIT		RUGGERINI P 105/2 R	21	20
FIN2038KIT		RUGGERINI P 105/2 L	21	22
FIN2038KIT		RUGGERINI RP 360	21	34
FIN2038KIT		RUGGERINI RP 368	21	36
FIN2038KIT		RUGGERINI RP 380	21	38
FIN2038KIT		RUGGERINI RP 388	21	40
FIN203AA	464.004	ACME AD 114	16	11
FIN203AA	464.004	ACME AD 112	16	13
FIN203AA	464.004	ACME AD 116	16	15
FIN203AA	464.039	ACME ADN 37	16	17
FIN203AA	464.039	ACME ADN 43	16	21
FIN203AA	464.039	ACME ADN 45	16	25
FIN203AA	464.039	ACME ADN 45	16	27
FIN203AA	464.039	ACME ADN 48	16	31
FIN203AA	464.039	ACME ADN 48	16	33
FIN203AA	464.039	ACME ADN 54	16	37
FIN203AA	464.039	ACME ADN 54	16	39
FIN203AA	464.039	ACME ADN 60	16	43
FIN203AA	464.039	ACME ADN 60	16	45
FIN203AA	464.039	ACME AD 108	16	5
FIN203AA	464.039	ACME AD 110	16	7
FIN203AA	464.039	ACME AD 114 / A	16	9
FIN203AA	464.39	RUGGERINI RF 100	17	15
FIN203AA	464.39	RUGGERINI RD 80	18	1
FIN203AA	464.39	RUGGERINI RD 850	18	11
FIN203AA	464.39	RUGGERINI RD 901/A	18	13
FIN203AA	464.39	RUGGERINI RD 900	18	21
FIN203AA	464.39	RUGGERINI RD 901	18	23
FIN203AA	464.39	RUGGERINI RD 901/AD	18	25
FIN203AA	464.39	RUGGERINI RD 81	18	3
FIN203AA	464.39	RUGGERINI RD 901/2	18	35
FIN203AA	464.39	RUGGERINI RD 920	18	37
FIN203AA	464.39	RUGGERINI RD 920 L	18	39
FIN203AA	464.39	RUGGERINI RD 248	18	43
FIN203AA	464.39	RUGGERINI RD 92/2	18	45
FIN203AA	464.39	RUGGERINI RD 92/2 L	18	47
FIN203AA	464.39	RUGGERINI RD 950	18	49
FIN203AA	464.39	RUGGERINI RD 950 L	18	51
FIN203AA	464.39	RUGGERINI RD 952	18	57
FIN203PC00	A2107	RUGGERINI RF 140	17	23
FIN203PC00	A2107	RUGGERINI RF 148	17	25
FIN203PC05	A2108	RUGGERINI RF 140	17	23
FIN203PC05	A2108	RUGGERINI RF 148	17	25
FIN203PC10	A2109	RUGGERINI RF 140	17	23
FIN203PC10	A2109	RUGGERINI RF 148	17	25

Finimpianti	OEM	Costruttore-Motore <i>Manufacturer-Engine</i>	Cp.	Pg.
FIN204PC00	2183	RUGGERINI P 101 L	21	11
FIN204PC00	2183	RUGGERINI P 101/2	21	13
FIN204PC00	2183	RUGGERINI P 101/2 L	21	15
FIN204PC00	2183	RUGGERINI RP 170	21	25
FIN204PC00	2183	RUGGERINI RP 178	21	27
FIN204PC00	2183	RUGGERINI RP 320	21	29
FIN204PC00	2183	RUGGERINI RP 328	21	31
FIN204PC00	2183	RUGGERINI CRD 100	21	5
FIN204PC00	2183	RUGGERINI CRD 100/2	21	7
FIN204PC00	2183	RUGGERINI P 101	21	9
FIN204PC05	2184	RUGGERINI P 101 L	21	11
FIN204PC05	2184	RUGGERINI P 101/2	21	13
FIN204PC05	2184	RUGGERINI P 101/2 L	21	15
FIN204PC05	2184	RUGGERINI RP 170	21	25
FIN204PC05	2184	RUGGERINI RP 178	21	27
FIN204PC05	2184	RUGGERINI RP 320	21	29
FIN204PC05	2184	RUGGERINI RP 328	21	31
FIN204PC05	2184	RUGGERINI CRD 100	21	5
FIN204PC05	2184	RUGGERINI CRD 100/2	21	7
FIN204PC05	2184	RUGGERINI P 101	21	9
FIN204PC10	2185	RUGGERINI P 101 L	21	11
FIN204PC10	2185	RUGGERINI P 101/2	21	13
FIN204PC10	2185	RUGGERINI P 101/2 L	21	15
FIN204PC10	2185	RUGGERINI RP 170	21	25
FIN204PC10	2185	RUGGERINI RP 178	21	27
FIN204PC10	2185	RUGGERINI RP 320	21	29
FIN204PC10	2185	RUGGERINI RP 328	21	31
FIN204PC10	2185	RUGGERINI CRD 100	21	5
FIN204PC10	2185	RUGGERINI CRD 100/2	21	7
FIN204PC10	2185	RUGGERINI P 101	21	9
FIN204SA	464.007	ACME AD 114	16	11
FIN204SA	464.007	ACME AD 112	16	13
FIN204SA	464.007	ACME AD 116	16	15
FIN204SA	464.040	ACME ADN 37	16	17
FIN204SA	464.040	ACME ADN 43	16	21
FIN204SA	464.040	ACME ADN 45	16	25
FIN204SA	464.040	ACME ADN 45	16	27
FIN204SA	464.040	ACME ADN 48	16	31
FIN204SA	464.040	ACME ADN 48	16	33
FIN204SA	464.040	ACME ADN 54	16	37
FIN204SA	464.040	ACME ADN 54	16	39
FIN204SA	464.040	ACME ADN 60	16	43
FIN204SA	464.040	ACME ADN 60	16	45
FIN204SA	464.040	ACME AD 108	16	5
FIN204SA	464.040	ACME AD 110	16	7
FIN204SA	464.040	ACME AD 114 / A	16	9
FIN204SA	464.40	RUGGERINI RF 100	17	15
FIN204SA	464.40	RUGGERINI RD 80	18	1
FIN204SA	464.40	RUGGERINI RD 850	18	11
FIN204SA	464.40	RUGGERINI RD 901/A	18	13
FIN204SA	464.40	RUGGERINI RD 900	18	21
FIN204SA	464.40	RUGGERINI RD 901	18	23
FIN204SA	464.40	RUGGERINI RD 901/AD	18	25
FIN204SA	464.40	RUGGERINI RD 81	18	3
FIN204SA	464.40	RUGGERINI RD 901/2	18	35
FIN204SA	464.40	RUGGERINI RD 920	18	37
FIN204SA	464.40	RUGGERINI RD 920 L	18	39
FIN204SA	464.40	RUGGERINI RD 248	18	43
FIN204SA	464.40	RUGGERINI RD 92/2	18	45
FIN204SA	464.40	RUGGERINI RD 92/2 L	18	47
FIN204SA	464.40	RUGGERINI RD 950	18	49
FIN204SA	464.40	RUGGERINI RD 950 L	18	51
FIN204SA	464.40	RUGGERINI RD 952	18	57
FIN2055KIT		SLANZI DVA 1750	15	22
FIN2055KIT		SLANZI DVA 1750 S	15	24
FIN2055KIT		SLANZI DVA 2350	15	26
FIN205PC00	2347	RUGGERINI P 105/2	21	17
FIN205PC00	2347	RUGGERINI P 105/2 R	21	19
FIN205PC00	2347	RUGGERINI P 105/2 L	21	21
FIN205PC00	2347	RUGGERINI RP 360	21	33
FIN205PC00	2347	RUGGERINI RP 368	21	35
FIN205PC00	2347	RUGGERINI RP 380	21	37
FIN205PC00	2347	RUGGERINI RP 388	21	39
FIN205PC05	2348	RUGGERINI P 105/2	21	17
FIN205PC05	2348	RUGGERINI P 105/2 R	21	19
FIN205PC05	2348	RUGGERINI P 105/2 L	21	21
FIN205PC05	2348	RUGGERINI RP 360	21	33
FIN205PC05	2348	RUGGERINI RP 368	21	35
FIN205PC05	2348	RUGGERINI RP 380	21	37
FIN205PC05	2348	RUGGERINI RP 388	21	39
FIN205PC10	2349	RUGGERINI P 105/2	21	17
FIN205PC10	2349	RUGGERINI P 105/2 R	21	19
FIN205PC10	2349	RUGGERINI P 105/2 L	21	21
FIN205PC10	2349	RUGGERINI RP 360	21	33
FIN205PC10	2349	RUGGERINI RP 368	21	35
FIN205PC10	2349	RUGGERINI RP 380	21	37
FIN205PC10	2349	RUGGERINI RP 388	21	39
FIN2063KIT		SLANZI DVA 1200	15	20
FIN206CO	447.076	ACME AD 114 / A	16	10
FIN206CO	447.076	ACME AD 114	16	12
FIN206CO	447.076	ACME AD 112	16	14
FIN206CO	447.076	ACME AD 116	16	16
FIN206CO	447.076	ACME ADN 37	16	18
FIN206CO	447.076	ACME ADN 37 W	16	20

Ricambi non originali per motori. Denominazioni e codici originali, sono riportati a puro titolo di riferimento.

Tavole di corrispondenza

Cross references

Finimpianti	OEM	Costruttore-Motore <i>Manufacturer-Engine</i>	Cp.	Pg.
FIN206CO	447.076	ACME ADN 43	16	22
FIN206CO	447.076	ACME ADN 43 W	16	24
FIN206CO	447.076	ACME ADN 45	16	26
FIN206CO	447.076	ACME ADN 45	16	28
FIN206CO	447.076	ACME ADN 45 W	16	30
FIN206CO	447.076	ACME ADN 48	16	32
FIN206CO	447.076	ACME ADN 48	16	34
FIN206CO	447.076	ACME ADN 48 W	16	36
FIN206CO	447.076	ACME ADN 54	16	38
FIN206CO	447.076	ACME ADN 54	16	40
FIN206CO	447.076	ACME ADN 54 W	16	42
FIN206CO	447.076	ACME ADN 60	16	44
FIN206CO	447.076	ACME ADN 60	16	46
FIN206CO	447.076	ACME ADN 60 W	16	48
FIN206CO	447.076	ACME AD 108	16	6
FIN206CO	447.076	ACME AD 110	16	8
FIN206CO	447.76	RUGGERINI RF 88	17	10
FIN206CO	447.76	RUGGERINI RF 90	17	12
FIN206CO	447.76	RUGGERINI RF 91	17	14
FIN206CO	447.76	RUGGERINI RF 100	17	16
FIN206CO	447.76	RUGGERINI RF 120	17	18
FIN206CO	447.76	RUGGERINI MC 70	17	2
FIN206CO	447.76	RUGGERINI RF 121	17	20
FIN206CO	447.76	RUGGERINI RF 130	17	22
FIN206CO	447.76	RUGGERINI RF 140	17	24
FIN206CO	447.76	RUGGERINI RF 148	17	26
FIN206CO	447.76	RUGGERINI MC 71	17	4
FIN206CO	447.76	RUGGERINI RF 80	17	6
FIN206CO	447.76	RUGGERINI RF 81	17	8
FIN206CO	447.76	RUGGERINI RD 850	18	12
FIN206CO	447.76	RUGGERINI RD 901/A	18	14
FIN206CO	447.76	RUGGERINI RD 80	18	2
FIN206CO	447.76	RUGGERINI RD 900	18	22
FIN206CO	447.76	RUGGERINI RD 901	18	24
FIN206CO	447.76	RUGGERINI RD 901/AD	18	26
FIN206CO	447.76	RUGGERINI RD 920	18	38
FIN206CO	447.76	RUGGERINI RD 81	18	4
FIN206CO	447.76	RUGGERINI RD 920 L	18	40
FIN206CO	447.76	RUGGERINI RD 950	18	50
FIN206CO	447.76	RUGGERINI RD 950 L	18	52
FIN207CO	448.15	RUGGERINI P 101	21	10
FIN207CO	448.15	RUGGERINI P 101 L	21	12
FIN207CO	448.15	RUGGERINI CRD 951	21	2
FIN207CO	448.15	RUGGERINI RP 170	21	26
FIN207CO	448.15	RUGGERINI RP 178	21	28
FIN207CO	448.15	RUGGERINI CRD 100	21	6
FIN2083KIT		RUGGERINI RD 290	18	60
FIN2083KIT		RUGGERINI SP 420	18	62
FIN208ASA	464.47	RUGGERINI RD 208	18	19
FIN208ASA	464.47	RUGGERINI RD 208	18	19
FIN208ASA	464.47	RUGGERINI RD 180	18	5
FIN208ASA	464.47	RUGGERINI RD 181	18	7
FIN208ASA	464.47	RUGGERINI RD 188	18	9
FIN208ASA	464.56	RUGGERINI MD 75.0	19	1
FIN208ASA	464.56	RUGGERINI MD 75.0	19	1
FIN208ASA	464.56	RUGGERINI MD 301	19	11
FIN208ASA	464.56	RUGGERINI MD 301	19	11
FIN208ASA	464.56	RUGGERINI MD 85.0	19	13
FIN208ASA	464.56	RUGGERINI MD 85.0	19	13
FIN208ASA	464.56	RUGGERINI MD 85.1	19	15
FIN208ASA	464.56	RUGGERINI MD 85.1	19	15
FIN208ASA	464.56	RUGGERINI MD 95.0	19	17
FIN208ASA	464.56	RUGGERINI MD 95.0	19	17
FIN208ASA	464.56	RUGGERINI MD 95.1	19	19
FIN208ASA	464.56	RUGGERINI MD 95.1	19	19
FIN208ASA	464.56	RUGGERINI MD 95.1	19	19
FIN208ASA	464.56	RUGGERINI MD 170	19	21
FIN208ASA	464.56	RUGGERINI MD 170	19	21
FIN208ASA	464.56	RUGGERINI MD 171	19	23
FIN208ASA	464.56	RUGGERINI MD 171	19	23
FIN208ASA	464.56	RUGGERINI MD 190	19	25
FIN208ASA	464.56	RUGGERINI MD 190	19	25
FIN208ASA	464.56	RUGGERINI MD 191	19	27
FIN208ASA	464.56	RUGGERINI MD 191	19	27
FIN208ASA	464.56	RUGGERINI MD 350	19	29
FIN208ASA	464.56	RUGGERINI MD 350	19	29
FIN208ASA	464.56	RUGGERINI MD 75.1	19	3
FIN208ASA	464.56	RUGGERINI MD 75.1	19	3
FIN208ASA	464.56	RUGGERINI MD 351	19	31
FIN208ASA	464.56	RUGGERINI MD 351	19	31
FIN208ASA	464.56	RUGGERINI MD 150	19	5
FIN208ASA	464.56	RUGGERINI MD 150	19	5
FIN208ASA	464.56	RUGGERINI MD 151	19	7
FIN208ASA	464.56	RUGGERINI MD 151	19	7
FIN208ASA	464.56	RUGGERINI MD 300	19	9
FIN208ASA	464.56	RUGGERINI MD 300	19	9
FIN208ASA	464.77	RUGGERINI RF 90	17	11
FIN208ASA	464.77	RUGGERINI RF 90	17	11
FIN208ASA	464.77	RUGGERINI RF 91	17	13
FIN208ASA	464.77	RUGGERINI RF 91	17	13
FIN208ASA	464.77	RUGGERINI RF 120	17	17
FIN208ASA	464.77	RUGGERINI RF 120	17	17
FIN208ASA	464.77	RUGGERINI RF 121	17	19
FIN208ASA	464.77	RUGGERINI RF 121	17	19
FIN208ASA	464.77	RUGGERINI RF 121	17	19
FIN208ASA	464.77	RUGGERINI RF 130	17	21

Finimpianti	OEM	Costruttore-Motore <i>Manufacturer-Engine</i>	Cp.	Pg.
FIN208ASA	464.77	RUGGERINI RF 130	17	21
FIN208ASA	464.77	RUGGERINI RF 140	17	23
FIN208ASA	464.77	RUGGERINI RF 140	17	23
FIN208ASA	464.77	RUGGERINI RF 148	17	25
FIN208ASA	464.77	RUGGERINI RF 148	17	25
FIN208ASA	464.77	RUGGERINI RF 80	17	5
FIN208ASA	464.77	RUGGERINI RF 80	17	5
FIN208ASA	464.77	RUGGERINI RF 81	17	7
FIN208ASA	464.77	RUGGERINI RF 81	17	7
FIN208ASA	464.77	RUGGERINI RF 88	17	9
FIN208ASA	464.77	RUGGERINI RF 88	17	9
FIN208ASA	464.77	RUGGERINI RD 200	18	15
FIN208ASA	464.77	RUGGERINI RD 200	18	15
FIN208ASA	464.77	RUGGERINI RD 201	18	17
FIN208ASA	464.77	RUGGERINI RD 201	18	17
FIN208ASA	464.77	RUGGERINI RD 210	18	27
FIN208ASA	464.77	RUGGERINI RD 210	18	27
FIN208ASA	464.77	RUGGERINI RD 211	18	29
FIN208ASA	464.77	RUGGERINI RD 211	18	29
FIN208ASA	464.77	RUGGERINI RD 218	18	31
FIN208ASA	464.77	RUGGERINI RD 218	18	31
FIN208ASA	464.77	RUGGERINI RD 180	18	5
FIN208ASA	464.77	RUGGERINI RD 181	18	7
FIN208ASA	464.77	RUGGERINI RD 188	18	9
FIN208ASA	464.77	RUGGERINI RY 100	20	13
FIN208ASA	464.77	RUGGERINI RY 100	20	13
FIN208ASA	464.77	RUGGERINI RY 101	20	15
FIN208ASA	464.77	RUGGERINI RY 101	20	15
FIN208ASA	464.77	RUGGERINI RY 120	20	19
FIN208ASA	464.77	RUGGERINI RY 120	20	19
FIN208ASA	464.77	RUGGERINI RY 121	20	21
FIN208ASA	464.77	RUGGERINI RY 121	20	21
FIN208ASA	464.77	RUGGERINI RY 125	20	23
FIN208ASA	464.77	RUGGERINI RY 125	20	23
FIN208ASA	464.77	RUGGERINI RY 85.0	20	5
FIN208ASA	464.77	RUGGERINI RY 85.0	20	5
FIN208ASA	464.77	RUGGERINI RY 85.1	20	7
FIN208ASA	464.77	RUGGERINI RY 85.1	20	7
FIN208CO	447.73	RUGGERINI P 101/2	21	14
FIN208CO	447.73	RUGGERINI P 101/2 L	21	16
FIN208CO	447.73	RUGGERINI P 105/2	21	18
FIN208CO	447.73	RUGGERINI P 105/2 R	21	20
FIN208CO	447.73	RUGGERINI P 105/2 L	21	22
FIN208CO	447.73	RUGGERINI RP 280	21	24
FIN208CO	447.73	RUGGERINI RP 320	21	30
FIN208CO	447.73	RUGGERINI RP 328	21	32
FIN208CO	447.73	RUGGERINI RP 360	21	34
FIN208CO	447.73	RUGGERINI RP 368	21	36
FIN208CO	447.73	RUGGERINI RP 380	21	38
FIN208CO	447.73	RUGGERINI CRD 951/2	21	4
FIN208CO	447.73	RUGGERINI RP 388	21	40
FIN208CO	447.73	RUGGERINI CRD 100/2	21	8
FIN209CO	4601.064	SLANZI DVA 1030 S	15	10
FIN209CO	4601.064	SLANZI DVA 1200	15	20
FIN209CO	4601.064	SLANZI DVA 920	15	4
FIN209CO	4601.064	SLANZI DVA 1030	15	8
FIN210CO	4601.071	SLANZI DVA 1500	15	28
FIN210PN	854.10	RUGGERINI CRD 951	21	1
FIN210PN	854.10	RUGGERINI P 101 L	21	11
FIN210PN	854.10	RUGGERINI P 101/2	21	13
FIN210PN	854.10	RUGGERINI P 101/2 L	21	15
FIN210PN	854.10	RUGGERINI P 105/2	21	17
FIN210PN	854.10	RUGGERINI P 105/2 R	21	19
FIN210PN	854.10	RUGGERINI P 105/2 L	21	21
FIN210PN	854.10	RUGGERINI RP 280	21	23
FIN210PN	854.10	RUGGERINI RP 170	21	25
FIN210PN	854.10	RUGGERINI RP 178	21	27
FIN210PN	854.10	RUGGERINI RP 320	21	29
FIN210PN	854.10	RUGGERINI CRD 951/2	21	3
FIN210PN	854.10	RUGGERINI RP 328	21	31
FIN210PN	854.10	RUGGERINI RP 360	21	33
FIN210PN	854.10	RUGGERINI RP 368	21	35
FIN210PN	854.10	RUGGERINI RP 380	21	37
FIN210PN	854.10	RUGGERINI RP 388	21	39
FIN210PN	854.10	RUGGERINI CRD 100	21	5
FIN210PN	854.10	RUGGERINI CRD 100/2	21	7
FIN210PN	854.10	RUGGERINI P 101	21	9
FIN211CO	451.32	RUGGERINI MD 85.0	19	14
FIN211CO	451.32	RUGGERINI MD 85.1	19	16
FIN211CO	451.32	RUGGERINI MD 95.0	19	18
FIN211CO	451.32	RUGGERINI MD 75.0	19	2
FIN211CO	451.32	RUGGERINI MD 95.1	19	20
FIN211CO	451.32	RUGGERINI MD 75.1	19	4
FIN2130KIT		RUGGERINI RD 200	18	16
FIN2130KIT		RUGGERINI RD 201	18	18
FIN2130KIT		RUGGERINI RD 208	18	20
FIN2131KIT		RUGGERINI RD 220	18	34
FIN2132KIT	A2398	RUGGERINI RD 210	18	28
FIN2132KIT	A2398	RUGGERINI RD 211	18	30
FIN2132KIT	A2398	RUGGERINI RD 218	18	32
FIN2134KIT		RUGGERINI RD 270	18	54
FIN2134KIT		RUGGERINI RD 278	18	56
FIN2134KIT		RUGGERINI RD 952	18	58
FIN2146KIT		SLANZI DVA 1500	15	28

Ricambi non originali per motori. Denominazioni e codici originali, sono riportati a puro titolo di riferimento.

16 - A

rel. 1511

Non original engine parts. OEMs names and part numbers are for reference purpose only.

Tavole di corrispondenza

Cross references

Finimpianti	OEM	Costruttore-Motore Manufacturer-Engine	Cp.	Pg.
FIN2146KIT		SLANZI DVA 2200	15	30
FIN2146KIT		SLANZI DVA 2900	15	32
FIN2147KIT		SLANZI DS 2000	15	40
FIN2147KIT		SLANZI DS 3000	15	42
FIN2147KIT		SLANZI DS 4000	15	44
FIN2182SM	2398	RUGGERINI RP 280	21	24
FIN2182SM	2398	RUGGERINI CRD 951/2	21	4
FIN2208AF	387.039	ACME AD 114 / A	16	10
FIN2208AF	387.039	ACME AD 114	16	12
FIN2208AF	387.039	ACME AD 112	16	14
FIN2208AF	387.039	ACME AD 116	16	16
FIN2208AF	387.039	ACME ADN 48	16	32
FIN2208AF	387.039	ACME ADN 54	16	38
FIN2208AF	387.039	ACME ADN 60	16	44
FIN2208AF	387.039	ACME AD 108	16	6
FIN2208AF	387.039	ACME AD 110	16	8
FIN2208AF	387.39	RUGGERINI RD 850	18	12
FIN2208AF	387.39	RUGGERINI RD 901/A	18	14
FIN2208AF	387.39	RUGGERINI RD 80	18	2
FIN2208AF	387.39	RUGGERINI RD 900	18	22
FIN2208AF	387.39	RUGGERINI RD 901	18	24
FIN2208AF	387.39	RUGGERINI RD 901/AD	18	26
FIN2208AF	387.39	RUGGERINI RD 920	18	38
FIN2208AF	387.39	RUGGERINI RD 81	18	4
FIN2208AF	387.39	RUGGERINI RD 920 L	18	40
FIN220CO	451.17	RUGGERINI MD 300	19	10
FIN220CO	451.17	RUGGERINI MD 301	19	12
FIN220CO	451.17	RUGGERINI MD 350	19	30
FIN220CO	451.17	RUGGERINI MD 351	19	32
FIN220TL	563.61	RUGGERINI MD 300	19	10
FIN220TL	563.61	RUGGERINI MD 301	19	12
FIN220TL	563.61	RUGGERINI MD 350	19	30
FIN220TL	563.61	RUGGERINI MD 351	19	32
FIN2210AF	388.36	RUGGERINI MC 70	17	2
FIN2210AF	388.36	RUGGERINI MC 71	17	4
FIN2212AF	387.92	RUGGERINI RF 100	17	16
FIN2214AF	387.56	RUGGERINI RD 950	18	50
FIN2214AF	387.56	RUGGERINI RD 950 L	18	52
FIN221CO	448.86	RUGGERINI RD 188	18	10
FIN221CO	448.86	RUGGERINI RD 200	18	16
FIN221CO	448.86	RUGGERINI RD 201	18	18
FIN221CO	448.86	RUGGERINI RD 208	18	20
FIN221CO	448.86	RUGGERINI RD 210	18	28
FIN221CO	448.86	RUGGERINI RD 211	18	30
FIN221CO	448.86	RUGGERINI RD 218	18	32
FIN221CO	448.86	RUGGERINI RD 220	18	34
FIN221CO	448.86	RUGGERINI RD 901/2	18	36
FIN221CO	448.86	RUGGERINI RD 240	18	42
FIN221CO	448.86	RUGGERINI RD 248	18	44
FIN221CO	448.86	RUGGERINI RD 92/2	18	46
FIN221CO	448.86	RUGGERINI RD 92/2 L	18	48
FIN221CO	448.86	RUGGERINI RD 270	18	54
FIN221CO	448.86	RUGGERINI RD 278	18	56
FIN221CO	448.86	RUGGERINI RD 952	18	58
FIN221CO	448.86	RUGGERINI RD 180	18	6
FIN221CO	448.86	RUGGERINI RD 181	18	8
FIN221JP	656.28	RUGGERINI RD 188	18	10
FIN221JP	656.28	RUGGERINI RD 200	18	16
FIN221JP	656.28	RUGGERINI RD 201	18	18
FIN221JP	656.28	RUGGERINI RD 208	18	20
FIN221JP	656.28	RUGGERINI RD 210	18	28
FIN221JP	656.28	RUGGERINI RD 211	18	30
FIN221JP	656.28	RUGGERINI RD 218	18	32
FIN221JP	656.28	RUGGERINI RD 180	18	6
FIN221JP	656.28	RUGGERINI RD 181	18	8
FIN221PC00	6500.609	SLANZI DVA 680	15	17
FIN221PC05	6500.610	SLANZI DVA 680	15	17
FIN221PC10	6500.611	SLANZI DVA 680	15	17
FIN2220AF	387.62	RUGGERINI P 101	21	10
FIN2220AF	387.62	RUGGERINI P 101 L	21	12
FIN2220AF	387.62	RUGGERINI P 101/2	21	14
FIN2220AF	387.62	RUGGERINI P 101/2 L	21	16
FIN2220AF	387.62	RUGGERINI P 105/2	21	18
FIN2220AF	387.62	RUGGERINI CRD 951	21	2
FIN2220AF	387.62	RUGGERINI P 105/2 R	21	20
FIN2220AF	387.62	RUGGERINI P 105/2 L	21	22
FIN2220AF	387.62	RUGGERINI RP 280	21	24
FIN2220AF	387.62	RUGGERINI RP 170	21	26
FIN2220AF	387.62	RUGGERINI RP 178	21	28
FIN2220AF	387.62	RUGGERINI RP 320	21	30
FIN2220AF	387.62	RUGGERINI RP 328	21	32
FIN2220AF	387.62	RUGGERINI RP 360	21	34
FIN2220AF	387.62	RUGGERINI RP 368	21	36
FIN2220AF	387.62	RUGGERINI RP 380	21	38
FIN2220AF	387.62	RUGGERINI CRD 951/2	21	4
FIN2220AF	387.62	RUGGERINI RP 388	21	40
FIN2220AF	387.62	RUGGERINI CRD 100	21	6
FIN2220AF	387.62	RUGGERINI CRD 100/2	21	8
FIN222PC00	6500.546	SLANZI DVA 1550	15	11
FIN222PC00	6500.546	SLANZI DVA 515	15	5
FIN222PC00	6500.546	SLANZI DVA 1030	15	7
FIN222PC05	6500.547	SLANZI DVA 1550	15	11
FIN222PC05	6500.547	SLANZI DVA 515	15	5
FIN222PC05	6500.547	SLANZI DVA 1030	15	7

Finimpianti	OEM	Costruttore-Motore Manufacturer-Engine	Cp.	Pg.
FIN222PC10	6500.686	SLANZI DVA 1550	15	11
FIN222PC10	6500.686	SLANZI DVA 515	15	5
FIN222PC10	6500.686	SLANZI DVA 1030	15	7
FIN223JP	656.29	RUGGERINI RD 220	18	34
FIN223JP	656.29	RUGGERINI RD 901/2	18	36
FIN223JP	656.29	RUGGERINI RD 240	18	42
FIN223JP	656.29	RUGGERINI RD 248	18	44
FIN223JP	656.29	RUGGERINI RD 92/2	18	46
FIN223JP	656.29	RUGGERINI RD 270	18	54
FIN223JP	656.29	RUGGERINI RD 952	18	58
FIN223PC00	6500.548	SLANZI DVA 1200	15	19
FIN223PC00	6500.548	SLANZI DVA 1750	15	21
FIN223PC00	6500.548	SLANZI DVA 1750 S	15	23
FIN223PC00	6500.548	SLANZI DVA 2350	15	25
FIN223PC05	6500.549	SLANZI DVA 1200	15	19
FIN223PC05	6500.549	SLANZI DVA 1750	15	21
FIN223PC05	6500.549	SLANZI DVA 1750 S	15	23
FIN223PC05	6500.549	SLANZI DVA 2350	15	25
FIN223PC10	6500.690	SLANZI DVA 1200	15	19
FIN223PC10	6500.690	SLANZI DVA 1750	15	21
FIN223PC10	6500.690	SLANZI DVA 1750 S	15	23
FIN223PC10	6500.690	SLANZI DVA 2350	15	25
FIN223SL00	2380.307	SLANZI DVA 1200	15	19
FIN223SL00	2380.307	SLANZI DVA 1750	15	21
FIN223SL00	2380.307	SLANZI DVA 1750 S	15	23
FIN223SL00	2380.307	SLANZI DVA 2350	15	25
FIN225PC00	6500.621	SLANZI DVA 1800	15	33
FIN225PC00	6500.621	SLANZI DVA 2700	15	35
FIN225PC00	6500.621	SLANZI DVA 3600	15	37
FIN225PC05	6500.622	SLANZI DVA 1800	15	33
FIN225PC05	6500.622	SLANZI DVA 2700	15	35
FIN225PC05	6500.622	SLANZI DVA 3600	15	37
FIN225PC10		SLANZI DVA 1800	15	33
FIN225PC10		SLANZI DVA 2700	15	35
FIN225PC10		SLANZI DVA 3600	15	37
FIN225TL	5840.089	RUGGERINI RD 220	18	34
FIN225TL	5840.089	RUGGERINI RD 901/2	18	36
FIN225TL	5840.089	RUGGERINI RD 240	18	42
FIN225TL	5840.089	RUGGERINI RD 248	18	44
FIN225TL	5840.089	RUGGERINI RD 92/2	18	46
FIN225TL	5840.089	RUGGERINI RD 270	18	54
FIN225TL	5840.089	RUGGERINI RD 278	18	56
FIN225TL	5840.089	RUGGERINI RD 952	18	58
FIN226OCR STD	316.70	RUGGERINI RF 120	17	17
FIN226OCR STD	316.70	RUGGERINI RF 121	17	19
FIN226OCR STD	316.70	RUGGERINI RF 140	17	23
FIN226OCR STD	316.70	RUGGERINI RD 200	18	15
FIN226OCR STD	316.70	RUGGERINI RD 201	18	17
FIN226OCR STD	316.70	RUGGERINI MD 301	19	11
FIN226OCR STD	316.70	RUGGERINI MD 350	19	29
FIN226OCR STD	316.70	RUGGERINI MD 351	19	31
FIN226OCR STD	316.70	RUGGERINI MD 300	19	9
FIN226OCR STD	A2638	RUGGERINI RD 210	18	27
FIN226OCR STD	A2638	RUGGERINI RD 211	18	29
FIN226OCR STD	A2638	RUGGERINI RD 218	18	31
FIN226OCR STD	A2638	RUGGERINI RD 220	18	33
FIN226OCR STD	A2638	RUGGERINI RD 240	18	41
FIN226OCR STD	A2638	RUGGERINI RD 270	18	53
FIN226OCR STD	A2638	RUGGERINI RD 278	18	55
FIN2284CGA		RUGGERINI RP 280	21	24
FIN2284CGA		RUGGERINI CRD 951/2	21	4
FIN2284CGB	2203	RUGGERINI RP 280	21	24
FIN2284CGB	2203	RUGGERINI CRD 951/2	21	4
FIN2284KIT		SLANZI DVA 1550	15	12
FIN2284KIT		SLANZI DVA 515	15	6
FIN2284KIT		SLANZI DVA 1030	15	8
FIN2300RS00	A2409	ACME ALN 330 W	16	3
FIN2300RS05	A2410	ACME ALN 330 W	16	3
FIN2300RS10	A2411	ACME ALN 330 W	16	3
FIN2315AF	387.177	ACME ALN 290 W	16	2
FIN2315AF	387.177	ACME ALN 330 W	16	4
FIN2316AF	359.121	ACME ALN 290W , ALN 330W	16	63
FIN231CO	4601.162	SLANZI DVA 460	15	2
FIN231CO	4601.162	SLANZI DVA 515	15	6
FIN2320AF	387.168	ACME ADX 300	16	50
FIN2320AF	387.168	ACME ADX 370	16	52
FIN2320AF	387.168	ACME ADX 600	16	54
FIN2320AF	387.168	ACME ADX 740	16	56
FIN2320AF	387.168	ACME ADX 742	16	58
FIN2330AF	388.37	RUGGERINI RD 220	18	34
FIN2330AF	388.37	RUGGERINI RD 901/2	18	36
FIN2330AF	388.37	RUGGERINI RD 240	18	42
FIN2330AF	388.37	RUGGERINI RD 248	18	44
FIN2330AF	388.37	RUGGERINI RD 92/2	18	46
FIN2330AF	388.37	RUGGERINI RD 92/2 L	18	48
FIN2330AF	388.37	RUGGERINI RD 270	18	54
FIN2330AF	388.37	RUGGERINI RD 278	18	56
FIN2330AF	388.37	RUGGERINI RD 952	18	58
FIN2340AF	387.142	ACME VT 88 W	16	60
FIN2340AF	387.142	ACME AL 480	16	62
FIN2340RS00	0082112510	RUGGERINI RY 50	20	1
FIN2340RS05	0082112520	RUGGERINI RY 50	20	1
FIN2340RS10	0082112530	RUGGERINI RY 50	20	1

Tavole di corrispondenza

Cross references

Finimpianti	OEM	Costruttore-Motore Manufacturer-Engine	Cp.	Pg.
FIN234JP	656.15	RUGGERINI RD 92/2 L	18	48
FIN238VR	0073622280	RUGGERINI SP 420	18	62
FIN238VR	730.13	RUGGERINI RF 90	17	12
FIN238VR	730.13	RUGGERINI RF 91	17	14
FIN238VR	730.13	RUGGERINI RF 120	17	18
FIN238VR	730.13	RUGGERINI RF 121	17	20
FIN238VR	730.13	RUGGERINI RF 140	17	24
FIN238VR	730.13	RUGGERINI RF 80	17	6
FIN238VR	730.13	RUGGERINI RF 81	17	8
FIN238VR	730.13	RUGGERINI RD 220	18	34
FIN238VR	730.13	RUGGERINI RD 901/2	18	36
FIN238VR	730.13	RUGGERINI RD 240	18	42
FIN238VR	730.13	RUGGERINI RD 248	18	44
FIN238VR	730.13	RUGGERINI RD 92/2	18	46
FIN238VR	730.13	RUGGERINI RD 92/2 L	18	48
FIN238VR	730.13	RUGGERINI RD 270	18	54
FIN238VR	730.13	RUGGERINI RD 278	18	56
FIN238VR	730.13	RUGGERINI RD 952	18	58
FIN238VR	730.13	RUGGERINI P 101/2	21	14
FIN238VR	730.13	RUGGERINI P 101/2 L	21	16
FIN238VR	730.13	RUGGERINI P 105/2	21	18
FIN238VR	730.13	RUGGERINI P 105/2 R	21	20
FIN238VR	730.13	RUGGERINI P 105/2 L	21	22
FIN238VR	730.13	RUGGERINI RP 280	21	24
FIN238VR	730.13	RUGGERINI RP 320	21	30
FIN238VR	730.13	RUGGERINI RP 328	21	32
FIN238VR	730.13	RUGGERINI RP 360	21	34
FIN238VR	730.13	RUGGERINI RP 368	21	36
FIN238VR	730.13	RUGGERINI RP 380	21	38
FIN238VR	730.13	RUGGERINI CRD 951/2	21	4
FIN238VR	730.13	RUGGERINI RP 388	21	40
FIN238VR	730.13	RUGGERINI CRD 100/2	21	8
FIN238VR	7362.228	SLANZI DVA 1030 S	15	10
FIN238VR	7362.228	SLANZI DVA 460	15	2
FIN238VR	7362.228	SLANZI DVA 1200	15	20
FIN238VR	7362.228	SLANZI DVA 920	15	4
FIN238VR	7362.228	SLANZI DVA 515	15	6
FIN238VR	7362.228	SLANZI DVA 1030	15	8
FIN2422KIT	A2278	RUGGERINI MD 350	19	30
FIN2422KIT	A2278	RUGGERINI MD 351	19	32
FIN2423KIT	A2626	RUGGERINI RY 120	20	20
FIN2423KIT	A2626	RUGGERINI RY 121	20	22
FIN2423KIT	A2626	RUGGERINI RY 125	20	24
FIN2424KIT	A2342	RUGGERINI MD 75.0	19	2
FIN2424KIT	A2342	RUGGERINI MD 75.1	19	4
FIN2424KIT	A2342	RUGGERINI MD 150	19	6
FIN2424KIT	A2342	RUGGERINI MD 151	19	8
FIN2426KIT	A2625	RUGGERINI RY 100	20	14
FIN2426KIT	A2625	RUGGERINI RY 101	20	16
FIN2427KIT	A2624	RUGGERINI RY 85.0	20	6
FIN2427KIT	A2624	RUGGERINI RY 85.1	20	8
FIN2431PC00	6500.552	SLANZI DVA 1550 S	15	13
FIN2431PC00	6500.552	SLANZI DVA 1030 S	15	9
FIN2431PC05	6500.553	SLANZI DVA 1550 S	15	13
FIN2431PC05	6500.553	SLANZI DVA 1030 S	15	9
FIN2431PC10		SLANZI DVA 1550 S	15	13
FIN2431PC10		SLANZI DVA 1030 S	15	9
FIN2430P	A2143	RUGGERINI MD 85.0	19	14
FIN2430P	A2143	RUGGERINI MD 85.1	19	16
FIN2430P	A2143	RUGGERINI MD 95.0	19	18
FIN2430P	A2143	RUGGERINI MD 75.0	19	2
FIN2430P	A2143	RUGGERINI MD 95.1	19	20
FIN2430P	A2143	RUGGERINI MD 170	19	22
FIN2430P	A2143	RUGGERINI MD 171	19	24
FIN2430P	A2143	RUGGERINI MD 190	19	26
FIN2430P	A2143	RUGGERINI MD 191	19	28
FIN2430P	A2143	RUGGERINI MD 75.1	19	4
FIN2430P	A2143	RUGGERINI MD 150	19	6
FIN2430P	A2143	RUGGERINI MD 151	19	8
FIN2458KIT		SLANZI DVA 460	15	2
FIN2458KIT		SLANZI DVA 920	15	4
FIN248JP	656.76	RUGGERINI RY 100	20	14
FIN248JP	656.76	RUGGERINI RY 101	20	16
FIN248JP	656.76	RUGGERINI RY 120	20	20
FIN248JP	656.76	RUGGERINI RY 121	20	22
FIN248JP	656.76	RUGGERINI RY 125	20	24
FIN248JP	656.76	RUGGERINI RY 85.0	20	6
FIN248JP	656.76	RUGGERINI RY 85.1	20	8
FIN248NO	644.55	RUGGERINI MD 170	19	22
FIN248NO	644.55	RUGGERINI MD 171	19	24
FIN248PN	854.113	ACME ADN 45	16	27
FIN248PN	854.113	ACME ADN 45 W	16	29
FIN248PN	854.113	ACME ADN 48	16	33
FIN248PN	854.113	ACME ADN 48 W	16	35
FIN2500AF	387.136	ACME ADN 37	16	18
FIN2500AF	387.136	ACME ADN 45	16	26
FIN2501AF	387.186	ACME ADN 37 W	16	20
FIN2501AF	387.186	ACME ADN 43	16	22
FIN2501AF	387.186	ACME ADN 43 W	16	24
FIN2501AF	387.186	ACME ADN 45	16	28
FIN2501AF	387.186	ACME ADN 45 W	16	30
FIN2501AF	387.186	ACME ADN 48	16	34
FIN2501AF	387.186	ACME ADN 48 W	16	36
FIN2501AF	387.186	ACME ADN 54	16	40

Finimpianti	OEM	Costruttore-Motore Manufacturer-Engine	Cp.	Pg.
FIN2501AF	387.186	ACME ADN 54 W	16	42
FIN2501AF	387.186	ACME ADN 60	16	46
FIN2501AF	387.186	ACME ADN 60 W	16	48
FIN253PF	0013010530	RUGGERINI RY 75	20	10
FIN253PF	0013010530	RUGGERINI RY 103	20	12
FIN253PF	0013010530	RUGGERINI RY 110	20	18
FIN253PF	0013010530	RUGGERINI RY 50	20	2
FIN253PF	0013010530	RUGGERINI RY 70	20	4
FIN255VR	0073622550	RUGGERINI RY 103	20	12
FIN255VR	0073622550	RUGGERINI RY 110	20	18
FIN2606RS00	0082112390	RUGGERINI RY 103	20	11
FIN2606RS00	0082112390	RUGGERINI RY 75	20	9
FIN2606RS05	0082112400	RUGGERINI RY 103	20	11
FIN2606RS05	0082112400	RUGGERINI RY 75	20	9
FIN2606RS10	0082112410	RUGGERINI RY 103	20	11
FIN2606RS10	0082112410	RUGGERINI RY 75	20	9
FIN260JP	656.60	RUGGERINI MD 300	19	10
FIN260JP	656.60	RUGGERINI MD 301	19	12
FIN260JP	656.60	RUGGERINI MD 85.0	19	14
FIN260JP	656.60	RUGGERINI MD 85.1	19	16
FIN260JP	656.60	RUGGERINI MD 95.0	19	18
FIN260JP	656.60	RUGGERINI MD 75.0	19	2
FIN260JP	656.60	RUGGERINI MD 95.1	19	20
FIN260JP	656.60	RUGGERINI MD 170	19	22
FIN260JP	656.60	RUGGERINI MD 171	19	24
FIN260JP	656.60	RUGGERINI MD 190	19	26
FIN260JP	656.60	RUGGERINI MD 191	19	28
FIN260JP	656.60	RUGGERINI MD 350	19	30
FIN260JP	656.60	RUGGERINI MD 351	19	32
FIN260JP	656.60	RUGGERINI MD 75.1	19	4
FIN260JP	656.60	RUGGERINI MD 150	19	6
FIN260JP	656.60	RUGGERINI MD 151	19	8
FIN2670RS00	0082112600	RUGGERINI RY 110	20	17
FIN2670RS05	0082112610	RUGGERINI RY 110	20	17
FIN2670RS10	0082112620	RUGGERINI RY 110	20	17
FIN268NO	0065315070	RUGGERINI SP 420	18	62
FIN275AF	175.52	RUGGERINI RY 85.0, RY 85.1, RY 100, RY 101, RY 120, RY 121	20	25
FIN2810GR	3001.082	LOMBARDINI Benzina Petrol LGA 184	14	41
FIN2810GR	3001.082	LOMBARDINI Benzina Petrol LKA 184	14	43
FIN2810GR	3001.082	LOMBARDINI Benzina Petrol LGA 225	14	45
FIN2810GR	3001.082	LOMBARDINI Benzina Petrol LKA 225	14	47
FIN2810GR	3001.082	LOMBARDINI Benzina Petrol LGA 226	14	49
FIN2810GR	3001.082	LOMBARDINI Benzina Petrol LKA 226	14	51
FIN281CB	447.079	ACME AD 114 / A	16	10
FIN281CB	447.079	ACME AD 114	16	12
FIN281CB	447.079	ACME AD 112	16	14
FIN281CB	447.079	ACME AD 116	16	16
FIN281CB	447.079	ACME ADN 37	16	18
FIN281CB	447.079	ACME ADN 37 W	16	20
FIN281CB	447.079	ACME ADN 43	16	22
FIN281CB	447.079	ACME ADN 43 W	16	24
FIN281CB	447.079	ACME ADN 45	16	26
FIN281CB	447.079	ACME ADN 45	16	28
FIN281CB	447.079	ACME ADN 45 W	16	30
FIN281CB	447.079	ACME ADN 48	16	32
FIN281CB	447.079	ACME ADN 48	16	34
FIN281CB	447.079	ACME ADN 48 W	16	36
FIN281CB	447.079	ACME ADN 54	16	38
FIN281CB	447.079	ACME ADN 54	16	40
FIN281CB	447.079	ACME ADN 54 W	16	42
FIN281CB	447.079	ACME ADN 60	16	44
FIN281CB	447.079	ACME ADN 60	16	46
FIN281CB	447.079	ACME ADN 60 W	16	48
FIN281CB	447.079	ACME AD 108	16	6
FIN281CB	447.079	ACME AD 110	16	8
FIN281CB	447.79	RUGGERINI RF 88	17	10
FIN281CB	447.79	RUGGERINI RF 90	17	12
FIN281CB	447.79	RUGGERINI RF 91	17	14
FIN281CB	447.79	RUGGERINI RF 100	17	16
FIN281CB	447.79	RUGGERINI RF 120	17	18
FIN281CB	447.79	RUGGERINI MC 70	17	2
FIN281CB	447.79	RUGGERINI RF 121	17	20
FIN281CB	447.79	RUGGERINI RF 130	17	22
FIN281CB	447.79	RUGGERINI RF 140	17	24
FIN281CB	447.79	RUGGERINI RF 148	17	26
FIN281CB	447.79	RUGGERINI MC 71	17	4
FIN281CB	447.79	RUGGERINI RF 80	17	6
FIN281CB	447.79	RUGGERINI RF 81	17	8
FIN281CB	447.79	RUGGERINI RD 850	18	12
FIN281CB	447.79	RUGGERINI RD 901/A	18	14
FIN281CB	447.79	RUGGERINI RD 80	18	2
FIN281CB	447.79	RUGGERINI RD 900	18	22
FIN281CB	447.79	RUGGERINI RD 901	18	24
FIN281CB	447.79	RUGGERINI RD 901/AD	18	26

Ricambi non originali per motori. Denominazioni e codici originali, sono riportati a puro titolo di riferimento.

Tavole di corrispondenza

Cross references

Finimpianti	OEM	Costruttore-Motore Manufacturer-Engine	Cp.	Pg.
FIN281CB	447.79	RUGGERINI RD 920	18	38
FIN281CB	447.79	RUGGERINI RD 81	18	4
FIN281CB	447.79	RUGGERINI RD 920 L	18	40
FIN281CB	447.79	RUGGERINI RD 950	18	50
FIN281CB	447.79	RUGGERINI RD 950 L	18	52
FIN281CFA	0054961820	RUGGERINI RD 290	18	60
FIN281CFA	0054961820	RUGGERINI SP 420	18	62
FIN285CB	447.60	RUGGERINI P 101	21	10
FIN285CB	447.60	RUGGERINI P 101 L	21	12
FIN285CB	447.60	RUGGERINI P 101/2	21	14
FIN285CB	447.60	RUGGERINI P 101/2 L	21	16
FIN285CB	447.60	RUGGERINI P 105/2	21	18
FIN285CB	447.60	RUGGERINI CRD 951	21	2
FIN285CB	447.60	RUGGERINI P 105/2 R	21	20
FIN285CB	447.60	RUGGERINI P 105/2 L	21	22
FIN285CB	447.60	RUGGERINI RP 280	21	24
FIN285CB	447.60	RUGGERINI RP 170	21	26
FIN285CB	447.60	RUGGERINI RP 178	21	28
FIN285CB	447.60	RUGGERINI RP 320	21	30
FIN285CB	447.60	RUGGERINI RP 328	21	32
FIN285CB	447.60	RUGGERINI RP 360	21	34
FIN285CB	447.60	RUGGERINI RP 368	21	36
FIN285CB	447.60	RUGGERINI RP 380	21	38
FIN285CB	447.60	RUGGERINI CRD 951/2	21	4
FIN285CB	447.60	RUGGERINI RP 388	21	40
FIN285CB	447.60	RUGGERINI CRD 100	21	6
FIN285CB	447.60	RUGGERINI CRD 100/2	21	8
FIN285SM	2399	RUGGERINI P 105/2	21	18
FIN285SM	2399	RUGGERINI P 105/2 R	21	20
FIN285SM	2399	RUGGERINI P 105/2 L	21	22
FIN285SM	2399	RUGGERINI RP 360	21	34
FIN285SM	2399	RUGGERINI RP 368	21	36
FIN285SM	2399	RUGGERINI RP 380	21	38
FIN285SM	2399	RUGGERINI RP 388	21	40
FIN290AF	388.29	RUGGERINI RF 90	17	12
FIN290AF	388.29	RUGGERINI RF 91	17	14
FIN290AF	388.29	RUGGERINI RF 120	17	18
FIN290AF	388.29	RUGGERINI RF 121	17	20
FIN290AF	388.29	RUGGERINI RF 140	17	24
FIN290AF	388.29	RUGGERINI RY 120	20	20
FIN290AF	388.29	RUGGERINI RY 121	20	22
FIN290AF	388.29	RUGGERINI RY 125	20	24
FIN290AF	388.40	RUGGERINI RF 88	17	10
FIN290AF	388.40	RUGGERINI RF 130	17	22
FIN290AF	388.40	RUGGERINI RF 148	17	26
FIN290AF	388.40	RUGGERINI RF 80	17	6
FIN290AF	388.40	RUGGERINI RF 81	17	8
FIN291AF	389.20	RUGGERINI RY 100	20	14
FIN291AF	389.20	RUGGERINI RY 101	20	16
FIN291AF	389.20	RUGGERINI RY 85.0	20	6
FIN291AF	389.20	RUGGERINI RY 85.1	20	8
FIN298VR	0073622980	RUGGERINI RD 290	18	60
FIN298VR	0073622980	RUGGERINI RY 75	20	10
FIN298VR	0073622980	RUGGERINI RY 50	20	2
FIN298VR	0073622980	RUGGERINI RY 70	20	4
FIN298VR	730.34	RUGGERINI RD 188	18	10
FIN298VR	730.34	RUGGERINI RD 200	18	16
FIN298VR	730.34	RUGGERINI RD 201	18	18
FIN298VR	730.34	RUGGERINI RD 208	18	20
FIN298VR	730.34	RUGGERINI RD 210	18	28
FIN298VR	730.34	RUGGERINI RD 211	18	30
FIN298VR	730.34	RUGGERINI RD 218	18	32
FIN298VR	730.34	RUGGERINI RD 180	18	6
FIN298VR	730.34	RUGGERINI RD 181	18	8
FIN298VR	730.34	RUGGERINI MD 85.0	19	14
FIN298VR	730.34	RUGGERINI MD 85.1	19	16
FIN298VR	730.34	RUGGERINI MD 95.0	19	18
FIN298VR	730.34	RUGGERINI MD 75.0	19	2
FIN298VR	730.34	RUGGERINI MD 95.1	19	20
FIN298VR	730.34	RUGGERINI MD 170	19	22
FIN298VR	730.34	RUGGERINI MD 171	19	24
FIN298VR	730.34	RUGGERINI MD 190	19	26
FIN298VR	730.34	RUGGERINI MD 191	19	28
FIN298VR	730.34	RUGGERINI MD 75.1	19	4
FIN298VR	730.34	RUGGERINI MD 150	19	6
FIN298VR	730.34	RUGGERINI MD 151	19	8
FIN298VR	730.34	RUGGERINI RY 100	20	14
FIN298VR	730.34	RUGGERINI RY 101	20	16
FIN298VR	730.34	RUGGERINI RY 120	20	20
FIN298VR	730.34	RUGGERINI RY 121	20	22
FIN298VR	730.34	RUGGERINI RY 125	20	24
FIN298VR	730.34	RUGGERINI RY 85.0	20	6
FIN298VR	730.34	RUGGERINI RY 85.1	20	8
FIN301ASA	464.104	ACME AL 480	16	61
FIN301ASA	464.104	ACME AL 480	16	61
FIN301FP	0065851030	RUGGERINI RY 103	20	12
FIN301FP	0065851030	RUGGERINI RY 110	20	18
FIN302PB	1585.089	SLANZI DVA 460	15	1
FIN302PB	1585.089	SLANZI DVA 1550	15	11
FIN302PB	1585.089	SLANZI DVA 1550 S	15	13
FIN302PB	1585.089	SLANZI DVA 1200	15	19
FIN302PB	1585.089	SLANZI DVA 1750	15	21
FIN302PB	1585.089	SLANZI DVA 1750 S	15	23
FIN302PB	1585.089	SLANZI DVA 2350	15	25

Finimpianti	OEM	Costruttore-Motore Manufacturer-Engine	Cp.	Pg.
FIN302PB	1585.089	SLANZI DVA 920	15	3
FIN302PB	1585.089	SLANZI DVA 515	15	5
FIN302PB	1585.089	SLANZI DVA 1030	15	7
FIN302PB	1585.089	SLANZI DVA 1030 S	15	9
FIN303CGA		RUGGERINI MD 350	19	30
FIN303CGA		RUGGERINI MD 351	19	32
FIN303CGB	A2273	RUGGERINI MD 350	19	30
FIN303CGB	A2273	RUGGERINI MD 351	19	32
FIN303ST	890.002	ACME ADN 37	16	18
FIN303ST	890.002	ACME ADN 37 W	16	20
FIN303ST	890.002	ACME ADN 43	16	22
FIN303ST	890.002	ACME ADN 43 W	16	24
FIN303ST	890.002	ACME ADN 45	16	26
FIN303ST	890.002	ACME ADN 45	16	28
FIN303ST	890.002	ACME ADN 45 W	16	30
FIN303ST	890.002	ACME ADN 48	16	32
FIN303ST	890.002	ACME ADN 48	16	34
FIN303ST	890.002	ACME ADN 48 W	16	36
FIN303ST	890.002	ACME ADN 54	16	38
FIN303ST	890.002	ACME ADN 54	16	40
FIN303ST	890.002	ACME ADN 54 W	16	42
FIN303ST	890.002	ACME ADN 60	16	44
FIN303ST	890.002	ACME ADN 60	16	46
FIN303ST	890.002	ACME ADN 60 W	16	48
FIN303ST	890.02	RUGGERINI RD 850	18	12
FIN303ST	890.02	RUGGERINI RD 901/A	18	14
FIN303ST	890.02	RUGGERINI RD 80	18	2
FIN303ST	890.02	RUGGERINI RD 900	18	22
FIN303ST	890.02	RUGGERINI RD 901	18	24
FIN303ST	890.02	RUGGERINI RD 901/AD	18	26
FIN303ST	890.02	RUGGERINI RD 920	18	38
FIN303ST	890.02	RUGGERINI RD 81	18	4
FIN303ST	890.02	RUGGERINI RD 920 L	18	40
FIN303ST	890.02	RUGGERINI RD 950	18	50
FIN303ST	890.02	RUGGERINI RD 950 L	18	52
FIN305CGA		RUGGERINI RY 120	20	20
FIN305CGA		RUGGERINI RY 121	20	22
FIN305CGA		RUGGERINI RY 125	20	24
FIN305CGB	A2613	RUGGERINI RY 120	20	20
FIN305CGB	A2613	RUGGERINI RY 121	20	22
FIN305CGB	A2613	RUGGERINI RY 125	20	24
FIN306CGA		RUGGERINI RY 100	20	14
FIN306CGA		RUGGERINI RY 101	20	16
FIN306CGB	A2612	RUGGERINI RY 100	20	14
FIN306CGB	A2612	RUGGERINI RY 101	20	16
FIN307AA	464.109	ACME VT 88 W	16	59
FIN307CGA		RUGGERINI RY 85.0	20	6
FIN307CGA		RUGGERINI RY 85.1	20	8
FIN307CGB	A2611	RUGGERINI RY 85.0	20	6
FIN307CGB	A2611	RUGGERINI RY 85.1	20	8
FIN308SA	464.107	ACME VT 88 W	16	59
FIN3215RT	054.016	ACME AD 114 / A	16	10
FIN3215RT	054.016	ACME AD 114	16	12
FIN3215RT	054.016	ACME AD 112	16	14
FIN3215RT	054.016	ACME AD 116	16	16
FIN3215RT	054.016	ACME ADN 37	16	18
FIN3215RT	054.016	ACME ALN 290 W	16	2
FIN3215RT	054.016	ACME ADN 37 W	16	20
FIN3215RT	054.016	ACME ADN 43	16	22
FIN3215RT	054.016	ACME ADN 43 W	16	24
FIN3215RT	054.016	ACME ADN 45	16	26
FIN3215RT	054.016	ACME ADN 45	16	28
FIN3215RT	054.016	ACME ADN 45 W	16	30
FIN3215RT	054.016	ACME ADN 48	16	32
FIN3215RT	054.016	ACME ADN 48	16	34
FIN3215RT	054.016	ACME ADN 48 W	16	36
FIN3215RT	054.016	ACME ADN 54	16	38
FIN3215RT	054.016	ACME ALN 330 W	16	4
FIN3215RT	054.016	ACME ADN 54	16	40
FIN3215RT	054.016	ACME ADN 54 W	16	42
FIN3215RT	054.016	ACME ADN 60	16	44
FIN3215RT	054.016	ACME ADN 60	16	46
FIN3215RT	054.016	ACME ADN 60 W	16	48
FIN3215RT	054.016	ACME ADX 300	16	50
FIN3215RT	054.016	ACME ADX 370	16	52
FIN3215RT	054.016	ACME ADX 600	16	54
FIN3215RT	054.016	ACME ADX 740	16	56
FIN3215RT	054.016	ACME ADX 742	16	58
FIN3215RT	054.016	ACME AD 108	16	6
FIN3215RT	054.016	ACME VT 88 W	16	60
FIN3215RT	054.016	ACME AL 480	16	62
FIN3215RT	054.016	ACME AD 110	16	8
FIN3215RT		RUGGERINI RF 88	17	10
FIN3215RT		RUGGERINI RF 90	17	12
FIN3215RT		RUGGERINI RF 91	17	14
FIN3215RT		RUGGERINI RF 100	17	16
FIN3215RT		RUGGERINI RF 120	17	18
FIN3215RT		RUGGERINI MC 70	17	2
FIN3215RT		RUGGERINI RF 121	17	20
FIN3215RT		RUGGERINI RF 130	17	22
FIN3215RT		RUGGERINI RF 140	17	24
FIN3215RT		RUGGERINI RF 148	17	26
FIN3215RT		RUGGERINI MC 71	17	4
FIN3215RT		RUGGERINI RF 80	17	6

Tavole di corrispondenza

Cross references

Finimpianti	OEM	Costruttore-Motore Manufacturer-Engine	Cp.	Pg.
FIN3215RT		RUGGERINI RF 81	17	8
FIN3215RT		RUGGERINI RD 850	18	12
FIN3215RT		RUGGERINI RD 901/A	18	14
FIN3215RT		RUGGERINI RD 80	18	2
FIN3215RT		RUGGERINI RD 900	18	22
FIN3215RT		RUGGERINI RD 901	18	24
FIN3215RT		RUGGERINI RD 901/AD	18	26
FIN3215RT		RUGGERINI RD 920	18	38
FIN3215RT		RUGGERINI RD 81	18	4
FIN3215RT		RUGGERINI RD 920 L	18	40
FIN3215RT		RUGGERINI RD 950	18	50
FIN3215RT		RUGGERINI RD 950 L	18	52
FIN3216RT	054.015	ACME AD 114 / A	16	10
FIN3216RT	054.015	ACME AD 114	16	12
FIN3216RT	054.015	ACME AD 112	16	14
FIN3216RT	054.015	ACME AD 116	16	16
FIN3216RT	054.015	ACME ADN 45	16	26
FIN3216RT	054.015	ACME ADN 48	16	32
FIN3216RT	054.015	ACME ADN 54	16	38
FIN3216RT	054.015	ACME ADN 60 W	16	48
FIN3216RT	054.015	ACME AD 108	16	6
FIN3216RT	054.015	ACME AD 110	16	8
FIN3216RT	054.131	ACME ADN 37	16	18
FIN3216RT	054.131	ACME ADN 37 W	16	20
FIN3216RT	054.131	ACME ADN 43	16	22
FIN3216RT	054.131	ACME ADN 43 W	16	24
FIN3216RT	054.131	ACME ADN 45	16	28
FIN3216RT	054.131	ACME ADN 45 W	16	30
FIN3216RT	054.131	ACME ADN 48	16	34
FIN3216RT	054.131	ACME ADN 48 W	16	36
FIN3216RT	054.131	ACME ADN 54	16	40
FIN3216RT	054.131	ACME ADN 54 W	16	42
FIN3216RT	054.131	ACME ADN 60	16	44
FIN3216RT	054.131	ACME ADN 60	16	46
FIN3216RT		RUGGERINI RF 88	17	10
FIN3216RT		RUGGERINI RF 90	17	12
FIN3216RT		RUGGERINI RF 91	17	14
FIN3216RT		RUGGERINI RF 100	17	16
FIN3216RT		RUGGERINI RF 120	17	18
FIN3216RT		RUGGERINI MC 70	17	2
FIN3216RT		RUGGERINI RF 121	17	20
FIN3216RT		RUGGERINI RF 130	17	22
FIN3216RT		RUGGERINI RF 140	17	24
FIN3216RT		RUGGERINI RF 148	17	26
FIN3216RT		RUGGERINI MC 71	17	4
FIN3216RT		RUGGERINI RF 80	17	6
FIN3216RT		RUGGERINI RF 81	17	8
FIN3216RT		RUGGERINI RD 850	18	12
FIN3216RT		RUGGERINI RD 901/A	18	14
FIN3216RT		RUGGERINI RD 80	18	2
FIN3216RT		RUGGERINI RD 900	18	22
FIN3216RT		RUGGERINI RD 901	18	24
FIN3216RT		RUGGERINI RD 901/AD	18	26
FIN3216RT		RUGGERINI RD 920	18	38
FIN3216RT		RUGGERINI RD 81	18	4
FIN3216RT		RUGGERINI RD 920 L	18	40
FIN3216RT		RUGGERINI RD 950	18	50
FIN3216RT		RUGGERINI RD 950 L	18	52
FIN3216RT		RUGGERINI P 101/2	21	14
FIN3216RT		RUGGERINI P 101/2 L	21	16
FIN3216RT		RUGGERINI P 105/2	21	18
FIN3216RT		RUGGERINI P 105/2 R	21	20
FIN3216RT		RUGGERINI P 105/2 L	21	22
FIN3216RT		RUGGERINI RP 280	21	24
FIN3216RT		RUGGERINI RP 320	21	30
FIN3216RT		RUGGERINI RP 328	21	32
FIN3216RT		RUGGERINI RP 360	21	34
FIN3216RT		RUGGERINI RP 368	21	36
FIN3216RT		RUGGERINI RP 380	21	38
FIN3216RT		RUGGERINI CRD 951/2	21	4
FIN3216RT		RUGGERINI RP 388	21	40
FIN3216RT		RUGGERINI CRD 100/2	21	8
FIN3217RTS (FIN3215RT + FIN3216RT)	2118	RUGGERINI MC-RF	17	27
FIN3217RTS (FIN3215RT + FIN3216RT)	2118	RUGGERINI RD 80, RD 81, RD 850, RD 901/A, RD 900, RD 901, RD 901/AD, RD 920, RD 920 L, RD 950, RD 950 L	18	63

Finimpianti	OEM	Costruttore-Motore Manufacturer-Engine	Cp.	Pg.
FIN3217RTS (FIN3215RT + FIN3216RT)	A2155	ACME AD 108, AD 110, AD 114 / A, AD 114, AD 112, AD 116, ADN 37, ADN 37 W, ADN 43, ADN 43 W, ADN 45, ADN 45 W, ADN 48, ADN 48 W, ADN 54, ADN 54 W, ADN 60, ADN 60 W	16	63
FIN3218RT		RUGGERINI RD 188	18	10
FIN3218RT		RUGGERINI RD 188	18	10
FIN3218RT		RUGGERINI RD 200	18	16
FIN3218RT		RUGGERINI RD 200	18	16
FIN3218RT		RUGGERINI RD 201	18	18
FIN3218RT		RUGGERINI RD 201	18	18
FIN3218RT		RUGGERINI RD 208	18	20
FIN3218RT		RUGGERINI RD 208	18	20
FIN3218RT		RUGGERINI RD 210	18	28
FIN3218RT		RUGGERINI RD 210	18	28
FIN3218RT		RUGGERINI RD 211	18	30
FIN3218RT		RUGGERINI RD 211	18	30
FIN3218RT		RUGGERINI RD 218	18	32
FIN3218RT		RUGGERINI RD 218	18	32
FIN3218RT		RUGGERINI RD 220	18	34
FIN3218RT		RUGGERINI RD 220	18	34
FIN3218RT		RUGGERINI RD 220	18	34
FIN3218RT		RUGGERINI RD 901/2	18	36
FIN3218RT		RUGGERINI RD 901/2	18	36
FIN3218RT		RUGGERINI RD 240	18	42
FIN3218RT		RUGGERINI RD 240	18	42
FIN3218RT		RUGGERINI RD 248	18	44
FIN3218RT		RUGGERINI RD 248	18	44
FIN3218RT		RUGGERINI RD 92/2	18	46
FIN3218RT		RUGGERINI RD 92/2	18	46
FIN3218RT		RUGGERINI RD 92/2 L	18	48
FIN3218RT		RUGGERINI RD 92/2 L	18	48
FIN3218RT		RUGGERINI RD 270	18	54
FIN3218RT		RUGGERINI RD 270	18	54
FIN3218RT		RUGGERINI RD 278	18	56
FIN3218RT		RUGGERINI RD 278	18	56
FIN3218RT		RUGGERINI RD 952	18	58
FIN3218RT		RUGGERINI RD 952	18	58
FIN3218RT		RUGGERINI RD 180	18	6
FIN3218RT		RUGGERINI RD 180	18	6
FIN3218RT		RUGGERINI RD 181	18	8
FIN3218RT		RUGGERINI RD 181	18	8
FIN3218RT		RUGGERINI MD 85.0	19	14
FIN3218RT		RUGGERINI MD 85.1	19	16
FIN3218RT		RUGGERINI MD 95.0	19	18
FIN3218RT		RUGGERINI MD 75.0	19	2
FIN3218RT		RUGGERINI MD 95.1	19	20
FIN3218RT		RUGGERINI MD 170	19	22
FIN3218RT		RUGGERINI MD 171	19	24
FIN3218RT		RUGGERINI MD 190	19	26
FIN3218RT		RUGGERINI MD 191	19	28
FIN3218RT		RUGGERINI MD 75.1	19	4
FIN3218RT		RUGGERINI MD 150	19	6
FIN3218RT		RUGGERINI MD 151	19	8
FIN3219RT		RUGGERINI MD 85.0	19	14
FIN3219RT		RUGGERINI MD 85.1	19	16
FIN3219RT		RUGGERINI MD 95.0	19	18
FIN3219RT		RUGGERINI MD 75.0	19	2
FIN3219RT		RUGGERINI MD 95.1	19	20
FIN3219RT		RUGGERINI MD 170	19	22
FIN3219RT		RUGGERINI MD 171	19	24
FIN3219RT		RUGGERINI MD 190	19	26
FIN3219RT		RUGGERINI MD 191	19	28
FIN3219RT		RUGGERINI MD 75.1	19	4
FIN3219RT		RUGGERINI MD 150	19	6
FIN3219RT		RUGGERINI MD 151	19	8
FIN3220RTS (FIN3218RT + FIN3219RT)	A2125	RUGGERINI MD 75.0, MD 75.1, MD 150, MD 151, MD 85.0, MD 85.1, MD 95.0, MD 95.1, MD 170, MD 171, MD 190, MD 191	19	33

Tavole di corrispondenza

Cross references

Finimpianti	OEM	Costruttore-Motore Manufacturer-Engine	Cp.	Pg.
FIN3222RTS (FIN3218RT + FIN3218RT)	2312	RUGGERINI RD 180, RD 181, RD 188, RD 200, RD 201, RD 208, RD 210, RD 211, RD 218, RD 220, RD 240, RD 248, RD 92/2, RD 92/2 L, RD 270, RD 278, RD 952	18	63
FIN3223RT		RUGGERINI P 101	21	10
FIN3223RT		RUGGERINI P 101 L	21	12
FIN3223RT		RUGGERINI CRD 951	21	2
FIN3223RT		RUGGERINI RP 170	21	26
FIN3223RT		RUGGERINI RP 178	21	28
FIN3223RT		RUGGERINI CRD 100	21	6
FIN3223RTS (FIN3241RT + FIN3241RT)	054.12	RUGGERINI RY 85.0, RY 85.1, RY 100, RY 101, RY 120, RY 121, RY 125	20	25
FIN3224RT		RUGGERINI P 101	21	10
FIN3224RT		RUGGERINI P 101 L	21	12
FIN3224RT		RUGGERINI P 101/2	21	14
FIN3224RT		RUGGERINI P 101/2 L	21	16
FIN3224RT		RUGGERINI P 105/2	21	18
FIN3224RT		RUGGERINI CRD 951	21	2
FIN3224RT		RUGGERINI P 105/2 R	21	20
FIN3224RT		RUGGERINI P 105/2 L	21	22
FIN3224RT		RUGGERINI RP 280	21	24
FIN3224RT		RUGGERINI RP 170	21	26
FIN3224RT		RUGGERINI RP 178	21	28
FIN3224RT		RUGGERINI RP 320	21	30
FIN3224RT		RUGGERINI RP 328	21	32
FIN3224RT		RUGGERINI RP 360	21	34
FIN3224RT		RUGGERINI RP 368	21	36
FIN3224RT		RUGGERINI RP 380	21	38
FIN3224RT		RUGGERINI CRD 951/2	21	4
FIN3224RT		RUGGERINI RP 388	21	40
FIN3224RT		RUGGERINI CRD 100	21	6
FIN3224RT		RUGGERINI CRD 100/2	21	8
FIN3225RTS (FIN3224RT + FIN3223RT)	2161	RUGGERINI CRD 951, CRD 100, P 101, P 101L, RP 170, RP 178,	21	41
FIN3226RTS (FIN3224RT + FIN3216RT)	2202	RUGGERINI CRD 951/2, CRD 100/2, P 101/2, P 101/2L, P105/2, P105/2R, P 105/2L, RP 280, RP 320, RP 328, RP 360, RP 368, RP 380, RP 388	21	41
FIN3228MB STD	0016112090	RUGGERINI RY 103	20	11
FIN3228MB STD	0016112090	RUGGERINI RY 110	20	17
FIN3229MB STD	0016111960	RUGGERINI RY 50	20	1
FIN3230MB STD	0016111850	RUGGERINI RY 70	20	3
FIN3230MB STD	0016111850	RUGGERINI RY 75	20	9
FIN3230RT	1213.257	SLANZI DVA 1030 S	15	10
FIN3230RT	1213.257	SLANZI DVA 1200	15	20
FIN3230RT	1213.257	SLANZI DVA 920	15	4
FIN3230RT	1213.257	SLANZI DVA 1030	15	8
FIN3231RT	1213.262	SLANZI DVA 1030 S	15	10
FIN3231RT	1213.262	SLANZI DVA 1200	15	20
FIN3231RT	1213.262	SLANZI DVA 920	15	4
FIN3231RT	1213.262	SLANZI DVA 1030	15	8
FIN3232RT	1213.267	SLANZI DVA 1550	15	12
FIN3232RT	1213.267	SLANZI DVA 1550 S	15	14
FIN3232RT	1213.267	SLANZI DVA 1750	15	22
FIN3232RT	1213.267	SLANZI DVA 1750 S	15	24
FIN3232RT	1213.267	SLANZI DVA 2350	15	26
FIN3233RT	1213.266	SLANZI DVA 1500	15	28
FIN3235RT	1213.256	SLANZI DVA 460	15	2
FIN3235RT	1213.256	SLANZI DVA 460	15	2
FIN3235RT	1213.256	SLANZI DVA 515	15	6
FIN3235RT	1213.256	SLANZI DVA 515	15	6
FIN3236RT	1210.050	SLANZI DVA 2200	15	30
FIN3236RT	1210.050	SLANZI DVA 2200	15	30
FIN3236RT	1210.050	SLANZI DVA 2900	15	32
FIN3236RT	1210.050	SLANZI DVA 2900	15	32
FIN3238RT	1212.050	SLANZI DVA 650	15	16
FIN3238RT	1212.050	SLANZI DVA 680	15	18
FIN323VA	014.09	RUGGERINI RF 90	17	12
FIN323VA	014.09	RUGGERINI RF 91	17	14
FIN323VA	014.09	RUGGERINI RF 120	17	18

Finimpianti	OEM	Costruttore-Motore Manufacturer-Engine	Cp.	Pg.
FIN323VA	014.09	RUGGERINI RF 121	17	20
FIN323VA	014.09	RUGGERINI RF 140	17	24
FIN323VA	014.09	RUGGERINI RF 80	17	6
FIN323VA	014.09	RUGGERINI RF 81	17	8
FIN323VA	014.09	RUGGERINI RD 220	18	34
FIN323VA	014.09	RUGGERINI RD 901/2	18	36
FIN323VA	014.09	RUGGERINI RD 240	18	42
FIN323VA	014.09	RUGGERINI RD 248	18	44
FIN323VA	014.09	RUGGERINI RD 92/2	18	46
FIN323VA	014.09	RUGGERINI RD 270	18	54
FIN323VA	014.09	RUGGERINI RD 278	18	56
FIN323VA	014.09	RUGGERINI RD 952	18	58
FIN3240RT	A2207	RUGGERINI MD 300	19	10
FIN3240RT	A2207	RUGGERINI MD 301	19	12
FIN3240RT	A2207	RUGGERINI MD 350	19	30
FIN3240RT	A2207	RUGGERINI MD 351	19	32
FIN3241RT		RUGGERINI RY 100	20	14
FIN3241RT		RUGGERINI RY 100	20	14
FIN3241RT		RUGGERINI RY 101	20	16
FIN3241RT		RUGGERINI RY 101	20	16
FIN3241RT		RUGGERINI RY 120	20	20
FIN3241RT		RUGGERINI RY 120	20	20
FIN3241RT		RUGGERINI RY 121	20	22
FIN3241RT		RUGGERINI RY 121	20	22
FIN3241RT		RUGGERINI RY 125	20	24
FIN3241RT		RUGGERINI RY 125	20	24
FIN3241RT		RUGGERINI RY 85.0	20	6
FIN3241RT		RUGGERINI RY 85.0	20	6
FIN3241RT		RUGGERINI RY 85.1	20	8
FIN3241RT		RUGGERINI RY 85.1	20	8
FIN3245KIT		RUGGERINI RD 950	18	50
FIN3245KIT		RUGGERINI RD 950 L	18	52
FIN3245RT	1213.265	SLANZI DVA 1800	15	34
FIN3245RT	1213.265	SLANZI DVA 2700	15	36
FIN3245RT	1213.265	SLANZI DVA 3600	15	38
FIN3245RT	1213.265	SLANZI DS 2000	15	40
FIN3245RT	1213.265	SLANZI DS 3000	15	42
FIN3245RT	1213.265	SLANZI DS 4000	15	44
FIN3246KIT		RUGGERINI RF 130	17	22
FIN3246RT	1213.259	SLANZI DVA 1800	15	34
FIN3246RT	1213.259	SLANZI DVA 2700	15	36
FIN3246RT	1213.259	SLANZI DVA 3600	15	38
FIN3246RT	1213.259	SLANZI DS 2000	15	40
FIN3246RT	1213.259	SLANZI DS 3000	15	42
FIN3246RT	1213.259	SLANZI DS 4000	15	44
FIN3250RT	1213.205	LOMBARDINI Benzina Petrol LGA 184	14	42
FIN3250RT	1213.205	LOMBARDINI Benzina Petrol LKA 184	14	44
FIN3250RT	1213.205	LOMBARDINI Benzina Petrol LGA 225	14	46
FIN3250RT	1213.205	LOMBARDINI Benzina Petrol LKA 225	14	48
FIN3251KIT	A2268	RUGGERINI MD 85.0	19	14
FIN3251KIT	A2268	RUGGERINI MD 85.1	19	16
FIN3251KIT	A2268	RUGGERINI MD 170	19	22
FIN3251KIT	A2268	RUGGERINI MD 171	19	24
FIN3251RT	1213.055	LOMBARDINI Benzina Petrol LGA 226	14	50
FIN3251RT	1213.055	LOMBARDINI Benzina Petrol LGA 226	14	50
FIN3251RT	1213.055	LOMBARDINI Benzina Petrol LKA 226	14	52
FIN3251RT	1213.055	LOMBARDINI Benzina Petrol LKA 226	14	52
FIN326AF	0037004070	RUGGERINI RD 290	18	60
FIN3283GR	3030.028	INTERMOTOR Benzina Petrol IM 250	14	1
FIN3283GR	3030.028	INTERMOTOR Benzina Petrol IM 302	14	13
FIN3283GR	3030.028	INTERMOTOR Benzina Petrol IM 350	14	17
FIN3283GR	3030.028	INTERMOTOR Benzina Petrol IM 352	14	21
FIN3283GR	3030.028	INTERMOTOR Benzina Petrol IM 359	14	25
FIN3283GR	3030.028	INTERMOTOR Benzina Petrol IM 252	14	5
FIN3283GR	3030.028	INTERMOTOR Benzina Petrol IM 300	14	9
FIN331AF	3700.213	SLANZI DVA 1030 S	15	10
FIN331AF	3700.213	SLANZI DVA 920	15	4
FIN331AF	3700.213	SLANZI DVA 1030	15	8
FIN332AF	3700.236	SLANZI DVA 1550	15	12
FIN3348KIT		ACME AD 116	16	16
FIN3348KIT		RUGGERINI RD 920	18	38
FIN3348KIT		RUGGERINI RD 920 L	18	40
FIN334PB	1585.090	SLANZI DVA 1500	15	27
FIN334PB	1585.090	SLANZI DVA 2200	15	29
FIN334PB	1585.090	SLANZI DVA 2900	15	31
FIN335PB	1585.091	SLANZI DS 2000	15	39
FIN335PB	1585.091	SLANZI DS 3000	15	41
FIN335PB	1585.091	SLANZI DS 4000	15	43
FIN3380KIT		RUGGERINI RD 901/2	18	36
FIN3381KIT		RUGGERINI RD 900	18	22

Ricambi non originali per motori. Denominazioni e codici originali, sono riportati a puro titolo di riferimento.

21 - A

rel. 1511

Non original engine parts. OEMs names and part numbers are for reference purpose only.

Tavole di corrispondenza

Cross references

Finimpianti	OEM	Costruttore-Motore Manufacturer-Engine	Cp.	Pg.
FIN340DV	956.43	RUGGERINI MD 300	19	10
FIN340DV	956.43	RUGGERINI MD 301	19	12
FIN340DV	956.43	RUGGERINI MD 85.0	19	14
FIN340DV	956.43	RUGGERINI MD 85.1	19	16
FIN340DV	956.43	RUGGERINI MD 95.0	19	18
FIN340DV	956.43	RUGGERINI MD 75.0	19	2
FIN340DV	956.43	RUGGERINI MD 95.1	19	20
FIN340DV	956.43	RUGGERINI MD 170	19	22
FIN340DV	956.43	RUGGERINI MD 171	19	24
FIN340DV	956.43	RUGGERINI MD 190	19	26
FIN340DV	956.43	RUGGERINI MD 191	19	28
FIN340DV	956.43	RUGGERINI MD 350	19	30
FIN340DV	956.43	RUGGERINI MD 351	19	32
FIN340DV	956.43	RUGGERINI MD 75.1	19	4
FIN340DV	956.43	RUGGERINI MD 150	19	6
FIN340DV	956.43	RUGGERINI MD 151	19	8
FIN342FE	2175.065	SLANZI DVA 1550 S	15	14
FIN342FE	2175.065	SLANZI DVA 1750	15	22
FIN342FE	2175.065	SLANZI DVA 1750 S	15	24
FIN342FE	2175.065	SLANZI DVA 1800	15	34
FIN342FE	2175.065	SLANZI DS 2000	15	40
FIN342FE	2175.065	SLANZI DVA 1500	15	45
FIN345FE	0021750450	RUGGERINI RY 75	20	10
FIN345FE	0021750450	RUGGERINI RY 50	20	25
FIN345FE	0021750450	RUGGERINI RY 70	20	4
FIN346FE	0021750460	RUGGERINI RD 290	18	60
FIN346FE	0021750460	RUGGERINI SP 420	18	62
FIN350HG	0047306070	RUGGERINI RY 50	20	2
FIN351DV	956.51	RUGGERINI RD 188	18	10
FIN351DV	956.51	RUGGERINI RD 200	18	16
FIN351DV	956.51	RUGGERINI RD 201	18	18
FIN351DV	956.51	RUGGERINI RD 208	18	20
FIN351DV	956.51	RUGGERINI RD 210	18	28
FIN351DV	956.51	RUGGERINI RD 211	18	30
FIN351DV	956.51	RUGGERINI RD 218	18	32
FIN351DV	956.51	RUGGERINI RD 180	18	6
FIN351DV	956.51	RUGGERINI RD 181	18	8
FIN351HG	0047306090	RUGGERINI RY 50	20	2
FIN352HG	0047304740	RUGGERINI RY 70	20	4
FIN353HG	0047304760	RUGGERINI RY 70	20	4
FIN354HG	0047307350	RUGGERINI RY 75	20	10
FIN355HG	0047307370	RUGGERINI RY 75	20	10
FIN356HG	0047307510	RUGGERINI RY 103	20	12
FIN357HG	0047307530	RUGGERINI RY 103	20	12
FIN3589RTS (FIN526RT + FIN3215RT)	2289	ACME ALN 290 W, ALN 330 W	16	63
FIN3589RTS (FIN526RT + FIN3215RT)	A2335	ACME VT 88 W, AL 480	16	63
FIN358HG	0047307590	RUGGERINI RY 103	20	12
FIN358VA	0011571580	RUGGERINI SP 420	18	62
FIN3590RTS (FIN3215RT + FIN527RT)	B0005	ACME ADX 300, ADX 370	16	63
FIN359HG	0047307610	RUGGERINI RY 103	20	12
FIN360HG	0047307540	RUGGERINI RY 110	20	18
FIN361HG	0047307560	RUGGERINI RY 110	20	18
FIN362HG	0047307620	RUGGERINI RY 110	20	18
FIN363HG	0047307640	RUGGERINI RY 110	20	18
FIN3700BR	3001.070	INTERMOTOR Benzina Petrol IM 250	14	1
FIN3700BR	3001.070	INTERMOTOR Benzina Petrol IM 300	14	11
FIN3700BR	3001.070	INTERMOTOR Benzina Petrol IM 302	14	13
FIN3700BR	3001.070	INTERMOTOR Benzina Petrol IM 302	14	15
FIN3700BR	3001.070	INTERMOTOR Benzina Petrol IM 350	14	17
FIN3700BR	3001.070	INTERMOTOR Benzina Petrol IM 350	14	19
FIN3700BR	3001.070	INTERMOTOR Benzina Petrol IM 352	14	21
FIN3700BR	3001.070	INTERMOTOR Benzina Petrol IM 352	14	23
FIN3700BR	3001.070	INTERMOTOR Benzina Petrol IM 359	14	25
FIN3700BR	3001.070	INTERMOTOR Benzina Petrol IM 359	14	27
FIN3700BR	3001.070	INTERMOTOR Benzina Petrol IM 250	14	3
FIN3700BR	3001.070	INTERMOTOR Benzina Petrol IM 252	14	5
FIN3700BR	3001.070	INTERMOTOR Benzina Petrol IM 252	14	7
FIN3700BR	3001.070	INTERMOTOR Benzina Petrol IM 300	14	9
FIN370EG	0045000790	RUGGERINI RD 290	18	60
FIN370EG	0045000790	RUGGERINI SP 420	18	62
FIN370EG	0045000790	RUGGERINI RY 75	20	10
FIN378AF	388.78	RUGGERINI MD 300	19	10
FIN378AF	388.78	RUGGERINI MD 301	19	12
FIN378AF	388.78	RUGGERINI MD 350	19	30
FIN378AF	388.78	RUGGERINI MD 351	19	32

Finimpianti	OEM	Costruttore-Motore Manufacturer-Engine	Cp.	Pg.
FIN382EG	0045011130	RUGGERINI RY 103	20	12
FIN382EG	0045011130	RUGGERINI RY 110	20	18
FIN382EG	0045011130	RUGGERINI RY 85.0	20	6
FIN388AF	3700.215	SLANZI DVA 1550 S	15	14
FIN388AF	3700.215	SLANZI DVA 1750	15	22
FIN388HG	4730.009	INTERMOTOR LA 490	14	38
FIN388HG	4730.009	INTERMOTOR LAP 490	14	40
FIN389HG	4730.028	INTERMOTOR LA 300	14	34
FIN389HG	4730.028	INTERMOTOR LAP 300	14	36
FIN390HG	4730.530	INTERMOTOR IM 250	14	2
FIN390HG	4730.530	INTERMOTOR IM 250	14	4
FIN390HG	4730.530	INTERMOTOR IM 252	14	6
FIN390HG	4730.530	INTERMOTOR IM 252	14	8
FIN391HG	4730.531	INTERMOTOR IM 300	14	10
FIN391HG	4730.531	INTERMOTOR IM 300	14	12
FIN392HG	4730.537	INTERMOTOR IM 302	14	14
FIN392HG	4730.537	INTERMOTOR IM 302	14	16
FIN392HG	4730.537	INTERMOTOR IM 350	14	18
FIN392HG	4730.537	INTERMOTOR IM 350	14	20
FIN392HG	4730.537	INTERMOTOR IM 352	14	22
FIN392HG	4730.537	INTERMOTOR IM 352	14	24
FIN392HG	4730.537	INTERMOTOR IM 359	14	26
FIN392HG	4730.537	INTERMOTOR IM 359	14	28
FIN393HG	4730.014	INTERMOTOR LA 250	14	30
FIN393HG	4730.014	INTERMOTOR LAP 250	14	32
FIN396FE	0037300960	RUGGERINI RY 103	20	12
FIN396FE	0037300960	RUGGERINI RY 110	20	18
FIN396FE	0037300960	RUGGERINI RY 50	20	2
FIN396FE	3730.096	RUGGERINI RY 70	20	25
FIN4002CGA		ACME AL 480	16	62
FIN4002CGB	A2336	ACME AL 480	16	62
FIN4003CGA		ACME VT 88 W	16	60
FIN4003CGB	A2337	ACME VT 88 W	16	60
FIN4004CGA		ACME ALN 290 W	16	2
FIN4004CGA		ACME ALN 330 W	16	4
FIN4004CGB	A2413	ACME ALN 290 W	16	2
FIN4004CGB	A2413	ACME ALN 330 W	16	4
FIN402AF	3700.221	SLANZI DVA 1750 S	15	24
FIN402AF	3700.221	SLANZI DVA 2350	15	26
FIN402E	660.112	ACME ADN 54	16	40
FIN402NO	644.112	ACME ADN 37 W	16	20
FIN402NO	644.112	ACME ADN 43 W	16	24
FIN402NO	644.112	ACME ADN 45 W	16	30
FIN402NO	644.112	ACME ADN 48	16	34
FIN402NO	644.112	ACME ADN 48 W	16	36
FIN402NO	644.112	ACME ADN 54	16	38
FIN402NO	644.112	ACME ADN 54	16	40
FIN402NO	644.112	ACME ADN 54 W	16	42
FIN402NO	644.112	ACME ADN 60	16	44
FIN402NO	644.112	ACME ADN 60	16	46
FIN402RS00	A2618	RUGGERINI RY 120	20	19
FIN402RS00	A2618	RUGGERINI RY 121	20	21
FIN402RS00	A2618	RUGGERINI RY 125	20	23
FIN402RS05		RUGGERINI RY 120	20	19
FIN402RS05		RUGGERINI RY 121	20	21
FIN402RS05		RUGGERINI RY 125	20	23
FIN402RS10		RUGGERINI RY 120	20	19
FIN402RS10		RUGGERINI RY 121	20	21
FIN402RS10		RUGGERINI RY 125	20	23
FIN403HG	0047306520	RUGGERINI RY 70	20	4
FIN403RS00	A2617	RUGGERINI RY 100	20	13
FIN403RS00	A2617	RUGGERINI RY 101	20	15
FIN403SM	A2274	RUGGERINI MD 350	19	30
FIN403SM	A2274	RUGGERINI MD 351	19	32
FIN403TL	563.78	RUGGERINI RY 100	20	14
FIN403TL	563.78	RUGGERINI RY 101	20	16
FIN403TL	563.78	RUGGERINI RY 120	20	20
FIN403TL	563.78	RUGGERINI RY 121	20	22
FIN403TL	563.78	RUGGERINI RY 125	20	24
FIN403TL	563.78	RUGGERINI RY 85.0	20	6
FIN403TL	563.78	RUGGERINI RY 85.1	20	8
FIN404HG	0047306560	RUGGERINI RY 70	20	4
FIN405HG	0047307480	RUGGERINI RY 75	20	10
FIN405NO	644.104	ACME ADX 300	16	50
FIN405NO	644.104	ACME ADX 370	16	52
FIN405NO	644.104	ACME ADX 600	16	54
FIN405NO	644.104	ACME ADX 740	16	56
FIN405NO	644.104	ACME ADX 742	16	58
FIN405RS00	8211.116	SLANZI DVA 650	15	15
FIN405RS05	8211.117	SLANZI DVA 650	15	15
FIN405RS10	8211.118	SLANZI DVA 650	15	15
FIN406HG	0047307500	RUGGERINI RY 75	20	10
FIN410NO	0065314350	RUGGERINI RY 70	20	4
FIN4114CR STD	1640.113	SLANZI DVA 1800	15	33
FIN4114CR STD	1640.113	SLANZI DVA 2700	15	35
FIN4114CR STD	1640.113	SLANZI DVA 3600	15	37
FIN4114CR STD	1640.113	SLANZI DS 2000	15	39
FIN4114CR STD	1640.113	SLANZI DS 3000	15	41
FIN4114CR STD	1640.113	SLANZI DS 4000	15	43
FIN411NO	0065314470	RUGGERINI RY 75	20	10
FIN420E	660.24	RUGGERINI MD 300	19	10
FIN420E	660.24	RUGGERINI MD 301	19	12
FIN420E	660.24	RUGGERINI MD 85.0	19	14
FIN420E	660.24	RUGGERINI MD 85.1	19	16

Ricambi non originali per motori. Denominazioni e codici originali, sono riportati a puro titolo di riferimento.

Tavole di corrispondenza

Cross references

Finimpianti	OEM	Costruttore-Motore Manufacturer-Engine	Cp.	Pg.
FIN420E	660.24	RUGGERINI MD 95.0	19	18
FIN420E	660.24	RUGGERINI MD 75.0	19	2
FIN420E	660.24	RUGGERINI MD 95.1	19	20
FIN420E	660.24	RUGGERINI MD 170	19	22
FIN420E	660.24	RUGGERINI MD 171	19	24
FIN420E	660.24	RUGGERINI MD 190	19	26
FIN420E	660.24	RUGGERINI MD 191	19	28
FIN420E	660.24	RUGGERINI MD 350	19	30
FIN420E	660.24	RUGGERINI MD 351	19	32
FIN420E	660.24	RUGGERINI MD 75.1	19	4
FIN420E	660.24	RUGGERINI MD 150	19	6
FIN420E	660.24	RUGGERINI MD 151	19	8
FIN4225OF	0021751950	RUGGERINI RY 125	20	24
FIN4225OF	175.005	ACME AD 114 / A	16	10
FIN4225OF	175.005	ACME AD 114	16	12
FIN4225OF	175.005	ACME AD 112	16	14
FIN4225OF	175.005	ACME AD 116	16	16
FIN4225OF	175.005	ACME ADN 37	16	18
FIN4225OF	175.005	ACME ADN 37 W	16	20
FIN4225OF	175.005	ACME ADN 43	16	22
FIN4225OF	175.005	ACME ADN 43 W	16	24
FIN4225OF	175.005	ACME ADN 45	16	26
FIN4225OF	175.005	ACME ADN 45	16	28
FIN4225OF	175.005	ACME ADN 45 W	16	30
FIN4225OF	175.005	ACME ADN 48	16	32
FIN4225OF	175.005	ACME ADN 48	16	34
FIN4225OF	175.005	ACME ADN 48 W	16	36
FIN4225OF	175.005	ACME ADN 54	16	38
FIN4225OF	175.005	ACME ADN 54	16	40
FIN4225OF	175.005	ACME ADN 54 W	16	42
FIN4225OF	175.005	ACME ADN 60	16	44
FIN4225OF	175.005	ACME ADN 60	16	46
FIN4225OF	175.005	ACME ADN 60 W	16	48
FIN4225OF	175.005	ACME ADX 300	16	50
FIN4225OF	175.005	ACME ADX 370	16	52
FIN4225OF	175.005	ACME ADX 600	16	54
FIN4225OF	175.005	ACME ADX 740	16	56
FIN4225OF	175.005	ACME ADX 742	16	58
FIN4225OF	175.005	ACME AD 108	16	6
FIN4225OF	175.005	ACME AD 110	16	8
FIN4225OF	175.05	RUGGERINI RF 88	17	10
FIN4225OF	175.05	RUGGERINI RF 90	17	12
FIN4225OF	175.05	RUGGERINI RF 91	17	14
FIN4225OF	175.05	RUGGERINI RF 100	17	16
FIN4225OF	175.05	RUGGERINI RF 120	17	18
FIN4225OF	175.05	RUGGERINI MC 70	17	2
FIN4225OF	175.05	RUGGERINI RF 121	17	20
FIN4225OF	175.05	RUGGERINI RF 130	17	22
FIN4225OF	175.05	RUGGERINI RF 140	17	24
FIN4225OF	175.05	RUGGERINI RF 148	17	26
FIN4225OF	175.05	RUGGERINI MC 71	17	4
FIN4225OF	175.05	RUGGERINI RF 80	17	6
FIN4225OF	175.05	RUGGERINI RF 81	17	8
FIN4225OF	175.05	RUGGERINI RD 850	18	12
FIN4225OF	175.05	RUGGERINI RD 901/A	18	14
FIN4225OF	175.05	RUGGERINI RD 80	18	2
FIN4225OF	175.05	RUGGERINI RD 900	18	22
FIN4225OF	175.05	RUGGERINI RD 901	18	24
FIN4225OF	175.05	RUGGERINI RD 901/AD	18	26
FIN4225OF	175.05	RUGGERINI RD 920	18	38
FIN4225OF	175.05	RUGGERINI RD 81	18	4
FIN4225OF	175.05	RUGGERINI RD 920 L	18	40
FIN4225OF	175.05	RUGGERINI RD 950	18	50
FIN4225OF	175.05	RUGGERINI RD 950 L	18	52
FIN4225OF	175.05	RUGGERINI MD 85.0	19	14
FIN4225OF	175.05	RUGGERINI MD 85.1	19	16
FIN4225OF	175.05	RUGGERINI MD 95.0	19	18
FIN4225OF	175.05	RUGGERINI MD 75.0	19	2
FIN4225OF	175.05	RUGGERINI MD 95.1	19	20
FIN4225OF	175.05	RUGGERINI MD 170	19	22
FIN4225OF	175.05	RUGGERINI MD 171	19	24
FIN4225OF	175.05	RUGGERINI MD 75.1	19	4
FIN4225OF	175.05	RUGGERINI MD 150	19	6
FIN4225OF	175.05	RUGGERINI MD 151	19	8
FIN4225OF	175.05	RUGGERINI RY 100	20	14
FIN4225OF	175.05	RUGGERINI RY 101	20	16
FIN4225OF	175.05	RUGGERINI RY 120	20	20
FIN4225OF	175.05	RUGGERINI RY 121	20	22
FIN4225OF	175.05	RUGGERINI RY 85.0	20	6
FIN4225OF	175.05	RUGGERINI RY 85.1	20	8
FIN4226FE	175.28	RUGGERINI RF 120, RF 121, RF 140	17	27
FIN4227FE	391.012	ACME AD 114 / A	16	10
FIN4227FE	391.012	ACME AD 114	16	12
FIN4227FE	391.012	ACME AD 112	16	14
FIN4227FE	391.012	ACME AD 116	16	16
FIN4227FE	391.012	ACME ADN 37	16	18
FIN4227FE	391.012	ACME ADN 37 W	16	20
FIN4227FE	391.012	ACME ADN 43	16	22
FIN4227FE	391.012	ACME ADN 43 W	16	24
FIN4227FE	391.012	ACME ADN 45	16	26
FIN4227FE	391.012	ACME ADN 45	16	28
FIN4227FE	391.012	ACME ADN 45 W	16	30
FIN4227FE	391.012	ACME ADN 48	16	32

Finimpianti	OEM	Costruttore-Motore Manufacturer-Engine	Cp.	Pg.
FIN4227FE	391.012	ACME ADN 48	16	34
FIN4227FE	391.012	ACME ADN 48 W	16	36
FIN4227FE	391.012	ACME ADN 54	16	38
FIN4227FE	391.012	ACME ADN 54	16	40
FIN4227FE	391.012	ACME ADN 54 W	16	42
FIN4227FE	391.012	ACME ADN 60	16	44
FIN4227FE	391.012	ACME ADN 60	16	46
FIN4227FE	391.012	ACME ADN 60 W	16	48
FIN4227FE	391.012	ACME ADX 742	16	58
FIN4227FE	391.012	ACME AD 108	16	6
FIN4227FE	391.012	ACME AD 110	16	8
FIN4228OF	395.15	RUGGERINI RY	20	25
FIN4231FE	175.23	RUGGERINI RF 88	17	10
FIN4231FE	175.23	RUGGERINI RF 100	17	16
FIN4231FE	175.23	RUGGERINI RF 120	17	18
FIN4231FE	175.23	RUGGERINI RF 121	17	20
FIN4231FE	175.23	RUGGERINI RF 130	17	22
FIN4231FE	175.23	RUGGERINI RF 140	17	24
FIN4231FE	175.23	RUGGERINI RF 148	17	26
FIN4231FE	175.23	RUGGERINI RD 188	18	10
FIN4231FE	175.23	RUGGERINI RD 200	18	16
FIN4231FE	175.23	RUGGERINI RD 201	18	18
FIN4231FE	175.23	RUGGERINI RD 208	18	20
FIN4231FE	175.23	RUGGERINI RD 210	18	28
FIN4231FE	175.23	RUGGERINI RD 211	18	30
FIN4231FE	175.23	RUGGERINI RD 218	18	32
FIN4231FE	175.23	RUGGERINI RD 180	18	6
FIN4231FE	175.23	RUGGERINI RD 181	18	8
FIN4232FE	175.020	ACME ADX 300	16	50
FIN4232FE	175.020	ACME ADX 370	16	52
FIN4232FE	175.020	ACME ADX 600	16	54
FIN4232FE	175.020	ACME ADX 740	16	56
FIN4232FE	175.020	ACME ADX 37W, ADN 43, ADN 43W, ADN 45, ADN 45W, ADN 48, ADN 48W, ADN 54, ADN 54W, ADN 60, ADN 60W	16	63
FIN4232FE	175.20	RUGGERINI RD 850	18	12
FIN4232FE	175.20	RUGGERINI RD 901/A	18	14
FIN4232FE	175.20	RUGGERINI RD 80	18	2
FIN4232FE	175.20	RUGGERINI RD 900	18	22
FIN4232FE	175.20	RUGGERINI RD 901	18	24
FIN4232FE	175.20	RUGGERINI RD 901/AD	18	26
FIN4232FE	175.20	RUGGERINI RD 920	18	38
FIN4232FE	175.20	RUGGERINI RD 81	18	4
FIN4232FE	175.20	RUGGERINI RD 920 L	18	40
FIN4232FE	175.20	RUGGERINI RD 950	18	50
FIN4232FE	175.20	RUGGERINI RD 950 L	18	52
FIN4232FE	175.20	RUGGERINI P 101	21	10
FIN4232FE	175.20	RUGGERINI P 101 L	21	12
FIN4232FE	175.20	RUGGERINI CRD 951	21	2
FIN4232FE	175.20	RUGGERINI RP 170	21	26
FIN4232FE	175.20	RUGGERINI RP 178	21	28
FIN4232FE	175.20	RUGGERINI CRD 100	21	6
FIN4240FE	175.19	RUGGERINI RD 220	18	34
FIN4240FE	175.19	RUGGERINI RD 901/2	18	36
FIN4240FE	175.19	RUGGERINI RD 240	18	42
FIN4240FE	175.19	RUGGERINI RD 248	18	44
FIN4240FE	175.19	RUGGERINI RD 92/2	18	46
FIN4240FE	175.19	RUGGERINI RD 92/2 L	18	48
FIN4240FE	175.19	RUGGERINI RD 270	18	54
FIN4240FE	175.19	RUGGERINI RD 278	18	56
FIN4240FE	175.19	RUGGERINI RD 952	18	58
FIN4240FE	175.19	RUGGERINI MD 300	19	10
FIN4240FE	175.19	RUGGERINI MD 301	19	12
FIN4240FE	175.19	RUGGERINI MD 350	19	30
FIN4240FE	175.19	RUGGERINI MD 351	19	32
FIN4240FE	175.19	RUGGERINI P 101/2	21	14
FIN4240FE	175.19	RUGGERINI P 101/2 L	21	16
FIN4240FE	175.19	RUGGERINI P 105/2	21	18
FIN4240FE	175.19	RUGGERINI P 105/2 R	21	20
FIN4240FE	175.19	RUGGERINI P 105/2 L	21	22
FIN4240FE	175.19	RUGGERINI RP 280	21	24
FIN4240FE	175.19	RUGGERINI RP 320	21	30
FIN4240FE	175.19	RUGGERINI RP 328	21	32
FIN4240FE	175.19	RUGGERINI RP 360	21	34
FIN4240FE	175.19	RUGGERINI RP 368	21	36
FIN4240FE	175.19	RUGGERINI RP 380	21	38
FIN4240FE	175.19	RUGGERINI CRD 951/2	21	4
FIN4240FE	175.19	RUGGERINI RP 388	21	40
FIN4240FE	175.19	RUGGERINI CRD 100/2	21	8

Ricambi non originali per motori. Denominazioni e codici originali, sono riportati a puro titolo di riferimento.

23 - A

rel. 1511

Non original engine parts. OEMs names and part numbers are for reference purpose only.

Tavole di corrispondenza

Cross references

Finimpianti	OEM	Costruttore-Motore Manufacturer-Engine	Cp.	Pg.
FIN4242OF	175.31	RUGGERINI RD 180, RD 181, RD 188, RD 200, RD 201, RD 208, RD 210, RD 211, RD 218, RD 220, RD 240, RD 270, RD 278	18	63
FIN4243OF	175.25	RUGGERINI RD 180, RD 181, RD 188, RD 200, RD 201, RD 208, RD 210, RD 211, RD 218, RD 220, RD 240, RD 270, RD 278	18	63
FIN4243OF	175.25	RUGGERINI MD 190	19	26
FIN4243OF	175.25	RUGGERINI MD 191	19	28
FIN4243OF	175.25	RUGGERINI MD	19	33
FIN4245OF	175.22	RUGGERINI P 101/2	21	14
FIN4245OF	175.22	RUGGERINI P 101/2 L	21	16
FIN4245OF	175.22	RUGGERINI P 105/2	21	18
FIN4245OF	175.22	RUGGERINI P 105/2 R	21	20
FIN4245OF	175.22	RUGGERINI P 105/2 L	21	22
FIN4245OF	175.22	RUGGERINI RP 280	21	24
FIN4245OF	175.22	RUGGERINI RP 320	21	30
FIN4245OF	175.22	RUGGERINI RP 328	21	32
FIN4245OF	175.22	RUGGERINI RP 360	21	34
FIN4245OF	175.22	RUGGERINI RP 368	21	36
FIN4245OF	175.22	RUGGERINI RP 380	21	38
FIN4245OF	175.22	RUGGERINI CRD 951/2	21	4
FIN4245OF	175.22	RUGGERINI RP 388	21	40
FIN4245OF	175.22	RUGGERINI CRD 100/2	21	8
FIN4247FE	2175.083	SLANZI DVA 1550	15	12
FIN4248OF	2175.090	SLANZI DVA 1550	15	12
FIN4260FE	175.102	ACME ADX 300, ADX 370, ADX 600, ADX 740	16	63
FIN4260OF	2175.091	SLANZI DVA 1750	15	45
FIN4290F	0021751550	RUGGERINI RY 75	20	10
FIN4290F	0021751550	RUGGERINI RY 103	20	12
FIN4290F	0021751550	RUGGERINI RY 110	20	18
FIN4290F	0021751550	RUGGERINI RY 70	20	4
FIN4300FE	3730.041	INTERMOTOR IM 300	14	10
FIN4300FE	3730.041	INTERMOTOR IM 300	14	12
FIN4300FE	3730.041	INTERMOTOR IM 302	14	14
FIN4300FE	3730.041	INTERMOTOR IM 302	14	16
FIN4300FE	3730.041	INTERMOTOR IM 350	14	18
FIN4300FE	3730.041	INTERMOTOR IM 250	14	2
FIN4300FE	3730.041	INTERMOTOR IM 350	14	20
FIN4300FE	3730.041	INTERMOTOR IM 352	14	22
FIN4300FE	3730.041	INTERMOTOR IM 352	14	24
FIN4300FE	3730.041	INTERMOTOR IM 250	14	4
FIN4300FE	3730.041	INTERMOTOR IM 252	14	6
FIN4300FE	3730.041	INTERMOTOR IM 252	14	8
FIN4301FE	3730.049	INTERMOTOR IM 359	14	26
FIN4301FE	3730.049	INTERMOTOR IM 359	14	28
FIN4301FE	3730.049	LOMBARDINI Benzina Petrol LGA 184	14	42
FIN4301FE	3730.049	LOMBARDINI Benzina Petrol LKA 184	14	44
FIN4301FE	3730.049	LOMBARDINI Benzina Petrol LGA 225	14	46
FIN4301FE	3730.049	LOMBARDINI Benzina Petrol LKA 225	14	48
FIN4301FE	3730.049	LOMBARDINI Benzina Petrol LGA 226	14	50
FIN4301FE	3730.049	LOMBARDINI Benzina Petrol LKA 226	14	52
FIN430E	660.101	ACME ADN 37 W	16	20
FIN430E	660.101	ACME ADN 43	16	22
FIN430E	660.101	ACME ADN 43 W	16	24
FIN430E	660.101	ACME ADN 45	16	28
FIN430E	660.101	ACME ADN 45 W	16	30
FIN4330CGA		RUGGERINI RY 75	20	10
FIN4330CGB	8180.199	RUGGERINI RY 75	20	10
FIN4331CGA		RUGGERINI RY 50	20	2
FIN4331CGB	0082051040	RUGGERINI RY 50	20	2
FIN4334CGA		RUGGERINI RY 103	20	12
FIN4334CGA		RUGGERINI RY 110	20	18
FIN4334CGB	0082051250	RUGGERINI RY 103	20	12
FIN4334CGB	0082051250	RUGGERINI RY 110	20	18
FIN436OF	2175.071	SLANZI DVA 1550 S	15	14
FIN436OF	2175.071	SLANZI DVA 1750	15	22
FIN436OF	2175.071	SLANZI DVA 1750 S	15	24
FIN436OF	2175.071	SLANZI DVA 2350	15	26
FIN436OF	2175.071	SLANZI DVA 1500	15	45
FIN438OP	2197	RUGGERINI P 101/2	21	14
FIN438OP	2197	RUGGERINI P 101/2 L	21	16
FIN438OP	2197	RUGGERINI P 105/2	21	18
FIN438OP	2197	RUGGERINI P 105/2 R	21	20

Finimpianti	OEM	Costruttore-Motore Manufacturer-Engine	Cp.	Pg.
FIN438OP	2197	RUGGERINI P 105/2 L	21	22
FIN438OP	2197	RUGGERINI RP 280	21	24
FIN438OP	2197	RUGGERINI RP 320	21	30
FIN438OP	2197	RUGGERINI RP 328	21	32
FIN438OP	2197	RUGGERINI RP 360	21	34
FIN438OP	2197	RUGGERINI RP 368	21	36
FIN438OP	2197	RUGGERINI RP 380	21	38
FIN438OP	2197	RUGGERINI CRD 951/2	21	4
FIN438OP	2197	RUGGERINI RP 388	21	40
FIN438OP	2197	RUGGERINI CRD 100/2	21	8
FIN440E	660.102	ACME ADN 48	16	34
FIN440E	660.102	ACME ADN 48 W	16	36
FIN440E	660.102	ACME ADN 54 W	16	42
FIN440E	660.102	ACME ADN 60	16	46
FIN440E	660.102	ACME ADN 60 W	16	48
FIN440OF	0021750400	RUGGERINI RD 290	18	60
FIN440OF	0021750400	RUGGERINI SP 420	18	62
FIN4450CGA		RUGGERINI MD 85.0	19	14
FIN4450CGA		RUGGERINI MD 85.1	19	16
FIN4450CGA		RUGGERINI MD 95.0	19	18
FIN4450CGA		RUGGERINI MD 95.1	19	20
FIN4450CGB	A2228	RUGGERINI MD 85.0	19	14
FIN4450CGB	A2228	RUGGERINI MD 85.1	19	16
FIN4450CGB	A2228	RUGGERINI MD 95.0	19	18
FIN4450CGB	A2228	RUGGERINI MD 95.1	19	20
FIN4451CGA		RUGGERINI RD 188	18	10
FIN4451CGA		RUGGERINI RD 180	18	6
FIN4451CGA		RUGGERINI RD 181	18	8
FIN4451CGB	2932	RUGGERINI RD 188	18	10
FIN4451CGB	2932	RUGGERINI RD 180	18	6
FIN4451CGB	2932	RUGGERINI RD 181	18	8
FIN4452CGA		RUGGERINI MD 170	19	22
FIN4452CGA		RUGGERINI MD 171	19	24
FIN4452CGA		RUGGERINI MD 190	19	26
FIN4452CGA		RUGGERINI MD 191	19	28
FIN4452CGB	A2291	RUGGERINI MD 170	19	22
FIN4452CGB	A2291	RUGGERINI MD 171	19	24
FIN4452CGB	A2291	RUGGERINI MD 190	19	26
FIN4452CGB	A2291	RUGGERINI MD 191	19	28
FIN4462CGA		RUGGERINI MD 300	19	10
FIN4462CGA		RUGGERINI MD 301	19	12
FIN4462CGB	A2287	RUGGERINI MD 300	19	10
FIN4462CGB	A2287	RUGGERINI MD 301	19	12
FIN450E	660.104	ACME ADX 300	16	50
FIN450E	660.104	ACME ADX 370	16	52
FIN450E	660.104	ACME ADX 600	16	54
FIN450E	660.104	ACME ADX 740	16	56
FIN450E	660.104	ACME ADX 742	16	58
FIN4585CGA		ACME ADN 37	16	18
FIN4585CGA		ACME ADN 37 W	16	20
FIN4585CGB	A2491	ACME ADN 37	16	18
FIN4585CGB	A2491	ACME ADN 37 W	16	20
FIN458AF	388.54	RUGGERINI RD 188	18	10
FIN458AF	388.54	RUGGERINI RD 200	18	16
FIN458AF	388.54	RUGGERINI RD 201	18	18
FIN458AF	388.54	RUGGERINI RD 208	18	20
FIN458AF	388.54	RUGGERINI RD 210	18	28
FIN458AF	388.54	RUGGERINI RD 211	18	30
FIN458AF	388.54	RUGGERINI RD 218	18	32
FIN458AF	388.54	RUGGERINI RD 180	18	6
FIN458AF	388.54	RUGGERINI RD 181	18	8
FIN4609CGA		RUGGERINI RD 290	18	60
FIN4609CGB	0082050990	RUGGERINI RD 290	18	60
FIN468PN	0084800290	RUGGERINI RD 290	18	59
FIN468PN	0084800290	RUGGERINI SP 420	18	61
FIN470IG	0045000670	RUGGERINI RY 75	20	10
FIN470IG	0045000670	RUGGERINI RY 103	20	12
FIN470IG	0045000670	RUGGERINI RY 110	20	18
FIN470IG	0045000670	RUGGERINI RY 50	20	2
FIN470IG	0045000670	RUGGERINI RY 70	20	4
FIN473AF	0037003740	RUGGERINI RY 75	20	10
FIN473AF	0037003740	RUGGERINI RY 103	20	12
FIN473AF	0037003740	RUGGERINI RY 110	20	18
FIN473AF	0037003740	RUGGERINI RY 50	20	2
FIN473AF	0037003740	RUGGERINI RY 70	20	4
FIN4752RS00		ACME VT 88 W, AL 480	16	63
FIN4752RS05		ACME VT 88 W, AL 480	16	63
FIN4752RS10		ACME VT 88 W, AL 480	16	63
FIN476IG	0044200200	RUGGERINI RD 290	18	60
FIN476IG	0044200200	RUGGERINI SP 420	18	62
FIN480OP	2321	RUGGERINI RD 188	18	10
FIN480OP	2321	RUGGERINI RD 200	18	16
FIN480OP	2321	RUGGERINI RD 201	18	18
FIN480OP	2321	RUGGERINI RD 208	18	20
FIN480OP	2321	RUGGERINI RD 210	18	28
FIN480OP	2321	RUGGERINI RD 211	18	30
FIN480OP	2321	RUGGERINI RD 218	18	32
FIN480OP	2321	RUGGERINI RD 220	18	34
FIN480OP	2321	RUGGERINI RD 901/2	18	36
FIN480OP	2321	RUGGERINI RD 240	18	42
FIN480OP	2321	RUGGERINI RD 248	18	44

Ricambi non originali per motori. Denominazioni e codici originali, sono riportati a puro titolo di riferimento.

24 - A

rel. 1511

Non original engine parts. OEMs names and part numbers are for reference purpose only.

Tavole di corrispondenza

Cross references

Finimpianti	OEM	Costruttore-Motore <i>Manufacturer-Engine</i>	Cp.	Pg.
FIN480OP	2321	RUGGERINI RD 92/2	18	46
FIN480OP	2321	RUGGERINI RD 92/2 L	18	48
FIN480OP	2321	RUGGERINI RD 270	18	54
FIN480OP	2321	RUGGERINI RD 278	18	56
FIN480OP	2321	RUGGERINI RD 952	18	58
FIN480OP	2321	RUGGERINI RD 180	18	6
FIN480OP	2321	RUGGERINI RD 181	18	8
FIN4823CGA		SLANZI DVA 1550 S	15	14
FIN4823CGB	8180.097	SLANZI DVA 1550 S	15	14
FIN4824CGB		SLANZI DVA 680	15	18
FIN4825CGA		SLANZI DVA 1200	15	20
FIN4825CGB		SLANZI DVA 1200	15	20
FIN482PN	0084800890	RUGGERINI RY 70	20	3
FIN4845CGA		LOMBARDINI Benzina Petrol LGA 226	14	50
FIN4845CGA		LOMBARDINI Benzina Petrol LKA 226	14	52
FIN4845CGB	8180.202	LOMBARDINI Benzina Petrol LGA 226	14	50
FIN4845CGB	8180.202	LOMBARDINI Benzina Petrol LKA 226	14	52
FIN487PC00	A2284	RUGGERINI MD 301	19	11
FIN487PC00	A2284	RUGGERINI MD 300	19	9
FIN487PC05		RUGGERINI MD 301	19	11
FIN487PC05		RUGGERINI MD 300	19	9
FIN487PC10		RUGGERINI MD 301	19	11
FIN487PC10		RUGGERINI MD 300	19	9
FIN488HG	0047301930	RUGGERINI RD 290	18	60
FIN488HG	0047301930	RUGGERINI SP 420	18	62
FIN488PC00	A2012	RUGGERINI RD 180	18	5
FIN488PC00	A2012	RUGGERINI RD 181	18	7
FIN488PC00	A2012	RUGGERINI RD 188	18	9
FIN488PC05	A2013	RUGGERINI RD 180	18	5
FIN488PC05	A2013	RUGGERINI RD 181	18	7
FIN488PC05	A2013	RUGGERINI RD 188	18	9
FIN488PC10	A2014	RUGGERINI RD 180	18	5
FIN488PC10	A2014	RUGGERINI RD 181	18	7
FIN488PC10	A2014	RUGGERINI RD 188	18	9
FIN488SL00	203.52	RUGGERINI RD 180	18	5
FIN488SL00	203.52	RUGGERINI RD 181	18	7
FIN488SL00	203.52	RUGGERINI RD 188	18	9
FIN489HG	0047300850	RUGGERINI RD 290	18	60
FIN489HG	0047300850	RUGGERINI SP 420	18	62
FIN489PC00	2336	ACME ADN 37	16	17
FIN489PC00	2336	RUGGERINI RD 80	18	1
FIN489PC00	2336	RUGGERINI RD 81	18	3
FIN489PC05	2337	ACME ADN 37	16	17
FIN489PC05	2337	RUGGERINI RD 80	18	1
FIN489PC05	2337	RUGGERINI RD 81	18	3
FIN489PC10	2338	ACME ADN 37	16	17
FIN489PC10	2338	RUGGERINI RD 80	18	1
FIN489PC10	2338	RUGGERINI RD 81	18	3
FIN489SL00	203.010	ACME ADN 48	16	31
FIN489SL00	203.010	ACME ADN 48	16	33
FIN489SL00	203.010	ACME ADN 48 W	16	35
FIN489SL00	203.010	ACME AD 108	16	5
FIN489SL00	203.010	ACME AD 110	16	7
FIN489SL00	203.010	ACME AD 114 / A	16	9
FIN489SL00	203.10	RUGGERINI RF 100	17	15
FIN489SL00	203.10	RUGGERINI RD 850	18	11
FIN489SL00	203.10	RUGGERINI RD 901/A	18	13
FIN490SL00	203.129	ACME ADX 300	16	49
FIN490SL00	203.129	ACME ADX 600	16	53
FIN491SL00	203.130	ACME ADX 370	16	51
FIN491SL00	203.130	ACME ADX 740	16	55
FIN491SL00	203.130	ACME ADX 742	16	57
FIN492VR	730.54	RUGGERINI MD 300	19	10
FIN492VR	730.54	RUGGERINI MD 301	19	12
FIN492VR	730.54	RUGGERINI MD 350	19	30
FIN492VR	730.54	RUGGERINI MD 351	19	32
FIN498PN	0084800980	RUGGERINI RY 75	20	9
FIN499PN	0084800990	RUGGERINI RY 50	20	1
FIN5012PF	060.06	RUGGERINI RF 88	17	10
FIN5012PF	060.06	RUGGERINI MC 70	17	2
FIN5012PF	060.06	RUGGERINI RF 130	17	22
FIN5012PF	060.06	RUGGERINI MC 71	17	4
FIN5012PF	060.06	RUGGERINI RF 80	17	6
FIN5012PF	060.06	RUGGERINI RF 81	17	8
FIN5014PF	059.73	RUGGERINI RF 100	17	16
FIN501IG	451.27	RUGGERINI MD 300	19	10
FIN501IG	451.27	RUGGERINI MD 301	19	12
FIN501IG	451.27	RUGGERINI MD 350	19	30
FIN501IG	451.27	RUGGERINI MD 351	19	32
FIN502NH	644.38	RUGGERINI RF 90	17	12
FIN502NH	644.38	RUGGERINI RF 91	17	14
FIN502NH	644.38	RUGGERINI RF 120	17	18
FIN502NH	644.38	RUGGERINI RF 121	17	20
FIN502NH	644.38	RUGGERINI RF 130	17	22
FIN502NH	644.38	RUGGERINI RF 140	17	24
FIN502NH	644.38	RUGGERINI RF 80	17	6
FIN502NH	644.38	RUGGERINI RF 81	17	8
FIN503HG	450.40	RUGGERINI RD 210	18	28
FIN503HG	450.40	RUGGERINI RD 211	18	30
FIN503HG	450.40	RUGGERINI RD 218	18	32

Finimpianti	OEM	Costruttore-Motore <i>Manufacturer-Engine</i>	Cp.	Pg.
FIN503IG	447.081	ACME AD 114 / A	16	10
FIN503IG	447.081	ACME AD 114	16	12
FIN503IG	447.081	ACME AD 112	16	14
FIN503IG	447.081	ACME AD 116	16	16
FIN503IG	447.081	ACME ADN 60 W	16	48
FIN503IG	447.081	ACME AD 108	16	6
FIN503IG	447.081	ACME AD 110	16	8
FIN503IG	448.014	ACME AD 114 / A	16	10
FIN503IG	448.014	ACME AD 114	16	12
FIN503IG	448.014	ACME AD 112	16	14
FIN503IG	448.014	ACME AD 116	16	16
FIN503IG	448.014	ACME ADN 37	16	18
FIN503IG	448.014	ACME ADN 37 W	16	20
FIN503IG	448.014	ACME ADN 37 W	16	22
FIN503IG	448.014	ACME ADN 43	16	22
FIN503IG	448.014	ACME ADN 43 W	16	24
FIN503IG	448.014	ACME ADN 43 W	16	26
FIN503IG	448.014	ACME ADN 45	16	26
FIN503IG	448.014	ACME ADN 45	16	28
FIN503IG	448.014	ACME ADN 45	16	28
FIN503IG	448.014	ACME ADN 45 W	16	30
FIN503IG	448.014	ACME ADN 45 W	16	30
FIN503IG	448.014	ACME ADN 48	16	32
FIN503IG	448.014	ACME ADN 48	16	32
FIN503IG	448.014	ACME ADN 48	16	34
FIN503IG	448.014	ACME ADN 48	16	34
FIN503IG	448.014	ACME ADN 48 W	16	36
FIN503IG	448.014	ACME ADN 48 W	16	36
FIN503IG	448.014	ACME ADN 54	16	38
FIN503IG	448.014	ACME ADN 54	16	38
FIN503IG	448.014	ACME ADN 54	16	40
FIN503IG	448.014	ACME ADN 54	16	40
FIN503IG	448.014	ACME ADN 54 W	16	42
FIN503IG	448.014	ACME ADN 54 W	16	42
FIN503IG	448.014	ACME ADN 60	16	44
FIN503IG	448.014	ACME ADN 60	16	44
FIN503IG	448.014	ACME ADN 60	16	46
FIN503IG	448.014	ACME ADN 60	16	46
FIN503IG	448.014	ACME ADN 60 W	16	48
FIN503IG	448.014	ACME AD 108	16	6
FIN503IG	448.014	ACME AD 110	16	8
FIN503IG	448.14	RUGGERINI RF 88	17	10
FIN503IG	448.14	RUGGERINI RF 88	17	10
FIN503IG	448.14	RUGGERINI RF 90	17	12
FIN503IG	448.14	RUGGERINI RF 90	17	12
FIN503IG	448.14	RUGGERINI RF 91	17	14
FIN503IG	448.14	RUGGERINI RF 91	17	14
FIN503IG	448.14	RUGGERINI RF 100	17	16
FIN503IG	448.14	RUGGERINI RF 100	17	16
FIN503IG	448.14	RUGGERINI RF 120	17	18
FIN503IG	448.14	RUGGERINI RF 120	17	18
FIN503IG	448.14	RUGGERINI MC 70	17	2
FIN503IG	448.14	RUGGERINI MC 70	17	2
FIN503IG	448.14	RUGGERINI RF 121	17	20
FIN503IG	448.14	RUGGERINI RF 121	17	20
FIN503IG	448.14	RUGGERINI RF 130	17	22
FIN503IG	448.14	RUGGERINI RF 130	17	22
FIN503IG	448.14	RUGGERINI RF 140	17	24
FIN503IG	448.14	RUGGERINI RF 140	17	24
FIN503IG	448.14	RUGGERINI RF 148	17	26
FIN503IG	448.14	RUGGERINI RF 148	17	26
FIN503IG	448.14	RUGGERINI MC 71	17	4
FIN503IG	448.14	RUGGERINI MC 71	17	4
FIN503IG	448.14	RUGGERINI RF 80	17	6
FIN503IG	448.14	RUGGERINI RF 80	17	6
FIN503IG	448.14	RUGGERINI RF 81	17	8
FIN503IG	448.14	RUGGERINI RF 81	17	8
FIN503IG	448.14	RUGGERINI RD 188	18	10
FIN503IG	448.14	RUGGERINI RD 850	18	12
FIN503IG	448.14	RUGGERINI RD 850	18	12
FIN503IG	448.14	RUGGERINI RD 901/A	18	14
FIN503IG	448.14	RUGGERINI RD 901/A	18	14
FIN503IG	448.14	RUGGERINI RD 200	18	16
FIN503IG	448.14	RUGGERINI RD 201	18	18
FIN503IG	448.14	RUGGERINI RD 80	18	2
FIN503IG	448.14	RUGGERINI RD 80	18	2
FIN503IG	448.14	RUGGERINI RD 208	18	20
FIN503IG	448.14	RUGGERINI RD 900	18	22
FIN503IG	448.14	RUGGERINI RD 900	18	22
FIN503IG	448.14	RUGGERINI RD 901	18	24
FIN503IG	448.14	RUGGERINI RD 901	18	24
FIN503IG	448.14	RUGGERINI RD 901/AD	18	26
FIN503IG	448.14	RUGGERINI RD 901/AD	18	26
FIN503IG	448.14	RUGGERINI RD 210	18	28
FIN503IG	448.14	RUGGERINI RD 211	18	30
FIN503IG	448.14	RUGGERINI RD 218	18	32
FIN503IG	448.14	RUGGERINI RD 920	18	38
FIN503IG	448.14	RUGGERINI RD 920	18	38
FIN503IG	448.14	RUGGERINI RD 81	18	4
FIN503IG	448.14	RUGGERINI RD 81	18	4
FIN503IG	448.14	RUGGERINI RD 920 L	18	40

Tavole di corrispondenza

Cross references

Finimpianti	OEM	Costruttore-Motore Manufacturer-Engine	Cp.	Pg.
FIN503IG	448.14	RUGGERINI RD 920 L	18	40
FIN503IG	448.14	RUGGERINI RD 950	18	50
FIN503IG	448.14	RUGGERINI RD 950	18	50
FIN503IG	448.14	RUGGERINI RD 950 L	18	52
FIN503IG	448.14	RUGGERINI RD 180	18	6
FIN503IG	448.14	RUGGERINI RD 181	18	8
FIN503IG	448.14	RUGGERINI MD 150, MD 151, MD 170, MD 171, MD 190, MD 191	19	33
FIN503IG	448.14	RUGGERINI RY 85.0, RY 85.1, RY 100, RY 101	20	25
FIN503NH	644.51	RUGGERINI RF 88	17	10
FIN503NH	644.51	RUGGERINI MC 70	17	2
FIN503NH	644.51	RUGGERINI RF 148	17	26
FIN503NH	644.51	RUGGERINI MC 71	17	4
FIN503PN	0084801030	RUGGERINI RY 103	20	11
FIN503PN	0084801030	RUGGERINI RY 110	20	17
FIN504EG	450.13	RUGGERINI RD 188	18	10
FIN504EG	450.13	RUGGERINI RD 200	18	16
FIN504EG	450.13	RUGGERINI RD 201	18	18
FIN504EG	450.13	RUGGERINI RD 208	18	20
FIN504EG	450.13	RUGGERINI RD 210	18	28
FIN504EG	450.13	RUGGERINI RD 211	18	30
FIN504EG	450.13	RUGGERINI RD 218	18	32
FIN504EG	450.13	RUGGERINI RD 180	18	6
FIN504EG	450.13	RUGGERINI RD 181	18	8
FIN504HG	453.28	RUGGERINI RY 120	20	20
FIN504HG	453.28	RUGGERINI RY 121	20	22
FIN504HG	453.28	RUGGERINI RY 125	20	24
FIN504NH	644.32	RUGGERINI RF 100	17	16
FIN505HG	435.37	RUGGERINI RY 100	20	14
FIN505HG	435.37	RUGGERINI RY 101	20	16
FIN505IG	453.23	RUGGERINI RY 100	20	14
FIN505IG	453.23	RUGGERINI RY 101	20	16
FIN505IG	453.23	RUGGERINI RY 120	20	20
FIN505IG	453.23	RUGGERINI RY 121	20	22
FIN505IG	453.23	RUGGERINI RY 125	20	24
FIN505IG	453.23	RUGGERINI RY 85.0	20	6
FIN505IG	453.23	RUGGERINI RY 85.1	20	8
FIN506EG	451.24	RUGGERINI MD 300	19	10
FIN506EG	451.24	RUGGERINI MD 301	19	12
FIN506EG	451.24	RUGGERINI MD 75.0	19	2
FIN506EG	451.24	RUGGERINI MD 170	19	22
FIN506EG	451.24	RUGGERINI MD 171	19	24
FIN506EG	451.24	RUGGERINI MD 350	19	30
FIN506EG	451.24	RUGGERINI MD 351	19	32
FIN506EG	451.24	RUGGERINI MD 75.1	19	4
FIN506EG	451.24	RUGGERINI RY 100	20	14
FIN506EG	451.24	RUGGERINI RY 101	20	16
FIN506EG	451.24	RUGGERINI RY 120	20	20
FIN506EG	451.24	RUGGERINI RY 121	20	22
FIN506EG	451.24	RUGGERINI RY 125	20	24
FIN506EG	451.24	RUGGERINI RY 85.1	20	8
FIN508HG	451.15	RUGGERINI MD 85.0	19	14
FIN508HG	451.15	RUGGERINI MD 85.1	19	16
FIN508HG	451.15	RUGGERINI MD 95.0	19	18
FIN508HG	451.15	RUGGERINI MD 95.1	19	20
FIN508HG	451.15	RUGGERINI MD 170	19	22
FIN508HG	451.15	RUGGERINI MD 171	19	24
FIN508HG	451.15	RUGGERINI MD 190	19	26
FIN508HG	451.15	RUGGERINI MD 191	19	28
FIN508HG	451.15	RUGGERINI MD 350	19	30
FIN508HG	451.15	RUGGERINI MD 351	19	32
FIN508IG	450.35	RUGGERINI MD 85.0	19	14
FIN508IG	450.35	RUGGERINI MD 85.1	19	16
FIN508IG	450.35	RUGGERINI MD 95.0	19	18
FIN508IG	450.35	RUGGERINI MD 75.0	19	2
FIN508IG	450.35	RUGGERINI MD 95.1	19	20
FIN508IG	450.35	RUGGERINI MD 170	19	22
FIN508IG	450.35	RUGGERINI MD 171	19	24
FIN508IG	450.35	RUGGERINI MD 190	19	26
FIN508IG	450.35	RUGGERINI MD 191	19	28
FIN508IG	450.35	RUGGERINI MD 75.1	19	4
FIN508IG	450.35	RUGGERINI MD 150	19	6
FIN508IG	450.35	RUGGERINI MD 151	19	8
FIN509HG	453.39	RUGGERINI RY 101	20	16
FIN509SL00	203.127	ACME ADN 43	16	21
FIN509SL00	203.127	ACME ADN 43 W	16	23
FIN510HG	453.33	RUGGERINI RY 85.0	20	6
FIN510HG	453.33	RUGGERINI RY 85.1	20	8
FIN510SL00	203.124	ACME ADN 45	16	25
FIN510SL00	203.124	ACME ADN 45	16	27
FIN510SL00	203.124	ACME ADN 45 W	16	29
FIN511HG	453.35	RUGGERINI RY 85.0	20	6
FIN511HG	453.35	RUGGERINI RY 85.1	20	8
FIN518NH	644.47	RUGGERINI MD 300	19	10
FIN518NH	644.47	RUGGERINI MD 301	19	12

Finimpianti	OEM	Costruttore-Motore Manufacturer-Engine	Cp.	Pg.
FIN518NH	644.47	RUGGERINI MD 85.0	19	14
FIN518NH	644.47	RUGGERINI MD 85.1	19	16
FIN518NH	644.47	RUGGERINI MD 95.0	19	18
FIN518NH	644.47	RUGGERINI MD 75.0	19	2
FIN518NH	644.47	RUGGERINI MD 95.1	19	20
FIN518NH	644.47	RUGGERINI MD 190	19	26
FIN518NH	644.47	RUGGERINI MD 191	19	28
FIN518NH	644.47	RUGGERINI MD 350	19	30
FIN518NH	644.47	RUGGERINI MD 351	19	32
FIN518NH	644.47	RUGGERINI MD 75.1	19	4
FIN518NH	644.47	RUGGERINI MD 150	19	6
FIN518NH	644.47	RUGGERINI MD 151	19	8
FIN520NH	644.54	RUGGERINI MD 170	19	22
FIN520NH	644.54	RUGGERINI MD 171	19	24
FIN521RS00	8211.122	SLANZI DVA 1500	15	27
FIN521RS00	8211.122	SLANZI DVA 2200	15	29
FIN521RS00	8211.122	SLANZI DVA 2900	15	31
FIN521RS05	8211.123	SLANZI DVA 1500	15	27
FIN521RS05	8211.123	SLANZI DVA 2200	15	29
FIN521RS05	8211.123	SLANZI DVA 2900	15	31
FIN521RS10	8211.136	SLANZI DVA 1500	15	27
FIN521RS10	8211.136	SLANZI DVA 2200	15	29
FIN521RS10	8211.136	SLANZI DVA 2900	15	31
FIN522NH	644.27	RUGGERINI RD 188	18	10
FIN522NH	644.27	RUGGERINI RD 200	18	16
FIN522NH	644.27	RUGGERINI RD 201	18	18
FIN522NH	644.27	RUGGERINI RD 208	18	20
FIN522NH	644.27	RUGGERINI RD 210	18	28
FIN522NH	644.27	RUGGERINI RD 211	18	30
FIN522NH	644.27	RUGGERINI RD 218	18	32
FIN522NH	644.27	RUGGERINI RD 180	18	6
FIN522NH	644.27	RUGGERINI RD 181	18	8
FIN523RS00	8211.110	SLANZI DVA 460	15	1
FIN523RS00	8211.110	SLANZI DVA 920	15	3
FIN523RS05	8211.111	SLANZI DVA 460	15	1
FIN523RS05	8211.111	SLANZI DVA 920	15	3
FIN523RS10	8211.134	SLANZI DVA 460	15	1
FIN523RS10	8211.134	SLANZI DVA 920	15	3
FIN5240SM	A2227	RUGGERINI MD 85.0	19	14
FIN5240SM	A2227	RUGGERINI MD 85.1	19	16
FIN5240SM	A2227	RUGGERINI MD 95.0	19	18
FIN5240SM	A2227	RUGGERINI MD 95.1	19	20
FIN5241SM	2931	RUGGERINI RD 188	18	10
FIN5241SM	2931	RUGGERINI RD 180	18	6
FIN5241SM	2931	RUGGERINI RD 181	18	8
FIN5242SM	A2292	RUGGERINI MD 170	19	22
FIN5242SM	A2292	RUGGERINI MD 171	19	24
FIN5242SM	A2292	RUGGERINI MD 190	19	26
FIN5242SM	A2292	RUGGERINI MD 191	19	28
FIN5248SM	A2288	RUGGERINI MD 300	19	10
FIN5248SM	A2288	RUGGERINI MD 301	19	12
FIN524NH	644.43	RUGGERINI RD 220	18	34
FIN524NH	644.43	RUGGERINI RD 901/2	18	36
FIN524NH	644.43	RUGGERINI RD 240	18	42
FIN524NH	644.43	RUGGERINI RD 248	18	44
FIN524NH	644.43	RUGGERINI RD 92/2	18	46
FIN524NH	644.43	RUGGERINI RD 270	18	54
FIN524NH	644.43	RUGGERINI RD 278	18	56
FIN524NH	644.43	RUGGERINI RD 952	18	58
FIN524NH	644.43	RUGGERINI P 101	21	10
FIN524NH	644.43	RUGGERINI P 101 L	21	12
FIN524NH	644.43	RUGGERINI P 101/2	21	14
FIN524NH	644.43	RUGGERINI P 101/2 L	21	16
FIN524NH	644.43	RUGGERINI P 105/2	21	18
FIN524NH	644.43	RUGGERINI CRD 951	21	2
FIN524NH	644.43	RUGGERINI P 105/2 R	21	20
FIN524NH	644.43	RUGGERINI P 105/2 L	21	22
FIN524NH	644.43	RUGGERINI RP 280	21	24
FIN524NH	644.43	RUGGERINI RP 170	21	26
FIN524NH	644.43	RUGGERINI RP 178	21	28
FIN524NH	644.43	RUGGERINI RP 320	21	30
FIN524NH	644.43	RUGGERINI RP 328	21	32
FIN524NH	644.43	RUGGERINI RP 360	21	34
FIN524NH	644.43	RUGGERINI RP 368	21	36
FIN524NH	644.43	RUGGERINI RP 380	21	38
FIN524NH	644.43	RUGGERINI CRD 951/2	21	4
FIN524NH	644.43	RUGGERINI RP 388	21	40
FIN524NH	644.43	RUGGERINI CRD 100	21	6
FIN524NH	644.43	RUGGERINI CRD 100/2	21	8
FIN524SM	8180.155	SLANZI DVA 1500	15	28
FIN525SM	8180.153	SLANZI DVA 920	15	4
FIN5262SM	A2610	RUGGERINI RY 120	20	20
FIN5262SM	A2610	RUGGERINI RY 121	20	22
FIN5262SM	A2610	RUGGERINI RY 125	20	24
FIN5263SM	A2609	RUGGERINI RY 100	20	14
FIN5263SM	A2609	RUGGERINI RY 101	20	16
FIN5264SM	A2608	RUGGERINI RY 85.0	20	6
FIN5264SM	A2608	RUGGERINI RY 85.1	20	8
FIN5265SM	8180.149	SLANZI DVA 460	15	2
FIN526RT	054.027	ACME ALN 290 W	16	2
FIN526RT	054.027	ACME ALN 330 W	16	4
FIN526RT	054.027	ACME VT 88 W	16	60
FIN526RT	054.027	ACME AL 480	16	62
FIN526SM	8180.106	SLANZI DVA 1030	15	8

Ricambi non originali per motori. Denominazioni e codici originali, sono riportati a puro titolo di riferimento.

26 - A

rel. 1511

Non original engine parts. OEMs names and part numbers are for reference purpose only.

Tavole di corrispondenza

Cross references

Finimpianti	OEM	Costruttore-Motore <i>Manufacturer-Engine</i>	Cp.	Pg.
FIN5278SM	8180.150	SLANZI DVA 515	15	6
FIN527RT	054.130	ACME ADX 300	16	50
FIN527RT	054.130	ACME ADX 370	16	52
FIN527RT	054.130	ACME ADX 600	16	54
FIN527RT	054.130	ACME ADX 740	16	56
FIN527RT	054.130	ACME ADX 742	16	58
FIN527SM	8180.108	SLANZI DVA 1550 S	15	14
FIN527SM	8180.108	SLANZI DVA 1750	15	22
FIN527SM	8180.108	SLANZI DVA 1750 S	15	24
FIN528SM	8180.109	SLANZI DVA 1030 S	15	10
FIN5300PF	059.132	ACME ADN 37	16	18
FIN5300PF	059.132	ACME ADN 45	16	26
FIN5301PF	059.159	ACME ADN 37 W	16	20
FIN5301PF	059.159	ACME ADN 43	16	22
FIN5301PF	059.159	ACME ADN 43 W	16	24
FIN5301PF	059.159	ACME ADN 45	16	28
FIN5301PF	059.159	ACME ADN 45 W	16	30
FIN5301PF	059.159	ACME ADN 48	16	34
FIN5301PF	059.159	ACME ADN 48 W	16	36
FIN5301PF	059.159	ACME ADN 54	16	40
FIN5301PF	059.159	ACME ADN 54 W	16	42
FIN5301PF	059.159	ACME ADN 60	16	46
FIN5301PF	059.159	ACME ADN 60 W	16	48
FIN530VA	014.35	RUGGERINI MD 300	19	10
FIN530VA	014.35	RUGGERINI MD 301	19	12
FIN530VA	014.35	RUGGERINI MD 350	19	30
FIN530VA	014.35	RUGGERINI MD 351	19	32
FIN532SM	8180.158	SLANZI DVA 1800	15	34
FIN533SM	8180.159	SLANZI DVA 2700	15	36
FIN534SM	8180.160	SLANZI DVA 3600	15	38
FIN536SM	8180.110	SLANZI DS 2000	15	40
FIN536SM	8180.111	SLANZI DS 3000	15	42
FIN537SM	8180.112	SLANZI DS 4000	15	44
FIN538HG	453.36	RUGGERINI RY 85.0	20	6
FIN538HG	453.36	RUGGERINI RY 85.1	20	8
FIN539HG	453.40	RUGGERINI RY 100	20	14
FIN539HG	453.40	RUGGERINI RY 101	20	16
FIN540HG	453.30	RUGGERINI RY 120	20	20
FIN540HG	453.30	RUGGERINI RY 121	20	22
FIN540HG	453.30	RUGGERINI RY 125	20	24
FIN541HG	453.31	RUGGERINI RY 120	20	20
FIN541HG	453.31	RUGGERINI RY 121	20	22
FIN541HG	453.31	RUGGERINI RY 125	20	24
FIN5481SM	8180.154	SLANZI DVA 1550	15	12
FIN5484SM		SLANZI DVA 1200	15	20
FIN5488SM	8180.113	SLANZI DVA 2350	15	26
FIN5493SM		SLANZI DVA 2200	15	30
FIN5494SM	8180.157	SLANZI DVA 2900	15	32
FIN550FP	6585.055	SLANZI DVA 1030 S	15	10
FIN550FP	6585.055	SLANZI DVA 1200	15	20
FIN550FP	6585.055	SLANZI DVA 920	15	4
FIN550FP	6585.055	SLANZI DVA 1030	15	8
FIN551FP	6585.054	SLANZI DVA 460	15	2
FIN551FP	6585.054	SLANZI DVA 1750	15	22
FIN551FP	6585.054	SLANZI DVA 2350	15	26
FIN551FP	6585.054	SLANZI DVA 515	15	6
FIN552FP	6585.062	SLANZI DVA 1550	15	12
FIN552FP	6585.062	SLANZI DVA 1550 S	15	14
FIN552FP	6585.062	SLANZI DVA 1750 S	15	24
FIN553VA	1157.153	SLANZI DVA 1030 S	15	10
FIN553VA	1157.153	SLANZI DVA 460	15	2
FIN553VA	1157.153	SLANZI DVA 920	15	4
FIN553VA	1157.153	SLANZI DVA 515	15	6
FIN553VA	1157.153	SLANZI DVA 1030	15	8
FIN554VA	0011571540	RUGGERINI RD 290	18	60
FIN560NH	5010.010	SLANZI DVA 460	15	2
FIN560NH	5010.010	SLANZI DVA 920	15	4
FIN560NH	5010.010	SLANZI DVA 515	15	6
FIN560NH	5010.010	SLANZI DVA 1030	15	8
FIN561NH	2123	ACME AD 114 / A	16	10
FIN561NH	2123	ACME AD 114	16	12
FIN561NH	2123	ACME AD 112	16	14
FIN561NH	2123	ACME AD 116	16	16
FIN561NH	2123	ACME ADN 37	16	18
FIN561NH	2123	ACME ADN 45	16	26
FIN561NH	2123	ACME ADN 48	16	32
FIN561NH	2123	ACME ADN 54	16	38
FIN561NH	2123	ACME ADN 60	16	44
FIN561NH	2123	ACME AD 108	16	6
FIN561NH	2123	ACME AD 110	16	8
FIN562NH	475.118	ACME ADN 37 W	16	20
FIN562NH	475.118	ACME ADN 43	16	22
FIN562NH	475.118	ACME ADN 43 W	16	24
FIN562NH	475.118	ACME ADN 45	16	28
FIN562NH	475.118	ACME ADN 45 W	16	30
FIN562NH	475.118	ACME ADN 48	16	34
FIN562NH	475.118	ACME ADN 48 W	16	36
FIN562NH	475.118	ACME ADN 54	16	40
FIN562NH	475.118	ACME ADN 54 W	16	42
FIN562NH	475.118	ACME ADN 60	16	46
FIN562NH	475.118	ACME ADN 60 W	16	48
FIN564NH	5010.012	SLANZI DVA 1030 S	15	10
FIN564NH	5010.012	SLANZI DVA 1550	15	12
FIN564NH	5010.012	SLANZI DVA 1550 S	15	14

Finimpianti	OEM	Costruttore-Motore <i>Manufacturer-Engine</i>	Cp.	Pg.
FIN564NH	5010.012	SLANZI DVA 1750	15	22
FIN564NH	5010.012	SLANZI DVA 1750 S	15	24
FIN564NH	5010.012	SLANZI DVA 2350	15	26
FIN565NH	5010.014	SLANZI DVA 1500	15	28
FIN565NH	5010.014	SLANZI DVA 1800	15	34
FIN565NH	5010.014	SLANZI DVA 2700	15	36
FIN565NH	5010.014	SLANZI DVA 3600	15	38
FIN565NH	5010.014	SLANZI DS 2000	15	40
FIN565NH	5010.014	SLANZI DS 3000	15	42
FIN565NH	5010.014	SLANZI DS 4000	15	44
FIN580NO	644.88	RUGGERINI RY 120	20	20
FIN580NO	644.88	RUGGERINI RY 121	20	22
FIN580NO	644.88	RUGGERINI RY 125	20	24
FIN581NO	644.85	RUGGERINI RY 100	20	14
FIN581NO	644.85	RUGGERINI RY 101	20	16
FIN582NO	644.89	RUGGERINI RY 85.0	20	6
FIN582NO	644.89	RUGGERINI RY 85.1	20	8
FIN585CK	0010508550	RUGGERINI RY 75	20	10
FIN585CK	0010508550	RUGGERINI RY 70	20	4
FIN591PC00	6500.550	SLANZI DS 2000	15	39
FIN591PC00	6500.550	SLANZI DS 3000	15	41
FIN591PC00	6500.550	SLANZI DS 4000	15	43
FIN591PC05	6500.551	SLANZI DS 2000	15	39
FIN591PC05	6500.551	SLANZI DS 3000	15	41
FIN591PC05	6500.551	SLANZI DS 4000	15	43
FIN591PC10		SLANZI DS 2000	15	39
FIN591PC10		SLANZI DS 3000	15	41
FIN591PC10		SLANZI DS 4000	15	43
FIN592RS00	8211.097	SLANZI DS 2000	15	39
FIN592RS00	8211.097	SLANZI DS 3000	15	41
FIN592RS00	8211.097	SLANZI DS 4000	15	43
FIN592RS05	8211.098	SLANZI DS 2000	15	39
FIN592RS05	8211.098	SLANZI DS 3000	15	41
FIN592RS05	8211.098	SLANZI DS 4000	15	43
FIN592RS10		SLANZI DS 2000	15	39
FIN592RS10		SLANZI DS 3000	15	41
FIN592RS10		SLANZI DS 4000	15	43
FIN593SL00	2380.308	SLANZI DS 2000	15	39
FIN593SL00	2380.308	SLANZI DS 3000	15	41
FIN593SL00	2380.308	SLANZI DS 4000	15	43
FIN594PC00	6500.893	LOMBARDINI Benzina Petrol LGA 184	14	41
FIN594PC00	6500.893	LOMBARDINI Benzina Petrol LKA 184	14	43
FIN594PC05	6500.894	LOMBARDINI Benzina Petrol LGA 184	14	41
FIN594PC05	6500.894	LOMBARDINI Benzina Petrol LKA 184	14	43
FIN594PC10	6500.895	LOMBARDINI Benzina Petrol LGA 184	14	41
FIN594PC10	6500.895	LOMBARDINI Benzina Petrol LKA 184	14	43
FIN595RS00	8211.074	LOMBARDINI Benzina Petrol LGA 184	14	41
FIN595RS00	8211.074	LOMBARDINI Benzina Petrol LKA 184	14	43
FIN595RS05	8211.075	LOMBARDINI Benzina Petrol LGA 184	14	41
FIN595RS05	8211.075	LOMBARDINI Benzina Petrol LKA 184	14	43
FIN595RS10	8211.076	LOMBARDINI Benzina Petrol LGA 184	14	41
FIN595RS10	8211.076	LOMBARDINI Benzina Petrol LKA 184	14	43
FIN596PC00	6500.896	LOMBARDINI Benzina Petrol LGA 225	14	45
FIN596PC00	6500.896	LOMBARDINI Benzina Petrol LKA 225	14	47
FIN596PC05	6500.897	LOMBARDINI Benzina Petrol LGA 225	14	45
FIN596PC05	6500.897	LOMBARDINI Benzina Petrol LKA 225	14	47
FIN596PC10	6500.898	LOMBARDINI Benzina Petrol LGA 225	14	45
FIN596PC10	6500.898	LOMBARDINI Benzina Petrol LKA 225	14	47
FIN597RS00	8211.085	LOMBARDINI Benzina Petrol LGA 225	14	45
FIN597RS00	8211.085	LOMBARDINI Benzina Petrol LKA 225	14	47
FIN597RS05	8211.086	LOMBARDINI Benzina Petrol LGA 225	14	45
FIN597RS05	8211.086	LOMBARDINI Benzina Petrol LKA 225	14	47
FIN597RS10	8211.087	LOMBARDINI Benzina Petrol LGA 225	14	45
FIN597RS10	8211.087	LOMBARDINI Benzina Petrol LKA 225	14	47
FIN598PC00	6501.566	LOMBARDINI Benzina Petrol LGA 226	14	49
FIN598PC00	6501.566	LOMBARDINI Benzina Petrol LKA 226	14	51
FIN598PC05	6501.567	LOMBARDINI Benzina Petrol LGA 226	14	49
FIN598PC05	6501.567	LOMBARDINI Benzina Petrol LKA 226	14	51

Ricambi non originali per motori. Denominazioni e codici originali, sono riportati a puro titolo di riferimento.

27 - A

rel. 1511

Non original engine parts. OEMs names and part numbers are for reference purpose only.

Tavole di corrispondenza

Cross references

Finimpianti	OEM	Costruttore-Motore Manufacturer-Engine	Cp.	Pg.
FIN598PC10	6501.568	LOMBARDINI Benzina Petrol LGA 226	14	49
FIN598PC10	6501.568	LOMBARDINI Benzina Petrol LKA 226	14	51
FIN599RS00	8211.254	LOMBARDINI Benzina Petrol LGA 226	14	49
FIN599RS00	8211.254	LOMBARDINI Benzina Petrol LKA 226	14	51
FIN599RS05	8211.255	LOMBARDINI Benzina Petrol LGA 226	14	49
FIN599RS05	8211.255	LOMBARDINI Benzina Petrol LKA 226	14	51
FIN599RS10	8211.256	LOMBARDINI Benzina Petrol LGA 226	14	49
FIN599RS10	8211.256	LOMBARDINI Benzina Petrol LKA 226	14	51
FIN600CFA	060.13	RUGGERINI RF 88	17	10
FIN600CFA	060.13	RUGGERINI RF 130	17	22
FIN600CFA	060.13	RUGGERINI RF 80	17	6
FIN600CFA	060.13	RUGGERINI RF 81	17	8
FIN601AA	4845.150	SLANZI DVA 1500	15	27
FIN601AA	4845.150	SLANZI DVA 2200	15	29
FIN601AA	4845.150	SLANZI DVA 2900	15	31
FIN6026BR	304.046	ACME ALN 290 W	16	1
FIN6026BR	304.046	ACME ALN 330 W	16	3
FIN6026BR	304.046	ACME VT 88 W	16	59
FIN6026BR	304.046	ACME AL 480	16	61
FIN602SA	4845.145	SLANZI DVA 1500	15	27
FIN602SA	4845.145	SLANZI DVA 2200	15	29
FIN602SA	4845.145	SLANZI DVA 2900	15	31
FIN603FE	2175.076	SLANZI DVA 650	15	16
FIN603FE	2175.076	SLANZI DVA 680	15	18
FIN603FE	2175.076	SLANZI DVA 1500	15	28
FIN604FE	2175.080	SLANZI DVA 2200	15	30
FIN604FE	2175.080	SLANZI DVA 2900	15	32
FIN604RTS (FIN3232RT + FIN892RT)		SLANZI DVA 1550 , DVA 1550 S, DVA 1750 , DVA 1750 S, DVA 2350	15	45
FIN605AA	4845.133	SLANZI DVA 460	15	1
FIN605AA	4845.133	SLANZI DVA 1550	15	11
FIN605AA	4845.133	SLANZI DVA 920	15	3
FIN605AA	4845.133	SLANZI DVA 515	15	5
FIN605AA	4845.133	SLANZI DVA 1030	15	7
FIN605FE	2175.084	SLANZI DVA 2900	15	45
FIN606SA	4845.128	SLANZI DVA 460	15	1
FIN606SA	4845.128	SLANZI DVA 1550	15	11
FIN606SA	4845.128	SLANZI DVA 920	15	3
FIN606SA	4845.128	SLANZI DVA 515	15	5
FIN606SA	4845.128	SLANZI DVA 1030	15	7
FIN610IG	448.06	RUGGERINI P 101	21	10
FIN610IG	448.06	RUGGERINI P 101	21	10
FIN610IG	448.06	RUGGERINI P 101 L	21	12
FIN610IG	448.06	RUGGERINI P 101 L	21	12
FIN610IG	448.06	RUGGERINI P 101/2	21	14
FIN610IG	448.06	RUGGERINI P 101/2	21	14
FIN610IG	448.06	RUGGERINI P 101/2 L	21	16
FIN610IG	448.06	RUGGERINI P 101/2 L	21	16
FIN610IG	448.06	RUGGERINI P 105/2	21	18
FIN610IG	448.06	RUGGERINI P 105/2	21	18
FIN610IG	448.06	RUGGERINI CRD 951	21	2
FIN610IG	448.06	RUGGERINI CRD 951	21	2
FIN610IG	448.06	RUGGERINI P 105/2 R	21	20
FIN610IG	448.06	RUGGERINI P 105/2 R	21	20
FIN610IG	448.06	RUGGERINI P 105/2 L	21	22
FIN610IG	448.06	RUGGERINI P 105/2 L	21	22
FIN610IG	448.06	RUGGERINI RP 280	21	24
FIN610IG	448.06	RUGGERINI RP 280	21	24
FIN610IG	448.06	RUGGERINI RP 170	21	26
FIN610IG	448.06	RUGGERINI RP 170	21	26
FIN610IG	448.06	RUGGERINI RP 178	21	28
FIN610IG	448.06	RUGGERINI RP 178	21	28
FIN610IG	448.06	RUGGERINI RP 320	21	30
FIN610IG	448.06	RUGGERINI RP 320	21	30
FIN610IG	448.06	RUGGERINI RP 328	21	32
FIN610IG	448.06	RUGGERINI RP 328	21	32
FIN610IG	448.06	RUGGERINI RP 360	21	34
FIN610IG	448.06	RUGGERINI RP 360	21	34
FIN610IG	448.06	RUGGERINI RP 368	21	36
FIN610IG	448.06	RUGGERINI RP 368	21	36
FIN610IG	448.06	RUGGERINI RP 380	21	38
FIN610IG	448.06	RUGGERINI RP 380	21	38
FIN610IG	448.06	RUGGERINI CRD 951/2	21	4
FIN610IG	448.06	RUGGERINI CRD 951/2	21	4
FIN610IG	448.06	RUGGERINI RP 388	21	40
FIN610IG	448.06	RUGGERINI RP 388	21	40
FIN610IG	448.06	RUGGERINI CRD 100	21	6
FIN610IG	448.06	RUGGERINI CRD 100	21	6
FIN610IG	448.06	RUGGERINI CRD 100/2	21	8
FIN610IG	448.06	RUGGERINI CRD 100/2	21	8
FIN6112HG	4730.296	SLANZI DVA 1030 S	15	10
FIN6112HG	4730.296	SLANZI DVA 1550 S	15	14
FIN6113HG	4730.293	SLANZI DVA 680	15	18

Finimpianti	OEM	Costruttore-Motore Manufacturer-Engine	Cp.	Pg.
FIN6113HG	4730.293	SLANZI DVA 1200	15	20
FIN6113HG	4730.293	SLANZI DVA 1750	15	22
FIN6113HG	4730.293	SLANZI DVA 1750 S	15	24
FIN6113HG	4730.293	SLANZI DVA 2350	15	26
FIN612PB	1630.009	INTERMOTOR Benzina Petrol LA 490	14	37
FIN612PB	1630.009	INTERMOTOR Benzina Petrol LAP 490	14	39
FIN612PN	854.103	ACME VT 88 W	16	59
FIN612PN	854.103	ACME AL 480	16	61
FIN613AA	4845.149	SLANZI DVA 650	15	15
FIN613AA	4845.149	SLANZI DVA 680	15	17
FIN613EG	450.96	RUGGERINI MD 85.0	19	14
FIN613EG	450.96	RUGGERINI MD 85.1	19	16
FIN613EG	450.96	RUGGERINI MD 95.0	19	18
FIN613EG	450.96	RUGGERINI MD 95.1	19	20
FIN613EG	450.96	RUGGERINI MD 190	19	26
FIN613EG	450.96	RUGGERINI MD 191	19	28
FIN613EG	450.96	RUGGERINI MD 150	19	6
FIN613EG	450.96	RUGGERINI MD 151	19	8
FIN614PF	670.14	RUGGERINI MD 85.0	19	14
FIN614PF	670.14	RUGGERINI MD 85.1	19	16
FIN614PF	670.14	RUGGERINI MD 95.0	19	18
FIN614PF	670.14	RUGGERINI MD 75.0	19	2
FIN614PF	670.14	RUGGERINI MD 95.1	19	20
FIN614PF	670.14	RUGGERINI MD 170	19	22
FIN614PF	670.14	RUGGERINI MD 171	19	24
FIN614PF	670.14	RUGGERINI MD 190	19	26
FIN614PF	670.14	RUGGERINI MD 191	19	28
FIN614PF	670.14	RUGGERINI MD 75.1	19	4
FIN614PF	670.14	RUGGERINI MD 150	19	6
FIN614PF	670.14	RUGGERINI MD 151	19	8
FIN614SA	4845.136	SLANZI DVA 650	15	15
FIN614SA	4845.136	SLANZI DVA 680	15	17
FIN6206KR 025	1526.027	INTERMOTOR Benzina Petrol IM 250, IM 252, IM 300, IM 302, IM 350, IM 352, IM 359	14	53
FIN6206KR 050	1526.028	INTERMOTOR Benzina Petrol IM 250, IM 252, IM 300, IM 302, IM 350, IM 352, IM 359	14	53
FIN6206KR STD	1526.026	INTERMOTOR IM 300	14	10
FIN6206KR STD	1526.026	INTERMOTOR IM 300	14	12
FIN6206KR STD	1526.026	INTERMOTOR IM 302	14	14
FIN6206KR STD	1526.026	INTERMOTOR IM 302	14	16
FIN6206KR STD	1526.026	INTERMOTOR IM 350	14	18
FIN6206KR STD	1526.026	INTERMOTOR IM 250	14	2
FIN6206KR STD	1526.026	INTERMOTOR IM 350	14	20
FIN6206KR STD	1526.026	INTERMOTOR IM 352	14	22
FIN6206KR STD	1526.026	INTERMOTOR IM 352	14	24
FIN6206KR STD	1526.026	INTERMOTOR IM 359	14	26
FIN6206KR STD	1526.026	INTERMOTOR IM 359	14	28
FIN6206KR STD	1526.026	INTERMOTOR IM 250	14	4
FIN6206KR STD	1526.026	INTERMOTOR IM 252	14	6
FIN6206KR STD	1526.026	INTERMOTOR IM 252	14	8
FIN620FP	652.37	RUGGERINI MD 85.0	19	14
FIN620FP	652.37	RUGGERINI MD 85.1	19	16
FIN620FP	652.37	RUGGERINI MD 95.0	19	18
FIN620FP	652.37	RUGGERINI MD 75.0	19	2
FIN620FP	652.37	RUGGERINI MD 95.1	19	20
FIN620FP	652.37	RUGGERINI MD 75.1	19	4
FIN6216KR 025	1526.145	LOMBARDINI Benzina Petrol LGA 184, LKA 184, LGA 225, LKA 225	14	53
FIN6216KR 050	1526.146	LOMBARDINI Benzina Petrol LGA 184, LKA 184, LGA 225, LKA 225	14	53
FIN6216KR STD	1526.126	LOMBARDINI Benzina Petrol LGA 184	14	42
FIN6216KR STD	1526.126	LOMBARDINI Benzina Petrol LKA 184	14	44
FIN6216KR STD	1526.126	LOMBARDINI Benzina Petrol LGA 225	14	46
FIN6216KR STD	1526.126	LOMBARDINI Benzina Petrol LKA 225	14	48
FIN6226KR 025	1526.213	LOMBARDINI Benzina Petrol LGA 226, LKA 226	14	53
FIN6226KR 050	1526.214	LOMBARDINI Benzina Petrol LGA 226	14	50
FIN6226KR 050	1526.214	LOMBARDINI Benzina Petrol LGA 226, LKA 226	14	53
FIN622IG	448.52	RUGGERINI RD 220	18	34
FIN622IG	448.52	RUGGERINI RD 901/2	18	36
FIN622IG	448.52	RUGGERINI RD 240	18	42
FIN622IG	448.52	RUGGERINI RD 248	18	44
FIN622IG	448.52	RUGGERINI RD 92/2	18	46
FIN622IG	448.52	RUGGERINI RD 92/2 L	18	48
FIN622IG	448.52	RUGGERINI RD 270	18	54
FIN622IG	448.52	RUGGERINI RD 278	18	56
FIN622IG	448.52	RUGGERINI RD 952	18	58

Ricambi non originali per motori. Denominazioni e codici originali, sono riportati a puro titolo di riferimento.

28 - A

rel. 1511

Non original engine parts. OEMs names and part numbers are for reference purpose only.

Tavole di corrispondenza

Cross references

Finimpianti	OEM	Costruttore-Motore <i>Manufacturer-Engine</i>	Cp.	Pg.
FIN622PN	8480.057	SLANZI DVA 1550	15	11
FIN622PN	8480.057	SLANZI DVA 1550 S	15	13
FIN622PN	8480.057	SLANZI DVA 515	15	5
FIN622PN	8480.057	SLANZI DVA 1030	15	7
FIN622PN	8480.057	SLANZI DVA 1030 S	15	9
FIN623EG	448.51	RUGGERINI RD 220	18	34
FIN623EG	448.51	RUGGERINI RD 901/2	18	36
FIN623EG	448.51	RUGGERINI RD 240	18	42
FIN623EG	448.51	RUGGERINI RD 248	18	44
FIN623EG	448.51	RUGGERINI RD 92/2	18	46
FIN623EG	448.51	RUGGERINI RD 92/2 L	18	48
FIN623EG	448.51	RUGGERINI RD 270	18	54
FIN623EG	448.51	RUGGERINI RD 278	18	56
FIN623EG	448.51	RUGGERINI RD 952	18	58
FIN6240HG	449.002	ACME ADN 37	16	18
FIN6240HG	449.002	ACME ADN 37 W	16	20
FIN6240HG	449.83	RUGGERINI RF 88	17	10
FIN6240HG	449.83	RUGGERINI MC 70	17	2
FIN6240HG	449.83	RUGGERINI MC 71	17	4
FIN6240HG	449.83	RUGGERINI RF 80	17	6
FIN6240HG	449.83	RUGGERINI RF 81	17	8
FIN6240HG	449.83	RUGGERINI RD 80	18	2
FIN6240HG	449.83	RUGGERINI RD 81	18	4
FIN6241HG	448.008	ACME AD 114	16	12
FIN6241HG	448.008	ACME AD 112	16	14
FIN6241HG	448.008	ACME AD 116	16	16
FIN6241HG	448.008	ACME ADN 54	16	38
FIN6241HG	448.008	ACME ADN 54	16	40
FIN6241HG	448.008	ACME ADN 54 W	16	42
FIN6241HG	448.08	RUGGERINI RF 90	17	12
FIN6241HG	448.08	RUGGERINI RF 91	17	14
FIN6241HG	448.08	RUGGERINI RF 120	17	18
FIN6241HG	448.08	RUGGERINI RF 121	17	20
FIN6241HG	448.08	RUGGERINI RF 130	17	22
FIN6241HG	448.08	RUGGERINI RD 901/AD	18	26
FIN6241HG	448.08	RUGGERINI RD 220	18	34
FIN6241HG	448.08	RUGGERINI RD 901/2	18	36
FIN6241HG	448.08	RUGGERINI RD 920	18	38
FIN6241HG	448.08	RUGGERINI RD 920 L	18	40
FIN6241HG	448.08	RUGGERINI RD 240	18	42
FIN6241HG	448.08	RUGGERINI RD 248	18	44
FIN6241HG	448.08	RUGGERINI RD 92/2	18	46
FIN6241HG	448.08	RUGGERINI RD 92/2 L	18	48
FIN6248HG	4730.304	SLANZI DVA 1800	15	34
FIN6248HG	4730.304	SLANZI DVA 2700	15	36
FIN6248HG	4730.304	SLANZI DVA 3600	15	38
FIN6249HG	4730.295	SLANZI DS 2000	15	40
FIN6249HG	4730.295	SLANZI DS 3000	15	42
FIN6249HG	4730.295	SLANZI DS 4000	15	44
FIN624JP	6590.158	SLANZI DVA 460	15	2
FIN624JP	6590.158	SLANZI DVA 515	15	6
FIN625HG	449.052	ACME ADN 60	16	44
FIN625HG	449.052	ACME ADN 60	16	46
FIN625HG	449.052	ACME ADN 60 W	16	48
FIN625HG	449.52	RUGGERINI RF 140	17	24
FIN625HG	449.52	RUGGERINI RF 148	17	26
FIN625HG	449.52	RUGGERINI RD 950	18	50
FIN625HG	449.52	RUGGERINI RD 950 L	18	52
FIN625HG	449.52	RUGGERINI RD 270	18	54
FIN625HG	449.52	RUGGERINI RD 278	18	56
FIN625HG	449.52	RUGGERINI RD 952	18	58
FIN625JP	6590.139	SLANZI DVA 1030 S	15	10
FIN625JP	6590.139	SLANZI DVA 1500	15	28
FIN625JP	6590.139	SLANZI DVA 920	15	4
FIN625JP	6590.139	SLANZI DVA 1030	15	8
FIN625PN	8480.071	SLANZI DVA 1800	15	33
FIN625PN	8480.071	SLANZI DVA 2700	15	35
FIN625PN	8480.071	SLANZI DVA 3600	15	37
FIN626FP	652.26	RUGGERINI MD 170	19	22
FIN626FP	652.26	RUGGERINI MD 171	19	24
FIN626FP	652.26	RUGGERINI MD 190	19	26
FIN626FP	652.26	RUGGERINI MD 191	19	28
FIN626FP	652.26	RUGGERINI MD 150	19	6
FIN626FP	652.26	RUGGERINI MD 151	19	8
FIN626HG	447.85	RUGGERINI P 101	21	10
FIN626HG	447.85	RUGGERINI P 101 L	21	12
FIN626HG	447.85	RUGGERINI P 101/2	21	14
FIN626HG	447.85	RUGGERINI P 101/2 L	21	16
FIN626HG	447.85	RUGGERINI RP 170	21	26
FIN626HG	447.85	RUGGERINI RP 178	21	28
FIN626HG	447.85	RUGGERINI RP 320	21	30
FIN626HG	447.85	RUGGERINI RP 328	21	32
FIN626HG	447.85	RUGGERINI CRD 100	21	6
FIN626HG	447.85	RUGGERINI CRD 100/2	21	8
FIN626JP	6590.142	SLANZI DVA 1550	15	12
FIN626JP	6590.142	SLANZI DVA 1550 S	15	14
FIN626JP	6590.142	SLANZI DVA 1750	15	22
FIN626JP	6590.142	SLANZI DVA 1750 S	15	24
FIN626PN		SLANZI DS 2000	15	39
FIN626PN		SLANZI DS 3000	15	41
FIN626PN		SLANZI DS 4000	15	43
FIN627CGA		ACME ADX 300	16	50
FIN627CGB	A2424	ACME ADX 300	16	50
FIN6284E	660.14	RUGGERINI RD 80	18	2

Finimpianti	OEM	Costruttore-Motore <i>Manufacturer-Engine</i>	Cp.	Pg.
FIN6284E	660.14	RUGGERINI RD 81	18	4
FIN6285HG	4730.302	SLANZI DVA 460	15	2
FIN6285HG	4730.302	SLANZI DVA 920	15	4
FIN6286HG	4730.294	SLANZI DVA 1550	15	12
FIN6286HG	4730.294	SLANZI DVA 515	15	6
FIN6286HG	4730.294	SLANZI DVA 1030	15	8
FIN6287HG	4730.303	SLANZI DVA 1500	15	28
FIN6287HG	4730.303	SLANZI DVA 2200	15	30
FIN6287HG	4730.303	SLANZI DVA 2900	15	32
FIN628CGA		ACME ADX 370	16	52
FIN628CGB	B0023	ACME ADX 370	16	52
FIN628HG	448.96	RUGGERINI P 105/2	21	18
FIN628HG	448.96	RUGGERINI P 105/2 R	21	20
FIN628HG	448.96	RUGGERINI P 105/2 L	21	22
FIN628HG	448.96	RUGGERINI RP 360	21	34
FIN628HG	448.96	RUGGERINI RP 368	21	36
FIN628HG	448.96	RUGGERINI RP 380	21	38
FIN628HG	448.96	RUGGERINI RP 388	21	40
FIN628JP	6590.165	SLANZI DVA 1800	15	34
FIN628JP	6590.165	SLANZI DS 2000	15	40
FIN6290HG	4730.528	LOMBARDINI Benzina Petrol LGA 184	14	42
FIN6290HG	4730.528	LOMBARDINI Benzina Petrol LKA 184	14	44
FIN6291HG	4730.529	LOMBARDINI Benzina Petrol LGA 225	14	46
FIN6291HG	4730.529	LOMBARDINI Benzina Petrol LKA 225	14	48
FIN6292HG	4730.722	LOMBARDINI Benzina Petrol LGA 226	14	50
FIN6292HG	4730.722	LOMBARDINI Benzina Petrol LKA 226	14	52
FIN629CGA		ACME ADX 600	16	54
FIN629CGB	B0108	ACME ADX 600	16	54
FIN629HG	447.54	RUGGERINI CRD 951	21	2
FIN629HG	447.54	RUGGERINI RP 280	21	24
FIN629HG	447.54	RUGGERINI CRD 951/2	21	4
FIN629JP	6590.176	SLANZI DVA 2700	15	36
FIN629JP	6590.176	SLANZI DVA 3600	15	38
FIN629JP	6590.176	SLANZI DS 3000	15	42
FIN629JP	6590.176	SLANZI DS 4000	15	44
FIN630CGA		ACME ADX 740	16	56
FIN630CGA		ACME ADX 742	16	58
FIN630CGB	B0109	ACME ADX 740	16	56
FIN630CGB	B0109	ACME ADX 742	16	58
FIN634JP	6590.145	SLANZI DVA 2350	15	26
FIN6351HG	450.72	RUGGERINI MD 300	19	10
FIN6351HG	450.72	RUGGERINI MD 301	19	12
FIN6351HG	450.72	RUGGERINI MD 75.0	19	2
FIN6351HG	450.72	RUGGERINI MD 75.1	19	4
FIN6351HG	450.72	RUGGERINI MD 150	19	6
FIN6351HG	450.72	RUGGERINI MD 151	19	8
FIN6352HG	450.18	RUGGERINI RD 188	18	10
FIN6352HG	450.18	RUGGERINI RD 180	18	6
FIN6352HG	450.18	RUGGERINI RD 181	18	8
FIN6353HG	450.45	RUGGERINI RD 200	18	16
FIN6353HG	450.45	RUGGERINI RD 201	18	18
FIN6353HG	450.45	RUGGERINI RD 208	18	20
FIN6380HG	447.078	ACME AD 114 / A	16	10
FIN6380HG	447.078	ACME ADN 43	16	22
FIN6380HG	447.078	ACME ADN 43 W	16	24
FIN6380HG	447.078	ACME ADN 45	16	26
FIN6380HG	447.078	ACME ADN 45	16	28
FIN6380HG	447.078	ACME ADN 45 W	16	30
FIN6380HG	447.078	ACME ADN 48	16	32
FIN6380HG	447.078	ACME ADN 48	16	34
FIN6380HG	447.078	ACME ADN 48 W	16	36
FIN6380HG	447.078	ACME AD 108	16	6
FIN6380HG	447.078	ACME AD 110	16	8
FIN6380HG	447.78	RUGGERINI RF 100	17	16
FIN6380HG	447.78	RUGGERINI RD 850	18	12
FIN6380HG	447.78	RUGGERINI RD 901/A	18	14
FIN6380HG	447.78	RUGGERINI RD 900	18	22
FIN6380HG	447.78	RUGGERINI RD 901	18	24
FIN6380KIT		RUGGERINI RD 901	18	24
FIN640FE	391.44	RUGGERINI RY 100	20	14
FIN640FE	391.44	RUGGERINI RY 101	20	16
FIN640FE	391.44	RUGGERINI RY 120	20	20
FIN640FE	391.44	RUGGERINI RY 121	20	22
FIN640FE	391.44	RUGGERINI RY 125	20	24
FIN640FE	391.44	RUGGERINI RY 85.0	20	6
FIN640FE	391.44	RUGGERINI RY 85.1	20	8
FIN6411GR	304.111	ACME VT 88 W	16	59
FIN6411GR	304.111	ACME AL 480	16	61
FIN641FE	391.40	RUGGERINI RY 85.0, RY 85.1, RY 100, RY 101	20	25
FIN645FP	652.41	RUGGERINI RY 100	20	14
FIN645FP	652.41	RUGGERINI RY 101	20	16
FIN645FP	652.41	RUGGERINI RY 120	20	20
FIN645FP	652.41	RUGGERINI RY 121	20	22
FIN645FP	652.41	RUGGERINI RY 125	20	24
FIN645FP	652.41	RUGGERINI RY 85.0	20	6

Tavole di corrispondenza

Cross references

Finimpianti	OEM	Costruttore-Motore <i>Manufacturer-Engine</i>	Cp.	Pg.
FIN645FP	652.41	RUGGERINI RY 85.1	20	8
FIN6518ASA	464.76	RUGGERINI RD 220	18	33
FIN6518ASA	464.76	RUGGERINI RD 220	18	33
FIN6518ASA	464.76	RUGGERINI RD 240	18	41
FIN6518ASA	464.76	RUGGERINI RD 240	18	41
FIN6518ASA	464.76	RUGGERINI RD 270	18	53
FIN6518ASA	464.76	RUGGERINI RD 270	18	53
FIN6518ASA	464.76	RUGGERINI RD 278	18	55
FIN6518ASA	464.76	RUGGERINI RD 278	18	55
FIN652FP	652.108	ACME ADN 37 W	16	20
FIN652FP	652.108	ACME ADN 43 W	16	24
FIN652FP	652.108	ACME ADN 45	16	28
FIN652FP	652.108	ACME ADN 45 W	16	30
FIN652FP	652.108	ACME ADN 48	16	34
FIN652FP	652.108	ACME ADN 48 W	16	36
FIN652FP	652.108	ACME ADN 54	16	40
FIN652FP	652.108	ACME ADN 54 W	16	42
FIN652FP	652.108	ACME ADN 60	16	46
FIN652FP	652.108	ACME ADN 60 W	16	48
FIN652FP	652.108	ACME ADX 600	16	54
FIN652FP	652.108	ACME ADX 740	16	56
FIN652FP	652.108	ACME ADX 742	16	58
FIN6600AA	0048452470	RUGGERINI RD 290	18	59
FIN6600AA	0048452470	RUGGERINI SP 420	18	61
FIN6620AA	0048452400	RUGGERINI RY 50	20	1
FIN6621SA	0048452410	RUGGERINI RY 50	20	1
FIN6625AA	0048452180	RUGGERINI RY 103	20	11
FIN6625AA	0048452180	RUGGERINI RY 110	20	17
FIN6625AA	0048452180	RUGGERINI RY 70	20	3
FIN6625AA	0048452180	RUGGERINI RY 75	20	9
FIN6626SA	0048452190	RUGGERINI RY 103	20	11
FIN6626SA	0048452190	RUGGERINI RY 110	20	17
FIN6626SA	0048452190	RUGGERINI RY 70	20	3
FIN6626SA	0048452190	RUGGERINI RY 75	20	9
FIN662CR STD	1640.035	INTERMOTOR <i>Benzina Petrol</i> LA 250	14	29
FIN662CR STD	1640.035	INTERMOTOR <i>Benzina Petrol</i> LAP 250	14	31
FIN662CR STD	1640.035	INTERMOTOR <i>Benzina Petrol</i> LA 300	14	33
FIN662CR STD	1640.035	INTERMOTOR <i>Benzina Petrol</i> LAP 300	14	35
FIN666DV	956.68	RUGGERINI RY 100	20	14
FIN666DV	956.68	RUGGERINI RY 101	20	16
FIN666DV	956.68	RUGGERINI RY 120	20	20
FIN666DV	956.68	RUGGERINI RY 121	20	22
FIN666DV	956.68	RUGGERINI RY 125	20	24
FIN666DV	956.68	RUGGERINI RY 85.0	20	6
FIN666DV	956.68	RUGGERINI RY 85.1	20	8
FIN670PN	854.37	RUGGERINI RY 85.0	20	5
FIN670PN	854.37	RUGGERINI RY 85.1	20	7
FIN677CB	0044000610	RUGGERINI RD 290	18	60
FIN677CB	0044000610	RUGGERINI SP 420	18	62
FIN678PF	9710.099	SLANZI DVA 460	15	2
FIN678PF	9710.099	SLANZI DVA 515	15	6
FIN679PF	6727.027	SLANZI DVA 1030 S	15	10
FIN679PF	6727.027	SLANZI DVA 920	15	4
FIN679PF	6727.027	SLANZI DVA 1030	15	8
FIN680CGA		RUGGERINI P 105/2	21	18
FIN680CGA		RUGGERINI P 105/2 R	21	20
FIN680CGA		RUGGERINI P 105/2 L	21	22
FIN680CGA		RUGGERINI RP 360	21	34
FIN680CGA		RUGGERINI RP 368	21	36
FIN680CGA		RUGGERINI RP 380	21	38
FIN680CGA		RUGGERINI RP 388	21	40
FIN680CGB	2357	RUGGERINI P 105/2	21	18
FIN680CGB	2357	RUGGERINI P 105/2 R	21	20
FIN680CGB	2357	RUGGERINI P 105/2 L	21	22
FIN680CGB	2357	RUGGERINI RP 360	21	34
FIN680CGB	2357	RUGGERINI RP 368	21	36
FIN680CGB	2357	RUGGERINI RP 380	21	38
FIN680CGB	2357	RUGGERINI RP 388	21	40
FIN681FP	652.12	RUGGERINI RD 188	18	10
FIN681FP	652.12	RUGGERINI RD 200	18	16
FIN681FP	652.12	RUGGERINI RD 201	18	18
FIN681FP	652.12	RUGGERINI RD 208	18	20
FIN681FP	652.12	RUGGERINI RD 210	18	28
FIN681FP	652.12	RUGGERINI RD 211	18	30
FIN681FP	652.12	RUGGERINI RD 218	18	32
FIN681FP	652.12	RUGGERINI RD 220	18	34
FIN681FP	652.12	RUGGERINI RD 901/2	18	36
FIN681FP	652.12	RUGGERINI RD 240	18	42
FIN681FP	652.12	RUGGERINI RD 248	18	44
FIN681FP	652.12	RUGGERINI RD 92/2	18	46
FIN681FP	652.12	RUGGERINI RD 92/2 L	18	48
FIN681FP	652.12	RUGGERINI RD 270	18	54
FIN681FP	652.12	RUGGERINI RD 278	18	56
FIN681FP	652.12	RUGGERINI RD 952	18	58
FIN681FP	652.12	RUGGERINI RD 180	18	6
FIN681FP	652.12	RUGGERINI RD 181	18	8
FIN681FP	652.12	RUGGERINI MD 300	19	10
FIN681FP	652.12	RUGGERINI MD 301	19	12
FIN681FP	652.12	RUGGERINI MD 350	19	30
FIN681FP	652.12	RUGGERINI MD 351	19	32

Finimpianti	OEM	Costruttore-Motore <i>Manufacturer-Engine</i>	Cp.	Pg.
FIN682CB	0044000580	RUGGERINI RY 75	20	10
FIN682CB	0044000580	RUGGERINI RY 103	20	12
FIN682CB	0044000580	RUGGERINI RY 110	20	18
FIN682CB	0044000580	RUGGERINI RY 50	20	2
FIN682CB	0044000580	RUGGERINI RY 70	20	4
FIN682PF	6727.030	SLANZI DVA 1550	15	12
FIN682PF	6727.030	SLANZI DVA 1750	15	22
FIN683FE	2175.066	SLANZI DVA 920	15	4
FIN684FE	2175.064	SLANZI DVA 1030 S	15	10
FIN684FE	2175.064	SLANZI DVA 460	15	2
FIN684FE	2175.064	SLANZI DVA 1200	15	20
FIN684FE	2175.064	SLANZI DVA 920	15	45
FIN684FE	2175.064	SLANZI DVA 515	15	6
FIN684FE	2175.064	SLANZI DVA 1030	15	8
FIN685PC00	6500.615	SLANZI DVA 1500	15	27
FIN685PC00	6500.615	SLANZI DVA 2200	15	29
FIN685PC00	6500.615	SLANZI DVA 2900	15	31
FIN685PC05	6500.616	SLANZI DVA 1500	15	27
FIN685PC05	6500.616	SLANZI DVA 2200	15	29
FIN685PC05	6500.616	SLANZI DVA 2900	15	31
FIN685PC10	6500.685	SLANZI DVA 1500	15	27
FIN685PC10	6500.685	SLANZI DVA 2200	15	29
FIN685PC10	6500.685	SLANZI DVA 2900	15	31
FIN685SL00	2380.328	SLANZI DVA 1500	15	27
FIN685SL00	2380.328	SLANZI DVA 2200	15	29
FIN685SL00	2380.328	SLANZI DVA 2900	15	31
FIN687PC00	6500.604	SLANZI DVA 460	15	1
FIN687PC00	6500.604	SLANZI DVA 920	15	3
FIN687PC05	6500.605	SLANZI DVA 460	15	1
FIN687PC05	6500.605	SLANZI DVA 920	15	3
FIN687PC10	6500.667	SLANZI DVA 460	15	1
FIN687PC10	6500.667	SLANZI DVA 920	15	3
FIN690FP	0065850960	RUGGERINI RD 290	18	60
FIN690FP	0065850960	RUGGERINI RY 50	20	2
FIN690FP	0065850960	RUGGERINI RY 70	20	4
FIN698VA	014.18	RUGGERINI P 101/2	21	14
FIN698VA	014.18	RUGGERINI P 101/2 L	21	16
FIN698VA	014.18	RUGGERINI P 105/2	21	18
FIN698VA	014.18	RUGGERINI P 105/2 R	21	20
FIN698VA	014.18	RUGGERINI P 105/2 L	21	22
FIN698VA	014.18	RUGGERINI RP 280	21	24
FIN698VA	014.18	RUGGERINI RP 320	21	30
FIN698VA	014.18	RUGGERINI RP 328	21	32
FIN698VA	014.18	RUGGERINI RP 360	21	34
FIN698VA	014.18	RUGGERINI RP 368	21	36
FIN698VA	014.18	RUGGERINI RP 380	21	38
FIN698VA	014.18	RUGGERINI CRD 951/2	21	4
FIN698VA	014.18	RUGGERINI RP 388	21	40
FIN698VA	014.18	RUGGERINI CRD 100/2	21	8
FIN699AF	3700.235	SLANZI DVA 2900	15	32
FIN700AF	3700.238	SLANZI DVA 460	15	2
FIN700AF	3700.238	SLANZI DVA 515	15	6
FIN701AF	3700.256	SLANZI DVA 1200	15	20
FIN701JP	656.41	RUGGERINI RF 88	17	10
FIN701JP	656.41	RUGGERINI RF 90	17	12
FIN701JP	656.41	RUGGERINI RF 91	17	14
FIN701JP	656.41	RUGGERINI MC 70	17	2
FIN701JP	656.41	RUGGERINI MC 71	17	4
FIN701JP	656.41	RUGGERINI RF 80	17	6
FIN701JP	656.41	RUGGERINI RF 81	17	8
FIN701PC00	A2276	RUGGERINI MD 350	19	29
FIN701PC00	A2276	RUGGERINI MD 351	19	31
FIN701PC05		RUGGERINI MD 350	19	29
FIN701PC05		RUGGERINI MD 351	19	31
FIN701PC10		RUGGERINI MD 350	19	29
FIN701PC10		RUGGERINI MD 351	19	31
FIN7026BR	304.101	ACME VT 88 W	16	59
FIN7026BR	304.101	ACME AL 480	16	61
FIN702JP	656.42	RUGGERINI RF 100	17	16
FIN702JP	656.42	RUGGERINI RF 120	17	18
FIN702JP	656.42	RUGGERINI RF 121	17	20
FIN702JP	656.42	RUGGERINI RF 130	17	22
FIN702JP	656.42	RUGGERINI RF 140	17	24
FIN702JP	656.42	RUGGERINI RF 148	17	26
FIN702JP	656.42	RUGGERINI P 101	21	10
FIN702JP	656.42	RUGGERINI P 101 L	21	12
FIN702JP	656.42	RUGGERINI CRD 951	21	2
FIN702JP	656.42	RUGGERINI RP 170	21	26
FIN702JP	656.42	RUGGERINI CRD 100	21	6
FIN702SL00	204.14	RUGGERINI RY 120	20	19
FIN702SL00	204.14	RUGGERINI RY 121	20	21
FIN702SL00	204.14	RUGGERINI RY 125	20	23
FIN703AF	3700.233	SLANZI DVA 680	15	18
FIN703AF	3700.233	SLANZI DVA 1500	15	28
FIN703CB	451.31	RUGGERINI MD 300	19	10
FIN703CB	451.31	RUGGERINI MD 301	19	12
FIN703CB	451.31	RUGGERINI MD 85.0	19	14
FIN703CB	451.31	RUGGERINI MD 85.1	19	16
FIN703CB	451.31	RUGGERINI MD 95.0	19	18
FIN703CB	451.31	RUGGERINI MD 75.0	19	2
FIN703CB	451.31	RUGGERINI MD 95.1	19	20
FIN703CB	451.31	RUGGERINI MD 170	19	22
FIN703CB	451.31	RUGGERINI MD 171	19	24
FIN703CB	451.31	RUGGERINI MD 190	19	26

Tavole di corrispondenza

Cross references

Finimpianti	OEM	Costruttore-Motore Manufacturer-Engine	Cp.	Pg.
FIN703CB	451.31	RUGGERINI MD 191	19	28
FIN703CB	451.31	RUGGERINI MD 350	19	30
FIN703CB	451.31	RUGGERINI MD 351	19	32
FIN703CB	451.31	RUGGERINI MD 75.1	19	4
FIN703CB	451.31	RUGGERINI MD 150	19	6
FIN703CB	451.31	RUGGERINI MD 151	19	8
FIN703JP	653.03	RUGGERINI RD 950	18	50
FIN703PC00	A2616	RUGGERINI RY 120	20	19
FIN703PC00	A2616	RUGGERINI RY 121	20	21
FIN703PC00	A2616	RUGGERINI RY 125	20	23
FIN703PC05		RUGGERINI RY 120	20	19
FIN703PC05		RUGGERINI RY 121	20	21
FIN703PC05		RUGGERINI RY 125	20	23
FIN703PC10		RUGGERINI RY 120	20	19
FIN703PC10		RUGGERINI RY 121	20	21
FIN703PC10		RUGGERINI RY 125	20	23
FIN703SL00	203.98	RUGGERINI MD 75.0	19	1
FIN703SL00	203.98	RUGGERINI MD 75.1	19	3
FIN703SL00	203.98	RUGGERINI MD 150	19	5
FIN703SL00	203.98	RUGGERINI MD 151	19	7
FIN704CB	448.53	RUGGERINI RD 188	18	10
FIN704CB	448.53	RUGGERINI RD 200	18	16
FIN704CB	448.53	RUGGERINI RD 201	18	18
FIN704CB	448.53	RUGGERINI RD 208	18	20
FIN704CB	448.53	RUGGERINI RD 210	18	28
FIN704CB	448.53	RUGGERINI RD 211	18	30
FIN704CB	448.53	RUGGERINI RD 218	18	32
FIN704CB	448.53	RUGGERINI RD 220	18	34
FIN704CB	448.53	RUGGERINI RD 901/2	18	36
FIN704CB	448.53	RUGGERINI RD 240	18	42
FIN704CB	448.53	RUGGERINI RD 248	18	44
FIN704CB	448.53	RUGGERINI RD 92/2	18	46
FIN704CB	448.53	RUGGERINI RD 92/2 L	18	48
FIN704CB	448.53	RUGGERINI RD 270	18	54
FIN704CB	448.53	RUGGERINI RD 278	18	56
FIN704CB	448.53	RUGGERINI RD 952	18	58
FIN704CB	448.53	RUGGERINI RD 180	18	6
FIN704CB	448.53	RUGGERINI RD 181	18	8
FIN704JP	656.23	RUGGERINI RD 80	18	2
FIN704JP	656.23	RUGGERINI RD 81	18	4
FIN704PC00	A2615	RUGGERINI RY 100	20	13
FIN704PC00	A2615	RUGGERINI RY 101	20	15
FIN705AF	3700.218	SLANZI DVA 1800	15	34
FIN705AF	3700.218	SLANZI DVA 2700	15	36
FIN705AF	3700.218	SLANZI DS 2000	15	40
FIN705AF	3700.218	SLANZI DS 3000	15	42
FIN705CB	453.76	RUGGERINI RY 100	20	14
FIN705CB	453.76	RUGGERINI RY 101	20	16
FIN705CB	453.76	RUGGERINI RY 120	20	20
FIN705CB	453.76	RUGGERINI RY 121	20	22
FIN705CB	453.76	RUGGERINI RY 125	20	24
FIN705CB	453.76	RUGGERINI RY 85.0	20	6
FIN705CB	453.76	RUGGERINI RY 85.1	20	8
FIN705PC00	A2614	RUGGERINI RY 85.0	20	5
FIN705PC00	A2614	RUGGERINI RY 85.1	20	7
FIN705PC05		RUGGERINI RY 85.0	20	5
FIN705PC05		RUGGERINI RY 85.1	20	7
FIN705PC10		RUGGERINI RY 85.0	20	5
FIN705PC10		RUGGERINI RY 85.1	20	7
FIN706AF	3700.219	SLANZI DVA 3600	15	38
FIN706AF	3700.219	SLANZI DS 4000	15	44
FIN707AF	3700.277	INTERMOTOR IM 300	14	10
FIN707AF	3700.277	INTERMOTOR IM 300	14	12
FIN707AF	3700.277	INTERMOTOR IM 302	14	14
FIN707AF	3700.277	INTERMOTOR IM 302	14	16
FIN707AF	3700.277	INTERMOTOR IM 350	14	18
FIN707AF	3700.277	INTERMOTOR IM 250	14	2
FIN707AF	3700.277	INTERMOTOR IM 350	14	20
FIN707AF	3700.277	INTERMOTOR IM 352	14	22
FIN707AF	3700.277	INTERMOTOR IM 352	14	24
FIN707AF	3700.277	INTERMOTOR IM 359	14	26
FIN707AF	3700.277	INTERMOTOR IM 359	14	28
FIN707AF	3700.277	INTERMOTOR IM 250	14	4
FIN707AF	3700.277	INTERMOTOR IM 252	14	6
FIN707AF	3700.277	INTERMOTOR IM 252	14	8
FIN707CO	450.60	RUGGERINI MD 170	19	22
FIN707CO	450.60	RUGGERINI MD 171	19	24
FIN707CO	450.60	RUGGERINI MD 190	19	26
FIN707CO	450.60	RUGGERINI MD 191	19	28
FIN707CO	450.60	RUGGERINI MD 150	19	6
FIN707CO	450.60	RUGGERINI MD 151	19	8
FIN708AF	3700.398	LOMBARDINI Benzina Petrol LGA 184	14	42
FIN708AF	3700.398	LOMBARDINI Benzina Petrol LKA 184	14	44
FIN708AF	3700.398	LOMBARDINI Benzina Petrol LGA 225	14	46
FIN708AF	3700.398	LOMBARDINI Benzina Petrol LKA 225	14	48
FIN708JP	656.003	ACME AD 114 / A	16	10
FIN708JP	656.003	ACME AD 114	16	12
FIN708JP	656.003	ACME AD 112	16	14
FIN708JP	656.003	ACME AD 116	16	16
FIN708JP	656.003	ACME ADN 45	16	26

Finimpianti	OEM	Costruttore-Motore Manufacturer-Engine	Cp.	Pg.
FIN708JP	656.003	ACME ADN 48	16	32
FIN708JP	656.003	ACME ADN 54	16	38
FIN708JP	656.003	ACME ADN 60	16	44
FIN708JP	656.003	ACME AD 108	16	6
FIN708JP	656.003	ACME AD 110	16	8
FIN708JP	656.03	RUGGERINI RD 850	18	12
FIN708JP	656.03	RUGGERINI RD 901/A	18	14
FIN708JP	656.03	RUGGERINI RD 900	18	22
FIN708JP	656.03	RUGGERINI RD 901	18	24
FIN708JP	656.03	RUGGERINI RD 901/AD	18	26
FIN708JP	656.03	RUGGERINI RD 920	18	38
FIN708PC00	A2037	ACME ALN 290 W	16	1
FIN708PC05	A2038	ACME ALN 290 W	16	1
FIN708PC10	A2039	ACME ALN 290 W	16	1
FIN708TL	563.54	RUGGERINI MD 170	19	22
FIN708TL	563.54	RUGGERINI MD 171	19	24
FIN708TL	563.54	RUGGERINI MD 190	19	26
FIN708TL	563.54	RUGGERINI MD 191	19	28
FIN708TL	563.54	RUGGERINI MD 150	19	6
FIN708TL	563.54	RUGGERINI MD 151	19	8
FIN709AF	3750.058	LOMBARDINI Benzina Petrol LGA 184, LKA 184, LGA 225, LKA 225	14	53
FIN709JP	656.14	RUGGERINI RD 920 L	18	40
FIN709JP	656.14	RUGGERINI RD 950 L	18	52
FIN709RS00	A2033	ACME ALN 290 W	16	1
FIN709RS05	A2034	ACME ALN 290 W	16	1
FIN709RS10	A2035	ACME ALN 290 W	16	1
FIN710AF	3700.397	LOMBARDINI Benzina Petrol LGA 226, LKA 226	14	53
FIN710JP	656.36	RUGGERINI RP 178	21	28
FIN710SL00	203.79	RUGGERINI MD 350	19	29
FIN710SL00	203.79	RUGGERINI MD 351	19	31
FIN711AF	3700.393	LOMBARDINI Benzina Petrol LGA 226	14	50
FIN711AF	3700.393	LOMBARDINI Benzina Petrol LKA 226	14	52
FIN711JP	656.49	RUGGERINI P 101/2	21	14
FIN711JP	656.49	RUGGERINI P 101/2 L	21	16
FIN711JP	656.49	RUGGERINI RP 280	21	24
FIN711JP	656.49	RUGGERINI RP 320	21	30
FIN711JP	656.49	RUGGERINI RP 328	21	32
FIN711JP	656.49	RUGGERINI CRD 951/2	21	4
FIN711JP	656.49	RUGGERINI CRD 100/2	21	8
FIN712JP	656.34	RUGGERINI P 105/2	21	18
FIN712JP	656.34	RUGGERINI P 105/2 R	21	20
FIN712JP	656.34	RUGGERINI P 105/2 L	21	22
FIN712JP	656.34	RUGGERINI RP 360	21	34
FIN712JP	656.34	RUGGERINI RP 368	21	36
FIN712JP	656.34	RUGGERINI RP 380	21	38
FIN712JP	656.34	RUGGERINI RP 388	21	40
FIN713PC00	A2406	ACME ALN 330 W	16	3
FIN713PC05	A2407	ACME ALN 330 W	16	3
FIN713PC10	A2408	ACME ALN 330 W	16	3
FIN714JP	656.105	ACME ADX 300	16	50
FIN714JP	656.105	ACME ADX 370	16	52
FIN714JP	656.105	ACME ADX 600	16	54
FIN714JP	656.105	ACME ADX 740	16	56
FIN714JP	656.105	ACME ADX 742	16	58
FIN722HG	449.105	ACME ALN 290 W	16	2
FIN722HG	449.105	ACME ALN 330 W	16	4
FIN722NF	5496.135	SLANZI DVA 680	15	18
FIN722NF	5496.135	SLANZI DVA 1500	15	28
FIN723SL00	204.17	RUGGERINI RY 100	20	13
FIN723SL00	204.17	RUGGERINI RY 101	20	15
FIN723SM	0081850220	RUGGERINI RD 290	18	60
FIN723SM	0081850220	RUGGERINI SP 420	18	62
FIN724AF	2175.073	SLANZI DVA 920	15	45
FIN724SL00	204.16	RUGGERINI RY 85.0	20	5
FIN724SL00	204.16	RUGGERINI RY 85.1	20	7
FIN725HG	449.173	ACME ADX 300	16	50
FIN725HG	449.173	ACME ADX 600	16	54
FIN725NF	2175.156	LOMBARDINI Benzina Petrol LGA 184	14	42
FIN725NF	2175.156	LOMBARDINI Benzina Petrol LKA 184	14	44
FIN725NF	2175.156	LOMBARDINI Benzina Petrol LGA 225	14	46
FIN725NF	2175.156	LOMBARDINI Benzina Petrol LKA 225	14	48
FIN725NF	2175.156	LOMBARDINI Benzina Petrol LGA 226	14	50
FIN725NF	2175.156	LOMBARDINI Benzina Petrol LKA 226	14	52
FIN726HG	449.174	ACME ADX 370	16	52
FIN726HG	449.174	ACME ADX 740	16	56
FIN726HG	449.174	ACME ADX 742	16	58
FIN734TL	563.02	RUGGERINI P 101/2	21	14
FIN734TL	563.02	RUGGERINI P 101/2 L	21	16
FIN734TL	563.02	RUGGERINI P 105/2	21	18
FIN734TL	563.02	RUGGERINI P 105/2 R	21	20
FIN734TL	563.02	RUGGERINI P 105/2 L	21	22
FIN734TL	563.02	RUGGERINI RP 280	21	24
FIN734TL	563.02	RUGGERINI RP 320	21	30

Tavole di corrispondenza

Cross references

Finimpianti	OEM	Costruttore-Motore <i>Manufacturer-Engine</i>	Cp.	Pg.
FIN734TL	563.02	RUGGERINI RP 328	21	32
FIN734TL	563.02	RUGGERINI RP 360	21	34
FIN734TL	563.02	RUGGERINI RP 368	21	36
FIN734TL	563.02	RUGGERINI RP 380	21	38
FIN734TL	563.02	RUGGERINI CRD 951/2	21	4
FIN734TL	563.02	RUGGERINI RP 388	21	40
FIN734TL	563.02	RUGGERINI CRD 100/2	21	8
FIN752CGA		ACME ADN 60	16	46
FIN752CGA		ACME ADN 60 W	16	48
FIN752CGB	A2490	ACME ADN 60	16	46
FIN752CGB	A2490	ACME ADN 60 W	16	48
FIN760JP	656.010	ACME ADN 37	16	18
FIN760PN	8480.058	SLANZI DVA 1200	15	19
FIN760PN	8480.058	SLANZI DVA 1750	15	21
FIN760PN	8480.058	SLANZI DVA 1750 S	15	23
FIN760PN	8480.058	SLANZI DVA 2350	15	25
FIN761JP	656.104	ACME ADN 37 W	16	20
FIN761JP	656.104	ACME ADN 43	16	22
FIN761JP	656.104	ACME ADN 43 W	16	24
FIN761JP	656.104	ACME ADN 45	16	28
FIN761JP	656.104	ACME ADN 45 W	16	30
FIN764NH	644.84	RUGGERINI RY 100	20	14
FIN764NH	644.84	RUGGERINI RY 101	20	16
FIN764NH	644.84	RUGGERINI RY 125	20	24
FIN765JP	656.109	ACME ADN 48	16	34
FIN765JP	656.109	ACME ADN 48 W	16	36
FIN765JP	656.109	ACME ADN 54	16	40
FIN765JP	656.109	ACME ADN 54 W	16	42
FIN765JP	656.109	ACME ADN 60	16	46
FIN765JP	656.109	ACME ADN 60 W	16	48
FIN765NH	644.87	RUGGERINI RY 120	20	20
FIN765NH	644.87	RUGGERINI RY 121	20	22
FIN767NH	644.86	RUGGERINI RY 85.0	20	6
FIN767NH	644.86	RUGGERINI RY 85.1	20	8
FIN769CO	4601.079	SLANZI DVA 1550	15	12
FIN769CO	4601.079	SLANZI DVA 1550 S	15	14
FIN769CO	4601.079	SLANZI DVA 1750	15	22
FIN769CO	4601.079	SLANZI DVA 1750 S	15	24
FIN780CO	4775.339	SLANZI DVA 1800	15	34
FIN781CO	4775.340	SLANZI DVA 2700	15	36
FIN782CO	4775.341	SLANZI DVA 3600	15	38
FIN788HG	449.143	ACME VT 88 W	16	60
FIN789HG	449.148	ACME AL 480	16	62
FIN802CGA		SLANZI DVA 920	15	4
FIN802CGB	8180.136	SLANZI DVA 920	15	4
FIN802PN	854.119	ACME ADX 300	16	49
FIN802PN	854.119	ACME ADX 600	16	53
FIN803CGA		SLANZI DVA 1030	15	8
FIN803CGB	8180.096	SLANZI DVA 1030	15	8
FIN803PN	854.013	ACME ALN 290 W	16	1
FIN803PN	854.013	ACME ALN 330 W	16	3
FIN803RTS (FIN3230RT + FIN3231RT)		SLANZI DVA 920, DVA 1030, DVA 1030 S, DVA 1200	15	45
FIN804CGA		SLANZI DVA 1500	15	28
FIN804CGB	8180.141	SLANZI DVA 1500	15	28
FIN811CGA		SLANZI DVA 460	15	2
FIN811CGB	8180.134	SLANZI DVA 460	15	2
FIN812CGA		SLANZI DVA 1550	15	12
FIN812CGB	8180.140	SLANZI DVA 1550	15	12
FIN813CGA		SLANZI DVA 1750	15	22
FIN813CGB	8180.098	SLANZI DVA 1750 S	15	24
FIN813CGB	8180.098	SLANZI DVA 1750	15	22
FIN813CGB	8180.098	SLANZI DVA 1750 S	15	24
FIN814CGA		SLANZI DVA 515	15	6
FIN814CGB	8180.130	SLANZI DVA 515	15	6
FIN815CGA		SLANZI DVA 1030 S	15	10
FIN815CGB	8180.096	SLANZI DVA 1030 S	15	10
FIN816CGA		SLANZI DVA 2350	15	26
FIN816CGB	8180.100	SLANZI DVA 2350	15	26
FIN817CGA		SLANZI DS 2000	15	40
FIN817CGB	8180.102	SLANZI DS 2000	15	40
FIN817PB	1585.117	SLANZI DVA 1800	15	33
FIN817PB	1585.117	SLANZI DVA 2700	15	35
FIN817PB	1585.117	SLANZI DVA 3600	15	37
FIN818CGA		SLANZI DS 3000	15	42
FIN818CGB	8180.103	SLANZI DS 3000	15	42
FIN819CGA		SLANZI DS 4000	15	44
FIN819CGB	8180.104	SLANZI DS 4000	15	44
FIN820CGA		SLANZI DVA 1800	15	34
FIN820CGB	8180.146	SLANZI DVA 1800	15	34
FIN821CGA		SLANZI DVA 2700	15	36
FIN821CGB	8180.147	SLANZI DVA 2700	15	36
FIN821NF	359.26	RUGGERINI RF 90	17	12
FIN821NF	359.26	RUGGERINI RF 91	17	14
FIN821NF	359.26	RUGGERINI RF 120	17	18
FIN821NF	359.26	RUGGERINI RF 121	17	20
FIN821NF	359.26	RUGGERINI RF 140	17	24
FIN821NF	359.26	RUGGERINI RD 188	18	10
FIN821NF	359.26	RUGGERINI RD 200	18	16
FIN821NF	359.26	RUGGERINI RD 201	18	18
FIN821NF	359.26	RUGGERINI RD 208	18	20
FIN821NF	359.26	RUGGERINI RD 210	18	28

Finimpianti	OEM	Costruttore-Motore <i>Manufacturer-Engine</i>	Cp.	Pg.
FIN821NF	359.26	RUGGERINI RD 211	18	30
FIN821NF	359.26	RUGGERINI RD 218	18	32
FIN821NF	359.26	RUGGERINI RD 180	18	6
FIN821NF	359.26	RUGGERINI RD 181	18	8
FIN821NF	359.26	RUGGERINI RY 120	20	20
FIN821NF	359.26	RUGGERINI RY 121	20	22
FIN821NF	359.26	RUGGERINI RY 125	20	24
FIN822AF	388.48	RUGGERINI MD 170	19	22
FIN822AF	388.48	RUGGERINI MD 171	19	24
FIN822AF	388.48	RUGGERINI MD 190	19	26
FIN822AF	388.48	RUGGERINI MD 191	19	28
FIN822AF	388.48	RUGGERINI MD 150	19	6
FIN822AF	388.48	RUGGERINI MD 151	19	8
FIN823AF	388.72	RUGGERINI MD 85.0	19	14
FIN823AF	388.72	RUGGERINI MD 85.1	19	16
FIN823AF	388.72	RUGGERINI MD 95.0	19	18
FIN823AF	388.72	RUGGERINI MD 75.0	19	2
FIN823AF	388.72	RUGGERINI MD 95.1	19	20
FIN823AF	388.72	RUGGERINI MD 75.1	19	4
FIN830RT	0012133960	RUGGERINI RY 103	20	12
FIN830RT	0012133960	RUGGERINI RY 110	20	18
FIN831RT	0012133900	RUGGERINI RY 103	20	12
FIN831RT	0012133900	RUGGERINI RY 110	20	18
FIN839FP	6585.064	SLANZI DVA 1500	15	28
FIN839FP	6585.064	SLANZI DVA 2200	15	30
FIN839FP	6585.064	SLANZI DVA 2900	15	32
FIN839FP	6585.064	SLANZI DVA 1800	15	34
FIN839FP	6585.064	SLANZI DVA 2700	15	36
FIN839FP	6585.064	SLANZI DVA 3600	15	38
FIN839FP	6585.064	SLANZI DS 2000	15	40
FIN839FP	6585.064	SLANZI DS 3000	15	42
FIN839FP	6585.064	SLANZI DS 4000	15	44
FIN840CFA	060.48	RUGGERINI RF 90	17	12
FIN840CFA	060.48	RUGGERINI RF 91	17	14
FIN840CFA	060.48	RUGGERINI RF 120	17	18
FIN840CFA	060.48	RUGGERINI RF 121	17	20
FIN840CFA	060.48	RUGGERINI RF 140	17	24
FIN840CFA	060.48	RUGGERINI RY 120	20	20
FIN840CFA	060.48	RUGGERINI RY 121	20	22
FIN840CFA	060.48	RUGGERINI RY 125	20	24
FIN852RT	0012133180	RUGGERINI RD 290	18	60
FIN854RT	0012133210	RUGGERINI RD 290	18	60
FIN856RT	0012133510	RUGGERINI SP 420	18	62
FIN867RS00	A2480	ACME ADN 45	16	25
FIN867RS05	A2481	ACME ADN 45	16	25
FIN867RS10	A2482	ACME ADN 45	16	25
FIN870VA	0085650780	RUGGERINI RY 75	20	10
FIN870VA	0085650780	RUGGERINI RY 103	20	12
FIN870VA	0085650780	RUGGERINI RY 110	20	18
FIN870VA	0085650780	RUGGERINI RY 50	20	2
FIN870VA	0085650780	RUGGERINI RY 70	20	4
FIN880PC00	A2595	ACME ADN 45	16	27
FIN880PC05		ACME ADN 45	16	27
FIN880PC10		ACME ADN 45	16	27
FIN881PC00	0065018910	RUGGERINI RY 110	20	17
FIN881PC05	0065018920	RUGGERINI RY 110	20	17
FIN881PC10	0065018930	RUGGERINI RY 110	20	17
FIN882CGA		SLANZI DVA 3600	15	38
FIN882CGB	8180.148	SLANZI DVA 3600	15	38
FIN892PN	854.18	RUGGERINI MD 75.0	19	1
FIN892PN	854.18	RUGGERINI MD 75.1	19	3
FIN892PN	854.18	RUGGERINI MD 150	19	5
FIN892PN	854.18	RUGGERINI MD 151	19	7
FIN892RT	1213.258	SLANZI DVA 1550	15	12
FIN892RT	1213.258	SLANZI DVA 1550 S	15	14
FIN892RT	1213.258	SLANZI DVA 1750	15	22
FIN892RT	1213.258	SLANZI DVA 1750 S	15	24
FIN892RT	1213.258	SLANZI DVA 2350	15	26
FIN902NF	359.29	RUGGERINI MD 85.0	19	14
FIN902NF	359.29	RUGGERINI MD 85.1	19	16
FIN902NF	359.29	RUGGERINI MD 95.0	19	18
FIN902NF	359.29	RUGGERINI MD 75.0	19	2
FIN902NF	359.29	RUGGERINI MD 95.1	19	20
FIN902NF	359.29	RUGGERINI MD 170	19	22
FIN902NF	359.29	RUGGERINI MD 171	19	24
FIN902NF	359.29	RUGGERINI MD 190	19	26
FIN902NF	359.29	RUGGERINI MD 191	19	28
FIN902NF	359.29	RUGGERINI MD 75.1	19	4
FIN902NF	359.29	RUGGERINI MD 150	19	6
FIN902NF	359.29	RUGGERINI MD 151	19	8
FIN904CGA		INTERMOTOR IM 350	14	18
FIN904CGA		INTERMOTOR IM 350	14	20
FIN904CGA		INTERMOTOR IM 352	14	22
FIN904CGA		INTERMOTOR IM 352	14	24
FIN904CGB	8180.188	INTERMOTOR IM 350	14	18
FIN904CGB	8180.188	INTERMOTOR IM 350	14	20
FIN904CGB	8180.188	INTERMOTOR IM 352	14	22
FIN904CGB	8180.188	INTERMOTOR IM 352	14	24
FIN905CGA		INTERMOTOR IM 359	14	26
FIN905CGA		INTERMOTOR IM 359	14	28
FIN905CGB	8180.193	INTERMOTOR IM 359	14	26
FIN905CGB	8180.193	INTERMOTOR IM 359	14	28
FIN907CGA		LOMBARDINI Benzina Petrol LGA 184	14	42

Ricambi non originali per motori. Denominazioni e codici originali, sono riportati a puro titolo di riferimento.

32 - A

rel. 1511

Non original engine parts. OEMs names and part numbers are for reference purpose only.

Tavole di corrispondenza

Cross references

Finimpianti	OEM	Costruttore-Motore <i>Manufacturer-Engine</i>	Cp.	Pg.
FIN907CGA		LOMBARDINI <i>Benzina Petrol</i>	LKA 184	14 44
FIN907CGB	8180.191	LOMBARDINI <i>Benzina Petrol</i>	LGA 184	14 42
FIN907CGB	8180.191	LOMBARDINI <i>Benzina Petrol</i>	LKA 184	14 44
FIN908CGA		LOMBARDINI <i>Benzina Petrol</i>	LGA 225	14 46
FIN908CGA		LOMBARDINI <i>Benzina Petrol</i>	LKA 225	14 48
FIN908CGB	8180.192	LOMBARDINI <i>Benzina Petrol</i>	LGA 225	14 46
FIN908CGB	8180.192	LOMBARDINI <i>Benzina Petrol</i>	LKA 225	14 48
FIN909CGA		RUGGERINI	RY 70	20 4
FIN909CGB	0082051050	RUGGERINI	RY 70	20 4
FIN915AA	4845.019	INTERMOTOR <i>Benzina Petrol</i>	LA 490	14 37
FIN915AA	4845.019	INTERMOTOR <i>Benzina Petrol</i>	LAP 490	14 39
FIN916SA	4845.021	INTERMOTOR <i>Benzina Petrol</i>	LA 490	14 37
FIN916SA	4845.021	INTERMOTOR <i>Benzina Petrol</i>	LAP 490	14 39
FIN917TWS STD	1257.051	SLANZI	DVA 1800	15 33
FIN917TWS STD	1257.051	SLANZI	DVA 2700	15 35
FIN917TWS STD	1257.051	SLANZI	DVA 3600	15 37
FIN917TWS STD	1257.051	SLANZI	DS 2000	15 39
FIN917TWS STD	1257.051	SLANZI	DS 3000	15 41
FIN917TWS STD	1257.051	SLANZI	DS 4000	15 43
FIN921EG	0045011290	RUGGERINI	RY 50	20 2
FIN921EG	0045011290	RUGGERINI	RY 70	20 4
FIN930VA	014.39	RUGGERINI	MD 85.0	19 14
FIN930VA	014.39	RUGGERINI	MD 85.1	19 16
FIN930VA	014.39	RUGGERINI	MD 95.0	19 18
FIN930VA	014.39	RUGGERINI	MD 75.0	19 2
FIN930VA	014.39	RUGGERINI	MD 95.1	19 20
FIN930VA	014.39	RUGGERINI	MD 170	19 22
FIN930VA	014.39	RUGGERINI	MD 171	19 24
FIN930VA	014.39	RUGGERINI	MD 190	19 26
FIN930VA	014.39	RUGGERINI	MD 191	19 28
FIN930VA	014.39	RUGGERINI	MD 75.1	19 4
FIN930VA	014.39	RUGGERINI	MD 150	19 6
FIN930VA	014.39	RUGGERINI	MD 151	19 8
FIN930VA	014.39	RUGGERINI	RY 100	20 14
FIN930VA	014.39	RUGGERINI	RY 101	20 16
FIN930VA	014.39	RUGGERINI	RY 120	20 20
FIN930VA	014.39	RUGGERINI	RY 121	20 22
FIN930VA	014.39	RUGGERINI	RY 125	20 24
FIN930VA	014.39	RUGGERINI	RY 85.0	20 6
FIN930VA	014.39	RUGGERINI	RY 85.1	20 8
FIN935ASA	4845.028	INTERMOTOR <i>Benzina Petrol</i>	IM 250	14 1
FIN935ASA	4845.028	INTERMOTOR <i>Benzina Petrol</i>	IM 250	14 1
FIN935ASA	4845.028	INTERMOTOR <i>Benzina Petrol</i>	IM 300	14 11
FIN935ASA	4845.028	INTERMOTOR <i>Benzina Petrol</i>	IM 300	14 11
FIN935ASA	4845.028	INTERMOTOR <i>Benzina Petrol</i>	IM 302	14 13
FIN935ASA	4845.028	INTERMOTOR <i>Benzina Petrol</i>	IM 302	14 13
FIN935ASA	4845.028	INTERMOTOR <i>Benzina Petrol</i>	IM 302	14 15
FIN935ASA	4845.028	INTERMOTOR <i>Benzina Petrol</i>	IM 302	14 15
FIN935ASA	4845.028	INTERMOTOR <i>Benzina Petrol</i>	IM 350	14 17
FIN935ASA	4845.028	INTERMOTOR <i>Benzina Petrol</i>	IM 350	14 17
FIN935ASA	4845.028	INTERMOTOR <i>Benzina Petrol</i>	IM 350	14 19
FIN935ASA	4845.028	INTERMOTOR <i>Benzina Petrol</i>	IM 350	14 19
FIN935ASA	4845.028	INTERMOTOR <i>Benzina Petrol</i>	IM 352	14 21
FIN935ASA	4845.028	INTERMOTOR <i>Benzina Petrol</i>	IM 352	14 21
FIN935ASA	4845.028	INTERMOTOR <i>Benzina Petrol</i>	IM 352	14 23
FIN935ASA	4845.028	INTERMOTOR <i>Benzina Petrol</i>	IM 352	14 23
FIN935ASA	4845.028	INTERMOTOR <i>Benzina Petrol</i>	IM 359	14 25
FIN935ASA	4845.028	INTERMOTOR <i>Benzina Petrol</i>	IM 359	14 25
FIN935ASA	4845.028	INTERMOTOR <i>Benzina Petrol</i>	IM 359	14 27
FIN935ASA	4845.028	INTERMOTOR <i>Benzina Petrol</i>	IM 359	14 27
FIN935ASA	4845.028	INTERMOTOR <i>Benzina Petrol</i>	LA 250	14 29
FIN935ASA	4845.028	INTERMOTOR <i>Benzina Petrol</i>	LA 250	14 29

Finimpianti	OEM	Costruttore-Motore <i>Manufacturer-Engine</i>	Cp.	Pg.
FIN935ASA	4845.028	INTERMOTOR <i>Benzina Petrol</i>	IM 250	14 3
FIN935ASA	4845.028	INTERMOTOR <i>Benzina Petrol</i>	IM 250	14 3
FIN935ASA	4845.028	INTERMOTOR <i>Benzina Petrol</i>	LAP 250	14 31
FIN935ASA	4845.028	INTERMOTOR <i>Benzina Petrol</i>	LAP 250	14 31
FIN935ASA	4845.028	INTERMOTOR <i>Benzina Petrol</i>	LA 300	14 33
FIN935ASA	4845.028	INTERMOTOR <i>Benzina Petrol</i>	LA 300	14 33
FIN935ASA	4845.028	INTERMOTOR <i>Benzina Petrol</i>	LAP 300	14 35
FIN935ASA	4845.028	INTERMOTOR <i>Benzina Petrol</i>	LAP 300	14 35
FIN935ASA	4845.028	INTERMOTOR <i>Benzina Petrol</i>	IM 252	14 5
FIN935ASA	4845.028	INTERMOTOR <i>Benzina Petrol</i>	IM 252	14 5
FIN935ASA	4845.028	INTERMOTOR <i>Benzina Petrol</i>	IM 252	14 7
FIN935ASA	4845.028	INTERMOTOR <i>Benzina Petrol</i>	IM 252	14 7
FIN935ASA	4845.028	INTERMOTOR <i>Benzina Petrol</i>	IM 300	14 9
FIN935ASA	4845.028	INTERMOTOR <i>Benzina Petrol</i>	IM 300	14 9
FIN940RT	0012133490	RUGGERINI	SP 420	18 62
FIN941SA	0048452480	RUGGERINI	RD 290	18 59
FIN941SA	0048452480	RUGGERINI	SP 420	18 61
FIN947RT	1213.056	INTERMOTOR	IM 300	14 10
FIN947RT	1213.056	INTERMOTOR	IM 300	14 12
FIN947RT	1213.056	INTERMOTOR	IM 302	14 14
FIN947RT	1213.056	INTERMOTOR	IM 302	14 16
FIN947RT	1213.056	INTERMOTOR	IM 350	14 18
FIN947RT	1213.056	INTERMOTOR	IM 250	14 2
FIN947RT	1213.056	INTERMOTOR	IM 350	14 20
FIN947RT	1213.056	INTERMOTOR	IM 352	14 22
FIN947RT	1213.056	INTERMOTOR	IM 352	14 24
FIN947RT	1213.056	INTERMOTOR	IM 359	14 26
FIN947RT	1213.056	INTERMOTOR	IM 359	14 28
FIN947RT	1213.056	INTERMOTOR	LA 250	14 30
FIN947RT	1213.056	INTERMOTOR	LAP 250	14 32
FIN947RT	1213.056	INTERMOTOR	LA 300	14 34
FIN947RT	1213.056	INTERMOTOR	LAP 300	14 36
FIN947RT	1213.056	INTERMOTOR	IM 250	14 4
FIN947RT	1213.056	INTERMOTOR	IM 252	14 6
FIN947RT	1213.056	INTERMOTOR	IM 252	14 8
FIN954RT	1210.024	INTERMOTOR	LA 490	14 38
FIN954RT	1210.024	INTERMOTOR	LAP 490	14 40
FIN954RT	1210.024	LOMBARDINI <i>Benzina Petrol</i>	LGA 184	14 42
FIN954RT	1210.024	LOMBARDINI <i>Benzina Petrol</i>	LKA 184	14 44
FIN954RT	1210.024	LOMBARDINI <i>Benzina Petrol</i>	LGA 225	14 46
FIN954RT	1210.024	LOMBARDINI <i>Benzina Petrol</i>	LKA 225	14 48
FIN955RT	1213.002	INTERMOTOR	IM 300	14 10
FIN955RT	1213.002	INTERMOTOR	IM 300	14 12
FIN955RT	1213.002	INTERMOTOR	IM 302	14 14
FIN955RT	1213.002	INTERMOTOR	IM 302	14 16
FIN955RT	1213.002	INTERMOTOR	IM 350	14 18
FIN955RT	1213.002	INTERMOTOR	IM 250	14 2
FIN955RT	1213.002	INTERMOTOR	IM 350	14 20
FIN955RT	1213.002	INTERMOTOR	IM 352	14 22
FIN955RT	1213.002	INTERMOTOR	IM 352	14 24
FIN955RT	1213.002	INTERMOTOR	IM 359	14 26
FIN955RT	1213.002	INTERMOTOR	IM 359	14 28
FIN955RT	1213.002	INTERMOTOR	LA 250	14 30
FIN955RT	1213.002	INTERMOTOR	LAP 250	14 32
FIN955RT	1213.002	INTERMOTOR	LA 300	14 34
FIN955RT	1213.002	INTERMOTOR	LAP 300	14 36
FIN955RT	1213.002	INTERMOTOR	IM 250	14 4
FIN955RT	1213.002	INTERMOTOR	IM 252	14 6
FIN955RT	1213.002	INTERMOTOR	IM 252	14 8
FIN959CR STD	1640.092	SLANZI	DVA 650	15 15
FIN959CR STD	1640.092	SLANZI	DVA 680	15 17
FIN959CR STD	1640.092	SLANZI	DVA 1500	15 27
FIN959CR STD	1640.092	SLANZI	DVA 2200	15 29
FIN959CR STD	1640.092	SLANZI	DVA 2900	15 31
FIN961CR STD	1640.104	SLANZI	DVA 460	15 1
FIN961CR STD	1640.104	SLANZI	DVA 1200	15 19
FIN961CR STD	1640.104	SLANZI	DVA 920	15 3
FIN961CR STD	1640.104	SLANZI	DVA 515	15 5
FIN961CR STD	1640.104	SLANZI	DVA 1030	15 7
FIN961CR STD	1640.104	SLANZI	DVA 1030 S	15 9
FIN964MB STD	1585.124	SLANZI	DVA 1500	15 27
FIN966MB STD	1585.102	SLANZI	DVA 1800	15 33
FIN966MB STD	1585.102	SLANZI	DVA 2700	15 35
FIN966MB STD	1585.102	SLANZI	DVA 3600	15 37
FIN966MB STD	1585.102	SLANZI	DS 2000	15 39
FIN966MB STD	1585.102	SLANZI	DS 3000	15 41
FIN966MB STD	1585.102	SLANZI	DS 4000	15 43

Ricambi non originali per motori. Denominazioni e codici originali, sono riportati a puro titolo di riferimento.

33 - A

rel. 1511

Non original engine parts. OEMs names and part numbers are for reference purpose only.

Tavole di corrispondenza

Cross references

Finimpianti	OEM	Costruttore-Motore <i>Manufacturer-Engine</i>	Cp.	Pg.
FIN967CR STD	1640.107	SLANZI DVA 1550	15	11
FIN967CR STD	1640.107	SLANZI DVA 1550 S	15	13
FIN967CR STD	1640.107	SLANZI DVA 1750	15	21
FIN967CR STD	1640.107	SLANZI DVA 1750 S	15	23
FIN967CR STD	1640.107	SLANZI DVA 2350	15	25
FIN968MB STD	1611.163	SLANZI DVA 1550	15	11
FIN968MB STD	1611.163	SLANZI DVA 1550 S	15	13
FIN968MB STD	1611.163	SLANZI DVA 1750	15	21
FIN968MB STD	1611.163	SLANZI DVA 1750 S	15	23
FIN968MB STD	1611.163	SLANZI DVA 2350	15	25
FIN969MB STD	1611.166	SLANZI DVA 1800	15	33
FIN969MB STD	1611.166	SLANZI DVA 2700	15	35
FIN969MB STD	1611.166	SLANZI DVA 3600	15	37
FIN969MB STD	1611.166	SLANZI DS 2000	15	39
FIN969MB STD	1611.166	SLANZI DS 3000	15	41
FIN969MB STD	1611.166	SLANZI DS 4000	15	43
FIN970FP	0065850790	RUGGERINI SP 420	18	62
FIN972CGA		INTERMOTOR LA 490	14	38
FIN972CGA		INTERMOTOR LAP 490	14	40
FIN972CGB	8180.018	INTERMOTOR LA 490	14	38
FIN972CGB	8180.018	INTERMOTOR LAP 490	14	40
FIN976RT	1210.039	SLANZI DVA 650	15	16
FIN976RT	1210.039	SLANZI DVA 680	15	18
FIN976RT	1210.039	SLANZI DVA 1500	15	28
FIN984PN	8480.065	SLANZI DVA 460	15	1
FIN984PN	8480.065	SLANZI DVA 920	15	3
FIN985PN	8480.067	SLANZI DVA 650	15	15
FIN985PN	8480.067	SLANZI DVA 680	15	17
FIN985PN	8480.067	SLANZI DVA 1500	15	27
FIN985PN	8480.067	SLANZI DVA 2200	15	29
FIN985PN	8480.067	SLANZI DVA 2900	15	31
FIN986PN	8480.002	INTERMOTOR Benzina Petrol IM 250	14	1
FIN986PN	8480.002	INTERMOTOR Benzina Petrol IM 300	14	11
FIN986PN	8480.002	INTERMOTOR Benzina Petrol IM 302	14	13
FIN986PN	8480.002	INTERMOTOR Benzina Petrol IM 302	14	15
FIN986PN	8480.002	INTERMOTOR Benzina Petrol IM 350	14	17
FIN986PN	8480.002	INTERMOTOR Benzina Petrol IM 350	14	19
FIN986PN	8480.002	INTERMOTOR Benzina Petrol IM 352	14	21
FIN986PN	8480.002	INTERMOTOR Benzina Petrol IM 352	14	23
FIN986PN	8480.002	INTERMOTOR Benzina Petrol IM 359	14	25
FIN986PN	8480.002	INTERMOTOR Benzina Petrol IM 359	14	27
FIN986PN	8480.002	INTERMOTOR Benzina Petrol LA 250	14	29
FIN986PN	8480.002	INTERMOTOR Benzina Petrol IM 250	14	3
FIN986PN	8480.002	INTERMOTOR Benzina Petrol LAP 250	14	31
FIN986PN	8480.002	INTERMOTOR Benzina Petrol LA 300	14	33
FIN986PN	8480.002	INTERMOTOR Benzina Petrol LAP 300	14	35
FIN986PN	8480.002	LOMBARDINI Benzina Petrol LGA 184	14	41
FIN986PN	8480.002	LOMBARDINI Benzina Petrol LKA 184	14	43
FIN986PN	8480.002	LOMBARDINI Benzina Petrol LGA 225	14	45
FIN986PN	8480.002	LOMBARDINI Benzina Petrol LKA 225	14	47
FIN986PN	8480.002	INTERMOTOR Benzina Petrol IM 252	14	5
FIN986PN	8480.002	INTERMOTOR Benzina Petrol IM 252	14	7
FIN986PN	8480.002	INTERMOTOR Benzina Petrol IM 300	14	9
FIN987PN	8480.102	LOMBARDINI Benzina Petrol LGA 226	14	49
FIN987PN	8480.102	LOMBARDINI Benzina Petrol LKA 226	14	51
FIN988PN		INTERMOTOR Benzina Petrol LA 490	14	37
FIN988PN		INTERMOTOR Benzina Petrol LAP 490	14	39
FIN993MB STD	1611.101	SLANZI DVA 1500	15	27
FIN993MB STD	1611.101	SLANZI DVA 2200	15	29
FIN993MB STD	1611.101	SLANZI DVA 2900	15	31
FIN994MB STD	1585.128	SLANZI DVA 2200	15	29
FIN994MB STD	1585.128	SLANZI DVA 2900	15	31
FIN995MB STD	1585.118	SLANZI DVA 460	15	1
FIN995MB STD	1585.118	SLANZI DVA 515	15	5
FIN996MB STD	8675.172	SLANZI DVA 1550	15	11
FIN996MB STD	8675.172	SLANZI DVA 1550 S	15	13
FIN996MB STD	8675.172	SLANZI DVA 1750	15	21
FIN996MB STD	8675.172	SLANZI DVA 1750 S	15	23
FIN996MB STD	8675.172	SLANZI DVA 2350	15	25
FIN997CGA		INTERMOTOR IM 250	14	2

Finimpianti	OEM	Costruttore-Motore <i>Manufacturer-Engine</i>	Cp.	Pg.
FIN997CGA		INTERMOTOR IM 250	14	4
FIN997CGA		INTERMOTOR IM 252	14	6
FIN997CGA		INTERMOTOR IM 252	14	8
FIN997CGB	8180.186	INTERMOTOR IM 250	14	2
FIN997CGB	8180.186	INTERMOTOR IM 250	14	4
FIN997CGB	8180.186	INTERMOTOR IM 252	14	6
FIN997CGB	8180.186	INTERMOTOR IM 252	14	8
FIN998CGA		INTERMOTOR LA 250	14	30
FIN998CGA		INTERMOTOR LAP 250	14	32
FIN998CGB	8180.034	INTERMOTOR LA 250	14	30
FIN998CGB	8180.034	INTERMOTOR LAP 250	14	32
FIN999CGA		INTERMOTOR LA 300	14	34
FIN999CGA		INTERMOTOR LAP 300	14	36
FIN999CGB	8180.042	INTERMOTOR LA 300	14	34
FIN999CGB	8180.042	INTERMOTOR LAP 300	14	36
FINA027	960.49	RUGGERINI MC 70	17	1
FINA027	960.49	RUGGERINI MC 71	17	3
FINA027	960.49	RUGGERINI RF 80	17	5
FINA027	960.49	RUGGERINI RF 81	17	7
FINA027	960.49	RUGGERINI RF 88	17	9
FINA027	960.49	RUGGERINI RD 200	18	15
FINA027	960.49	RUGGERINI RD 201	18	17
FINA027	960.49	RUGGERINI RD 208	18	19
FINA027	960.49	RUGGERINI RD 218	18	31
FINA027	960.49	RUGGERINI RD 180	18	5
FINA027	960.49	RUGGERINI RD 181	18	7
FINA027	960.49	RUGGERINI RD 188	18	9
FINA051	9652.016	INTERMOTOR Benzina Petrol IM 250	14	1
FINA051	9652.016	INTERMOTOR Benzina Petrol IM 300	14	11
FINA051	9652.016	INTERMOTOR Benzina Petrol IM 302	14	13
FINA051	9652.016	INTERMOTOR Benzina Petrol IM 302	14	15
FINA051	9652.016	INTERMOTOR Benzina Petrol IM 350	14	17
FINA051	9652.016	INTERMOTOR Benzina Petrol IM 350	14	19
FINA051	9652.016	INTERMOTOR Benzina Petrol IM 352	14	21
FINA051	9652.016	INTERMOTOR Benzina Petrol IM 352	14	23
FINA051	9652.016	INTERMOTOR Benzina Petrol IM 359	14	25
FINA051	9652.016	INTERMOTOR Benzina Petrol IM 359	14	27
FINA051	9652.016	INTERMOTOR Benzina Petrol LA 250	14	29
FINA051	9652.016	INTERMOTOR Benzina Petrol IM 250	14	3
FINA051	9652.016	INTERMOTOR Benzina Petrol LAP 250	14	31
FINA051	9652.016	INTERMOTOR Benzina Petrol LA 300	14	33
FINA051	9652.016	INTERMOTOR Benzina Petrol LAP 300	14	35
FINA051	9652.016	INTERMOTOR Benzina Petrol IM 252	14	5
FINA051	9652.016	INTERMOTOR Benzina Petrol IM 252	14	7
FINA051	9652.016	INTERMOTOR Benzina Petrol IM 300	14	9
FINA055	9652.011	INTERMOTOR Benzina Petrol LA 490	14	37
FINA055	9652.011	INTERMOTOR Benzina Petrol LAP 490	14	39
FINA072	9652.070	SLANZI DVA 460	15	1
FINA072	9652.070	SLANZI DVA 1550	15	11
FINA072	9652.070	SLANZI DVA 920	15	3
FINA072	9652.070	SLANZI DVA 515	15	5
FINA072	9652.070	SLANZI DVA 1030	15	7
FINA074	9652.088	SLANZI DVA 1500	15	27
FINA074	9652.088	SLANZI DVA 2200	15	29
FINA074	9652.088	SLANZI DVA 2900	15	31
FINA084	9652.087	SLANZI DVA 650	15	15
FINA084	9652.087	SLANZI DVA 680	15	17
FINA098	960.027	ACME ALN 290 W	16	1
FINA098	960.027	ACME ALN 330 W	16	3
FINA099	9652.071	SLANZI DVA 1550 S	15	13
FINA099	9652.071	SLANZI DVA 1200	15	19
FINA099	9652.071	SLANZI DVA 1750	15	21
FINA099	9652.071	SLANZI DVA 1750 S	15	23
FINA099	9652.071	SLANZI DVA 2350	15	25
FINA099	9652.071	SLANZI DVA 1030 S	15	9
FINA100	960.103	ACME AL 480	16	61
FINA102	960.104	ACME VT 88 W	16	59
FINA106	960.022	ACME ADN 37	16	17
FINA106	960.022	ACME ADN 45	16	25
FINA106	960.22	RUGGERINI RD 80	18	1
FINA106	960.22	RUGGERINI RD 81	18	3
FINA116	960.016	ACME ADN 43	16	21
FINA116	960.016	ACME ADN 48	16	31
FINA116	960.016	ACME ADN 48	16	33
FINA116	960.016	ACME AD 108	16	5

Ricambi non originali per motori. Denominazioni e codici originali, sono riportati a puro titolo di riferimento.

Tavole di corrispondenza

Cross references

Finimpianti	OEM	Costruttore-Motore <i>Manufacturer-Engine</i>	Cp.	Pg.
FINA116	960.016	ACME AD 110	16	7
FINA116	960.016	ACME AD 114 / A	16	9
FINA116	960.16	RUGGERINI RF 100	17	15
FINA116	960.16	RUGGERINI RD 850	18	11
FINA116	960.16	RUGGERINI RD 901/A	18	13
FINA116	960.16	RUGGERINI RD 900	18	21
FINA116	960.16	RUGGERINI RD 901	18	23
FINA118	960.019	ACME AD 114	16	11
FINA118	960.019	ACME AD 112	16	13
FINA118	960.019	ACME AD 116	16	15
FINA119	960.13	RUGGERINI CRD 951	21	1
FINA119	960.13	RUGGERINI RP 280	21	23
FINA119	960.13	RUGGERINI CRD 951/2	21	3
FINA122	960.20	RUGGERINI P 101 L	21	11
FINA122	960.20	RUGGERINI P 101/2	21	13
FINA122	960.20	RUGGERINI P 101/2 L	21	15
FINA122	960.20	RUGGERINI P 105/2	21	17
FINA122	960.20	RUGGERINI P 105/2 R	21	19
FINA122	960.20	RUGGERINI P 105/2 L	21	21
FINA122	960.20	RUGGERINI RP 170	21	25
FINA122	960.20	RUGGERINI RP 178	21	27
FINA122	960.20	RUGGERINI RP 320	21	29
FINA122	960.20	RUGGERINI RP 328	21	31
FINA122	960.20	RUGGERINI RP 360	21	33
FINA122	960.20	RUGGERINI RP 368	21	35
FINA122	960.20	RUGGERINI RP 380	21	37
FINA122	960.20	RUGGERINI RP 388	21	39
FINA122	960.20	RUGGERINI CRD 100	21	5
FINA122	960.20	RUGGERINI CRD 100/2	21	7
FINA122	960.20	RUGGERINI P 101	21	9
FINA124	960.045	ACME ADN 54	16	37
FINA124	960.045	ACME ADN 54	16	39
FINA124	960.045	ACME ADN 60	16	43
FINA124	960.045	ACME ADN 60	16	45
FINA124	960.45	RUGGERINI RD 901/AD	18	25
FINA124	960.45	RUGGERINI RD 901/2	18	35
FINA124	960.45	RUGGERINI RD 920	18	37
FINA124	960.45	RUGGERINI RD 920 L	18	39
FINA124	960.45	RUGGERINI RD 248	18	43
FINA124	960.45	RUGGERINI RD 92/2	18	45
FINA124	960.45	RUGGERINI RD 92/2 L	18	47
FINA124	960.45	RUGGERINI RD 950	18	49
FINA124	960.45	RUGGERINI RD 950 L	18	51
FINA124	960.45	RUGGERINI RD 952	18	57
FINA138	9652.068	SLANZI DVA 1800	15	33
FINA138	9652.068	SLANZI DVA 2700	15	35
FINA138	9652.068	SLANZI DVA 3600	15	37
FINA140	9652.044	LOMBARDINI Benzina Petrol LGA 184	14	41
FINA140	9652.044	LOMBARDINI Benzina Petrol LKA 184	14	43
FINA140	9652.044	LOMBARDINI Benzina Petrol LGA 225	14	45
FINA140	9652.044	LOMBARDINI Benzina Petrol LKA 225	14	47
FINA149	960.118	ACME ADX 300	16	49
FINA149	960.118	ACME ADX 370	16	51
FINA149	960.118	ACME ADX 600	16	53
FINA149	960.118	ACME ADX 740	16	55
FINA149	960.118	ACME ADX 742	16	57
FINA151	960.115	ACME ADN 45	16	27
FINA156	960.58	RUGGERINI MD 301	19	11
FINA156	960.58	RUGGERINI MD 170	19	21
FINA156	960.58	RUGGERINI MD 171	19	23
FINA156	960.58	RUGGERINI MD 350	19	29
FINA156	960.58	RUGGERINI MD 351	19	31
FINA156	960.58	RUGGERINI MD 300	19	9
FINA156	960.58	RUGGERINI RY 100	20	13
FINA156	960.58	RUGGERINI RY 101	20	15
FINA156	960.58	RUGGERINI RY 120	20	19
FINA156	960.58	RUGGERINI RY 121	20	21
FINA156	960.58	RUGGERINI RY 125	20	23
FINA1568	0096521300	RUGGERINI RY 70	20	3
FINA1568	0096521300	RUGGERINI RY 75	20	9
FINA158	960.53	RUGGERINI MD 75.0	19	1
FINA158	960.53	RUGGERINI MD 85.0	19	13
FINA158	960.53	RUGGERINI MD 85.1	19	15
FINA158	960.53	RUGGERINI MD 95.0	19	17
FINA158	960.53	RUGGERINI MD 95.1	19	19
FINA158	960.53	RUGGERINI MD 190	19	25
FINA158	960.53	RUGGERINI MD 191	19	27
FINA158	960.53	RUGGERINI MD 75.1	19	3
FINA158	960.53	RUGGERINI MD 150	19	5
FINA158	960.53	RUGGERINI MD 151	19	7
FINA158	960.53	RUGGERINI RY 85.0	20	5
FINA158	960.53	RUGGERINI RY 85.1	20	7
FINA160	960.56	RUGGERINI RF 90	17	11
FINA160	960.56	RUGGERINI RF 91	17	13
FINA160	960.56	RUGGERINI RF 120	17	17
FINA160	960.56	RUGGERINI RF 121	17	19
FINA160	960.56	RUGGERINI RF 130	17	21
FINA160	960.56	RUGGERINI RF 140	17	23
FINA160	960.56	RUGGERINI RF 148	17	25
FINA160	960.56	RUGGERINI RD 210	18	27

Finimpianti	OEM	Costruttore-Motore <i>Manufacturer-Engine</i>	Cp.	Pg.
FINA160	960.56	RUGGERINI RD 211	18	29
FINA2293	0096521530	RUGGERINI RD 290	18	59
FINA2293	0096521530	RUGGERINI SP 420	18	61
FINA4936	9652.069	SLANZI DS 2000	15	39
FINA4936	9652.069	SLANZI DS 3000	15	41
FINA4936	9652.069	SLANZI DS 4000	15	43
FINA4938	9652.159	LOMBARDINI Benzina Petrol LGA 226	14	49
FINA4938	9652.159	LOMBARDINI Benzina Petrol LKA 226	14	51
FINA5000	960.128	ACME ADN 54 W	16	41
FINA5000	960.128	ACME ADN 60 W	16	47
FINA5002	960.136	ACME ADN 37 W	16	19
FINA5002	960.136	ACME ADN 43 W	16	23
FINA5002	960.136	ACME ADN 45 W	16	29
FINA5002	960.136	ACME ADN 48 W	16	35
FINA6110	0096521480	RUGGERINI RY 50	20	1
FINA6115	0096521630	RUGGERINI RY 103	20	11
FINA6115	0096521630	RUGGERINI RY 110	20	17
FINAS164	960.57	RUGGERINI RD 220	18	33
FINAS164	960.57	RUGGERINI RD 220	18	33
FINAS164	960.57	RUGGERINI RD 240	18	41
FINAS164	960.57	RUGGERINI RD 240	18	41
FINAS164	960.57	RUGGERINI RD 270	18	53
FINAS164	960.57	RUGGERINI RD 270	18	53
FINAS164	960.57	RUGGERINI RD 278	18	55
FINAS164	960.57	RUGGERINI RD 278	18	55
FINR1551MB STD	311.03	RUGGERINI MD 301	19	11
FINR1551MB STD	311.03	RUGGERINI MD 350	19	29
FINR1551MB STD	311.03	RUGGERINI MD 351	19	31
FINR1551MB STD	311.03	RUGGERINI MD 300	19	9
FINR1552MB STD	311.02	RUGGERINI MD 301	19	11
FINR1552MB STD	311.02	RUGGERINI MD 350	19	29
FINR1552MB STD	311.02	RUGGERINI MD 351	19	31
FINR1552MB STD	311.02	RUGGERINI MD 300	19	9
FINR4763MB STD	1585.100	SLANZI DVA 1200	15	19
FINR4763MB STD	1585.100	SLANZI DVA 920	15	3
FINR4763MB STD	1585.100	SLANZI DVA 1030	15	7
FINR4763MB STD	1585.100	SLANZI DVA 1030 S	15	9
FINR757MB STD		SLANZI DVA 650	15	15
FINR757MB STD		SLANZI DVA 680	15	17
FINR960CR STD	1611.172	SLANZI DVA 1200	15	19
FINR960CR STD	1611.172	SLANZI DVA 920	15	3
FINR960CR STD	1611.172	SLANZI DVA 1030	15	7
FINR960CR STD	1611.172	SLANZI DVA 1030 S	15	9
FINR963MB STD	1611.114	SLANZI DVA 650	15	15
FINR963MB STD	1611.114	SLANZI DVA 680	15	17
FINR965MB STD	1585.097	SLANZI DVA 1200	15	19
FINR965MB STD	1585.097	SLANZI DVA 920	15	3
FINR965MB STD	1585.097	SLANZI DVA 1030	15	7
FINR965MB STD	1585.097	SLANZI DVA 1030 S	15	9
FINS028	960.50	RUGGERINI MC 70	17	1
FINS028	960.50	RUGGERINI MC 71	17	3
FINS028	960.50	RUGGERINI RF 80	17	5
FINS028	960.50	RUGGERINI RF 81	17	7
FINS028	960.50	RUGGERINI RF 88	17	9
FINS028	960.50	RUGGERINI RD 200	18	15
FINS028	960.50	RUGGERINI RD 201	18	17
FINS028	960.50	RUGGERINI RD 208	18	19
FINS028	960.50	RUGGERINI RD 218	18	31
FINS028	960.50	RUGGERINI RD 180	18	5
FINS028	960.50	RUGGERINI RD 181	18	7
FINS028	960.50	RUGGERINI RD 188	18	9
FINS052	9685.022	INTERMOTOR Benzina Petrol IM 250	14	1
FINS052	9685.022	INTERMOTOR Benzina Petrol IM 300	14	11
FINS052	9685.022	INTERMOTOR Benzina Petrol IM 302	14	13
FINS052	9685.022	INTERMOTOR Benzina Petrol IM 302	14	15
FINS052	9685.022	INTERMOTOR Benzina Petrol IM 350	14	17
FINS052	9685.022	INTERMOTOR Benzina Petrol IM 350	14	19
FINS052	9685.022	INTERMOTOR Benzina Petrol IM 352	14	21
FINS052	9685.022	INTERMOTOR Benzina Petrol IM 352	14	23
FINS052	9685.022	INTERMOTOR Benzina Petrol IM 359	14	25
FINS052	9685.022	INTERMOTOR Benzina Petrol IM 359	14	27
FINS052	9685.022	INTERMOTOR Benzina Petrol LA 250	14	29
FINS052	9685.022	INTERMOTOR Benzina Petrol IM 250	14	3
FINS052	9685.022	INTERMOTOR Benzina Petrol LAP 250	14	31
FINS052	9685.022	INTERMOTOR Benzina Petrol LA 300	14	33
FINS052	9685.022	INTERMOTOR Benzina Petrol LAP 300	14	35
FINS052	9685.022	INTERMOTOR Benzina Petrol IM 252	14	5

Ricambi non originali per motori. Denominazioni e codici originali, sono riportati a puro titolo di riferimento.

35 - A

rel. 1511

Non original engine parts. OEMs names and part numbers are for reference purpose only.

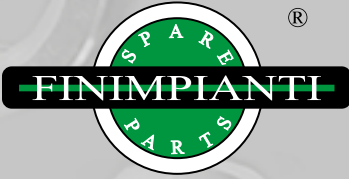

Via Aldo Moro, 9 - 10080 Oglianico (TO) - Italy

Tel. +39 0124 470670 - Fax +39 0124 470686

e-mail: info@finimpianti.it

<http://www.finimpianti.it>



www.finimpianti.it