

ILLUSTRATED GUIDE

For Building Safe and Durable Wood Decks and Balconies



This guide is for residential construction professionals to assist in building safe, durable wood deck and balcony structures for single and multi-family wood-frame homes in British Columbia.



Table of Contents

Forward	3
Acknowledgments	3
Disclaimer	3
Building Safe and Durable Wood Decks and Balconies	4
Overview	4
Types of Wood Decks and Balconies	4
Elements of Wood Decks and Balconies	5
Common Performance Issues	6
Structural Design	9
Design Loads	10
Foundations	11
Columns (Posts)	11
Framing (Joists and Beams)	12
Lateral Support	14
Decking	15
Guards	16
Stairs	17
Moisture Considerations	18
Slope and Drainage	18
Wood Movement	20
Ventilation and Drying	20
Flashing and Detailing	21
Building Interface	22
Balcony Edge	25
Moisture Point Sources	26
Material Choices and Specs	27
Decay-resistant Wood	27
Decking	28
Corrosion Resistant Fasteners, Connectors and Flashings	28
Maintenance and Renewals	29
Key Points to Consider	30
For More Information	31

Forward

This Guide provides readers with general information on best practice approaches for designing wood decks and balconies in British Columbia. It provides an overview of key principles that should be followed with regard to structural design, moisture management, material selection, and maintenance. Readers are urged not to rely only on this publication, but to also carefully review the British Columbia Building Code and other relevant documents as well as consult with appropriate, reputable professionals and construction specialists as necessary. For more detailed information, references are provided at the end of this publication.

Acknowledgments

This publication was developed through extensive consultation with many individuals and organizations involved in residential construction in British Columbia. BC Housing gratefully acknowledges the valued contributions made by the Industry Steering Committee. This guide was prepared by RDH Building Science Inc.

Disclaimer

While care has been taken to confirm the accuracy of information contained herein, the authors, contributors, funders, and publishers assume no liability for the accuracy of the statements made or for any damage, loss, injury or expense that may be incurred or suffered as a result of the use of or reliance on the contents of this Guide. It is the responsibility of all persons undertaking the design and construction of wood decks or balconies to review and comply with British Columbia's Building Code. The views expressed here do not necessarily represent those of individual contributors or BC Housing.

Building Safe and Durable Wood Decks and Balconies

Overview

While wood decks and balconies can be robust and long-lasting structures, they can be challenging to design and construct, primarily because of their exposure to the elements. This Guide provides an overview of commonly occurring durability issues and is intended to be used as a resource for designing, constructing, and maintaining wood deck and balcony structures.

Types of Wood Decks and Balconies

There are several different types of exterior wood structures that fall into the general category of wood decks and balconies. However, the terminology used to describe them is often ambiguous and is used inconsistently. In order to add clarity for this Guide, the following terminology is used: open deck, balcony and roof deck.

1. An **open deck** is an outdoor living surface generally constructed of spaced decking on a pressure treated wood framework. Water drains through the decking and framework to the ground below.
2. A **balcony** is an outdoor usable space that may or may not use pavers or other materials to create a walking surface over a continuous waterproof membrane installed onto the surface of an exterior-grade sheathing. Water is removed from the balcony surface at the perimeter of the structure or at drains integrated into the waterproof membrane. A balcony does not have occupied interior space below it. Balconies may be cantilevered or rely on a ledger attachment (and posts) for support.
3. A **roof deck** is a roof located above an indoor living space that is also outdoor usable space. The roof deck may use pavers or other materials to create a walking surface over the roof membrane. For the purpose of this publication, discussions related to roof decks will largely be omitted. However, the principles that guide other deck and balcony structures remain relevant for these structures as well.

These three types of exterior structures have important differences in detailing, drainage and material choices.



.....
Open Deck -
Independent Structure
(Post Support)
.....



.....
Open Deck -
Ledger Attachment
.....



.....
Balcony - Cantilevered
.....



.....
Roof Deck
.....

Elements of Wood Decks and Balconies

This Guide focuses on several components of these structures:

- Support structure
- Attachments
- Guardrails
- Stairs
- Walking surface

Factors that improve performance in the outdoor environment are also discussed. The diagram below identifies some common components of these structures.

Each of the three types of wood decks and balconies can be supported:

- By structural members that extend through the building enclosure (cantilevered), or
- As an independently supported structure, or
- One edge supported by a ledger attached to the building structure. The outside edge is supported independently on posts, piers, and footings.

Specific aspects and detailing of membranes, sealants and flashings are not addressed in this Guide, except as they impact the wetting and drying of wood elements. Refer to BC Housing's *Decks and Balconies Maintenance Matters Bulletin*¹ and *Building Enclosure Design Guide*² for further information on membranes.

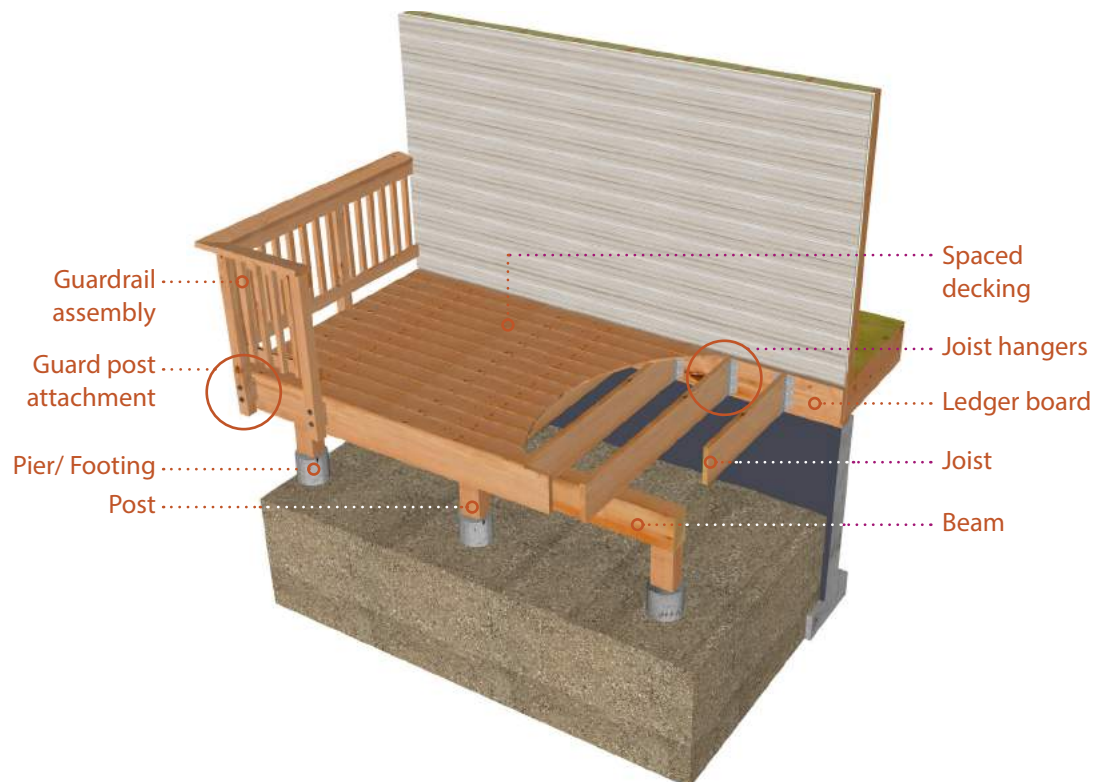

¹ <https://www.bchousing.org/research-centre>

² <https://www.bchousing.org/research-centre>

Common Performance Issues

The following is a summary of common performance issues with typical locations indicated on the accompanying house model graphic.

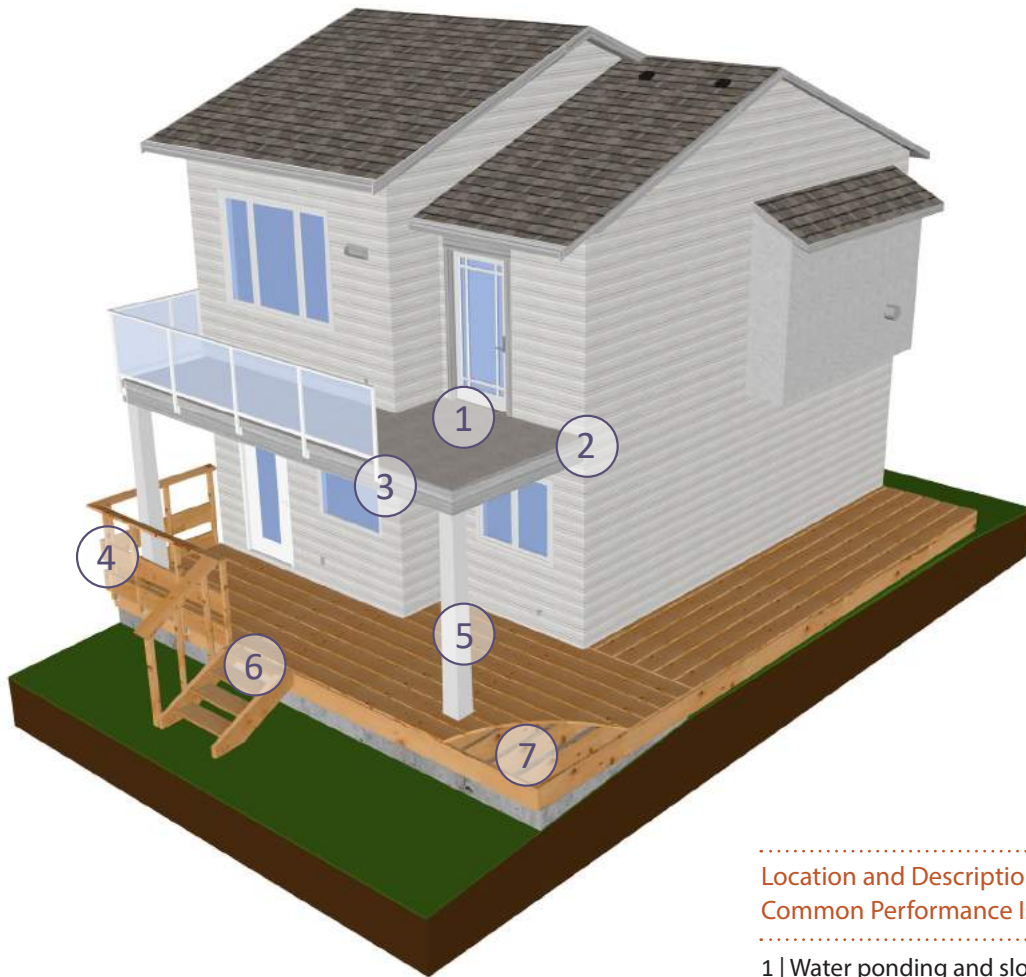

.....
Location and Description of
Common Performance Issues:
.....

- 1 | Water ponding and slope reversals
- 2 | Poor ledger attachment
- 3 | Deterioration of trim and fasciboard
- 4 | Unsafe guards and railings
- 5 | Deterioration of columns and posts
- 6 | Unsafe stair stringer attachment
- 7 | Deterioration of framing and sheathing



1 | Water ponding and slope reversals

Excessive water ponding on membraned balconies/decks can lead to moisture ingress at installation deficiencies and membrane degradation. Water ponding occurs where the surface of the deck or balcony is not adequately sloped to encourage positive drainage. Other causes include obstructions to the drainage path (wood sleepers, etc.) and clogged or limited drains.



2 | Poor ledger attachment

Deck and balcony ledger attachment to the building structure is a common point of failure. If inappropriate fasteners or fastener spacings are used for structural connections, the deck or balcony may not be able to adequately accommodate the required design loads. If the ledger attachment is not suitably detailed and protected from moisture exposure, leakage into the building enclosure may occur and untreated wood products may experience decay.



3 | Deterioration of trim and fascia board

Trim and fascia board deterioration occurs with excessive moisture exposure and/or incorrect material choices. Poor detailing of membranes and edge flashing can lead to trim/fascia that has minimal protection from exterior moisture. Water ponding on the flat top of trim boards, or trapped between the rim joist and trim, where water is held and drying is limited, also leads to premature failure. If treated or decay-resistant wood is not used, trim/fascia may deteriorate quickly.



4 | Unsafe guards and railings

Unsafe guards and railings are the result of poor design or inappropriate material choices. If guard and railing components are not sized, attached, or spaced suitably, they may not adequately support the required design loads. Use of wood products that are not adequately decay-resistant, and fasteners that are not sufficiently corrosion-resistant, can also hasten guard and railing failures.

5 | Deterioration of columns and posts

Wood columns and posts exposed to high levels of moisture are at increased risk of decay. Wood products with elevated moisture contents for extended periods of time provide a perfect environment for wood decay fungi and insect attack. Common problems include:

- Wood elements that are not an appropriate height above ground level
- Posts and columns with inadequate base drainage or with attached cladding that traps water
- Use of untreated wood products and/or inappropriate use of membranes
- Insufficient separation between concrete footings and posts (no drainage and drying provisions)



6 | Unsafe stair stringer attachment

If stairs are not properly secured to the horizontal wood-framed structure there is a high probability of failure. Often nails and blocking are inappropriately used in place of screws and stringer hangers to secure the stairs to the deck. The stair attachment point must also be designed to allow drying to occur when wood components are wetted. Another common issue is poor material choice: the use of non-corrosion-resistant fasteners and untreated wood products may lead to metal corrosion and wood decay.



7 | Deterioration of framing and sheathing

If moisture penetrates into the deck/balcony framing space, the assembly may experience wood decay. A common cause of framing and sheathing deterioration is waterproof membrane failure due to poor membrane installation or fastener penetrations allowing moisture to contact untreated wood products below. Other causes of damage are point sources such as dryer duct vents exhausting into the balcony framing cavity, and/or a lack of ventilation provisions (vented soffit panels) allowing incidental moisture to be removed from the cavity space.



Structural Design

British Columbia Building Code (BCBC)³ dictates the structural requirements for exterior decks and balconies including stairs and guardrails. If the building complies with Part 9 of BCBC, which regulates the construction of houses and small buildings, then the structural requirements must meet the prescriptive requirements specified for balconies and decks. Buildings that do not comply with Part 9, including buildings over three storeys in height or those that have assemblies beyond the limitations of Part 9, are required to meet the structural requirements of Part 4 of BCBC. The following sections are of particular importance to balcony and deck construction:

- Section 4.2 – Design requirements for foundations not included in Part 9
- Section 4.3 – Design requirements for wood structural materials not included in Part 9
- Section 9.8 – Requirements for the design of stairs, handrails and guards
- Section 9.17 – Requirements for wood columns (posts)
- Section 9.23 – Requirements for wood framing of decks and balconies
- Section 9.26 – Requirements for roofing (balcony/decks with roof structures)

The articles within BCBC guiding deck and balcony structural design are referenced in the following section. Where explicit building code guidance is not provided, industry best practices should be applied to ensure safe and robust wood structures. Note that deck and balcony design may be altered during construction due to changing owner requirements. Care must be taken to ensure that all modifications meet BCBC and do not compromise good design principles.

³ <http://www.bccodes.ca/building-code.aspx>

Design Loads

The loading, spacing, and sizing of structural members is influenced by local environmental conditions, material choices, service conditions (wet, dry), and occupant usage such as hot tubs and fire places. Balconies and decks must be designed to accommodate the local specified snow load or an occupancy load of 1.9 kPa — whichever load is higher (BCBC 9.4.2.3). Snow loads vary considerably across British Columbia, leading to considerably different structural requirements in different areas of the province (see table below).

Note that wood framing exposed to repetitive wetting in an exterior application (wet service conditions) is not accounted for in the prescriptive solutions provided in BCBC 9.23 and may need to meet Part 4 of the Code. Elements such as hot tubs represent very high localized loading requiring significant upgrading of the structure beyond Code-specified snow and occupancy loads. Roof decks may also have large pots and planters installed that will also dictate upgrading of the structure. Ideally, building strata councils should provide guidance on the limitations of unit balconies and decks in order to prevent unacceptable loading.

Select Specified Loads across British Columbia

Location	Design Snow Load for Decks and Balconies (kPa) $S = 0.55S_s + S_r$
Abbotsford	1.4
Cranbrook	1.9
Kamloops	1.2
Kelowna	1.0
Merritt	1.3
Prince George	2.1
Terrace	3.6
Vancouver	1.2
Victoria	1.0 (min, see 9.4.2.2(2))
Whistler	6.1



High Localized Loading

A hot tub requires structural upgrades

Foundations

All foundations must extend down to undisturbed soil (BCBC 9.12.2.1). The minimum depth of foundations for decks and balconies is largely governed by the type of soil (e.g., rock, coarse-grained soil, clay). Refer to BCBC 9.12.2.2 for more information. If foundations are located on, in, or near sloping ground, they must be designed to account for potential slope instability (BCBC 4.2.4.5). In practice, building in these conditions often means deeper or wider foundations are necessary. It is recommended that concrete footings and piers extend a minimum 152mm (6") above grade to limit the moisture exposure of wood elements in the deck/balcony structure.

Hot-dipped galvanized steel helical piles are occasionally utilized in place of traditional concrete foundations as permanent load-carrying members. The helical piles transfer deck loads via bearing and friction into the surrounding soil/rock; this allows them to be installed in loose soils and/or locations with high groundwater. Because helical piles are classified as **deep foundations**, they must be designed and installed according to BCBC 4.2.7.2 and BCBC 4.2.7.5, respectively.

Columns (Posts)

Wood columns or posts must be 140mm x 140mm (5.5" x 5.5") for rectangular columns and 184mm (7.25") in diameter for round columns unless structural calculations indicate a lesser size is structurally adequate (BCBC 9.17.4.1). As a reference, the Canadian Wood Council (CWC) recommends a post size of 89mm x 89mm (3.5" x 3.5") for decks less than or equal to 2.0m (6.5ft) in height, otherwise post size must be 140mm x 140mm (5.5" x 5.5") up to 3.66m (12ft) in height.

Columns require anchorage to the foundations unless the limitations of BCBC 9.23.6.2 are met in another manner. Physical separation is required between wood columns and concrete in contact with the ground (BCBC 9.17.4.3). In practice, separation can be provided by a number of components including neoprene spacers, metal post bases, or saddle anchors. Always ensure that posts are centrally located over the foundations (concrete piers) in order to ensure that loads are transferred effectively from the deck/balcony structure to the ground.

.....
Left:
Helical pile foundation
.....



.....
Right:
Post connection to
concrete foundation
.....



Framing (Joists and Beams)

Once the deck or balcony dimensions and design loads are determined, structural framing members (joists and beams) can usually be selected from span tables in the Code. Framing members are highly influenced by wood species, preservative treatment process (incising), service conditions, and joist spacing and dimensions. The following tables are reproduced from the CWC *Prescriptive Residential Exterior Wood Deck Span Guide*⁴ and can be used for incised (treated) wood products in wet service conditions. Note that wet service conditions and the use of pressure treated lumber will reduce allowable spans compared to untreated, protected framing members. As a result, untreated framing members in protected balconies will generally require different span tables.

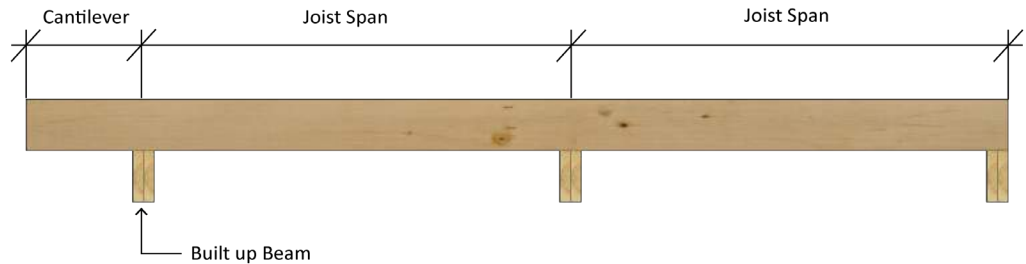

Allowable Joist Spans (meters)

Joist Size (mm)	300mm Joist Spacing				400mm Joist Spacing				600mm Joist Spacing				Maximum Allowable Cantilever (mm)
	DF-L	H-F	S-P-F	Nor	DF-L	H-F	S-P-F	Nor	DF-L	H-F	S-P-F	Nor	
38 x 89	2.01	2.01	1.91	1.73	1.82	1.82	1.74	1.57	1.51	1.58	1.52	1.32	200
38 x 140	3.05	3.16	3.01	2.66	2.64	2.77	2.73	2.30	2.15	2.26	2.34	1.88	400
38 x 184	3.71	3.89	3.95	3.23	3.21	3.37	3.49	2.80	2.62	2.75	2.85	2.28	400
38 x 235	4.53	4.75	4.92	3.95	3.92	4.12	4.26	3.42	3.20	3.36	3.48	2.79	600

Beam Selection Supporting Two Spans (meters)

Joist Span (m)	1.2m Post Spacing				1.8m Post Spacing			
	DF-L	H-F	S-P-F	Nor	DF-L	H-F	S-P-F	Nor
2.4	2-38 x 140	2-38 x 140	2-38 x 140	2-38 x 140	2-38 x 235	2-38 x 184	2-38 x 184	2-38 x 235
3.0	2-38 x 140	2-38 x 140	2-38 x 140	2-38 x 184	2-38 x 235	2-38 x 235	2-38 x 235	2-38 x 286
3.7	2-38 x 184	2-38 x 140	2-38 x 140	2-38 x 184	2-38 x 286	2-38 x 235	2-38 x 235	3-38 x 235
4.3	2-38 x 184	2-38 x 184	2-38 x 184	2-38 x 235	2-38 x 286	2-38 x 286	2-38 x 286	3-38 x 235

Note:

- Beam information is provided as numbers of plies — ply thickness(mm) x ply depth(mm)
- Wood Species:

DF-L	Douglas Fir, Western Larch
H-F	Western Hemlock, Amabilis Fir
S-P-F	White Spruce, Engelmann Spruce, Black Spruce, Red Spruce, Lodgepole Pine, Jack Pine, Alpine Fir, Balsam Fir
Nor	Eastern White Cedar, Western Red Cedar, Yellow Cedar, Grand Fir, Eastern Hemlock, Eastern White Pine, Ponderosa Pine, Red Pine, Western White Pine, Whitebark Pine, Coast Sitka Spruce, Western White Spruce, Eastern Larch, Aspen Poplar, Largetooth Aspen, Black Cottonwood, Balsam Poplar

• Reproduced from *Prescriptive Residential Exterior Wood Deck Span Guide* (CWC)

⁴ <http://cwc.ca/wp-content/uploads/2016/05/Prescriptive-Residential-Exterior-Wood-Deck-Span-Guide.pdf>

Joist spacing is limited to a maximum of 600mm (24") or less for Part 9 buildings (BCBC 9.23.1.1). If the deck or balcony is designed for a Part 4 building, the joist spacing can exceed this value; however, the structure of the deck or balcony must be designed by a professional engineer.

Beam selection (sizing, number of plies) is influenced by several factors including post spacing, joist span, service conditions, wood treatment, and wood species characteristics. When joists are connected to a beam, they must either be supported by the top of the beam or be framed to the side of the beam (BCBC 9.23.9.2). When the side connection option is selected, joists must be secured to the beam with acceptable metal connectors or by ledger strips and fasteners (BCBC 9.23.9.2).

Refer to BCBC and *CAN/CSA O86 Engineering Design in Wood* for further guidance on the selection of wood framing members.



.....
Wood deck framing
.....

Lateral Support

All decks and balconies over 600mm (24") above ground must be laterally supported to resist racking (horizontal movement) of the structure (BCBC 9.17.2.2). In practice, this means that most deck structures must be tied to the building (ledger attached structure) or, alternatively, have bracing between the columns and the supported members (freestanding structure). Note that large decks set on tall columns or posts may require additional lateral support in the form of post bracing and/or additional building connections. Typically, two or more hold-downs or similar tension devices (engineered connectors) should be installed when lateral loads exceed the design capacity of the ledger connection.

If a ledger attachment is used, an adequate water management strategy must be developed to reduce the potential for periods of extended wetting as poor detailing at the ledger connection is a common cause of failure in this deck/balcony type. While BCBC does not provide comprehensive guidance on ledger fastening patterns, *Section R507.2⁵* of the International Residential Code (IRC), the model building code adopted throughout most of the United States, has requirements for both fastener selection and placement.

Best practices dictates that lag bolts or through bolts with washers be used to secure the ledger to the appropriate backing within the building structure. Fasteners should be 13mm (0.5") in diameter and must fully penetrate through the ledger and rim joist. A gap of 13mm (0.5") is structurally allowable between the ledger and wall and is recommended for open decks to provide space for drainage and drying to occur. In order to ensure a robust connection to the building and sufficient support for the deck structure, fasteners should be installed in a staggered fashion at a spacing corresponding to the joist span. The table and corresponding figure below provide guidance on fastener spacing and placement at the ledger.

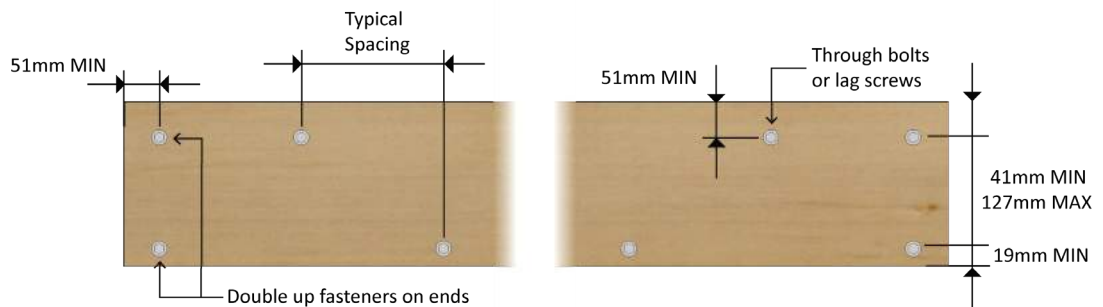

Fastener Spacing for Deck Ledger (millimeter)

Joist Span (m)	≤1.82	2.44	3.05	3.66	4.27	4.88
Connection Details	On-center Spacing of Fasteners					
13mm diameter lag screw with 12mm MAX sheathing	762	584	457	381	330	279
13mm diameter bolt with 12mm MAX sheathing	914	914	864	737	610	533
13mm diameter bolt with 12mm MAX sheathing and 13mm stacked washers ²	914	914	737	610	533	457

Note:

- Ledger must be minimum 38mm x 184mm and pressure-preservative-treated S-P-F or better.
- Stacked washers must be galvanized or stainless steel or an alternative corrosion resistant material.
- Adapted from *Section R507.2 - Decks* (IRC).

Decking

Some exterior wood structures rely on spaced deck boards or decking for a walking surface. Joist spacing typically governs the minimum allowable thickness of decking: as joist spacing increases, decking thickness must also increase (BCBC 9.30.3.1). At 400mm (16") joist spacing decking must be 25mm (1") thick, whereas at 600mm (24") joist spacing decking must be 38mm (1.5") thick. It is recommended that decking be face-nailed to the joists with two fasteners at each end, located at 25% and 75% width, to reduce end-splitting. An alternating fastener pattern can then be installed at joist spacing for the remainder of the decking length. This fastener arrangement reduces the potential for checking and minimizes the number of fasteners that are needed.

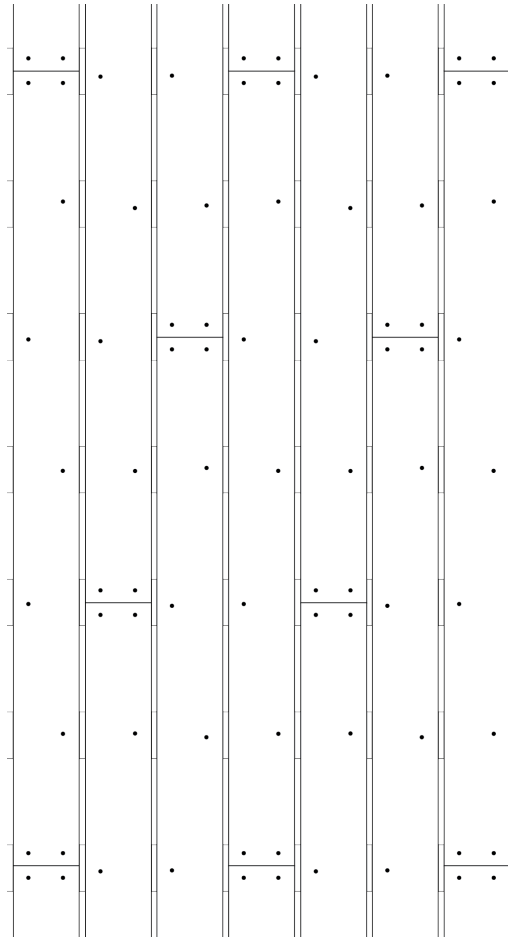

Decking nailing pattern

Guards

All decks/balconies that are higher than 600mm (24") above grade must have guards to mitigate fall hazards (BCBC 9.8.8.3). In order to minimize the risk of children bypassing guardrail assemblies, all openings must be designed to prevent the passage of a 100mm (4") diameter object or must demonstrate that the opening in question is not hazardous (BCBC 9.8.8.5).

It is recommended that guard posts be fastened with lag bolts or through bolts to ensure they are adequately supported, though nails and screws are acceptable in some situations, as detailed in *Supplementary Standard SB-7⁶* of the 2012 Ontario Building Code Compendium (Volume 2). Support blocking should also be provided where the guard post is side mounted to the deck structure (rim or floor joists) to ensure that the horizontal and vertical design loads are met as specified in the Code (BCBC 9.8.8.2).

Guard posts should not be secured to the top surface of the deck or balcony because it is difficult to achieve adequate structural attachment and good drainage in this configuration. Where possible, a gap should be provided between the guard post and rim joist to facilitate drainage and drying.

In order to provide the required load resistance at the post-to-rim-joist connection, straps or other connectors are recommended to transfer loads placed on the guard back into the deck joist framing. If necessary, consult with a professional engineer to confirm that the guard configuration meets Code requirements.

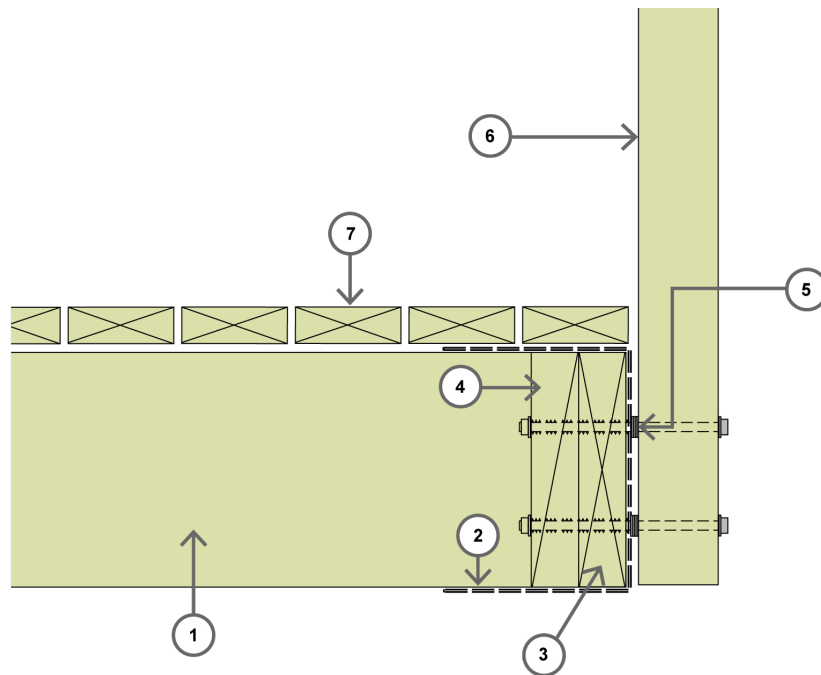

Legend

1. Wood joists (p.t.)
2. Structural strap at each side of guard post
3. Rim joist (p.t.)
4. Blocking (p.t.)
5. Hot dipped galvanized washers at post locations
6. Guardrail system (p.t.)
7. Wood decking (p.t.)

p.t. - pressure treated

Deck guard post attachment

⁶ <https://www.publications.serviceontario.ca/ecomlinks/510090.pdf>

Stairs

The design of wood stairs including treads, risers and stringers is covered in Section 9.8 of BCBC. Stringers must be supported at the top and bottom and must be well supported by the wood framing members of the deck or balcony structure (BCBC 9.8.9.4). Typically, the bottom of the stairs should be bolted to an at-grade concrete pad or slab. While a ledger strip fastened with nails is acceptable for stair attachment to the deck/balcony, when possible it is recommended that stringer hangers or other engineered connectors be used.

Always avoid overcutting stair stringers when sizing them to the necessary dimensions. Note that any cuts and notches in the stringers should be treated with a field-cut preservative such as copper or zinc naphthenate.

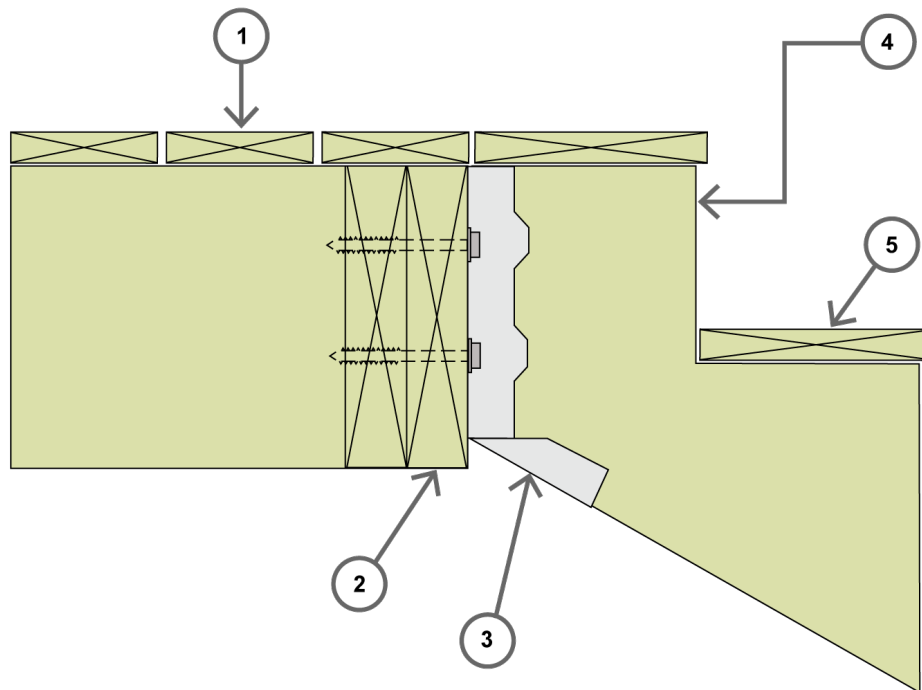

Legend

1. Wood decking (p.t.)
2. Rim joist (p.t.)
3. Stringer hanger secured to rim joist with screws
4. Stringer (p.t.)
5. Stair thread (p.t.)

p.t. - pressure treated

Stair stringer attachment

Moisture Considerations

A key consideration for durability is controlling moisture by preventing or reducing deck and balcony exposure to the natural elements and encouraging drainage and drying. The following concepts should be addressed in the design and construction of wood decks and balconies.

Slope and Drainage

When a balcony membrane is used, the deck surface should be sloped away from the building enclosure at a minimum in-service slope of 2% (taking into account wood shrinkage). The drainage surface should be unobstructed so ponding does not occur (BCBC 9.26.3.1). This is particularly important at balcony edges and corners, where different components and materials interface and detailing is critical. By providing adequate slope and removing any obstacles to movement, bulk water is able to move freely past high-risk areas. Slope can be provided in membraned balconies through cross-strapping or tapered joists. Waterproof membranes should follow all Code and manufacturer requirements and should also follow Roofing Contractors Association of British Columbia (RCABC) standards to ensure proper installation and detailing of the membrane.

In situations where free drainage of deck or balcony surfaces is not possible, drains of a sufficient diameter should be provided to remove surface water. At least two drains should be provided in order to prevent water build up from occurring if the primary drain becomes plugged with debris: overflow provisions should be equal to the drainage capacity of the deck/balcony. Ideally, any horizontal surfaces such as the tops of guard rails should also be sloped to limit sitting water.

When alternate walking surfaces (pavers, concrete topping, decking) are included over a membrane, it is important that a drain mat, pedestals, shims, or sleepers be provided to facilitate drainage and drying. If a gap is not provided between the membrane and concrete topping or other walking surface, moisture will be retained against the membrane surface increasing the risk of membrane failure and subsequent moisture ingress. When a permanent walking surface such as concrete topping is installed directly over the membrane surface, it is difficult to service in the event of a water leak. Furthermore, membrane damage may occur when the concrete topping is removed for repairs.

When alternate walking surface materials are used, they should be constructed in removable sections to enable drainage-obstructing detritus to be removed, and to facilitate maintenance and renewal of the membrane without damage to the wood substrate.

Balcony Assemblies with Drainage

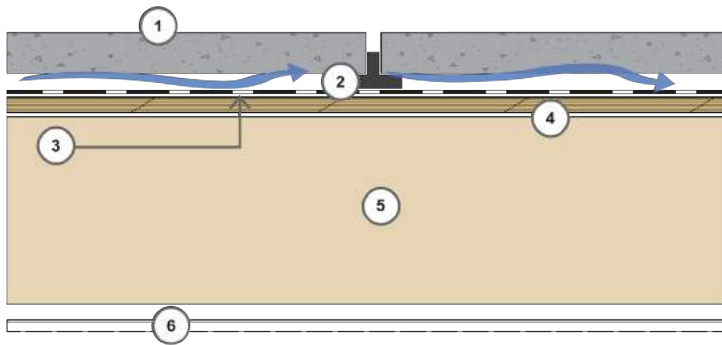

Pavers

Legend

1. Pavers
2. Pedestals
3. Waterproof membrane
4. Sheathing
5. Wood framing sloped to drain
6. Vented soffit panels

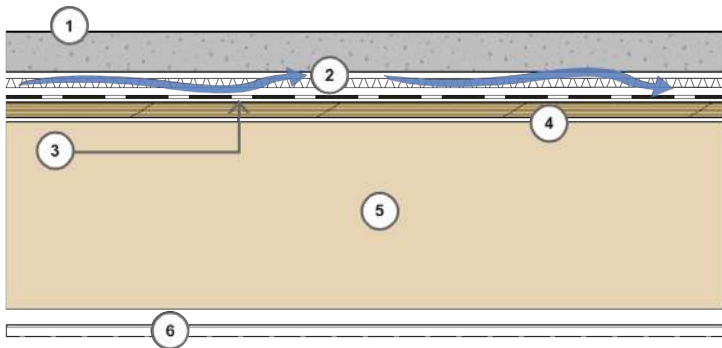

Concrete Topping

Legend

1. Concrete topping OR Tile on mortar bed*
2. Drainage composite
3. Waterproof membrane
4. Sheathing
5. Wood framing sloped to drain
6. Vented soffit panels

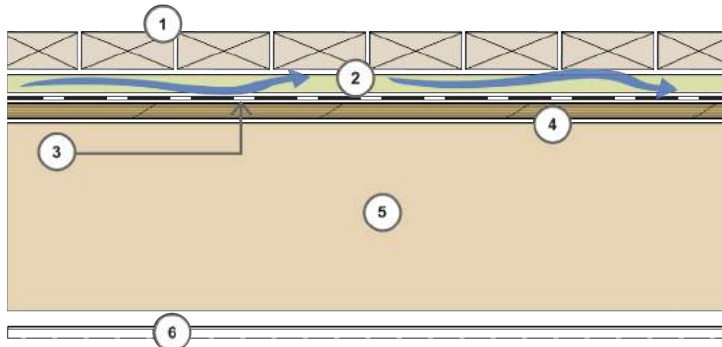

Decking

Legend

1. Wood decking
2. Sleepers (p.t.) with layout to facilitate drainage
3. Waterproof membrane
4. Sheathing
5. Wood framing sloped to drain
6. Vented soffit panels

* Do not place concrete or tile directly on waterproof membrane

For structural members such as posts in close proximity to concrete, separation should be provided between the post end grain and concrete foundation to allow drainage and drying to occur. Ideally, posts should be elevated above the concrete foundation in a metal saddle anchor or post base with appropriate drainage and drying provisions such as weep holes. Typical post base stand-off height is 1" (25mm).

Wood Movement

For wood elements that experience high moisture exposure, care must be taken to address wood shrinkage and expansion. Decking commonly experiences high levels of in-service moisture and is susceptible to damage due to improper installation such as inadequate spacing. By properly spacing decking, some allowance for wood movement, drainage, and drying is provided. A minimum spacing of 6mm (0.25") is recommended between deck boards. Spacing should be further increased if organic matter tends to collect at the particular building site.

Ventilation and Drying

It is critical that wood decks and balconies allow wood elements to dry when wetting occurs. Many components are constantly exposed to moisture and will deteriorate if they are unable to dry out—even if they are naturally durable or treated with preservatives. Soffit panels should be vented when installed on the underside of a balcony to allow for framing members to dry. Situations should also be avoided where the end grain of wood elements is maintained in a wet environment where it is unable to readily drain and dry.

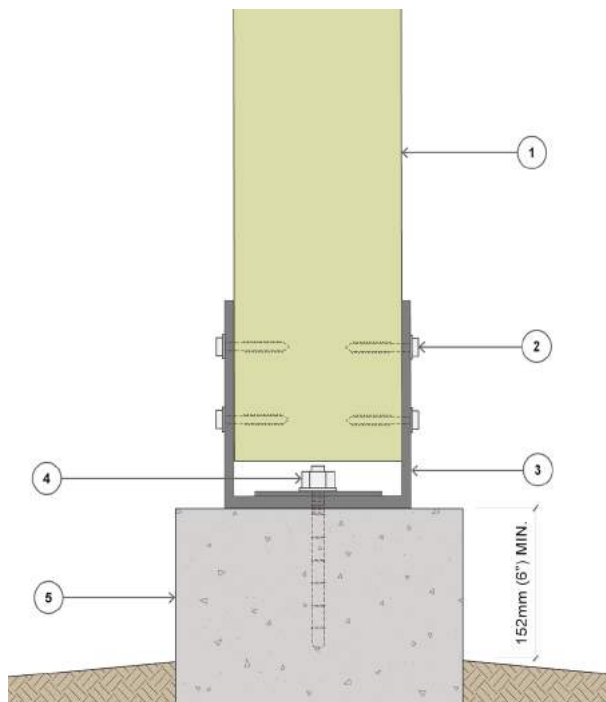

Legend

1. 140x140mm (5.5" x 5.5") Wood posts (p.t.)
2. Hot dipped galvanized lag screws
3. Hot dipped galvanized standoff post base
4. Hot dipped galvanized anchor bolt
5. Concrete footing

p.t. - pressure treated

.....
 Post elevated above
 concrete foundation

Flashing and Detailing

Maintaining continuity of water drainage surfaces and waterproofing through proper detailing of all membranes and flashings is critical — improper sequencing of building components can lead to water ingress and other related problems. Overhangs and metal flashings (cap, drip edge) should be used to reduce moisture exposure and to direct water away from moisture-sensitive materials.

Detailing is particularly important at the edges of the deck/balcony structure and where it interfaces with the main building enclosure. For additional guidance on detailing wood decks and balconies, refer to BC Housing's *Building Enclosure Design Guide*².

Metal Flashing Profiles

Flashing profiles have a strong impact on the water-shedding characteristics of flashing elements: the overhang distance, metal gauge, and profile angle all influence the effectiveness of the flashing. Ideally, a heavy gauge metal (24 gauge) should be selected to mitigate surface tension effects at the bottom leg of the flashing. A minimum 13mm (0.5") gap is recommended between the flashing bottom leg and the vertical framing surface behind as well as a 45-degree drip edge in order to limit water kick-back behind the flashing.

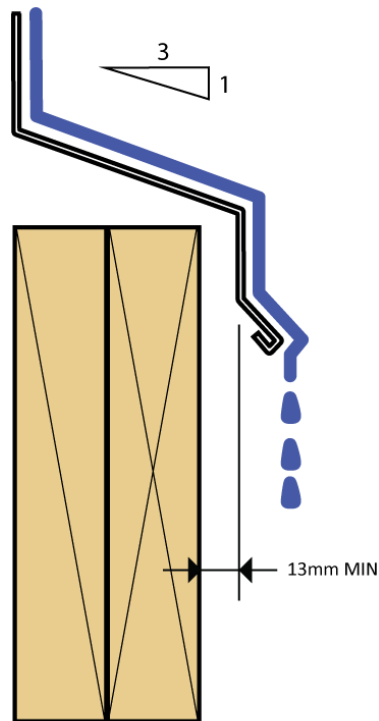

.....
Drip edge profile
.....

Building Interface

Many decks and balconies rely on a ledger connection for structural support. The development of an effective water management and detailing strategy at the ledger attachment is critical.

For open decks, a strip of waterproof membrane should be installed between the ledger and the building rim joist to protect the untreated wood elements in the wall assembly. Corrosion resistant washers should also be installed between the ledger and rim joist to facilitate drainage behind the ledger.

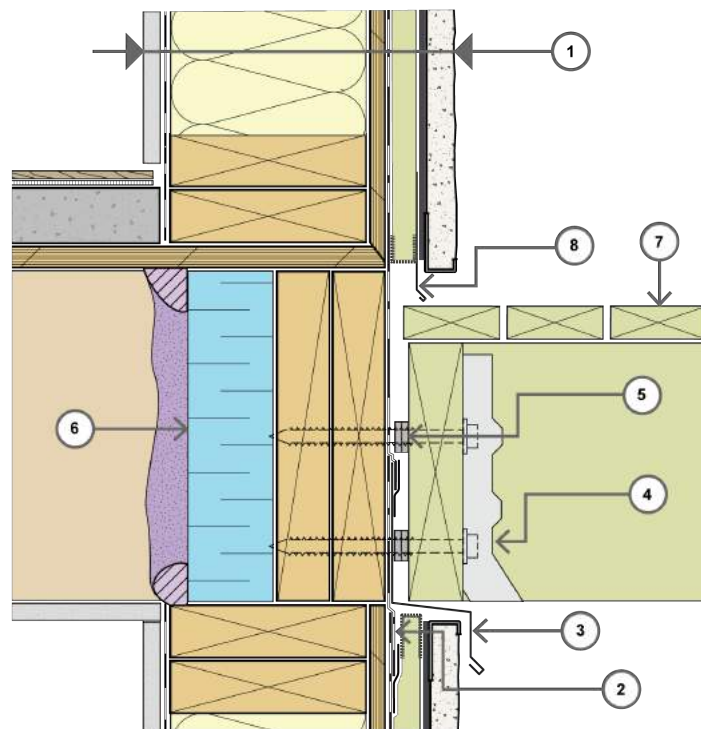

Legend

- | | |
|--|---|
| <p>1. Wall Assembly
 Cladding (stucco with backer board)
 19mm (0.75") wood furring (p.t.)
 Vapour permeable sheathing membrane
 Sheathing
 Wood framing 38x140mm (2x6)
 Batt insulation
 Polyethylene
 Gypsum board</p> | <p>3. Cross cavity flashing with sheathing membrane
 taped to flashing back leg
 4. Joist hanger secured to ledger board
 5. Hot dipped galvanized washers
 6. Extruded polystyrene with spray foam at edges
 7. Wood decking (p.t.)
 8. Metal flashing secured to wood furring</p> |
| <p>2. Vapour permeable membrane pre-strip
 lapped and taped to sheathing membrane
 below</p> | |

p.t. - pressure treated

Open deck ledger attachment

Membraned balconies also require careful detailing where the wall and balcony meet. Sequencing of membranes and flashing at this interface must be correct in order to maintain waterproofing continuity. In particular, the corner interface, where the balcony edge and wall meet, requires interactions between the sheathing membrane (or building paper), balcony membrane and several tapes, sealants, and flashings that must all be compatible and properly detailed.

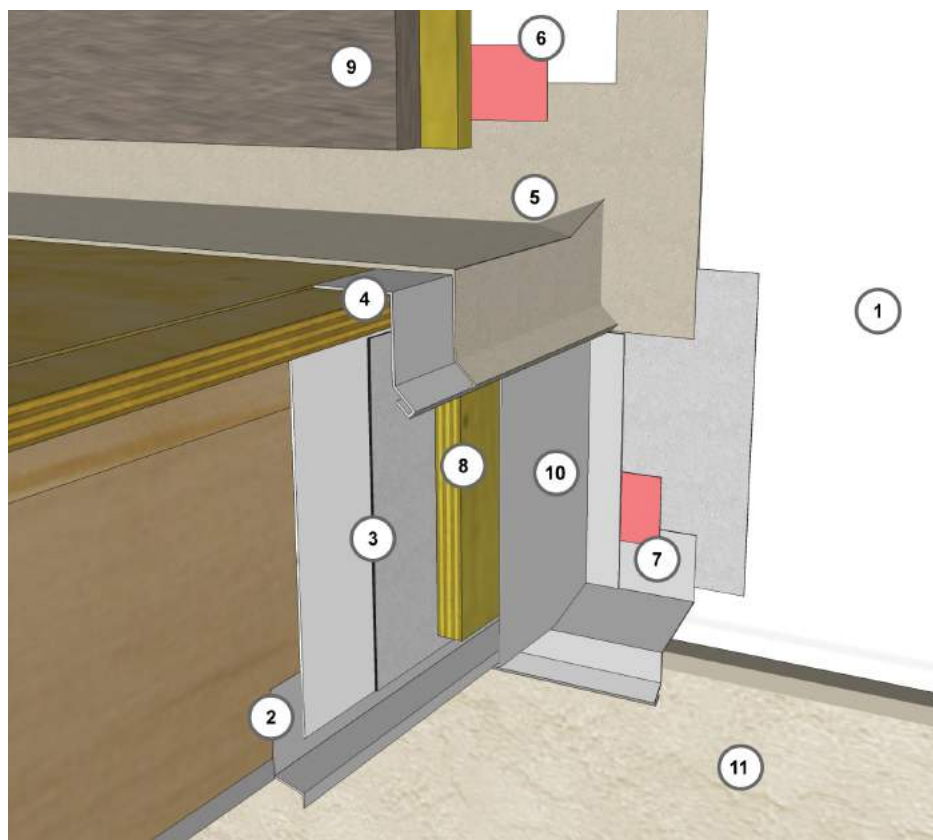

- | Legend | |
|---|---|
| 1. Sheathing membrane pre-strip behind ledger | 7. Pre-finished metal flashing beneath balcony corner |
| 2. Metal closure flashing with weep holes | 8. Wood furring strip (p.t.) |
| 3. Balcony edge membrane with self-adhered membrane at transition to wall | 9. Balcony trim |
| 4. Pre-finished metal flashing | 10. Pre-finished metal flashing |
| 5. Balcony membrane with cricket to divert water away from corner interface | 11. Cladding (stucco) |
| 6. Sheathing membrane lapped and taped to balcony membrane | |
- p.t. - pressure treated*

Balcony to wall corner interface

To reduce the risk of wind-driven rain penetration, particularly at doors exiting onto the deck or balcony structure, it is good practice for the horizontal surface to be below the floor level of the building. The detail below provides an example of proper detailing at an entry door onto a balcony.

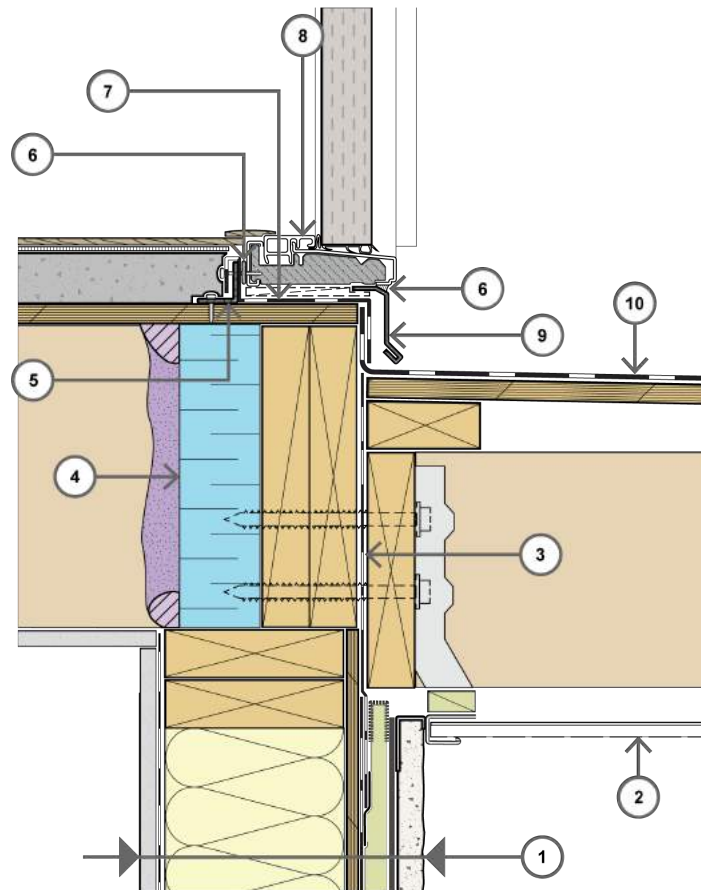

Legend

- | | |
|--|---|
| <ol style="list-style-type: none"> 1. Wall Assembly
Cladding (stucco with backer board)
19mm (0.75") wood furring (p.t.)
Vapour permeable sheathing membrane
Sheathing
Wood framing 38x140mm (2x6)
Batt insulation
Polyethylene
Gypsum board 2. Perforated soffit panel 3. Vapour permeable membrane pre-strip lapped and taped to sheathing membrane below | <ol style="list-style-type: none"> 4. Extruded polystyrene with spray foam at edges 5. Aluminum sill angle (back-dam under door) 6. Sealant 7. Self-adhered membrane (compatible with balcony membrane) 8. Door sill on intermittent shims 9. Pre-finished metal flashing 10. Balcony membrane |
|--|---|
- p.t. - pressure treated*

Balcony entry door

Balcony Edge

The balcony edge can be particularly susceptible to poor detailing: several components commonly interface at this location including the guardrail assembly, edge flashing, and balcony membrane. The guardrail assembly should be supported by the vertical face of fascia boards or rim joists. Top-mounted guards increase the risk of moisture ingress due to fastener penetrations through the waterproof membrane and should be avoided.

Proper installation and sequencing of membranes and flashings reduces the potential for water ingress. Blocking, installed at the point of guard post attachment, provides space for drainage and drying to occur behind the closure flashing. Care should be taken to ensure adequate slope is provided at the balcony edge to remove bulk water from this detail.



Top mounted guard posts should be avoided

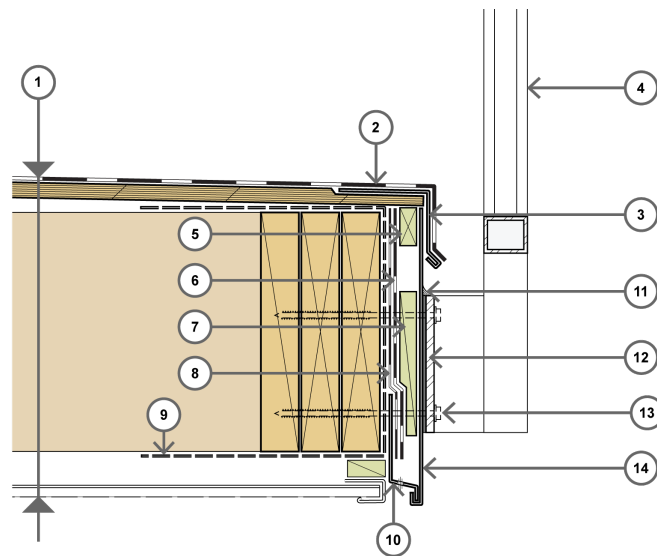

Legend

- | | |
|--|--|
| 1. Balcony Assembly
Balcony membrane
Sheathing
Strapping to provide slope
Wood joist
Perforated soffit panel on furring | 6. Self-adhered membrane at post locations |
| 2. Adhered balcony membrane onto flashing | 7. Plywood blocking at post locations (p.t.) |
| 3. Pre-finished metal flashing
(rabbet plywood edge for flashing) | 8. Permeable sheathing membrane lapped onto metal flashing |
| 4. Guardrail assembly | 9. Structural strap at each side of guardrail post |
| 5. Continuous 19x38mm (1x2) blocking (p.t.) | 10. Metal closure flashing with weep holes |
| | 11. Sealant at top & sides of guardrail post plate |
| | 12. Guardrail post plate on gasket |
| | 13. Lag bolts |
| | 14. Pre-finished metal fascia flashing |

Balcony edge

Moisture Point Sources

Moisture point sources should be avoided or minimized:

- Wood posts should be elevated above soil and hardscapes to avoid soil moisture and water splashing from hardscapes.
- Dryer vents should be vented well away from wood decks and balconies and carefully detailed to minimize condensation on the underside of the structure. Side wall venting of gas appliances below decks and balconies should also be avoided.
- Gutters and downpipes should not discharge directly onto wood decks or balconies. If this is not possible, splash pads or protection mats should be used. Downpipes should be routed to the ground level and directed away from the deck and building.
- Planters and hot tubs should not sit directly on decking or waterproof membranes as drainage must be provided underneath. Always ensure the structure has been designed to accept the additional load.



.....
Good practice of
elevating planter boxes
with drainage beneath
.....

Material Choices and Specs

Where moisture exposure is inevitable, selection of moisture-resistant components and materials is essential to ensure the longevity and safety of wood decks and balconies.

Decay-resistant Wood

All wood elements exposed to water should be decay-resistant or have a factory-applied pressure preservative treatment such as Amine Copper Quat (ACQ), Copper Azole (CA), Micronized Copper Quat (MCQ), or Micronized Copper Azole (MCA). Pressure treatment is necessary for the preservative chemicals to sufficiently penetrate the wood products. If pressure-treated wood is cut or notched during construction, a field-cut preservative should be applied to protect the cut area. Copper naphthenate and zinc naphthenate are two common preservatives used for this purpose.

While a preservative treatment is recommended under most circumstances, the heartwood of some wood species has inherent decay-resistant properties and can be used for **decking, fascia board and trim**. See the table below for naturally durable wood species. Note that while cedar and redwood species are naturally durable, they should not be used in many applications without appropriate preservative treatment. Wood coatings such as paints and stains should not be considered a primary durability measure — at best they reduce moisture absorption and lower UV exposure.

Natural Durability of Common Wood Species

Species	Predominant in Tree	Durability
Western Red Cedar	Heartwood	Durable
Eastern White Cedar	Heartwood	Durable
Yellow Cedar	Heartwood	Durable
Redwood	Heartwood	Durable
All other wood species have limited natural durability		

The following table, reproduced from BC Housing's *Building Enclosure Design Guide*⁷, provides guidance on wood materials and preservative treatment selection dependent on their application in the deck or balcony structure.

Recommended Wood Products and Treatments for Deck and Balcony Components

Components	Conditions of Service	Wood Product	Treatment
Floor framing for exterior balconies and walkways over nonliving space	Plywood, framing installed under membrane Exposed wood decks and exposed duck boards over inverted roof membranes	Lumber, Plywood, Hem-Fir, SPF, D-Fir.-L, northern species Western red cedar, or yellow cedar, or treatable species (drying after treatment is preferable)	Refer to product standards for maximum product moisture content at manufacturing; keep dry on site For treatable species, pressure preservative treatment to meet CSA O80.1-08; use Category 3.2 (Residential Product Group B or C) ACQ-A, ACQ-C, ACQ-D, CA-B, MCA, MCQ.
Above-grade exterior wall and column framing not adjacent to conditioned space	Balcony guards, parapet walls, and support posts	Treatable species (Drying after treatment)	Pressure preservative treatment to meet CSA O80.1-08; use Category 3.2 (Residential Product Group C) ACQ-A, ACQ-C, ACQ-D, CA-B, MCA, MCQ
Cladding, fascia and trim	Exterior exposure	Western red cedar and yellow cedar Treatable species (Drying after treatment)	Back primed, exterior prime and paint or stain, particularly on end-grain. Pressure preservative treatment to meet CSA O80.1-08; use Category 3.1 ACQ-A, ACQ-B, ACQ-D, CA-B, MCA, MCQ
Below grade elements such as fence posts, deck posts, guardrail posts, structural lumber	Exterior exposure high potential for decay	Treatable Species (Drying after treatment)	Pressure preservative treatment to meet CSA O80.1-08; use Category 4.1 ACQ-C and ACQ-D

⁷ <http://cwc.ca/design-with-wood/>

For further information on preservative treatments and wood products see *Design with Wood*⁷ available on the CWC website.

Decking

There are several different materials that are often used for decking.

Common wood decking products include:

- Decay-resistant cedar species
- Pressure-treated lumber
- Composite products that combine wood fiber and plastic

Decking that incorporates a wood preservative or a pure plastic surface can require less maintenance than other wood products. In practice, all decking products require a degree of cleaning and maintenance for optimal deck performance. Note that composite products need to be designed for increased expansion and contraction when compared to natural wood decking. Consider the temperature at the time of installation and space accordingly. All three materials have acceptable performance and should be selected on a project basis according to cost, aesthetic, and durability requirements

Corrosion Resistant Fasteners, Connectors and Flashings

Most wood preservatives contain high amounts of copper that induce corrosion in non-resistant metal deck/balcony components. Electroplated galvanized steel (G-60 or G-90) and aluminum materials are not sufficiently corrosion resistant for contact with treated wood and should be avoided. Hot-dipped galvanized steel (G-185 coating) is an acceptable material for fasteners, flashings and connectors. For best results, stainless steel (Type 304, Type 316) fasteners, flashings and hangers should be used to maximize service life, particularly in applications where wood members have high concentrations of preservatives or in salt spray environments (coastal locations). The use of dissimilar metal types should be avoided at locations where metal elements interface in order to avoid incompatibility problems (galvanic corrosion). In practice, this means that fasteners and connectors used in the same connection should be all stainless steel or all galvanized steel.

Organic polymer/ceramic coatings applied to the surface of metal components may also be suitable to mitigate the corrosive impact of some wood preservatives; however, these coatings can be damaged or removed during installation. Always consult the manufacturer's recommendations prior to using them with treated wood products. See BC Housing's *Builder Insight Bulletin #8: Compatibility of Fasteners and Connectors with Residential Pressure Treated Wood*⁸ and visit *Design with Wood*⁷ (CWC) for further information on compatibility of fasteners and connectors with pressure-treated wood.

When to Use Screws and Nails

While BCBC allows nails for most fastening applications, framing members in exposed locations are best secured with screws and bolts. It is recommended that important structural connections at ledgers and guard posts always be fastened with lag bolts or through bolts to improve deck robustness and safety. Nails are best utilized for securing less critical elements such as decking and railing pickets, where cost and installation time savings can be realized with no impact to deck performance.

⁸<https://www.bchousing.org/research-centre>

Maintenance and Renewals

It is important to acknowledge that wood decks and balconies have limited lifespans, eventually renewals need to occur. The length of time of time between replacing components can be dramatically improved if the appropriate steps are taken to maintain the assembly components. Frequent inspection of guards and waterproof membranes, and undertaking minor repairs when required, can often extend the period of time until full replacement is required. Where decking is installed, individual boards exhibiting excessive checking or decay should be removed and replaced. Regular removal of debris and moss from areas such as drains, scuppers, membranes, and gutters ensures that the intended water management strategy is functioning optimally and that drainage and drying is occurring. Typically, decks and balconies in high exposure locations will require more attention and maintenance than more protected structures.

Wood decks and balconies should be designed and constructed to facilitate the eventual replacement of key components such as the waterproof membrane by eliminating the need for unnecessary dismantling or destruction of other adjacent components. An example of a renewal-oriented design is installing removable wood trim at the base of the wall to allow easy access to the balcony membrane termination. Removable duck boards or pavers should be considered above waterproof membranes as they allow for walking surface replacement and easy cleaning of the surface below.

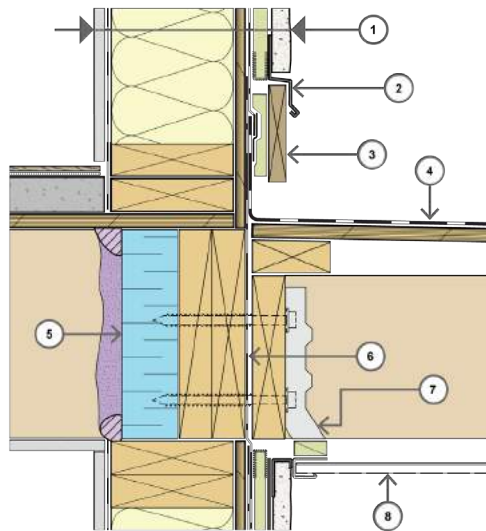

Legend

- | | |
|--|---|
| <p>1. Wall Assembly
Cladding (stucco with backer board)
19mm (0.75") wood furring (p.t.)
Vapour permeable sheathing membrane
Sheathing
Wood framing 38x140mm (2x6)
Batt insulation
Polyethylene
Gypsum board</p> | <p>2. Metal flashing secured to wood furring
3. Wood trim
4. Balcony membrane
5. Extruded polystyrene with spray foam at edges
6. Vapour permeable membrane pre-stip lapped and taped to sheathing membrane below
7. Joist hangers secured to ledger board
8. Perforated soffit panel</p> |
|--|---|

p.t. - pressure treated

Care must be taken when making major changes to the in-service use of the wood deck or balcony; for example, the addition of a heavy planter or hot tub can result in the deck or balcony being overloaded. Any furniture or objects with sharp edges should also be avoided as they may penetrate the deck or balcony waterproof membrane. The design of the wood deck and balcony should facilitate a reasonable maintenance and renewal program while considering occupant uses and requirements.

Designing for renewals

Key Points to Consider

- Follow applicable building codes and standards when designing a wood deck or balcony. Where prescriptive instructions are not provided in BCBC follow best practices for safety and durability.
- Design for drainage and drying to occur in the assembly. This can be accomplished through proper deck grading and leaving appropriate drainage gaps between components.
- Provide ventilation to allow balcony elements to dry, particularly untreated wood framing beneath waterproof membranes.
- Limit moisture exposure by deflecting water away from wood elements. This can be accomplished with proper grading, drip edges, cap flashing, and diverters.
- Pay special attention to detailing at interfaces between the building enclosure and decks and balconies (e.g., ledger attachment, railing penetrations, etc.).
- Be aware of potential moisture sources (e.g., dryer exhaust, gutter downspouts, planters). Design to reduce the risk of moisture damage.
- Ensure that the correct materials are utilized: select decay-resistant wood products and corrosion-impervious fasteners and connectors at all areas with potential for moisture exposure. Ensure compatibility of waterproof membranes with other building enclosure components.
- Design wood decks and balconies with an effective renewal strategy in mind: elements should be easily accessible when they need to be replaced.
- Keep the deck or balcony free of dirt and debris.
- Conduct frequent inspections of guardrails, drains, gutters, membranes, and soffits to confirm the safety of the wood structure. Hire an appropriate professional if any potential problems are apparent.
- Ensure that the in-service use of the deck or balcony does not change substantially from the intended design. If use changes significantly (e.g., introduction of fireplaces, hot tubs, etc.) the original design may not be adequate and upgrades will need to be implemented with the assistance of a professional engineer.

For More Information

Agriculture Handbook No. 432: Construction Guides for Exposed Wood Decks, Forest Service, US Department of Agriculture, 1971.

British Columbia Building Code 2012, Building and Safety Standards Branch, Province of British Columbia.
Available at: www.bccodes.ca *

Builder Insight Bulletin #8: Compatibility of Fasteners and Connectors with Residential Pressure Treated Wood. BC Housing, 2011.
Available at: www.hpo.bc.ca

Building Enclosure Design Guide (Wood Frame Multi-Unit Residential Buildings), BC Housing, 2011.
Available at: www.hpo.bc.ca

Maintenance Matters Bulletin #6: Decks and Balconies. BC Housing, 2007.
Available at: www.hpo.bc.ca

Maintenance Matters Bulletin #9: Exposed Wood Structures. BC Housing, 2011.
Available at: www.hpo.bc.ca

Canadian Wood-Frame House Construction, Canadian Mortgage and Housing Corporation, 2014.
Available at: www.cmhc-schl.gc.ca

Design for Code Compliance #6: Prescriptive Residential Wood Deck Construction Guide, American Wood Council, 2015. Available at: www.awc.org

Design with Wood, Canadian Wood Council, 2016.
Available at: <http://cwc.ca/design-with-wood/>

Engineering Design in Wood, CAN/CSA-O86-14 (2014), Canadian Standards Association.

International Residential Code 2012, International Code Council, 2012.

Manual for the Inspection of Residential Wood Decks and Balconies, North American Deck and Railing Association, 2003.

Prescriptive Residential Exterior Wood Deck Span Guide (Revision 1), Canadian Wood Council, 2016.
Available at: www.cwc.ca/publications/

Roofing Practices Manual, Roofing Contractors Association of British Columbia.
Available at: www.rcabc.org

Standard Specification for Zinc Coating (Hot-Dip) on Iron and Steel Hardware, ASTM A153/A153M-16 (2016), American Society for Testing and Materials.

Supplementary Standard SB-7 – Guards for Houses and Small Buildings, Ontario Ministry of Municipal Affairs and Housing, 2006.

Wood Handbook – Wood as an Engineering Material, Forest Products Laboratory, 1999.
Available at: www.fpl.fs.fed.us

Wood Preservation, CAN/CSA O80 Series-15 (2015), Canadian Standards Association.

* BC Building Code is freely available at all public libraries in British Columbia