

ILLUSTRATED PRICE BOOK

Effective November 1, 2016

- ***Clipper® Industrial Shelving***
- ***Grating & Handrail***
- ***Related Multi-Level Accessories***
- ***Wide Span Shelving***
- ***RivetRite® Shelving***
- ***Pallet Rack***



General Instructions

All prices are based on Penco Standard Construction.

All orders are subject to final acceptance at the main office.

SPECIFICATIONS: (Subject to change without notice) Refer to current Penco Catalogs for description and specifications of Penco Products, Inc.

LEAD TIMES: See the Penco website for lead times (www.pencoproducts.com/lead-times).

SPECIAL ENGINEERING OR ENGINEERING DRAWINGS: Engineering drawings for approval require additional time and above specified deliveries do not apply. Such drawings can be supplied only on an order of \$10,000 total price book value or more. Shipment for this type of order normally requires 6 to 8 weeks after receipt of approved drawings.

FREIGHT CHARGES: All shipments will be made pre-pay and add unless otherwise specified. When freight is prepaid, charges will be added to the invoice. Parcel post charges will be added to invoice. Each order must be for one destination to one consignee.

RETURN SHIPMENTS: No return shipments will be accepted without previous written factory authorization. A restocking charge of 35% or more with a minimum of \$50.00 net will be levied on all authorized material subject to inspection for damage at the factory. Non-standard parts or colors are not returnable. No credit will be issued for damaged material. Material returned without authorization will be refused. All return freight charges must be prepaid.

HOW TO ORDER: Order by indicating quantity, catalog number and color. Do NOT use standard catalog numbers for special or modified parts.

COLORS: In some cases the 'traditional' colors are mentioned, however any of our 24 colors are available on most products. Color names are shown on the next page. The customer must specify color desired on all orders.

WEIGHT: Weights shown are approximate shipping weights for average packing per average order.

CHANGES & CANCELLATIONS: Orders changed after scheduling but before manufacturing are subject to a minimum \$100.00 net charge, if approved by the main office. Changes may have an adverse effect on scheduled ship date. Orders are not subject to changes or cancellations after commencement of manufacturing. Orders requiring engineering drawings are subject to an engineering fee if cancelled.

CLAIMS AND FREIGHT DAMAGE: If freight arrangements are 3rd party or collect, claims for damage or short must be filed by the Penco distributor/customer with the delivering carrier. For pre-pay and add shipments, all claims for shortages and damages must be made in writing to the main office within 72 hours from receipt of shipment.

Caution: When the delivering carrier is given a clear receipt for a shipment in which there is damaged merchandise or a shortage, the carrier is relieved of further responsibility. Penco will not accept return of merchandise damaged in transit. The claim is with the delivering carrier.

Caution: When you give the delivering carrier a clear receipt for a shipment in which there is damaged merchandise or a shortage, the carrier is relieved of further responsibility. Claims for damage or shortage must be filed by you with the delivering carrier. Penco will not accept return of merchandise damaged in transit. Your claim is with the delivering carrier.

CHOICE OF CARRIER: On pre-pay and add shipments, Penco retains the right to select the most appropriate carrier for delivery to your order's destination.

GUARANTEE: We guarantee our products for a one year limited warranty to be free from mechanical and manufacturing defects. Penco is not responsible for products damaged by misuse, abuse or any acts of vandalism. The guarantee is also voided if the finish is exposed to items such as high humidity, chlorine salts, abrasive cleaners, germicidal cleaners or acids.

SMALL ORDER POLICY: MINIMUM ORDER - \$50.00 Net plus shipping costs.

PACKAGING AND MARKING: For special crating, marking, palletizing, or export packing, contact your Penco Representative for availability and cost.

INSTALLATION: For installation at job site contact the local Penco Representative for assistance in locating installation personnel. Unless otherwise specified, all products are shipped knocked down (unassembled) from the factory.

QUICKSHIP PROGRAM: Certain products, shown in a separate price list, are available from multiple warehouse locations on a QuickShip basis, many available for shipment in 5 days or less. Popular sizes of the following products are in the QuickShip program: Clipper & RivetRite Shelving, Lockers and locker accessories. For locations of QuickShip warehouses and which products are stocked there, please refer to our website at: www.pencoproducts.com/quickship.

PENCO ASSUMES NO RESPONSIBILITY FOR PRODUCT FAILURE OR PERSONAL INJURY IF PRODUCTS ARE MODIFIED OR USED FOR OTHER THAN THEIR DESIGNED PURPOSE.

Prices are F. O. B. plant of manufacture, knocked down and subject to change without notice. Penco Products reserves the right to determine plant of manufacture. Prices are in U.S. Dollars at time of shipment.

Penco Products, Inc. pursues a continuing program of design and products improvement. When such improvements occur, or when conditions exist beyond our control, Penco reserves the right to furnish equipment considered standard at the time of shipment.

Price Book Info / Freight Classes / Contents

Price Book Information

How to Read This Price List: Pricing Information is printed in two columns on most pages, flowing from the bottom of one column to the top of the next column. Do not read across columns; read it as you would read a newspaper.

Dimensions: Unless stated otherwise, all sizes are in inches. All dimensions are nominal - refer to our product catalog for additional growth details.

Footnotes: The "NOTES" column is marked with a "*" at the top of the page. Refer to the bottom of each page for the key to the symbols found in the column.

Abbreviations: In the "Per" column, the following apply: "Ea." = Each; "Pr." = Pair; "Frm." = Frame; "Bdl." = Bundle;. In the "Std. Pkg" column (Standard Packaging), "LPP" = Like Parts Packed Together; "PPO" = Packed Per Order.

Other Sizes: In most product lines, other sizes are available. Contact your Penco representative with your requirements.

Freight Classes

Freight Class

F.O.B. Hamilton, NC 27840

50	RivetRite Shelving, Pallet Rack Beams, Channel Lock Safety Grating, Handrail
60	Particle Board
70	Pallet Rack Frames
	<u>Shelving:</u>
	Clipper, , Wide Span, Erectomatic & Modular Drawers for Shelving
	<u>K.D. Lockers:</u>
	All KD Lockers
	Locker Room Benches, Basket Racks, Hardware.
85	Bench Pedestals
125-150	Assembled Lockers (assembled from KD parts) and All-Welded Lockers

The factory shipping point is shown above for your convenience, however, Penco and its vendors reserve the right to change shipping points at any time without notice. QuickShip products (found in a different price list) shipping points can differ. See www.pencoproducts.com/quickship for more information on QuickShip products.

Color Selection

24 Standard Colors are available on most products. Color Chart is available.

012 Tawny Tan	073 Champagne	767 Cardinal Red
021 Gray Ash	701 Spray Green	806 Marine Blue
028 Gray	710 Sagebrush Yellow	812 Hunter Green
052 Reflex Blue	715 Lake Blue	822 Regal Blue
054 Canvas	720 Mandarin Orange	826 Slate Blue
055 Shamrock	722 Patriot Red	848 January White
056 Sunburst	723 Light Putty	949 Jet Black
058 Nordic Purple	736 Burgundy	952 Turquoise Teal

Contents

Clipper Shelving Open/Closed Units.....	4
Clipper Bin Units.....	5
Clipper Specialty Shelving and Components.....	6
Clipper Shelving Components.....	7-8
Clipper Hi-Performance Shelves.....	9
Clipper Shelving Accessories.....	10-11
Channel Locker Safety Grating.....	12
Handrail & Shelving Hardware.....	13
Wide Span Shelving Units and Tire Racks Units.....	14
Wide Span Components.....	15
Wide Span Beams, Supports and Braces.....	16
Wide Span Shelves and Side Shelf Supports.....	17
RivetRite Shelf Framing.....	18
RivetRite Double Rivet Shelving Units.....	19-20
RivetRite Single Rivet Shelving Units.....	21
RivetRite Record Storage Units.....	22
RivetRite Automotive Shelving Units.....	23
RivetRite Components Parts.....	24-28
RivetRite Particle Board.....	29
Pallet Rack Introduction.....	30
Pallet Rack Frames.....	31-35
Pallet Rack Beams.....	36-37
Pallet Rack Accessories.....	38-39
Inventory Carts & Misc. Parts.....	40
Touch-up Paint.....	41



Clipper Shelving Units

W D H * Cat. No. Price Per Wt. Pkg.

W D H * Cat. No. Price Per Wt. Pkg.

Open Basic Clipper Units consist of:
1 Front Box Post, 2 rear Offset Angle Posts,
Side & Back Sway Braces, Heavy Duty Hi-Performance Shelves.
Order Open Clipper End Kits in the appropriate depth separately.

Closed Basic Clipper Units consist of:
1 Front Box Post, 2 rear Offset Angle Posts,
Side and Back Panels, Heavy Duty Hi-Performance Shelves.
Order Closed Clipper End Kit in the appropriate depth separately.

Open Clipper Basic Units

Closed Clipper Basic Units



5 Shelves

Heavy Duty Hi-Performance

36	12	87	1H7015	217.20	Ea.	59.6	LPP
36	18	87	1H7025	250.70	Ea.	70.5	LPP
36	24	87	1H7035	282.85	Ea.	81.7	LPP
42	12	87	1H7045	236.75	Ea.	65.1	LPP
42	18	87	1H7055	270.50	Ea.	78.0	LPP
42	24	87	1H7065	309.65	Ea.	90.2	LPP
48	12	87	1H7075	260.25	Ea.	70.6	LPP
48	18	87	1H7085	327.50	Ea.	85.0	LPP
48	24	87	1H7095	379.40	Ea.	99.3	LPP



5 Shelves

Heavy Duty Hi-Performance

36	12	87	1H8015	306.20	Ea.	82.5	LPP
36	18	87	1H8025	350.20	Ea.	96.3	LPP
36	24	87	1H8035	392.25	Ea.	110.5	LPP
42	12	87	1H8045	347.35	Ea.	91.7	LPP
42	18	87	1H8055	391.60	Ea.	107.5	LPP
42	24	87	1H8065	440.65	Ea.	122.9	LPP
48	12	87	1H8075	389.70	Ea.	100.4	LPP
48	18	87	1H8085	467.45	Ea.	117.8	LPP
48	24	87	1H8095	529.25	Ea.	135.2	LPP

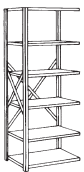

6 Shelves

36	12	87	1H7016	243.60	Ea.	66.6	LPP
36	18	87	1H7026	283.60	Ea.	79.5	LPP
36	24	87	1H7036	321.85	Ea.	92.9	LPP
42	12	87	1H7046	266.65	Ea.	73.2	LPP
42	18	87	1H7056	306.95	Ea.	88.5	LPP
42	24	87	1H7066	353.60	Ea.	103.1	LPP
48	12	87	1H7076	294.85	Ea.	79.6	LPP
48	18	87	1H7086	375.35	Ea.	96.8	LPP
48	24	87	1H7096	437.30	Ea.	113.9	LPP



6 Shelves

36	12	87	1H8016	332.60	Ea.	89.5	LPP
36	18	87	1H8026	383.10	Ea.	105.4	LPP
36	24	87	1H8036	431.25	Ea.	121.7	LPP
42	12	87	1H8046	377.25	Ea.	99.7	LPP
42	18	87	1H8056	428.05	Ea.	118.0	LPP
42	24	87	1H8066	484.60	Ea.	135.8	LPP
48	12	87	1H8076	424.30	Ea.	109.5	LPP
48	18	87	1H8086	515.30	Ea.	129.7	LPP
48	24	87	1H8096	587.15	Ea.	149.9	LPP



7 Shelves

36	12	87	1H7017	270.00	Ea.	73.6	LPP
36	18	87	1H7027	316.50	Ea.	88.6	LPP
36	24	87	1H7037	360.85	Ea.	104.1	LPP
42	12	87	1H7047	296.55	Ea.	81.2	LPP
42	18	87	1H7057	343.40	Ea.	99.0	LPP
42	24	87	1H7067	397.55	Ea.	116.0	LPP
48	12	87	1H7077	329.45	Ea.	88.7	LPP
48	18	87	1H7087	423.20	Ea.	108.7	LPP
48	24	87	1H7097	495.20	Ea.	128.5	LPP

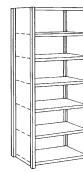

7 Shelves

36	12	87	1H8017	359.00	Ea.	96.5	LPP
36	18	87	1H8027	416.00	Ea.	114.4	LPP
36	24	87	1H8037	470.25	Ea.	133.0	LPP
42	12	87	1H8047	407.15	Ea.	107.7	LPP
42	18	87	1H8057	464.50	Ea.	128.5	LPP
42	24	87	1H8067	528.55	Ea.	148.6	LPP
48	12	87	1H8077	458.90	Ea.	118.6	LPP
48	18	87	1H8087	563.15	Ea.	141.5	LPP
48	24	87	1H8097	645.05	Ea.	164.5	LPP

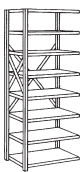

8 Shelves

36	12	87	1H7018	296.40	Ea.	80.6	LPP
36	18	87	1H7028	349.40	Ea.	97.6	LPP
36	24	87	1H7038	399.85	Ea.	115.4	LPP
42	12	87	1H7048	326.45	Ea.	89.2	LPP
42	18	87	1H7058	379.85	Ea.	109.5	LPP
42	24	87	1H7068	441.50	Ea.	128.9	LPP
48	12	87	1H7078	364.05	Ea.	97.7	LPP
48	18	87	1H7088	471.05	Ea.	120.5	LPP
48	24	87	1H7098	553.10	Ea.	143.2	LPP

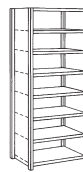

8 Shelves

36	12	87	1H8018	385.40	Ea.	103.5	LPP
36	18	87	1H8028	448.90	Ea.	123.5	LPP
36	24	87	1H8038	509.25	Ea.	144.2	LPP
42	12	87	1H8048	437.05	Ea.	115.8	LPP
42	18	87	1H8058	500.95	Ea.	139.1	LPP
42	24	87	1H8068	572.50	Ea.	161.5	LPP
48	12	87	1H8078	493.50	Ea.	127.6	LPP
48	18	87	1H8088	611.00	Ea.	153.4	LPP
48	24	87	1H8098	702.95	Ea.	179.1	LPP

Open Clipper End Kits

Closed Clipper End Kits



To End Row of Open Shelving

Consists of front Box Post and 1 pair of Side Sway Braces.

12	87	101287	38.85	Ea.	10.0	LPP
18	87	101887	39.85	Ea.	11.0	LPP
24	87	102487	41.50	Ea.	12.0	LPP



To End Row of Closed Shelving

Consists of front Box Post and Side Panel.

12	87	1C1287	55.80	Ea.	14.0	LPP
18	87	1C1887	67.30	Ea.	18.0	LPP
24	87	1C2487	78.85	Ea.	22.0	LPP

Front Bases for Closed Clipper Shelving units shown above must be ordered separately.

Clipper Bin Units (with Front Bases)



W	D	H	*	Cat. No.	Price	Per	Wt.	Pkg.
---	---	---	---	----------	-------	-----	-----	------

W	D	H	*	Cat. No.	Price	Per	Wt.	Pkg.
---	---	---	---	----------	-------	-----	-----	------

Closed Basic Clipper Bin Units consist of:
 1 Front Box Post, 2 rear Offset Angle Posts,
 Side and Back Panels, H.D. Hi-Performance Shelves, Dividers & Bin
 Fronts as required. **Order Closed Clipper End Kit in the
 appropriate depth separately. (Label Holders not included)**

Note: Bin widths are nominal. They are measured from the hole centers on the shelves, not the vertical bead of the dividers.

Clipper Bin Basic Units

9 Openings

Heavy Duty Hi-Performance
 8 - 36" x 9", 1 - 36" x 12"

36	12	87	1H6109	446.70	Ea.	118.8	LPP
36	18	87	1H6209	523.20	Ea.	142.9	LPP
36	24	87	1H6309	595.75	Ea.	167.9	LPP

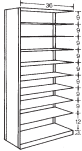

9 Openings

8 - 48" x 9", 1 - 48" x 12"

48	12	87	1H6409	573.05	Ea.	147.4	LPP
48	18	87	1H6509	717.05	Ea.	178.7	LPP
48	24	87	1H6609	829.10	Ea.	210.0	LPP



21 Openings

21 - 12" x 12"

36	12	87	1H6121	594.25	Ea.	118.9	LPP
36	18	87	1H6221	666.15	Ea.	147.8	LPP
36	24	87	1H6321	762.90	Ea.	176.2	LPP

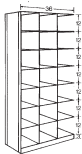

28 Openings

28 - 12" x 12"

48	12	87	1H6428	802.40	Ea.	150.5	LPP
48	18	87	1H6528	932.50	Ea.	189.6	LPP
48	24	87	1H6628	1079.05	Ea.	226.8	LPP



35 Openings

32 - 9" x 9", 3 - 12" x 12"

36	12	87	1H6135	777.25	Ea.	139.6	LPP
36	18	87	1H6235	875.35	Ea.	176.7	LPP
36	24	87	1H6335	1032.30	Ea.	213.1	LPP

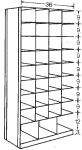

52 Openings

48 - 8" x 9", 4 - 12" x 12"

48	12	87	1H6452	1116.90	Ea.	181.8	LPP
48	18	87	1H6552	1508.70	Ea.	206.0	LPP
48	24	87	1H6652	1336.55	Ea.	284.6	LPP

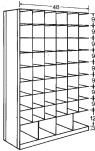

43 Openings

24 - 6" x 6", 9 - 12" x 9", 4 - 9" x 9", 6 - 12" x 12"

36	12	87	1H6143	890.70	Ea.	147.9	LPP
36	18	87	1H6243	1000.75	Ea.	188.3	LPP
36	24	87	1H6343	1135.35	Ea.	227.5	LPP

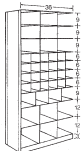

Bin sizes shown (w x h) are nominal unless stated otherwise. Subtract 1-3/16" from bin height for actual clear opening height.

Refer to the previous page for Closed Clipper End Kits.

58 Openings

32 - 6" x 6", 12 - 12" x 9", 4 - 7-1/2" x 9", 2 - 9" x 9", 8 - 12" x 12"

48	12	87	1H6458	1231.55	Ea.	189.1	LPP
48	18	87	1H6558	1428.10	Ea.	244.0	LPP
48	24	87	1H6658	1638.60	Ea.	295.6	LPP

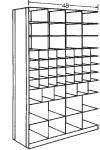

13 Openings

12 - 36" x 6", 1 - 36" x 12"

36	12	87	1H6113	552.30	Ea.	146.8	LPP
36	18	87	1H6213	654.80	Ea.	179.1	LPP
36	24	87	1H6313	751.75	Ea.	212.8	LPP

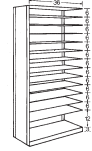

13 Openings

12 - 48" x 6", 1 - 48" x 12"

48	12	87	1H6413	711.45	Ea.	183.6	LPP
48	18	87	1H6513	908.45	Ea.	226.1	LPP
48	24	87	1H6613	1060.70	Ea.	268.5	LPP



37 Openings

24 - 9" x 6", 4 - 9" x 12", 9 - 12" x 12"

36	12	87	1H6137	853.05	Ea.	144.8	LPP
36	18	87	1H6237	946.10	Ea.	183.2	LPP
36	24	87	1H6337	1076.20	Ea.	220.8	LPP

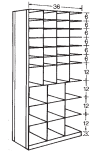

54 Openings

24 - 7-1/2" x 6", 12 - 9" x 6", 4 - 7-1/2" x 12", 2 - 9" x 12", 12 - 12" x 12"

48	12	87	1H6454	1227.15	Ea.	187.3	LPP
48	18	87	1H6554	1398.80	Ea.	241.1	LPP
48	24	87	1H6654	1599.30	Ea.	291.8	LPP

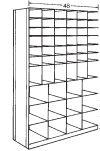

21 Openings

21 - 12" x 12", 7 - 3" Bin Fronts

36	12	87	1H6621	746.15	Ea.	133.9	LPP
36	18	87	1H6521	818.05	Ea.	162.8	LPP
36	24	87	1H6421	914.80	Ea.	191.3	LPP



28 Openings

28 - 12" x 12", 7 - 3" Bin Fronts

48	12	87	1H6328	1014.50	Ea.	170.3	LPP
48	18	87	1H6228	1144.60	Ea.	209.4	LPP
48	24	87	1H6128	1291.15	Ea.	246.6	LPP



29 Openings

16 - 9" x 9", 4 - 9" x 12", 9 - 12" x 12", 8 - 3" Bin Fronts

36	12	87	1H6129	862.85	Ea.	147.4	LPP
36	18	87	1H6229	958.60	Ea.	181.2	LPP
36	24	87	1H6329	1090.80	Ea.	214.0	LPP

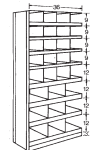

42 Openings

16 - 7-1/2" x 9", 8 - 9" x 9", 4 - 7-1/2" x 12", 2 - 9" x 12", 12 - 12" x 12", 8 - 3" Bin Fronts

48	12	87	1H6442	1230.35	Ea.	190.8	LPP
48	18	87	1H6542	1386.50	Ea.	238.0	LPP
48	24	87	1H6642	1590.90	Ea.	282.6	LPP





Clipper Specialty Shelving and Components

W	D	H	*	Cat. No.	Price	Per	Wt.	Pkg.
---	---	---	---	----------	-------	-----	-----	------

W	D	H	*	Cat. No.	Price	Per	Wt.	Pkg.
---	---	---	---	----------	-------	-----	-----	------

Art Work Storage Shelving



Art Work Basic Unit

18 Openings - 18 - 6" x 26-3/4" Clear. Order 24" x 87"
Closed Clipper End Kit separately.

36	24	87		1H6700	815.50	Ea.	216.5	LPP
----	----	----	--	---------------	---------------	-----	-------	-----

Divider For Art Filing

24	28			15996H	30.25	Ea.	7.0	LPP
----	----	--	--	---------------	--------------	-----	-----	-----

X-Ray Storage Shelving



X-Ray Basic Unit

Heavy Duty Hi-Performance
30 Openings - 18 - 6" x 14-3/4", 12 - 6" x 16-3/4" Clear.
For X-Ray jackets up to 14-1/2". Order 18" x 87" Closed
Clipper End Kit separately.

36	18	87		1H6705	1238.85	Ea.	166.2	LPP
----	----	----	--	---------------	----------------	-----	-------	-----

Plan Storage Shelving



Plan Shelving Basic Unit

73 Openings - 64 - 6" x 6", 9 - 48" x 4". Order 36" x 87"
Closed Clipper End Kit separately.

48	36	87		1H6659	3372.55	Ea.	561.6	LPP
----	----	----	--	---------------	----------------	-----	-------	-----

Plan Shelving Dividers

36	6			16100H	12.65	Ea.	1.8	LPP
----	---	--	--	---------------	--------------	-----	-----	-----

Open Shelf File Shelving



Open Shelf Filing Basic Unit

Uses Standard Flange Clipper Shelves
Order Closed Clipper End Kit separately to finish basic
unit or end a row.

36	12	87		176709	826.85	Ea.	139.5	LPP
----	----	----	--	---------------	---------------	-----	-------	-----

Divider for Open Shelf Filing

Cannot be used with Hi-Performance Shelves.

12	7			164210C	11.60	Ea.	1.1	LPP
----	---	--	--	----------------	--------------	-----	-----	-----

Divider Support

For Open Shelf Filing Units.

36	4			16421H	15.95	Ea.	2.1	LPP
----	---	--	--	---------------	--------------	-----	-----	-----

Closed Clipper End Kits

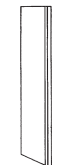

To End Row of Closed Shelving

12	87			1C1287	55.80	Ea.	14.1	LPP
18	87			1C1887	67.30	Ea.	17.5	LPP
24	87			1C2487	78.85	Ea.	21.0	LPP
36	87			1C3687	106.10	Ea.	27.8	LPP

Open Ledge Shelving



Open Ledge Basic Unit

Heavy Duty Hi-Performance
Order Ledge Open End Kit separately to finish basic unit
or to end a row.

36	24	87		1H432L	418.40	Ea.	118.7	LPP
----	----	----	--	---------------	---------------	-----	-------	-----

Ledge Open End Kit

12/24	87			19433E	71.25	Ea.	15.5	LPP
-------	----	--	--	---------------	--------------	-----	------	-----

Closed Ledge Shelving



Closed Ledge Basic Unit

Heavy Duty Hi-Performance
Order Ledge Closed End Kit separately to finish basic
unit or to end a row.

36	24	87		1H434L	522.65	Ea.	143.4	LPP
----	----	----	--	---------------	---------------	-----	-------	-----

Ledge Closed End Kit

12/24	87			19435E	94.95	Ea.	20.9	LPP
-------	----	--	--	---------------	--------------	-----	------	-----

Ledge Shelving Components

Ledge Top

36	24			10538H	174.00	Ea.	27.0	LPP
----	----	--	--	---------------	---------------	-----	------	-----

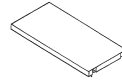

Ledge Top End, LH

24				13545H	40.35	Ea.	1.6	LPP
----	--	--	--	---------------	--------------	-----	-----	-----

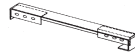

Ledge Top End, RH

24				13546H	40.35	Ea.	1.6	LPP
----	--	--	--	---------------	--------------	-----	-----	-----

Counter Shelving

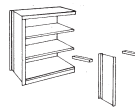

Counter Basic Unit

Heavy Duty Hi-Performance
Order Counter End Kit separately to finish a basic unit or
to end a row. 36" wide packed 1 per 2 cartons. Unit has
Box Posts at front and rear.

36	24	39		1H122C	338.45	Ea.	96.8	
----	----	----	--	---------------	---------------	-----	------	--

42	24	39		1H123C	372.80	Ea.	109.1	LPP
----	----	----	--	---------------	---------------	-----	-------	-----

48	24	39		1H124C	432.65	Ea.	121.0	LPP
----	----	----	--	---------------	---------------	-----	-------	-----

End Kit, Counter

24	39			19125E	76.25	Ea.	18.0	
----	----	--	--	---------------	--------------	-----	------	--

Counter Shelving Components

Counter Tops

36	24			13670H	82.20	Ea.	27.0	LPP
----	----	--	--	---------------	--------------	-----	------	-----

42	24			13680H	91.80	Ea.	31.0	LPP
----	----	--	--	---------------	--------------	-----	------	-----

48	24			13690H	102.60	Ea.	35.0	LPP
----	----	--	--	---------------	---------------	-----	------	-----

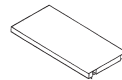

Bin sizes shown (w x h) are nominal unless stated otherwise.
Subtract 1-3/16" from bin height for actual clear opening height.

Clipper Shelving Components



W	D	H *	Cat. No.	Price	Per	Wt.	Pkg.
---	---	-----	----------	-------	-----	-----	------

Counter Fronts



36	39		13870H	77.00	Ea.	19.0	LPP
42	39		13880H	85.45	Ea.	22.0	LPP
48	39		13890H	94.10	Ea.	25.0	LPP

Counter Top Finishing Strip



24			13760H	11.25	Ea.	1.8	LPP
----	--	--	---------------	--------------	-----	-----	-----

Divider Support Angle (Pairs)

Used to support the top of dividers under ledge or counter top. Reduces the required height of the divider by 1".

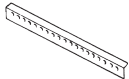

36			17120H	22.00	Pr.	2.3	LPP
----	--	--	---------------	--------------	-----	-----	-----

Box Posts



14 Gauge

39			1B4039C	14.65	Ea.	4.5	10
48			1B4048C	17.75	Ea.	5.0	10
75			1B4075C	27.15	Ea.	7.8	10
87			1B4087C	31.65	Ea.	9.1	10
99			1B4099C	37.80	Ea.	10.3	10
123			1B4123C	46.55	Ea.	12.8	10
147			1B4147C	56.20	Ea.	15.3	10

16 Gauge

Not recommended for Multi-Level Shelving use.

87			1B6087C	27.20	Ea.	6.9	10
----	--	--	----------------	--------------	-----	-----	----

Offset Angle Posts



14 Gauge

39			1A4039C	8.35	Ea.	2.8	12
48			1A4048C	9.90	Ea.	3.4	12
75			1A4075C	14.70	Ea.	5.2	12
87			1A4087C	16.85	Ea.	6.1	12
99			1A4099C	21.25	Ea.	6.9	12
123			1A4123C	26.20	Ea.	8.6	12
147			1A4147C	31.65	Ea.	10.2	12

16 Gauge

Not for Multi-Level Shelving use.

87			1A6087C	15.05	Ea.	4.6	12
----	--	--	----------------	--------------	-----	-----	----

Post Splice



With Hardware

6			10030H	11.80	Ea.	0.3	PPO
---	--	--	---------------	--------------	-----	-----	-----

Foot Plate-Floor Protector

Plated

NOT for Multi-Level or High Rise Structures.

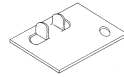

1-3/4	2-5/8		10007Z	1.85	Ea.	0.2	PPO
-------	-------	--	---------------	-------------	-----	-----	-----

Floor Anchor Clip

Anchor holes are 7/16" diameter.

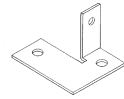

3-1/2	2-7/8		10006Z	3.00	Ea.	0.4	PPO
-------	-------	--	---------------	-------------	-----	-----	-----

Concrete Floor Anchor

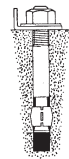

3/8" x 2-1/4"

3/8	2-1/4		9280	1.75	Ea.	0.1	PPO
-----	-------	--	-------------	-------------	-----	-----	-----

3/8" x 3-3/4"

Use the longer anchor # 9281 in seismic zones higher than 2A.

3/8	3-3/4		9281	2.40	Ea.	0.2	PPO
-----	-------	--	-------------	-------------	-----	-----	-----

Shim

11 Gauge

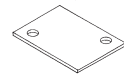

3-1/2	2-7/8		10011	5.00	Ea.	0.4	PPO
-------	-------	--	--------------	-------------	-----	-----	-----

Foot Plate, Clipper, Heavy Duty (7 Ga.)

For Box, Single & Double Angle Posts.

Specify color. Hardware included to fasten to post.



5-1/2	2-3/8		1ACX322H	20.85	Ea.	0.8	PPO
-------	-------	--	-----------------	--------------	-----	-----	-----

Shim for Heavy Duty Foot Plate

(7 Ga.) Specify color.

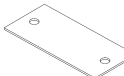

5-1/2	2-3/8		1ACX330	4.35	Ea.	0.4	PPO
-------	-------	--	----------------	-------------	-----	-----	-----

For Multi-level shelving components and other accessories, see page 11-13

W	D	H	*	Cat. No.	Price	Per	Wt.	Pkg.
---	---	---	---	----------	-------	-----	-----	------

W	D	H	*	Cat. No.	Price	Per	Wt.	Pkg.
---	---	---	---	----------	-------	-----	-----	------

Back Sway Braces (Pair)

For Open Shelving

One pair forms a set which bolts to the short leg of the rear Offset Angle Posts for lateral stability. Can be used in common between back-to-back units. Dimension shown is shelf width.



24		12045A	11.70	Pr.	2.3	20
30		12050A	12.65	Pr.	2.5	20
36		12036H	12.65	Pr.	3.2	20
42		12042H	14.70	Pr.	3.8	20
48		12048H	14.70	Pr.	3.8	20

Side Sway Braces (Pair)

One pair forms a set which bolts to the front and rear posts for stability. Can be used in common between adjoining units. Dimension shown is shelf depth.



9		12011S	7.20	Pr.	0.8	20
12		12015S	7.20	Pr.	1.0	20
15		12019S	8.20	Pr.	1.1	20
18		12026S	8.20	Pr.	1.4	20
24		12034S	9.85	Pr.	1.8	20
30		12045S	12.05	Pr.	2.3	20
32		12046S	12.80	Pr.	2.4	20
36		12049S	12.05	Pr.	2.5	20

Back Panels

For Closed Shelving

Punched on 1" centers at vertical edges and center for attaching to posts & shelves. 36" w backs are furnished in 1 pc. thru 87" h.; over 87", split horizontally. 42" & 48" in 1 pc. thru 51"; 2 pcs. above 51" h. Includes back clip and hardware.

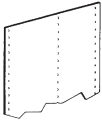

24	87	12340H	61.55	Ea.	14.9	8
30	87	12440H	70.65	Ea.	18.3	6
36	39	12500H	41.30	Ea.	9.4	10
36	51	12510H	52.30	Ea.	12.3	8
36	75	12530H	69.65	Ea.	17.9	6
36	87	12540H	84.70	Ea.	20.9	5
36	99	12550H	104.35	Ea.	23.5	4
42	39	12600H	62.90	Ea.	10.7	5
42	51	12610H	65.00	Ea.	13.9	5
42	75	12630H	110.85	Ea.	21.4	5
42	87	12640H	108.35	Ea.	24.4	5
42	99	12650H	125.95	Ea.	27.8	5
48	39	12700H	55.20	Ea.	12.3	5
48	51	12710H	72.00	Ea.	15.9	5
48	75	12730H	110.25	Ea.	27.9	5
48	87	12740H	127.20	Ea.	28.2	5
48	99	12750H	143.80	Ea.	31.8	5

Side Panels

Side Panels over 87" high are supplied in 2 pieces split horizontally.

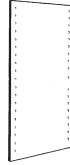

9	87	11340H	19.70	Ea.	3.2	20
12	39	11400H	20.35	Ea.	2.3	25
12	48	11409H	24.15	Ea.	2.8	25
12	51	11410H	16.45	Ea.	3.0	25
12	75	11430H	21.75	Ea.	4.3	20
12	87	11440H	24.15	Ea.	5.0	16
12	99	11450H	33.10	Ea.	5.8	12
15	87	11540H	29.35	Ea.	6.7	14
18	39	11600H	31.65	Ea.	3.9	20
18	48	11609H	36.95	Ea.	4.7	20
18	51	11610H	24.45	Ea.	5.0	20
18	75	11630H	31.95	Ea.	7.3	12
18	87	11640H	35.65	Ea.	8.4	10
18	99	11650H	48.95	Ea.	9.9	10
24	39	11700H	24.45	Ea.	5.4	20
24	51	11710H	31.25	Ea.	7.0	18
24	75	11730H	40.70	Ea.	10.3	8
24	87	11740H	47.20	Ea.	11.9	8
24	99	11750H	62.65	Ea.	13.9	6
30	39	11800H	34.80	Ea.	6.9	14
30	87	11840H	64.35	Ea.	15.2	6
30	99	11850H	92.65	Ea.	17.9	5
36	39	11900H	40.40	Ea.	8.5	10
36	75	11930H	65.60	Ea.	16.2	6
36	87	11940H	74.45	Ea.	18.7	5
36	99	11950H	108.45	Ea.	21.9	5

Closed Upright Assemblies

Side panels and posts factory welded into a single unit. Other heights & depths are available up to 123" high.

Box Post End

12	87	15412CC	86.65	Ea.	22.0	4
18	87	15418CC	97.05	Ea.	25.4	4
24	87	15424CC	111.50	Ea.	28.9	4

Box Post Intermediate

12	87	15412BC	105.25	Ea.	28.7	4
18	87	15418BC	115.50	Ea.	32.2	4
24	87	15424BC	128.65	Ea.	35.6	4

Offset Angle End

12	87	15412AC	64.75	Ea.	18.5	4
18	87	15418AC	74.40	Ea.	22.0	4
24	87	15424AC	89.85	Ea.	25.4	4

Hi-Performance Shelves and Capacities



W	D	H	*	Cat. No.	Price	Per	Wt.	Pkg.
---	---	---	---	----------	-------	-----	-----	------

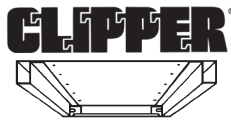

Hi-Performance Shelves
Integral box-beam construction on the front and rear flanges. Capacity is varied on Class 0, 1 & 2 by using thicker steel.

Clipper Shelves, with 4 Clips

SEE SHELF CAPACITIES: Select the proper shelf type for the expected maximum load.

Hi-Performance Medium Duty, Class 0

NOTE: Minimum order of 100 Medium Duty Shelves per order.



36	12	1H223612C	24.25	Ea.	6.1	10
36	15	1H223615C	28.20	Ea.	7.0	10
36	18	1H223618C	29.20	Ea.	7.9	10
36	24	1H223624C	35.25	Ea.	9.8	10
48	12	1H224812C	32.30	Ea.	7.4	10
48	18	1H224818C	44.95	Ea.	9.7	6
48	24	1H224824C	54.25	Ea.	12.1	6

Hi-Performance Heavy Duty, Class 1



36	12	1H203612C	26.40	Ea.	7.3	10
36	15	1H203615C	31.30	Ea.	8.4	10
36	18	1H203618C	32.90	Ea.	9.5	10
36	24	1H203624C	39.00	Ea.	11.6	10
36	30	1H203630C	46.50	Ea.	13.8	6
36	36	1H203636C	52.70	Ea.	16.0	6
42	12	1H204212C	29.90	Ea.	8.3	10
42	15	1H204215C	33.05	Ea.	9.2	6
42	18	1H204218C	36.45	Ea.	10.8	10
42	24	1H204224C	43.95	Ea.	13.3	6
42	30	1H204230C	54.05	Ea.	15.8	6
42	32	1H204232C	57.90	Ea.	15.9	6
42	36	1H204236C	58.30	Ea.	18.3	6
48	12	1H204812C	34.60	Ea.	9.4	10
48	15	1H204815C	41.15	Ea.	10.3	6
48	18	1H204818C	47.85	Ea.	12.2	6
48	24	1H204824C	57.90	Ea.	15.0	6
48	30	1H204830C	62.25	Ea.	17.9	6
48	36	1H204836C	66.10	Ea.	21.7	6

W	D	H	*	Cat. No.	Price	Per	Wt.	Pkg.
---	---	---	---	----------	-------	-----	-----	------

Hi-Performance Extra Heavy Duty, Class 2

Can be converted to Class 3 Shelf by adding center support and side shelf supports.

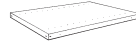



36	12	1H183612C	35.30	Ea.	9.9	10
36	15	1H183615C	40.95	Ea.	11.5	10
36	18	1H183618C	43.00	Ea.	13.0	10
36	24	1H183624C	51.65	Ea.	16.0	10
36	30	1H183630C	62.75	Ea.	19.0	6
36	36	1H183636C	74.50	Ea.	22.0	6
42	12	1H184212C	40.65	Ea.	11.4	10
42	15	1H184215C	47.65	Ea.	12.9	6
42	18	1H184218C	51.85	Ea.	14.9	10
42	24	1H184224C	61.65	Ea.	18.4	6
42	30	1H184230C	74.50	Ea.	21.9	6
42	32	1H184232C	78.75	Ea.	22.5	6
42	36	1H184236C	85.00	Ea.	24.8	6
48	12	1H184812C	45.60	Ea.	12.9	10
48	15	1H184815C	53.10	Ea.	14.6	6
48	18	1H184818C	58.40	Ea.	16.8	6
48	24	1H184824C	71.00	Ea.	20.8	6
48	30	1H184830C	83.50	Ea.	24.7	6
48	36	1H184836C	95.60	Ea.	28.7	6

MEDIUM Duty Class "0" Hi-Performance shelves are available on production runs, the minimum order quantity being 100 shelves for each catalog size.

Wire Shelves are available as an alternative to Clipper Shelving. Contact your Penco representative for pricing. Clipper Clips must be purchased separately.

Clipper Hi-Performance® Shelf Capacities

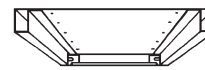
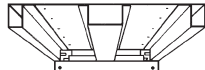
		 Class 0 Medium Duty High Strength Steel		 Class 1 Heavy Duty High Strength Steel		 Class 2 Extra Heavy Duty High Strength Steel		 Class 3 Extra Heavy Duty With Reinforcing*		
Width	Depth	Cat. No.	Capacity	Cat. No.	Capacity	Cat. No.	Capacity	Capacity		
36"	12"	1H223612C	500 lb	1H203612C	800 lb	1H183612C	1100 lb	-		
	15"	1H223615C	500 lb	1H203615C	800 lb	1H183615C	1100 lb	-		
	18"	1H223618C	500 lb	1H203618C	850 lb	1H183618C	1200 lb	2000 lb		
	24"	1H223624C	500 lb	1H203624C	800 lb	1H183624C	1250 lb	2000 lb		
	30"	-	-	-	1H203630C	500 lb	1H183630C	900 lb	2000 lb	
	36"	-	-	-	1H203636C	500 lb	1H183636C	900 lb	2000 lb	
42"	12"	-	-	1H204212C	600 lb	1H184212C	1100 lb	-		
	15"	-	-	1H204215C	600 lb	1H184215C	1100 lb	-		
	18"	-	-	1H204218C	600 lb	1H184218C	1050 lb	1600 lb		
	24"	-	-	1H204224C	600 lb	1H184224C	900 lb	1600 lb		
	30"	-	-	1H204230C	625 lb	1H184230C	1000 lb	1600 lb		
	32"	-	-	1H204232C	525 lb	1H184232C	950 lb	1600 lb		
48"	36"	-	-	1H204236C	475 lb	1H184236C	900 lb	1600 lb		
	12"	1H224812C	350 lb	1H204812C	500 lb	1H184812C	750 lb	-		
	15"	-	-	1H204815C	500 lb	1H184815C	850 lb	-		
	18"	1H224818C	375 lb	1H204818C	500 lb	1H184818C	900 lb	1200 lb		
	24"	1H224824C	400 lb	1H204824C	500 lb	1H184824C	900 lb	1200 lb		
	30"	-	-	-	1H204830C	500 lb	1H184830C	750 lb	1200 lb	
36"	-	-	-	1H204836C	500 lb	1H184836C	750 lb	1200 lb		

All figures shown are shelf load capacities in pounds for evenly distributed loads and include a safety factor of 1.65. Recommend Heavy Duty or Extra Heavy Duty for shelving requirements larger than 36"x 24". Note: (1) : Class 3 capacities are based upon the use of Extra Heavy Duty Shelves with (A) Side Shelf Supports and (B) Center Support for additional capacity. Must use nuts and bolts for shelves, not clips.

W	D	H	*	Cat. No.	Price	Per	Wt.	Pkg.
---	---	---	---	----------	-------	-----	-----	------

W	D	H	*	Cat. No.	Price	Per	Wt.	Pkg.
---	---	---	---	----------	-------	-----	-----	------

Class 3 Shelf Supports

Center Support

Runs left to right beneath the mid-point of the shelf for conversion to Class 3. Supported by side shelf supports.

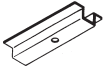

36		H13736C	26.20	Ea.	3.9	20
42		H13742C	32.20	Ea.	4.6	20
48		H13748C	32.30	Ea.	5.2	20

Side Shelf Support (Pair)

Supports center support in Class 3 applications.

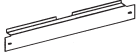

18		1H830H	52.75	Pr.	2.9	10
24		1H840H	55.80	Pr.	3.9	10
30		1H850H	38.60	Pr.	4.9	10
36		1H860H	75.60	Pr.	5.9	10

Shelving Doors

With Lock & 2 keys

Standard Swinging Doors cannot be used on shelving with Modular Drawers.



36	36	19600H	293.35	Pr.	37.0	PPO
36	48	19610H	328.70	Pr.	49.0	PPO
36	73	19630H	436.70	Pr.	67.0	PPO
36	85	19640H	475.35	Pr.	65.0	PPO
48	36	19646H	513.35	Pr.	32.5	PPO
48	85	19650H	583.70	Pr.	89.0	PPO

Sliding Doors

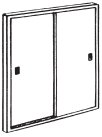

(set of 2)

Flanged on all 4 sides and reinforced. Doors slide on quiet, smooth-running nylon rollers and guides. Complete with grooved key cylinder lock w/keys, mounting channels & universal clips. Designed for use in side by side models with shelf at top.

72	36	1H907236	828.30	Pr.	64.1	PPO
72	84	1H907284	1038.20	Pr.	123.0	PPO

Front Base Strips

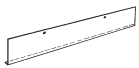

Fastens directly to the bottom shelf front to close the gap beneath it and the floor. Normally used with closed shelving. Includes hardware.

24	3	14500H	15.50	Ea.	0.8	10
30	3	14510H	15.93	Ea.	1.1	10
36	3	14520H	10.75	Ea.	1.6	10
42	3	14530H	11.75	Ea.	1.8	10
48	3	14540H	13.95	Ea.	2.0	10

Label Holders

Punched for attaching to the front flange of shelves.

Accepts 7/8" high labels. Attaches with plastic button fasteners (included).

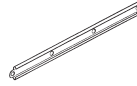

24		13900H	2.45	Ea.	0.3	100
30		13910H	2.80	Ea.	0.3	100
36		13920H	6.15	Ea.	0.4	100
42		13930H	6.80	Ea.	0.4	100
48		13940H	7.80	Ea.	0.5	100

Bin Fronts

Hardware included for fastening to front of shelf.

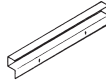

36	1	14210H	17.35	Ea.	1.6	10
36	2	14220H	19.60	Ea.	2.0	10

Hardware included for clipping between posts.

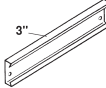

36	3	14230C	21.70	Ea.	2.2	10
42	3	14330C	22.35	Ea.	2.5	10
48	3	14430C	30.30	Ea.	2.8	10

Full Height Dividers

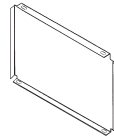

Front edge beaded; top, bottom and rear edges flanged. Attaches with plastic button fasteners (included). For Class 3 use, contact your representative regarding special notching.

12	6	15600H	12.95	Ea.	0.6	PPO
12	9	15620H	12.50	Ea.	0.8	PPO
12	12	15640H	14.15	Ea.	1.0	PPO
12	14	15650H	14.50	Ea.	1.2	PPO
12	18	15670H	16.80	Ea.	1.5	PPO
15	6	15700H	13.45	Ea.	0.8	PPO
15	9	15720H	17.00	Ea.	1.4	PPO
15	12	15740H	13.00	Ea.	1.4	PPO
18	6	15800H	13.80	Ea.	0.9	PPO
18	9	15820H	13.35	Ea.	1.3	PPO
18	10	15830H	14.75	Ea.	1.4	PPO
18	12	15840H	14.75	Ea.	1.7	PPO
18	16	15860H	17.40	Ea.	2.2	PPO
18	18	15870H	18.35	Ea.	2.4	PPO
18	24	15890H	25.95	Ea.	4.8	PPO
24	6	15900H	14.75	Ea.	1.2	PPO
24	9	15920H	16.65	Ea.	1.7	PPO
24	12	15940H	17.35	Ea.	2.2	PPO
24	18	15970H	20.70	Ea.	3.2	PPO
24	24	15990H	26.60	Ea.	6.2	PPO
36	6	16100H	34.00	Ea.	1.8	PPO
36	9	16120H	25.55	Ea.	2.4	PPO
36	12	16140H	29.35	Ea.	3.1	PPO
36	18	16170H	43.05	Ea.	4.7	PPO
36	24	16180H	62.60	Ea.	9.1	PPO

Clipper Shelving Accessories



W	D	H	*	Cat. No.	Price	Per	Wt.	Pkg.
---	---	---	---	----------	-------	-----	-----	------

W	D	H	*	Cat. No.	Price	Per	Wt.	Pkg.
---	---	---	---	----------	-------	-----	-----	------

Partial Dividers

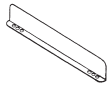

Partitions shelves from front to rear. Flanged and punched for shelf attachment. Has rounded top corners for safety. Attaches with plastic button fasteners (included).

12	2			16395H	5.85	Ea.	0.4	PPO
12	4			16410H	6.05	Ea.	0.7	PPO
18	2			16397H	7.70	Ea.	0.6	PPO
18	4			16430H	7.05	Ea.	1.1	PPO
24	4			16440H	7.05	Ea.	1.5	PPO

Sliding Dividers

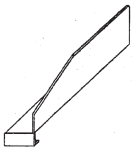

For Hi-Performance Shelves ONLY

Formed to fit around front and over rear edges of shelf. Can be positioned horizontally anywhere along shelf surface. No hardware required. Medium & Heavy Duty Hi-Performance shelves only (NOT for Conv. Flange shelf or Extra HD).

12	4			1H4124C	18.45	Ea.	1.0	PPO
12	6			1H4126C	18.55	Ea.	1.3	PPO
18	4			1H4184C	16.95	Ea.	1.5	PPO
18	6			1H4186C	18.00	Ea.	1.9	PPO
24	4			1H4244C	18.10	Ea.	1.9	PPO
24	6			1H4246C	20.60	Ea.	2.4	PPO

Shelf Boxes

Has integral full finger grip and embossed label holder. Slotted on 1" centers for dividers. Back stop minimizes accidental removal of drawer. Depth dimension nominal. Boxes per 36" wide shelf: 6" wide, 6; 8" wide, 4; 11" wide, 3.



028 Gray is Standard

Order Box Dividers separately.

5-5/8	11	4-5/8		38030C	22.20	Ea.	2.9	12
8-7/16	11	4-5/8		38035C	30.35	Ea.	3.4	8
11-1/4	11	4-5/8		38040C	32.50	Ea.	5.5	6
5-5/8	17	4-5/8		38180C	28.65	Ea.	3.9	12
8-7/16	17	4-5/8		38185C	33.55	Ea.	4.7	8
11-1/4	17	4-5/8		38190C	37.35	Ea.	6.0	6
5-5/8	23	4-5/8		38255C	35.70	Ea.	4.9	12
8-7/16	23	4-5/8		38260C	37.45	Ea.	6.0	8
11-1/4	23	4-5/8		38265C	48.25	Ea.	7.4	6

Divider, Shelf Boxes



For quick and easy partitioning of shelf boxes on 1" centers. Galvanized steel.

5-5/8		4-1/2		38306	1.80	Ea.	0.3	10
8-7/16		4-1/2		38307	2.30	Ea.	0.4	10
11-1/4		4-1/2		38308	3.10	Ea.	0.6	10

Shelf Box Guide (Ea.)

Guides shelf box to prevent snagging on post. Order 2 guides for each full shelf of shelf boxes.

For Shelf Boxes - 028 Gray is Standard

10038H028	1.00	Ea.	0.1	PPO
-----------	------	-----	-----	-----



Coat Rod Bracket

18		14705H	9.55	Ea.	1.5	PPO
24		14706H	12.65	Ea.	2.0	PPO
36		14708H	19.00	Ea.	3.0	PPO

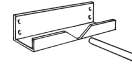

Coat Rod - 3/4" Galvanized Pipe

36		9405C	14.05	Ea.	3.5	PPO
48		9406C	19.50	Ea.	4.7	PPO

Finished End Panels

For use with Box front posts.

12	87	18241H	56.20	Ea.	15.0	PPO
18	87	18440H	82.25	Ea.	26.0	PPO
24	87	18540H	116.95	Ea.	31.0	PPO



Multi-Level Shelving Parts

Multi-Level Support W/Hardware

LH or RH All Except Box Post

5		10062H	8.40	Ea.	0.9	PPO
---	--	---------------	-------------	-----	-----	-----

LH or RH Box Post Only

5		10063H	8.40	Ea.	0.6	PPO
---	--	---------------	-------------	-----	-----	-----

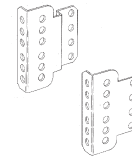

Cross Aisle Supports

30	4	85130H	23.65	Ea.	4.7
36	4	85136H	25.45	Ea.	5.5
42	4	85142H	27.20	Ea.	6.3
48	4	85148H	32.45	Ea.	10.6

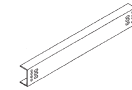

Grating Support Channels

30	4	85230H	22.75	Ea.	4.4
36	4	85236H	25.35	Ea.	5.3
42	4	85242H	26.05	Ea.	6.0
48	4	85248H	30.70	Ea.	10.0

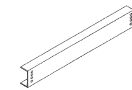

Grating Support Hanger

3	2	4	85201C	6.20	Ea.	0.9
---	---	---	---------------	-------------	-----	-----





Channel Lock Safety Grating

W	D	H	*	Cat. No.	Price	Per	Wt.	Pkg.
---	---	---	---	----------	-------	-----	-----	------

Grating Support Angle

1	2	4		85200C	3.65	Ea.		0.4
---	---	---	--	---------------	-------------	-----	--	-----



Post Assembly

3	2-1/4	87		84087C	150.65	Ea.		25.0
3	2-1/4	99		84099C	167.35	Ea.		28.0

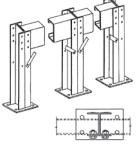

5" High Beam

To be used with Post Assembly. Maximum 93" Long.

93	2	5		85293C	69.90	Ea.		31.0
----	---	---	--	---------------	--------------	-----	--	------



End of Aisle Kickplate

For Clipper & Erectomatic Posts

30		4		H2KP30	20.80	Ea.		4.8
36		4		H2KP36	22.50	Ea.		5.6
42		4		H2KP42	25.60	Ea.		6.4
48		4		H2KP48	26.55	Ea.		7.3



Channel Lock Grating, 16 Ga.

Actual size of top of grating is 8-7/8". **GRATING CONVERSION FACTORS:** To convert Sq. Ft. to 9" wide linear feet; Multiply Sq. Ft. x 1.35. To convert 9" wide linear feet to square feet; Multiply Linear Ft. x .74.

Male/Female

Interlocks on both sides. Galvanized Finish.

72	8-7/8	2		8AL072C	49.40	Ea.		19.0
108	8-7/8	2		8AL108C	73.10	Ea.		28.0
144	8-7/8	2		8AL144	97.10	Ea.		37.0



Male/Male

For end of row applications. Interlocks on one side only.

Galvanized Finish.

72	8-7/8	2		8GL072C	61.85	Ea.		19.0
108	8-7/8	2		8GL108C	90.10	Ea.		28.0
144	8-7/8	2		8GL144	118.25	Ea.		37.0



Grating Fillers

Galvanized

Tek screws may be required for fastening.

72	3	2		8FK072C	38.65	Ea.		8.5
108	3	2		8FK108C	58.75	Ea.		12.8
144	3	2		8FK144	75.90	Ea.		17.0



W	D	H	*	Cat. No.	Price	Per	Wt.	Pkg.
---	---	---	---	----------	-------	-----	-----	------

Grating Splice Angle

12				8SP012C	7.05	Ea.		1.0
----	--	--	--	----------------	-------------	-----	--	-----

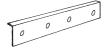

Grating Hardware Kit Bag of 50 Nuts and Bolts

5/16" x 5/8" Hex Head Bolts with Hex Nuts. Order four nuts and bolts per plank.

82201	13.85	50		2.0	50
--------------	--------------	----	--	-----	----

Grating "J" Bolts

Bag of 50 With Nuts

Order one bag per 200 square feet of grating.

82200	35.55	50		4.0	50
--------------	--------------	----	--	-----	----

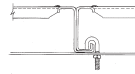

Grating Hold Down Clips

With Tek Screw

Must use power tool with extension.

8HC00H	1.55	Ea.		0.1
---------------	-------------	-----	--	-----

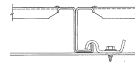

W	D	H	*	Cat. No.	Price	Per	Wt.	Pkg.
---	---	---	---	----------	-------	-----	-----	------

Handrail/Parts: Multi-Level Shelving

Available with posts for 2 rails and 3 rails. Finished in 710 Yellow. Use only with Penco Channel-Lock Grating. For handrail with other types of decking, contact your representative.

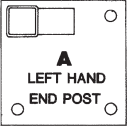
Post, Left Hand End, 2 Rails		42	85204A	74.00	Ea.	10.5
						
Post, Left Hand End, 3 Rails		42	85205A	80.10	Ea.	10.7

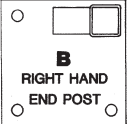
Post, Right Hand End, 2 Rails		42	85204B	74.00	Ea.	10.5
						
Post, Right Hand End, 3 Rails		42	85205B	80.10	Ea.	10.7

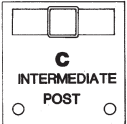
Post, Intermediate, 2 Rails		42	85204C	87.20	Ea.	11.2
						
Post, Intermediate, 3 Rails		42	85205C	98.80	Ea.	11.4

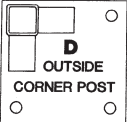
Post, Outside Corner, 2 Rails		42	85204D	86.95	Ea.	11.0
						
Post, Outside Corner, 3 Rails		42	85205D	98.80	Ea.	11.4

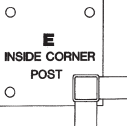
Post, Inside Corner, 2 Rails		42	85204E	86.95	Ea.	11.0
						
Post, Inside Corner, 3 Rails		42	85205E	98.80	Ea.	11.4

Handrail - Nominal 6' Section		72	852066C	34.10	Ea.	9.6
						
Kick Plate		72	850072C	24.25	Ea.	9.2

End Of Aisle Handrail Bracket		Order 2 Per Pc. of Handrail		85207H	13.95	Ea.	1.0
							

Two Rail Post illustrated: two and three rail models are available

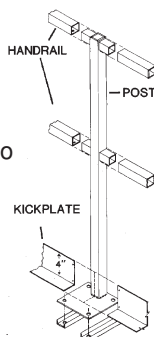



W	D	H	*	Cat. No.	Price	Per	Wt.	Pkg.
---	---	---	---	----------	-------	-----	-----	------

Replacement Hardware

Clipper Hi-Performance Shelf Clip		For Hi-Performance Shelves		10002Z	0.45	Ea.	0.1 PPO
							

Clipper Standard Shelf Clip		For Standard Flange Shelves		100001Z	0.45	Ea.	0.1 PPO
							

Plastic Button		For attaching various shelving accessories such as dividers and label holders. Normally included with shipment; order here for replacement only.		8401	0.10	Ea.	0.1 PPO
							

Back Panel Clip		Formed to fit the bottom flange of the shelf and tabbed to insert in holes in center of back panel. Holds back panel to shelf. Order as replacement part only.		H120	0.70	Ea.	0.1 PPO
							

Bin Front Clip, For 3" h Bin Fronts		Order as replacement part only.		10037Z	1.00	Ea.	0.1 PPO
							

Machine Screw, 1/4-20 x 1-1/4" TR HD		1-1/4	8101H	10.65	100	4.0	100
							

Machine Screw, 5/16-18 x 1-1/4" TR HD		1-1/4	8102H	19.90	100	6.0	100
							

Pan Head Screw, 1/4-20 x 1/2"		1/2	8412H	6.05	100	2.0	100
							

Slotted Truss Head Mach. Bolt, 1/4-20 x 3/4"		3/4	8410H	9.20	100	2.3	100
							

Hex Nuts 1/4"-20		8473H	3.10	100	1.5	100	
							

Machine Screw, 1/4-20 x 1" TR HD		1	8415H	9.20	100	3.0	100
							

Machine Screw, 5/16-18 X 1/2" TR HD		1/2	8455H	12.25	100	3.5	100
							

Hex Nuts 5/16" - 18		8459H	6.05	100	2.0	100	
							

Stairs and Stair Structures are Available from our sister company, Schmidt Structural Products
All applications involving stairs are reviewed individually and designed to meet or exceed local, state and federal codes in effect at the location where the stairs are to be installed.



Wide Span Shelving Units

W	D	H	*	Cat. No.	Price	Per	Wt.	Pkg.
---	---	---	---	----------	-------	-----	-----	------

W	D	H	*	Cat. No.	Price	Per	Wt.	Pkg.
---	---	---	---	----------	-------	-----	-----	------

Wide Span Basic Units with Steel Shelves Consist of:

- 1 Upright Frame,
- 2 or 3 levels of Steel Shelves,
- 2 or 3 pairs of Side Shelf Supports,
- 2 pairs of Rigidity Beams.

Order the appropriate size Upright Frame to end each unit or group of units separately!

Wide Span Units for Wood Deck Consist of:

- 1 Upright Frame,
- 3 pairs of Plywood Beams,
- Plywood Support Angles (3 per pair of 72-1/2" beams, 4 per pair of 96-1/2" beams).

Order the appropriate size Upright Frame to end each unit or group of units separately!

Wide Span Shelving Basic Units

To end a row or unit of Wide Span Shelving order the appropriate size Upright Frame separately.



With 2 Steel Shelves

60	30	72	20351	489.90	Unit	147.0	LPP
72	30	72	20353	534.00	Unit	168.0	LPP
84	30	72	20355	583.95	Unit	189.0	LPP
96	30	72	20357	631.20	Unit	210.0	LPP
60	30	96	20383	515.05	Unit	154.0	LPP
72	30	96	20385	559.20	Unit	175.0	LPP
84	30	96	20387	609.05	Unit	196.0	LPP
96	30	96	20389	656.35	Unit	217.0	LPP
60	36	72	20359	550.90	Unit	169.0	LPP
72	36	72	20361	604.85	Unit	193.0	LPP
84	36	72	20363	662.70	Unit	217.0	LPP
96	36	72	20365	716.35	Unit	241.0	LPP
60	36	96	20391	577.40	Unit	177.0	LPP
72	36	96	20393	631.35	Unit	202.0	LPP
84	36	96	20395	689.15	Unit	226.0	LPP
96	36	96	20397	742.90	Unit	250.0	LPP
60	48	72	20375	618.60	Unit	196.0	LPP
72	48	72	20377	680.70	Unit	224.0	LPP
84	48	72	20379	759.10	Unit	252.0	LPP
96	48	72	20381	817.75	Unit	280.0	LPP
60	48	96	20407	647.20	Unit	205.0	LPP
72	48	96	20409	709.45	Unit	233.0	LPP
84	48	96	20411	787.50	Unit	261.0	LPP
96	48	96	20413	846.50	Unit	289.0	LPP



With 3 Steel Shelves

60	30	120	20415	671.90	Unit	207.0	LPP
72	30	120	20417	732.55	Unit	235.0	LPP
84	30	120	20419	801.30	Unit	264.0	LPP
96	30	120	20421	865.70	Unit	292.0	LPP
60	30	144	20447	702.50	Unit	214.0	LPP
72	30	144	20449	763.05	Unit	243.0	LPP
84	30	144	20451	831.40	Unit	271.0	LPP
96	30	144	20453	896.30	Unit	300.0	LPP
60	36	120	20423	764.65	Unit	240.0	LPP
72	36	120	20425	839.45	Unit	302.0	LPP
84	36	120	20427	920.45	Unit	307.0	LPP
96	36	120	20429	994.70	Unit	341.0	LPP
60	36	144	20455	796.80	Unit	249.0	LPP
72	36	144	20457	871.70	Unit	282.0	LPP
84	36	144	20459	952.60	Unit	316.0	LPP
96	36	144	20461	1026.80	Unit	350.0	LPP
60	48	120	20439	864.75	Unit	280.0	LPP
72	48	120	20441	951.80	Unit	320.0	LPP
84	48	120	20443	1063.40	Unit	359.0	LPP
96	48	120	20445	1145.40	Unit	398.0	LPP
60	48	144	20471	898.20	Unit	289.0	LPP
72	48	144	20473	985.10	Unit	328.0	LPP
84	48	144	20475	1097.10	Unit	367.0	LPP
96	48	144	20477	1178.85	Unit	407.0	LPP

Wide Span Units For Wood Deck

To end a row or unit of Wide Span Shelving order the appropriate size Upright Frame separately. Deck material NOT included.



With 3 Beam Levels

72-1/2	48	120	20512	482.50	Unit	136.0	LPP
72-1/2	48	144	20535	515.90	Unit	145.0	LPP
96-1/2	48	120	20514	554.00	Unit	167.0	LPP
96-1/2	48	144	20537	587.60	Unit	175.0	LPP

Tire Rack Units

For passenger car tires. Units have tire beams on aisle side; rigidity beams at rear. Order Upright Frames Separately.

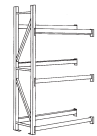

Basic Units, Single Entry

60	18	96	20651	290.80	Unit	84.0	LPP
60	18	126	20653	371.10	Unit	106.0	LPP
60	18	156	20655	480.80	Unit	132.0	LPP
60	18	192	20657	563.60	Unit	159.0	LPP



Basic Units, Double Entry

60	38	96	20659	461.50	Unit	124.0	LPP
60	38	126	20661	577.40	Unit	161.0	LPP
60	38	156	20663	708.25	Unit	201.0	LPP
60	38	192	20665	840.75	Unit	241.0	LPP

Wide Span Tire Rack Unit Tire Capacities

Width (in.)	Depth (in.)	Height (in.)	Number of Tiers	Number of Tires
Single Entry Tire Racks				
60	18	96	3	24
60	18	126	4	32
60	18	156	5	40
60	18	192	6	48
Double Entry Tire Racks				
60	38	96	3	48
60	38	126	4	64
60	38	156	5	80
60	38	192	6	96

Tire storage capacities based on average passenger size tires.

Traditional color is 028 Gray, however all Penco standard colors are available. For Row Spacers and Wall Brackets, see Pallet Rack Accessories. ** Wide Span Upright capacity of 7,500 lbs. based on maximum vertical distance of 60" between floor and beam, or between beam and beam.

Wide Span Shelving Components



W	D	H *	Cat. No.	Price	Per	Wt.	Pkg.
---	---	-----	----------	-------	-----	-----	------

W	D	H *	Cat. No.	Price	Per	Wt.	Pkg.
---	---	-----	----------	-------	-----	-----	------

Wide Span Upright Frames

7,500 LB. CAPACITY**. Order to end a row or basic unit, and when building units from piece parts.

36" High (with Splices)

36" high units are designed to provide additional height when used with standard uprights; e.g. a 72" upright plus a 36" upright obtains a 108" high upright.



24	36	20081C	72.95	Ea.	13.4	PPO
30	36	20082C	74.50	Ea.	14.2	PPO
36	36	20083C	75.95	Ea.	14.9	PPO
42	36	20084C	79.20	Ea.	15.6	PPO
48	36	20085C	80.85	Ea.	16.4	PPO
50	36	2P036C	81.30	Ea.	16.7	PPO

72" & 84" High (with Footplates)



18	72	20000C	86.40	Ea.	19.8	PPO
24	72	20001C	87.65	Ea.	20.6	PPO
30	72	20002C	88.50	Ea.	21.1	PPO
36	72	20003C	89.35	Ea.	21.6	PPO
42	72	20004C	91.60	Ea.	22.1	PPO
48	72	20005C	93.85	Ea.	23.3	PPO
50	72	2P072C	94.20	Ea.	23.5	PPO
18	84	20008C	110.00	Ea.	22.3	PPO
24	84	20009C	111.25	Ea.	23.4	PPO
30	84	20010C	112.45	Ea.	24.1	PPO
36	84	20011C	115.15	Ea.	24.6	PPO
42	84	20012C	118.50	Ea.	25.1	PPO
48	84	20013C	121.65	Ea.	29.0	PPO
50	84	2P084C	121.95	Ea.	29.2	PPO

96" & 120" High (with Footplates)



18	96	20016C	111.10	Ea.	26.7	PPO
24	96	20017C	112.25	Ea.	27.7	PPO
30	96	20018C	113.55	Ea.	28.5	PPO
36	96	20019C	116.00	Ea.	30.4	PPO
42	96	20020C	119.75	Ea.	31.2	PPO
48	96	20021C	122.65	Ea.	32.5	PPO
50	96	2P096C	123.15	Ea.	32.8	PPO
18	120	20032C	127.65	Ea.	33.0	PPO
24	120	20033C	129.25	Ea.	34.0	PPO
30	120	20034C	130.35	Ea.	34.8	PPO
36	120	20035C	133.00	Ea.	36.1	PPO
42	120	20036C	135.25	Ea.	36.9	PPO
48	120	20037C	138.10	Ea.	38.5	PPO
50	120	2P020C	138.65	Ea.	38.8	PPO

144" To 192" High (with Footplates)

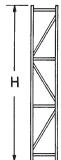

18	144	20048C	156.30	Ea.	39.4	PPO
24	144	20049C	158.05	Ea.	40.8	PPO
30	144	20050C	160.95	Ea.	42.4	PPO
36	144	20051C	165.10	Ea.	43.7	PPO
42	144	20052C	168.35	Ea.	45.6	PPO
48	144	20053C	171.45	Ea.	47.3	PPO
50	144	2P044C	173.30	Ea.	47.6	PPO
24	168	20065C	192.15	Ea.	47.7	PPO
30	168	20066C	193.70	Ea.	48.7	PPO
36	168	20067C	195.80	Ea.	49.7	PPO
42	168	20068C	203.20	Ea.	50.7	PPO
48	168	20069C	206.85	Ea.	52.9	PPO
50	168	2P068C	207.85	Ea.	53.2	PPO
24	192	24001C	207.50	Ea.	52.6	PPO
30	192	24002C	210.35	Ea.	54.8	PPO
36	192	24003C	213.40	Ea.	56.7	PPO
42	192	24004C	219.95	Ea.	58.2	PPO
48	192	24005C	223.35	Ea.	59.9	PPO
50	192	2P092C	224.40	Ea.	60.2	PPO

Tire Rack Upright Frames

For Single Entry Units (with Footplates)

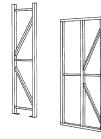

18	96	20016C	111.10	Ea.	26.7	PPO
18	126	20260C	131.60	Ea.	35.0	PPO
18	156	20056C	181.30	Ea.	43.0	PPO
18	192	24040C	204.20	Ea.	56.0	PPO

For Double Entry Units

38	96	20262C	192.80	Ea.	47.0	PPO
38	126	20263C	219.35	Ea.	57.0	PPO
38	156	20264C	260.55	Ea.	68.0	PPO
38	192	20265C	303.60	Ea.	94.0	PPO

Wide Span Upright Frame Accessories

Upright Frame Splice

Note that TWO splices must be ordered per frame. Top upright frame MUST be ordered without footplate. Hardware included.

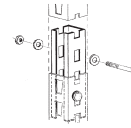

8	20099H	8.85	Ea.	1.0	PPO
---	---------------	-------------	-----	-----	-----

Shim, unpainted

2-1/4 3-1/2	20100C	1.55	Ea.	0.3	PPO
-------------	---------------	-------------	-----	-----	-----

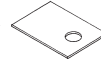

Concrete Floor Anchor

Use the longer anchor # 9281 in seismic zones above 2A.

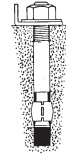

3/8	2-1/4	9280	1.75	Ea.	0.1	PPO
-----	-------	-------------	-------------	-----	-----	-----

Traditional color is 028 Gray, however all Penco standard colors are available. For Row Spacers and Wall Brackets, see Pallet Rack Accessories.** Wide Span Upright capacity of 7,500 lbs. based on maximum vertical distance of 60" between floor and beam, or between beam and beam.



Wide Span Beams and Supports

W	D	H	*	Cat. No.	Price	Per	Wt.	Pkg.
---	---	---	---	----------	-------	-----	-----	------

W	D	H	*	Cat. No.	Price	Per	Wt.	Pkg.
---	---	---	---	----------	-------	-----	-----	------

Wide Span Beams

Add 1/4" to beam width to obtain clearance between upright frames.

Rigidity Beams (Pairs)



48	20315	55.05	Pr.	13.9 PPO
60	20316	60.60	Pr.	16.8 PPO
72	20317	66.55	Pr.	18.7 PPO
84	20318	72.20	Pr.	22.6 PPO
96	20319	78.55	Pr.	25.4 PPO

Standard Plywood Beams (Pairs)

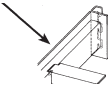

Plywood Support Angles Required

48-1/2	20337	64.70	Pr.	15.9 PPO
60-1/2	20338	74.35	Pr.	19.3 PPO
72-1/2	20339	81.15	Pr.	22.7 PPO
84-1/2	20340	87.35	Pr.	26.0 PPO
96-1/2	20335	93.75	Pr.	29.5 PPO

Heavy Duty Plywood Beams (Pairs)



H.D. Plywood Support/Beam Braces are required. Order Beam Braces based on capacity required. Has 5/8" Step.

48-1/2	210480	107.30	Pr.	20.8 PPO
72-1/2	210720	123.20	Pr.	29.9 PPO
96-1/2	210960	135.20	Pr.	39.0 PPO

Tire Rack Beams (Each)



Beam is slanted to cradle tires. It is designed to be installed on aisle side of unit.

48	20619C	26.85	Ea.	7.0 PPO
60	20620C	29.65	Ea.	8.0 PPO
72	20621C	32.65	Ea.	10.0 PPO

Plywood Support Angles

For Standard Plywood Beam

Use 2 per level of 48-1/2" & 60-1/2" beams; 3 for 72-1/2" & 84-1/2"; 4 for 96-1/2" beams.

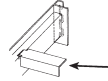

18	20349C	16.45	Ea.	1.2 PPO
24	20341C	18.20	Ea.	1.5 PPO
30	20330C	18.30	Ea.	2.0 PPO
36	20342C	18.50	Ea.	2.5 PPO
42	20332C	18.95	Ea.	2.8 PPO
48	20336C	19.00	Ea.	3.3 PPO

Beam Brace/H.D. Plywood Supports



When Rigidity Beams are used as load bearing members Beam Braces are used to keep beams from twisting.

When used with Heavy Duty Plywood Beams they are used as Plywood Supports. Use a minimum of two per pair of beams.

24	202040C	17.45	Ea.	2.2	12
30	202050C	20.60	Ea.	2.7	12
36	202060C	21.00	Ea.	3.2	12
42	202070C	22.45	Ea.	3.8	12
48	202080C	22.50	Ea.	4.3	12
50	2P0050C	25.85	Ea.	4.5	12

Wide Span Beam Capacities

Beam Type	Size (inches)	Capacity (Lbs.)**
Rigidity Beams (Capacity with Beam Braces- 1 for pair of 60" & 72", 2 per pair of 84" & 96")	48	2500/Pr.
	60	2140/Pr.
	72	1780/Pr.
	84	1580/Pr.
	96	1340/Pr.
Standard Plywood Beams (With Plywood Support Angles)	48-1/2	2500/Pr.
	60-1/2	2120/Pr.
	72-1/2	1760/Pr.
	84-1/2	1500/Pr.
	96-1/2	1350/Pr.
Heavy Duty Plywood Beams (Capacity using Beam Brace/ H.D. Plywood Supports)	48-1/2	2500/Pr.
	72-1/2	2500/Pr.
	96-1/2	2500/Pr.
Tire Rack Beams	48	950 Ea.
	60	800 Ea.
	72	600 Ea.

**Capacities based upon Uniformly Distributed Load, in Pounds.

Wide Span Beam Brace Capacities

Brace Type	Size (inches)	Capacity (Lbs.)**
Beam Brace/Heavy Duty Plywood Support	24	1200 Ea.
	30	1100 Ea.
	36	900 Ea.
	42	700 Ea.
	48	500 Ea.
	50	500 Ea.

**Capacities based upon Uniformly distributed Load, in Pounds.

For Row Spacers and Wall Brackets for Wide Span, use Pallet Rack parts on page 39.

A minimum of two (2) pairs of Rigidity Beams are required for each Wide Span unit. Note that Wide Span Shelves do NOT rest on standard Rigidity or Plywood Beams, but must be supported by Side Shelf supports.

Traditional color is 028 Gray, however all Penco standard colors are available. For Row Spacers and Wall Brackets, see Pallet Rack Accessories.** Wide Span Upright capacity of 7,500 lbs. based on maximum vertical distance of 60" between floor and beam, or between beam and beam.

Wide Span Steel Shelves and Shelf Supports



W	D	H	*	Cat. No.	Price	Per	Wt.	Pkg.
---	---	---	---	----------	-------	-----	-----	------

W	D	H	*	Cat. No.	Price	Per	Wt.	Pkg.
---	---	---	---	----------	-------	-----	-----	------

Wide Span Steel Shelves

Order Side Shelf Supports SEPARATELY

1 pair of Shelf Supports req'd per Shelf.

NOTE: 36" deep shelf is supplied as 2-18" deep shelves; 42" deep shelf is supplied as 1-24" & 1-18" shelf; 48" shelf is supplied as 2-24" shelves.

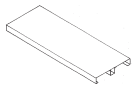

48	18	22418C	61.45	Ea.	18.8	LPP
48	24	22424C	72.00	Ea.	22.6	LPP
48	30	22430C	98.50	Ea.	30.5	LPP
48	36	22436	122.95	Ea.	37.6	LPP
48	42	22442	133.55	Ea.	41.4	LPP
48	48	22448	144.00	Ea.	45.2	LPP
60	18	22518C	70.15	Ea.	23.5	LPP
60	24	22524C	83.15	Ea.	28.3	LPP
60	30	22530C	114.70	Ea.	38.0	LPP
60	36	22536	140.40	Ea.	47.0	LPP
60	42	22542	153.25	Ea.	51.8	LPP
60	48	22548	166.05	Ea.	56.6	LPP
72	18	22618C	80.60	Ea.	28.1	LPP
72	24	22624C	95.55	Ea.	33.9	LPP
72	30	22630C	130.70	Ea.	45.6	LPP
72	36	22636	161.40	Ea.	56.2	LPP
72	42	22642	176.35	Ea.	62.0	LPP
72	48	22648	191.30	Ea.	67.8	LPP
84	18	22718C	92.25	Ea.	32.8	LPP
84	24	22724C	112.30	Ea.	39.5	LPP
84	30	22730C	150.00	Ea.	53.2	LPP
84	36	22736	184.45	Ea.	65.6	LPP
84	42	22742	204.45	Ea.	72.3	LPP
84	48	22748	224.50	Ea.	79.0	LPP
96	18	22818C	102.45	Ea.	37.2	LPP
96	24	22824C	123.85	Ea.	45.1	LPP
96	30	22830C	167.25	Ea.	60.8	LPP
96	36	22836	205.15	Ea.	78.5	LPP
96	42	22842	226.25	Ea.	82.5	LPP
96	48	22848	247.65	Ea.	90.2	LPP

Side Shelf Supports (Pairs)

One Pair Required Per Steel Shelf

Required for units with Steel Shelves!

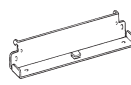

18	22018	27.90	Pr.	5.1	LPP
24	22024	38.85	Pr.	6.8	LPP
30	22030	41.80	Pr.	8.4	LPP
36	22036	43.80	Pr.	10.0	LPP
42	22042	44.35	Pr.	11.6	LPP
48	22048	51.50	Pr.	13.2	LPP

Wide Span Shelf Capacities**

Shelf Depth (Inches)	48" Wide	60" Wide	72" Wide	84" Wide	96" Wide
18	1200	1200	1000	800	600
24	1500	1200	1000	800	600
30	2300	1800	1500	1200	900
36	2400	2400	2000	1600	1200
42	2000	2000	2000	1600	1200
48	1800	1800	1800	1600	1200

** Capacities based upon Uniformly distributed load, in Pounds

A minimum of two (2) pairs of Rigidity Beams are required for each Wide Span unit using Wide Span Steel Shelves.

Note that Wide Span Shelves do NOT rest on standard Rigidity or Plywood Beams, but must be supported by Side Shelf supports.

A minimum of two (2) pairs of Rigidity Beams are required for each Wide Span unit . Note that Wide Span Shelves do NOT rest on standard Rigidity or Plywood Beams, but must be supported by Side Shelf supports.

Traditional color is 028 Gray, however all Penco standard colors are available. For Row Spacers and Wall Brackets, see Pallet Rack Accessories.
 ** Wide Span Upright capacity of 7,500 lbs. based on maximum vertical distance of 60" between floor and beam, or between beam and beam.

DESIGN CRITERIA

All units must have a full perimeter of double rivet beams at the top and bottom to insure a stable and rigid unit.

Single Rivet Units

All units using single rivet beams 10'0" to 18'0" in height, require an additional double rivet perimeter beam level located approximately in the middle of the unit.

All single rivet beam units must have one (1) intermediate pair of front to back beams for 7'0" and 8'0" high units and two (2) intermediate pair of front to back beams for 9'0" high units. For 10'0" to 18'0" high units refer to the above paragraph. DO NOT exceed 48" between front to back beams. Single Rivet and

Double front to back beams may be common when using TEE Posts on units up to 8'0" high.

All intermediate single rivet shelves over 24 inches deep must also have single rivet beams supporting the particle board front to back.

Double Rivet Units

All double rivet beam units must have a full perimeter of beams at every level.

Note: All front to back beams must be the same type as the left to right beams in any single level except channel beams.

How To Order RivetRite UNITS

The unit catalog numbers make it easy to order RivetRite without having to compile a bill of material of all component parts. Here is a guide to ordering RivetRite with UNIT catalog numbers.

1. Review the catalog and decide what type of unit will meet your requirement.
2. Determine the shelf size desired and select the capacity needed. Note the capacity shown is for the steel structure only.
3. Next determine the type of shelf deck material and calculate the quantity. Note that none of the unit catalog numbers include decking. (Particle Board decking available from Penco is unfinished and natural in color).
4. The 'traditional' color for all RivetRite steel parts is 723 Light Putty. It is available in any of Penco's standard powder coat colors on a production basis.
5. All starter units are furnished with four Angle Posts. Add-on units have two intermediate Tee Posts. When assembling Starter and Add-on units, put the Angle Posts at the extreme ends of the shelving row. Note that shelving growth will always occur; see growth chart in the RivetRite catalog.
6. If ordering piece parts from the component parts pages of the catalog, see How To Order RivetRite Components, or contact your Penco representative.
7. For faster shipment, see the Penco Quick-SHIP price list: the most popular sizes of most items are available from multiple warehouses in a 723 Light Putty finish.

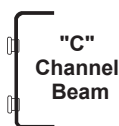

Double Rivet Unit Capacities

Units Without Center Supports

Width	Inches		Shelf Levels Per Unit	Beam Type	Capacity ** (lbs.)
	Depth	Height			
48	18 - 48	84	4	"R" Heavy Duty Angle	750
60	18 - 48	84	4	"R" Heavy Duty Angle	600
72	18 - 48	84	4	"R" Heavy Duty Angle	500
72	30 - 48	120	5	"R" Heavy Duty Angle	500

Units With Center Supports

48	18 - 24	84	4	"R" Heavy Duty Angle	1400
48	30	84	4	"R" Heavy Duty Angle	1310
48	36	84	4	"R" Heavy Duty Angle	1220
48	48	84	4	"R" Heavy Duty Angle	1125
60	18 - 48	84	4	"R" Heavy Duty Angle	1200
60	18 - 48	84	4	"C" Channel	2240 (1)
72	18 - 48	84	4	"R" Heavy Duty Angle	1000
72	18 - 48	84	4	"C" Channel	1850
96	18 - 48	84	4	"R" Heavy Duty Angle	620
96	18 - 48	84	4	"C" Channel	1400
72	30 - 48	120	5	"R" Heavy Duty Angle	1000
72	30 - 48	120	5	"C" Channel	1850 (2)
96	30 - 48	120	5	"R" Heavy Duty Angle	620
96	30 - 48	120	5	"C" Channel	1400

** Capacities for the steel support beams per level, not the shelf deck material. They are expressed in pounds for uniformly distributed loads.

NOTE: Units with Channel Beams are furnished with Heavy Duty Angle Beams at floor level.

(1) - Maximum Average Shelf Load 2000 lbs. per shelf.

(2) - Maximum Average Shelf Load 1490 lbs. per shelf

* NOTES: Traditional Color is 723 Light Putty, however all standard colors are available. Color selection must be made on the order.

All Unit Catalog Numbers are for Steel Framing only. Order deck material separately.

W	D	H	*	Cat. No.	Price	Per	Wt.	Pkg.
---	---	---	---	----------	-------	-----	-----	------

Double Rivet Units without Center Supports Consist of:

Starter Units

- 4 Standard Angle Posts (Up to and including 144" high)
- 2 Double Rivet Angle Beams left to right per shelf level
- 2 Double Rivet Angle Beams front to back per shelf level

Add-On Units

- 2 Standard Tee Posts (Up to and including 144" high)
- 2 Double Rivet Angle Beams left to right per shelf level
- 2 Double Rivet Angle Beams front to back per shelf level

- Order Deck Material Separately -

Double Rivet Units (w/o Center Support)

4 Shelf Starter Unit, 48" Wide

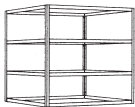

48	18	84	R	46001H	180.00	Unit	59.2
48	24	84	R	46002H	184.80	Unit	62.4
48	30	84	R	46003H	190.40	Unit	65.6
48	36	84	R	46004H	201.20	Unit	68.0
48	48	84	R	46005H	219.60	Unit	80.0

4 Shelf Starter Unit, 60" Wide

60	18	84	R	46011H	194.00	Unit	66.4
60	24	84	R	46012H	198.80	Unit	69.6
60	30	84	R	46013H	204.40	Unit	72.8
60	36	84	R	46014H	215.20	Unit	75.2
60	48	84	R	46015H	233.60	Unit	87.2

4 Shelf Starter Unit, 72" Wide

72	18	84	R	46021H	211.60	Unit	74.4
72	24	84	R	46022H	216.40	Unit	77.6
72	30	84	R	46023H	222.00	Unit	80.8
72	36	84	R	46024H	232.80	Unit	83.2
72	48	84	R	46025H	251.20	Unit	95.2

4 Shelf Add-On Unit, 48" Wide

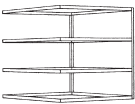

48	18	84	R	46006H	172.30	Unit	57.2
48	24	84	R	46007H	177.10	Unit	60.4
48	30	84	R	46008H	182.70	Unit	63.6
48	36	84	R	46009H	193.50	Unit	66.0
48	48	84	R	46010H	211.90	Unit	78.0

4 Shelf Add-On Unit, 60" Wide

60	18	84	R	46016H	186.30	Unit	64.4
60	24	84	R	46017H	191.10	Unit	67.6
60	30	84	R	46018H	196.70	Unit	70.8
60	36	84	R	46019H	207.50	Unit	73.2
60	48	84	R	46020H	225.90	Unit	85.2

4 Shelf Add-On Unit, 72" Wide

72	18	84	R	46026H	203.90	Unit	72.4
72	24	84	R	46027H	208.70	Unit	75.6
72	30	84	R	46028H	214.30	Unit	78.8
72	36	84	R	46029H	225.10	Unit	81.2
72	48	84	R	46030H	243.50	Unit	93.2

5 Shelf Starter Unit, 72" Wide



72	30	120	R	46041H	287.20	Unit	104.2
72	36	120	R	46042H	300.70	Unit	107.2
72	48	120	R	46043H	323.70	Unit	122.2

5 Shelf Add-On Unit, 72" Wide



72	30	120	R	46044H	274.10	Unit	101.6
72	36	120	R	46045H	287.60	Unit	104.6
72	48	120	R	46046H	310.60	Unit	119.6

* NOTES: Traditional Color is 723 Light Putty, however all standard colors are available. Color selection must be made on the order. All Unit Catalog Numbers are for Steel Framing only. Order deck material separately.

W	D	H	*	Cat. No.	Price	Per	Wt.	Pkg.
---	---	---	---	----------	-------	-----	-----	------

Double Rivet Units with Center Supports Consist of:

Starter Units

- 4 Standard Angle Posts (Up to and including 144" high)
- 2 Double Rivet Angle Beams left to right per shelf level
- 2 Double Rivet Angle Beams front to back per shelf level
- 1 Center Support per shelf level except for 96" wide units which have 2 per level.

Add-On Units

- 2 Standard Tee Posts (Up to and including 144" high)
- 2 Double Rivet Angle Beams left to right per shelf level
- 2 Double Rivet Angle Beams front to back per shelf level
- 1 Center Support per shelf level except for 96" wide units which have 2 per level.

- Order Deck Material Separately -

Double Rivet Units (w/Center Support)

4 Shelf Starter Unit, 48" Wide

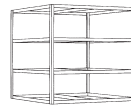

48	18	84	R	46W01H	206.80	Unit	64.8
48	24	84	R	46W02H	215.60	Unit	69.6
48	30	84	R	46W03H	224.80	Unit	74.4
48	36	84	R	46W04H	238.40	Unit	78.8
48	48	84	R	46W05H	268.40	Unit	94.0

4 Shelf Starter Unit, 60" Wide

60	18	84	R	46W11H	220.80	Unit	72.0
60	24	84	R	46W12H	229.60	Unit	76.8
60	30	84	R	46W13H	238.80	Unit	81.6
60	36	84	R	46W14H	252.40	Unit	86.0
60	48	84	R	46W15H	282.40	Unit	101.2

60	18	84	C	46W01C	245.40	Unit	79.8
60	24	84	C	46W02C	254.20	Unit	84.6
60	30	84	C	46W03C	263.40	Unit	89.4
60	36	84	C	46W04C	277.00	Unit	93.8
60	48	84	C	46W05C	307.00	Unit	109.0

4 Shelf Starter Unit, 72" Wide

72	18	84	R	46W21H	238.40	Unit	80.0
72	24	84	R	46W22H	247.20	Unit	84.8
72	30	84	R	46W23H	256.40	Unit	89.6
72	36	84	R	46W24H	270.00	Unit	94.0
72	48	84	R	46W25H	300.00	Unit	109.2

72	18	84	C	46W11C	263.30	Unit	89.0
72	24	84	C	46W12C	272.10	Unit	93.8
72	30	84	C	46W13C	281.30	Unit	98.6
72	36	84	C	46W14C	294.90	Unit	103.0
72	48	84	C	46W15C	324.90	Unit	118.2

4 Shelf Starter Unit, 96" Wide

96	18	84	R	46W31H	300.40	Unit	100.0
96	24	84	R	46W32H	313.20	Unit	106.4
96	30	84	R	46W33H	326.00	Unit	112.8
96	36	84	R	46W34H	342.40	Unit	119.2
96	48	84	R	46W35H	384.00	Unit	137.6

96	18	84	C	46W21C	335.80	Unit	112.6
96	24	84	C	46W22C	348.60	Unit	119.0
96	30	84	C	46W23C	361.40	Unit	125.4
96	36	84	C	46W24C	377.80	Unit	131.8
96	48	84	C	46W25C	419.40	Unit	150.2

C: Uses Channel Beam (except at floor level).

R: Beams 48" or longer are Heavy Duty, all other units have standard beams.



RivetRite Double Rivet Units

W	D	H	*	Cat. No.	Price	Per	Wt.	Pkg.
---	---	---	---	----------	-------	-----	-----	------

4 Shelf Add-On Unit, 48" Wide

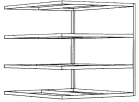

48	18	84	R	46W06H	199.10	Unit	62.8	
48	24	84	R	46W07H	207.90	Unit	67.6	
48	30	84	R	46W08H	217.10	Unit	72.4	
48	36	84	R	46W09H	230.70	Unit	76.8	
48	48	84	R	46W10H	260.70	Unit	92.0	

4 Shelf Add-On Unit, 60" Wide

60	18	84	R	46W16H	213.10	Unit	70.0	
60	24	84	R	46W17H	221.90	Unit	74.8	
60	30	84	R	46W18H	231.10	Unit	79.6	
60	36	84	R	46W19H	244.70	Unit	84.0	
60	48	84	R	46W20H	274.70	Unit	99.2	
60	18	84	C	46W06C	237.70	Unit	77.8	
60	24	84	C	46W07C	246.50	Unit	82.6	
60	30	84	C	46W08C	255.70	Unit	87.4	
60	36	84	C	46W09C	269.30	Unit	91.8	
60	48	84	C	46W10C	299.30	Unit	107.0	

4 Shelf Add-On Unit, 72" Wide

72	18	84	R	46W26H	230.70	Unit	78.0	
72	24	84	R	46W27H	239.50	Unit	82.8	
72	30	84	R	46W28H	248.70	Unit	87.6	
72	36	84	R	46W29H	262.30	Unit	92.0	
72	48	84	R	46W30H	292.30	Unit	107.2	
72	18	84	C	46W16C	255.60	Unit	87.0	
72	24	84	C	46W17C	264.40	Unit	91.8	
72	30	84	C	46W18C	273.60	Unit	96.6	
72	36	84	C	46W19C	287.20	Unit	101.0	
72	48	84	C	46W20C	317.20	Unit	116.2	

4 Shelf Add-On Unit, 96" Wide

96	18	84	R	46W36H	292.70	Unit	98.0	
96	24	84	R	46W37H	305.50	Unit	104.4	
96	30	84	R	46W38H	318.30	Unit	110.8	
96	36	84	R	46W39H	334.70	Unit	117.2	
96	48	84	R	46W40H	376.30	Unit	135.6	
96	18	84	C	46W26C	328.10	Unit	110.6	
96	24	84	C	46W27C	340.90	Unit	117.0	
96	30	84	C	46W28C	353.70	Unit	123.4	
96	36	84	C	46W29C	370.10	Unit	129.8	
96	48	84	C	46W30C	411.70	Unit	148.2	

W	D	H	*	Cat. No.	Price	Per	Wt.	Pkg.
---	---	---	---	----------	-------	-----	-----	------

5 Shelf Starter Unit, 72" Wide



72	30	120	R	46W41H	330.20	Unit	115.2	
72	36	120	R	46W42H	347.20	Unit	120.7	
72	48	120	R	46W43H	384.70	Unit	139.7	
72	30	120	C	46W31C	363.40	Unit	127.2	
72	36	120	C	46W32C	380.40	Unit	132.7	
72	48	120	C	46W33C	417.90	Unit	151.7	

5 Shelf Starter Unit, 96" Wide

96	30	120	R	46W47H	417.20	Unit	144.2	
96	36	120	R	46W48H	437.70	Unit	152.2	
96	48	120	R	46W49H	489.70	Unit	175.2	
96	30	120	C	46W37C	464.40	Unit	161.0	
96	36	120	C	46W38C	484.90	Unit	169.0	
96	48	120	C	46W39C	536.90	Unit	192.0	

5 Shelf Add-On Unit, 72" Wide

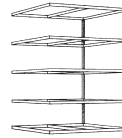

72	30	120	R	46W44H	317.10	Unit	112.6	
72	36	120	R	46W45H	334.10	Unit	118.1	
72	48	120	R	46W46H	371.60	Unit	137.1	
72	30	120	C	46W34C	350.30	Unit	124.6	
72	36	120	C	46W35C	367.30	Unit	130.1	
72	48	120	C	46W36C	404.80	Unit	149.1	

5 Shelf Add-On Unit, 96" Wide

96	30	120	R	46W50H	404.10	Unit	141.6	
96	36	120	R	46W51H	424.60	Unit	149.6	
96	48	120	R	46W52H	476.60	Unit	172.6	
96	30	120	C	46W40C	451.30	Unit	158.4	
96	36	120	C	46W41C	471.80	Unit	166.4	
96	48	120	C	46W42C	523.80	Unit	189.4	

C: Uses Channel Beam (except at floor level).
R: Beams 48" or longer are Heavy Duty, all other units have standard beams.

* NOTES: Traditional Color is 723 Light Putty, however all standard colors are available. Color selection must be made on the order.
All Unit Catalog Numbers are for Steel Framing only. Order deck material separately.

Single Rivet Shelving Units



W	D	H	*	Cat. No.	Price	Per	Wt.	Pkg.
---	---	---	---	----------	-------	-----	-----	------

W	D	H	*	Cat. No.	Price	Per	Wt.	Pkg.
---	---	---	---	----------	-------	-----	-----	------

Single Rivet Units Consist of:

Starter Units

- 4 Standard Angle Posts
- 4 Double Rivet Angle Beams left to right
- 4 Double Rivet Angle Beams front to back
- The appropriate number of Single Rivet Shelf Beams left to right.
- 2 Single Rivet Shelf Beams front to back up to 24" deep;

All units that are 36" Deep - Single Rivet Shelf Beams front to back at every shelf level

Add-On Units

- 2 Standard Tee Posts
- 2 Standard Angle Posts
- 4 Double Rivet Angle Beams left to right
- 2 Double Rivet Angle Beams front to back, except 36" deep unit has 4. The appropriate number of Single Rivet Shelf Beams left to right.
- 1 Single Rivet Shelf Beam front to back except for 36" deep which has 2 per shelf level.

- Order Deck Material Separately -

Single Rivet Unit Capacities

Inches			Number of Shelf levels per Unit	Capacity ** (lbs.)
Width	Depth	Height		
36	12 - 36	84	5 - 8	350
48	12 - 36	84	5 - 8	250

**Capacities are for the steel beam levels, not the shelf deck material. They are expressed in pounds for uniformly distributed loads.

Single Rivet Shelving Units

5 Shelf Starter Unit

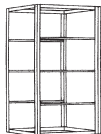

36	12	84	461315	142.10	Unit	42.4
36	18	84	461325	147.30	Unit	44.6
36	24	84	461335	150.40	Unit	46.6
36	36	84	461345	181.00	Unit	56.8
48	12	84	461415	155.20	Unit	51.4
48	18	84	461425	157.20	Unit	52.0
48	24	84	461435	163.50	Unit	55.6
48	36	84	461445	194.10	Unit	65.8

5 Shelf Add-On Unit

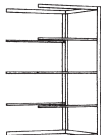

36	12	84	462355	134.40	Unit	40.4
36	18	84	462365	139.60	Unit	42.6
36	24	84	462375	142.70	Unit	44.6
36	36	84	462385	173.30	Unit	54.8
48	12	84	462455	147.50	Unit	49.4
48	18	84	462465	149.50	Unit	50.0
48	24	84	462475	155.80	Unit	53.6
48	36	84	462485	186.40	Unit	63.8

6 Shelf Starter Unit

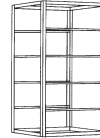

36	12	84	461316	152.00	Unit	45.6
36	18	84	461326	157.20	Unit	47.8
36	24	84	461336	160.30	Unit	49.8
36	36	84	461346	200.80	Unit	63.2
48	12	84	461416	166.40	Unit	55.6
48	18	84	461426	171.60	Unit	57.8
48	24	84	461436	174.70	Unit	59.8
48	36	84	461446	215.20	Unit	73.2

6 Shelf Add-On Unit

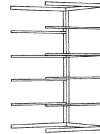

36	12	84	462356	144.30	Unit	43.6
36	18	84	462366	149.50	Unit	45.8
36	24	84	462376	152.60	Unit	47.8
36	36	84	462386	193.10	Unit	61.2
48	12	84	462456	158.70	Unit	53.6
48	18	84	462466	163.90	Unit	55.8
48	24	84	462476	167.00	Unit	57.8
48	36	84	462486	207.50	Unit	71.2

7 Shelf Starter Unit



36	12	84	461317	161.90	Unit	48.8
36	18	84	461327	167.10	Unit	51.0
36	24	84	461337	170.20	Unit	53.0
36	36	84	461347	220.60	Unit	69.6
48	12	84	461417	177.60	Unit	59.8
48	18	84	461427	179.60	Unit	60.4
48	24	84	461437	185.90	Unit	64.0
48	36	84	461447	236.30	Unit	80.6

7 Shelf Add-On Unit

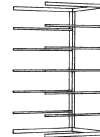

36	12	84	462357	154.20	Unit	46.8
36	18	84	462367	159.40	Unit	49.0
36	24	84	462377	162.50	Unit	51.0
36	36	84	462387	212.90	Unit	67.6
48	12	84	462457	169.90	Unit	57.8
48	18	84	462467	171.90	Unit	58.4
48	24	84	462477	178.20	Unit	62.0
48	36	84	462487	228.60	Unit	78.6

8 Shelf Starter Unit



36	12	84	461318	171.80	Unit	52.0
36	18	84	461328	177.00	Unit	54.2
36	24	84	461338	180.10	Unit	56.2
36	36	84	461348	240.40	Unit	76.0
48	12	84	461418	188.80	Unit	64.0
48	18	84	461428	190.80	Unit	64.6
48	24	84	461438	197.10	Unit	68.2
48	36	84	461448	257.40	Unit	88.0

8 Shelf Add-On Unit



36	12	84	462358	164.10	Unit	50.0
36	18	84	462368	169.30	Unit	52.2
36	24	84	462378	172.40	Unit	54.2
36	36	84	462388	232.70	Unit	74.0
48	12	84	462458	181.10	Unit	62.0
48	18	84	462468	186.30	Unit	64.2
48	24	84	462478	189.40	Unit	66.2
48	36	84	462488	239.80	Unit	82.8

* NOTES: Traditional Color is 723 Light Putty, however all standard colors are available. Color selection must be made on the order.

All Unit Catalog Numbers are for Steel Framing only. Order deck material separately.



RivetRite Record Storage Units

W	D	H	*	Cat. No.	Price	Per	Wt.	Pkg.
---	---	---	---	----------	-------	-----	-----	------

W	D	H	*	Cat. No.	Price	Per	Wt.	Pkg.
---	---	---	---	----------	-------	-----	-----	------

Units with 4 levels are illustrated.
Actual number of shelf levels shown in table at right
 (60"=3; 84"=4; 108"=5; 168"=7; 192"=8 levels).

Record Storage Unit Storage Box Capacities

Inches			Number of Shelves	Number of Boxes
Width	Depth	Height		
42	15	60	3	18
42	30	60	3	36
69	15	60	3	30
69	30	60	3	60
42	15	84	4	24
42	30	84	4	48
69	15	84	4	40
69	30	84	4	80
42	15	108	5	30
42	30	108	5	60
69	15	108	5	50
69	30	108	5	100
69	15	168	7	70
69	30	168	7	140
69	15	192	8	80
69	30	192	8	160

Box capacities are based on a standard archive box size of 12-1/2" w x 16 1/2" d x 10-1/2" h

The unit illustrations to the left show starter units as if they were the beginning of a continuous row, where a Tee Post would be common between units. If you are ordering a single starter unit, you will receive all Angle Posts. Tee Posts are furnished with Add-On units.



Record Storage Shelving Units

Order Deck Material Separately.

For Use With Decking

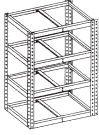

Starter Units								
42	15	84	46601A	165.20	Unit	48.8		
42	30	84	46602A	178.40	Unit	56.8		
69	15	84	46603A	203.60	Unit	70.4		
69	30	84	46604A	251.20	Unit	87.2		
42	15	108	46605A	208.00	Unit	61.4		
42	30	108	46606A	224.50	Unit	71.4		
69	15	108	46607A	256.00	Unit	88.4		
69	30	108	46608A	315.50	Unit	109.4		
69	15	168	46609A	393.60	Unit	136.0		
69	30	168	46610A	476.90	Unit	165.4		
69	15	192	46611A	449.40	Unit	155.6		
69	30	192	46612A	544.60	Unit	189.2		

Order Deck Material Separately.



Add-On Units								
42	15	84	46613A	157.50	Unit	46.8		
42	30	84	46614A	170.70	Unit	54.8		
69	15	84	46615A	195.90	Unit	68.4		
69	30	84	46616A	243.50	Unit	85.2		
42	15	108	46617A	195.20	Unit	59.2		
42	30	108	46618A	211.70	Unit	69.2		
69	15	108	46619A	243.20	Unit	86.2		
69	30	108	46620A	302.70	Unit	107.2		
69	15	168	46621A	399.30	Unit	134.6		
69	30	168	46622A	482.60	Unit	164.0		
69	15	192	46623A	456.40	Unit	153.8		
69	30	192	46624A	551.60	Unit	187.4		

With Steel Box Supports

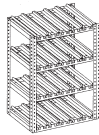

Starter Units								
42	15	60	46701A	216.90	Unit	50.2		
42	30	60	46702A	272.70	Unit	67.0		
69	15	60	46703A	310.50	Unit	76.0		
69	30	60	46704A	422.70	Unit	106.6		
42	15	84	46705A	292.00	Unit	68.0		
42	30	84	46706A	366.40	Unit	90.4		
69	15	84	46707A	416.80	Unit	102.4		
69	30	84	46708A	566.40	Unit	143.2		

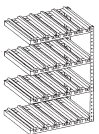

Add-On Units								
42	15	60	46709A	212.90	Unit	49.0		
42	30	60	46710A	268.70	Unit	65.8		
69	15	60	46711A	306.50	Unit	74.8		
69	30	60	46712A	418.70	Unit	105.4		
42	15	84	46713A	284.30	Unit	66.0		
42	30	84	46714A	358.70	Unit	88.4		
69	15	84	46715A	409.10	Unit	100.4		
69	30	84	46716A	558.70	Unit	141.2		

Record Storage Units For Use With Decking Consist of:

Starter Units

- 4 Standard Angle Posts (Up to and including 108" high) 168" and 192" are Heavy Duty
- 2 Double Rivet Angle Beams left to right per shelf level
- 2 Double Rivet Angle Beams front to back per shelf level
- 1 Center Support per shelf level for 69" w. x 30" d. only.

Add-On Units

- 2 Standard Tee Posts (Up to and including 108" high) 168" and 192" are Heavy Duty
- 2 Double Rivet Angle Beams left to right per shelf level
- 2 Double Rivet Angle Beams front to back per shelf level
- 1 Center Support per shelf level for 69" w. x 30" d. only.

Record Storage Units For Use With Steel Box Supports Consist of:

Same as above with the addition of Steel Box Supports in the following quantities.

- 3 pair per 42" wide shelf level
- 5 pair per 69" wide shelf level

* NOTES: Traditional Color is 723 Light Putty, however all standard colors are available. Color selection must be made on the order.

All Unit Catalog Numbers are for Steel Framing only. Order deck material separately.

W	D	H	*	Cat. No.	Price	Per	Wt.	Pkg.
---	---	---	---	----------	-------	-----	-----	------

Tire Storage Racks (for 'standard' tires)

Single-Row, (12" deep units with 9" Wall Ties) and Double-Row, (two 12" deep units separated by 18" Double Row Spacers). Unit depth shown includes wall ties/row spacers. 192" high units are supplied with Heavy Duty Posts.

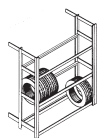

Single Row Starter Units

60	21	84		46351T	185.40	Unit	57.0
60	21	120		46352T	242.00	Unit	76.0
60	21	144		46353T	292.80	Unit	92.6
60	21	192		46354T	383.40	Unit	124.0

Single Row Add-On Units

60	21	84		46451T	150.30	Unit	50.2
60	21	120		46452T	218.30	Unit	71.8
60	21	144		46453T	264.60	Unit	87.6
60	21	192		46454T	379.80	Unit	120.6

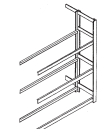

Double Row Starter Units

60	42	84		46355T	355.60	Unit	113.2
60	42	120		46356T	468.80	Unit	151.2
60	42	144		46357T	570.40	Unit	184.4
60	42	192		46358T	751.60	Unit	247.2



Double Row Add-On Units

60	42	84		46455T	293.00	Unit	100.0
60	42	120		46456T	387.00	Unit	135.2
60	42	144		46457T	471.20	Unit	165.2
60	42	192		46458T	693.20	Unit	229.6

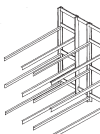

Tire Storage Racks (SUV Tires)

Single Row Starter Units

Accommodates Larger SUV Tires. Single-Row, (15" deep units with 9" Wall Ties) and Double-Row, (two 15" deep units separated by 18" Double Row Spacers) configurations. Unit depth shown includes wall ties/row spacers. 192" high units are supplied with Heavy Duty Posts.

60	24	84		46361TP	189.00	Unit	58.6
60	24	120		46362TP	246.50	Unit	78.0
60	24	144		46363TP	298.20	Unit	95.0
60	24	192		46364TP	389.70	Unit	126.8

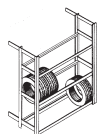

Single Row Add-On Units

60	24	84		46461TP	152.10	Unit	51.0
60	24	120		46462TP	199.55	Unit	68.8
60	24	144		46463TP	242.10	Unit	84.0
60	24	192		46464TP	353.55	Unit	116.4

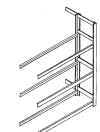

Double Row Starter Units

60	48	84		46655TP	362.80	Unit	116.4
60	48	120		46656TP	477.80	Unit	155.2
60	48	144		46657TP	581.20	Unit	189.2
60	48	192		46658TP	764.20	Unit	252.8



W	D	H	*	Cat. No.	Price	Per	Wt.	Pkg.
---	---	---	---	----------	-------	-----	-----	------

Double Row Add-On Units

60	48	84		46655TP	296.60	Unit	101.6
60	48	120		46456TP	391.50	Unit	137.2
60	48	144		46557TP	476.60	Unit	167.6
60	48	192		46558TP	699.50	Unit	232.4

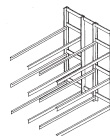

Muffler Storage

Order Deck Material Separately.

5 Shelf Starter Units

48	36	84		46801M	236.40	Unit	80.2
96	36	84		46802M	412.90	Unit	144.2



5 Shelf Add-On Units

48	36	84		46803M	228.70	Unit	78.2
96	36	84		46804M	405.20	Unit	142.2



Tire Storage Rack Unit Tire Capacities

Width	Inches		Number of Tiers	Tire Capacity
	Depth	Height		
Single Row Tire Racks				
60	21	84	3	24
60	21	120	4	32
60	21	144	5	40
60	21	192	6	48
Double Row Tire Racks				
60	42	84	3	48
60	42	120	4	64
60	42	144	5	80
60	42	192	6	96
Tire storage capacities are based on an average passenger size tire.				

Hanging Tailpipe Rack

Designed specifically for the storage of automotive and light truck tailpipes. Stored items are visible and easily accessible.

Starter Unit Only

48	18	120		46901P	188.30	Unit	60.0
96	18	120		46902P	265.20	Unit	87.8

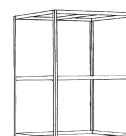

* NOTES: Traditional Color is 723 Light Putty, however all standard colors are available. Color selection must be made on the order.

All Unit Catalog Numbers are for Steel Framing only. Order deck material separately.

W	D	H	*	Cat. No.	Price	Per	Wt.	Pkg.
---	---	---	---	----------	-------	-----	-----	------

W	D	H	*	Cat. No.	Price	Per	Wt.	Pkg.
---	---	---	---	----------	-------	-----	-----	------

How To Order RivetRite COMPONENTS

These pages contain the component parts used to build all RivetRite units. Before designing RivetRite for a specific application, determine the following:

1. The desired shelf size and capacity.
2. The required number of shelves and the spacing between shelves.
3. The post height and capacity needed to support the shelves.
4. The type and capacity of decking material to be used.

Once these decisions have been made, you can select the parts:

5. Select left to right beams and center supports (if required) to carry the load. See Beam Load Tables for capacities. Note that all units require Double Rivet Beams from left to right and from front to back at the top and bottom. Refer to "Design Criteria" and Particle Board Load Chart.

6. Add front to back beams as required. See "Design Criteria".

7. Add the appropriate size, type and quantity and capacity of posts for the application. Check the post capacity by multiplying the number of shelves x average load per shelf. Divide by 4 for Angle Posts; divide by 2 for TEE Posts, then refer to the chart. Determine the largest distance between beams. Check both the left to right and front to back dimension and use the largest distance. Check the capacity by using the appropriate Post Capacity Chart.

8. Add the appropriately sized deck material. Verify that the deck will hold the load (see capacity chart for 5/8" particle board).

9. Double check to see that all beams, deck material and posts have sufficient capacity to hold the anticipated load.

(For information on shelving growth and shelf spacing, refer to the 'Storage Products' catalog).

Angle Posts (Punched on 1-1/2" centers)



Standard, 1-1/2" x 1-1/2"

36	46AS03C	6.45	Ea.	2.1
48	46AS04C	8.55	Ea.	2.8
60	46AS05C	10.80	Ea.	3.4
72	46AS06C	12.85	Ea.	4.1
84	46AS07C	15.10	Ea.	4.8
96	46AS08C	17.00	Ea.	5.5
108	46AS09C	19.25	Ea.	6.1
120	46AS10C	21.30	Ea.	6.8
144	46AS12C	26.05	Ea.	8.2



Heavy Duty, 1-7/8" x 1-7/8"

96	46AH08C	20.15	Ea.	6.7
108	46AH09C	23.35	Ea.	7.5
120	46AH10C	25.80	Ea.	8.3
144	46AH12C	30.75	Ea.	10.1
168	46AH14C	35.75	Ea.	11.6
192	46AH16C	40.75	Ea.	13.3
216	46AH18C	45.65	Ea.	14.9

Tee Posts (Punched on 1-1/2" centers)



Standard, 3" x 1-1/2"

36	46TS03C	12.80	Ea.	3.8
48	46TS04C	16.30	Ea.	5.0
60	46TS05C	19.60	Ea.	6.2
72	46TS06C	22.85	Ea.	7.4
84	46TS07C	26.35	Ea.	8.6
96	46TS08C	29.70	Ea.	9.9
108	46TS09C	32.10	Ea.	11.1
120	46TS10C	36.05	Ea.	12.3
144	46TS12C	43.30	Ea.	14.7

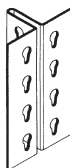

Heavy Duty, 3-3/4" x 1-7/8"

84	46TH07C	36.60	Ea.	11.3
96	46TH08C	41.40	Ea.	12.9
108	46TH09C	44.80	Ea.	14.5
120	46TH10C	49.15	Ea.	16.1
144	46TH12C	58.55	Ea.	19.3
168	46TH14C	74.35	Ea.	22.5
192	46TH16C	85.00	Ea.	25.7
216	46TH18C	95.40	Ea.	29.0

Post Splice

Used to extend post; attaches to outside of post. Order one per Angle Post, two per Tee Post.



1-3/8	1-3/8	5	46PS0H	11.25	Ea.	0.5
-------	-------	---	--------	-------	-----	-----

RivetRite Post Capacity Chart

Recommended safe loads (per post) for use only where seismic forces are not a factor.

Beam Spacing (inches)	Standard Angle Post Capacity (lbs.)	Heavy Duty Angle Post Capacity (lbs.)
12	1530	1735
18	1520	1720
24	1510	1695
30	1490	1680
36	1350	1660
42	990	1560
48	755	1195

Beam Spacing (inches)	Standard Tee Post Capacity (lbs.)	Heavy Duty Tee Post Capacity (lbs.)
12	4725	5045
18	4510	4965
24	4210	4850
30	3825	4705
36	3350	4525
42	2795	4315
48	2180	4075

For beam spacing over 48", please contact Penco.

Post capacities are based on the maximum vertical distance between left to right beams or front to back beams, whichever is greater. In single rivet beam units, the vertical distance between front to back beams will usually govern.

Tie plates must be spaced no more than 48 inches apart to insure structural stability when joining angle posts together.

The above capacities are NOT intended for use when designing multi-level systems or for specific requirements where seismic forces are a factor. For specific multi-level or seismic requirements, contact your Penco District Manager.

W	D	H	*	Cat. No.	Price	Per	Wt.	Pkg.
---	---	---	---	----------	-------	-----	-----	------

W	D	H	*	Cat. No.	Price	Per	Wt.	Pkg.
---	---	---	---	----------	-------	-----	-----	------

Single Rivet Shelf Beams

For use as left to right and front to back shelf support. See Beam Load Table for capacity. Do not mix with any other beam type on the same level. You MUST fully frame each unit with DOUBLE Rivet beams at the top and bottom.

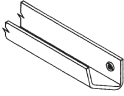
Standard								
	12	1		46SS12C	2.30	Ea.	0.6	
	15	1		46SS15C	3.15	Ea.	0.7	
	18	1		46SS18C	3.30	Ea.	0.9	
	24	1		46SS24C	3.65	Ea.	1.1	
	30	1		46SS30C	4.20	Ea.	1.3	
	36	1		46SS36C	4.95	Ea.	1.6	
	42	1		46SS42C	5.35	Ea.	1.9	
	48	1		46SS48C	5.60	Ea.	2.1	

Heavy Duty

Heavy duty 36" support beam capacity is 600 lbs. per pair. Heavy duty 48" support beam capacity is 500 lbs. per pair.

	36	1-1/4		46HS36C	12.40	Ea.	3.2	
	42	1-1/4		46HS42C	13.50	Ea.	3.7	
	48	1-1/4		46HS48C	14.65	Ea.	4.2	

Double Rivet Angle Beams

2-3/4" h. x 1" d. - For left to right and front to back shelf support. NOTE: "S" is for beams punched to accept Record Storage Box Supports.

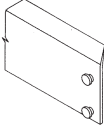
Standard								
	12			46SB12C	4.20	Ea.	0.8	
	15			46SB15C	4.65	Ea.	1.0	
	18			46SB18C	5.00	Ea.	1.2	
	24			46SB24C	5.60	Ea.	1.6	
	30			46SB30C	6.30	Ea.	2.0	
	32			46SB32C	7.00	Ea.	2.2	
	36			46SB36C	7.65	Ea.	2.3	
	42			46SB42C	8.45	Ea.	2.7	
	42		S	46AB42C	9.45	Ea.	2.7	

Heavy Duty

	48			46HB48C	9.95	Ea.	3.8	
	60			46HB60C	11.70	Ea.	4.7	
	69			46HB69C	13.25	Ea.	5.4	
	69		S	46AB69C	15.15	Ea.	5.4	
	72			46HB72C	13.90	Ea.	5.7	
	84			46HB84C	15.95	Ea.	6.6	
	96			46HB96C	18.30	Ea.	7.5	

Double Rivet Channel Beams

3"h. x 1"d. - For left to right shelf support. Provides for a higher capacity than Heavy Duty Double Rivet Angle Beams. NOTE: When a bottom shelf is required to be at the bottom level, use a Heavy Duty Double Rivet Angle Beam.

	60			46CB60C	15.80	Ea.	6.0	
	69			46CB69C	17.75	Ea.	7.0	
	72			46CB72C	18.05	Ea.	7.2	
	84			46CB84C	21.30	Ea.	8.4	
	96			46CB96C	24.20	Ea.	9.6	

RivetRite Beam Capacities

Recommended Safe Use Allowable Uniformly Distributed Hand Loaded Static Beam Loads

Width (in.)	Cap./Pair (lbs.)	Deflection (in.)
Single Rivet Shelf Beams		
Standard Beams		
36	350	0.25
42	300	0.30
48	250	0.34
Heavy Duty Beams		
36	600	0.25
42	550	0.30
48	500	0.34
Double Rivet Angle Beams		
Standard Beams		
Without Center Supports (***)		
36	1000	***
42	780	***
Heavy Duty Beams		
Without Center Supports (***)		
48	750	***
60	600	***
69	525	***
72	500	***
With Center Supports (*)		
48	1400	0.16
60	1200	0.25
69	1050	0.33
72	1000	0.36
84	840	0.49
96	620	0.53
Double Rivet Channel Beams		
With Center Supports (*)		
60	2240	0.23
72	1850	0.33
84	1600	0.45
96	1400	0.59
Double Rivet Zee Step Beams		
Without Center Supports		
48	1250	-
60	750	-
69	600	-
72	600	-
With Center Supports (*)		
48	1750	
60	1000	
69	1000	
72	1000	

(*) One (1) support per pair of beams except 96" which have two (2) Supports

(***) Beam rotation is less than 5 degrees

* S: Beam is punched to accept Record Storage Box Supports.

W	D	H	*	Cat. No.	Price	Per	Wt.	Pkg.
---	---	---	---	----------	-------	-----	-----	------

W	D	H	*	Cat. No.	Price	Per	Wt.	Pkg.
---	---	---	---	----------	-------	-----	-----	------

Center Supports

2-3/4" h. - Bolts to double rivet or channel beams to add support to decking and stabilize beams. Supplied with bolts and wing nuts for fast assembly. Use 1 per pair of beams under 96"; 2 per pair of 96" beams.

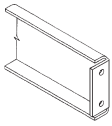

12		46CS12	5.70	Ea.	1.0
15		46CS15	6.25	Ea.	1.2
18		46CS18	6.70	Ea.	1.4
24		46CS24	7.70	Ea.	1.8
30		46CS30	8.60	Ea.	2.2
32		46CS32	9.10	Ea.	2.4
36		46CS36	9.30	Ea.	2.7
42		46CS42	10.70	Ea.	3.1
48		46CS48	12.20	Ea.	3.5

Double Rivet Zee Step Beams

2-1/8" h. - For left to right and front to back shelf support. Lower profile than other double rivet beams allows more useable space between shelf levels.

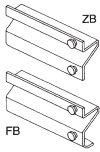

ZB Style Beam

12	-	-	46ZB12C	4.05	Ea.	0.9
15	-	-	46ZB15C	4.60	Ea.	1.1
18	-	-	46ZB18C	5.45	Ea.	1.3
24	-	-	46ZB24C	6.65	Ea.	1.8
30	-	-	46ZB30C	7.75	Ea.	2.2
32	-	-	46ZB32C	8.35	Ea.	2.4
36	-	-	46ZB36C	9.05	Ea.	2.7
42	-	-	46ZB42C	10.20	Ea.	3.1
48	-	-	46ZB48C	11.30	Ea.	3.5
60	-	-	46ZB60C	13.65	Ea.	4.4

FB Style Beam

69	-	-	46FB69C	17.40	Ea.	5.6
72	-	-	46FB72C	17.90	Ea.	5.8

Decking Support For Zee Beams

1-1/8" h. - 11 Gauge. Provides front to back support for decking when used with Zee Step Beams.

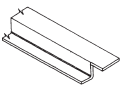

-	24	-	46ZS24C	5.60	Ea.	2.2
-	30	-	46ZS30C	6.50	Ea.	2.8
-	32	-	46ZS32C	6.90	Ea.	3.0
-	36	-	46ZS36C	7.50	Ea.	3.3
-	42	-	46ZS42C	8.45	Ea.	3.9
-	48	-	46ZS48C	9.55	Ea.	4.4

Double Rivet Low-Profile Beams

Intended for use with deck material with minimum thickness of 1/2". Do not mix with any other beam type on the same level. Center supports are NOT available. Can be used at top and bottom of unit.



12		46DB12C	3.40	Ea.	0.4
15		46DB15C	3.50	Ea.	0.6
18		46DB18C	3.75	Ea.	0.7
24		46DB24C	4.45	Ea.	0.9
30		46DB30C	5.20	Ea.	1.2
32		46DB32C	5.40	Ea.	1.3
36		46DB36C	5.85	Ea.	1.4
42		46DB42C	6.45	Ea.	1.7
48		46DB48C	6.75	Ea.	2.0

Low Profile

Double Rivet Beam Capacities

With 5/8" Particle Board Decking, (All 4 Sides Supported)

Shelf Size W x D (in.)	Capacity (lbs.)**
36x12	193
36x15	203
36x18	212
36x24	231
36x30	255
36x32	266
36x36	293
42X12	166
42X15	168
42X18	170
42X24	176
42X30	187
42X32	192
42X36	204
48x12	136
48x15	136
48x18	136
48x24	138
48x30	143
48x32	145
48x36	150
48x42	162
48x48	181

The Low-Profile RivetRite Beam capacities shown here are for all four sides of a shelf deck supported (front and rear, and both sides). All loading calculations are based upon ANSI standard MH 28.2-1996 (L/140)**. The allowable loads shown are uniformly distributed and assume 5/8" thick particle board is the shelf deck material.

Other decking material, such as plywood or steel, may change unit load capacities. For special sizes not listed here, please direct your inquiries to the Shelving Product Managers and include as much detail about the proposed installation as possible.

* Capacities shown are for Evenly Distributed Loads
** L = Length

Tire Rack Beams

2-3/4" h. - For left to right support of tires. 30 degree angle on supporting edge.

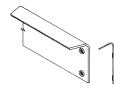

48	46TB48C	10.35	Ea.	3.8
60	46TB60C	11.70	Ea.	4.7

Wall Ties

Used to secure units to wall and provide space between wall and unit. (Hardware to attach to wall not included.)



9-1/4	46WT09C	5.30	Ea.	0.8
-------	----------------	-------------	-----	-----

W	D	H	*	Cat. No.	Price	Per	Wt.	Pkg.
---	---	---	---	----------	-------	-----	-----	------

Double Row And Top Ties

Used to space back-to-back units and to top-tie rows across aisles for added stability.

	9-1/4	46RT09C	5.40	Ea.	0.8
	15-1/4	46RT15C	6.30	Ea.	1.2
	18-1/4	46RT18C	6.80	Ea.	1.4
	36-1/4	46RT36C	8.85	Ea.	2.5

Foot Plate

For use in anchoring angle and tee posts to the floor. Hardware included for attaching to posts. Floor anchor holes are 1/2" diameter. Hardware to anchor to the floor not included - see No. 9280, Concrete Floor Anchor in Wide Span Section.

	4	46FP0H	3.50	Ea.	0.5
---	---	---------------	-------------	-----	-----

Shim

For placement beneath RivetRite posts. Has two 1/2" holes for anchoring. Unpainted, 14 gauge. Accepts anchors Cat.No. 9280 or 9281.

	3-1/2	2	46FPS00Z	2.30	Ea.	0.2
---	-------	---	-----------------	-------------	-----	-----

Record Storage Box Supports

Used in place of particle board decking to support boxes and maintain neat organized storage. Supplied with nylon button fasteners.

	15	46BS15	4.95	Ea.	0.8
	30	46BS30	7.50	Ea.	1.4
	32	46BS32	10.05	Ea.	2.0

Tie Plate

Used to join Angle Post units side by side to insure proper row alignment.

	3	3	46TP00C	6.10	Ea.	0.2
---	---	---	----------------	-------------	-----	-----

W	D	H	*	Cat. No.	Price	Per	Wt.	Pkg.
---	---	---	---	----------	-------	-----	-----	------

Deck Over Grating Supports

3-1/2" h. - Provides secure support for grating when decking over entire installation. Can be used inside or outside upright posts to support decking. Capacity Per Support: 48" 3000, 60" 2500, 72" 2100.

	36	46GS36C	22.20	Ea.	8.8
	42	46GS42C	25.45	Ea.	10.1
	48	46GS48C	27.95	Ea.	11.7
	60	46GS60C	34.25	Ea.	14.6
	69	46GS69C	38.60	Ea.	16.7
	72	46GS72C	40.15	Ea.	17.4

Grating, Galvanized for RivetRite, 16 ga.

Use with Down Aisle Grating Supports. Interlocking grating has male and female flanges that interlock with adjacent planks for a continuous locked surface. Secure to Down Aisle Grating Supports with self tapping-screws. Order separately.

Non-Interlocking

	30	8-7/8	2	8GL030	39.85	Ea.	7.9
	36	8-7/8	2	8GL036	43.15	Ea.	9.4
	42	8-7/8	2	8GL042	49.60	Ea.	10.9
	48	8-7/8	2	8GL048	54.60	Ea.	12.5

Interlocking

	30	8-7/8	2	8AL030	21.30	Ea.	7.9
	36	8-7/8	2	8AL036	25.40	Ea.	9.4
	42	8-7/8	2	8AL042	29.70	Ea.	11.0
	48	8-7/8	2	8AL048	33.95	Ea.	12.6

Grating Fillers

3" w. - Galvanized. Special short length for use with RivetRite Down Aisle Grating Supports.

Galvanized

	30	3	2	8FK030	23.25	Ea.	4.1
	36	3	2	8FK036	25.90	Ea.	5.0
	42	3	2	8FK042	29.65	Ea.	5.8
	48	3	2	8FK048	32.85	Ea.	6.6

Grating and Grating filler are Galvanized so they require no paint



RivetRite Component Parts

W	D	H	*	Cat. No.	Price	Per	Wt.	Pkg.
---	---	---	---	----------	-------	-----	-----	------

W	D	H	*	Cat. No.	Price	Per	Wt.	Pkg.
---	---	---	---	----------	-------	-----	-----	------

Down Aisle Grating Supports

Attaches to unit front between rows to provide support for grating on 2-level RivetRite installations. For maximum aisle width of 48". Use a minimum of 3 screws per support. Capacity per Support: 48"-3000 lbs.; 60"-2500 lbs.; 72"-2100 lbs.

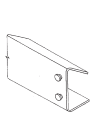

36	3-1/2	46DA36C	22.20	Ea.	8.8
48	3-1/2	46DA48C	27.95	Ea.	11.7
60	3-1/2	46DA60C	34.25	Ea.	14.6
69	3-1/2	46DA69C	38.60	Ea.	16.7
72	3-1/2	46DA72C	40.15	Ea.	17.4

Shelving & Main Aisle Support

To support decking across shelving or main aisle. Spacing between supports not to exceed 48" (formerly called 'Cross Aisle Support').

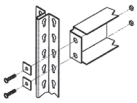

Includes Hardware to bolt to posts

30-1/2	3-1/2	46AX30H	23.75	Ea.	4.5
36-1/2	3-1/2	46AX36H	28.25	Ea.	5.5
42-1/2	3-1/2	46AX42H	32.70	Ea.	6.5
48-1/2	3-1/2	46AX48H	37.10	Ea.	9.5

Flue Spacing Components

To allow nominal 6" spacing between RivetRite Units to satisfy NFPA (Nat'l Fire Protection Agency) recommendations.

Use with RivetRite Posts

Can be used to join tee or angle post units back to back.

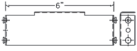

6	46RT06	5.30	Ea.	0.5
---	---------------	-------------	-----	-----

Use with RivetRite Posts, side by side.

6	46AX153	4.90	Ea.	0.4
---	----------------	-------------	-----	-----



Hanger Bars

1-1/4"w. x 1-1/4"h. - For hanging items between double rivet beams. One or more may be used per level.



36	46BH36C	8.85	Ea.	2.7
42	46BH42C	10.35	Ea.	3.1
48	46BH48C	11.55	Ea.	3.6
60	46BH60C	13.45	Ea.	4.4

Beam Cleat

An economical way to add on units. Not recommended for heavy loads.

(LH) Left Hand

3	3	46BC00C	8.20	Ea.	0.2
---	---	----------------	-------------	-----	-----



(RH) Right Hand

3	3	46BC01C	8.20	Ea.	0.2
---	---	----------------	-------------	-----	-----

Slotted Angle Cleat

For use where Heavy Duty Slotted Angle pieces must be joined, such as special grating supports and top ties

(LH) Left Hand

3	46SA00C	9.85	Ea.	0.2
---	----------------	-------------	-----	-----



(RH) Right Hand

3	46SA01C	9.85	Ea.	0.2
---	----------------	-------------	-----	-----

Replacement Hardware

Four Wing Nuts and Four 10-24 x 5/8" TR HD Machine Screws required per Center Support.

Wing Nut For Center Support

8860	0.20	Ea.	0.1
-------------	-------------	-----	-----

TR HD Machine Screw, 10-24 x 5/8"

8704	0.10	Ea.	0.1
-------------	-------------	-----	-----

Particle Board Decking & Capacities



W	D	H *	Cat. No.	Price	Per	Wt.	Pkg.
---	---	-----	----------	-------	-----	-----	------

Particle Board Decking

Particle Board supplied by Penco is classified as 1-Medium Density-1 interior grade. If you are cutting your own board use nominal size & cut to +0" - 1/8".

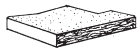

NOTE: Check 5/8" Particle Board Capacity Table in the III. Price Book for the unit you require. Shelf deck capacity may not carry the rating of the steel framing.

36	12	94603	6.00	Ea.	6.6
36	15	94604	7.30	Ea.	8.2
36	18	94605	8.75	Ea.	10.0
36	24	94606	17.65	Ea.	13.0
36	30	94607	23.70	Ea.	16.5
36	36	94608	23.70	Ea.	19.8
42	12	94613	7.85	Ea.	7.7
42	15	94614	10.50	Ea.	9.6
42	18	94615	11.85	Ea.	11.5
42	24	94616	15.90	Ea.	15.4
42	30	94617	23.70	Ea.	19.2
42	36	94618	23.70	Ea.	23.0
48	12	94623	7.85	Ea.	8.8
48	18	94625	11.85	Ea.	13.2
48	24	94626	15.60	Ea.	18.0
48	30	94627	19.60	Ea.	22.0
48	36	94628	23.70	Ea.	26.3
48	48	94629	31.35	Ea.	35.0
60	18	94635	19.60	Ea.	16.5
60	24	94636	19.60	Ea.	22.0
60	30	94637	39.10	Ea.	27.4
60	36	94638	39.10	Ea.	32.9
60	48	94639	39.10	Ea.	43.8
69	15	94644	15.90	Ea.	15.8
69	30	94647	46.95	Ea.	31.5
72	18	94655	23.55	Ea.	19.7
72	24	94656	23.55	Ea.	26.3
72	30	94657	46.95	Ea.	32.9
72	36	94658	46.95	Ea.	39.4
72	48	94659	46.95	Ea.	52.6
96	18	94665	31.35	Ea.	26.3
96	24	94666	31.35	Ea.	35.0
96	30	94667	62.65	Ea.	43.8
96	36	94668	62.65	Ea.	52.6
96	48	94669	62.65	Ea.	70.0

Wire Deck is available for RivetRite as an alternative. Contact your Penco Representative for pricing on your requirements.

Particle Board Capacities

Recommended Safe Use Load Table For 5/8" Particle Board Allowable Uniformly Distributed Static Live Loads For Deck Material

Size (inches)	2 Sides Supported		4 Sides Supported		4 Sides + Center Support		4 Sides + 2 Center Supports	
	Load (lbs.)	Defl. (in.)	Load (lbs.)	Defl. (in.)	Load (lbs.)	Defl. (in.)	Load (lbs.)	Defl. (in.)
36 x 12	425	0.06	675	0.08				
36 x 18	400	0.17	550	0.18				
36 x 24	305	0.30	435	0.23				
36 x 30	250	0.47	385	0.32				
36 x 36	150	0.50	180	0.39				
42 x 12	490	0.06	755	0.08				
42 x 18	460	0.17	600	0.18				
42 x 24	355	0.30	500	0.29				
42 x 30	300	0.47	410	0.36				
42 x 36	175	0.50	385	0.45				
48 x 12	560	0.06	850	0.08	1160	0.08		
48 x 18	525	0.17	635	0.18	770	0.10		
48 x 24	405	0.30	530	0.30	700	0.11		
48 x 30	325	0.47	440	0.40	705	0.12		
48 x 36	200	0.50	400	0.50	755	0.12		
48 x 42	130	0.50	320	0.50	830	0.12		
48 x 48	85	0.50	275	0.50	920	0.13		
60 x 18	660	0.17	735	0.18	835	0.12	1140	0.08
60 x 24	505	0.30	615	0.32	700	0.15	1180	0.10
60 x 30	410	0.47	520	0.46	650	0.16	1324	0.11
60 x 36	250	0.50	380	0.50	665	0.17	1520	0.12
60 x 42	160	0.50	285	0.50	700	0.18	1750	0.13
60 x 48	105	0.50	230	0.50	750	0.18	2000	0.14
69 x 15	900	0.11	950	0.12	1150	0.12	1250	0.11
69 x 30	470	0.50	600	0.50	670	0.20	1220	0.13
72 x 18	800	0.17	850	0.17	1000	0.15	1200	0.10
72 x 24	605	0.30	680	0.31	770	0.19	1135	0.12
72 x 30	500	0.47	610	0.50	680	0.21	1200	0.14
72 x 36	300	0.50	390	0.50	655	0.23	1325	0.16
72 x 42	190	0.50	280	0.50	660	0.24	1500	0.17
72 x 48	130	0.50	215	0.50	685	0.25	1670	0.18
84 x 18	920	0.17	980	0.17	1200	0.17	1325	0.13
84 x 24	705	0.30	765	0.31	870	0.23	1150	0.15
84 x 30	570	0.47	650	0.49	735	0.27	1150	0.18
84 x 36	355	0.50	415	0.50	670	0.29	1210	0.20
84 x 42	225	0.50	290	0.50	750	0.32	1325	0.21
84 x 48	150	0.50	215	0.50	660	0.33	1460	0.23
96 x 18	1050	0.17	1115	0.17	1300	0.18	1500	0.15
96 x 24	810	0.30	850	0.31	1000	0.26	1200	0.18
96 x 30	655	0.47	710	0.48	800	0.32	1180	0.20
96 x 36	405	0.50	450	0.50	710	0.36	1150	0.24
96 x 42	255	0.50	300	0.50	670	0.39	1225	0.25
96 x 48	170	0.50	220	0.50	650	0.41	1325	0.28

NOTE: The above load chart refers to the Deck material only; 5/8" Particle Board type 1-M-1. The allowable shelf load capacity may be reduced due to allowable column and / or beam capacities. Specified allowable deflection limits may also reduce the shelf load capacity.

How to Select Pallet Rack Frames & Beams

Letters A through E refer to the diagram at right.

A. Height: Measure the height of the pallet and pallet load. Add an extra 4" to 6". Total is the required vertical clearance between beams or between floor and bottom of the first beam. (Beam spacing is in 3" increments.)

B. Depth: Measure the depth of the pallet. Pallet should overhang the beams by 3" to 4" front and back. (Example: for a 48" deep pallet use a 42" deep frame).

C. Width: Measure the width of the load and pallet, and use the greater of the two.

Add 3" to 4" between loads, and between loads and upright frames to determine correct beam length. Select beams with a capacity equal to or greater than the total load of each level.

D. Frame Capacity: Add the total of all loads for each bay (exclude the pallets on the floor), and review allowable upright frame loads based on the beam spacing (see chart below). Pick the appropriate capacity Upright in the size you need.

E. A common frame should be used between each of the sections.

Rack Upright Frame Configurations

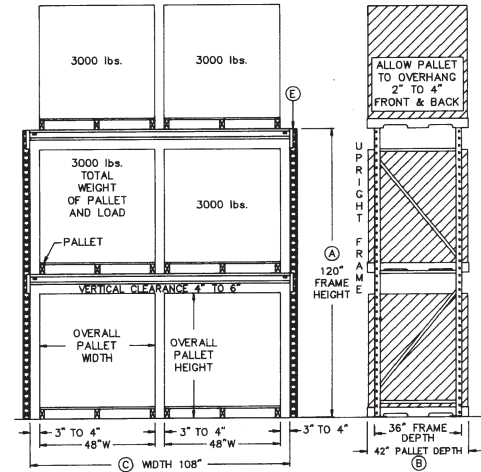
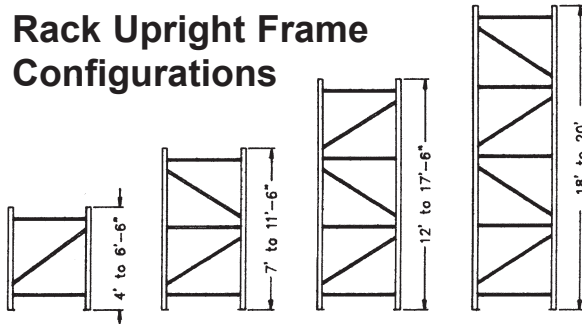

General Information

Anchoring: All pallet rack upright frames shall be anchored to the floor. Anchors are sold separately; see Pallet Rack Accessories.

Beam Capacities are shown per pair, in pounds. The capacity is calculated in compliance with RMI Specifications and AISI Standard. Calculations assume uniform load distribution. Beams of 138" and 144" span require a minimum of two (2) Heavy Duty Cross Bars.

'Traditional' Colors: Frames-028 Gray; Beams-710 Yellow; Accessories-028 Gray except for Frame Protectors (710 Yellow). Any of our standard colors can be ordered.

When ordering accessories, be sure to match the proper accessories with the beam step (either 7/8" or 1-5/8").

Frame Capacities Are calculated in compliance with Rack Manufacturer's Institute (RMI) Specifications and AISI Standard. Load data shown is for preliminary consideration only. Each installation must be individually evaluated for actual conditions and the use of each element in relation to the entire system with all aspects of the structural function. Frame capacities shown here are representative for most areas. In places where seismic activity is known to occur, we advise you to contact your Penco representative for assistance. You may want to order Pallet Rack PLUS instead (see box at right).

PALLET RACK UPRIGHT FRAME CAPACITY CHART

Allowable Upright load in Pounds

FRAME TYPE	Beam Spacing (Inches)											
	24	30	36	42	48	54	60	66	72	78	84	90
F	22,555	21,213	19,853	18,528	16,929	15,381	13,543	11,773	9,824	8,439	7,216	6,336
G	26,512	25,236	23,839	22,311	20,663	18,904	17,025	15,015	12,864	10,774	9,306	8,110
P	32,751	31,227	29,555	27,932	25,965	24,342	21,871	19,203	17,212	14,630	12,540	11,026
R	39,108	37,264	35,464	33,266	30,891	28,339	25,934	23,043	19,959	17,245	14,796	12,834
T	45,629	43,478	41,102	38,503	35,715	32,703	29,897	26,489	22,875	19,432	16,713	14,527

Pallet Rack PLUS

For Severe Conditions or High Seismic Activity

Pallet Rack Plus load capacities are the same as standard pallet rack shown in this price book, however the frames and beams are more resistant to horizontal and vertical forces that could damage standard rack and its load. To learn the seismic rating where your pallet rack will be in use, contact your Penco representative.

Beams: The Plus beams have 4 connectors

instead of 3 for a stronger connection between the beam and the upright post. The beam is welded 3" down from the top of the connector so loading is evenly distributed across all four connector prongs.

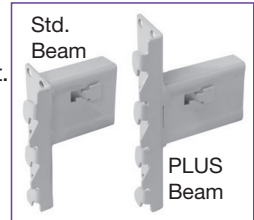

The beam locking key is the same as used on standard beams.

To Order PLUS BEAMS: ADD A "P" SUFFIX TO THE PART NUMBER, ADD \$25.00 TO THE PRICE/PAIR AND ADD 3 LBS TO THE WEIGHT per PAIR.

Upright Frames: Each Plus upright frame

has two 5" x 7" x 3/8" thick footplates with four 9/16" diameter anchoring holes. The extra holes provide the installer with more choices for floor anchoring.

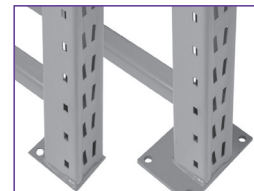

To Order PLUS FRAMES: REPLACE THE 'C' PART NUMBER SUFFIX WITH A "PC" SUFFIX, ADD \$50.00 TO THE PRICE AND 6 LBS TO THE WEIGHT.

Other Options Penco also manufactures Double Posted Frames and Cantilever Leg Frames to RMI, ANSI and other custom requirements. Contact your Sales Representative for pricing.

Standard Pallet Rack Upright Frames



Frame Type F

3" wide x 1-3/4" deep Post - 14 Gauge

D	H	Cat. No.	Price	Wt.	D	H	Cat. No.	Price	Wt.	D	H	Cat. No.	Price	Wt.	D	H	Cat. No.	Price	Wt.
30	48	5FB048C	74.05	25.0	30	102	5FB102C	139.05	47.0	30	156	5FB156C	214.80	72.0	30	210	5FB210C	282.65	94.0
36	48	5FE048C	77.70	26.0	36	102	5FE102C	145.15	49.0	36	156	5FE156C	219.80	74.0	36	210	5FE210C	287.65	95.0
42	48	5FH048C	81.60	27.0	42	102	5FH102C	151.40	52.0	42	156	5FH156C	229.00	79.0	42	210	5FH210C	296.55	99.0
48	48	5FL048C	85.25	29.0	48	102	5FL102C	157.40	55.0	48	156	5FL156C	237.80	81.0	48	210	5FL210C	303.05	101.0
54	48	5FP048C	88.25	30.0	54	102	5FP102C	161.50	56.0	54	156	5FP156C	246.20	86.0	54	210	5FP210C	310.05	104.0
60	48	5FS048C	91.70	32.0	60	102	5FS102C	167.25	59.0	60	156	5FS156C	251.95	87.0	60	210	5FS210C	315.05	106.0
30	54	5FB054C	79.60	26.0	30	108	5FB108C	149.40	51.0	30	162	5FB162C	219.80	74.0	30	216	5FB216C	298.60	98.0
36	54	5FE054C	83.10	27.0	36	108	5FE108C	153.00	52.0	36	162	5FE162C	225.35	76.0	36	216	5FE216C	305.25	100.0
42	54	5FH054C	86.95	29.0	42	108	5FH108C	159.10	55.0	42	162	5FH162C	234.55	71.0	42	216	5FH216C	316.90	104.0
48	54	5FL054C	90.70	31.0	48	108	5FL108C	165.30	57.0	48	162	5FL162C	243.55	82.0	48	216	5FL216C	328.45	109.0
54	54	5FP054C	93.15	32.0	54	108	5FP108C	172.00	60.0	54	162	5FP162C	252.25	87.0	54	216	5FP216C	339.95	113.0
60	54	5FS054C	98.45	34.0	60	108	5FS108C	175.70	61.0	60	162	5FS162C	257.45	89.0	60	216	5FS216C	345.65	117.0
30	60	5FB060C	86.95	29.0	30	114	5FB114C	154.60	53.0	30	168	5FB168C	225.50	76.0	30	222	5FB222C	301.60	100.0
36	60	5FE060C	90.05	30.0	36	114	5FE114C	158.40	54.0	36	168	5FE168C	231.05	78.0	36	222	5FE222C	305.25	102.0
42	60	5FH060C	99.05	32.0	42	114	5FH114C	164.45	57.0	42	168	5FH168C	239.90	82.0	42	222	5FH222C	319.25	106.0
48	60	5FL060C	97.75	33.0	48	114	5FL114C	170.80	59.0	48	168	5FL168C	248.55	84.0	48	222	5FL222C	330.65	111.0
54	60	5FP060C	101.35	35.0	54	114	5FP114C	177.05	62.0	54	168	5FP168C	258.20	89.0	54	222	5FP222C	342.40	116.0
60	60	5FS060C	106.65	35.0	60	114	5FS114C	180.70	63.0	60	168	5FS168C	263.00	91.0	60	222	5FS222C	347.40	118.0
30	66	5FB066C	92.90	31.0	30	120	5FB120C	160.20	54.0	30	174	5FB174C	233.10	78.0	30	228	5FB228C	307.45	101.0
36	66	5FE066C	95.30	32.0	36	120	5FE120C	163.30	56.0	36	174	5FE174C	238.30	80.0	36	228	5FE228C	313.55	104.0
42	66	5FH066C	103.35	34.0	42	120	5FH120C	170.05	59.0	42	174	5FH174C	247.55	84.0	42	228	5FH228C	325.50	108.0
48	66	5FL066C	103.15	35.0	48	120	5FL120C	175.90	60.0	48	174	5FL174C	256.70	86.0	48	228	5FL228C	336.70	112.0
54	66	5FP066C	106.65	36.0	54	120	5FP120C	182.80	63.0	54	174	5FP174C	265.65	90.0	54	228	5FP228C	348.30	118.0
60	66	5FS066C	109.50	37.0	60	120	5FS120C	186.15	65.0	60	174	5FS174C	271.00	92.0	60	228	5FS228C	353.30	120.0
30	72	5FB072C	100.85	33.0	30	126	5FB126C	172.55	56.0	30	180	5FB180C	239.35	80.0	30	234	5FB234C	313.55	103.0
36	72	5FE072C	103.80	34.0	36	126	5FE126C	176.60	58.0	36	180	5FE180C	244.65	82.0	36	234	5FE234C	319.85	106.0
42	72	5FH072C	107.20	35.0	42	126	5FH126C	183.85	61.0	42	180	5FH180C	253.60	86.0	42	234	5FH234C	331.70	110.0
48	72	5FL072C	109.30	36.0	48	126	5FL126C	189.45	62.0	48	180	5FL180C	262.35	88.0	48	234	5FL234C	342.80	115.0
54	72	5FP072C	113.40	38.0	54	126	5FP126C	196.30	65.0	54	180	5FP180C	271.75	92.0	54	234	5FP234C	354.80	120.0
60	72	5FS072C	117.20	39.0	60	126	5FS126C	200.60	68.0	60	180	5FS180C	276.70	95.0	60	234	5FS234C	359.80	122.0
30	78	5FB078C	108.95	34.0	30	132	5FB132C	183.85	58.0	30	186	5FB186C	245.35	81.0	30	240	5FB240C	319.65	105.0
36	78	5FE078C	111.85	35.0	36	132	5FE132C	187.60	59.0	36	186	5FE186C	250.65	83.0	36	240	5FE240C	325.85	107.0
42	78	5FH078C	115.70	37.0	42	132	5FH132C	193.35	63.0	42	186	5FH186C	259.15	88.0	42	240	5FH240C	337.65	112.0
48	78	5FL078C	118.35	38.0	48	132	5FL132C	199.05	64.0	48	186	5FL186C	268.45	90.0	48	240	5FL240C	349.20	117.0
54	78	5FP078C	122.70	40.0	54	132	5FP132C	204.35	68.0	54	186	5FP186C	277.25	95.0	54	240	5FP240C	360.70	121.0
60	78	5FS078C	126.50	42.0	60	132	5FS132C	208.40	69.0	60	186	5FS186C	282.65	97.0	60	240	5FS240C	365.70	123.0
30	84	5FB084C	126.10	42.0	30	138	5FB138C	189.30	60.0	30	192	5FB192C	255.75	85.0	30	246	5FB246C	323.65	106.0
36	84	5FE084C	130.40	43.0	36	138	5FE138C	193.05	61.0	36	192	5FE192C	260.90	87.0	36	246	5FE246C	329.85	108.0
42	84	5FH084C	136.35	46.0	42	138	5FH138C	199.60	64.0	42	192	5FH192C	269.15	91.0	42	246	5FH246C	341.70	112.0
48	84	5FL084C	140.40	50.0	48	138	5FL138C	204.55	66.0	48	192	5FL192C	278.75	94.0	48	246	5FL246C	353.60	116.0
54	84	5FP084C	146.55	51.0	54	138	5FP138C	209.90	70.0	54	192	5FP192C	284.95	97.0	54	246	5FP246C	365.50	120.0
60	84	5FS084C	153.00	54.0	60	138	5FS138C	213.90	71.0	60	192	5FS192C	293.35	100.0	60	246	5FS246C	377.40	124.0
30	90	5FB090C	129.10	44.0	30	144	5FB144C	199.60	65.0	30	198	5FB198C	261.70	87.0	30	252	5FB252C	335.65	107.0
36	90	5FE090C	135.35	45.0	36	144	5FE144C	208.50	68.0	36	198	5FE198C	266.55	89.0	36	252	5FE252C	341.85	109.0
42	90	5FH090C	142.20	48.0	42	144	5FH144C	215.90	73.0	42	198	5FH198C	275.70	92.0	42	252	5FH252C	353.70	113.0
48	90	5FL090C	148.20	51.0	48	144	5FL144C	226.45	77.0	48	198	5FL198C	284.70	97.0	48	252	5FL252C	365.60	117.0
54	90	5FP090C	152.45	53.0	54	144	5FP144C	232.30	79.0	54	198	5FP198C	291.40	99.0	54	252	5FP252C	377.50	121.0
60	90	5FS090C	158.40	56.0	60	144	5FS144C	241.15	83.0	60	198	5FS198C	297.20	102.0	60	252	5FS252C	389.40	125.0
30	96	5FB096C	134.55	46.0	30	150	5FB150C	201.70	68.0	30	204	5FB204C	272.10	91.0	30	258	5FB258C	347.65	108.0
36	96	5FE096C	141.20	47.0	36	150	5FE150C	210.45	70.0	36	204	5FE204C	277.75	94.0	36	258	5FE258C	353.85	110.0
42	96	5FH096C	147.05	50.0	42	150	5FH150C	219.55	75.0	42	204	5FH204C	286.65	97.0	42	258	5FH258C	365.70	114.0
48	96	5FL096C	152.60	53.0	48	150	5FL150C	228.75	79.0	48	204	5FL204C	293.35	99.0	48	258	5FL258C	377.60	118.0
54	96	5FP096C	157.00	55.0	54	150	5FP150C	233.55	81.0	54	204	5FP204C	298.20	102.0	54	258	5FP258C	389.50	122.0
60	96	5FS096C	163.30	58.0	60	150	5FS150C	242.75	85.0	60	204	5FS204C	303.70	104.0	60	258	5FS258C	401.40	126.0

See Pallet Rack Upright Frame Capacity Chart for frame capacity at various beam spacing



Standard Pallet Rack Upright Frames

Frame Type G 3" wide x 2-1/4" deep Post - 14 Gauge

D	H	Cat. No.	Price	Wt.	D	H	Cat. No.	Price	Wt.	D	H	Cat. No.	Price	Wt.	D	H	Cat. No.	Price	Wt.
30	48	5GB048C	79.10	27.0	30	102	5GB102C	148.60	52.0	30	156	5GB156C	230.15	79.0	30	210	5GB210C	305.60	102.0
36	48	5GE048C	82.65	28.0	36	102	5GE102C	154.40	53.0	36	156	5GE156C	235.35	81.0	36	210	5GE210C	310.05	104.0
42	48	5GH048C	86.40	29.0	42	102	5GH102C	160.60	56.0	42	156	5GH156C	244.15	85.0	42	210	5GH210C	317.40	108.0
48	48	5GL048C	90.15	31.0	48	102	5GL102C	166.85	59.0	48	156	5GL156C	253.00	87.0	48	210	5GL210C	325.50	110.0
54	48	5GP048C	92.65	32.0	54	102	5GP102C	170.80	61.0	54	156	5GP156C	262.35	92.0	54	210	5GP210C	332.75	113.0
60	48	5GS048C	96.25	34.0	60	102	5GS102C	177.05	64.0	60	156	5GS156C	267.10	95.0	60	210	5GS210C	336.90	115.0
30	54	5GB054C	85.05	29.0	30	108	5GB108C	159.40	55.0	30	162	5GB162C	236.45	81.0	30	216	5GB216C	321.15	107.0
36	54	5GE054C	89.00	30.0	36	108	5GE108C	163.30	57.0	36	162	5GE162C	241.65	83.0	36	216	5GE216C	327.85	109.0
42	54	5GH054C	92.65	31.0	42	108	5GH108C	169.75	60.0	42	162	5GH162C	250.65	85.0	42	216	5GH216C	339.60	114.0
48	54	5GL054C	96.25	33.0	48	108	5GL108C	175.70	61.0	48	162	5GL162C	259.15	89.0	48	216	5GL216C	351.50	119.0
54	54	5GP054C	98.60	34.0	54	108	5GP108C	182.10	64.0	54	162	5GP162C	268.45	95.0	54	216	5GP216C	362.70	123.0
60	54	5GS054C	102.95	36.0	60	108	5GS108C	185.20	66.0	60	162	5GS162C	273.35	97.0	60	216	5GS216C	369.30	126.0
30	60	5GB060C	93.15	32.0	30	114	5GB114C	165.05	57.0	30	168	5GB168C	242.65	83.0	30	222	5GB222C	326.25	109.0
36	60	5GE060C	96.25	33.0	36	114	5GE114C	169.40	59.0	36	168	5GE168C	247.55	85.0	36	222	5GE222C	329.40	111.0
42	60	5GH060C	99.05	34.0	42	114	5GH114C	175.70	62.0	42	168	5GH168C	256.40	89.0	42	222	5GH222C	340.75	116.0
48	60	5GL060C	103.80	35.0	48	114	5GL114C	185.20	63.0	48	168	5GL168C	265.65	91.0	48	222	5GL222C	351.90	121.0
54	60	5GP060C	107.20	37.0	54	114	5GP114C	186.80	66.0	54	168	5GP168C	274.35	97.0	54	222	5GP222C	363.40	125.0
60	60	5GS060C	112.40	38.0	60	114	5GS114C	191.05	69.0	60	168	5GS168C	279.55	99.0	60	222	5GS222C	369.30	126.0
30	66	5GB066C	100.45	34.0	30	120	5GB120C	171.05	59.0	30	174	5GB174C	243.70	85.0	30	228	5GB228C	329.50	111.0
36	66	5GE066C	102.35	35.0	36	120	5GE120C	174.75	61.0	36	174	5GE174C	248.55	87.0	36	228	5GE228C	331.50	114.0
42	66	5GH066C	106.10	36.0	42	120	5GH120C	180.70	64.0	42	174	5GH174C	257.45	92.0	42	228	5GH228C	347.35	119.0
48	66	5GL066C	109.50	37.0	48	120	5GL120C	187.10	65.0	48	174	5GL174C	266.40	94.0	48	228	5GL228C	358.85	123.0
54	66	5GP066C	113.40	39.0	54	120	5GP120C	193.15	69.0	54	174	5GP174C	275.20	99.0	54	228	5GP228C	374.40	128.0
60	66	5GS066C	124.50	40.0	60	120	5GS120C	197.15	71.0	60	174	5GS174C	279.55	101.0	60	228	5GS228C	379.30	129.0
30	72	5GB072C	108.55	36.0	30	126	5GB126C	185.20	62.0	30	180	5GB180C	250.25	87.0	30	234	5GB234C	336.15	113.0
36	72	5GE072C	110.80	37.0	36	126	5GE126C	189.30	63.0	36	180	5GE180C	255.60	89.0	36	234	5GE234C	342.40	116.0
42	72	5GH072C	114.60	38.0	42	126	5GH126C	195.60	66.0	42	180	5GH180C	264.00	95.0	42	234	5GH234C	354.45	121.0
48	72	5GL072C	117.20	39.0	48	126	5GL126C	202.40	68.0	48	180	5GL180C	272.45	97.0	48	234	5GL234C	365.20	125.0
54	72	5GP072C	121.10	42.0	54	126	5GP126C	208.60	72.0	54	180	5GP180C	281.75	101.0	54	234	5GP234C	376.90	130.0
60	72	5GS072C	123.90	43.0	60	126	5GS126C	212.50	73.0	60	180	5GS180C	286.30	103.0	60	234	5GS234C	381.80	131.0
30	78	5GB078C	117.20	38.0	30	132	5GB132C	196.75	64.0	30	186	5GB186C	256.40	89.0	30	240	5GB240C	342.65	116.0
36	78	5GE078C	119.90	39.0	36	132	5GE132C	200.40	65.0	36	186	5GE186C	261.15	91.0	36	240	5GE240C	349.20	118.0
42	78	5GH078C	123.90	40.0	42	132	5GH132C	206.60	69.0	42	186	5GH186C	270.25	97.0	42	240	5GH240C	361.00	123.0
48	78	5GL078C	126.50	42.0	48	132	5GL132C	212.00	71.0	48	186	5GL186C	278.75	99.0	48	240	5GL240C	372.25	127.0
54	78	5GP078C	130.55	44.0	54	132	5GP132C	217.40	74.0	54	186	5GP186C	287.90	103.0	54	240	5GP240C	383.85	132.0
60	78	5GS078C	134.30	45.0	60	132	5GS132C	223.75	75.0	60	186	5GS186C	292.50	105.0	60	240	5GS240C	389.30	133.0
30	84	5GB084C	132.70	45.0	30	138	5GB138C	202.85	66.0	30	192	5GB192C	267.10	94.0	30	246	5GB246C	348.15	117.0
36	84	5GE084C	139.05	47.0	36	138	5GE138C	206.60	67.0	36	192	5GE192C	272.10	96.0	36	246	5GE246C	354.90	119.0
42	84	5GH084C	145.15	50.0	42	138	5GH138C	213.05	71.0	42	192	5GH192C	280.95	100.0	42	246	5GH246C	366.15	124.0
48	84	5GL084C	151.75	52.0	48	138	5GL138C	218.45	74.0	48	192	5GL192C	289.75	102.0	48	246	5GL246C	377.40	127.0
54	84	5GP084C	155.40	54.0	54	138	5GP138C	222.45	76.0	54	192	5GP192C	296.15	105.0	54	246	5GP246C	388.65	131.0
60	84	5GS084C	161.90	58.0	60	138	5GS138C	227.35	77.0	60	192	5GS192C	303.45	110.0	60	246	5GS246C	394.10	132.0
30	90	5GB090C	138.75	48.0	30	144	5GB144C	214.00	73.0	30	198	5GB198C	282.65	97.0	30	252	5GB252C	354.15	120.0
36	90	5GE090C	144.80	49.0	36	144	5GE144C	222.45	74.0	36	198	5GE198C	287.65	98.0	36	252	5GE252C	360.90	122.0
42	90	5GH090C	151.25	52.0	42	144	5GH144C	231.80	79.0	42	198	5GH198C	296.55	102.0	42	252	5GH252C	372.15	126.0
48	90	5GL090C	157.00	55.0	48	144	5GL144C	240.70	83.0	48	198	5GL198C	306.95	105.0	48	252	5GL252C	383.40	130.0
54	90	5GP090C	161.35	57.0	54	144	5GP144C	246.05	85.0	54	198	5GP198C	312.35	108.0	54	252	5GP252C	394.65	134.0
60	90	5GS090C	167.45	60.0	60	144	5GS144C	255.05	89.0	60	198	5GS198C	320.20	110.0	60	252	5GS252C	405.90	138.0
30	96	5GB096C	144.50	50.0	30	150	5GB150C	216.55	75.0	30	204	5GB204C	293.65	100.0	30	258	5GB258C	360.15	121.0
36	96	5GE096C	150.50	51.0	36	150	5GE150C	225.35	77.0	36	204	5GE204C	299.40	102.0	36	258	5GE258C	366.90	123.0
42	96	5GH096C	156.80	54.0	42	150	5GH150C	234.10	81.0	42	204	5GH204C	308.05	105.0	42	258	5GH258C	378.15	127.0
48	96	5GL096C	163.30	57.0	48	150	5GL150C	243.25	85.0	48	204	5GL204C	314.45	108.0	48	258	5GL258C	389.40	131.0
54	96	5GP096C	167.25	59.0	54	150	5GP150C	248.25	87.0	54	204	5GP204C	321.00	111.0	54	258	5GP258C	400.65	135.0
60	96	5GS096C	173.55	62.0	60	150	5GS150C	256.90	91.0	60	204	5GS204C	326.25	113.0	60	258	5GS258C	411.90	139.0

See Pallet Rack Upright Frame Capacity Chart for frame capacity at various beam spacing

Standard Pallet Rack Upright Frames



Frame Type P 3" wide x 3" deep Post - 14 Gauge

D	H	Cat. No.	Price	Wt.	D	H	Cat. No.	Price	Wt.	D	H	Cat. No.	Price	Wt.	D	H	Cat. No.	Price	Wt.
30	48	5PB048C	86.40	30.0	30	102	5PB102C	164.05	58.0	30	156	5PB156C	253.45	89.0	30	210	5PB210C	340.65	117.0
36	48	5PE048C	90.05	31.0	36	102	5PE102C	169.90	60.0	36	156	5PE156C	258.50	91.0	36	210	5PE210C	341.70	119.0
42	48	5PH048C	93.75	32.0	42	102	5PH102C	176.25	63.0	42	156	5PH156C	267.80	96.0	42	210	5PH210C	350.60	122.0
48	48	5PL048C	98.05	34.0	48	102	5PL102C	182.80	66.0	48	156	5PL156C	276.45	98.0	48	210	5PL210C	357.00	125.0
54	48	5PP048C	100.35	35.0	54	102	5PP102C	186.80	68.0	54	156	5PP156C	285.35	103.0	54	210	5PP210C	363.40	127.0
60	48	5PS048C	103.80	37.0	60	102	5PS102C	192.70	71.0	60	156	5PS156C	290.80	105.0	60	210	5PS210C	368.60	129.0
30	54	5PB054C	93.05	32.0	30	108	5PB108C	175.70	62.0	30	162	5PB162C	260.65	92.0	30	216	5PB216C	353.80	122.0
36	54	5PE054C	97.05	33.0	36	108	5PE108C	179.65	64.0	36	162	5PE162C	265.80	94.0	36	216	5PE216C	360.70	124.0
42	54	5PH054C	98.60	35.0	42	108	5PH108C	185.45	68.0	42	162	5PH162C	274.45	99.0	42	216	5PH216C	372.55	128.0
48	54	5PL054C	104.20	37.0	48	108	5PL108C	192.05	69.0	48	162	5PL162C	283.40	101.0	48	216	5PL216C	382.90	133.0
54	54	5PP054C	106.95	38.0	54	108	5PP108C	197.80	72.0	54	162	5PP162C	292.00	105.0	54	216	5PP216C	395.15	137.0
60	54	5PS054C	113.30	39.0	60	108	5PS108C	202.05	74.0	60	162	5PS162C	298.20	107.0	60	216	5PS216C	401.30	139.0
30	60	5PB060C	102.95	35.0	30	114	5PB114C	182.75	65.0	30	168	5PB168C	267.80	92.0	30	222	5PB222C	355.50	125.0
36	60	5PE060C	104.50	36.0	36	114	5PE114C	186.15	66.0	36	168	5PE168C	271.90	94.0	36	222	5PE222C	362.60	128.0
42	60	5PH060C	109.30	38.0	42	114	5PH114C	192.70	70.0	42	168	5PH168C	281.75	101.0	42	222	5PH222C	373.75	132.0
48	60	5PL060C	112.75	39.0	48	114	5PL114C	198.55	72.0	48	168	5PL168C	289.75	103.0	48	222	5PL222C	385.70	136.0
54	60	5PP060C	116.65	42.0	54	114	5PP114C	204.55	75.0	54	168	5PP168C	299.05	108.0	54	222	5PP222C	397.05	140.0
60	60	5PS060C	118.70	43.0	60	114	5PS114C	208.50	76.0	60	168	5PS168C	304.30	109.0					
30	66	5PB066C	111.40	38.0	30	120	5PB120C	189.45	68.0	30	174	5PB174C	275.30	97.0	30	228	5PB228C	363.90	128.0
36	66	5PE066C	112.40	39.0	36	120	5PE120C	193.05	69.0	36	174	5PE174C	280.35	99.0	36	228	5PE228C	369.95	130.0
42	66	5PH066C	116.25	42.0	42	120	5PH120C	199.05	73.0	42	174	5PH174C	289.25	104.0	42	228	5PH228C	381.80	134.0
48	66	5PL066C	119.65	43.0	48	120	5PL120C	204.95	74.0	48	174	5PL174C	297.55	106.0	48	228	5PL228C	393.05	139.0
54	66	5PP066C	123.35	44.0	54	120	5PP120C	211.35	77.0	54	174	5PP174C	306.95	110.0	54	228	5PP228C	405.05	143.0
60	66	5PS066C	125.80	45.0	60	120	5PS120C	215.05	78.0	60	174	5PS174C	311.95	112.0					
30	72	5PB072C	118.70	40.0	30	126	5PB126C	203.70	70.0	30	180	5PB180C	277.25	100.0	30	234	5PB234C	371.85	130.0
36	72	5PE072C	121.50	42.0	36	126	5PE126C	207.40	72.0	36	180	5PE180C	282.40	102.0	36	234	5PE234C	378.35	132.0
42	72	5PH072C	125.30	44.0	42	126	5PH126C	213.50	75.0	42	180	5PH180C	291.10	106.0	42	234	5PH234C	389.20	137.0
48	72	5PL072C	127.30	45.0	48	126	5PL126C	219.80	76.0	48	180	5PL180C	299.75	108.0	48	234	5PL234C	400.60	141.0
54	72	5PP072C	131.70	47.0	54	126	5PP126C	226.45	79.0	54	180	5PP180C	308.55	112.0	54	234	5PP234C	412.55	146.0
60	72	5PS072C	135.65	48.0	60	126	5PS126C	230.50	81.0	60	180	5PS180C	313.55	114.0					
30	78	5PB078C	126.65	44.0	30	132	5PB132C	215.80	73.0	30	186	5PB186C	284.20	102.0	30	240	5PB240C	379.10	131.0
36	78	5PE078C	131.40	45.0	36	132	5PE132C	219.30	74.0	36	186	5PE186C	289.25	104.0	36	240	5PE240C	385.15	135.0
42	78	5PH078C	135.00	46.0	42	132	5PH132C	225.35	77.0	42	186	5PH186C	297.55	109.0	42	240	5PH240C	397.05	139.0
48	78	5PL078C	138.15	47.0	48	132	5PL132C	230.75	79.0	48	186	5PL186C	312.70	110.0	48	240	5PL240C	408.00	144.0
54	78	5PP078C	141.45	49.0	54	132	5PP132C	236.45	79.0	54	186	5PP186C	315.40	116.0	54	240	5PP240C	419.90	148.0
60	78	5PS078C	145.65	50.0	60	132	5PS132C	239.90	83.0	60	186	5PS186C	320.85	118.0					
30	84	5PB084C	145.15	51.0	30	138	5PB138C	223.00	75.0	30	192	5PB192C	294.05	106.0					
36	84	5PE084C	151.75	52.0	36	138	5PE138C	226.45	77.0	36	192	5PE192C	301.60	108.0					
42	84	5PH084C	157.90	55.0	42	138	5PH138C	232.70	80.0	42	192	5PH192C	310.05	113.0					
48	84	5PL084C	164.05	58.0	48	138	5PL138C	238.10	81.0	48	192	5PL192C	316.90	115.0					
54	84	5PP084C	167.45	60.0	54	138	5PP138C	243.55	84.0	54	192	5PP192C	324.70	118.0					
60	84	5PS084C	173.55	63.0	60	138	5PS138C	246.50	86.0	60	192	5PS192C	332.35	122.0					
30	90	5PB090C	152.05	53.0	30	144	5PB144C	234.55	82.0	30	198	5PB198C	312.35	109.0					
36	90	5PE090C	158.00	55.0	36	144	5PE144C	243.95	84.0	36	198	5PE198C	317.40	111.0					
42	90	5PH090C	164.35	58.0	42	144	5PH144C	252.20	89.0	42	198	5PH198C	326.70	114.0					
48	90	5PL090C	170.70	61.0	48	144	5PL144C	260.55	93.0	48	198	5PL198C	335.50	118.0					
54	90	5PP090C	174.35	62.0	54	144	5PP144C	267.30	95.0	54	198	5PP198C	340.65	121.0					
60	90	5PS090C	180.70	65.0	60	144	5PS144C	274.75	100.0	60	198	5PS198C	349.50	124.0					
30	96	5PB096C	158.55	56.0	30	150	5PB150C	239.25	84.0	30	204	5PB204C	324.30	114.0					
36	96	5PE096C	165.25	57.0	36	150	5PE150C	240.60	86.0	36	204	5PE204C	329.75	116.0					
42	96	5PH096C	170.80	60.0	42	150	5PH150C	248.25	90.0	42	204	5PH204C	338.55	119.0					
48	96	5PL096C	176.45	63.0	48	150	5PL150C	265.65	96.0	48	204	5PL204C	345.15	123.0					
54	96	5PP096C	180.90	65.0	54	150	5PP150C	271.00	98.0	54	204	5PP204C	351.50	125.0					
60	96	5PS096C	187.35	69.0	60	150	5PS150C	279.90	102.0	60	204	5PS204C	357.00	127.0					

See Pallet Rack Upright Frame Capacity Chart for frame capacity at various beam spacing



Standard Pallet Rack Upright Frames

Frame Type R 3" wide x 3" deep Post - 13 Gauge

D	H	Cat. No.	Price	Wt.	D	H	Cat. No.	Price	Wt.	D	H	Cat. No.	Price	Wt.	D	H	Cat. No.	Price	Wt.
30	48	5RB048C	93.15	33.0	30	102	5RB102C	178.65	66.0	30	156	5RB156C	277.25	101.0	30	210	5RB210C	381.90	133.0
36	48	5RE048C	97.05	34.0	36	102	5RE102C	184.80	68.0	36	156	5RE156C	282.40	103.0	36	210	5RE210C	387.40	135.0
42	48	5RH048C	100.85	36.0	42	102	5RH102C	191.05	71.0	42	156	5RH156C	291.10	108.0	42	210	5RH210C	396.85	138.0
48	48	5RL048C	104.50	38.0	48	102	5RL102C	197.15	74.0	48	156	5RL156C	300.15	110.0	48	210	5RL210C	404.15	140.0
54	48	5RP048C	107.05	39.0	54	102	5RP102C	200.95	76.0	54	156	5RP156C	309.00	115.0	54	210	5RP210C	410.30	143.0
60	48	5RS048C	111.00	42.0	60	102	5RS102C	207.65	79.0	60	156	5RS156C	319.85	117.0	60	210	5RS210C	415.60	146.0
30	54	5RB054C	100.85	36.0	30	108	5RB108C	191.70	70.0	30	162	5RB162C	284.70	104.0	30	216	5RB216C	401.50	138.0
36	54	5RE054C	105.05	37.0	36	108	5RE108C	195.15	72.0	36	162	5RE162C	289.85	106.0	36	216	5RE216C	408.00	140.0
42	54	5RH054C	108.35	39.0	42	108	5RH108C	201.90	75.0	42	162	5RH162C	299.40	111.0	42	216	5RH216C	420.10	146.0
48	54	5RL054C	112.40	42.0	48	108	5RL108C	207.65	76.0	48	162	5RL162C	307.70	113.0	48	216	5RL216C	432.75	150.0
54	54	5RP054C	115.25	43.0	54	108	5RP108C	213.90	79.0	54	162	5RP162C	317.10	118.0	54	216	5RP216C	444.60	157.0
60	54	5RS054C	118.70	44.0	60	108	5RS108C	217.70	81.0	60	162	5RS162C	322.40	120.0	60	216	5RS216C	451.30	159.0
30	60	5RB060C	111.10	40.0	30	114	5RB114C	199.30	74.0	30	168	5RB168C	292.75	107.0	30	222	5RB222C	405.05	146.0
36	60	5RE060C	113.70	42.0	36	114	5RE114C	203.00	75.0	36	168	5RE168C	298.00	109.0	36	222	5RE222C	411.65	143.0
42	60	5RH060C	117.00	44.0	42	114	5RH114C	209.20	79.0	42	168	5RH168C	306.95	114.0	42	222	5RH222C	423.45	146.0
48	60	5RL060C	121.15	45.0	48	114	5RL114C	215.40	80.0	48	168	5RL168C	315.50	116.0	48	222	5RL222C	435.00	153.0
54	60	5RP060C	125.45	46.0	54	114	5RP114C	221.50	83.0	54	168	5RP168C	324.70	121.0	54	222	5RP222C	447.85	159.0
60	60	5RS060C	127.65	47.0	60	114	5RS114C	225.35	84.0	60	168	5RS168C	330.05	123.0					
30	66	5RB066C	118.95	44.0	30	120	5RB120C	208.40	77.0	30	174	5RB174C	295.65	110.0	30	228	5RB228C	414.05	145.0
36	66	5RE066C	121.50	45.0	36	120	5RE120C	211.55	78.0	36	174	5RE174C	300.90	112.0	36	228	5RE228C	420.60	147.0
42	66	5RH066C	125.65	46.0	42	120	5RH120C	218.45	81.0	42	174	5RH174C	309.35	116.0	42	228	5RH228C	432.75	151.0
48	66	5RL066C	129.20	47.0	48	120	5RL120C	224.40	83.0	48	174	5RL174C	318.10	119.0	48	228	5RL228C	444.60	156.0
54	66	5RP066C	133.10	49.0	54	120	5RP120C	231.05	86.0	54	174	5RP174C	327.45	124.0	54	228	5RP228C	456.60	160.0
60	66	5RS066C	135.70	50.0	60	120	5RS120C	234.55	87.0	60	174	5RS174C	332.25	126.0					
30	72	5RB072C	125.45	47.0	30	126	5RB126C	221.70	80.0	30	180	5RB180C	304.20	113.0	30	234	5RB234C	422.90	147.0
36	72	5RE072C	132.10	48.0	36	126	5RE126C	226.00	81.0	36	180	5RE180C	309.35	116.0	36	234	5RE234C	429.45	150.0
42	72	5RH072C	135.65	49.0	42	126	5RH126C	231.95	84.0	42	180	5RH180C	318.00	120.0	42	234	5RH234C	441.75	154.0
48	72	5RL072C	138.35	50.0	48	126	5RL126C	238.30	86.0	48	180	5RL180C	326.70	122.0	48	234	5RL234C	453.50	158.0
54	72	5RP072C	142.10	52.0	54	126	5RP126C	245.65	89.0	54	180	5RP180C	335.10	127.0	54	234	5RP234C	455.05	163.0
60	72	5RS072C	146.05	53.0	60	126	5RS126C	249.00	90.0	60	180	5RS180C	340.65	128.0					
30	78	5RB078C	137.75	49.0	30	132	5RB132C	234.70	83.0	30	186	5RB186C	312.15	117.0	30	240	5RB240C	432.15	150.0
36	78	5RE078C	140.05	50.0	36	132	5RE132C	239.25	84.0	36	186	5RE186C	316.90	119.0	36	240	5RE240C	438.20	153.0
42	78	5RH078C	143.70	52.0	42	132	5RH132C	244.95	87.0	42	186	5RH186C	325.50	123.0	42	240	5RH240C	450.15	157.0
48	78	5RL078C	146.55	53.0	48	132	5RL132C	250.15	89.0	48	186	5RL186C	334.30	125.0	48	240	5RL240C	459.00	161.0
54	78	5RP078C	150.50	55.0	54	132	5RP132C	255.60	92.0	54	186	5RP186C	343.55	129.0	54	240	5RP240C	474.55	166.0
60	78	5RS078C	157.90	57.0	60	132	5RS132C	259.15	94.0	60	186	5RS186C	348.70	131.0					
30	84	5RB084C	154.60	57.0	30	138	5RB138C	242.75	86.0	30	192	5RB192C	325.05	121.0					
36	84	5RE084C	160.75	58.0	36	138	5RE138C	246.50	87.0	36	192	5RE192C	330.05	123.0					
42	84	5RH084C	166.75	62.0	42	138	5RH138C	252.65	90.0	42	192	5RH192C	338.55	128.0					
48	84	5RL084C	172.95	65.0	48	138	5RL138C	255.60	91.0	48	192	5RL192C	347.35	130.0					
54	84	5RP084C	176.45	66.0	54	138	5RP138C	263.20	96.0	54	192	5RP192C	353.35	132.0					
60	84	5RS084C	182.95	70.0	60	138	5RS138C	267.10	97.0	60	192	5RS192C	361.10	136.0					
30	90	5RB090C	161.90	60.0	30	144	5RB144C	255.60	92.0	30	198	5RB198C	355.10	125.0					
36	90	5RE090C	167.80	61.0	36	144	5RE144C	264.60	95.0	36	198	5RE198C	360.70	127.0					
42	90	5RH090C	173.90	64.0	42	144	5RH144C	273.35	99.0	42	198	5RH198C	369.65	130.0					
48	90	5RL090C	180.20	68.0	48	144	5RL144C	282.20	104.0	48	198	5RL198C	379.35	134.0					
54	90	5RP090C	184.80	70.0	54	144	5RP144C	287.65	106.0	54	198	5RP198C	386.30	137.0					
60	90	5RS090C	190.50	73.0	60	144	5RS144C	292.50	110.0	60	198	5RS198C	394.35	140.0					
30	96	5RB096C	169.75	63.0	30	150	5RB150C	261.70	96.0	30	204	5RB204C	369.05	130.0					
36	96	5RE096C	175.50	64.0	36	150	5RE150C	270.25	98.0	36	204	5RE204C	374.40	132.0					
42	96	5RH096C	185.20	68.0	42	150	5RH150C	279.10	102.0	42	204	5RH204C	383.85	135.0					
48	96	5RL096C	190.50	71.0	48	150	5RL150C	282.40	107.0	48	204	5RL204C	390.65	137.0					
54	96	5RP096C	192.05	73.0	54	150	5RP150C	293.55	109.0	54	204	5RP204C	397.20	140.0					
60	96	5RS096C	198.20	76.0	60	150	5RS150C	302.15	113.0	60	204	5RS204C	402.90	142.0					

See Pallet Rack Upright Frame Capacity Chart for frame capacity at various beam spacing

Standard Pallet Rack Upright Frames



Frame Type T 3" wide x 3" deep Post - 12 Gauge

D	H	Cat. No.	Price	Wt.	D	H	Cat. No.	Price	Wt.	D	H	Cat. No.	Price	Wt.	D	H	Cat. No.	Price	Wt.
30	48	5TB048C	102.65	37.0	30	102	5TB102C	197.05	73.0	30	156	5TB156C	302.55	112.0	30	210	5TB210C	414.05	147.0
36	48	5TE048C	106.10	39.0	36	102	5TE102C	203.00	75.0	36	156	5TE156C	307.70	114.0	36	210	5TE210C	419.05	150.0
42	48	5TH048C	109.65	41.0	42	102	5TH102C	208.60	77.0	42	156	5TH156C	315.95	117.0	42	210	5TH210C	427.95	153.0
48	48	5TL048C	113.50	43.0	48	102	5TL102C	214.95	79.0	48	156	5TL156C	324.70	120.0	48	210	5TL210C	434.75	156.0
54	48	5TP048C	115.90	45.0	54	102	5TP102C	218.45	81.0	54	156	5TP156C	335.10	123.0	54	210	5TP210C	440.35	159.0
60	48	5TS048C	119.65	47.0	60	102	5TS102C	222.00	83.0	60	156	5TS156C	338.35	126.0	60	210	5TS210C	445.55	162.0
30	54	5TB054C	111.10	40.0	30	108	5TB108C	210.95	78.0	30	162	5TB162C	311.40	116.0	30	216	5TB216C	435.50	152.0
36	54	5TE054C	115.00	42.0	36	108	5TE108C	213.90	80.0	36	162	5TE162C	316.30	119.0	36	216	5TE216C	442.05	155.0
42	54	5TH054C	118.35	44.0	42	108	5TH108C	219.80	82.0	42	162	5TH162C	325.35	122.0	42	216	5TH216C	453.25	158.0
48	54	5TL054C	125.65	46.0	48	108	5TL108C	226.15	84.0	48	162	5TL162C	333.95	125.0	48	216	5TL216C	464.50	161.0
54	54	5TP054C	127.30	48.0	54	108	5TP108C	231.80	86.0	54	162	5TP162C	342.65	128.0	54	216	5TP216C	475.65	164.0
60	54	5TS054C	129.95	50.0	60	108	5TS108C	236.10	88.0	60	162	5TS162C	347.25	131.0	60	216	5TS216C	482.25	167.0
30	60	5TB060C	121.95	44.0	30	114	5TB114C	218.80	82.0	30	168	5TB168C	320.05	119.0	30	222	5TB222C	439.40	156.0
36	60	5TE060C	125.45	46.0	36	114	5TE114C	225.50	84.0	36	168	5TE168C	325.35	122.0	36	222	5TE222C	445.80	159.0
42	60	5TH060C	128.30	48.0	42	114	5TH114C	228.15	86.0	42	168	5TH168C	334.15	125.0	42	222	5TH222C	457.65	162.0
48	60	5TL060C	132.10	50.0	48	114	5TL114C	234.10	88.0	48	168	5TL168C	342.65	128.0	48	222	5TL222C	468.55	166.0
54	60	5TP060C	134.85	52.0	54	114	5TP114C	240.10	90.0	54	168	5TP168C	351.20	131.0	54	222	5TP222C	479.90	170.0
60	60	5TS060C	137.75	54.0	60	114	5TS114C	243.70	92.0	60	168	5TS168C	355.50	134.0					
30	66	5TB066C	129.85	48.0	30	120	5TB120C	227.00	85.0	30	174	5TB174C	325.50	123.0	30	228	5TB228C	450.15	159.0
36	66	5TE066C	135.75	50.0	36	120	5TE120C	231.05	87.0	36	174	5TE174C	330.65	125.0	36	228	5TE228C	456.00	162.0
42	66	5TH066C	137.15	52.0	42	120	5TH120C	237.05	89.0	42	174	5TH174C	338.55	128.0	42	228	5TH228C	467.15	166.0
48	66	5TL066C	140.90	54.0	48	120	5TL120C	242.75	91.0	48	174	5TL174C	347.90	132.0	48	228	5TL228C	478.30	170.0
54	66	5TP066C	144.20	56.0	54	120	5TP120C	248.55	93.0	54	174	5TP174C	356.05	135.0	54	228	5TP228C	490.25	174.0
60	66	5TS066C	147.15	58.0	60	120	5TS120C	252.25	95.0	60	174	5TS174C	360.70	138.0					
30	72	5TB072C	141.55	52.0	30	126	5TB126C	245.80	89.0	30	180	5TB180C	335.50	126.0	30	234	5TB234C	462.45	162.0
36	72	5TE072C	144.50	54.0	36	126	5TE126C	249.45	91.0	36	180	5TE180C	339.95	129.0	36	234	5TE234C	465.60	166.0
42	72	5TH072C	148.00	56.0	42	126	5TH126C	255.60	93.0	42	180	5TH180C	348.10	132.0	42	234	5TH234C	477.50	170.0
48	72	5TL072C	151.00	58.0	48	126	5TL126C	261.15	95.0	48	180	5TL180C	356.75	135.0	48	234	5TL234C	488.30	174.0
54	72	5TP072C	154.90	60.0	54	126	5TP126C	268.00	97.0	54	180	5TP180C	365.60	138.0	54	234	5TP234C	499.60	178.0
60	72	5TS072C	158.55	62.0	60	126	5TS126C	271.75	99.0	60	180	5TS180C	369.95	140.0					
30	78	5TB078C	154.20	56.0	30	132	5TB132C	259.15	94.0	30	186	5TB186C	343.55	130.0	30	240	5TB240C	469.55	166.0
36	78	5TE078C	157.00	58.0	36	132	5TE132C	261.70	96.0	36	186	5TE186C	348.70	133.0	36	240	5TE240C	475.85	170.0
42	78	5TH078C	160.75	60.0	42	132	5TH132C	268.75	98.0	42	186	5TH186C	357.00	135.0	42	240	5TH240C	487.15	174.0
48	78	5TL078C	163.30	62.0	48	132	5TL132C	273.85	100.0	48	186	5TL186C	365.60	138.0	48	240	5TL240C	498.75	178.0
54	78	5TP078C	167.80	64.0	54	132	5TP132C	278.75	102.0	54	186	5TP186C	374.05	141.0	54	240	5TP240C	509.80	182.0
60	78	5TS078C	171.05	66.0	60	132	5TS132C	282.40	104.0	60	186	5TS186C	379.10	144.0					
30	84	5TB084C	172.35	63.0	30	138	5TB138C	268.00	98.0	30	192	5TB192C	357.20	135.0					
36	84	5TE084C	178.25	65.0	36	138	5TE138C	271.75	100.0	36	192	5TE192C	362.55	137.0					
42	84	5TH084C	184.00	67.0	42	138	5TH138C	277.90	102.0	42	192	5TH192C	370.75	140.0					
48	84	5TL084C	190.40	69.0	48	138	5TL138C	282.65	104.0	48	192	5TL192C	378.80	143.0					
54	84	5TP084C	194.00	71.0	54	138	5TP138C	287.65	106.0	54	192	5TP192C	385.15	146.0					
60	84	5TS084C	200.10	73.0	60	138	5TS138C	291.65	108.0	60	192	5TS192C	392.45	149.0					
30	90	5TB090C	180.70	66.0	30	144	5TB144C	282.20	103.0	30	198	5TB198C	381.70	138.0					
36	90	5TE090C	186.60	68.0	36	144	5TE144C	290.45	106.0	36	198	5TE198C	386.75	140.0					
42	90	5TH090C	192.85	70.0	42	144	5TH144C	299.15	109.0	42	198	5TH198C	395.15	143.0					
48	90	5TL090C	198.55	72.0	48	144	5TL144C	307.45	112.0	48	198	5TL198C	404.15	146.0					
54	90	5TP090C	204.55	74.0	54	144	5TP144C	309.50	115.0	54	198	5TP198C	410.30	149.0					
60	90	5TS090C	208.05	76.0	60	144	5TS144C	321.70	118.0	60	198	5TS198C	417.75	152.0					
30	96	5TB096C	188.90	70.0	30	150	5TB150C	287.15	106.0	30	204	5TB204C	395.25	143.0					
36	96	5TE096C	195.15	72.0	36	150	5TE150C	295.50	109.0	36	204	5TE204C	400.60	145.0					
42	96	5TH096C	202.05	74.0	42	150	5TH150C	303.45	112.0	42	204	5TH204C	409.50	149.0					
48	96	5TL096C	207.40	76.0	48	150	5TL150C	312.35	115.0	48	204	5TL204C	415.15	153.0					
54	96	5TP096C	212.50	78.0	54	150	5TP150C	317.55	118.0	54	204	5TP204C	422.40	156.0					
60	96	5TS096C	216.80	80.0	60	150	5TS150C	325.85	121.0	60	204	5TS204C	427.50	159.0					

See Pallet Rack Upright Frame Capacity Chart for frame capacity at various beam spacing



Standard Pallet Rack Beams

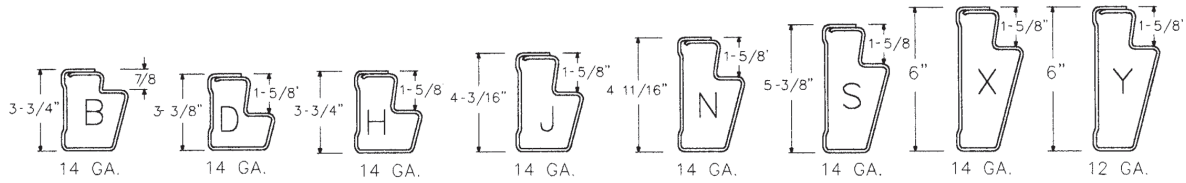

W	H	Capacity Lbs. **	Cat. No.	Price per Pair	Wt. Pair
---	---	------------------	----------	----------------	----------

Typical Beam Depth Dimensions

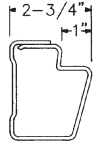

Pallet Rack Beams

48" Clear Span

W	H	Capacity Lbs. **	Cat. No.	Price per Pair	Wt. Pair
7/8" Step					
48	3-3/4	8920	5BB048	102.80	35.0
1-5/8" Step					
48	3-3/8	8380	5BD048	100.55	33.0
48	3-3/4	9430	5BH048	102.80	35.0
48	4-3/16	10670	5BJ048	106.15	36.0
48	4-11/16	12170	5BN048	111.55	38.0

54" Clear Span

W	H	Capacity Lbs. **	Cat. No.	Price per Pair	Wt. Pair
7/8" Step					
54	3-3/4	7920	5BB054	110.80	38.0
1-5/8" Step					
54	3-3/8	7445	5BD054	107.10	37.0
54	3-3/4	8370	5BH054	110.80	38.0
54	4-3/16	9480	5BJ054	114.60	40.0
54	4-11/16	10810	5BN054	120.20	42.0

60" Clear Span

W	H	Capacity Lbs. **	Cat. No.	Price per Pair	Wt. Pair
7/8" Step					
60	3-3/4	7120	5BB060	118.75	42.0
1-5/8" Step					
60	3-3/8	6695	5BD060	114.85	40.0
60	3-3/4	7530	5BH060	118.75	42.0
60	4-3/16	8520	5BJ060	123.10	44.0
60	4-11/16	9730	5BN060	128.65	46.0

66" Clear Span

W	H	Capacity Lbs. **	Cat. No.	Price per Pair	Wt. Pair
7/8" Step					
66	3-3/4	6470	5BB066	126.35	45.0
1-5/8" Step					
66	3-3/8	6080	5BD066	123.15	43.0
66	3-3/4	6840	5BH066	126.35	45.0
66	4-3/16	7740	5BJ066	130.95	47.0
66	4-11/16	8830	5BN066	137.30	50.0

72" Clear Span

W	H	Capacity Lbs. **	Cat. No.	Price per Pair	Wt. Pair
7/8" Step					
72	3-3/4	5920	5BB072	134.15	49.0
1-5/8" Step					
72	3-3/8	5570	5BD072	131.40	47.0
72	3-3/4	6260	5BH072	134.15	49.0
72	4-3/16	7090	5BJ072	139.20	51.0
72	4-11/16	8090	5BN072	146.05	54.0
72	5-3/8	9560	5BS072	154.50	57.0

W	H	Capacity Lbs. **	Cat. No.	Price per Pair	Wt. Pair
---	---	------------------	----------	----------------	----------

78" Clear Span

W	H	Capacity Lbs. **	Cat. No.	Price per Pair	Wt. Pair
7/8" Step					
78	3-3/4	5460	5BB078	142.20	52.0
1-5/8" Step					
78	3-3/8	5135	5BD078	139.75	50.0
78	3-3/4	5770	5BH078	142.20	52.0
78	4-3/16	6540	5BJ078	147.70	55.0
78	4-11/16	7460	5BN078	154.95	58.0
78	6	10220	5BX078	178.25	65.0

84" Clear Span

W	H	Capacity Lbs. **	Cat. No.	Price per Pair	Wt. Pair
7/8" Step					
84	3-3/4	5070	5BB084	149.85	56.0
1-5/8" Step					
84	3-3/8	4760	5BD084	147.60	53.0
84	3-3/4	5360	5BH084	149.85	56.0
84	4-3/16	6060	5BJ084	156.00	58.0
84	4-11/16	6920	5BN084	163.65	62.0
84	6	9480	5BX084	188.60	70.0
84	6	12650	5BY084	227.40	92.0

90" Clear Span

W	H	Capacity Lbs. **	Cat. No.	Price per Pair	Wt. Pair
7/8" Step					
90	3-3/4	4720	5BB090	157.60	59.0
1-5/8" Step					
90	3-3/8	4430	5BD090	154.95	57.0
90	3-3/4	4990	5BH090	157.60	59.0
90	4-3/16	5650	5BJ090	164.10	62.0
90	4-11/16	6450	5BN090	172.35	65.0
90	5-3/8	7630	5BS090	182.95	70.0
90	6	8840	5BX090	200.05	74.0
90	6	11800	5BY090	243.65	99.0

96" Clear Span

W	H	Capacity Lbs. **	Cat. No.	Price per Pair	Wt. Pair
7/8" Step					
96	3-3/4	4420	5BB096	165.25	63.0
1-5/8" Step					
96	3-3/8	3990	5BD096	162.55	60.0
96	3-3/4	4670	5BH096	165.25	63.0
96	4-3/16	5290	5BJ096	172.00	66.0
96	4-11/16	6040	5BN096	181.15	69.0
96	5-3/8	7190	5BS096	192.15	74.0
96	6	8280	5BX096	211.70	79.0
96	6	11050	5BY096	256.75	105.0

Traditional Color - 710 Sagebrush Yellow
 Clear Span = Inside Frame to Inside Frame Dimension
 ** Capacity per Pair for Uniformly Distributed Load
 Order by Catalog Number Only

Standard Pallet Rack Beams

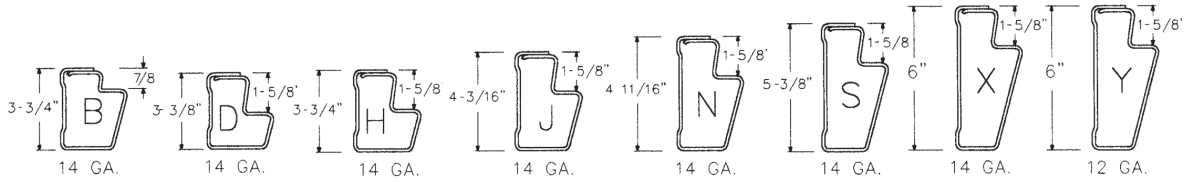

W	H	Capacity Lbs. **	Cat. No.	Price per Pair	Wt. Pair
102" Clear Span					
7/8" Step					
102	3-3/4	4160	5BB102	175.20	66.0
1-5/8" Step					
102	3-3/8	3530	5BD102	171.40	64.0
102	3-3/4	4390	5BH102	175.20	66.0
102	4-3/16	4980	5BJ102	182.35	70.0
102	4-11/16	5680	5BN102	192.00	73.0
102	5-3/8	6720	5BS102	203.70	79.0
102	6	7790	5BX102	222.35	83.0
102	6	10390	5BY102	274.00	111.0
108" Clear Span					
7/8" Step					
108	3-3/4	3920	5BB108	183.25	70.0
1-5/8" Step					
108	3-3/8	3150	5BD108	179.80	67.0
108	3-3/4	3990	5BH108	183.25	70.0
108	4-3/16	4690	5BJ108	191.00	73.0
108	4-11/16	5340	5BN108	200.95	77.0
108	5-3/8	6340	5BS108	213.40	83.0
108	6	7350	5BX108	233.85	88.0
108	6	9800	5BY108	287.75	117.0
114" Clear Span					
7/8" Step					
114	3-3/4	3540	5BB114	192.85	73.0
1-5/8" Step					
114	3-3/8	2830	5BD114	184.40	70.0
114	4-3/16	4440	5BJ114	201.10	77.0
114	6	6950	5BX114	244.60	92.0
114	6	9280	5BY114	301.60	123.0
120" Clear Span					
7/8" Step					
120	3-3/4	3190	5BB120	200.90	77.0
1-5/8" Step					
120	3-3/8	2550	5BD120	196.75	74.0
120	3-3/4	3230	5BH120	200.90	77.0
120	4-3/16	4130	5BJ120	209.55	81.0
120	4-11/16	4810	5BN120	220.75	85.0
120	5-3/8	5690	5BS120	234.55	91.0
120	6	6600	5BX120	256.40	97.0
120	6	8800	5BY120	315.20	129.0
126" Clear Span					
7/8" Step					
126	3-3/4	2900	5BB126	209.15	80.0
1-5/8" Step					
126	3-3/8	2310	5BD126	219.25	77.0
126	4-11/16	4570	5BN126	229.70	89.0
126	5-3/8	5410	5BS126	243.95	95.0
126	6	6270	5BX126	265.25	101.0
126	6	8370	5BY126	328.90	135.0

W	H	Capacity Lbs. **	Cat. No.	Price per Pair	Wt. Pair
132" Clear Span					
7/8" Step					
132	3-3/4	2840	5BB132	217.40	84.0
1-5/8" Step					
132	4-11/16	4410	5BN132	239.30	93.0
132	5-3/8	5160	5BS132	254.75	100.0
132	6	5980	5BX132	277.90	106.0
132	6	7980	5BY132	342.80	142.0
138" Clear Span					
7/8" Step					
138	3-3/4	2410	5BB138	225.75	87.0
1-5/8" Step					
138	4-11/16	4030	5BN138	248.25	97.0
138	6	5710	5BX138	287.65	110.0
138	6	7620	5BY138	356.45	148.0
144" Clear Span					
7/8" Step					
144	3-3/4	2220	5BB144	233.85	91.0
1-5/8" Step					
144	3-3/4	2240	5BH144	233.85	91.0
144	5-3/8	4740	5BS144	274.05	108.0
144	6	5500	5BX144	300.60	115.0
144	6	7340	5BY144	370.35	154.0

Traditional Color - 710 Sagebrush Yellow
 Clear Span = Inside Frame to Inside Frame Dimension
 ** Capacity per Pair for Uniformly Distributed Load
 Order by Catalog Number Only

W	D	H	*	Cat. No.	Price	Per	Wt.	Pkg.
---	---	---	---	----------	-------	-----	-----	------

W	D	H	*	Cat. No.	Price	Per	Wt.	Pkg.
---	---	---	---	----------	-------	-----	-----	------

General Duty Cross Bars, 16 Ga.

For 7/8" Step Beam

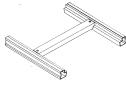

30	5AX530C	15.80	Ea.	3.6
36	5AX536C	17.75	Ea.	4.4
42	5AX542C	20.35	Ea.	5.3
48	5AX548C	23.15	Ea.	6.1
54	5AX554C	26.05	Ea.	6.8
60	5AX560C	28.40	Ea.	7.5

For 1-5/8" Step Beam

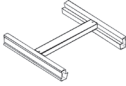

30	5AX630C	14.95	Ea.	3.6
36	5AX636C	17.25	Ea.	4.4
42	5AX642C	19.80	Ea.	5.3
48	5AX648C	22.20	Ea.	6.1
54	5AX654C	24.30	Ea.	6.8
60	5AX660C	27.20	Ea.	7.5

Heavy Duty Flanged Cross Bars, 16 Ga.

For 1-5/8" Step Beams

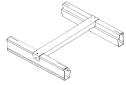

30	5AX730C	19.15	Ea.	4.5
36	5AX736C	20.95	Ea.	5.3
42	5AX742C	23.70	Ea.	6.1
48	5AX748C	26.40	Ea.	6.9
54	5AX754C	29.10	Ea.	7.7
60	5AX760C	32.10	Ea.	8.5

Plywood Supports, 16 Ga.

When used as a deck support (for plywood, particle board, etc.) we recommend that the center support be securely fastened (using Tek screw #8822) to both the front and rear beams. Plywood depth should be Frame depth minus 3-3/4".

For 7/8" Step Beam, 1/2" Deck



30	5AP230C	10.60	Ea.	3.6
36	5AP236C	12.50	Ea.	4.4
42	5AP242C	14.05	Ea.	5.3
48	5AP248C	15.80	Ea.	6.1

For 1-5/8" Step Beam, 3/4" Deck

30	5AP330	15.80	Ea.	3.6
36	5AP336	17.75	Ea.	4.4
42	5AP342	20.35	Ea.	5.3
48	5AP348	23.15	Ea.	6.1
54	5AP354	26.05	Ea.	6.8
60	5AP360	28.40	Ea.	7.5

Heavy Duty Skid Channels

11 Ga., 4" Wide Runners

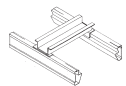

30	5AS230C	32.85	Ea.	9.3
36	5AS236C	36.70	Ea.	11.1
42	5AS242C	41.10	Ea.	12.9
48	5AS248C	45.20	Ea.	14.7

Fork Clearance Bars

11 Ga.

Raises unpalletized loads by 2-3/4".

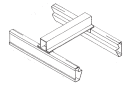

30	5AF330C	30.15	Ea.	9.0
36	5AF336C	33.50	Ea.	10.7
42	5AF342C	37.60	Ea.	12.5
48	5AF348C	41.50	Ea.	14.2
54	5AF354C	45.60	Ea.	16.0
60	5AF360C	49.50	Ea.	17.7

Cross Bar Load Ratings For Offset Pallet Conditions

- For pallet depths equal to or greater than frame depth.
- NOT for uniformly distributed load conditions.
- For series 5AX500, 5AX600 and 5AX700.
- For rigid pallets only.

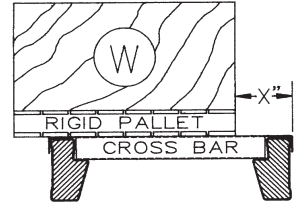

Frame Depth (inches)	Offset "X" (inches)	Max. Allowable Load "W" (lbs) on two Bars
36	4	6058
	5	3895
	6	2988
	7	2503
42	4	5960
	5	3786
	6	2868
	7	2370
48	4	5890
	5	3711
	6	2786
	7	2281
54	4	5838
	5	3655
	6	2727
	7	2217
60	4	5798
	5	3613
	6	2682
	7	2169

Coil Bed Assembly

7 Ga., Full Depth

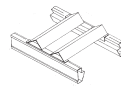

30	5AC030C	70.45	Ea.	21.0
36	5AC036C	79.85	Ea.	25.0
42	5AC042C	90.15	Ea.	29.0
48	5AC048C	99.00	Ea.	33.0

Drum Wedges

Pairs

Attach to front beam only.

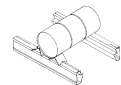

5AW000	9.30	Pr.	1.2
--------	------	-----	-----

Pallet Stop - Pairs

For 1-5/8" Step Beams Only

Attaches to rear beam with Tek screw # 8822 (included).



4	3-1/4	4	5AT00H	24.55	Pr.	5.4
---	-------	---	--------	-------	-----	-----

Self-Tapping screws are available for fastening accessories to beams. See Part No. 8822 in RivetRite Component Parts Section.

W	D	H	*	Cat. No.	Price	Per	Wt.	Pkg.
---	---	---	---	----------	-------	-----	-----	------

Rigid Row Spacers, 12 Ga.

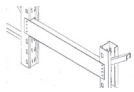

Hardware Included

6	5AR506	8.20	Ea.	2.0
8	5AR508	9.30	Ea.	2.4
10	5AR510	10.30	Ea.	2.8
12	5AR512	11.15	Ea.	3.2
18	5AR518	14.65	Ea.	4.5
24	5AR524	17.65	Ea.	5.8
30	5AR530	21.20	Ea.	6.7
36	5AR536	24.30	Ea.	8.3
42	5AR542	27.60	Ea.	9.6
48	5AR548	30.25	Ea.	10.8
54	5AR554	33.25	Ea.	12.1
60	5AR560	36.15	Ea.	13.4

Rigid Wall Spacers, 12 Ga.

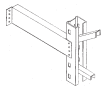

Frame Hardware Included

4	5AR404	6.45	Ea.	1.5
6	5AR406	7.95	Ea.	2.0
8	5AR408	8.85	Ea.	2.4
10	5AR410	9.90	Ea.	2.8
12	5AR412	10.80	Ea.	3.2
18	5AR418	14.70	Ea.	4.6

Reel Holder - Pairs

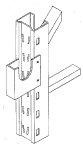

2-1/2" Diameter Max. Axle

Hardware Included. 1000 lb. capacity per pair maximum.
5AH000 17.65 Pr. 3.0

Frame Splice Channels - Pairs

Specify that top frame be manufactured without foot plates. Hardware included.



For Frame Type F, G & P

12	5AU008P	34.80	Pr.	4.5
----	---------	-------	-----	-----

For Frame Type R & T

12	5AU018P	36.00	Pr.	6.0
----	---------	-------	-----	-----

W	D	H	*	Cat. No.	Price	Per	Wt.	Pkg.
---	---	---	---	----------	-------	-----	-----	------

Frame Protector

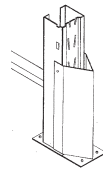

Includes Frame Hardware

Floor Anchors Not Included.

Finished in 710 Yellow only. NOT for use with Pallet Rack PLUS upright frames.

18	5AF018	30.15	Ea.	7.0
----	--------	-------	-----	-----

Frame Deflector

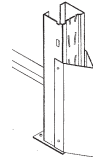

Finished 710 Yellow Only.

18	5AF021PC	25.80	Ea.	5.8
----	----------	-------	-----	-----

Drum Rack Unit

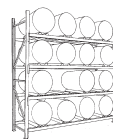

16-55 Gallon Drum Capacity

Consists of 4 pairs of "J" Beams, 2 "F" Uprights and 16 Coil Bed Assemblies.

120	36	120	5SC0162312.10	Unit	664.0
-----	----	-----	---------------	------	-------

Concrete Floor Anchor

1/2"-13 x 3-3/4"

9580	3.60	Ea.	0.2
------	------	-----	-----



Shim, 7 Ga.

Rack Foot Plate, Unpainted

Has 2-9/16" Holes

3-1/4	4-1/4	55020	2.45	Ea.	0.8
-------	-------	-------	------	-----	-----

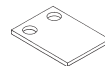

Shim for Pallet Rack PLUS Foot Plate, 7 Ga.

Specify color.

5	7	55021	6.35	Ea.	1.0
---	---	-------	------	-----	-----



Inventory Carts & Misc. Parts

W	D	H	*	Cat. No.	Price	Per	Wt.	Pkg.
---	---	---	---	----------	-------	-----	-----	------

Inventory Carts-723 Lt. Putty

48" High - 3 Levels

With Particle Board Deck

36	24	48		35076P	300.35	Ea.	94.0
48	24	48		35077P	334.20	Ea.	116.0
60	24	48		35078P	371.95	Ea.	139.0

With White Melamine Deck

36	24	48		35080P	323.40	Ea.	94.0
48	24	48		35081P	359.55	Ea.	116.0
60	24	48		35082P	385.20	Ea.	139.0

NO Deck

36	24	48		35095P	254.90	Ea.	49.0
48	24	48		35096P	294.05	Ea.	56.0
60	24	48		35097P	321.75	Ea.	64.0

60" High - 4 Levels

With Particle Board Deck

36	24	60		35074P	337.80	Ea.	117.0
48	24	60		35073P	377.85	Ea.	145.0
60	24	60		35075P	412.30	Ea.	181.0

With White Melamine Deck

36	24	60		35083P	357.30	Ea.	117.0
48	24	60		35084P	393.75	Ea.	145.0
60	24	60		35085P	424.50	Ea.	181.0

NO Deck

36	24	60		35092P	277.25	Ea.	57.0
48	24	60		35093P	324.30	Ea.	65.0
60	24	60		35094P	345.50	Ea.	81.0

Inventory Cart Components

Shelf Level Kit

4 Beams & 1 Pc. Particle Board

36	24			35086P	32.95	Kit	19.0
48	24			35087P	32.50	Kit	25.0
60	24			35088P	52.45	Kit	37.0

4 Beams & 1 Pc. Melamine

36	24			35089P	45.50	Kit	19.0
48	24			35090P	54.25	Kit	25.0
60	24			35091P	78.05	Kit	37.0

Deck Only

Particle Board Deck

36	24			94606	15.15	Ea.	13.0
48	24			94626	13.35	Ea.	18.0
60	24			94636	16.80	Ea.	22.0

White Melamine Deck

36	24			94706	27.70	Ea.	13.0
48	24			94726	35.10	Ea.	18.0
60	24			94736	42.35	Ea.	22.0

For components of extra shelf levels for Inventory Carts, see the RivetRite Component Parts section.

For 36" & 48" long carts (Single Rivet Beams):

24", **46SS24P** 36", **46SS36P** 48", **46SS48P**

For 60" long carts (Double Rivet Beams)

24", **46SB24P** 60", **46HB60P**

W	D	H	*	Cat. No.	Price	Per	Wt.	Pkg.
---	---	---	---	----------	-------	-----	-----	------

5" Replacement Caster For Service Carts

2 Rigid, 2 Swivel

125# Capacity Per Caster



9375 78.30 Set 8.0

Cylinder Cam Lock

For use with work bench drawer or as a replacement on shop desk. For keyed alike group sets, consult your Penco Representative.

Keyed Differently

9389 18.05 Ea. 0.2

Master Key

93891 5.10 Ea. 0.1

Keyed Alike

9390 22.85 Ea. 0.2



Padlock Clip

Used as a replacement part for Case and Drawer and Shop Desk drawers.

31212Z 3.60 Ea. 0.3

T-Handle Lock Assembly

Used as replacement parts for cabinets with TEE Handles.

Keyed Differently

8797 24.70 Ea. 2.0

Master Key

93891 5.10 Ea. 0.1



Replacement Parts

"L" Handle

For 42" High & 48" Wide Cabinets

8799 21.20 Ea. 2.0

"L" Handle Master Key

93891 5.10 Ea. 0.1



Coat Rod

For 36" Wide Cabinets

36 **8793H 6.65** Ea.

3.0

W	D	H	*	Cat. No.	Price	Per	Wt.	Pkg.
---	---	---	---	----------	-------	-----	-----	------

W	D	H	*	Cat. No.	Price	Per	Wt.	Pkg.
---	---	---	---	----------	-------	-----	-----	------

Touch Up Paint, Air Dry

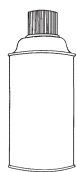

4.5 Oz. Spray Can, Air Dry

Tawny Tan	97012	25.60	Ea.	1.0
Gray Ash	97021	25.60	Ea.	1.0
Gray	97028	25.60	Ea.	1.0
Reflex Blue	97052	25.60	Ea.	1.0
Canvas	97054	25.60	Ea.	1.0
Shamrock	97055	25.60	Ea.	1.0
Sunburst	97056	25.60	Ea.	1.0
Nordic Purple	97058	25.60	Ea.	1.0
Champagne	97073	25.60	Ea.	1.0
Spray Green	97701	25.60	Ea.	1.0
Sagebrush Yellow	97710	25.60	Ea.	1.0
Lake Blue	97715	25.60	Ea.	1.0
Mandarin Orange	97720	25.60	Ea.	1.0
Patriot Red	97722	25.60	Ea.	1.0
Light Putty	97723	25.60	Ea.	1.0
Burgundy	97736	25.60	Ea.	1.0
Cardinal Red	97767	25.60	Ea.	1.0
Marine Blue	97806	25.60	Ea.	1.0
Hunter Green	97812	25.60	Ea.	1.0
Regal Blue	97822	25.60	Ea.	1.0
Slate Blue	97826	25.60	Ea.	1.0
January	97848	25.60	Ea.	1.0
Jet Black	97949	25.60	Ea.	1.0
Turquoise Teal	97952	25.60	Ea.	1.0

Gallon Cans

GALLON 314.30 Ea. 10.0

0.33 oz. Paint Pens

The metal barrel Paint Pens (0.33 oz.) with a valve activated chisel-tip, ship from the Penco manufacturing plant in Hamilton, NC. Store recapped pens in a cool, dark area for optimal performance. Pens are recommended to be used on more visible areas like doors and frames. A minimum order of two (2) pens of the same color is required. Prices shown are as NET PRICE.

Tawny Tan	2PEN012	10.00NET	Ea.	1.0
Gray Ash	2PEN021	10.00NET	Ea.	1.0
Gray	2PEN028	10.00NET	Ea.	1.0
Reflex Blue	2PEN052	10.00NET	Ea.	1.0
Canvas	2PEN054	10.00NET	Ea.	1.0
Shamrock	2PEN055	10.00NET	Ea.	1.0
Sunburst	2PEN056	10.00NET	Ea.	1.0
Nordic Purple	2PEN058	10.00NET	Ea.	1.0
Champagne	2PEN073	10.00NET	Ea.	1.0
Spray Green	2PEN701	10.00NET	Ea.	1.0
Sagebrush Yellow	2PEN710	10.00NET	Ea.	1.0
Lake Blue	2PEN715	10.00NET	Ea.	1.0
Mandarin Orange	2PEN720	10.00NET	Ea.	1.0
Patriot Red	2PEN722	10.00NET	Ea.	1.0
Light Putty	2PEN723	10.00NET	Ea.	1.0
Burgundy	2PEN736	10.00NET	Ea.	1.0
Cardinal Red	2PEN767	10.00NET	Ea.	1.0
Marine Blue	2PEN806	10.00NET	Ea.	1.0
Hunter Green	2PEN812	10.00NET	Ea.	1.0
Regal Blue	2PEN822	10.00NET	Ea.	1.0
Slate Blue	2PEN826	10.00NET	Ea.	1.0
January White	2PEN848	10.00NET	Ea.	1.0
Jet Black	2PEN949	10.00NET	Ea.	1.0
Turquoise Teal	2PEN952	10.00NET	Ea.	1.0

1.0 oz. Paint Bottles

Paint Bottles ship from East Hanover, NJ. Both ship in approximately 10 business days. Store recapped bottles in a cool, dark area for optimal performance. A minimum order of two (2) bottles of the same color is required. Prices shown are as NET PRICE.

Tawny Tan	2BCB012	10.00NET	Ea.	1.0
Gray Ash	2BCB021	10.00NET	Ea.	1.0
Gray	2BCB028	10.00NET	Ea.	1.0
Reflex Blue	2BCB052	10.00NET	Ea.	1.0
Canvas	2BCB054	10.00NET	Ea.	1.0
Shamrock	2BCB055	10.00NET	Ea.	1.0
Sunburst	2BCB056	10.00NET	Ea.	1.0
Nordic Purple	2BCB058	10.00NET	Ea.	1.0
Champagne	2BCB073	10.00NET	Ea.	1.0
Spray Green	2BCB701	10.00NET	Ea.	1.0
Sagebrush Yellow	2BCB710	10.00NET	Ea.	1.0
Lake Blue	2BCB715	10.00NET	Ea.	1.0
Mandarin Orange	2BCB720	10.00NET	Ea.	1.0
Patriot Red	2BCB722	10.00NET	Ea.	1.0
Light Putty	2BCB723	10.00NET	Ea.	1.0
Burgundy	2BCB736	10.00NET	Ea.	1.0
Cardinal Red	2BCB767	10.00NET	Ea.	1.0
Marine Blue	2BCB806	10.00NET	Ea.	1.0
Hunter Green	2BCB812	10.00NET	Ea.	1.0
Regal Blue	2BCB822	10.00NET	Ea.	1.0
Slate Blue	2BCB826	10.00NET	Ea.	1.0
January White	2BCB848	10.00NET	Ea.	1.0
Jet Black	2BCB949	10.00NET	Ea.	1.0
Turquoise Teal	2BCB952	10.00NET	Ea.	1.0



www.pencoproducts.com

Every customer's first choice to transform space into safe, secure and effective storage.

Illustrated Price Book

For Shelving, Shelving Accessories and Pallet Rack

See our other price lists for **Lockers, Erectomatic® Shelving & QuickShip products.**

All prices shown are FOB plant of manufacture, with standard construction, unless otherwise stated. Prices and specifications are subject to change without notice.

Main Office

Penco Products, Inc.
1820 Stonehenge Drive
Greenville, NC 27858

Phone: 800-562-1000
252-917-5287

Fax: 800-248-1555
252-917-5294

Send orders directly to the main office.

Manufacturing

1301 Penco Drive
Hamilton, NC 27840

QuickShip Distribution Centers* Northeast

Pennsylvania QuickShip
524 Imperial Court, Suite D
Bensalem, PA 19020

South

Tennessee QuickShip
3624 Democrat Road
Suite 2
Memphis, TN 38118

Central

Indiana QuickShip
2602 Innovation Court
Fort Wayne, IN 46818

West

Utah QuickShip
4093 West 8530 South
Salt Lake City, UT 84088

* QuickShip lockers and other QuickShip products are in a separate price list. To see which products are stocked at each Penco warehouse location, go to www.pencoproducts.com/quickship