

Impact of Natural Gas Infrastructure on Electric Power Systems

MOHAMMAD SHAHIDEHPOUR, FELLOW, IEEE, YONG FU, MEMBER, IEEE, AND THOMAS WIEDMAN, SENIOR MEMBER, IEEE

Invited Paper

The restructuring of electricity has introduced new risks associated with the security of natural gas infrastructure on a significantly large scale, which entails changes in physical capabilities of pipelines, operational procedures, sensors and communications, contracting (supply and transportation), and tariffs. This paper will discuss the essence of the natural gas infrastructure for supplying the ever-increasing number of gas-powered units and use security-constrained unit commitment to analyze the short-time impact of natural gas prices on power generation scheduling. The paper analyzes the impact of natural gas infrastructure contingencies on the operation of electric power systems. Furthermore, the paper examines the impact of renewable sources of energy such as pumped-storage units and photovoltaic/battery systems on power system security by reducing the dependence of electricity infrastructure on the natural gas infrastructure. A modified IEEE 118-bus with 12 combined-cycle units is presented for analyzing the gas/electric interdependency.

Keywords—Combined-cycle unit, electricity market, natural gas infrastructure, pipeline contingency, pumped-storage hydro, renewable energy, security-constrained unit commitment (SCUC).

NOMENCLATURE

DR_i	Ramp-down rate limit of unit i .
E_S^{\max}	System emission limit.
$F_{ci}(\cdot)$	Production cost function of unit i .
$F_{fi}(\cdot)$	Fuel consumption function of unit i .
$F_{ei}(\cdot)$	Emission function of unit i .
F_{FT}^{\max}	Maximum fuel consumption (type FT).
F_{FT}^{\min}	Minimum fuel consumption (type FT).
i	Index for unit.

Manuscript received April 30, 2002; revised October 24, 2003. This work was supported by the Department of Energy's Office of Energy Efficiency and Renewable Energy (EERE) under Grant 03-57701.

M. Shahidehpour and Y. Fu are with the Electric Power and Power Electronics Center, Illinois Institute of Technology, Chicago, IL 60616 USA (e-mail: ms@iit.edu; fuyong@iit.edu).

T. Wiedman is with Wiedman Power System Consulting, Elizabeth, IL 61028 USA.

Digital Object Identifier 10.1109/JPROC.2005.847253

I_{it}	Commitment state of unit i at time t .
$N_{cfcg,i}$	Number of configuration of combined-cycle unit i .
NG	Number of units.
NT	Period of study (24 h in this paper).
P_{it}	Generation of unit i at time t .
$P_{i,\max}$	Upper limit of real power generation of unit i .
$P_{i,\min}$	Lower limit of real power generation of unit i .
P_{ikt}	Generation of combined-cycle unit i at configuration k at time t .
$P_{ik,\max}$	Upper limit of real generation of combined-cycle unit i at configuration k .
$P_{ik,\min}$	Lower limit of real generation of combined-cycle unit i at configuration k .
$P_{D,t}$	System demand at time t .
PL_{km}^{\max}	Maximum capacity of line $k-m$.
PL_{km}^{\max}	Maximum capacity of line $k-m$.
$PL_{km,t}$	Power flow from bus k to bus m at time t .
$R_{O,t}$	System operating reserve requirement at time t .
$R_{O,it}$	Operating reserve of unit i at time t .
$R_{S,t}$	System spinning reserve requirement at time t .
$R_{S,it}$	Spinning reserve of unit i at time t .
SU_{it}	Startup cost of unit i at time t .
$SU_{f,it}$	Startup fuel consumption of unit i at time t .
$SU_{e,it}$	Startup emission of unit i at time t .
SD_{it}	Shutdown cost of unit i at time t .
$SD_{f,it}$	Shutdown fuel consumption of unit i at time t .
$SD_{e,it}$	Shutdown emission of unit i at time t .
t	Index for time.
T_i^{off}	Minimum down time of unit i .
T_i^{on}	Minimum up time of unit i .
UR_i	Ramp-up rate limit of unit i .
U_{ikt}	Status of combined-cycle unit i at configuration k at time t .
X_{it}^{off}	OFF time of unit i at time t .
X_{it}^{on}	ON time of unit i at time t .

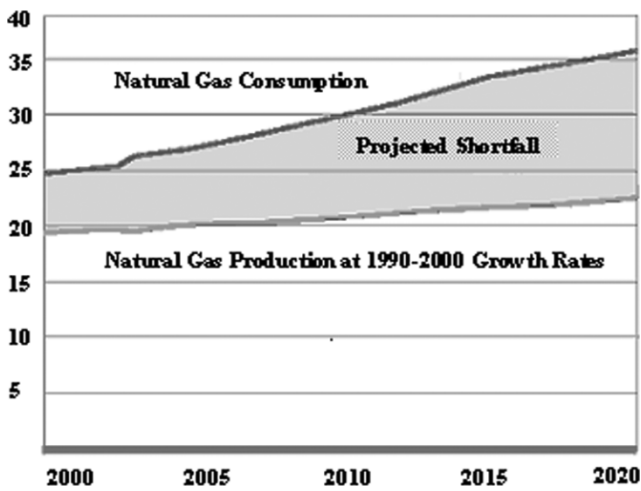

Fig. 1. U.S. natural gas consumption and production (trillion cubic feet).

I. INTRODUCTION

The concept of Energy–Environment–Economy (E^3) is becoming more momentous in this era of electricity restructuring as the national economy relies increasingly on a complex and interdependent energy infrastructure. The available, affordable, and clean sources of supplying energy are generally viewed as a prerequisite for economical strength in an industrialized society. The unbundling of electricity sector and the impetus of competition have also introduced new technologies to the generation and the delivery of electricity which signify less pollutant, higher efficiency, and less costly means of supplying the load. These technologies often apply to conventional (coal, oil, gas, hydro, nuclear) and unconventional (solar, wind, fuel cells, microturbines) sources of energy. In this era, the use of natural gas for supplying fuel to combine cycle units is represented as a pinnacle for utilizing cleaner and more efficient means of power generation in a competitive electricity market.

The natural gas infrastructure in the United States accounts for 25% of the nation’s primary energy consumption (including heating and other applications). The consumption of natural gas has increased by roughly 14% in the past decade and is expected to grow by over 50% over the next 20 years, as shown in Fig. 1 [1], [2]. Fig. 2 shows that in the years 1997–2001, natural gas provided about 24% of the U.S. electricity generation [3].

The continuing and rapid growth in gas-fired electric power generating plants (e.g., combined-cycle units) will consume a larger share of the forecasted increase in natural gas demand in the coming decades.

In Fig. 3, the amount of natural gas used for electricity generation is projected to triple by 2020 [2]. Seven states (Rhode Island, New York, Delaware, Louisiana, Texas, California, and Alaska) currently obtain over one-third of their electricity generation from natural gas. The primary reason for this increase is that the natural gas is the preferred fuel for more than 96% of the 200 new generation projects in the United States. This dramatic shift to natural gas is further driven by improved efficiencies, lower capital costs, reduced

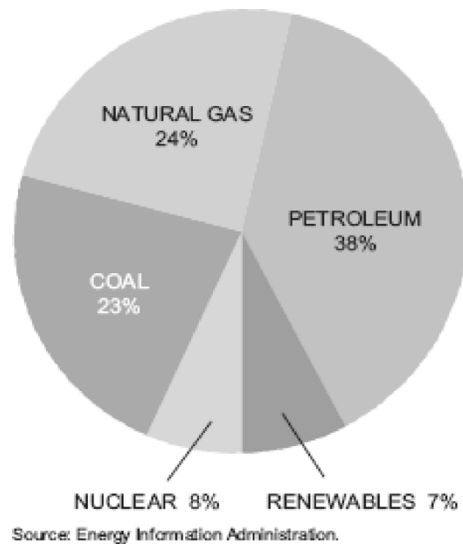

Fig. 2. Average annual fuel for electricity generation in 1997–2001.

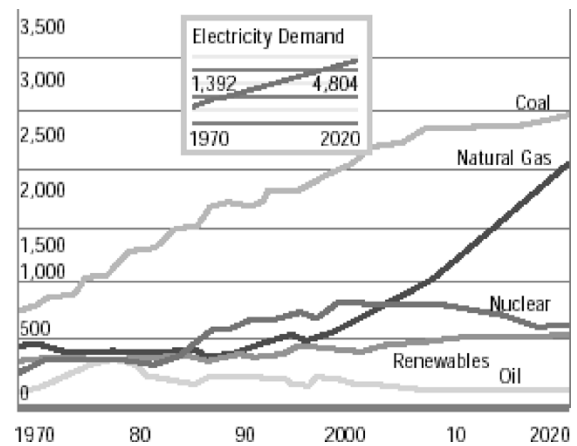

Fig. 3. Electricity generation by fuel (billions of kilowatt-hours).

construction time, more expeditious permitting, and environmental compliance of natural gas-burning combined-cycle units.

The possibility of replacing coal and oil burning plants with natural gas plants could greatly improve the sustainability of forests, waters, and farmlands, which are negatively affected by acid deposition. It is imperative to recognize that no new nuclear capacity construction is projected in the near future and an estimated 15 GW of nuclear generation capacity is projected for retirement by 2015 as some licenses expire. Nuclear retirements could further increase the need for natural gas infrastructure in the 2015 time frame.

A. Natural Gas Transportation System

In 1984, the U.S. Federal Energy Regulatory Commission (FERC) took the first step toward addressing the pipeline competition with an order to eliminate a requirement that gas utilities purchase natural gas from interstate pipelines. FERC Orders 436 and 500 required interstate pipelines to provide nondiscriminatory service to all transporters of natural gas.

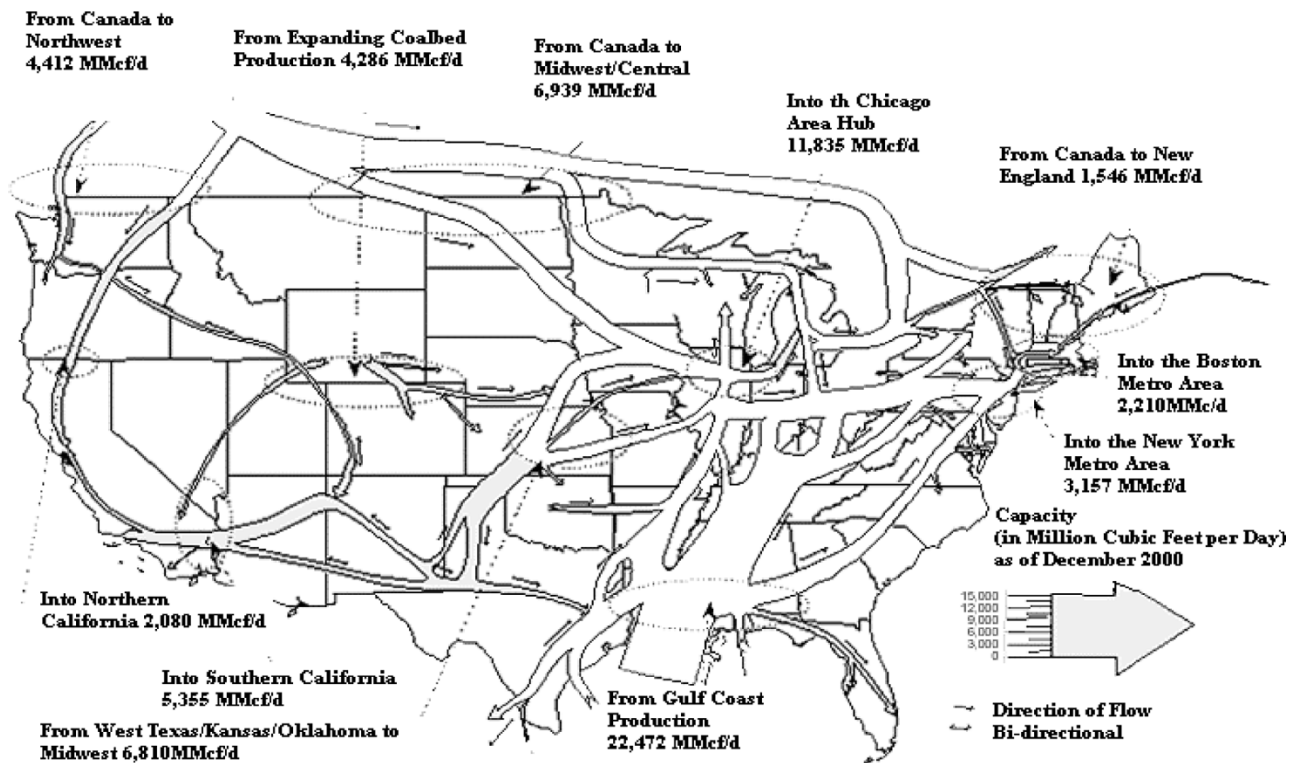

Fig. 4. Major natural pipeline transportation routes and capacity level at key locations.

With the move to competition, however, the natural gas utilities are no longer responsible for assuring sufficient supplies on interstate pipeline for noncore natural gas customers including commercial customers and electric generators. These customers will have to acquire interstate pipeline capacity while gas utilities are responsible for assuring that the intrastate gas system is adequate to receive the flow from the interstate pipelines.

Fig. 4 shows the major natural gas pipeline transportation routes and capacity levels at key locations in the year 2000 [3], [4]. Natural gas is produced primarily at remote sites and more than 250 000 miles of transmission pipelines, 1 million miles of distribution pipelines, vast underground storage facilities, and thousands of compressors are constructed throughout the nation to deliver the natural gas from wellheads to power generating sites and end users.

At the same time, over 38 000 miles of new transmission pipeline as well as 263 000 miles of distribution mains and almost 0.8 trillion cubic feet (TCF) of new gas storage capacity are projected through 2015. The current domestic natural gas transmission capacity of approximately 23 TCF will be insufficient to meet the projected 50% increase in U.S. consumption for 2020. Certain regions like California and New England have already faced gas capacity shortages.

One of the largest natural gas reserves in the United States, with over 35 TCF capacity, is in the Arctic, which is associated with the development of oil at Alaska's Prudhoe Bay. Moreover, there may be an additional 100 TCF on the North Slope of Alaska [4].

These gas reserves would make a significant long-term contribution to the nation's energy supplies once it is deliv-

ered to the lower 48 states. The proposed gas transmission capacity extends from the Rockies to California, Canadian Atlantic to New England, Gulf of Mexico to Florida, western Canada to the Pacific Northwest, and the MacKenzie Delta to Alberta.

II. INTERDEPENDENCY OF GAS AND ELECTRICITY

Issues related to interdependency are listed as follows.

- In restructured electricity markets, the Independent System Operator (ISO) executes security-constrained unit commitment (SCUC) to minimize the generation cost on the premise of meeting the network security constraints. The gas market price will directly affect the commitment, dispatch, and generation cost of units. If the natural gas price lacks a competitive edge with respect to those of alternative fossil fuels, such as coal and oil, the market could switch from generating units which utilize natural gas to those with lower cost fuels.
- An interruption or pressure loss in gas pipeline systems may lead to a loss of multiple gas-fired electric generators, which could dramatically reduce the supplied power and jeopardize the power system security. Although, in the case of certain pipeline contingencies, underground gas storage facilities can provide the backup for the natural gas supply to some of the units, the power dispatch and pertinent market decisions could be affected by gas pipeline constraints and gas storage shortfalls.
- In severe weather situations (e.g., hot summer or unusually cold winter days), the demand for electricity

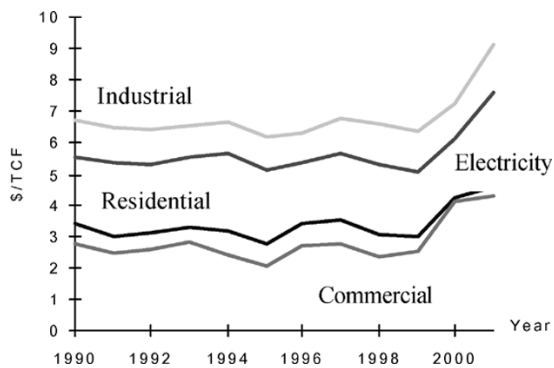

Fig. 5. Natural gas prices by sector.

and gas may peak together, which could cause a spike in energy price. In such cases, gas price hikes could push up the marginal cost of gas-fired generating units, which would directly translate into higher market prices for electricity. For instance, in the 2000–2001 winter, gas and electricity markets in California approached their capacity limits concurrently. At that time, natural gas prices often exceeded \$10/MBtu and peaked at \$60/MBtu. As a result, wholesale electricity prices ranged from \$50/MWh to \$580/MWh [5].

- In the event of outages of gas pipelines or power transmission systems, inconsistent curtailment proceedings of natural gas supplies to gas-fired generators without dual fuel capacity could constrain the power system operation and even lead to additional outages.
- Since 2000, the North American natural gas market has remained tight due to strong demand and lower supplies, which resulted in substantially higher prices for electricity generated with natural gas. Fig. 5 shows the natural gas real prices by sector. In addition, low gas prices in 1998 and 1999 caused the industry to scale back gas exploration and production activity [6]. Such incidents could yield major impacts on generation scheduling, production cost, electricity price, power transmission congestion management, and emission of the electric power system infrastructure.

Differences between natural gas and electricity systems are given as follows.

- Electricity moves at the speed of light, while natural gas travels 40–60 mi/h.
- Electricity is not a storable commodity. So the contingency-constrained network flow operation could preclude transmission systems from utilizing their maximum capacity. Accordingly, the value of a transmission line may not necessarily be reflected in its current flow. The ability to store gas in tanks and in pipelines alleviates this problem for gas. Natural gas utilities typically rely on the natural gas storage to augment supplies flowing through the pipeline system and to meet the total natural gas demand throughout the year. A natural gas system designed to meet peak demands that does not include storage would be significantly more costly.

- Economies of scale are very large in electric power transmission projects. It is much cheaper to install the required capacity of a transmission line initially than to retrofit the line later. However, gas pipelines are commonly operated at a lower pressure and the pressure is raised later to obtain additional capacity.
- Natural gas pipeline flows can be controlled independent of the gas network constituents. However, it is neither economical nor practical at this time to control individual power transmission segment flows.

III. SECURITY OF GAS AND ELECTRICITY

The interdependency of gas and electricity infrastructures will support the social sustainability of energy infrastructure. However, the gas and electricity interdependency could inevitably result in a new electric supply risk on a significantly large scale associated with the security of natural gas infrastructure. The additional gas infrastructure which is necessary for supporting the economic growth of our nation could greatly increase the vulnerability of gas pipelines from the security viewpoint and complicate the monitoring and control of electric power systems.

Some of the proposals for securing gas and electricity infrastructures are outlined below.

A. Resource Diversity

Deployment of renewable and distributed units (such as pumped-storage hydro, photovoltaic (PV)/battery, and cogeneration which captures waste heat for energy) at load centers could promote energy efficiency and reduce the dependence of electricity infrastructure on the gas infrastructure system and enhance the security of electric power systems.

B. Least Cost Dispatch

As long as the natural gas is readily available, electric power companies will utilize the cleaner and more efficient combined-cycle units for supplying loads in a competitive electricity market. However, the utilization of more sophisticated energy management techniques, such as SCUC, could utilize the least cost commitment and dispatch while preventing an excessive utilization of combined-cycle units, which could inflate natural gas prices. The least cost dispatch of other units could also mitigate shortages of natural gas supply at peak load periods while maintaining the power system security.

C. Load Shedding Scheme

Although it is not a favorable approach to maintaining the security of the natural gas supply and electric power network, respective industries must prepare a comprehensive approach to load shedding and system restoration for retaining the security of the infrastructures in the case of massive contingencies.

D. Coordination

Although restructured gas and electricity infrastructures are operated independently and based on their respective operating guidelines and market competition rules, the coordination and cooperation between gas and electricity industries will be absolutely essential for maintaining a cheap, reliable, and continuous supply of power service to end users. This coordination and cooperation may be extended to a joint on-line control and monitoring of the two infrastructures using the global positioning system (GPS) and geographical information system (GIS).

E. Communication

Gas supply availability and contingencies, and the corresponding remedial actions, should be communicated regularly to day-ahead power generation schedulers, while the power system operators are obliged to provide the similar information on pertinent power supply contingencies and possible remedial solutions to natural gas companies.

F. Integrated Resource Planning

It is essential to include the gas infrastructure model in electricity planning. The integrated system planning could identify the optimal locations for new generating units and the required enhancements for transmission lines in order to utilize fuel diversity and mitigate the intense reliance of power generation on natural gas.

G. Fuel Diversity

The ability of a generating unit to switch from natural gas to other types of fuels (fuel switching capability) at peak hours and at high demand for gas seasons could buffer short-term pressures on the balance of natural gas and electricity supply/demand. Fuel diversity is an effective gas demand peak shaving strategy that could reduce upward price volatility for gas and electricity. Increasing fuel diversity and the installation of new generation units with fuel switching capability could reduce greater gas consumptions over the life of the new generating capacity in a competitive electricity market.

H. Expansion of Natural Gas and Electricity Infrastructures

While North America has very sizable natural gas resources, existing supplies are unlikely to meet projected demand growth. As a result, new sources of supply must enter the natural gas market, and existing infrastructures in gas and electricity ought to be expanded and modernized in order to reduce forced outages and meet the volatile demand in a strong economy.

Among the listed issues, this paper will mainly analyze the role of natural gas infrastructure in supplying the ever-increasing number of gas-powered generating units. The paper will use SCUC to exhibit the impact of natural gas pipeline contingencies on the security of electric power systems. The paper will also consider the role of fuel diversity, load shedding, volatile gas prices, and unconventional generating sources on the economic operation of electric power systems.

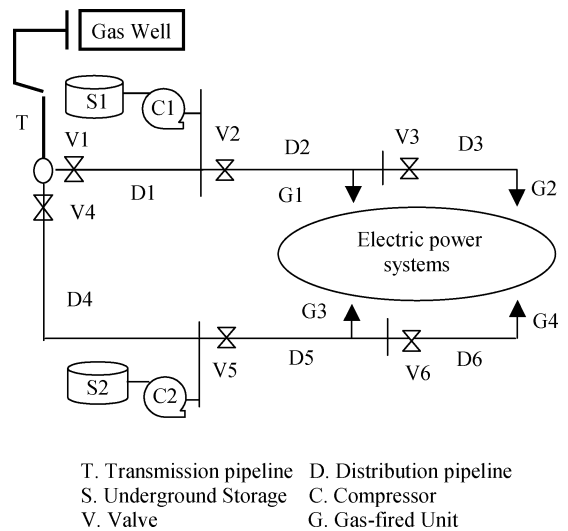

Fig. 6. Gas flow infrastructure from wellhead to gas-fired units.

The rest of the paper is organized as follows. Section IV describes the gas pipeline infrastructure model. Section V presents a high-efficiency gas-burning combined-cycle unit. Section VI shows the mathematical model of SCUC with the prevailing constraints, such as generation, reserve, system security, fuel, and emission constraints. Section VII presents and discusses a 118-bus test case with gas pipelines. The conclusion drawn from the study is provided in Section VIII.

IV. GAS PIPELINE INFRASTRUCTURE

Delivering the natural gas from a gas wellhead to end customers is represented by an enormous section of the gas industry, which entails gas wells, transmission and distribution pipelines, underground storages, compressors, and valves. Fig. 6 shows a simplified natural gas flow path from a gas wellhead to gas-fired units, which is utilized in this study for analyzing the impact of natural gas system infrastructure security on electric power systems control and economics.

A. Key Components of Gas Infrastructure System

Gas Well: A gas well is commonly located at sites which are far from load centers. Gas wells can be classified into offshore and onshore. The total number of oil and gas wells drilled per year (including dry holes) will have to be doubled from approximately 24 000 in 1998 to over 48 000 by 2015, as the demand for natural gas increases over the next decades [7], [8].

Transmission Pipelines: Transmission pipelines undertake the responsibility of transporting natural gas from wellheads or producers to local distribution companies or directly to large commercial and industrial users. Pipelines operating entirely in one state are called intrastate pipelines, whereas interstate pipelines extend across several states. In restructured electricity markets, gas transmission companies have unbundled sales and transportation functions and have provided open access on pipelines to other market participants for gas delivery, which has permitted producers to sell gas directly to end users and marketers. The gas market

competition has provided to end users cheaper and more flexible options for purchasing gas fuel.

Distribution Pipelines: Distribution pipelines generally provide the final link in the natural gas delivery chain. Distribution pipelines, which comprise the largest section (over 1 million mi) in the natural gas system, deliver natural gas from city gate stations, underground storage facilities, and other gas supply sources to local industrial, as well as commercial and residential, customers. These pipelines operate at a lower pressure level than transmission pipelines and offer different pressure services for different customers by adjusting the associated pressure regulators. For instance, pipelines connected to gas-burning power plants require high-pressure services. However, residential customers would need low-pressure gas for appliances.

Underground Storage: Unlike electric power systems, which must constantly monitor the entire system and adjust to changes instantaneously as electricity demand fluctuates, the gas industry can inject gas into certain underground storage facilities during off-peak periods for mitigating the high demand during peak hours and maintaining a steady flow through other pipelines when contingencies occur. In uncertain market conditions, reasonable planning and construction of underground storage facilities will become more critical. Generally as backup, underground storage facilities should be located near load centers (e.g., fleet of gas-fired generating units) in a market.

Compressor: A compressor functions similar to step-up transformers in electric power systems. As gas is transported through a pipeline, its pressure would drop. Thus, the compressor must be an imperative component in natural gas systems to maintain the desired pressure level in the transmission and distribution pipelines. In Fig. 6, compressors are placed close to underground storage. Additional compressors can be installed along pipelines (commonly at 50–100-mi intervals). The optimized placement of compressors in pipeline planning could decrease the operation cost dramatically, improve the market competition, and guarantee a reliable gas supply to customers.

Valve: A valve is a protective device which functions similar to breakers, fuses, and switches in electric power systems. It can isolate faulted sections and maintain the operation of other components in natural gas systems by retaining a desired pressure level.

B. Outage Analyses

Since a considerable amount of power generation could be interrupted due to outages in gas distribution systems, gas distribution systems are studied here more intensely. Classical techniques such as fault tree, cut sets, Markov chains, and Monte Carlo simulations could be employed for evaluating the reliability and the availability of a gas/electric composite system [9]. However, in this paper we focus on the short-term operation of gas/electric composite system and evaluate the consequences of gas system failures, fluctuations in gas and electricity prices, and power generation scheduling constraints on electricity market operations.

Table 1
Outage Analyses

Outage	Action	Results
D3	V3 Shuts off	Stops supplying gas to G2
V3	V2 Shuts off	Stops supplying gas to G1, G2
D2	V2 Shuts off	Stops supplying gas to G1, G2
V2	V1 Shuts off	Stops supplying gas to G1, G2
D1	V1 Shut-off	S1 supplies limited gas to G1, G2
V1	T Shuts off	S1 supplies limited gas to G1, G2 S2 supplies limited gas to G3, G4
D6	V6 Shuts off	Stops supplying gas to G4
V6	V5 Shuts off	Stops supplying gas to G3, G4
D5	V5 Shuts off	Stops supplying gas to G3, G4
V5	V4 Shuts off	Stops supplying gas to G3, G4
D4	V4 Shuts off	S2 supplies limited gas to G3, G4
V4	T Shuts off	S1 supplies limited gas to G1, G2 S2 supplies limited gas to G3, G4

The following assumptions are for the modeling of natural gas network outages.

- A two-state up/down model is considered for the operation of each component in gas systems.
- All failures are statistically independent.
- Any protective device, such as a valve, has the function of fault isolation. A fault in radial systems is isolated by its nearest source-side valve. A fault in meshed systems is isolated by its nearest set of valves. In Fig. 6, in the case of a leak on distribution pipeline D3, the nearest valve V3 will shut off momentarily to avoid the loss of gas, while the remaining system maintains a normal pressure level. In the case of a fault on valve V3, gas supplies to generators 1 and 2 will be interrupted by valve V2.
- Underground storage facilities are backup for supplying gas to associated units during peak demands or when faults occur on certain components. In Fig. 6, if there is a leak in distribution pipeline D1, storage 1 will use compressor 1 to provide a limited gas supply to generators 1 and 2.

Table 1 shows postcontingency control actions and results in the event of $N - 1$ outages in the gas distribution system of Fig. 6. The availability of large quantities of natural gas and market competitions for electricity coupled with a widespread concern for the environmental effects of traditional thermal units have resulted in widely utilized gas-fired generating units in unbundled electric power systems. However, further attention is focused on high efficiency and flexibility of combined-cycle units. Synthesized from traditional gas and steam turbine technology, combined-cycle gas turbines appear to be at a sufficiently mature stage of development for taking advantage of the market-driven economic climate. In the following, we discuss the benefits of utilizing combined-cycle units in electricity markets.

V. COMBINED-CYCLE UNITS

Primary reasons for the success of combined-cycle plants in electricity markets are listed below.

A. High Efficiency

Traditional gas-fired units generally expel the waste gas without any further utilization, which leads to a relatively low

efficiency of energy conversion. In contrast, combined-cycle units have two cycles for generating the electricity. In the first cycle, natural gas and compressed air from a combustion turbine compressor are mixed and burned in a combustion chamber. The energy released during the combustion is used to turn a turbine. The turbine drives a generator to make electricity. The heat captured from exhaust gases—heat that would otherwise be wasted—is used in generating steam in the heat recovery, which is sent to turn a steam turbine. The steam turbine in turn, drives an electric generator to make additional electricity [10]. The total efficiency of energy conversion of combined-cycle plant can reach 60%, an almost 20%–30% improvement of conversion efficiency over traditional thermal plants [11].

B. Fast Response

The mid-1960s brought about a significant breakthrough for gas turbines manufacturers. Blackouts in the electricity systems of the U.K. and North America led to the installation of a large number of fast response units for use in emergencies. The restructuring of gas and electricity industries allowed turbine manufacturers to introduce new technologies that were applied to jet engines for enhancing the design of gas units. In today's power market environment, where electricity price and load demand are often uncertain, combined-cycle units are quite instrumental in facing rapid changes in markets [12]–[14].

C. Environmentally Friendly

The carbon dioxide production of a gas-fired combined-cycle plant is much lower than that of other fossil fuel technologies because of the relatively high thermal efficiency of the combined-cycle technology and the high hydrogen–carbon ratio of methane, which is the primary constituent of natural gas. A typical combined-cycle plant would produce about 0.8 lb CO₂ per kilowatt-hour output as compared with that of a new coal-fired power plant, which is about 2 lb CO₂ per kilowatt-hour [15]. Other types of environmentally hazardous exhaust gas, including nitrogen oxides (NO_x), carbon monoxide (CO), and sulfur dioxide (SO₂) are reduced in combined-cycle units to much less than those from other types of thermal plants.

D. Flexibility

Combined-cycle plants are extremely flexible, as they can operate by burning a wide range of fuels from clean natural gas and distillate oil fuels to ash-bearing crude oil and residual oil fuels. The commercial size combined-cycle units have been operated with coal-derived gas fuels. Combined-cycle equipment costs higher than that for conventional steam plants due to the newer technology and the type of material used in the design of combined-cycle plants. However, the installation cost of a combined-cycle plant is significantly lower, resulting from the reduced installation cycle [16]. Combined-cycle units are very compact, which save the square footage requirement and can be installed within a short period.

In the following, we discuss the problem formulation for studying the gas/electric interdependence and analyzing

the significance of natural gas infrastructure protection for supporting the electricity market operation. The formulation is based on the SCUC algorithm. The power system example that we study in this paper will include various thermal, hydro, as well as PV and battery units.

VI. PROBLEM FORMULATION

The SCUC software is executed by an ISO (such as the PJM ISO or the New York ISO) which is in charge of managing the transmission system. The ISO provides a unit commitment with minimum cost for all available generators while preserving the network security. The objective function of SCUC for minimizing the generation cost is formulated as follows:

$$\text{Min} \sum_{i=1}^{\text{NG}} \sum_{t=1}^{\text{NT}} [F_{ci}(P_{it}) * I_{it} + \text{SU}_{it} + \text{SD}_{it}]. \quad (1)$$

Function (1) is composed of the production cost and the start-up and shutdown costs of individual units. The production cost of a combined-cycle unit is equal to the gas market price times its gas consumption. Thus, lower fuel prices could result in higher marketability for combine cycle units with lower generation costs.

The SCUC formulation with thermal constraints is discussed here. The formulation of cascaded hydro, pumped-storage, and PV/battery units is given in Appendixes A–C. Thermal unit constraints include the system power balance (2), system spinning and operating reserve requirements (3), ramping up/down limits (4), minimum up/down time limits (5), unit generation limits (6), and network flow limits (7). Additional system-wide constraints such as fuel constraints (8) and emission limits (9) are included in this formulation for representing the interactions among electricity market, fuel market, and environment

$$\sum_{i=1}^{\text{NG}} P_{it} * I_{it} = P_{D,t} \quad (t = 1, \dots, \text{NT}) \quad (2)$$

$$\sum_{i=1}^{\text{NG}} R_{S,it} * I_{it} \geq R_{S,t}$$

$$\sum_{i=1}^{\text{NG}} R_{O,it} * I_{it} \geq R_{O,t} \quad (t = 1, \dots, \text{NT}) \quad (3)$$

$$\begin{aligned} & P_{it} - P_{i(t-1)} \\ & \leq [1 - I_{it}(1 - I_{i(t-1)})] \text{UR}_i + I_{it}(1 - I_{i(t-1)}) P_{i,\min} \\ & P_{i(t-1)} - P_{it} \\ & \leq [1 - I_{i(t-1)}(1 - I_{it})] \text{DR}_i + I_{i(t-1)}(1 - I_{it}) P_{i,\min} \\ & (i = 1, \dots, \text{NG}) \end{aligned} \quad (4)$$

$$\begin{aligned} & [X_{i(t-1)}^{\text{on}} - T_i^{\text{on}}] * [I_{i(t-1)} - I_{it}] \geq 0 \\ & [X_{i(t-1)}^{\text{off}} - T_i^{\text{off}}] * [I_{it} - I_{i(t-1)}] \geq 0 \\ & (i = 1, \dots, \text{NG})(t = 1, \dots, \text{NT}) \end{aligned} \quad (5)$$

$$\begin{aligned} & P_{i,\min} I_{it} \\ & \leq P_{it} \leq P_{i,\max} I_{it} \quad (i = 1, \dots, \text{NG})(t = 1, \dots, \text{NT}) \quad (6) \\ & - \text{PL}_{km}^{\max} \leq \text{PL}_{km,t} \leq \text{PL}_{km}^{\max} \quad (7) \end{aligned}$$

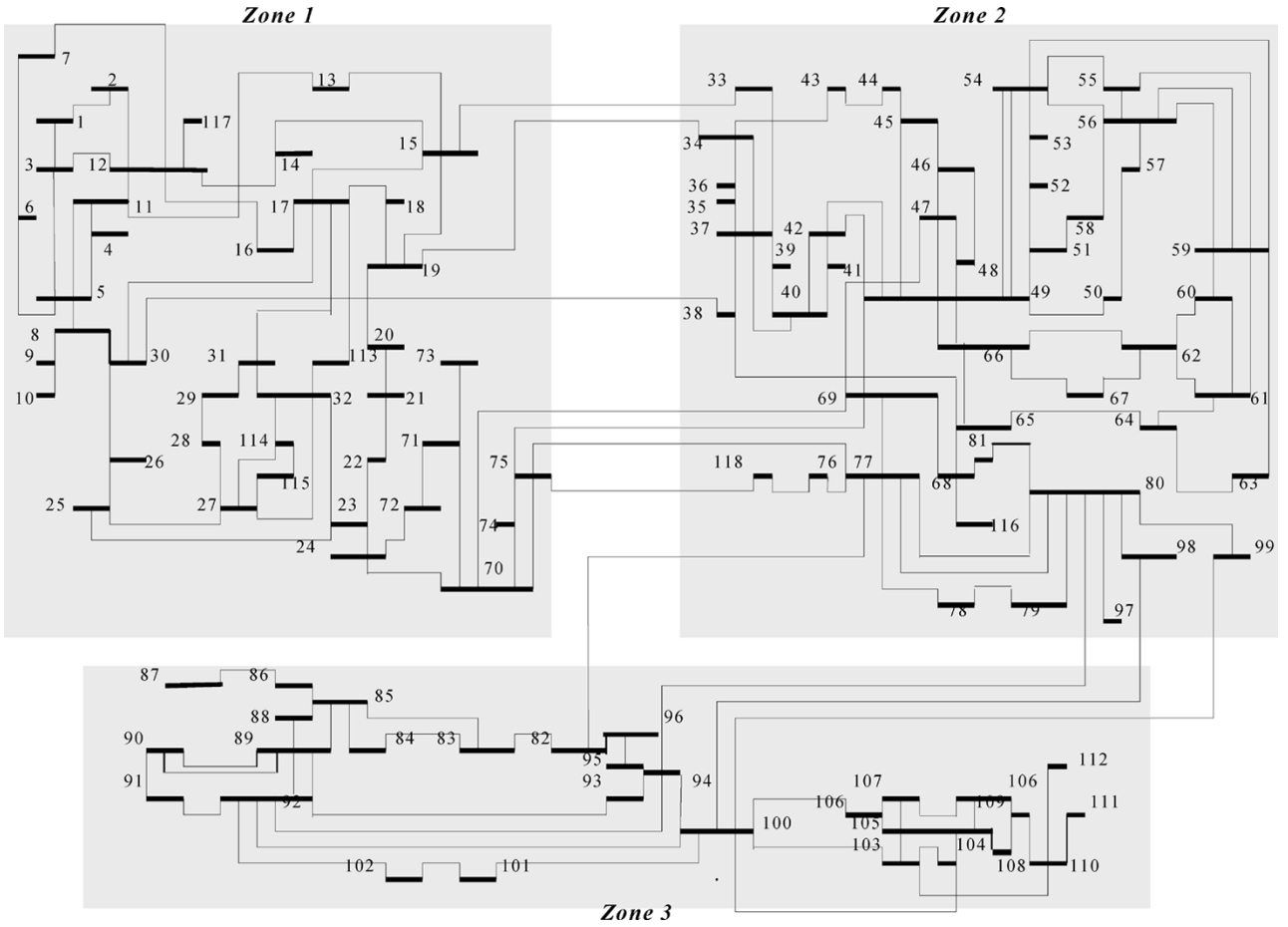

Fig. 7. One-line diagram of 118-bus system.

$$F_{FT}^{\min} \leq \sum_{t=1}^{NT} \sum_{i \in FT} [F_{fi}(P_{it}) * I_{it} + SU_{f,it} + SD_{f,it}] \leq F_{FT}^{\max} \quad (8)$$

$$\sum_{t=1}^{NT} \sum_{i=1}^{NG} [F_{ei}(P_{it}) * I_{it} + SU_{e,it} + SD_{e,it}] \leq E_S^{\max}. \quad (9)$$

The optimal generation scheduling of combined-cycle units is more cumbersome than that of traditional thermal units because of the multiplicity of its configuration. Accordingly, (6) in the above list of equations for thermal generating units would be rewritten as follows. In the following, (10) shows that the generation of a combined-cycle unit i at any time is equal to the sum of generation by its individual configurations. The generation by each configuration would have to satisfy lower and upper limits (11). Also, (12) shows the generating unit configurations are exclusive and each combined-cycle unit can operate at most in one of the configurations at any given time [17]

$$P_{it} = \sum_{k=1}^{N_{cfg,i}} P_{ikt} * U_{ikt} \quad (10)$$

$$P_{ik,\min} * U_{ikt} \leq P_{ikt} \leq P_{ik,\max} * U_{ikt} \quad (11)$$

$$\sum_{k=1}^{N_{cfg,i}} U_{ikt} = \begin{cases} 1 & \text{ON} \\ 0 & \text{OFF} \end{cases} \quad (t=1, \dots, NT)(k=1, \dots, N_{i,cfg}). \quad (12)$$

In order to solve SCUC, the problem is decomposed into a master problem and a subproblem based on the Benders decomposition. In the master problem, while disregarding the network constraints, Lagrangian Relaxation (LR) is employed for unit commitment with relaxed constraints (2,3,8,9). The relaxed master problem is decomposed into N subproblems for each unit and dynamic programming (DP) with minimum up/down time limits (5) and ramp rate limits (4) is used to search the optimal commitment for a single unit over the study period. Then, Lagrangian multipliers are updated based on the relaxed system violations. The convergence criterion is satisfied if the duality gap between primal and dual solutions in LR is within a given limit [18], [19]. In the subproblem, the network security is checked and if a violation exists the corresponding Benders cut will participate in the next calculation of the master problem. Otherwise, the iteration will stop [20]–[24].

VII. CASE STUDIES

A modified IEEE 118-Bus network topology is shown in Fig. 7. The system represents generating companies which provide hourly generation bids to the ISO. The ISO will apply SUCU for the commitment of generating units and managing the transmission congestion. The IEEE 118-bus system has 186 branches and is divided into three zones (1, 2, and 3) with a peak load of 4666.20 MW at hour 18.

The zonal boundaries are defined based on the historical Location Marginal Price (LMP) data which signify interzonal lines with heaviest flows between the three zones.¹

To facilitate our study, we consider the following two generating systems.

System A: 33 thermal units and seven cascaded hydro plants representing two catchments with four and three hydro plants, respectively.

System B: 12 thermal units in System A are replaced with 12 combined-cycle units. The 12 combined-cycle units are divided into four groups in three zones: two groups in Zones 1 and 3 and two groups in Zone 2 (i.e., Zone 2A and Zone 2B).

The case studies include:

- Case 1: fast response of combined-cycle units;
- Case 2: environmental impact of combined-cycle units;
- Case 3: impact of gas price on combined-cycle units;
- Case 4: impact of gas infrastructure outages on LMP;
- Case 5: impact of pumped-storage hydro plants;
- Case 6: impact of PV/battery system.

In cases 1 and 2, we will analyze the merits of utilizing gas-fired combined-cycle units in electric power systems. It is shown that combined-cycle units present significant operational and economical advantages over the traditional thermal units in a competitive electricity market. In case 3, we show that the merits of combined-cycle units could be flawed by the unavailability or higher prices of natural gas. In case 4, we study the impact of gas pipeline outages on the dispatch of gas-fired units, power transmission congestion, and LMPs. It is shown in this case that fuel diversity plays a major role in the power system operation when more traditional units (coal, oil, nuclear) are utilized to supply the load. In case 4, we also consider load shedding as a possible option for mitigating a tie line congestion in the case of contingencies. Furthermore, in case 5, we consider the installation and the utilization of pumped-storage hydro units for mitigating the congestion in case 4. The point in case 5 is that the diversity of generating resources, fuel diversity, and the use of renewable energy may serve as alternatives for reducing the reliance on combined-cycle units when the natural gas flow is interrupted intentionally, its availability has become scarce because of gas infrastructure malfunctions, or gas price is hiked in the market. In case 6, we consider PV/battery as a local alternative for mitigating the power flow congestion and reducing LMPs, if the alternatives presented in cases 4 and 5 cannot be fully utilized. These cases are discussed further as follows.

A. Case 1: Fast Response of Combined-Cycle Units

The thermal constraints such as the minimum ON/OFF times could prevent large generators from responding quickly to hourly load changes. Table 2 represents the daily commitment of large thermal units (i.e., 350–400 MW)

¹The test data for the 118-bus system are given in <http://motor.ece.iit.edu/data/gaspaper.xls>

Table 2
Daily Schedule Thermal Units (System A)

Unit	Hour												
	0	1	2	3	4	5	6	7	8	9	10	11	12
25	1	1	1	1	1	1	1	1	1	1	1	1	1
26	1	1	1	1	1	1	1	1	1	1	1	1	1
27	1	1	1	1	1	1	1	1	1	1	1	1	1
28	1	1	1	1	1	1	1	1	1	1	1	1	1
29	1	1	1	1	1	1	1	1	1	1	1	1	1
30	1	1	1	1	1	1	1	1	1	1	1	1	1
31	1	1	1	1	1	1	1	1	1	1	1	1	1
32	1	1	1	1	1	1	1	1	1	1	1	1	1
33	1	1	1	1	1	1	1	1	1	1	1	1	1

Unit	Hour													
	13	14	15	16	17	18	19	20	21	22	23	24		
25	1	1	1	1	1	1	1	1	1	1	1	1	1	
26	1	1	1	1	1	1	1	1	1	1	1	1	1	
27	1	1	1	1	1	1	1	1	1	1	1	1	1	
28	1	1	1	1	1	1	1	1	1	1	1	1	1	
29	1	1	1	1	1	1	1	1	1	1	1	1	1	
30	1	1	1	1	1	1	1	1	1	1	1	1	1	
31	1	1	1	1	1	1	1	1	1	1	1	1	1	
32	1	1	1	1	1	1	1	1	1	1	1	1	1	
33	1	1	1	1	1	1	1	1	1	1	1	1	1	

Table 3
Configurations of (2CTS, 1ST)

Configuration Number	Components
1	1CT + 0ST
2	2CT + 0ST
3	1CT + 1ST
4	2CT + 1ST

in System A. The table shows that the listed units are committed between hours 2 and 8 when the system load is low. The commitment at these hours is due to minimum ON/OFF constraints, which will force large units to remain in operation even when it is uneconomical to do so.

In contrast, combined-cycle units with multiple configurations in System B provide a wider range of options (between ON/OFF states) to respond to hourly load changes. Table 3 lists possible configurations of a combined-cycle unit with two combustion turbines (CT) and one steam turbine (ST). At each load level, the SCUC solution will choose the best configuration for maximizing the scheduling of combined-cycle units. Table 4 shows the daily schedules of combined-cycle units in System B in which some of the combined-cycle units have switched to configuration 3 between hours 2 and 8 when the load level is low. This alternative is much more economical than operating the units at configuration 4.

The transition between configurations 3 and 4 is very quick so the units could adjust quickly to lower values of load.

Table 4
Schedule of Combined-Cycle Units (System B)

Unit	Hour												
	0	1	2	3	4	5	6	7	8	9	10	11	12
401	0	0	0	0	0	0	0	0	0	0	0	0	0
402	4	4	3	3	3	3	3	3	3	4	4	4	4
403	4	4	4	4	4	4	4	4	4	4	4	4	4
404	0	0	0	0	0	0	0	0	0	0	0	0	0
405	0	0	0	0	0	0	0	0	0	0	0	0	0
406	4	4	4	3	3	3	3	3	4	4	4	4	4
407	4	4	3	3	3	3	3	3	3	4	4	4	4
408	4	4	3	3	3	3	3	3	3	4	4	4	4
409	4	4	3	3	3	3	3	3	3	4	4	4	4
410	0	0	0	0	0	0	0	0	0	0	0	0	0
411	0	0	0	0	0	0	0	0	0	0	0	0	0
412	4	4	4	3	3	3	3	3	4	4	4	4	4

Unit	Hour												
	13	14	15	16	17	18	19	20	21	22	23	24	
401	0	0	0	0	0	0	0	0	0	0	0	0	0
402	4	4	4	4	4	4	4	4	4	4	4	4	4
403	4	4	4	4	4	4	4	4	4	4	4	4	4
404	0	0	0	0	0	0	0	0	0	0	0	0	0
405	0	0	0	0	0	0	0	0	0	0	0	0	0
406	4	4	4	4	4	4	4	4	4	4	4	4	4
407	4	4	4	4	4	4	4	4	4	4	4	4	4
408	4	4	4	4	4	4	4	4	4	4	4	4	4
409	4	4	4	4	4	4	4	4	4	4	4	4	4
410	0	0	0	0	0	0	0	0	0	0	0	0	0
411	0	0	0	0	0	0	0	0	0	0	0	0	0
412	4	4	4	4	4	4	4	4	4	4	4	4	4

B. Case 2: Environmental Impact of Combined-Cycle Units

The natural gas burned by combined-cycle units is cleaner than other types of fossil fuel at the same time that several remedial procedures are applied to combined-cycle plants to absorb its hazardous exhaust. Hence, combined-cycle units generally have a lower level of emission production than that of traditional single cycle thermal units per unit of power production.

In Case 2, we use SCUC to calculate initially the daily scheduling of System A without considering system emission constraints. Then we introduce the system emission constraint with a daily limit of 280 000 lbs. Table 5 shows the two schedules in which the emission coefficient represents a coefficient that is multiplied by the heat rate curve of the thermal unit to represent the emission at different generation levels. Since we assume that cheaper coal units have larger emission coefficients, these units will be constrained more by their emission cap as shown by the shadowed block in Table 5.

On the other hand, units with lower emission coefficients (generally more expensive units) will have a chance to generate more power to meet system load requirements

Table 5
Daily Generation and Emission Constraint (System A)

Unit # , Emission Coefficient (lbs/MBtu)	Daily Gen (MWh)		Unit # , Emission Coefficient (lbs/MBtu)	Daily Gen (MWh)	
	Emission Limit			Emission Limit	
	With	Without		With	Without
1, 0.0	7.20	2.40	18, 0.0	3720.00	2448.64
2, 0.0	0.00	0.00	19, 0.1	3720.00	2386.38
3, 0.0	0.00	0.00	20, 0.1	0.00	0.00
4, 0.0	0.00	0.00	21, 0.1	0.00	0.00
5, 0.0	0.00	0.00	22, 0.1	0.00	0.00
6, 0.0	0.00	4.00	23, 0.0	0.00	0.00
7, 0.0	0.00	4.00	24, 0.0	0.00	0.00
8, 0.1	494.00	123.40	25, 0.4	5474.88	6562.27
9, 0.1	646.00	241.27	26, 0.4	5284.28	6408.79
10, 0.1	494.00	236.40	27, 0.4	6559.09	7271.96
11, 0.1	494.00	136.00	28, 0.4	4550.47	5750.65
12, 0.0	25.00	25.00	29, 0.4	9402.42	9588.80
13, 0.0	278.63	25.00	30, 0.4	9375.10	9584.01
14, 0.1	0.00	0.00	31, 0.4	9349.24	9579.70
15, 0.1	0.00	0.00	32, 0.4	9307.99	9572.81
16, 0.1	100.00	100.00	33, 0.4	9165.17	9548.90
17, 0.0	3720.00	2521.29			

while satisfying the system emission constraint. In Table 5, the daily generation cost will increase from \$856 958.44 to \$867 365.00 after considering the emission limit. As for System B, the inclusion of emission cap does not change the generation schedule, nor does it increase the generation cost in Table 6, which implies the benefit of utilizing combined-cycle units in a competitive market.

C. Case 3: Impact of Gas Price on Combined-Cycle Units

The previous case studies demonstrated the benefits of utilizing combined-cycle units in daily power generation. However, the emergence of combined-cycle units will constrain the gas pipeline infrastructure further and the availability of reasonably priced gas will be a major issue in a competitive electricity market. The shortages in gas supply and the higher priced gas should directly affect the commitment and the operation of combined-cycle units.

Fig. 8 illustrates the dispatch of combined-cycle units as a function of the market gas price. The first value on the horizontal axis represents the base price for gas. As the base gas price increases in the market, combined-cycle units could lose their competitive advantage when competing with other types of thermal units, even though the combined-cycle units have high efficiency. As gas prices increase, combined-cycle units could cut back on their generation level or be decommitted to reduce the daily generation cost. For instance, the daily generation of combined-cycle units is reduced from 33 831.57 to 29 539.99 MWh when gas price increases by 15%. At the same time, other thermal units would increase their generation level or be committed to meet the system load requirement. This example supports the notion of fuel

Table 6
Daily Generation of System B

Unit	Daily Gen (MWh)	Emission Coefficient (lbs/MBtu)	Unit	Daily Gen (MWh)	Emission Coefficient (lbs/MBtu)
1	0.00	0.0	29	9600.00	0.4
2	0.00	0.0	30	9600.00	0.4
3	0.00	0.0	32	9600.00	0.4
4	0.00	0.0	33	9579.79	0.4
5	0.00	0.0	401	0.00	0.1
6	0.00	0.0	402	2926.85	0.1
7	0.00	0.0	403	9600.00	0.1
9	15.20	0.1	404	0.00	0.1
10	15.20	0.1	405	0.00	0.1
11	15.20	0.1	406	6262.09	0.1
12	25.00	0.0	407	2926.85	0.1
13	25.00	0.0	408	2926.85	0.1
17	1340.10	0.0	409	2926.85	0.1
19	1320.87	0.1	410	0.00	0.1
20	0.00	0.1	411	0.00	0.1
25	3446.26	0.4	412	6262.09	0.1
27	3659.70	0.4			

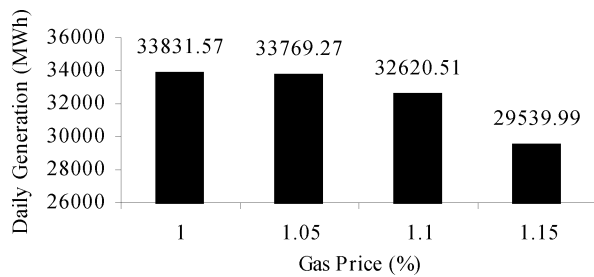

Fig. 8. Generation of combined cycle with different gas prices.

diversity for reducing the dependence of electric power systems on natural gas. Furthermore, the installation of renewable and distributed units such as pumped-storage units and PV could hedge the volatility of gas prices.

D. Case 4: Impact of Gas Infrastructure Outages on LMP

As the total installed capacity of combined-cycle units increases in electricity markets, the availability of fuel and the reliability of the gas infrastructure system will become a critical issue in power system operations. In this case, we study the impact of gas pipeline outages on LMP of interzonal transmission lines.

For comparison, we initially calculate LMPs for the normal operating condition of gas pipelines. Fig. 9 shows the incremental LMP between the two ends of tie line 54 on which there is no congestion when pipelines are in service. Tie line 54 is chosen here as it transmits the highest level of power among interzonal lines. The flow limit on line 54 is set at 200 MW.

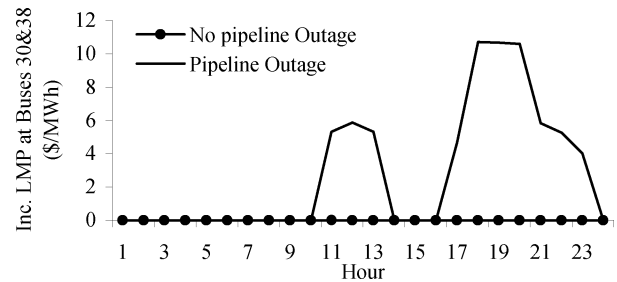

Fig. 9. Incremental LMP across tie line 54.

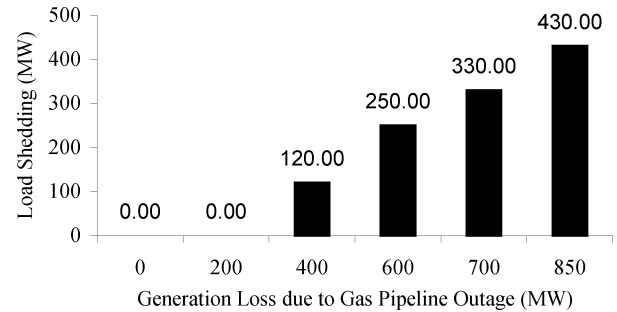

Fig. 10. Load shedding as a function of gas pipeline outages.

The outage of a gas pipeline which is supplying combined-cycle units 407, 408, and 409 in Zone 2B will force the units off. Zone 2 has the largest proportion of the system load, so its generation deficiency would have to be imported from Zone 1. The interzonal lines could be congested once the line flows, especially that of line 54, increase. In Fig. 9, the larger interzonal congestion occurs during peak load hours when the remaining units in Zone 2 are incapable of supplying the local load. In this case, the cheaper power supplied by Zone 1 will compensate the loss of combined-cycle units in Zone 2B.

To mitigate the tie flow congestion in short term, we resort to load shedding in Zone 2B. In long term, additional units could be installed to enhance the system security. Since Zone 2 has the largest proportion of the system load, once the pipeline outages occur in this zone, we curtail 250 MW of the load from Zone 2. Load shedding would lower the incremental LMP on tie line 54 and mitigate the congestion throughout 24 hours.

Fig. 10 shows the relation between the loss of combined-cycle generation capacity due to pipeline outage and load shedding. For minor outages in this example (for instance, 200 MW or less), the remaining units in the market would supply the load economically without importing power from other zones. Under this situation, there would be no tie line congestion and load shedding is not deemed necessary. However, with additional outages of gas pipelines, load shedding would be required to mitigate the tie line congestion.

It ought to be emphasized that load shedding is not a desirable approach to congestion mitigation, as it raises the level of customers' dissatisfaction with the electric utility operation. Power suppliers use the load shedding as the last resort, since they may have to compensate the impacted customers financially based on load shedding contracts.

E. Case 5: Impact of Pumped-Storage Hydro Plants

A pumped-storage hydro plant in Zone 2 could reduce the need for imported power to Zone 2. So instead of shedding loads in Zone 2, we would introduce three pumped-storage hydro plants at buses 59 and 60 with a total capacity of 400 MW. Pumped-storage hydro plants store large amounts of energy. When the system load is low (e.g., at nights), the water is pumped to the upper reservoir. During peak hours, the stored water in the upper reservoir is discharged to the lower reservoir generating electricity.

Comparing Cases 4 and 5, one could appreciate the impact of additional pumped-storage hydro plants on LMP reduction versus load shedding by which LMP difference between buses 30 and 38 is reduced to zero. The choice between these two options (i.e., penalty for load shedding and the socio-economical cost of security versus the cost of installing pumped-storage hydro plants and hourly expenses for pumping the water to upper reservoirs) ought to be addressed by system planners and is beyond the scope of this paper.

F. Case 6: Impact of PV/Battery System

The pumped-storage hydro units present a great opportunity for mitigating congestion at certain zones. However, for physical and geographical reasons, pumped-storage units are not traditionally installed near load centers, which could necessitate additional transmission and distribution lines to deliver the pumped-storage power generation to load centers. With a dramatic increase in urban populations, electric power companies would have fewer opportunities for building additional transmission and distribution lines near load centers. So depending on the size and the location of pumped-storage units, the congestion might not be completely mitigated in Case 5. Accordingly, when transmission flows exceed the MW limit of existing lines, power companies might either rely on more expensive generators or resort to load shedding for maintaining the transmission system security.

To reduce the hourly cost of power dispatch during peak hours and to overcome the inconvenience of load shedding, electric power companies have recently considered the utilization of distributed and renewable generation at specific locations in power systems. One of the possible alternative sources of energy is the PV/battery system, which provides superior characteristics such as a pollution-free and abundant source of energy with minute operating costs [25]. The installation cost of such systems could be substantial, which will be paid off over the lifetime of the unit.

In this case, we study the impact of additional PV/battery systems on locational pricing of Case 5. Bus 86 is chosen for the installation of an aggregated PV/battery. The local generating unit at bus 87 represents an expensive generator. Therefore, most of the power supplied to bus 86 is imported from bus 85 through line 133. Once the line 133 is congested, the available unit at bus 87 will have to increase its power output to meet the load requirement, which creates a high LMP at bus 86, as shown in Fig. 11.

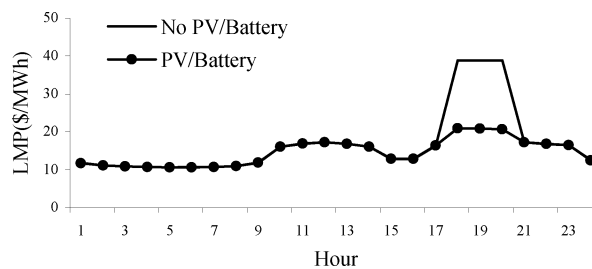

Fig. 11. LMP at bus 86.

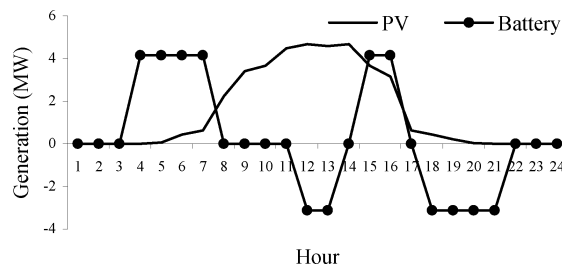

Fig. 12. Daily scheduling of PV/battery generator.

We intend to install an aggregated 4.68-MW PV and 3.12-MW battery system at bus 86. Fig. 11 shows accordingly that the congestion on line 133 is cleared and the LMP at bus 86 is returned to normal. Fig. 12 depicts the daily scheduling of the PV/battery system in which the positive battery output correspond to charging periods. According to the daily load profile, power grid could contribute to charging of the battery at late night and early morning hours, when hourly loads are relatively low. At peak load hours (hours 12 and 13), both PV and battery will be supplying the local load. PV charges the battery at hours 15–16. At last the battery will supply the local load during evening peak loads when the PV power is scarce. This scheme is much more economical as compared with that of charging the battery at peak load hours, like noon, when LMPs are high. The PV/battery operation diminishes the burdens on a constrained power system by lowering LMPs and flows on critical lines. It is expected that as time goes on, the further utilization of renewable energy sources will be a serious contender for more volatile gas-fired units in a competitive electricity market [26], [27].

VIII. CONCLUSION

Natural gas is the least polluting fossil fuel. It is thought by many to be the fuel of the century that will power our economy into the sustainable fuels of the later decades and beyond. In long run, the conversion of polluting fossil fuel-burning units to natural gas will greatly diminish air pollution and improve the long run sustainability of forests, waters, and farmlands, which are being negatively affected by acid deposition.

The presented analyses in this paper signify the interdependency of natural gas and electricity infrastructures and the essence of securing the natural gas infrastructure for supplying the ever-increasing number of gas-powered units. The analyses showed that the interdependency could be affected

by physical characteristics and capabilities of gas pipelines and electric power systems, operational procedures of electrical and gas systems, types of generating plants, availability of gas supply, transmission and delivery of natural gas and electricity, and the volatile gas and electricity market prices.

The paper also showed that a significant reliance on the natural gas supply could seriously impact the security and the market price of electricity. Furthermore, the utilization of distributed and renewable energy in electric power system could reduce the power flow congestion when the supply of gas is scarce or the market price for gas is high.

The optimization of natural gas and electricity infrastructures could encompass new pipelines to reach supplies in the frontier regions, a more comprehensive communication and coordination for managing contingencies in natural gas and electricity infrastructures, expansion of existing pipeline systems, enhancement of electric power transmission and distribution systems, new laterals to serve electricity plants, diversity in fuel and generating plants, and expansion and construction of storage facilities to meet peak day requirements.

It is envisioned that energy companies and government agencies must consider an integrated approach to the operation and planning of natural gas and electricity infrastructures to assure that the pertinent economical and critical security issues are dealt with for the foreseeable future.

APPENDIX A CASCADED HYDRO PLANTS SUBPROBLEM

The formulation of cascaded hydro plants subproblem is written as

$$L_{ch} = \sum_{t=1}^{NT} \left\{ \begin{array}{l} -\lambda_g(t) \sum_{i=1}^{N_{ch}} P(w(i,t))I(i,t) \\ -\lambda_s(t) \sum_{i=1}^{N_{ch}} r_s(w(i,t))I(i,t) \\ -\lambda_o(t) \sum_{i=1}^{N_{ch}} r_o(w(i,t))I(i,t) \end{array} \right\}.$$

Besides power generation constraints that we considered for thermal units, we would need to consider water constraints for cascaded hydro plants.

Water balance equation

$$V(i,t) = V(i,t-1) + \sum_{iu \in U_i} w(iu,t - \tau(iu)) - w(i,t) + \xi(i,t).$$

Volume limit

$$V^{\text{Min}}(i) \leq V(i,t) \leq V^{\text{Max}}(i).$$

Terminal and initial volume

$$\begin{aligned} V(i,T) &= V^T(i) \\ V(i,0) &= V^0(i). \end{aligned}$$

Discharge limit

$$\begin{aligned} w^{\text{Min}}(i) \leq w(i,t) \leq w^{\text{Max}}(i) \\ (i = 1, \dots, N_{ch})(t = 1, \dots, NT). \end{aligned}$$

where

L_{ch}	Lagrangian function of cascaded hydro units subproblem;
N_{ch}	number of cascaded hydro units;
$P(w(i,t))$	dispatch of cascaded hydro unit i at time t [MW];
$w(i,t)$	water discharge of cascaded hydro unit i at time t [Hm ³ /h];
$r_s(w(i,t))$	contribution of cascaded hydro unit i to spinning reserve at time t [MW];
$r_o(w(i,t))$	contribution of cascaded hydro unit i to operating reserve at time t [MW];
$V(i,t)$	reservoir volume of unit i at time t [Hm ³];
U_i	set of upstream cascaded hydro plants which directly connect to hydro unit i ;
iu	upstream cascaded hydro unit which directly connect to hydro unit i ;
$\tau(iu)$	water discharge delay times of cascaded hydro unit iu [hour];
$\xi(i,t)$	natural inflow of cascaded hydro unit i at time t [Hm ³ /h];
$V^{\text{Min}}(i)$	reservoir volume lower limit of unit i [Hm ³];
$V^{\text{Max}}(i)$	reservoir volume upper limit of unit i [Hm ³];
$V^T(i)$	terminal reservoir volume of unit i [Hm ³];
$V^0(i)$	initial reservoir volume of unit i [Hm ³];
$w^{\text{min}}(i)$	water discharge lower limit of unit i [Hm ³ /h];
$w^{\text{max}}(i)$	water discharge upper limit of unit i [Hm ³ /h].

APPENDIX B PUMPED-STORAGE HYDRO PLANT SUBPROBLEM

Similarly, the formulation of pumped-storage hydro plant subproblem can be written as

$$L_{ps} = \sum_{t=1}^{NT} \left\{ \begin{array}{l} -\lambda_g(t) \sum_{i=1}^{N_{ps}} P(w(i,t))I(i,t) \\ -\lambda_s(t) \sum_{i=1}^{N_{ps}} r_s(w(i,t))I(i,t) \\ -\lambda_o(t) \sum_{i=1}^{N_{ps}} r_o(w(i,t))I(i,t) \end{array} \right\}$$

subject to:

Water balance equation

$$V(i,t) = V(i,t-1) - w(i,t).$$

Volume limit

$$V^{\text{Min}}(i) \leq V(i,t) \leq V^{\text{Max}}(i).$$

Terminal and initial volume

$$\begin{aligned} V(i,T) &= V^T(i) \\ V(i,0) &= V^0(i). \end{aligned}$$

Discharge limit

$$w^{\text{Min}}(i) \leq w(i, t) \leq w^{\text{Max}}(i) \\ (i = 1, \dots, N_{ps})(t = 1, \dots, NT).$$

where (we ignore the similar symbols used in cascaded hydro formulation here)

L_{ps}	Lagrangian function of pumped-storage unit subproblem;
N_{ps}	number of pumped-storage units;
$P(w(i, t))$	dispatch of pumped-storage unit i at time i (+: generating; -: pumping) [MW];
$w(i, t)$	water discharge of pumped-storage unit i at time t (+: generating; -: pumping) [Hm^3/h].

APPENDIX C PV/BATTERY SUBPROBLEM

In practice, PV/battery systems could be installed at various distribution sites. We consider an aggregated PV/battery unit that is connected to a single substation. Then the Lagrangian function for the PV/battery subproblem is written as

$$L_{pv} = \sum_{t=1}^{NT} \left\{ \begin{array}{l} -\lambda_g(t) \sum_{i=1}^{N_{pv}} P_u(i, t) I(i, t) \\ -\lambda_s(t) \sum_{i=1}^{N_{pv}} r_s(i, t) I(i, t) \\ -\lambda_o(t) \sum_{i=1}^{N_{pv}} r_o(i, t) I(i, t) \end{array} \right\}$$

subject to:

State of charge balance equation

$$C(t) = C(t-1) + w(t).$$

Power balance equation

$$P_u(t) = P_{pv}(t) - P_b(w(t)) - P_s(t).$$

State of charge limits

$$\underline{C} \leq C(t) \leq \bar{C} \quad t = 1, \dots, N_t - 1 \\ C(0) = C_S \quad \text{initial state of charge} \\ C(T) = C_E \quad \text{final state of charge.}$$

Charge/discharge current limit

$$\underline{w} \leq w(t) \leq \bar{w}.$$

Output power limits

$$\underline{P_u} \leq P_u(t) \leq \bar{P_u} \quad (i = 1, \dots, N_{pv})(t = 1, \dots, NT).$$

where

L_{pv}	Lagrangian function of PV/battery unit subproblem;
N_{pv}	number of PV/battery units;
$C(t)$	state of charge of the equivalent battery at hour t [KAh];
$w(t)$	charge (+)/discharge(-) current [KA];
\bar{C}	aggregated capacity of all batteries [KAh];
\underline{C}	aggregated lower capacity limit [KAh]: this value is equal to 20% of \bar{C} for most of deep-cycle batteries used in PV applications;
\bar{w}	aggregated charging current limit (+) for all batteries [KA];
\underline{w}	aggregated discharge current limit (-) for all batteries [KA];
$P_u(t)$	power generated (+)/consumed (-) by PV/battery generator at hour t [MW];
$P_{pv}(t)$	electrical power of the equivalent PV generator [MW];
$P_b(w(t))$	charge (+)/discharge(-) power of the equivalent battery [MW];
$P_s(t)$	spillage power [MW];
$P_{pv}(t)$	aggregated power [MW] of PV arrays at hour t [KA];
$\bar{P_b}$	aggregated charging power limit (+) of all batteries [MW];
$\underline{P_b}$	aggregated discharge power limit (-) of all batteries [MW].

REFERENCES

- [1] (2001, May) US natural gas markets: Recent trends and prospects for the future. Energy Inf. Admin. (EIA), U.S. Dept. Energy, Washington, DC. [Online]. Available: <http://www.eia.doe.gov/oiarf/servicerpt/naturalgas/pdf/oiarf00102.pdf>
- [2] (2001, Dec.) Annual energy outlook 2002 with projections to 2020. Energy Inf. Admin. (EIA), U.S. Dept. Energy. [Online]. Available: [http://www.eia.doe.gov/oiarf/archive/aeo02/pdf/0383\(2002\).pdf](http://www.eia.doe.gov/oiarf/archive/aeo02/pdf/0383(2002).pdf)
- [3] (2002, Nov.) Annual Energy Review 2001. Energy Inf. Admin. (EIA), U.S. Dept. Energy. [Online]. Available: <http://tonto.eia.doe.gov/FTP/ROOT/multifuel/038401.pdf>
- [4] J. B. Foster, "Meeting the challenges of the nation's growing natural gas demand," Nat. Petroleum Council, Washington, DC, 1999.
- [5] S. L. Pope. (2002) California electricity price spikes: An update on the facts. [Online]. Available: <http://www.ksg.harvard.edu/hepg>
- [6] J. Tobin, "Natural gas transportation-infrastructure issues and operational trends," Energy Inf. Admin. (EIA)/Natural Gas Div., 2001.
- [7] "Natural gas infrastructure issues," California Energy Comm., Sacramento, CA, 2001.
- [8] J. Kennedy. (2000) Meeting US gas demand will challenge contracts. [Online]. Available: <http://www.iadc.org/dcp/dec-novdec00/n-gas.pdf>
- [9] A. Carpignano, M. Piccini, M. Gargiulo, and A. Ponta, "Reliability and availability evaluation for highly meshed network systems: Status of the art and new perspectives," in *Proc. Annu. Reliability and Maintainability Symp.*, 2002, pp. 104–111.
- [10] Combined cycle power plants [Online]. Available: <http://www.pseg.com/companies/power/cycle.html>
- [11] R. Kehlhofer, *Combined-Cycle Gas and Steam Turbine Power Plants*. Lilburn, GA: Fairmont, 1991.

- [12] J. Arroyo and A. Conejo, "Optimal response of a power generator to energy, AGC and reserve pool based markets," *IEEE Trans. Power Syst.*, vol. 17, no. 2, pp. 404–410, May 2002.
- [13] C. Wang and M. Shahidehpour, "Effects of ramp-rate limits on unit commitment and economic dispatch," *IEEE Trans. Power Syst.*, vol. 8, no. 3, pp. 1341–1350, Aug. 1993.
- [14] Z. Li and M. Shahidehpour, "Generation scheduling with thermal stress constraints," *IEEE Trans. Power Syst.*, vol. 18, no. 4, pp. 1402–1409, Nov. 2003.
- [15] (2002, Aug.) New resource characterization for the fifth power plan: Natural gas combined-cycle gas turbine power plants. Northwest Power Planning Council. [Online]. Available: http://www.westgov.org/wieb/electric/Transmission%20Protocol/SSG-WI/pnw_5pp_02.pdf
- [16] D. Chase. (2001) Combined-cycle development, evolution, and future. GE Power Syst. [Online]. Available: <http://web.mit.edu/1.149/www/GER4206.pdf>
- [17] B. Lu and M. Shahidehpour, "Short-term scheduling of combined cycle units," *IEEE Trans. Power Syst.*, vol. 19, no. 3, pp. 1616–1625, Aug. 2004.
- [18] A. Wood and B. Wollenberg, *Power Generation, Operation, and Control*. New York: Wiley, 1996.
- [19] M. Shahidehpour, H. Yamin, and Z. Li, *Market Operations in Electric Power Systems: Forecasting, Scheduling, and Risk Management*. New York: Wiley, 2002.
- [20] S. Wang, M. Shahidehpour, D. Kirschen, S. Mokhtari, and G. Irisarri, "Short-term generation scheduling with transmission and environmental constraints using an augmented Lagrangian relaxation," *IEEE Trans. Power Syst.*, vol. 10, no. 3, pp. 1294–1301, Aug. 1995.
- [21] C. Wang and M. Shahidehpour, "Ramp-rate limits in unit commitment and economic dispatch incorporating rotor fatigue effect," *IEEE Trans. Power Syst.*, vol. 9, no. 3, pp. 1539–1545, Aug. 1994.
- [22] H. Ma and M. Shahidehpour, "Transmission constrained unit commitment based on benders decomposition," *Elect. Power Energy Syst.*, vol. 20, no. 4, pp. 287–294, Apr. 1998.
- [23] —, "Unit commitment with transmission security and voltage constraints," *IEEE Trans. Power Syst.*, vol. 14, no. 2, pp. 757–764, May 1999.
- [24] Y. Fu, M. Shahidehpour, and Z. Li, "Security-constrained unit commitment with AC constraints," *IEEE Trans. Power Syst.*, to be published.
- [25] M. Shahidehpour and M. Marwali, *Maintenance Scheduling in Restructured Power Systems*. Norwell, MA: Kluwer, 2000.
- [26] M. Shahidehpour and F. Schwatz, "Don't let the sun go down on PV," *IEEE Power Energy Mag.*, vol. 2, no. 3, pp. 40–48, May 2004.
- [27] B. Lu and M. Shahidehpour, "Short-term scheduling of battery in grid-connected PV/battery system," *IEEE Trans. Power Syst.*, to be published.



Mohammad Shahidehpour (Fellow, IEEE) received the Ph.D. degree from the University of Missouri, Columbia, in 1981.

He is a Professor in the Electrical and Computer Engineering Department and Director of the Electric Power and Power Electronics Center, Illinois Institute of Technology (IIT), Chicago. He is the author of 300 technical papers and four books on electric power systems planning, operation, and control. His books include

Maintenance Scheduling in Restructured Power Systems (Norwell, MA: Kluwer, 2000), *Restructured Electrical Power Systems* (New York: Marcel Dekker, 2001), *Market Operations in Electric Power Systems* (New York: Wiley, 2002), and *Communication and Control of Electric Power Systems* (New York: Wiley, 2003).

Prof. Shahidehpour is the recipient of the 2004 IEEE Power System Operation Committee's Best Paper Award, 2005 IEEE Power Engineering Society Best Paper Award, the Edison Electric Institute's Outstanding Faculty Award, the Electrical Engineering Honor Society's (HKN's) Outstanding Young Electrical Engineering Award, Sigma Xi's Outstanding Researcher Award, IIT's Outstanding Faculty Award, and the University of Michigan's Outstanding Teaching Award.



Yong Fu (Member, IEEE) received the B.S. and M.S. degrees in electrical engineering from Shanghai Jiaotong University in 1997 and 2002, respectively. He is currently working toward the Ph.D. degree at the Illinois Institute of Technology, Chicago.

His research interests include power systems restructuring and reliability.



Thomas Wiedman (Senior Member, IEEE) received the B.S.E.E. degree from the University of Illinois, Chicago, in 1970, the M.B.A. degree from Loyola University, Chicago, IL, in 1974, and the M.S.E.E. degree from the Illinois Institute of Technology, Chicago, in 1994.

He held management positions at ComEd—Exelon related to Bulk Power Operations (Bulk System Security Manager) and System Protection (System Protection Manager).

He has also held several positions in MAIN's operations and planning committees. He was the Director of Transmission Planning at ComEd—Exelon until 2004. He is currently the President of Wiedman Power System Consulting.

Mr. Wiedman is a Senior Member of the IEEE Power Engineering Society.