

IMPLEMENTATION OF FUZZY AND HYBRID CONTROLLERS FOR INVERTED PENDULUM PROBLEM

B.Laxman¹, G. Karunakar Reddy², Pramod Singh³

Assistant Professor, EEE
Bhoj Reddy Engineering College for Women, Hyderabad, India

Abstract: In this paper a design methodology (“AN INTELLIGENT HYBRID FUZZY PID CONTROLLER”) is used that blends the classical PID and the fuzzy controllers in an intelligent way and thus a new intelligent hybrid controller has been achieved. Basically, in this design methodology, the classical PID and fuzzy controller have been combined by a blending mechanism that depends on a certain function of actuating error. Moreover, an intelligent switching scheme is induced on the blending mechanism that makes a decision upon the priority of the two controller parts; namely, the classical PID and the fuzzy constituents

Keywords: Inverted pendulum, Inverted pendulum Problem, Fuzzy PID controller, Fuzzy control.

I. INTRODUCTION

The Inverted pendulum is one of the most commonly studied systems in the control area. They are quite popular because many variations of the pendulum often represent different kinds of robotic arms. It is a well established benchmark problem that provides many challenging problems to control design. The system is nonlinear, unstable, non minimum phase and under actuated. It is not full-state measurable with noisy measured signals. Many parasitic effects exist such as friction, elastic modes of rod and shaft, backlash effects of gears and belts, together with input saturation. These challenges made the inverted pendulum systems a classic tool in control laboratories [1]. It is used to illustrate ideas in nonlinear control, task-oriented control, hybrid systems and control of chaotic systems. The reason behind such extensive studies of the pendulum relies behind the fact that many important engineering systems can be approximately modeled as pendula. For example, in thrust vectored rocket control, the pitch dynamics of a rocket can be approximated by a simple pendulum. In robot systems, the relation is pertinent with inverted pendulum systems. In biomechanics, the pendulum is used to model bipedal dynamic walking. The pendulums are also used in the study of wheeled motion and balancing mechanisms [2].

Many control paradigms address the inverted pendulum on a cart problem as a fourth- order under actuated system. Examples include, experimental implementations using linear control techniques, linear parameter varying (LPV) techniques, the control under constraints, the grey prediction model, and energy control using potential and kinetic energy. Embedded applications using microcontrollers are gaining a lot of importance. The use of these controllers reduces the hardware requirement for electronics with no

compromise is speed of operations. Microcontrollers form the dedicated hardware devices and are inevitable for applications like the robotics. Application of Microcontrollers in control of the pendulum model using modern control strategy was a challenge in itself.

II. PROBLEM DESCRIPTION

The system amounts to an inverted pendulum mounted on a cart. The diagram below depicts this system.

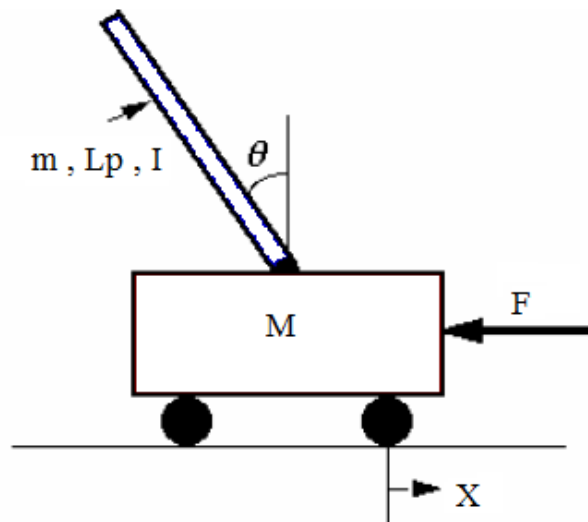

Fig: 1 Inverted pendulum on a moving cart.

Here ‘M’ is mass of the cart , ‘m’ is mass of the pendulum , L_p is length of the pendulum , I is pendulum inertia and the system variables are ‘F’ force applied to cart in (N) , ‘X’ cart position (m) , ‘dx’ cart velocity (m/sec) , ‘ θ ’ pendulum angle (from vertical) radians, ‘ $d\theta$ ’ pendulum angular velocity radians/sec.

The system works as follows. The system begins at rest (all of the system variables are zero) with the pendulum standing straight up. An initial disturbance force is applied to the cart, which puts the system out of balance. After this point, it is up to the controller to keep the system in control. The system simulator provides the system status variables (x , dx , θ , $d\theta$) to the controller. The controller uses these variables to determine the force to apply to the cart.

The primary objective of this problem is to keep the pendulum and cart in a controlled state over the simulation period. This means that the controlled system variables are not monotonically increasing or decreasing and that the controlled system variables are within a certain band. Our benchmark for the system variable control band is for θ to be within 0.5

radians and x to be within 0.5 meters. The secondary objective is to tighten the system control. The best possible result would be for the system to return to a balanced rest state. The closer the controller comes to achieving this, the better [3].

III. MODELING OF AN INVERTED PENDULUM SYSTEM

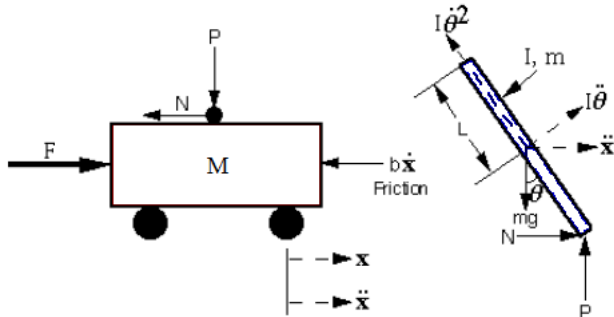

From the above figure considering the free body diagram of cart by summing all the forces acting on cart

$$M \frac{d^2x}{dt^2} + b \frac{dx}{dt} + N = F \tag{1}$$

Now from the pendulum free body diagram summing the forces acting on the pendulum

$$N = m \frac{d^2x}{dt^2} + ml \frac{d^2\theta}{dt^2} \cos\theta - ml \left(\frac{d\theta}{dt}\right)^2 \sin\theta \tag{2}$$

Substituting equation (2) in (1)

$$(M + m) \frac{d^2x}{dt^2} + b \frac{dx}{dt} + ml \frac{d^2\theta}{dt^2} \cos\theta - ml \left(\frac{d\theta}{dt}\right)^2 \sin\theta = F \tag{3}$$

Equation (3) represents the first equation of motion of the pendulum and cart system.

Now summing the perpendicular forces acting on pendulum

$$P \sin\theta + N \cos\theta - mg \sin\theta = ml \frac{d^2\theta}{dt^2} + m \frac{d^2x}{dt^2} \cos\theta \tag{4}$$

Summing the moments around the centroid of the pendulum

$$-Pl \sin\theta - Nl \cos\theta = I \frac{d^2\theta}{dt^2} \tag{5}$$

Combining equations (4) and (5)

$$(I + ml^2) \frac{d^2\theta}{dt^2} + mgl \sin\theta = -ml \frac{d^2x}{dt^2} \cos\theta \tag{6}$$

Above equation (6) represents the second equation of motion of the pendulum and cart system. These two equations of motion of the pendulum and cart system will be linearized about $\theta = 0$. Assume θ is a small

angle from the vertical upward direction). Therefore, $\cos(\theta) \approx 1$, $\sin(\theta) \approx \theta$, and $d^2\theta/dt^2 \approx 0$

$$(I + ml^2) \frac{d^2\theta}{dt^2} - mgl\theta = ml \frac{d^2x}{dt^2} \tag{7}$$

$$(M + m) \frac{d^2x}{dt^2} + b \frac{dx}{dt} - ml \frac{d^2\theta}{dt^2} = U = F \tag{8}$$

Equation (7) & (8) are linearized equations of the inverted pendulum [6].

TRANSFER FUNCTION MODEL

Applying Laplace transforms to the linearized equations (7&8)

$$(I + ml^2) \theta(s) - mgl\theta(s) = ml X(s) s^2 \tag{9}$$

$$(M + m) X(s) s^2 + b X(s) s - ml \theta(s) s^2 = U(s) \tag{10}$$

$$X(s) = \left[\frac{(I + ml^2)}{ml} - \frac{g}{s^2} \right] \theta(s) \tag{11}$$

Substituting Equation (10) in Equation (11)

$$(M + m) \left[\frac{(I + ml^2)}{ml} + \frac{g}{s} \right] \theta(s) s^2 + b \left[\frac{(I + ml^2)}{ml} + \frac{g}{s} \right] \theta(s) s - ml \theta(s) s^2 = U(s) \tag{12}$$

By solving

$$\frac{\theta(s)}{U(s)} = \frac{\frac{ml}{s}}{s^3 + \frac{b(I + ml^2)}{[M + m](I + ml^2) - (ml)^2} s^2 - \frac{(M + m)mgl}{[M + m](I + ml^2) - (ml)^2} s - \frac{bmgI}{[M + m](I + ml^2) - (ml)^2}} \tag{13}$$

Where $q = I(M + m) + Mml^2$

Now let $M = 1\text{Kg}$, $m = 0.1\text{Kg}$, $L = 1\text{m}$, $g = 9.81\text{m/s}^2$, $b = 0.1\text{N/m/sec}$, $I = 0.006\text{kg}\cdot\text{m}^2$

$$\frac{\theta(s)}{U(s)} = \frac{1.9231s}{s^3 + 0.0962s^2 - 20.7519s - 1.8865}$$

STATE SPACE MODEL

The below equations represents the state space model of the inverted pendulum

$$\begin{bmatrix} \ddot{x}(t) \\ \ddot{\phi}(t) \end{bmatrix} = \begin{bmatrix} 1 & 0 \\ 0 & 1 \end{bmatrix} \begin{bmatrix} -\frac{(I+ml^2)b}{I(M+m)+Mml^2} & \frac{m^2 g l^2}{I(M+m)+Mml^2} \\ 0 & 0 \end{bmatrix} \begin{bmatrix} x(t) \\ \phi(t) \end{bmatrix} + \begin{bmatrix} 0 \\ 0 \end{bmatrix} + \begin{bmatrix} \frac{0}{I(M+m)+Mml^2} \\ \frac{0}{ml} \end{bmatrix} u(t) \tag{15}$$

For this state-space design, a multi-output system will be controlled so that the cart's position and pendulum's angle can be observed from the first row and second row of the output respectively.

$$\begin{bmatrix} \dot{x}(t) \\ \ddot{x}(t) \\ \dot{\phi}(t) \\ \ddot{\phi}(t) \end{bmatrix} = \begin{bmatrix} 0 & 1.0000 & 0 & 0 \\ 0 & -0.0962 & 0.5660 & 0 \\ 0 & 0 & 0 & 1.0000 \\ 0 & -0.1923 & 20.7519 & 0 \end{bmatrix} \begin{bmatrix} x(t) \\ \dot{x}(t) \\ \phi(t) \\ \dot{\phi}(t) \end{bmatrix} + \begin{bmatrix} 0 \\ 0.9615 \\ 0 \\ 1.9231 \end{bmatrix} u(t) \tag{16}$$

$$y(t) = \begin{bmatrix} 1 & 0 & 0 & 0 \\ 0 & 0 & 1 & 0 \end{bmatrix} \begin{bmatrix} x(t) \\ \dot{x}(t) \\ \phi(t) \\ \dot{\phi}(t) \end{bmatrix} + \begin{bmatrix} 0 \\ 0 \end{bmatrix} u(t) \tag{17}$$

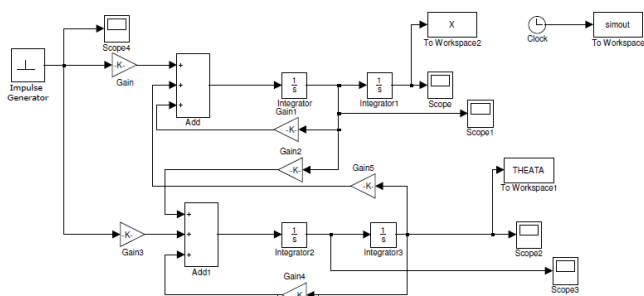

Fig: 2 Simulink diagram for inverted pendulum.

IV. PID CONTROLLER

Although it is very difficult to control this system, a good idea is to use a simpler control (PID) as starting point for the development and validation of more complex controllers. With this intention, the gains of the PID controller were found by trial and error method in order to control both the angle and position.

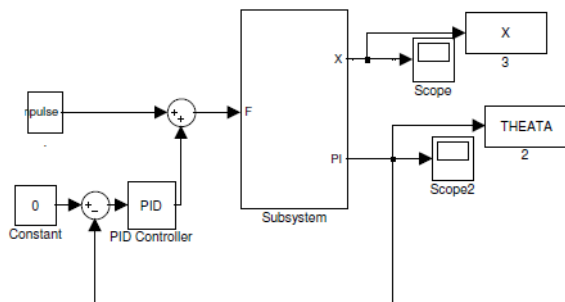

Fig: 3 Simulink diagram of PID control system for IP

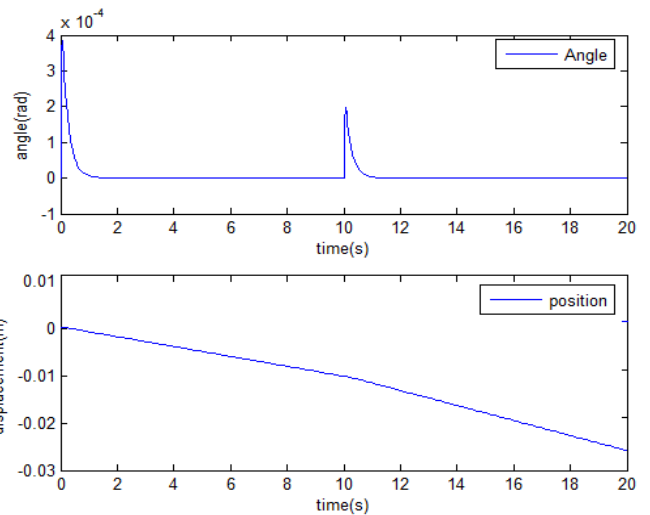

Fig: 4 Inverted pendulum responses with PID controller.

FUZZY LOGIC CONTROLLER

The architecture of a fuzzy logic controller is as shown below

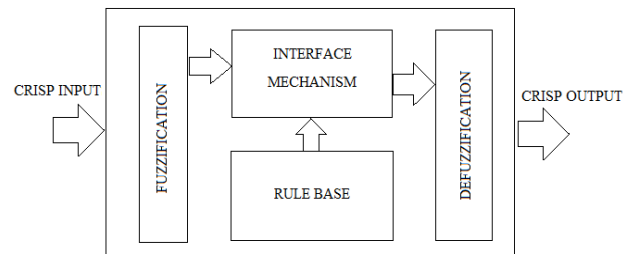

Fig: 5 Architecture diagram of fuzzy logic controller.

As shown in the figure a fuzzy controller will generate the proper control signal to control a system in three steps:

Fuzzification is the operation that translates a crisp data value in a linguistic variable to a membership degree (called alpha value). The membership degree depends on the shape of the membership function used. There are two strategies for the evaluation of membership degrees:

- 1) Memory oriented approaches.
- 2) Computation oriented approach.

Fuzzy Inference is the operation that uses the rule base and alpha values to deduce the fuzzy output. This step can be accomplished in many different ways. The most classical inference methods are the max-min method and the max-dot method. If each rule involves all input variables (worst case) and we have R rules, we must execute R (N_{in}-1) cascaded minimum operations. The term fuzzy inference indicates the process that computes an output value from an input value by means of the application of linguistic rules. Fuzzy rules have an IF-THEN structure and involve linguistic values for the input and the output variables. There are two parts in a fuzzy rule:

- 1) The antecedent part, i.e., the terms between IF and THEN concerning the inputs (premises), and
- 2) The consequent part, i.e., the terms after THEN concerning the outputs (conclusion).

It is observed that the general format of a rule includes both AND and OR functions to combine the premises. However, in some case (Max-Min inference

method), we can restructure the rule base so that only AND rules are used, by using the distributive property of the and operator. For instance a rule of the form

if (A or B) and C then X

Can be equivalently translated in the pair of rules

if A and C then X

if B and C then X

The output values are computed from the evaluation of the whole rule base, taking into account the contribution of the single rule, through three main steps:

Defuzzification is the step that translates the fuzzy output to a precise answer (also called crisp output). In case of control applications, the crisp output is usually the value or the control action. Many defuzzification methods have been proposed in literature. The most commonly used are the center of gravity method, the centroid method and the mean of maxima method. For example if we decide to use the center of gravity methods, we need to execute a number of multiply-and –accumulate a step that is proportional to the number of rules. In this case the complexity is algorithmic with respect to the number of rules: $O(\log_2(R))$.

Basically the fuzzy controllers are divided into two types based on implication methods they are:

- Mamdani implication method.
- Takagi-sugeno implication method.

Here mamdani implication method is used to control the inverted pendulum; mamdani implication method is having membership functions for both input and output, and it is using min-max composition method as inference mechanism to generate the control signal, and it will use the centre of gravity method for defuzzification process [9].

The basic block diagram for a fuzzy control system is shown below

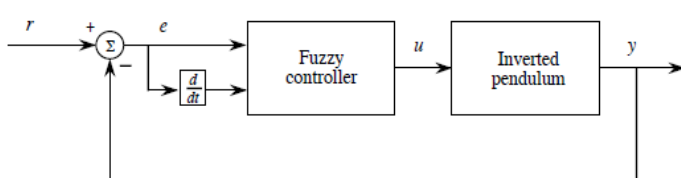

Fig: 6 fuzzy control system of inverted pendulum.

Here the fuzzy controller will collect the data of two variables i.e. “error” signal and “change in error” (derivative of error) signal and gives the controlled signal to inverted pendulum system, the fuzzy logic controller designed for the inverted pendulum in Simulink by using fuzzy logic tool box in MATLAB as follows.

The membership functions are constructed for the input variables i.e. ‘error’, change in error

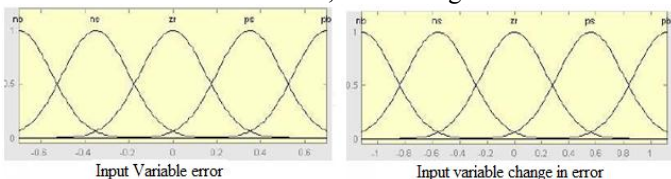

Fig: 7 Membership functions for input variables

Similarly membership functions for output variable are also constructed as shown below.

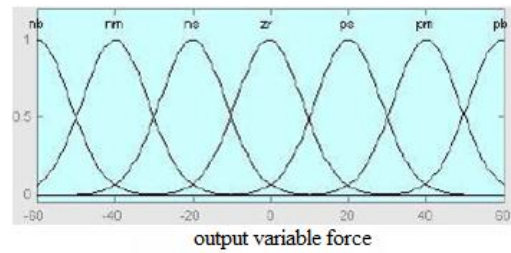

Fig: 8 Membership functions for output variable

Here twenty five rules are used to generate the proper control signal to control the inverted pendulum, inference mechanism will use these rules to generate the proper control signal by using min-max composition method, and the general way of expressing this fuzzy rule is

“If error is ‘X’ and change in error is ‘Y’ then the output is ‘Z’”

Here X, Y and Z are the linguistic values for the error, change in error, and output respectively. Rules used for generating control signal are tabulated below [10].

e/ de	Nb	Ns	Zr	Ps	Pb
Nb	Nb	Nb	Nb	Nm	Nm
Ns	Nb	Nm	Nm	Ns	Ns
Zr	Ns	Ns	Zr	Ps	Ps
Ps	Ps	Ps	Pm	Pb	Pb
Pb	Pm	Pm	Pb	Pb	Pb

Table: 1 fuzzy rule base

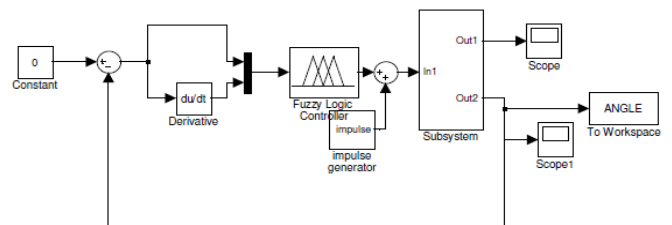

Fig: 9 Simulink diagram for fuzzy control system of IP

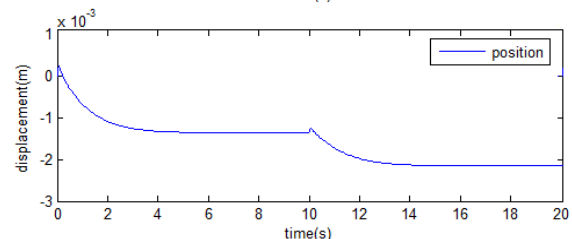
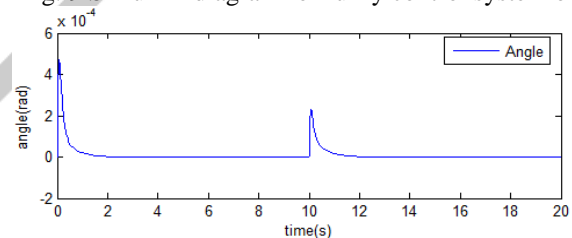

Fig: 11 IP responses with fuzzy controller.

HYBRID FUZZY PID CONTROLLER

Basically the fuzzy PID controllers are classified into three major categories those are

1. Direct action type,
2. Fuzzy gain scheduling type,
3. Hybrid type.

Again the direct action type fuzzy PID controllers are classified into three categories according to the no of inputs

1. Single input type,
2. Double input type,
3. Triple input type.

Fig 12 shows the structure of fuzzy PID controller which has two inputs and one rule base. The inputs for fuzzy PID controller are classical error (e) and rate of change of error (de/dt).

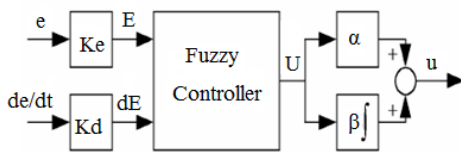

Fig: 12 structure of fuzzy PID controller

The Hybrid type fuzzy PID controller will be obtained by combining a two-input direct action fuzzy PID controller and a conventional PID controller [11] [12]. The structure is shown in Fig 13

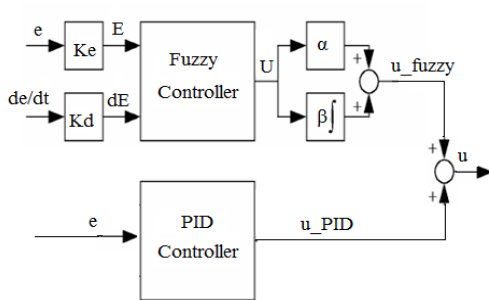

Fig: 13 structure of Hybrid fuzzy PID controller.

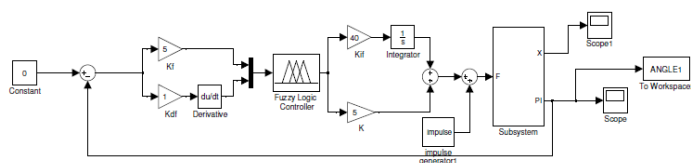

Fig: 14 Simulink diagram for fuzzy PID control system of IP.

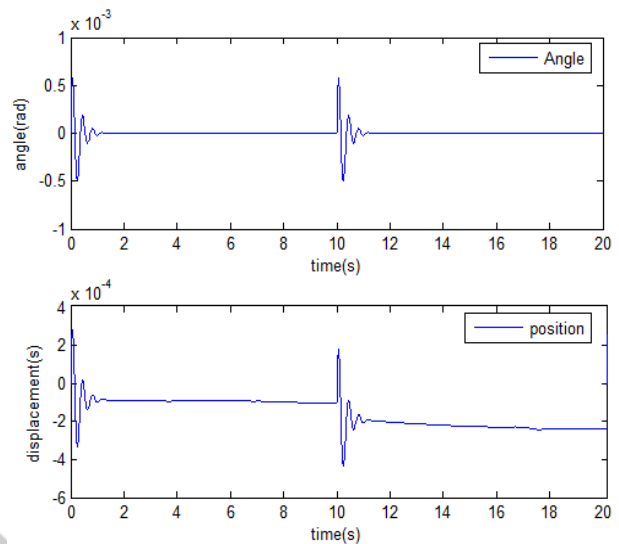

Fig: 15 IP responses with fuzzy PID controller.

INTELLIGENT HYBRID FUZZY PID (IHFPID) CONTROLLER

The Intelligent Hybrid fuzzy PID controller is obtained by combining the classical PID and fuzzy PID controller by a blending mechanism, which depends on a certain function of actuating error. Moreover, an intelligent switching scheme is induced on the blending mechanism that makes a decision on the priority of the two controller parts; namely, the classical PID and the fuzzy constituents.

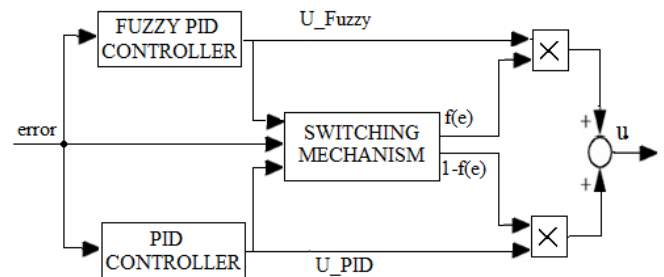

Fig 16 structure of IHFPID controller.

A switching & blending mechanism firstly decides the dominant one of the two controller structures; namely, classical and fuzzy controllers. The outputs of the fuzzy PID controller and the classical PID controller are then multiplied by either one of the functions 1-f (e) and f (e). 1-f (e) and f (e) are the weighing factors of the blending part of the mechanism. They quantify the level of the activity of the contributing controller and help us to achieve a reasonable tradeoff between the actions generated by the individual controllers. Since the function f (e) has to be positive valued, it has been selected as f (e) =e2. Consequently the hybrid controller's output becomes either.

$$U=f(e)*U_fuzzy + (1-f(e))*U_PID$$

OR

$$U= f(e)*U_PID+ (1-f(e))*U_fuzzy.$$

It is obvious that when the error is large the controller output multiplied by f (e) is activated more than the other controller part. For this reason, at the early stages of the control action, the controller output which gives the faster response must be multiplied by f (e). The switching part of the mechanism tries

to catch the bigger one of the control efforts of the two main controller parts. The idea behind this is that higher control effort should produce faster system response [13].

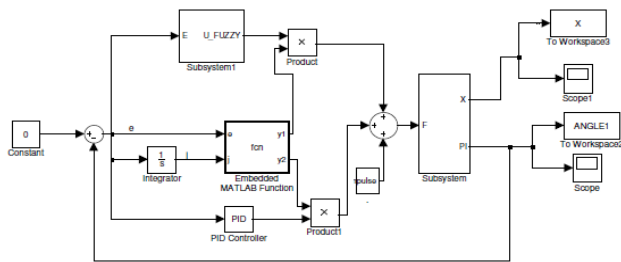

Fig: 17 Simulink diagram for IHFPID control system of IP

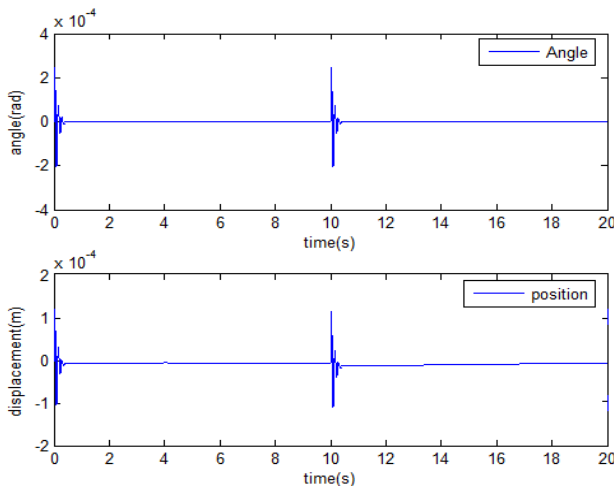

Fig: 18 Inverted pendulum response with IHFPID controller

V.CONCLUSION

In this paper different controllers are implemented on Inverted pendulum system they are PID controller, fuzzy controller, fuzzy PID controller, and an Intelligent Hybrid fuzzy PID controller. Here in one case only pendulum angle is only the objective to control in the second case all the states of the system are the objectives to control, in both the case intelligent hybrid fuzzy PID controller is providing 'better' system responses in terms of transient and steady-state performances when compared to the pure classical PID or the pure fuzzy controller.

REFERENCES

- [1]. Mohamed I. El-Hawwary, A. L. Elshafei, H. M. Emara, and H. A. Abdel Fattah, "Adaptive Fuzzy Control of the Inverted Pendulum Problem", IEEE transactions on control systems technology, vol. 14, no. 6, pp: 1135- 1144, NOVEMBER 2006.
- [2] K. Shuuji and T. Kazuo, "Experimental study of biped dynamic walking," IEEE Contr. Syst. Mag., vol. 16, no. 1, pp. 13-20, Feb. 1996.
- [3] Lawrence Bush, "fuzzy control of inverted pendulum" Troy network, November 27,2001.
- [4] K. Pathak, J. Franch, and S. A. Agrawal, "Velocity and position control of a wheeled inverted pendulum," IEEE Trans. Robot., vol. 21, no. 3, pp. 505-514, Jun. 2005.
- [5]. Ashish Tewari, "Modern control design with matlab and Simulink" john wiley & sons, Ltd, pp: 88-93, 2002.
- [6] K Ogata, "Discrete time control systems" Prentice Hall publishers' second edition 1987.

[7] "PID controller Design" Copyright ©2007 by the Society for Industrial and Applied Mathematics.

[8]. Zdenko kovacic, Stjepan Bogadan, "fuzzy controller design theory and applications" crc press an imprint of tailor & Francis group, pp: 1-70, 2006.

[9]. Kevin M. Passino, Stephen Yurkovich, "Fuzzy Control", Addison Wesley Longman, Inc., pp 23-50, 1998.

[10]. Hong Liu, Fengyang Duan and Ying Gao Huadong Yu and Jinkai Xu, "Study on Fuzzy Control of Inverted Pendulum System in the Simulink Environment" Proceedings of the IEEE International Conference on Mechatronics and Automation August 5 - 8, 2007, Harbin, China, pp: 937-942, 2007.

[11]. Birkan Akbryik Ibrahim Eksin Müjde Güzelkaya Engin Yeşil, "evaluation of the performance of various fuzzy pid Controller structures on benchmark systems", Proceedings 19th European Conference on Modeling and Simulation.

[12]. Bao-Gang Hu, George K. I. Mann, and Raymond G. Gosine, "A Systematic Study of Fuzzy PID Controllers—Function-Based Evaluation Approach", IEEE transactions on fuzzy systems, vol. 9, no. 5,pp: 699-712 october 2001.

[13]. Isin Erenoglu Ibrahim Eksin Engin Yesil Mujde Guzelkaya, "An Intelligent Hybrid Fuzzy Pid Controller", Proceedings 20th European Conference on Modelling and Simulation Wolfgang Borutzky, Alessandra Orsoni, Richard Zobel © ECMS, 2006.

BIOGRAPHIES



Bhukya Laxman Graduated in Electrical and Electronics Engineering from Kamala Institute of Technology and science, Huzurabad, Telangana, India. He completed his post-graduation in Instrumentation and Control Systems from NIT Calicut, Kerala, India. He is an Assistant Professor, Bhoj Reddy Engineering College for Women, Saidabad, and Hyderabad, India. His fields of interest include control systems, FUZZY logic, FACTS devices, distribution systems & discrete PID controllers.



G Karunakar Reddy Graduated in Electrical and Electronics Engineering from Madhira Institute of Technology and Science, kodad, Telangana, India. He completed his post-graduation in Electrical power systems from St. Mary's college of Engineering and Technology, Hyderabad, India. He is an Assistant Professor, Bhoj Reddy Engineering College for Women, Saidabad, and Hyderabad, India. His fields of interest include FACTS devices, distribution systems, FUZZY logic, fault analysis, discrete PID controllers & high voltage engineering.



Pramod Singh Graduated in Electrical and Electronics Engineering from Raja Mahendra College of Engineering, Ibrahimpatnam, Telangana, India. He completed his M.Tech from JNTU, Hyderabad, India. He is an Assistant Professor, Bhoj Reddy Engineering College for Women, Saidabad, and Hyderabad, India. His fields of interest include FACTS devices, Industrial Drives, Power Systems.