

Read this manual carefully before you use this service and keep it handy for future reference.  
For safe and correct use, be sure to read the Safety Information in "Read This First" before using the machine.

### Important Notice

The user's manual for RICOH Unified Communication System P3500 can be found among the user's manuals that come with this product, but this product does not work with conferencing systems via RICOH Unified Communication System.  
We will not have any liability in regard to any loss or damage resulting from the use of this product for any applications other than the video conference system.

### About This Manual

This manual explains how to operate RICOH Unified Communication System P3500M (this machine) for connecting to a compatible video conference system.

For details of the specifications and operating environment of this machine, see Read This First or the Operating Instructions of RICOH Unified Communication System P3500 that comes with this product.

The Operating Instructions is supplied in HTML form. You can view the Operating Instructions on the Ricoh home page:

- <http://www.ricoh.com/support/>

### About This Machine

This machine runs on Microsoft Windows 7 Embedded Standard OS and can be operated by using the mouse, keyboard, Control Panel, or via remote control.

This machine provides a conferencing function by using a Web browser to connect to a virtual conference room set up on a supported video conference system.

### Necessary devices

The following devices are necessary to use this machine.

Device name	Interface
Mouse	USB3.0 (type A)
Keyboard	USB3.0 (type A)
Video output device (monitor or projector)	Analog RGB/VGA, HDMI terminal

The following devices can also be used to suit your environment and usage application.

Device name	Interface
Analog Audio Input Device (Microphone, headset, and other devices)	Audio input
Analog Audio Output Device (Speaker or headset, and other devices)	Audio output
Digital Audio Input/Output Device (USB microphone speaker)	USB3.0 (type A)
Video Input Device (USB camera)	USB3.0 (type A)
USB flash drive (used to import and export Address Book data, update system files, and import certificates)	USB3.0 (type A)

#### ★ Important

- Video input devices equipped with HDMI terminals cannot be used.
- A keyboard coupled with a mouse or a keyboard with a mouse connected to its USB port can also be used.

## Using the Control Panel

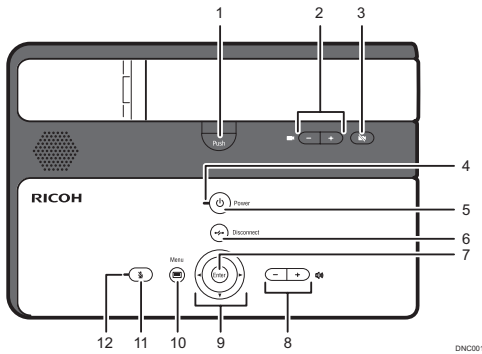

1. <b>[Push] key</b>	Used to raise the camera unit.
2. <b>Zoom keys</b>	Used to adjust the zoom of the machine's camera.
3. <b>Camera OFF key</b>	Used to turn off the display of the machine's camera.
4. <b>Power indicator</b>	Lights when the machine turns on. This indicator blinks while the machine is starting up or shutting down.
5. <b>[Power] key</b>	Used to turn the machine on and off.
6. <b>[Disconnect] key</b>	Used to exit browser.
7. <b>[Enter] key</b>	Used to activate the menu, setting, or set value selected with the cursor keys.
8. <b>Speaker volume keys</b>	Used to adjust the speaker volume.
9. <b>Cursor keys</b>	Used to select a menu or setting.
10. <b>[Menu] key</b>	Used to display the Windows Start menu.
11. <b>[Mute] key</b>	Used to temporarily disable audio input on the machine.
12. <b>Mute indicator</b>	Flashes if the [Mute] key is used to disable the microphone.

### Note

- You can use the remote control to perform the same operations that are performed on the control panel of the machine.

## Connecting Devices

- Connect the power cord set to the machine.
- Connect the video output device to the machine.
- Connect the Ethernet cable to the machine.  
Only when using the wired network, connect the Ethernet cable.
- Connect the keyboard to the machine.
- Connect the mouse to the machine.

## About Start Menu

Displays shortcut icons of related applications for this product.

### Address Book

Used to select the registered destination to connect to the video conference system.  
For details, see "Using Address Book".

### Default Startup Page

Used to start browser and to access the video conference system.  
For details, see "Start Meeting".

### Ricoh Screen Share

Used to start Ricoh Screen Share window to display your computer screen.  
For details, see "Sharing the Computer Screen".

### Settings

Used to change the settings for this machine.  
For details, see "Changing the Machine Settings".

# Preparing to Use the Machine

Start this machine, configure network and other initial settings, and then install browser. Follow the instructions on the screen to operate the system by using the mouse and keyboard.

1. **Press the [Power] key.**  
The machine starts and the Initial Settings window appears.
2. **Set the date and time, and then select [Next].**
3. **Configure required settings for your network environment.**  
Ask the network administrator about which settings need to be specified in this step, and then enter the correct values.
4. **When you are finished with the configuration, select [Next (Save Settings and Restart)].**  
The machine restarts and the Initial Settings window appears.
5. **Select the browser to install.**  
Follow the instructions on the screen for operation.  
When the installation is complete, the browser might be started.

**★ Important**

- If the machine is not properly connected to the network, an error message is displayed, and you will not be able to access the browser download site. Open the Initial Settings window and select [Previous] to show Network Settings. Then, review the settings.

**↓ Note**

- Select the browser that supports the video conference system you want to use.
6. **If the browser and the browser install window are displayed, close them.**
  7. **Display the Initial Settings window, and then select [Next].**
  8. **Restart the machine.**  
The machine restarts and the Initial Settings window appears.
  9. **Follow the instructions on the screen to enter the URL of the video conference system you use.**  
The URL can be up to 256 characters in length.
  10. **Set a certificate as necessary.**

**↓ Note**

- If the network environment requires a certificate, use a USB flash drive to download the certificate from your computer.

11. **When you are finished with the configuration, select [Done (Save Settings and Restart)].**  
The machine restarts and the default startup page appears.

**↓ Note**

- You can also change the machine settings from “Settings”. For details, see “Changing the Machine Settings”.

## Holding a Meeting

### About Address Book Screen

When this machine starts, Address Book is displayed. Address Book is used to register the URL and name of a virtual conference room with a supported conference system as a destination.

**↓ Note**

- Before having a meeting, you need to register the destination address in Address Book. For details about registering the destination, see “Managing Address Book.”

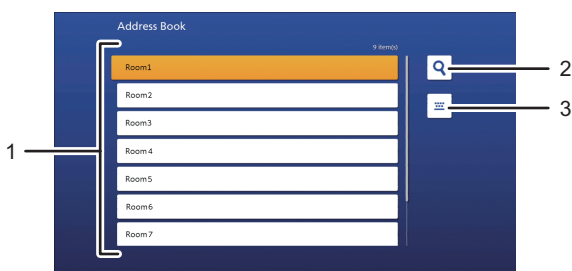

DPW008

1. <b>Destination List</b>	Displays a list of destinations registered in Address Book.
2. <b>[Search] button</b>	Use this function to search for a registered destination in the destination list.
3. <b>[Manual Entry] button</b>	Use this function to display the page of the video conference system specified as the default startup page.

## Start meeting

1. **Press the [Power] key.**  
Address Book is displayed.
2. **Press the [Push] key and then pull up on the arm of the camera to raise the camera unit.**
3. **Adjust the orientation by carefully moving and rotating the camera vertically and horizontally.**
4. **Select the destination you want to connect, and start the meeting.**

You can also use the cursor keys on this machine to select the destination and then press the [Enter] key.

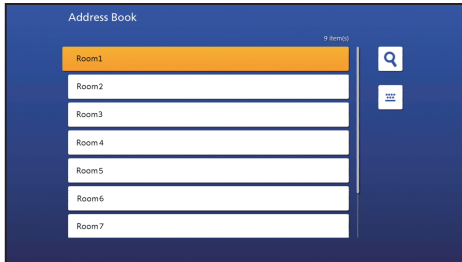

3. **Select [Connect].**

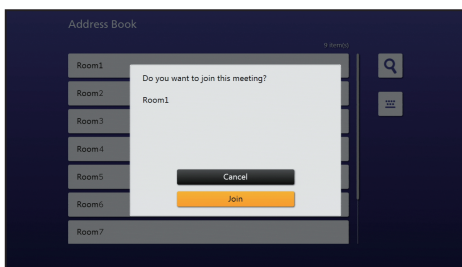

The Web browser opens and displays the selected video conference system.

### ↓ Note

- For details about operation during the meeting, see the manual or Help of the video conference system you are using.
- The machine turns off automatically when it is left idle for 15 minutes.

## Searching for a destination in the destination list

1. **Select the [Search] button.**  
You can also use [▶] key of this machine to select the [Search] button, and then press the [Enter] key of this machine.
2. **Enter a keyword to search for the destination.**

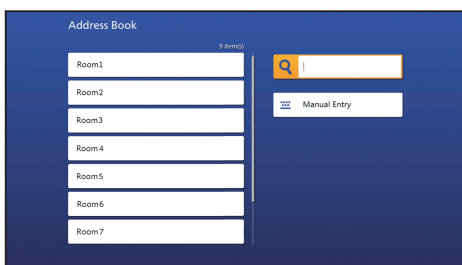

3. **Press the [Enter] key of the keyboard.**  
Search results showing all relevant destinations are displayed in the destination list.
4. **Select the destination you want to connect.**  
You can also use [◀] key of this machine to select the destination, and then press the [Enter] key of this machine.  
The Web browser opens and displays the selected video conference system.

### ↓ Note

- Keywords can be up to 100 characters in length.

## Connecting to an Unregistered Destination

### 1. Select the [Manual Entry] button.

You can also use [▶] and [▼] keys of this machine to select the [Manual Entry] button, and then press the [Enter] key of this machine.

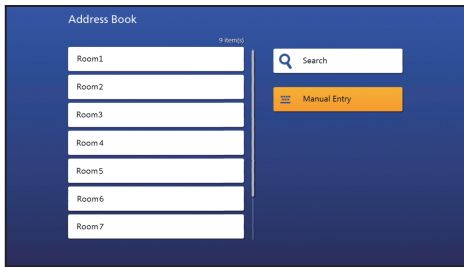

The Web browser opens and displays the selected video conference system.

## Sharing the Computer Screen

Connecting the machine to your computer via a USB cable and using Screen Share allows you to share the screen displayed on your computer to the other party.

### ★ Important

- To share your screen of the computer running Windows OS, you must first install the driver for Screen Share on your computer. For details about how to install the driver, see "Preparing for Screen Share", Operating Instructions of RICOH Unified Communication System P3500.
- If the video conference system that you are using does not support the "Screen Share" function via a browser, the screen cannot be shared.

### 1. Connect the micro-B connector end of the USB cable to the USB port (type micro-B) on this machine.

### 2. Connect the A connector end of the USB cable to the USB port (type A) on the computer.

The Screen Share software on your computer starts automatically.

If it does not start automatically, open "Computer" on your computer, right-click [Screen Share], and then click [Start Screen Share].

### 3. Click [Start Sharing].

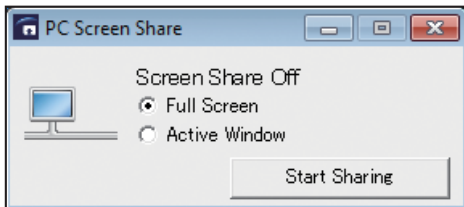

### 4. Start screen sharing on the video conference system to be used.

Select "Ricoh Screen Share" as a shared application.

For operation instructions, refer to the help for the video conference system to be used.

### ↓ Note

- To stop sharing your computer screen, click [Stop Sharing].

## Ending the Meeting

### 1. Press the [Disconnect] key of this machine.

The browser closes.

### 2. Press the [Power] key to turn this machine off.

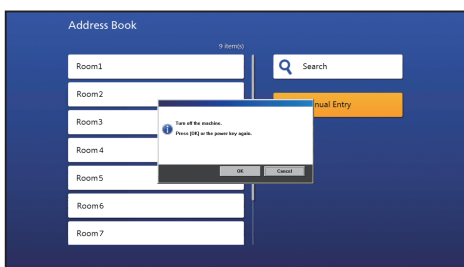

### 3. Select [OK].

The power of the machine is turned off.

# Changing the Machine Settings

Change the machine settings according to the environment in which the machine is used.

**★ Important**

- If changing the network settings, ask the network administrator about which settings need to be specified in wired/wireless network settings, and then enter the correct values.

1. Select [Settings] from the Windows Start menu on this machine.
2. Select the setting menu you want to change.

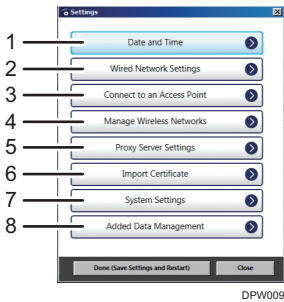

1.	<b>Date and Time</b>	Used to change date, time, or timezone.
2.	<b>Wired Network Settings</b>	Used to change the wired network settings.
3.	<b>Connect to an Access Point</b>	Used to change the access point.
4.	<b>Manage Wireless Networks</b>	Used to change the wireless network settings.
5.	<b>Proxy Server Settings</b>	Used to change the proxy server settings.
6.	<b>Import Certificate</b>	Used to change the certificate.
7.	<b>System Settings</b>	Used to change the system settings. <ul style="list-style-type: none"> <li>• <b>Startup Page</b> Used to change the startup page.</li> <li>• <b>Connection Test</b> Tests whether the machine can connect to the system update server. If your network environment requires proxy server authentication, a dialog box prompting for authentication is displayed.</li> <li>• <b>System update</b> You can check whether there is a system file that needs to be updated. If a system update is available, follow the instructions on the screen to update the system files. Used to update the system files downloaded on your computer. Store the system files in the USB flash drive, and then insert it into this machine. Follow the instructions on the screen to update the system files.</li> <li>• <b>Collect Log</b> Used to collect the logs. Insert the USB flash drive, and then follow the instructions on the screen to collect and save the logs.</li> <li>• <b>Install Web browser</b> Used to install the Web browser.</li> </ul>
8.	<b>Added Data Management</b>	Used to managing Address Book. For details, see "Managing Address Book" and "Changing Background Image".

## Managing Address Book

### Preparing Address Book

You must first create a text file that contains the destination list.

Create a text file and enter the destination address in accordance with the following format.

File name:

Format	rucs-addrbook-*.txt
Example	rucs-addrbook-20160101.txt

Destination address:

Format	Label line: name<tab>url 2nd and subsequent lines: destination name<tab>destination URL
Example	name url Room1 https://url1.com/ Room2 https://url2.com/

To transfer the Address Book file to this machine, save the text file to a USB flash drive

## Note

- The destination name is a name displayed in the Address Book application of this machine.
- A destination name can contain one or more spaces. If there is a blank line that only contains spaces and the like, that line and succeeding lines are not registered.
- If there is no destination registered in Address Book, a text file only containing a label line is exported. You can enter destinations into the text file for use.
- When you import a new Address Book file, any existing Address Book files will be deleted.
- If there are more than 1000 items in the file, only the first 1000 items will be imported

## Import Address Book

1. Insert the USB flash drive into this machine.
2. Select [Settings] from the Windows Start menu on this machine.
3. Select [Added Data Management].
4. Select [Import] of "Address Book".

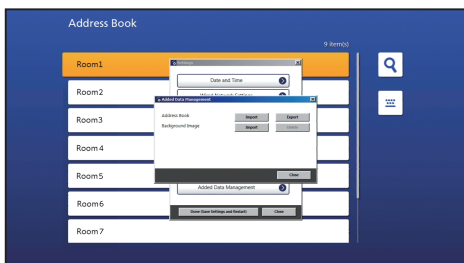

5. Select the text file you want to import, and then select [Import].

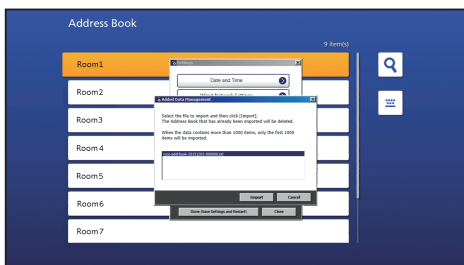

If the Address Book file has been imported successfully, a confirmation message is displayed.

6. Select [Close].

## Note

- If an error message is displayed, check the destination addresses in the file and check the file name to make sure they are correct.

## Export Address Book

1. Insert the USB flash drive into this machine.
2. Select [Settings] from the Windows Start menu on this machine.
3. Select [Added Data Management].
4. Select [Export] of "Address Book".

If Address Book is exported successfully, The message will be appeared.

5. Select [Close].

# Changing Background Image

You can change the background image in Address book.  
To do so, save your desired image as a JPEG file on a USB flash drive.

## Note

- When you import a new background image file, any image file that has already been imported will be deleted.

### Import background image

1. Insert the USB flash drive into this machine.
2. Select [Settings] from the Windows Start menu on this machine.
3. Select [Added Data Management].
4. Select [Import] of "Background Image".

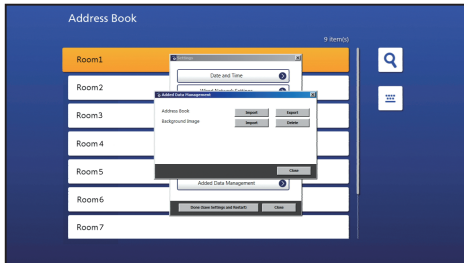

5. Select the text file you want to import, and then select [Import].

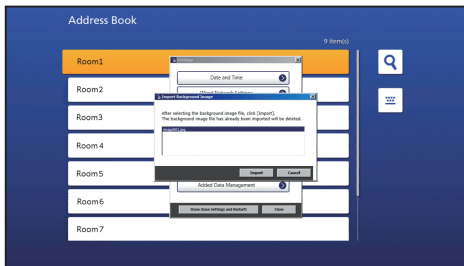

If Address Book is imported successfully, the message will be appeared.

6. Select [Close].

### Delete background image

If the background image is deleted, the background of Address Book is reset to the factory setting.

1. Insert the USB flash drive into this machine.
2. Select [Settings] from the Windows Start menu on this machine.
3. Select [Added Data Management].
4. Select [Delete] of "Background Image".
5. Select [Delete].

## Trademarks

Microsoft, Windows, and Windows 7 Embedded Standard are either registered trademarks or trademarks of Microsoft Corporation in the United States and/or other countries.

Other product names used herein are for identification purposes only and might be trademarks of their respective companies. We disclaim any and all rights to those marks.

© 2015 Ricoh Co., Ltd.  
Printed in Japan  
EOA5-7005

EN (GB) EN (US)



EOA57005