

in.k450



compact full-function keypads
for in.xe and in.xm spa systems

TechBook



Giving full control to wet fingers!

Aeware **3**
by gecko



Table of contents

overview	3	functions for in.xm spa systems	
installation		- on/off key.....	17
- drilling template	6	- economy mode.....	17
- with adhesive	7	- pump 1 key	17
connections		- pump 2 key	18
- connecting in.k450 keypad to in.xe.....	8	- pump 3 & blower key	18
- connecting in.k450 keypad to in.xm	9	- light key.....	18
functions for in.xe spa systems		- up/down keys	18
- on/off key.....	11	- program key	19
- economy mode.....	11	- setting time	19
- pump 1 key	11	- setting filter cycle	19
- pump 2 key	12	- setting economy mode	20
- pump 3 & blower key	12	- setting temperature unit	21
- light key.....	12	- other features.....	21
- up/down keys	12	troubleshooting section.....	22
- program key	13	specifications.....	25
- setting time	13		
- setting filter cycle	13		
- setting economy mode	14		
- setting temperature unit	15		
- other features.....	15		



Aeware
by gecko 3



in.k450

Compact full-function keypad
for in.xm & in.xe spa systems

Aeware's new series of keypads features a large LCD display and slightly raised keys that let users control all spa system functions and programming directly from spa side. In.k450 comes with a customizable overlay in an easy to install waterproof plastic enclosure designed to maximize user experience.



function description

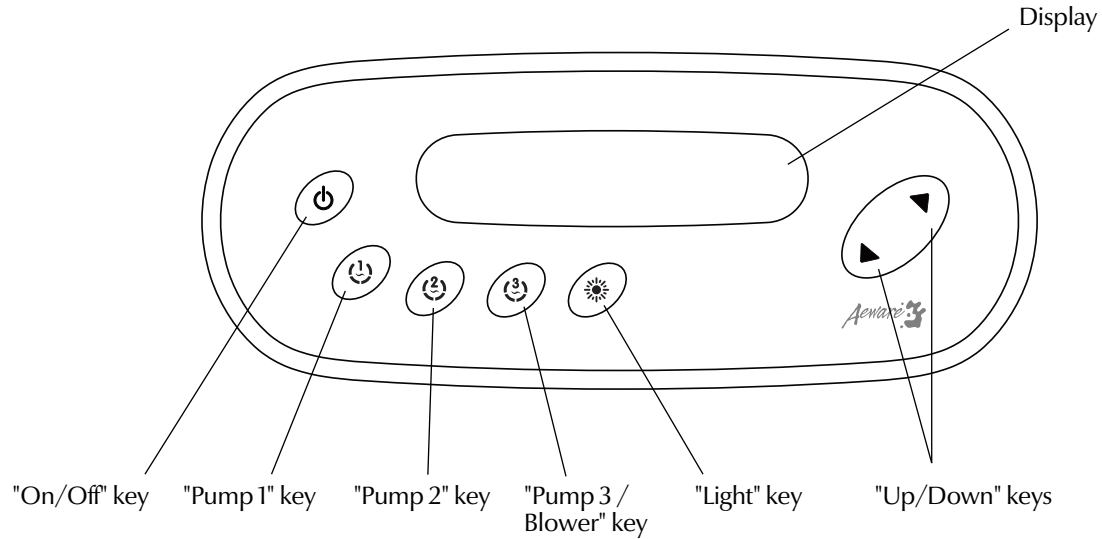

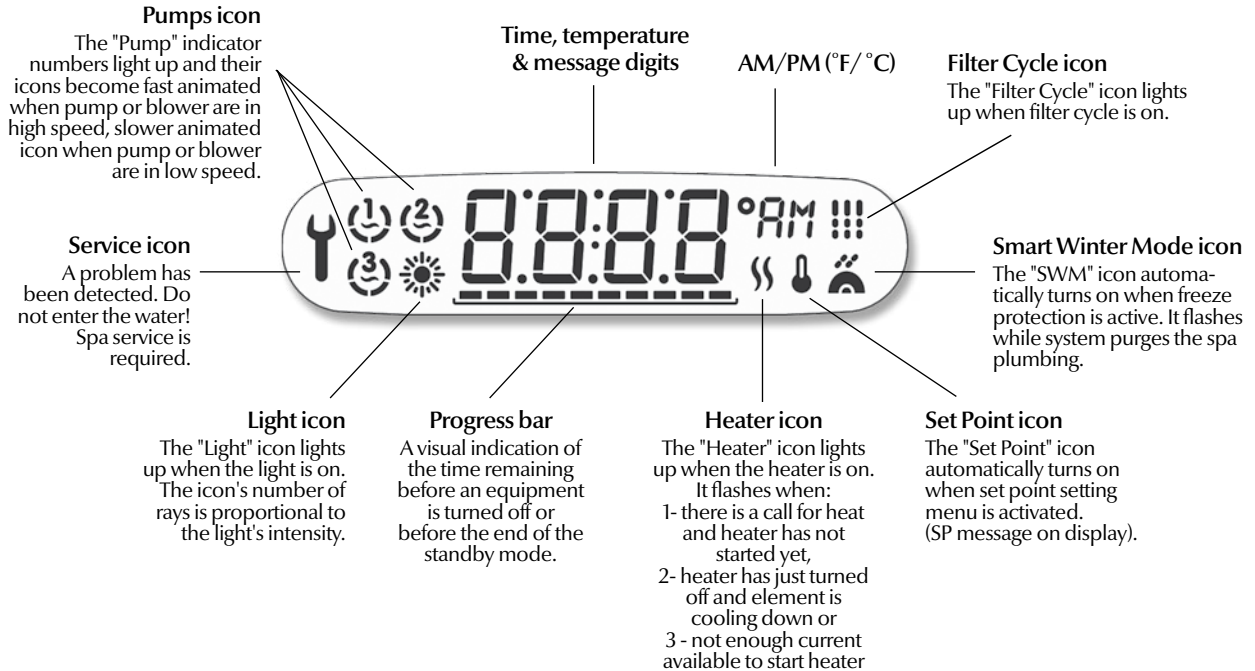



Drilling template

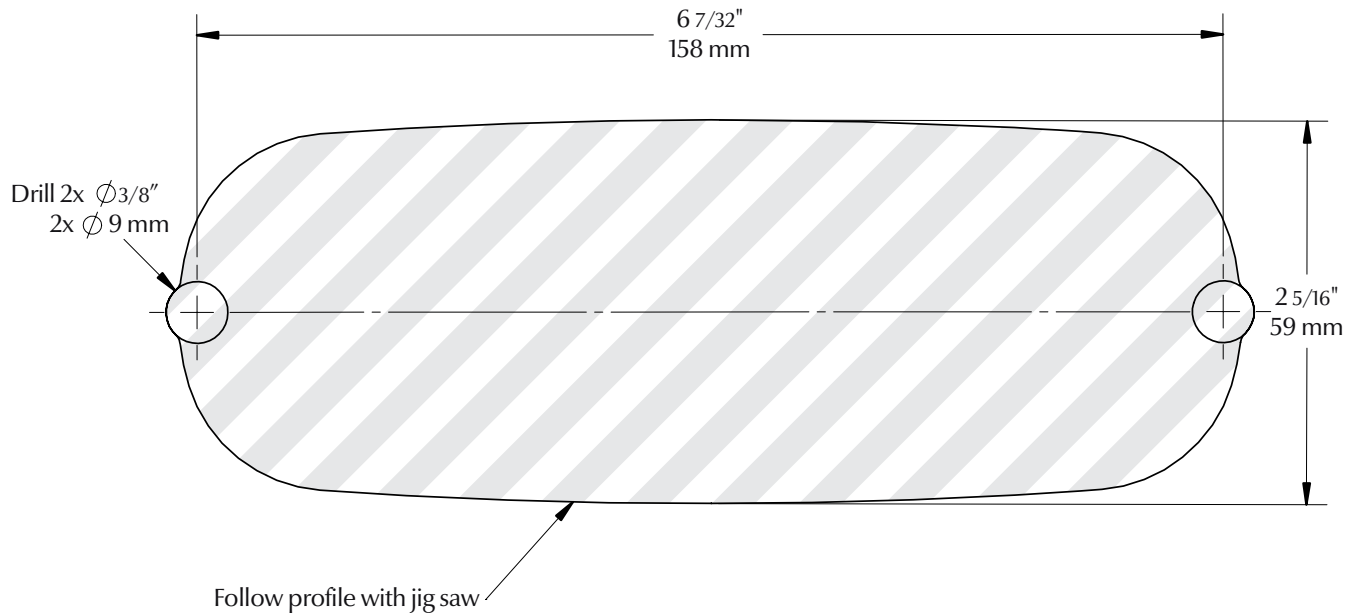



Installation in.k450 with adhesive

The keypad should be installed directly onto the spa (or very close to it) so that it is easily accessible to the user.

- Using the drilling template supplied with the unit, determine the mounting location and then stick the template on the location.
- Drill two $3/8''$ (9 mm) diameter holes at $6\ 7/32''$ (158 mm) from center to center, in the exact position according to the drilling template.
- Cut out and remove the material between the two holes following the profile with a jig saw (see illustration).
- Clean the installation surface and peel the adhesive gasket from the back of the keypad.
- Insert keypad and align it correctly, then secure it properly in place by using the two wing nuts provided.

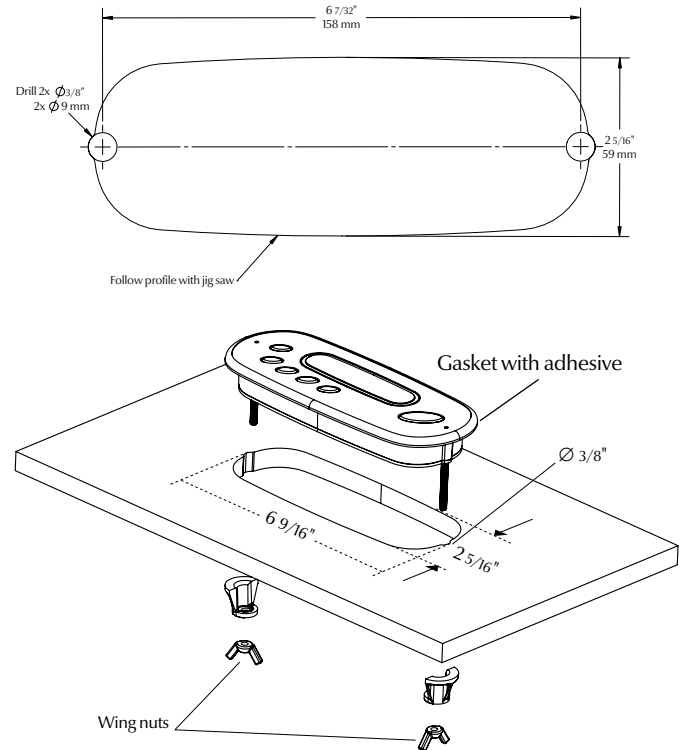



Connecting in.k450 keypad to in.xe

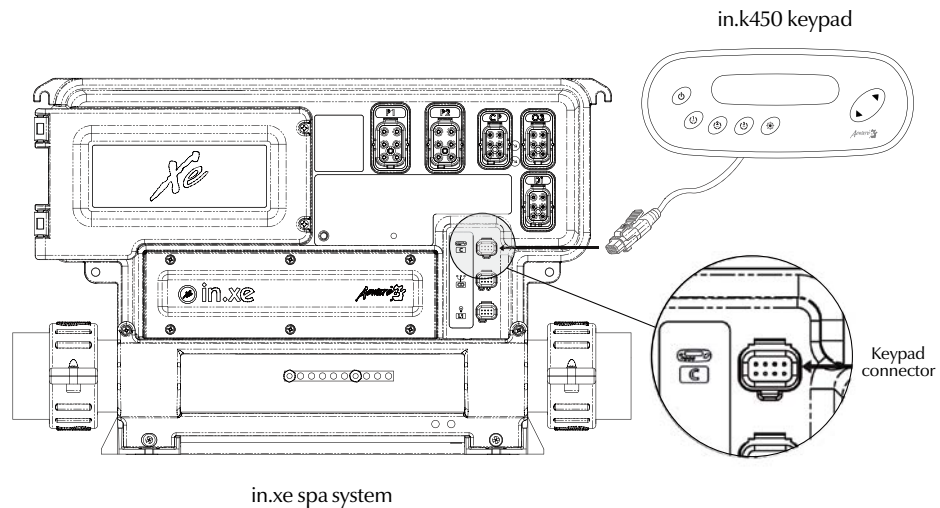



Connecting in.k450 keypad to in.xm

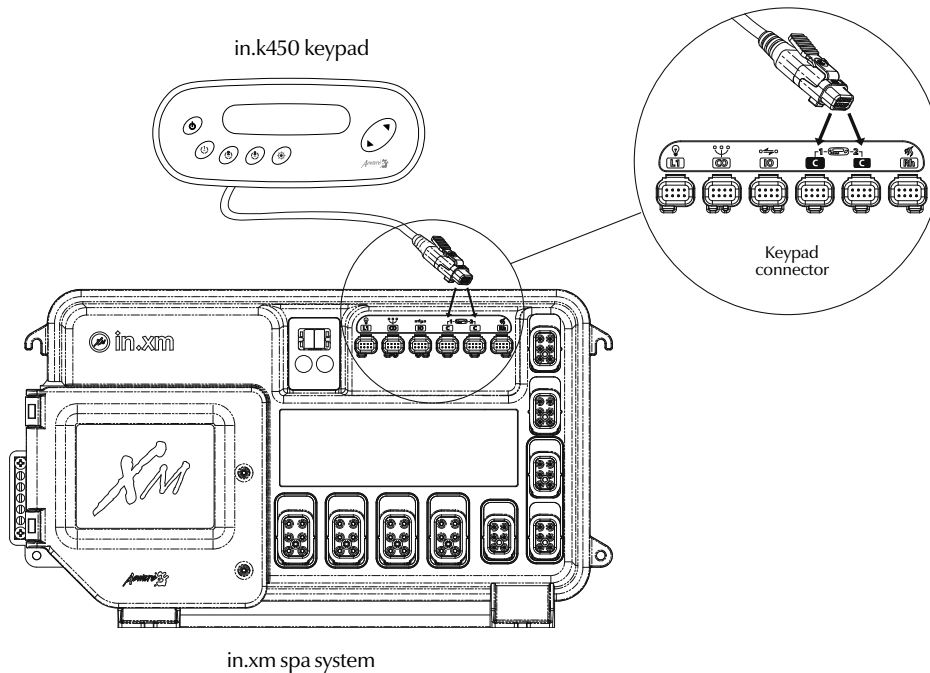



in.k450

for in.xe spa systems

user instructions and functions

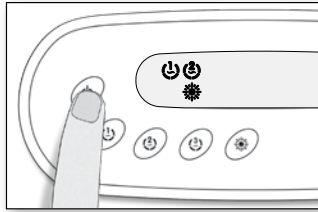

On/Off key

Depending on the spa manufacturer, this key may have different functions: On/Off, Standby mode or quick enable of the Economy mode.

On/Off Mode

By default, the system is always on. Press and hold **On/Off** key for 5 sec. (or Press and hold **Pump 1** key for 5 sec.) to shut the system down for 30 minutes.

The display will toggle between the "OFF" message and water temperature. Press On/Off key to restart the system before the expiration of the 30 minutes delay.



Standby Mode

Quick press and release the **On/Off** key to shut the system down (i.e. to set it to Standby mode) for 30 minutes. The display will toggle between the "SBY" message and water temperature. All keys are then disabled, unless you press **On/Off** key again to reactivate the system before the expiration of the 30 minutes delay.

In order to warn the user, the spa light will flash for a few seconds before the exit of Standby mode.

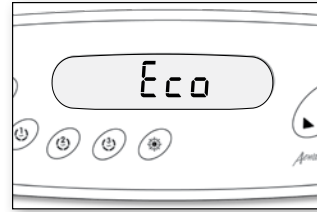

Economy Mode

This mode allows you to lower the temperature set point of the spa by 20 °F (11 °C) during a certain period of the day.

To enable the economy mode: Press and hold **On/Off** key for 10 sec.

While the Economy mode is enabled the display will toggle between "Eco" and the water temperature. Once the system goes back to normal mode, the display will show "noE".

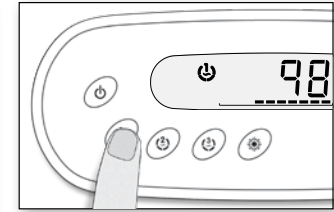

Pump 1 key

Press **Pump 1** key to turn Pump 1 on at low speed. Press a second time to turn pump to high speed (with a dual-speed pump). A third time turns pump off.

A built-in timer automatically turns pump off after a predetermined period of time, unless pump has been manually deactivated first.

** If single speed pump: press Pump key to turn pump on. Press Pump key again to turn pump off.*

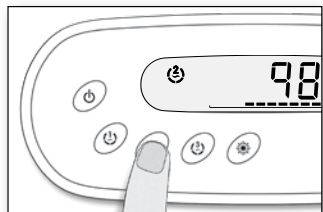

Pump 2 key

Press **Pump 2** key to turn Pump 2 on. Press a second time to turn pump off.

A built-in timer automatically turns pump off after a predetermined period of time, unless pump has been manually deactivated first.

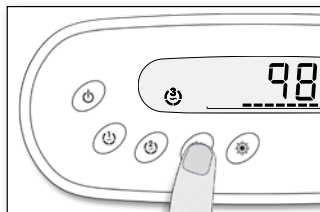

Blower key

Press **Blower** key to turn blower on. Press a second time to turn blower off.

A built-in timer automatically turns blower off after a predetermined period of time, unless blower has been manually deactivated first.

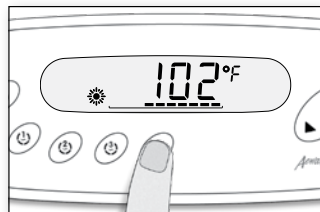

Light key

Press **Light** key to turn light on at high intensity. Subsequent presses change light intensity. A last press turns light off.

A built-in timer automatically turns light off after a predetermined period of time, unless it has been manually deactivated first.

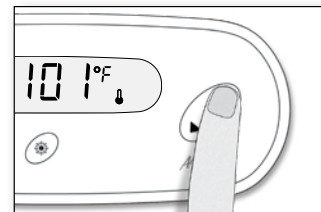

Up/Down keys

Use **Up** or **Down** key to set desired water temperature. The temperature setting will be displayed for 5 seconds to confirm your new selection.

The "Set Point" icon indicates that the display shows the desired temperature, NOT the current water temperature!

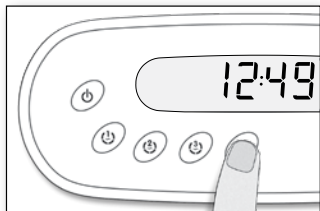

Program key

Use **Program** key to display time or enter Programming mode by pressing and holding key. In Programming mode, the following parameters can be set: time, filter cycle start time, filter cycle duration, filter cycle frequency, and temperature unit.

Note: Light key is used as Program key if this key is not present.

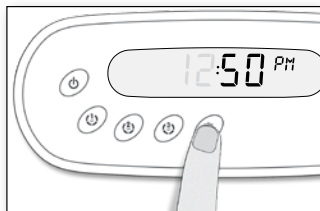

Setting the time

Enter Programming mode by holding **Prog.** key pressed down for 3 sec. The display will show the current time setting.

Setting the hour: Use **Up** or **Down** arrows to change hour setting (AM/PM).

Setting the minutes: Press **Prog.** key a second time.

Use **Up** or **Down** key to change hour setting.

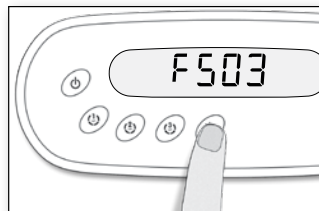

Setting filter cycle start time

To program the filter cycle, you must enter these parameters: the start time, duration and frequency. During a filter cycle, pumps run for one minute to purge the plumbing, then Pump 1 runs for the programmed number of hours.

Press **Prog.** key a third time. The display will show FSxx, with "xx" representing the starting hour.

Use **Up** or **Down** key to change setting.

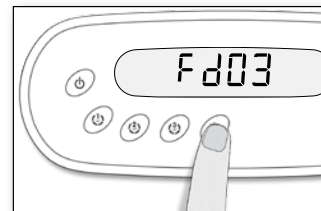

Setting filter cycle duration

Press **Prog.** key a fourth time.

The display will show Fdxx, with "xx" representing the duration in hours.

Use **Up** or **Down** key to change setting.

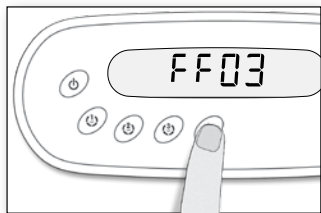

Filter cycle frequency

Press **Prog.** key a fifth time.

The display will show FFxx, with "xx" representing the number of filter cycles per day (up to 4).

Use **Up** or **Down** key to change setting.

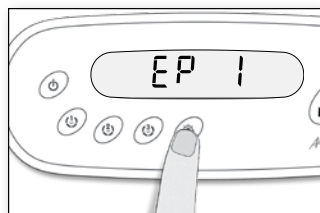

Setting economy mode*

Press **Prog.** key a sixth time. Use **Up** key to enable the economy mode, the display will show EP1 or use **Down** key to disable economy mode, the display will show EP 0.

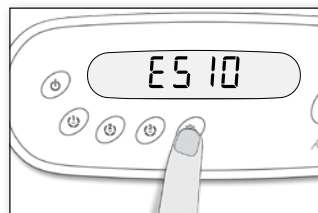

Setting economy start time*

Press **Prog.** key an seventh time. The display will show ESxx, with "xx" representing the starting hour.

Use **Up** or **Down** key to change setting.

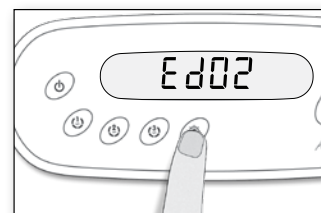

Setting economy duration*

Press and hold **Light** key until the display shows Edxx, with "xx" representing the duration in hours. (Default: 2 hours).

Use **Up** or **Down** key to change setting.
0 = no filtration¹
24 = continuous filtration

¹ It's not recommended to set this to "0".

* Note that the parameters for the economy mode settings are associated to specific low level configuration of the system that are not present in all software revisions.

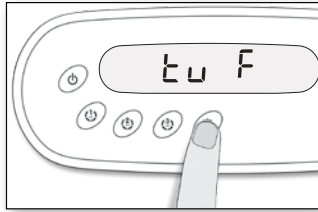

Setting temperature unit

Water temperature can be displayed in either Fahrenheit (°F) or Celsius (°C). Press **Prog.** key a ninth time. The display will show either °F or °C.

Use **Up** or **Down** key to change setting.

Press **Prog.** key once more to go back to normal mode.

Note: "F" will be displayed in in.xe Spa Packs.

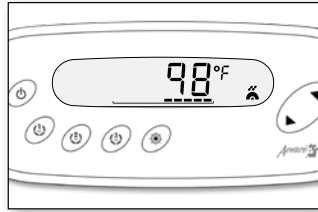

Smart Winter Mode

Our Smart Winter Mode protects your system from the cold by turning pumps on several times a day to prevent water from freezing in pipes.

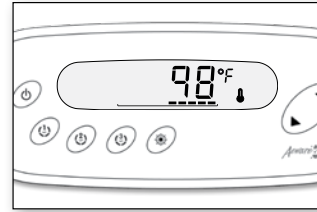

Water temperature regulation

In a regulation cycle, the system first generates water flow through the heater housing and the plumbing, in order to ensure accurate water temperature readings as well as avoiding heater activation in dry conditions.

After verifying pump activation and taking a water temperature reading if required, the system automatically turns the heater on to reach and maintain water temperature at Set Point.

Cooldown

After heating the spa water to the desired Set Point, the heater is turned off, but its associated pump (Pump 1 Low-speed or CP) remains on for a predetermined period of time to ensure adequate cooling of the heating element, this prolongs its useful life. The heater icon flashes during this time.



in.k450

for in.xm spa systems

user instructions and functions

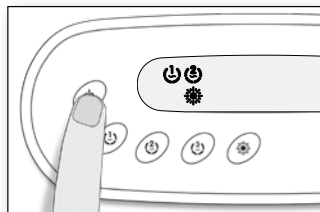

On/Off key

Depending on the spa manufacturer, this key may have different functions: On/Off, Standby mode or quick enable of the Economy mode.

Standby Mode*: Use **On/Off** key to pause all pumps.* Progress bar will display the remaining time before the system automatically exits Standby mode (user can also exit Standby mode at any time by pressing again on **On/Off** key).



In order to warn the user, the spa light will flash for a few seconds before the exit of Standby mode and restart the pumps. The "Stby" message is also displayed during Standby mode.

* *Pump will stay turned on if there is a request for more heat.*

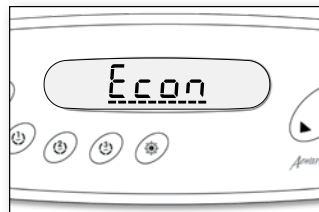

Economy Mode

This mode allows you to lower the temperature set point of the spa by 20 °F (11 °C) during a certain period of the day.

Press and hold the **On/Off** key for 10 sec. to enable the Economy mode. Repeat operation to disable it.

While the Economy mode is enabled the display will toggle between "Econ" and the water temperature. Once the system goes back to normal mode, the display will show "noE" for 3 sec.

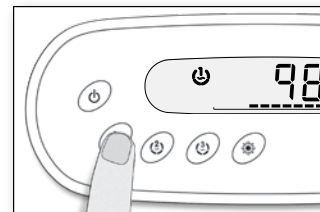

Pump 1 key

Press **Pump 1** key to turn Pump 1 on at low speed. Press a second time to turn pump to high speed (with a dual-speed pump). A third time turns pump off.

A built-in timer automatically turns pump off after a predetermined period of time, unless pump has been manually deactivated first.

* *If single speed pump: press Pump key to turn pump on. Press Pump key again to turn pump off.*

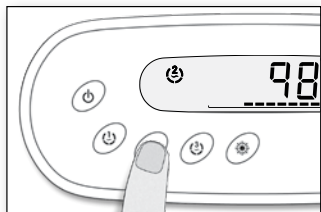

Pump 2 key

Press **Pump 2** key to turn Pump 2 on at low speed. Press a second time to turn pump to high speed (with a dual-speed pump). A third time turns pump off.

A built-in timer automatically turns pump off after a predetermined period of time, unless pump has been manually deactivated first.

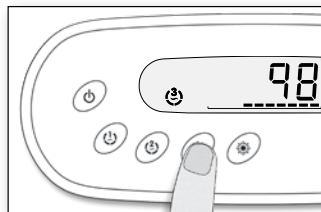

Pump 3 / Blower key

Press **Pump 3/Blower** key to turn Pump 3 /Blower on. Press a second time to turn pump or blower off.

A built-in timer automatically turns pump/blower off after a predetermined period of time, unless pump has been manually deactivated first.

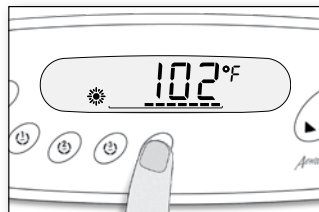

Light key

Press **Light** key to turn light on at high intensity. Subsequent presses change light intensity. A last press turns light off.

A built-in timer automatically turns light off after a predetermined period of time, unless it has been manually deactivated first.

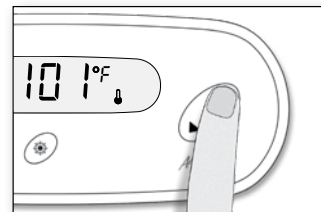

Up/Down keys

Use **Up** or **Down** key to set desired water temperature. The temperature setting will be displayed for 5 seconds to confirm your new selection.

The "Set Point" icon indicates that the display shows the desired temperature, NOT the current water temperature!



Program key

Use **Program** key to display time or enter Programming mode by pressing and holding key. In Programming mode, the following parameters can be set: time, filter cycle start time, filter cycle duration, filter cycle frequency, and temperature unit.

Note: Light key is used as Program key if this key is not present.



Setting the time

Enter Programming mode by holding **Prog.** key pressed down for 3 sec. The display will show the current time setting.

Setting the hour: Use **Up** or **Down** key to change hour setting (AM/PM).

Setting the minutes: Press **Prog.** key a second time.

Use **Up** or **Down** key to change hour setting.

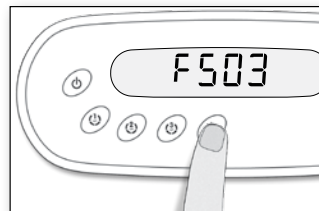

Setting filter cycle start time

To program the filter cycle, you must enter these parameters: the start time, duration and frequency. During a filter cycle, pumps run for one minute to purge the plumbing, then Pump 1 runs for the programmed number of hours.

Press **Prog.** key a third time. The display will show FSxx, with "xx" representing the starting hour.

Use **Up** or **Down** key to change setting.



Setting filter cycle duration

Press **Prog.** key a fourth time.

The display will show Fdxx, with "xx" representing the duration in hours.

Use **Up** or **Down** key to change setting.

0 = no filtration¹
24 = continuous filtration

¹ *It's not recommended to set this to "0".*

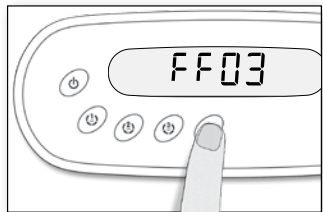

Filter cycle frequency

Press **Prog.** key a fifth time.

The display will show FFxx, with "xx" representing the number of filter cycles per day (up to 4).

Use **Up** or **Down** key to change setting.

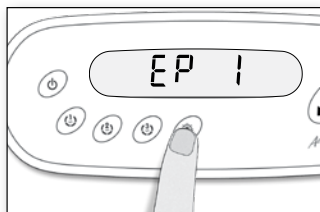

Setting economy mode*

This mode allows you to lower the temperature set point of the spa by 20 °F (11 °C) during a certain period of the day.

Press **Prog.** key a sixth time. Use **Up** key to enable the economy mode, the display will show EP1 or use **Down** key to disable economy mode, the display will show EP 0.

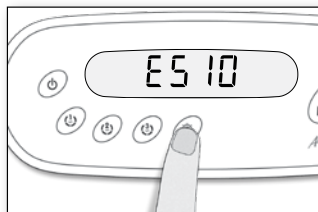

Setting economy start time*

Press **Prog.** key an seventh time. The display will show ESxx, with "xx" representing the starting hour.

Use **Up** or **Down** key to change setting.

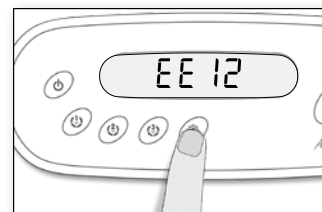

Setting economy end time*

Press **Prog.** key a eighth time. The display will show EExx, with "xx" representing the ending time in hour.

Use **Up** or **Down** key to change setting.

** Note that the parameters for the economy mode settings are associated to specific low level configuration of the system that are not present in all software revisions.*

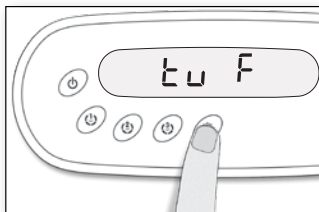

Setting temperature unit

Water temperature can be displayed in either Fahrenheit (°F) or Celsius (°C). Press **Prog.** key a ninth time. The display will show either °F or °C.

Use **Up** or **Down** key to change setting.

Press **Prog.** key once more to go back to normal mode.

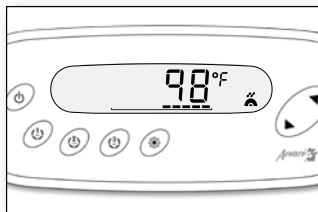

Smart Winter Mode

Our Smart Winter Mode protects your system from the cold by turning pumps on several times a day to prevent water from freezing in pipes.

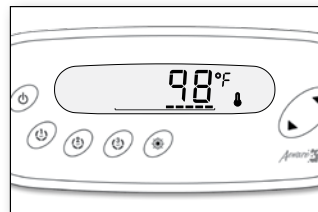

Water temperature regulation

In a regulation cycle, the system first generates water flow through the heater housing and the plumbing, in order to ensure accurate water temperature readings as well as avoiding heater activation in dry conditions.

After verifying pump activation and taking a water temperature reading if required, the system automatically turns the heater on to reach and maintain water temperature at Set Point.

Cooldown

After heating the spa water to the desired Set Point, the heater is turned off, but its associated pump (Pump 1 Low-speed or CP) remains on for a predetermined period of time to ensure adequate cooling of the heating element, this prolongs its useful life. The heater icon flashes during this time.



in.xm error codes

in.xe error codes

Description

			<p>The chosen input current rating is lower than the sum of current for all pumps. Call your electrician for tech support.</p>
			<p>Temperature inside the spa skirt is too high, causing the internal temperature in the Spa Pack to increase above normal limits. Open skirt and wait until error clears. If error persists, note the error message and contact dealer or service supplier for Tech Support.</p>
			<p>The water temperature in the spa has reached 108°F (42°C). Do not enter the water! Remove the spa cover and allow the water to cool down to a lower temperature. If problem persists, Note the error message and contact dealer or service supplier for Tech Support.</p>
			<p>Any other SP error code Note the error message and contact dealer or service supplier for Tech Support.</p>



in.xm error codes

in.xe error codes

Description

		<p>An internal hardware error has been detected Note the error message and contact dealer or service supplier for Tech Support.</p>
		<p>The system has shut the heater down because the temperature at the heater has reached 119°F (48°C). Do not enter the water! Remove the spa cover and allow the water to cool down, then shut power off and power your spa up again to reset the system. If problem persists, note the error message and contact dealer or service supplier for Tech Support.</p>
		<p>The system does not detect any water flow while the primary pump is running. Check and open water valves. Check for water level. Clean filter. If the problem persists, call your dealer or service supplier</p>
		<p>A problem is detected with the temperature probe. Note the error message and contact dealer or service supplier for Tech Support.</p>
	<p>Any other RH code Note the error message and contact dealer or service supplier for Tech Support.</p>	



in.xm error codes

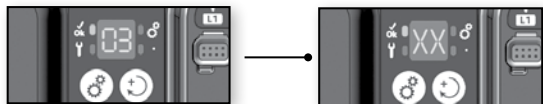
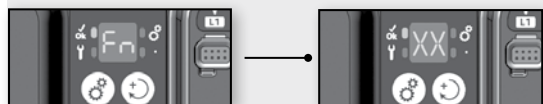
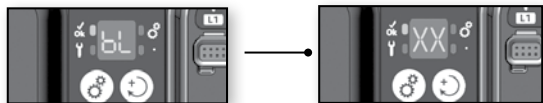
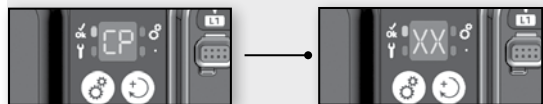
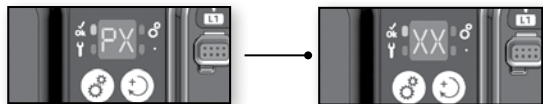

Description

A Pump problem has been detected

Note the error message and contact dealer or service supplier for Tech Support.

A Circ. Pump problem has been detected

Note the error message and contact dealer or service supplier for Tech Support.

A Blower problem has been detected

Note the error message and contact dealer or service supplier for Tech Support.

A Fan problem has been detected

Note the error message and contact dealer or service supplier for Tech Support.

An Ozonator problem has been detected

Note the error message and contact dealer or service supplier for Tech Support.



Dimensions:

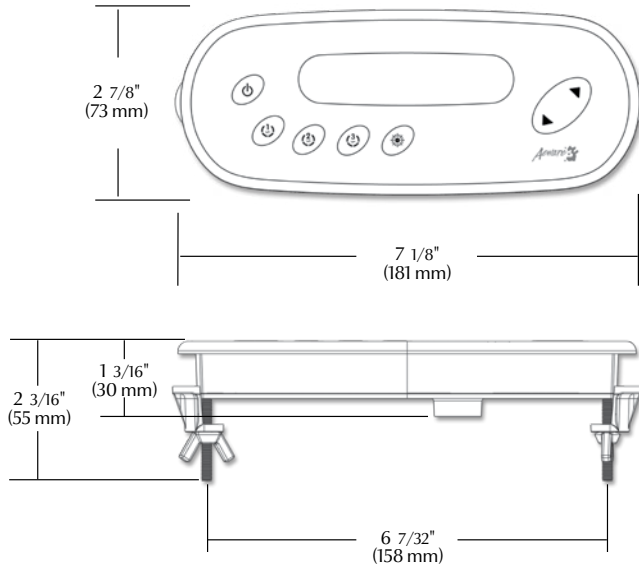

General specifications:

Environmentals:

Storage temperature: 70°C (158°F) to -30°C (-22°F)

Operating temperature: 60°C (140°F) to -20°C (-4°F)

Humidity: up to 95% condensing

Mechanical Specs:

Weight: 0.52 kg (1.2 lbs)

Dimensions (W x H x D): Front Panel:

181 mm x 73 mm x 55 mm

(7 1/8" x 2 7/8" x 2 3/16") Soft gasket

Standards:

UL 1563 Fifth Ed. File: E182156

CSA No. 22.2 - 218.1-M89



Specifications and design are subject to change without notice.

Advanced electronics! Water resistance!



Aeware 3
by gecko

Gecko Alliance

450 des Canetons, Quebec City (QC) G2E 5W6 Canada, 1.800.78.GECKO

www.geckoalliance.com