



IN-WALL™ SLIDE-OUT  
**OWNER'S MANUAL**

L I P P E R T  
C O M P O N E N T S™

# TABLE OF CONTENTS

<b>System and Safety Information</b> .....	<b>2</b>
Safety Information.....	<b>2</b>
<b>Prior to Operation</b> .....	<b>3</b>
<b>Operation</b> .....	<b>3</b>
Extending Slide-out Room.....	<b>3</b>
Retracting Slide-out Room.....	<b>3</b>
<b>Troubleshooting</b> .....	<b>4</b>
Controller Overview (B Version).....	<b>4</b>
Controller Overview (C-2 Version).....	<b>5</b>
Electronic Manual Override.....	<b>6</b>
Extend and Retract Switch Connections.....	<b>6</b>
Power and Ground Connections at the Controller.....	<b>6</b>
Error Codes.....	<b>6</b>
Low Voltage.....	<b>6</b>
Obstructions.....	<b>7</b>
Checking Fuses.....	<b>7</b>
Motors and Harnesses.....	<b>7</b>
Resynchronizing the Slide-out Motors.....	<b>7</b>
<b>IN-WALL™ Slide-out Assembly</b> .....	<b>8</b>
<b>IN-WALL™ Slide-out Controllers</b> .....	<b>9</b>
<b>IN-WALL™ Slide-out Motors</b> .....	<b>10</b>
<b>IN-WALL™ Slide-out Components</b> .....	<b>11 - 14</b>

## System and Safety Information

### Safety Information



**Failure to act in accordance with the following may result in death, serious injury, coach or property damage.**

The IN-WALL™ Slide-out System is intended for the sole purpose of extending and retracting the slide-out room. Its function should not be used for any purpose or reason other than to actuate the slide-out room. To use the system for any reason other than what it is designed for may result in death, serious injury or damage to the coach.

Before actuating the system, please keep these things in mind:

- 1.** Parking locations should be clear of obstructions that may cause damage when the slide-out room is actuated.
- 2.** Be sure all persons are clear of the coach prior to the slide-out room actuation.
- 3.** Keep hands and other body parts away from slide-out mechanisms during actuation.
- 4.** To optimize slide-out actuation, park coach on solid and level ground.

## Prior to Operation

1. Park the coach on the most level surface available.
2. Actuate the leveling or stabilizing systems to ensure coach will not move during operation of slide-out system.
3. Be sure battery is fully charged.
4. Be sure to keep all persons and pets clear of slide-out system during operation.

**NOTE:** Install transit bars (if so equipped) on the slide-out room during storage and transportation.



**Always make sure that the slide-out room path is clear of people and objects before and during operation of the slide-out. Always keep away from the gear racks when the room is being operated.**

## Operation

### Extending Slide-out Room

1. Level the unit.
2. Verify the battery is fully charged and hooked up to the electrical system.
3. Remove the transit bars (if so equipped).
4. Press and hold the IN/OUT switch (Fig. 1B) in the OUT position until the room is fully extended and stops moving.

**NOTE:** It is important to continue to press the slide-out switch for a few seconds after the room is fully extended until the motor shuts off. The control will sense that the room has stopped and will shut off the motor after a few seconds.

5. Release the switch, which will lock the room into position.

### Retracting Slide-out Room

1. Verify the battery is fully charged and hooked-up to the electrical system.
2. Press and hold the IN/OUT switch (Fig. 1A) in the IN position until the room is fully retracted and stops moving.

**NOTE:** It is important to continue to press the slide-out switch for a few seconds after the room is fully retracted until the motor shuts off. The control will sense that the room has stopped and will shut off the motor after a few seconds.

3. Release the switch, which will lock the room into position.
4. Install the transit bars (if so equipped).

Fig. 1

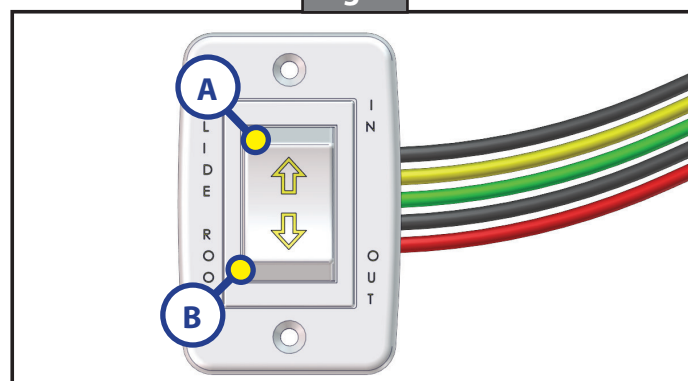

# Troubleshooting

## Controller Overview (B Version)

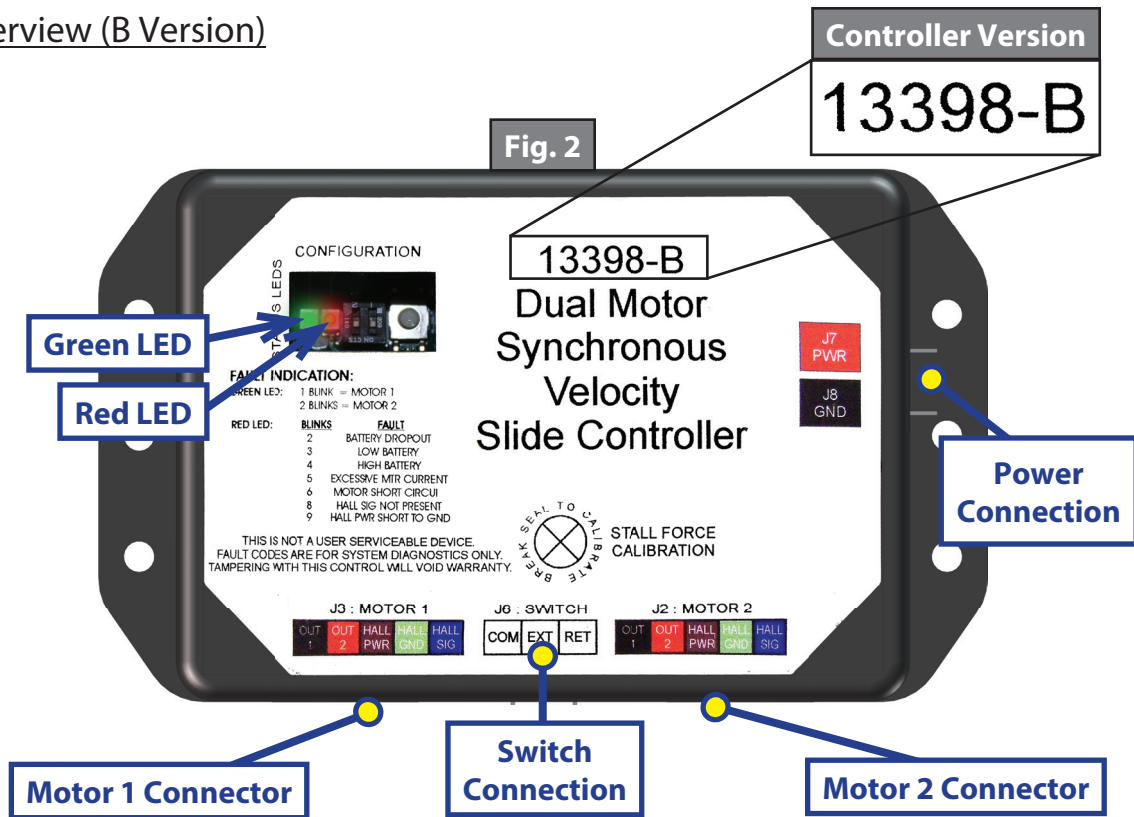

**Fig. 3 - Controller Connections**



**Fig. 4 - End of Motor Harness**



**Status LEDs:** 2 LEDs, 1 green and 1 red, are provided to indicate current controller status and faults.

**Power Connection:** 12V DC input. Unit will operate from 8V DC to 18V DC.

**Switch Connection:** Spade connection for the switch wiring.

**Motor 1 Connector:** Power and encoder input for motor 1.

**Motor 2 Connector:** Power and encoder input for motor 2.

**NOTE:** Version B motor harnesses have five wire in-line connectors at the controller and the molded connector at the motor end (Figs. 3 and 4). Wire colors match with color codes on control board. It does not matter which motor is 1 or 2.

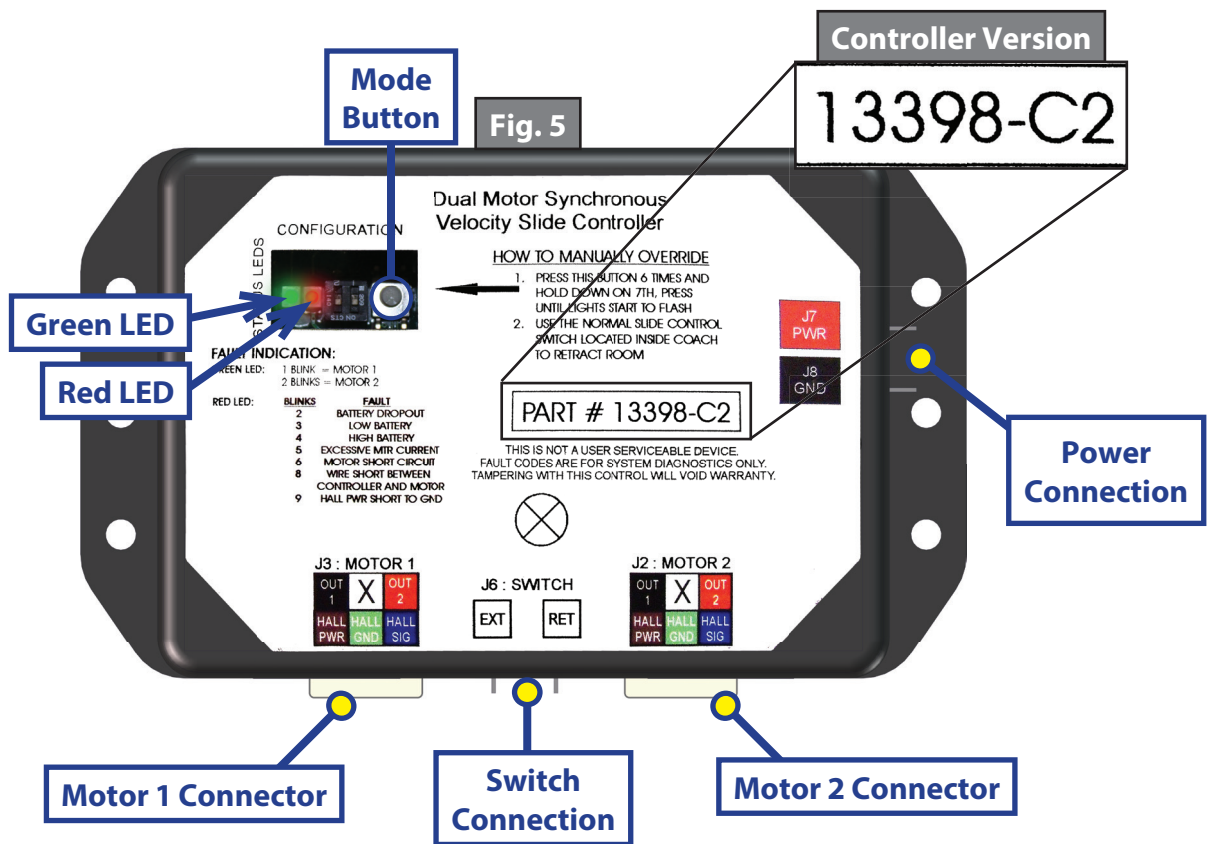

**Fig. 6 - Controller Connections**

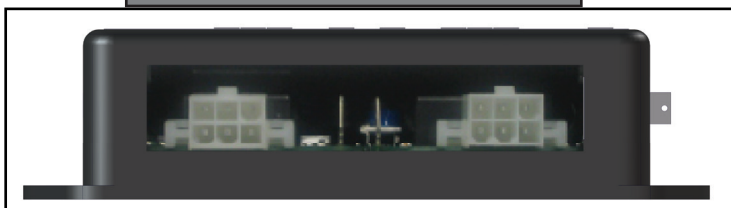

**Fig. 7 - End of Motor Harness**

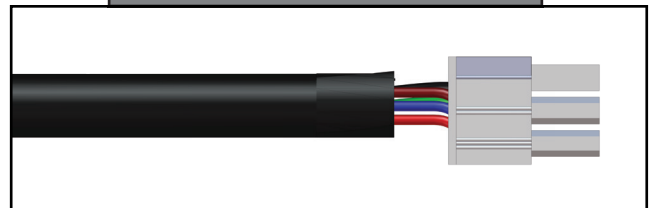

**Status LEDs:** 2 LEDs, 1 green and 1 red, are provided to indicate current controller status and faults.

**Mode Button:** Used to engage the electronic manual override.

**Power Connection:** 12V DC input. Unit will operate from 8V DC to 18V DC.

**Switch Connection:** Spade connection for the switch wiring.

**Motor 1 Connector:** Power and encoder input for motor 1.

**Motor 2 Connector:** Power and encoder input for motor 2.

**NOTE:** Motor harnesses have Molex® connectors at the controller and the molded connector at the motor end (Figs. 6 and 7). Wire colors match with color codes on control board. It does not matter which motor is 1 or 2.

## Electronic Manual Override (Controllers C-1 and C-2 Only)

**NOTE:** See (Fig. 5) for locations of the mode button and LEDs.

1. Press the mode button on the controller six times and hold on the seventh for five seconds to enter electronic manual override mode.
2. Use the extend/retract switch to move both motors in or out.

**NOTE:** Over-current and short circuit detection are disabled. Electronic manual override provides 12V directly to both motors.

3. To exit the mode, push and hold the mode button until the LEDs begin to blink simultaneously. Exiting the override mode resets the motor positions.

### Extend and Retract Switch Connections

Common connection on controller goes to common connection on extend and retract switch. Extend and retract connections on the controller go to the extend and retract terminals on the switch. Switch is powered by the OEM supplied 12V DC power source.

### Power and Ground Connections at the Controller

Power and ground are supplied to the controller through the spade terminals located on the right hand side of the controller (Fig. 8A, 8B). 12V DC is recommended. A 10ga wire is the minimum size recommended.

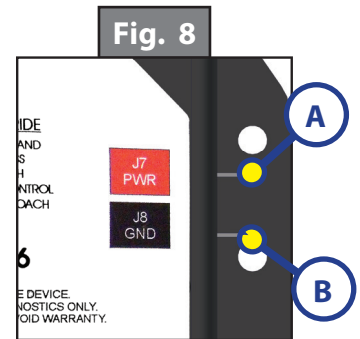

### Error Codes

During operation when an error occurs the board will use the LEDs to indicate where the problem exists. For motor-specific faults the green LED will blink 1 time for motor 1, and 2 times for motor 2. The red LED will blink from 2 to 9 times depending on the error code.

Error Code	Name	Description
2	Battery Drop Out	Battery capacity low enough to drop below 6 volts while running.
3	Low Battery	Voltage below 8 volts at start of cycle.
4	High Battery	Voltage greater than 18 volts.
5	Excessive Motor Current	High amperage, also indicated by 1 side of slide continually stalling.
6	Motor Short Circuit	Motor or wiring to motor has shorted out.
8	Wire Short Between Controller and Motor (Error named "Hall Sig Not Present" on Rev. B controller)	Encoder is not providing a signal, which is usually a wiring problem.
9	Hall Power Short To Ground	Power to encoder has been shorted to ground, which is usually a wiring problem.

When an error code is present, the board needs to be reset. Energizing the extend/retract switch resets the board. Energize the extend/retract switch again for normal operation.

### Low Voltage

The Lippert IN-WALL™ Slide-out Controller is capable of operating the room with as little as 8 volts. But at these lower voltages the amperage requirement is greater. Check voltage at the controller, see pages 4 and 5 for the location of power connections. If voltage is lower than 11 volts, it is recommended that the battery be placed on a charger until it is fully charged. It may be possible to "jump" the RV's battery temporarily to extend or retract the room. Consult the RV manufacturer's owners manual on the procedure for "jumping" or charging the battery.

**NOTE:** Never "jump" or charge the battery from the power connections on the IN-WALL™ Controller. Always do this at the battery.

## Obstructions

Check outside the RV for possible obstructions: tree, post, car, etc. Check inside the RV for any obstructions: luggage, furniture, open cabinets, etc. Also, check for smaller objects that may be wedged under the floor or in the sides of unit. Remove obstructions before proceeding.

## Checking Fuses

The Lippert IN-WALL™ Slide-out requires a minimum of a 30-amp fuse. Check the 12-volt fuse box for blown fuses, and replace any if necessary. Consult the RV manufacturer's documentation for the location of the 12-volt fuse box, and the location of the IN-WALL™ Slide-out controller's fuse. If the fuse blows immediately upon replacement, there is a problem with the wiring to the IN-WALL™ Slide-out controller. Have qualified service personnel check and repair.

## Motors and Harnesses

1. Check for proper connections between the motors and harnesses (Fig. 9).
2. Visually inspect the exposed harnesses to ensure they are not pinched or damaged.

**NOTE:** Ribs on motor connector line up with notch inside of male connector on wiring harness. Color codes on wires also match (black to black, red to red, etc.).

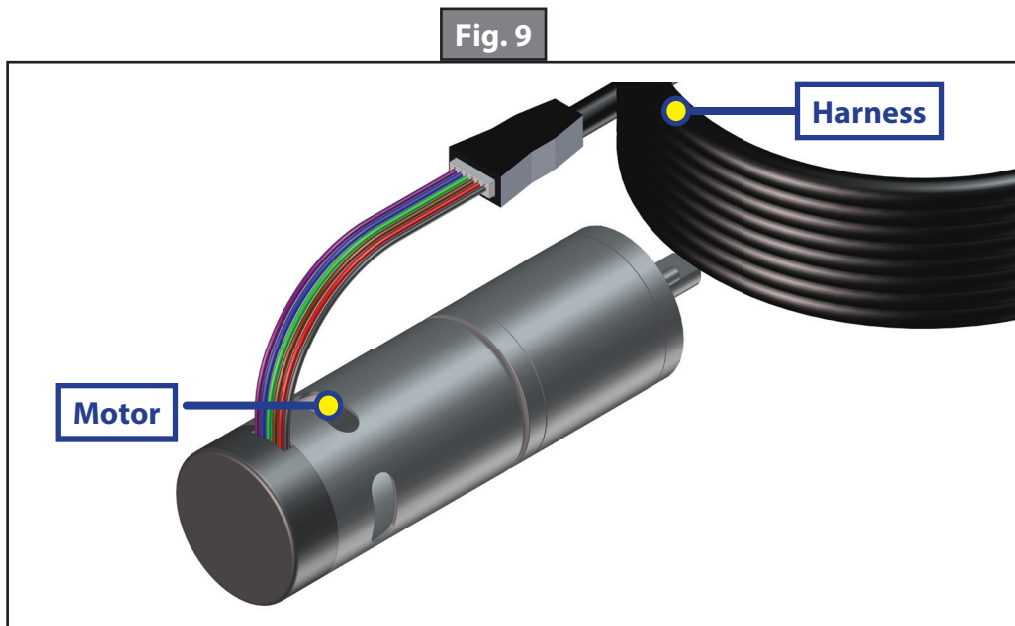

## Resynchronizing the Slide-out Motors

3. Fully extend the slide room using the switch. Keep the switch engaged until the motors shut down on their own.
4. Retract the room 1-2 inches.
5. Repeat steps 1 and 2 until both motors shut down at the same time. In many cases, two or three repetitions are necessary to re-sync the system.
6. Fully extend and then retract the room. Again, always let the motors shut down on their own before releasing the switch.

## SLIDE-OUTS

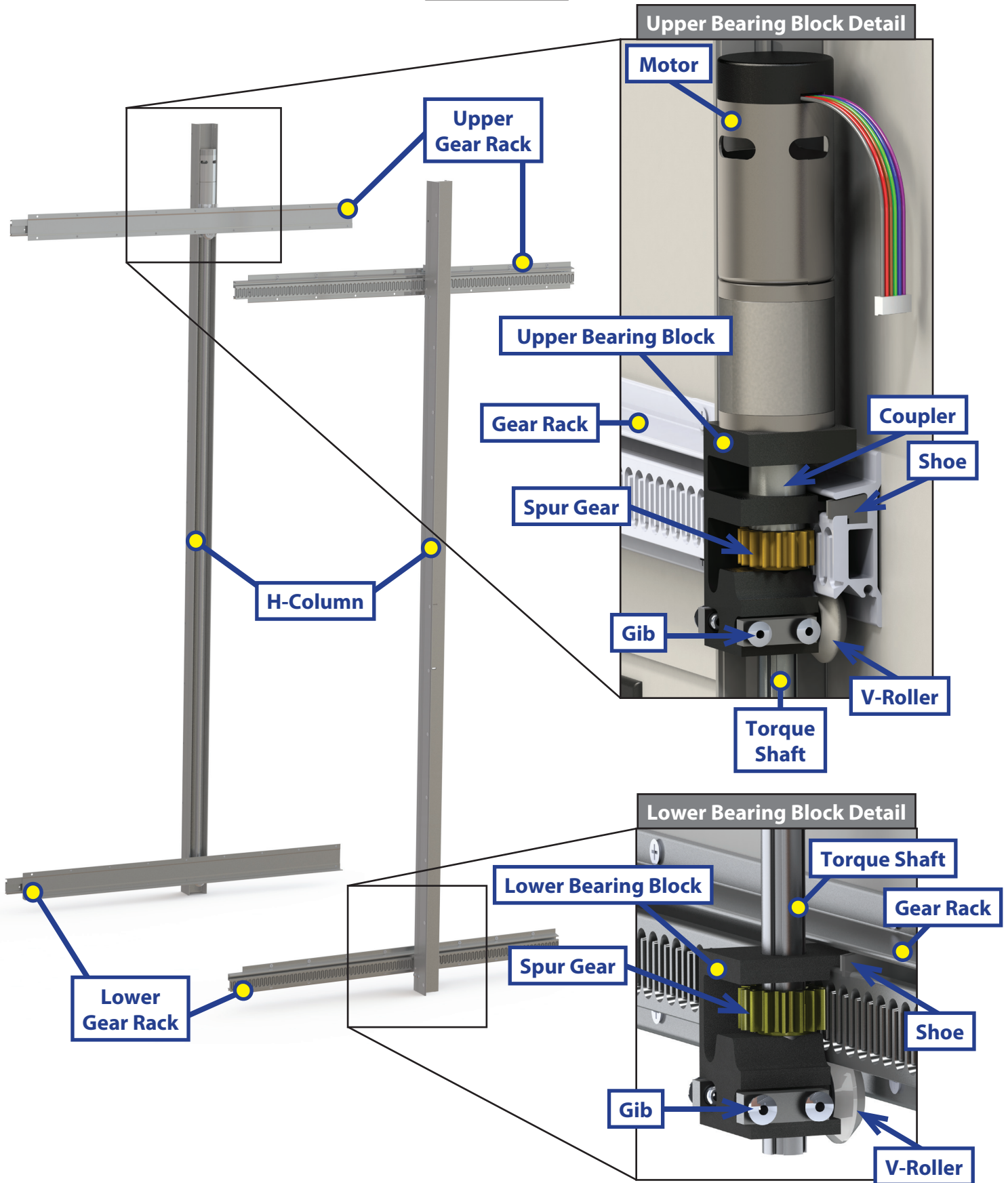



## SLIDE-OUTS

Rev B

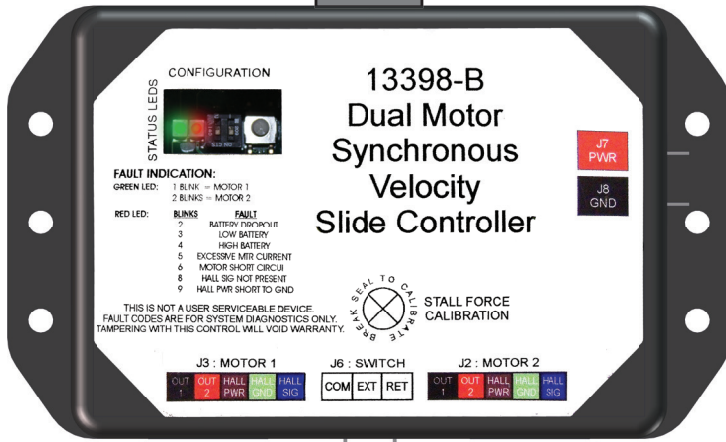

Rev C-1



Rev C-2

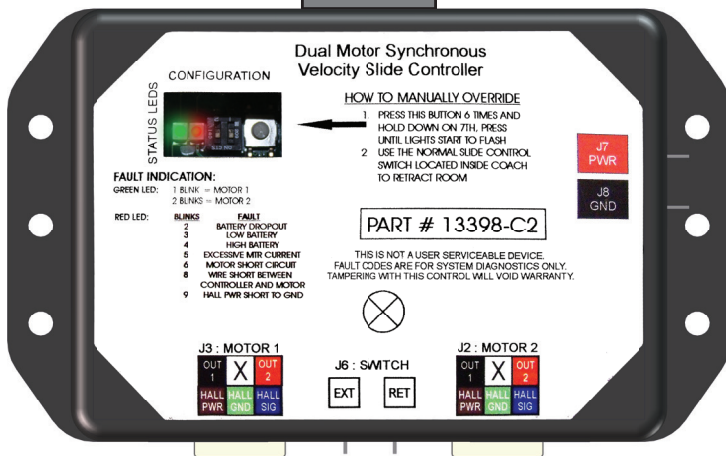

8 Amp

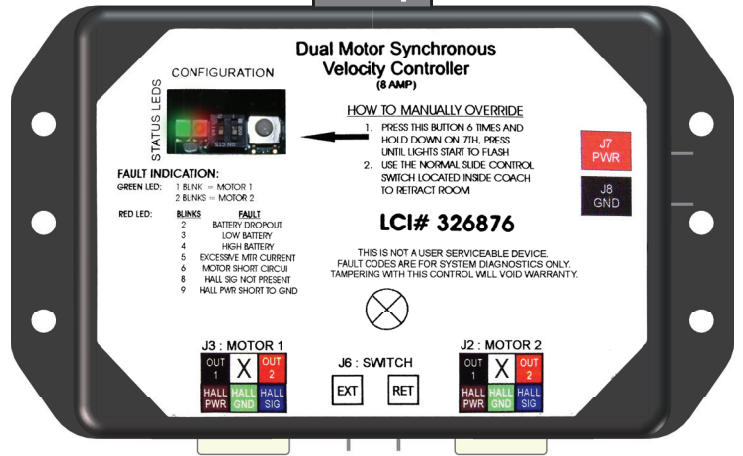

Part #	Description
211852 - Rev B, Rev C-1, Rev C-2	Dual Motor Synchronous Velocity Slide Controller
326876 - 8 amp	Dual Motor Synchronous Velocity Slide Controller <b>NOTE:</b> This controller will not replace other controller versions.

## SLIDE-OUTS



Callout	Part #	Description
A	229466	Motor
B	287298	Motor, High Torque 500:1
C	236575	Motor, 300:1
D	-	Obsolete (Replace with 236575)



LIPPERT  
COMPONENTS

# IN-WALL™ SLIDE-OUT COMPONENTS

## SLIDE-OUTS

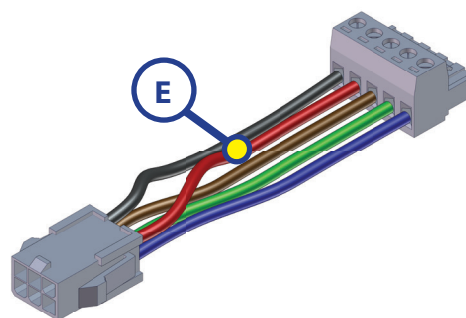
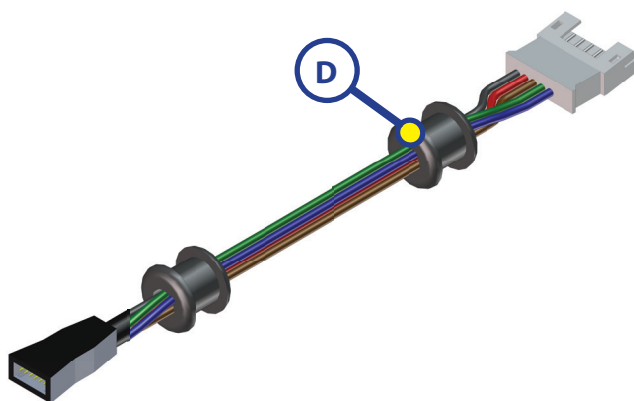
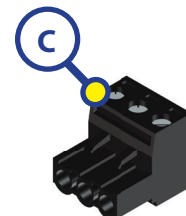
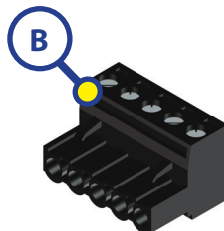
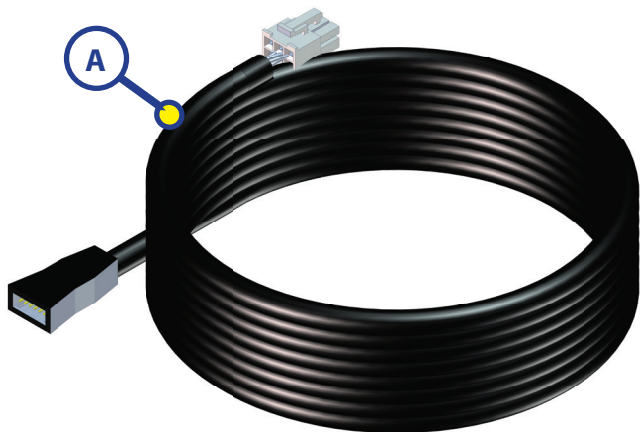

Callout	Part #	Description
A	238744	5 ft. Controller to Motor Harness
	238990	10 ft. Controller to Motor Harness
	247768	15 ft. Controller to Motor Harness
	229755	20 ft. Controller to Motor Harness
	238991	25 ft. Controller to Motor Harness
	229756	30 ft. Controller to Motor Harness
	238992	35 ft. Controller to Motor Harness
B	229758	Harness Connectors 5 Wires
C	229759	Harness Connectors 3 Wires
D	241834	5 ft. Interconnect Harness
	241835	6 ft. Interconnect Harness
	241836	8 ft. Interconnect Harness
E	258760	Slide Controller 6" Pigtail Harness (For use with B and C-1 Controllers with (A) harness)

# IN-WALL™ SLIDE-OUT COMPONENTS

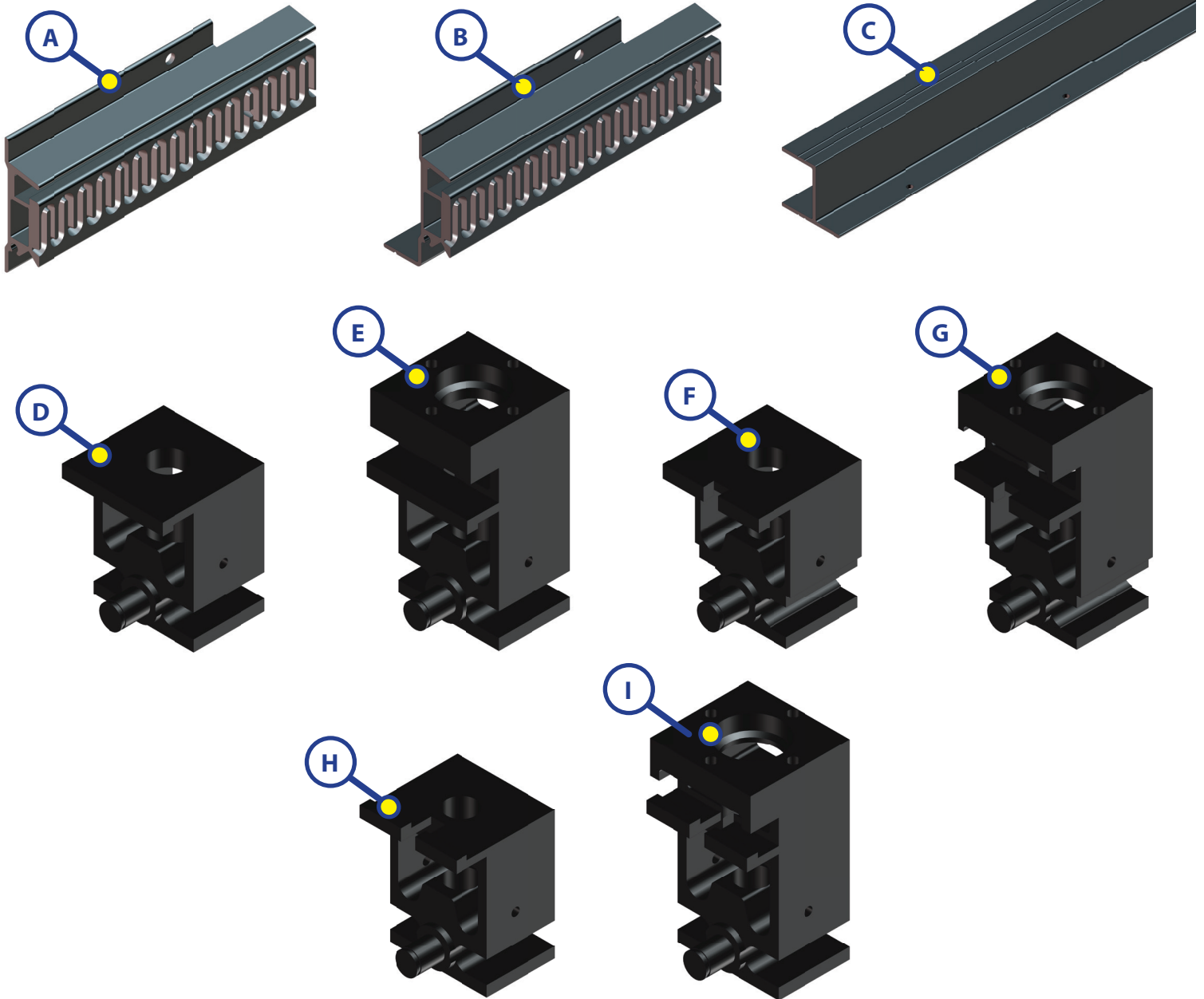

Callout	Part #	Description
A	254569	Upper Gear Rack
B	254570	Lower Gear Rack
C	240411	H-Column, Black
	238457	H-Column, White
D	239365	Lower Bearing Block
E	239366	Upper Bearing Block
F	335632	Lower Bearing Block (Hex Shaft)
G	335633	Upper Bearing Block (Hex Shaft)
H	338237	Lower Bearing Block (Steel Shaft)
I	338241	Upper Bearing Block (Steel Shaft)

# IN-WALL™ SLIDE-OUT COMPONENTS

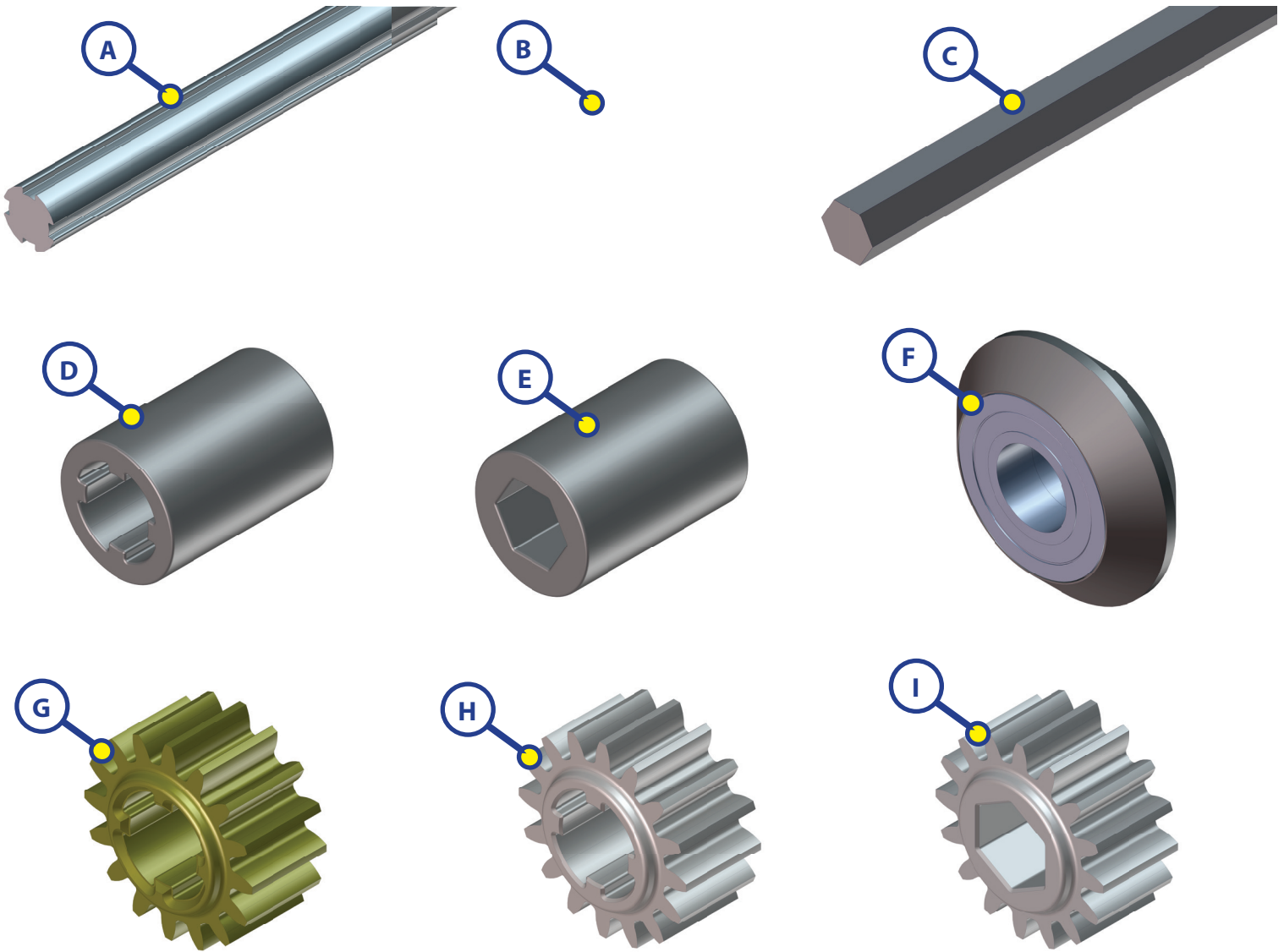

Callout	Part #	Description
A	238462	Aluminum Torque Shaft
B	259065	Steel Torque Shaft
C	295873	Hex Torque Shaft
D	238461	Coupler - Old Style (for 229466 Motor)
	238461	Coupler - New Style (for 236575 Motor)
E	285083	Hex Coupler
F	292801	V-Roller Assembly
G	238893	Spur Gear
H	292435	Copper Infused Spur Gear
I	285085	Hex Spur Gear

## SLIDE-OUTS

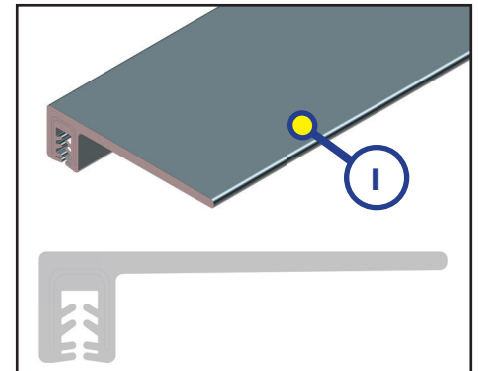
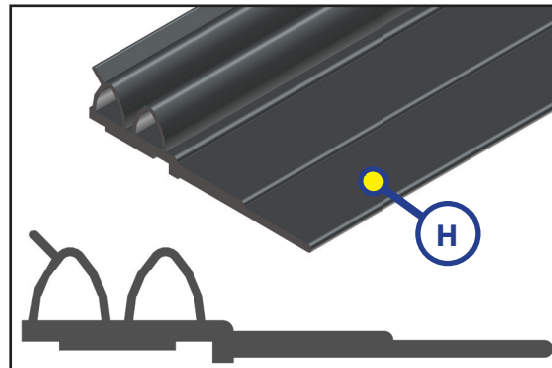
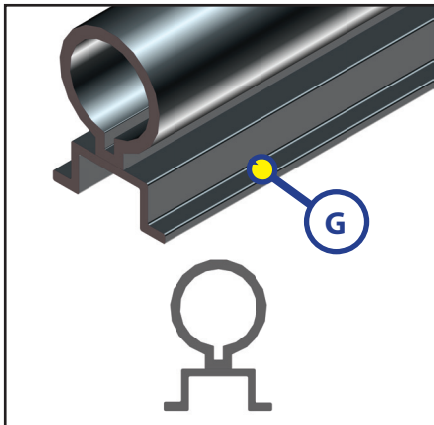
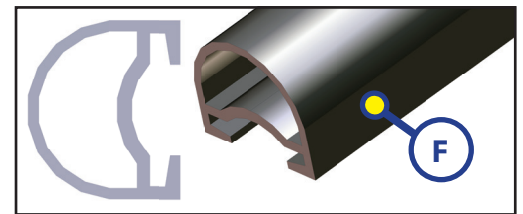
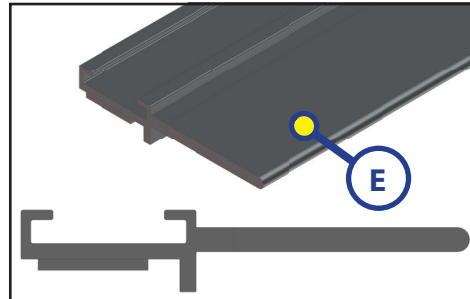
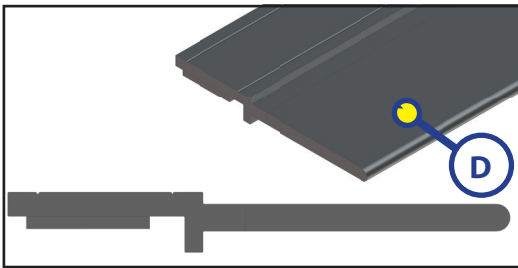
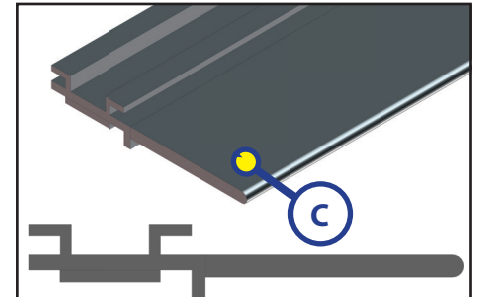
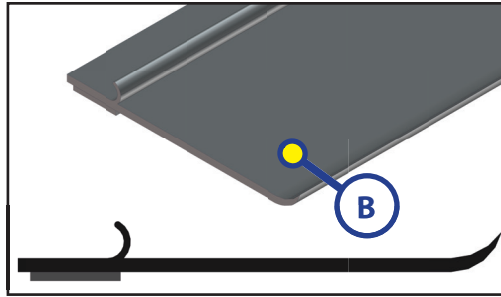
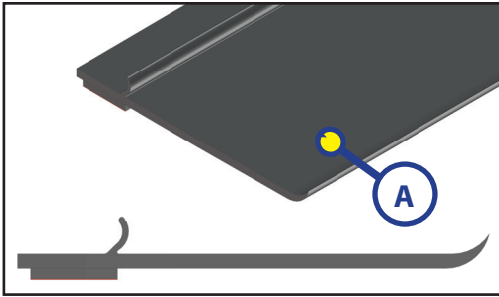

Callout	Part #	Description	Measurements
A	156603	Seal	1" x 2 21/32" x 5/64"
B	132733	Sweep Seal	2 43/64" x 1/16"
C	239667	EK Design Flap	1 1/4"
D	240410	Flat Side Wiper	1 1/4"
E	240448	KE Black Single Wiper with Leg	1 1/4"
F	260406	EK Black Slide on D-Seal	-
G	240449	KE Black Slide on Bulb Seal	-
H	253344	Winnebago Double Bulb Seal	-
I	300614	Slide-out Seal	144"



# L I P P E R T C O M P O N E N T S™

The contents of this manual are proprietary and copyright protected by Lippert Components, Inc. ("LCI"). LCI prohibits the copying or dissemination of portions of this manual unless prior written consent from an authorized LCI representative has been provided. Any unauthorized use shall void any applicable warranty. The information contained in this manual is subject to change without notice and at the sole discretion of LCI.

Revised editions are available for free download from [www.lci1.com](http://www.lci1.com).

Please recycle all obsolete materials.

For all concerns or questions, please contact  
Lippert Components, Inc.

Ph: (574) 537-8900 | Web: [www.lci1.com](http://www.lci1.com) | Email: [warranty@lci1.com](mailto:warranty@lci1.com)