

DAIKIN AC[®]
absolute comfort

VRV III[®]
VRV-W III[®]
VRV III-S[®]

INDOOR UNITS



AIR COOLED ■ WATER COOLED ■ RESIDENTIAL ■ COMMERCIAL ■ RENOVATION ■ NEW CONSTRUCTION

VRV: The Components

Condensing units

Air-Cooled Condensers

VRV III-S

Heat Pump



3 and 4-Ton
208-230V/60Hz/1ph

VRV III

Heat Pump or
Heat Recovery



6 to 16-Ton
208-230V/60Hz/3ph or
460V/60Hz/3ph

Water-Cooled Condenser

VRV-WIII

Heat Pump or
Heat Recovery



6 to 21-Ton
208-230V/60Hz/3ph

REFNET®

REFNET joints distribute an equal flow of refrigerant in every branch of the piping network.



A BSVQ changeover box is necessary for heat recovery applications.



Controls

Individual Zone Controllers			Multi-Zone Controllers		Time Clock Controllers
NEW Navigation Wired R/C BRC1E71	Simplified Wired R/C BRC2A71	Wireless R/C BRC7C812 BRC7E83 BRC4C82 BRC7E818	Unified On/Off R/C DCS301C71	Centralized R/C DCS302C71	Schedule Timer DST301BA61

LonWorks® Networks Compatible Interface

- Interface for LonWorks networks
- Communication via LON protocol (twisted pair wire)
- 64 units connectable per interface
- Unlimited site size
- Quick, easy installation



Integrated control system connecting VRV system with Building Management system

- Interface for BMS system
- Communication via BACnet® protocol (BACnet/IP)
- 256 units connectable per BACnet® gateway (with DAM411B51)
- Unlimited site size
- Quick, easy installation



**Intelligent
Manager III**



**Intelligent
Controller**



IMP-128/256/512/768/1,024



- 1,024 indoor units (organized in up to 200 control groups)
- Management of AC units and ancillary equipment
- Operation on one master PC and one sub PC (sub PC option)
- Remote monitoring via the Web
- Alarm e-mail function

DCS601C71

- 64 groups (128 indoor units) connectable
- Management of AC units and ancillary equipment
- Touch screen display
- Built-in Ethernet port, Web enabled (optional)
- Alarm e-mail function

VRV Indoor Units

Indoor Type	MBH	Capacity Range											Page				
		7.5	09	12	18	24	30	36	42	48	54	72		96			
		Tons	0.6	0.75	1	1.5	2	2.5	3	3.5	4	4.5		6	8		
Ducted	Vertical air handling unit (horizontal RHS is possible)	FXTQ_PAVJU 			 	 	 	 	 	 	 	 			4		
	DC ducted concealed ceiling (medium static)	FXMQ_PVJU 	 	 	 	 	 	 	 	 	 				6		
	Concealed ceiling unit (medium static)	FXMQ_MVJU 											 	 		8	
	Slim duct built-in concealed ceiling unit	FXDQ_MVJU 	 	 	 	 	 									10	
Duct-free	Round flow ceiling mounted cassette	FXFQ_PVJU 		 	 	 	 	 	 	 	 				12		
	2' x 2' 4-way ceiling mounted cassette	FXZQ_M7VJU 	 	 	 	 										14	
	Wall mounted unit	FXAQ_MVJU 															16
	Ceiling suspended unit	FXHQ_MVJU 															18
	Floor standing unit	FXLQ_MVJU 															20
	Concealed floor standing unit	FXNQ_MVJU 			 	 	 										20
Ventilation	100% Outside Air Processing Unit	FXMQ_MFVJU 								 		 	 		22		

-  Available (11 types, 51 models)
-  Condensate pump standard on model
-  Outside air connection possible on model

Vertical Air Handling Unit

FXTQ_PAVJU

Concealed. Powerful. Compact. Comfortable.

The upflow or horizontal (RHS) air handling unit is designed for use with all Daikin VRV® systems allowing more flexibility and combination possibilities. Ranging from 1 to 4 1/2 tons, the vertical air handling* unit by Daikin will take your next installation above and beyond your expectations.

*Horizontal right configuration is possible



Outside air integration possible

Electric heater options

Model Name	Electrical heater capacity						
	3kW	5kW	6kW	8kW	10kW	15kW	20kW
FXTQ12PAVJU	■	■	×	×	×	×	×
FXTQ18PAVJU	●	■	■	×	×	×	×
FXTQ24PAVJU	●	■	■	■	■	×	×
FXTQ30PAVJU	●	●	■	■	■	×	×
FXTQ36PAVJU	●	●	■	■	■	×	×
FXTQ42PAVJU	●	●	●	●	■	■	×
FXTQ48PAVJU	●	●	●	●	■	■	■
FXTQ54PAVJU	●	●	●	●	■	■	■

● Electric heater operation with heat pump is allowed × Not allowed
 ■ Only electric heater operation is allowed ◆ Acceptable 2 step heating operation

The FXTQ_PAVJU represents an improvement in Electric Heater options and control logic versus previous units:

- Wide line up of electric heat (field installed) options from 3kW to 20kW
- Integrated KRP1 function to minimize cost
- Electric heater operation in combination with heat pump operation (boost) is now possible
- Reduced operational deadband

A field supplied and installed Ground Fault Circuit Interrupter is required when utilizing the electric heat option

Features and Benefits

- Reduced installation time with integrated Electronic Expansion Valve and Printed Circuit Boards
- Improved application flexibility with the ability to mix and match with other Daikin indoor units on the same system
- Wider application range with dual voltage 208-230V/1ph/60Hz power supply
- Reduced piping cost with smaller piping diameters
- Only up flow and horizontal right installation is permitted
- Improved user comfort with 2 selectable fan speeds (H and L)
- New fan "Auto" logic allowing the unit to be commissioned where the fan operation will cycle on and off with the load
- The ECM fan motor as standard contributes to the increase in energy efficiency, reduction in sound and increased ESP (up to 0.5" W.G.)
- Ideal replacement for fan coils, vertical stacks or PTACs
- Replacement for geothermal heat pump and traditional split systems
- New construction or replacement

Application

- Offices
- Hotels
- Multi-family residences
- Single family residences



FXTQ Specifications

FXTQ Specifications		1-Ton	1.5-Ton	2-Ton	2.5-Ton	3-Ton	3.5-Ton	4-Ton	4.5-Ton
Model Name		FXTQ12PAVJU	FXTQ18PAVJU	FXTQ24PAVJU	FXTQ30PAVJU	FXTQ36PAVJU	FXTQ42PAVJU	FXTQ48PAVJU	FXTQ54PAVJU
Power Supply	V/ph/Hz	208-230/1/60							
Cooling Capacity	Btu/h	12,000	18,000	24,000	30,000	36,000	42,000	48,000	54,000
Heating Capacity	Btu/h	13,500	20,000	27,000	34,000	40,000	47,000	54,000	60,000
Refrigerant		R-410A	R-410A	R-410A	R-410A	R-410A	R-410A	R-410A	R-410A
Refrigerant Control		Electronic Expansion Valve							
Airflow Rate H/L	cfm	400/280	600/420	800/560	1,000/700	1,200/840	1,400/980	1,600/1,120	1,800/1,260
Unit Weight	lbs.	119	119	145	145	145	167	167	167
Unit Height	in.	46 3/4	46 3/4	53 1/4	53 1/4	53 1/4	53 1/4	53 1/4	53 1/4
Unit Width	in.	19 1/2	19 1/2	22	22	22	22	22	22
Unit Depth	in.	22	22	24	24	24	24	24	24
Sound Pressure H/L	dB(A)	n/a	n/a	n/a	n/a	n/a	n/a	n/a	n/a
External Static Pressure Range	in. W.G.	up to 0.5	up to 0.5	up to 0.5	up to 0.5	up to 0.5	up to 0.5	up to 0.5	up to 0.5
Unit Condensate Connection	in. O.D.	3/4 (fpt)	3/4 (fpt)	3/4 (fpt)	3/4 (fpt)	3/4 (fpt)	3/4 (fpt)	3/4 (fpt)	3/4 (fpt)
Pipe Connections	Gas	in. 1/2 (Braze)	1/2 (Braze)	5/8 (Braze)	5/8 (Braze)	5/8 (Braze)	5/8 (Braze)	5/8 (Braze)	5/8 (Braze)
	Liquid	in. 1/4 (Braze)	1/4 (Braze)	3/8 (Braze)	3/8 (Braze)	3/8 (Braze)	3/8 (Braze)	3/8 (Braze)	3/8 (Braze)
External Finish		Fully insulated, painted steel cabinet with gray finish							
Protection Devices		Fuse Fan Motor Thermal Protector							
Recommended Fuse/Breaker	A	15	15	15	15	15	15	15	15

Nominal Conditions:

Cooling Mode

Indoor: 80 °F DB / 67 °F WB
Outdoor: 95 °F DB
Pipe Length: 25 ft.
Level Difference: 0 ft.

Heating Mode

Indoor: 70 °F DB
Outdoor: 47 °F DB / 43 °F WB
Pipe Length: 25 ft.
Level Difference: 0 ft.

Note:

Specifications are subject to change without notice.

FXTQ Accessories

Model Name	FXTQ12PAVJU	FXTQ18PAVJU	FXTQ24PAVJU	FXTQ30PAVJU	FXTQ36PAVJU	FXTQ42PAVJU	FXTQ48PAVJU	FXTQ54PAVJU
Navigation Remote Controller	BRC1E71	BRC1E71	BRC1E71	BRC1E71	BRC1E71	BRC1E71	BRC1E71	BRC1E71
Simplified Wired Remote Controller*	BRC2A71	BRC2A71	BRC2A71	BRC2A71	BRC2A71	BRC2A71	BRC2A71	BRC2A71
Wireless Remote Controller	BRC4C82	BRC4C82	BRC4C82	BRC4C82	BRC4C82	BRC4C82	BRC4C82	BRC4C82
Remote Sensor kit	KRCS01-4B	KRCS01-4B	KRCS01-4B	KRCS01-4B	KRCS01-4B	KRCS01-4B	KRCS01-4B	KRCS01-4B
Wiring Adaptor PCB (interface with aux/primary heater, humidifier, OA damper/fan)	KRP1C75 ¹	KRP1C75 ¹	KRP1C75 ¹	KRP1C75 ¹	KRP1C75 ¹	KRP1C75 ¹	KRP1C75 ¹	KRP1C75 ¹
Group Control Adaptor PCB (connects to external BMS)	KRP4A74 ²	KRP4A74 ²	KRP4A74 ²	KRP4A74 ²	KRP4A74 ²	KRP4A74 ²	KRP4A74 ²	KRP4A74 ²
External Control Adapter for Outdoor Unit	DTA104A53 ²	DTA104A53 ²	DTA104A53 ²	DTA104A53 ²	DTA104A53 ²	DTA104A53 ²	DTA104A53 ²	DTA104A53 ²
Fixing Box	KRP1B101 ³	KRP1B101 ³	KRP1B101 ³	KRP1B101 ³	KRP1B101 ³	KRP1B101 ³	KRP1B101 ³	KRP1B101 ³
Air Filter	FIL 36-42	FIL 36-42	FIL 48-61	FIL 48-61	FIL 48-61	FIL 48-61	FIL 48-61	FIL 48-61
Insulation Kit (vertical)	DPI 36-42/20	DPI 36-42/20	DPI 48-61/-20	DPI 48-61/-20	DPI 48-61/-20	DPI 48-61/-20	DPI 48-61/-20	DPI 48-61/-20
Insulation Kit (horizontal)	DPIH 36-42	DPIH 36-42	DPIH48-61	DPIH48-61	DPIH48-61	DPIH48-61	DPIH48-61	DPIH48-61

¹ Need 24VAC power supply

² Need 16VDC power supply

³ Fixing box installed beside the unit

* Optional face plates available to provide a more intuitive user interface and disable specific functions

FXTQ Installation Space

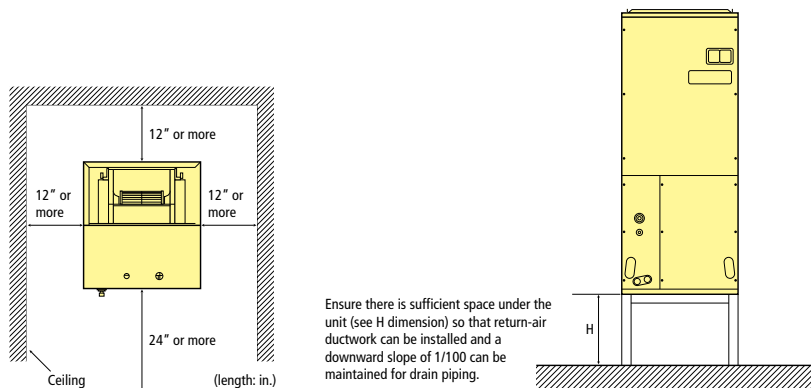

DC Ducted Concealed Ceiling Unit (medium static)

FXMQ_PVJU

Concealed. Quiet. Compact. Comfortable.

For small to large well-populated spaces in need of a concealed air-conditioning system, you can count on our ceiling mounted ducted unit. This extremely powerful unit's compact design allows it to be completely concealed – and it's perfect for offices, restaurants, shops or even hotel ballrooms.



Outside air integration possible



Condensate pump as standard

Auto adjust External Static Pressure

- After installation, it is possible the actual duct resistance is lower than expected at the time of designing. As a consequence, the air flow will be too high.
- With the automatic air flow adjustment function the unit can adapt its fan speed to a lower curve, so the air flow decreases.
- The air flow will always be within 10% of the rated air flow because of the amount of possible fan curves (more than 8 fan curves available per model).
- Alternatively the installer can manually select a fan curve with the wired remote control.

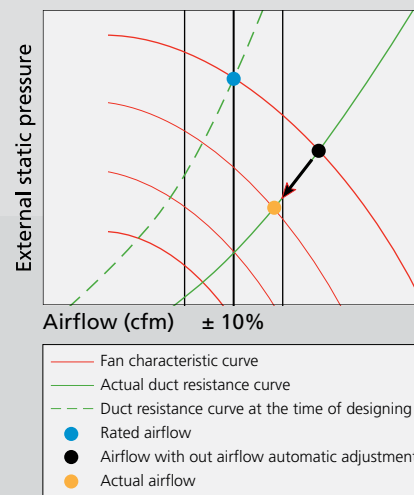

Application

- Hotels/Conference centers
- Multi-family residences
- Single family residences
- Offices
- Retail

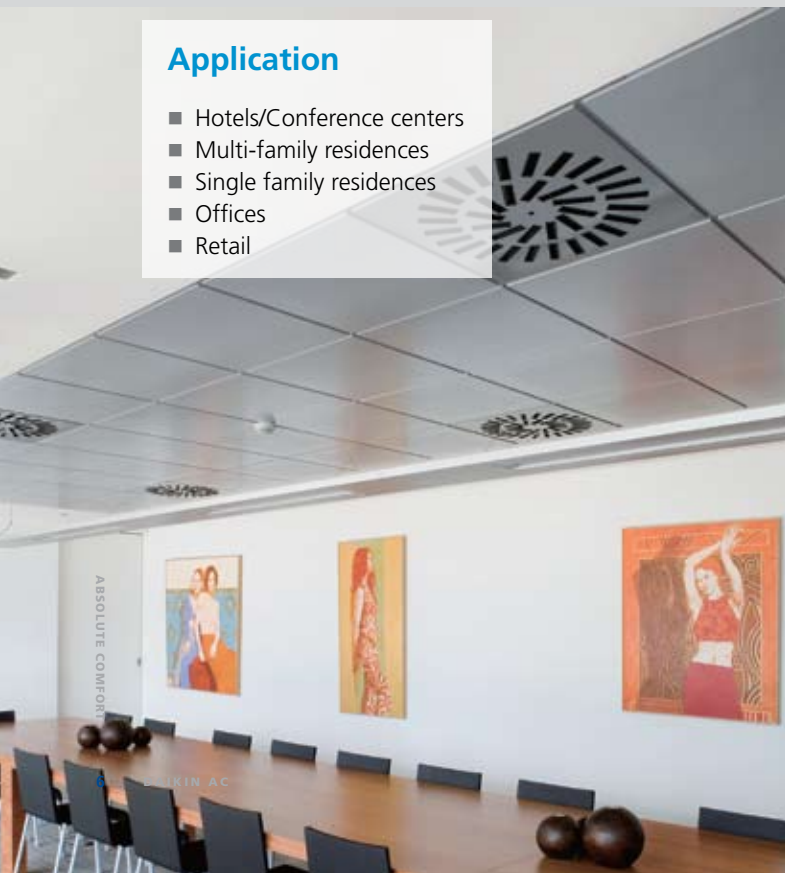

Features and Benefits

- New ducted indoor unit designed to unify the FXSQ and FXMQ range with the best features taken from both units
- Available from 7.5 MBH to 48 MBH
- Improved efficiency with our new DC fan motor
- Auto adjusting airflow at commissioning based on ESP
- Medium ESP capabilities of up to 0.8" W.G.
- Three user selected fan speeds available plus fan "Auto" logic
- Low profile design – less than 12" high
- Built-in condensate pump
- Indoor Air Quality options include filters (MERV 8 and 13) and UV Air Cleaner Module
- Service access from below

FXMQ_P Specifications

FXMQ_P Specifications		0.6-Ton	0.75-Ton	1-Ton	1.5-Ton	2-Ton	2.5-Ton	3-Ton	4-Ton
Model Name		FXMQ07PVJU	FXMQ09PVJU	FXMQ12PVJU	FXMQ18PVJU	FXMQ24PVJU	FXMQ30PVJU	FXMQ36PVJU	FXMQ48PVJU
Power Supply	V/ph/Hz	208-230/1/60							
Cooling Capacity	Btu/h	7,500	9,500	12,000	18,000	24,000	30,000	36,000	48,000
Heating Capacity	Btu/h	8,500	10,500	13,500	20,000	27,000	34,000	40,000	54,000
Refrigerant		R-410A	R-410A	R-410A	R-410A	R-410A	R-410A	R-410A	R-410A
Refrigerant Control		Electronic Expansion Valve							
Airflow Rate HH/H/L	cfm	317/264/229	317/264/229	335/282/246	635/582/529	688/618/565	882/794/706	1,130/953/812	1,377/1,165/988
Unit Weight	lbs.	55	55	55	80	80	80	102	102
Unit Height	in.	11 13/16	11 13/16	11 13/16	11 13/16	11 13/16	11 13/16	11 13/16	11 13/16
Unit Width	in.	21 5/8	21 5/8	21 5/8	39 3/8	39 3/8	39 3/8	55 1/8	55 1/8
Unit Depth	in.	27 9/16	27 9/16	27 9/16	27 9/16	27 9/16	27 9/16	27 9/16	27 9/16
Sound Pressure H/L	dB(A)	33/29	33/29	34/29	41/37	42/38	43/39	43/39	44/40
External Static Pressure (High/Low)	in. W.G.	0.40/0.12	0.40/0.12	0.40/0.12	0.80/0.20	0.80/0.20	0.80/0.20	0.80/0.20	0.80/0.20
Unit Condensate Connection	in. O.D.	1 1/4	1 1/4	1 1/4	1 1/4	1 1/4	1 1/4	1 1/4	1 1/4
Condensate Pump Lift	in.	18 3/8	18 3/8	18 3/8	18 3/8	18 3/8	18 3/8	18 3/8	18 3/8
Pipe Connections	Liquid	in. 1/4 Flare	1/4 Flare	1/4 Flare	1/4 Flare	3/8 Flare	3/8 Flare	3/8 Flare	3/8 Flare
	Gas	in. 1/2 Flare	1/2 Flare	1/2 Flare	1/2 Flare	5/8 Flare	5/8 Flare	5/8 Flare	5/8 Flare
External Finish		Galvanized Steel Plate							
Protection Devices		Fuse Fan Driver Overload Protector							
Recommended Fuse/Breaker	A	15	15	15	15	15	15	15	15

Nominal Conditions:

Cooling Mode
 Indoor: 80 °F DB / 67 °F WB
 Outdoor: 95 °F DB
 Pipe Length: 25 ft.
 Level Difference: 0 ft.

Heating Mode
 Indoor: 70 °F DB
 Outdoor: 47 °F DB / 43 °F WB
 Pipe Length: 25 ft.
 Level Difference: 0 ft.

Note:
 Specifications are subject to change without notice.

FXMQ_P Accessories

Model Name	FXMQ07PVJU	FXMQ09PVJU	FXMQ12PVJU	FXMQ18PVJU	FXMQ24PVJU	FXMQ30PVJU	FXMQ36PVJU	FXMQ48PVJU
Navigation Remote Controller	BRC1E71	BRC1E71	BRC1E71	BRC1E71	BRC1E71	BRC1E71	BRC1E71	BRC1E71
Simplified Wired Remote Controller*	BRC2A71	BRC2A71	BRC2A71	BRC2A71	BRC2A71	BRC2A71	BRC2A71	BRC2A71
Wireless Remote Controller	BRC4C82	BRC4C82	BRC4C82	BRC4C82	BRC4C82	BRC4C82	BRC4C82	BRC4C82
Remote Sensor Kit	KRCS01-4B	KRCS01-4B	KRCS01-4B	KRCS01-4B	KRCS01-4B	KRCS01-4B	KRCS01-4B	KRCS01-4B
Wiring Adaptor PCB (interface with aux/primary heater, humidifier, OA damper/fan)	KRP1B71	KRP1B71	KRP1B71	KRP1B71	KRP1B71	KRP1B71	KRP1B71	KRP1B71
Group Control Adaptor PCB (connects to external BMS)	KRP4A71	KRP4A71	KRP4A71	KRP4A71	KRP4A71	KRP4A71	KRP4A71	KRP4A71

* Optional face plates available to provide a more intuitive user interface and disable specific functions

FXMQ_P Installation Space

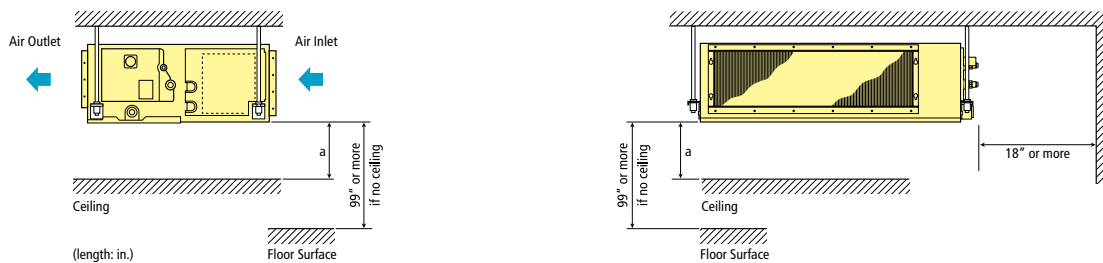

Concealed Ceiling Unit (medium static)

FXMQ_MVJU

Concealed. Slim design. Strong. Comfortable.

The new FXMQ_MVJU ducted fan coil unit is ideal for larger open space floor plans usually found in offices, retails, hotels or education facilities. It is a perfect addition to Daikin's line up of ducted units that performs well across multiple spaces that can benefit from the same mode of operation, limiting equipment and installation cost.



Outside air integration possible



Features and Benefits

- Greater design flexibility with a capacity range extended to 96 MBH
- Improved ductwork and filtration flexibility with high CFM and ESP capabilities of up to 1.1" W.G.
- Low profile design of less than 19" high to reduce required installation space
- Built-in condensate float switch (condensate pump is not included)

Application

- Hotel/Conference centers
- Schools
- Retail/Shopping centers
- Large open plan offices
- Churches



FXMQ_M Specifications

FXMQ_M Specifications		6-Ton	8-Ton
Model Name		FXMQ72MVJU	FXMQ96MVJU
Power Supply	V/ph/Hz	208-230/1/60	
Cooling Capacity	Btu/h	72,000	96,000
Heating Capacity	Btu/h	81,000	108,000
Refrigerant		R-410A	R-410A
Refrigerant Control		Electronic Expansion Valve	
Airflow Rate H/L	cfm	2,047 / 1,764	2,541 / 2,188
Unit Weight	lbs.	302	302
Unit Height	in.	18 1/8	18 1/8
Unit Width	in.	54 3/8	54 3/8
Unit Depth	in.	43 5/16	43 5/16
Sound Pressure H/L	dB(A)	48/45	48/45
External Static Pressure (Nominal/Maximum)	in. W.G.	0.38/0.95	0.43/0.95
Unit Condensate Connection	in. O.D.	1	1
Pipe Connections	Liquid	in.	3/8 Flare
	Gas	in.	3/4 Flare
External Finish		Galvanized Steel Plate	
Protection Devices		Fuse	
		Fan Motor Thermal Protector	
Recommended Fuse/Breaker	A	15	15

Nominal Conditions:

Cooling Mode

Indoor: 80 °F DB / 67 °F WB
 Outdoor: 95 °F DB
 Pipe Length: 25 ft.
 Level Difference: 0 ft.

Heating Mode

Indoor: 70 °F DB
 Outdoor: 47 °F DB / 43 °F WB
 Pipe Length: 25 ft.
 Level Difference: 0 ft.

Note:

Specifications are subject to change without notice.



FXMQ_M Accessories

Model Name	FXMQ72MVJU	FXMQ96MVJU
Navigation Remote Controller	BRC1E71	BRC1E71
Simplified Wired Remote Controller*	BRC2A71	BRC2A71
Wireless Remote Controller	BRC4C82	BRC4C82
Remote Sensor Kit	KRCS01-1B	KRCS01-1B
Wiring Adaptor PCB (interface with aux/primary heater, humidifier, OA damper/fan)	KRP1B71	KRP1B71
Group Control Adaptor PCB (connects to external BMS)	KRP4A71	KRP4A71
High Efficiency Filter Kit (MERV 13)	DACA-MQ96M-13-1K	DACA-MQ96M-13-1K
High Efficiency Filter Kit (MERV 8)	DACA-MQ96M-8-1K	DACA-MQ96M-8-1K

* Optional face plates available to provide a more intuitive user interface and disable specific functions

FXMQ_M Installation Space

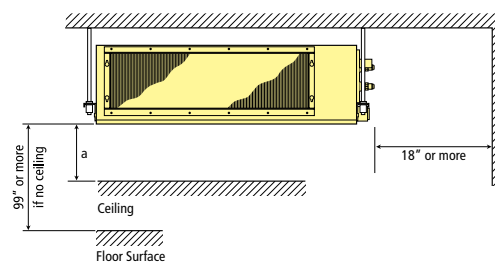
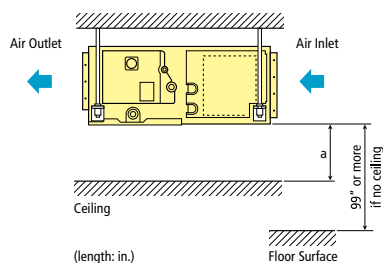

Slim Duct Built-In Concealed Ceiling Unit

FXDQ_MVJU

Concealed. Slim. Quiet. Comfortable

The slim duct built-in concealed unit is available for use with the VRV systems to complement the existing concealed ceiling unit options (FXMQ). With its low profile and low sound level this unit can be installed into limited ceiling void, bulkhead or soffit space.



Condensate pump as standard



Outside air integration possible



Filter included

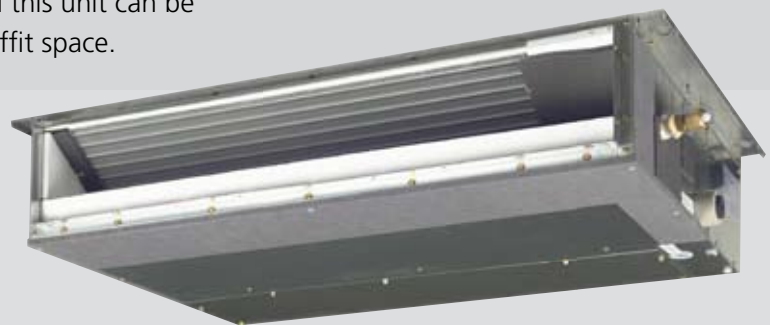

Application

- Hotel rooms
- Multi-family residences
- Single family residences
- School dormitories
- Retail

Features and Benefits

- Slim height, at only 7 7/8", makes it suitable for most of the applications where attic / bulkhead space is limited
- With a sound level as low as 29 dB(A) for the 7.5, 9 or 12 MBH indoor unit, these units are among the quietest on the market
- Factory set rear suction; bottom suction is possible to reverse
- Washable filter included
- Condensate pump with vertical lift of up to 21 5/8" included as standard
- Blends unobtrusively with any interior decor; only the suction and discharge grills are visible
- Medium static pressure facilitates unit use with flexible ducts of varying length



FXDQ Specifications

FXDQ Specifications		0.6-Ton	0.75-Ton	1-Ton	1.5-Ton	2-Ton
Model Name		FXDQ07MVJU	FXDQ09MVJU	FXDQ12MVJU	FXDQ18MVJU	FXDQ24MVJU
Power Supply	V/ph/Hz	208-230/1/60				
Cooling Capacity	Btu/h	7,500	9,500	12,000	18,000	24,000
Heating Capacity	Btu/h	8,500	10,500	13,500	20,000	27,000
Refrigerant		R-410A	R-410A	R-410A	R-410A	R-410A
Refrigerant Control		Electronic Expansion Valve				
Airflow Rate H/L	cfm	280/226	280/226	280/226	440/350	580/460
Unit Weight	lbs.	51	51	51	63	71
Unit Height	in.	7 7/8	7 7/8	7 7/8	7 7/8	7 7/8
Unit Width	in.	27 9/16	27 9/16	27 9/16	35 7/16	43 5/16
Unit Depth	in.	24 7/16	24 7/16	24 7/16	24 7/16	24 7/16
Sound Pressure H/L	dB(A)	33/29	33/29	33/29	35/31	36/32
External Static Pressure (High/Low)	in. W.G.	0.12/0.04	0.12/0.04	0.12/0.04	0.17/0.06	0.17/0.06
Unit Condensate Connection	in. O.D.	1 1/32	1 1/32	1 1/32	1 1/32	1 1/32
Condensate Pump Lift	in.	21 5/8	21 5/8	21 5/8	21 5/8	21 5/8
Pipe Connections	Liquid	in.	1/4 Flare	1/4 Flare	1/4 Flare	3/8 Flare
	Gas	in.	1/2 Flare	1/2 Flare	1/2 Flare	5/8 Flare
External Finish		Galvanized Steel Plate				
Protection Devices		Fuse				
		Fan Motor Thermal Protector				
Recommended Fuse/Breaker	A	15	15	15	15	15
Standard Filter Type		Removable, Washable, Mildew Proof				

Nominal Conditions:

Cooling Mode

Indoor: 80 °F DB / 67 °F WB
 Outdoor: 95 °F DB
 Pipe Length: 25 ft.
 Level Difference: 0 ft.

Heating Mode

Indoor: 70 °F DB
 Outdoor: 47 °F DB / 43 °F WB
 Pipe Length: 25 ft.
 Level Difference: 0 ft.

Note:

Specifications are subject to change without notice.

FXDQ Accessories

Model Name	FXDQ07MVJU	FXDQ09MVJU	FXDQ12MVJU	FXDQ18MVJU	FXDQ24MVJU
Navigation Remote Controller	BRC1E71	BRC1E71	BRC1E71	BRC1E71	BRC1E71
Simplified Wired Remote Controller*	BRC2A71	BRC2A71	BRC2A71	BRC2A71	BRC2A71
Wireless Remote Controller	BRC4C82	BRC4C82	BRC4C82	BRC4C82	BRC4C82
Remote Sensor Kit	KRCS01-1B	KRCS01-1B	KRCS01-1B	KRCS01-1B	KRCS01-1B
Wiring Adaptor PCB (interface with aux/primary heater, humidifier, OA damper/fan)	KRP1B71-D	KRP1B71-D	KRP1B71-D	KRP1B71-D	KRP1B71-D
Group Control Adaptor PCB (connects to external BMS)	KRP4A74	KRP4A74	KRP4A74	KRP4A74	KRP4A74
Access Panel (single door)	APFXDQ070912	APFXDQ070912	APFXDQ070912	APFXDQ18	APFXDQ24
Access Panel with return air filter (single door)	APRFXDQ070912	APRFXDQ070912	APRFXDQ070912	APRFXDQ18	APRFXDQ24
Filter Media Replacement	APRFXDQ070912F	APRFXDQ070912F	APRFXDQ070912F	APRFXDQ18F	APRFXDQ24F

* Optional face plates available to provide a more intuitive user interface and disable specific functions

FXDQ Installation Space

Choose an installation site that ensures both optimum air distribution and sufficient clearance for maintenance.

The return air inlet can be easily changed from rear to bottom using the same chamber lid.

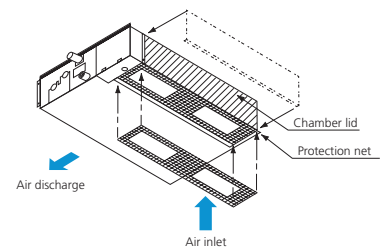
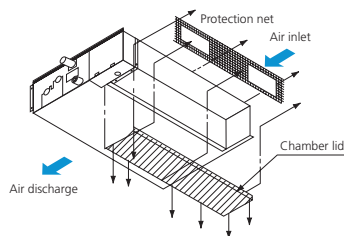
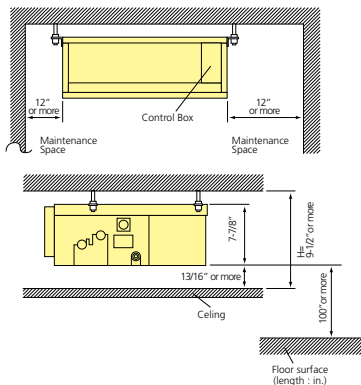

Round Flow Ceiling-Mounted Cassette

FXFQ_PVJU

For use with:

VRV III VRV-WIII VRV-III-S

Quiet. Elegant. Customizable. Low-maintenance. Comfortable.

The Round Flow cassette is ideal for open plan applications such as classrooms and offices where variances in temperature and airflow can cause discomfort. With 23 configurable airflow distribution patterns, it can also be effective in smaller, more intricate spaces too.



Condensate pump as standard



Outside air integration possible



Filter included



Features and Benefits

- 360° airflow to reduce drafts and improve comfort
- Models range from 9 MBH to 48 MBH
- Improved flexibility with 23 different possible airflow patterns, ensuring ideal air distribution to maximize comfort and savings
- Lower air velocities for better room airflow distribution
- Reduced unit weight and improved efficiency with a light weight fan
- Stain resistant and easily cleanable decoration panel coating
- Silver ion antibacterial drain pan treatment
- 3 user selectable fan speeds (HH, H and L)

Airflow directions

For air discharge in 2 or 3 directions, it is necessary to make field settings by remote controller and to close the air outlet(s). Refer to the section FIELD SETTING in the installation manual of the optional blocking pad kit.

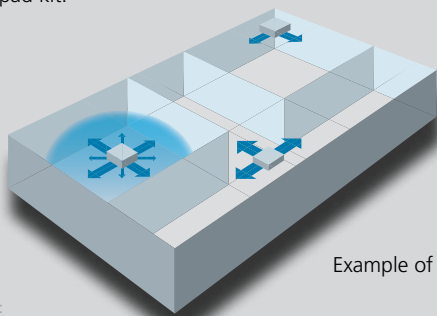

Example of airflow patterns

Application

- Retail
- Schools
- Offices
- Restaurants



FXFQ Specifications

FXFQ Specifications		0.75-Ton	1-Ton	1.5-Ton	2-Ton	2.5-Ton	3-Ton	4-Ton
Model Name		FXFQ09PVJU	FXFQ12PVJU	FXFQ18PVJU	FXFQ24PVJU	FXFQ30PVJU	FXFQ36PVJU	FXFQ48PVJU
Power Supply	V/ph/Hz	208-230/1/60						
Rated Cooling Capacity	Btu/h	9,500	12,000	18,000	24,000	30,000	36,000	48,000
Rated Heating Capacity	Btu/h	10,500	13,500	20,000	27,000	34,000	40,000	54,000
Refrigerant		R-410A						
Refrigerant Control		Electronic Expansion Valve						
Airflow Rate HH/H/L	cfm	460/390/350	460/390/350	560/470/390	780/620/470	830/670/530	1,180/910/700	1,220/970/790
Unit Weight	lbs.	43	43	43	48.5	48.5	55	55
Unit Height	in.	9 11/16	9 11/16	9 11/16	9 11/16	9 11/16	11 5/16	11 5/16
Unit Width	in.	33 1/16	33 1/16	33 1/16	33 1/16	33 1/16	33 1/16	33 1/16
Unit Depth	in.	33 1/16	33 1/16	33 1/16	33 1/16	33 1/16	33 1/16	33 1/16
Sound Pressure HH/H/L	dB(A)	30/28/27	30/28/27	32/30/27	36/32/28	38/35/31	44/38/32	45/40/34
Unit Condensate Connection	in. O.D.	1 1/4	1 1/4	1 1/4	1 1/4	1 1/4	1 1/4	1 1/4
Condensate Pump Lift	in.	33 1/2	33 1/2	33 1/2	33 1/2	33 1/2	33 1/2	33 1/2
Pipe Connections	Gas	in. 1/4 (Flare)	1/4 (Flare)	1/4 (Flare)	3/8 (Flare)	3/8 (Flare)	3/8 (Flare)	3/8 (Flare)
	Liquid	in. 1/2 (Flare)	1/2 (Flare)	1/2 (Flare)	5/8(Flare)	5/8(Flare)	5/8(Flare)	5/8(Flare)
External Finish		Galvanized Steel Plate						
Protection Devices		Fuse/Breaker						
		Fan Motor Thermal Protector						
Recommended Fuse/Breaker	A	15	15	15	15	15	15	15
Standard Filter Type		Mold Resistant Resin Net						

Nominal Conditions:

Cooling Mode
 Indoor: 80 °F DB / 67 °F WB
 Outdoor: 95 °F DB
 Pipe Length: 25 ft.
 Level Difference: 0 ft.

Heating Mode
 Indoor: 70 °F DB
 Outdoor: 47 °F DB / 43 °F WB
 Pipe Length: 25 ft.
 Level Difference: 0 ft.

Note:
 Specifications are subject to change without notice.

FXFQ Accessories

Model Name	FXFQ09PVJU	FXFQ12PVJU	FXFQ18PVJU	FXFQ24PVJU	FXFQ30PVJU	FXFQ36PVJU	FXFQ48PVJU
Navigation Remote Controller	BRC1E71	BRC1E71	BRC1E71	BRC1E71	BRC1E71	BRC1E71	BRC1E71
Simplified Wired Remote Controller*	BRC2A71	BRC2A71	BRC2A71	BRC2A71	BRC2A71	BRC2A71	BRC2A71
Wireless Remote Controller	BRC7F812	BRC7F812	BRC7F812	BRC7F812	BRC7F812	BRC7F812	BRC7F812
Remote Sensor Kit	KRCS01-4B	KRCS01-4B	KRCS01-4B	KRCS01-4B	KRCS01-4B	KRCS01-4B	KRCS01-4B
Decoration Panel	BYCP125K-W1	BYCP125K-W1	BYCP125K-W1	BYCP125K-W1	BYCP125K-W1	BYCP125K-W1	BYCP125K-W1
Wiring Adaptor PCB (interface with aux/primary heater, humidifier, OA damper/fan)	KRP1C75	KRP1C75	KRP1C75	KRP1C75	KRP1C75	KRP1C75	KRP1C75
Group Control Adaptor PCB (connects to external BMS)	KRP4A74	KRP4A74	KRP4A74	KRP4A74	KRP4A74	KRP4A74	KRP4A74
Long-Life Replacement Filter	KAFP551K160	KAFP551K160	KAFP551K160	KAFP551K160	KAFP551K160	KAFP551K160	KAFP551K160
Panel Spacer	KDBP55H160FA	KDBP55H160FA	KDBP55H160FA	KDBP55H160FA	KDBP55H160FA	KDBP55H160FA	KDBP55H160FA
Fresh Air Intake Kit with T pipe	KDDP55B160K	KDDP55B160K	KDDP55B160K	KDDP55B160K	KDDP55B160K	KDDP55B160K	KDDP55B160K
Fresh Air Intake Kit without T pipe	KDDP55B160	KDDP55B160	KDDP55B160	KDDP55B160	KDDP55B160	KDDP55B160	KDDP55B160

* Optional face plates available to provide a more intuitive user interface and disable specific functions

FXFQ Installation Space

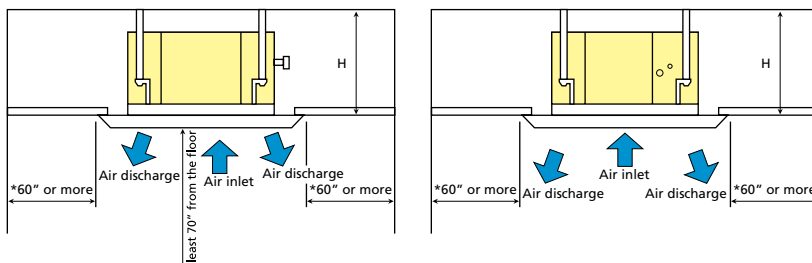

Model	H
FXFQ09 • 12 • 18 • 24 • 30PVJU	10"
FXFQ36 • 48PVJU	11 3/4" or more

2' x 2' 4-way Ceiling-mounted cassette

FXZQ_M7VJU

Soft. Elegant. Customizable. Low-maintenance. Comfortable.

From corner stores to offices and classrooms, our elegant ceiling-mounted cassette units provide low-noise, customizable comfort. Airflow can be sent in any of four directions, and the ability to shut down one or two sides allows for easy corner installation. For easier installation, units fit in a standard 2' x 2' ceiling grid.



Condensate pump as standard



Outside air integration possible



Filter included

Application

- Retail
- Schools
- Offices



Features and Benefits

- Sound pressure levels are as low as 29 dB(A)
- Space-saving depth of units requires only 11.6" of ceiling space
- Three auto-swing positions to choose from – standard, draft prevention and ceiling stain prevention
- Simple installation with an easy-to-fit decoration panel, easy height adjustment and a suction grille that can rotate up to 90°
- Easy-to-clean grille, washable long-life filter and optional high efficiency filters
- Trouble-free condensate pump inside the unit
- Models range from 7.5 MBH to 18 MBH

Airflow directions

For air discharge in 2 or 3 directions, it is necessary to make field settings by remote controller and to close the air outlet(s). Refer to the section FIELD SETTING in the installation manual of the optional blocking pad kit.

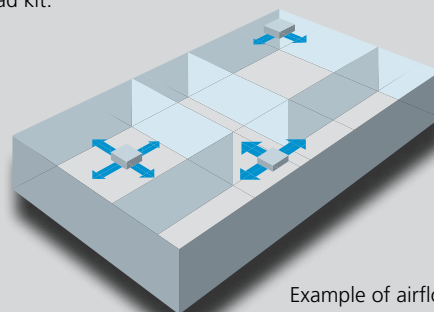

Example of airflow patterns

FXZQ Specifications

FXZQ Specifications		0.6-Ton	0.75-Ton	1-Ton	1.5-Ton
Model Name		FXZQ07M7VJU	FXZQ09M7VJU	FXZQ12M7VJU	FXZQ18M7VJU
Power Supply	V/ph/Hz	208-230/1/60			
Cooling Capacity	Btu/h	7,500	9,500	12,000	18,000
Heating Capacity	Btu/h	8,700	11,100	14,000	21,000
Refrigerant		R-410A	R-410A	R-410A	R-410A
Refrigerant Control		Electronic Expansion Valve			
Airflow Rate H/L	cfm	320/247	335/265	495/353	495/353
Unit Weight	lbs.	42	42	42	42
Unit Height	in.	11 1/4	11 1/4	11 1/4	11 1/4
Unit Width	in.	22 5/8	22 5/8	22 5/8	22 5/8
Unit Depth	in.	22 5/8	22 5/8	22 5/8	22 5/8
Sound Pressure H/L	dB(A)	31/29	33/29	41/34	41/34
Unit Condensate Connection	in. O.D.	1 1/32	1 1/32	1 1/32	1 1/32
Condensate Pump Lift	in.	21 1/2	21 1/2	21 1/2	21 1/2
Pipe Connections	Liquid	in.	1/4 Flare	1/4 Flare	1/4 Flare
	Gas	in.	1/2 Flare	1/2 Flare	1/2 Flare
External Finish		Galvanized Steel Plate			
Protection Devices		Fuse			
		Fan Motor Thermal Protector			
Recommended Fuse/Breaker	A	15	15	15	15
Standard Filter Type		Resin Net (with Mold Resistant)			

Nominal Conditions:

Cooling Mode
Indoor: 80 °F DB / 67 °F WB
Outdoor: 95 °F DB
Pipe Length: 25 ft.
Level Difference: 0 ft.

Heating Mode
Indoor: 70 °F DB
Outdoor: 47 °F DB / 43 °F WB
Pipe Length: 25 ft.
Level Difference: 0 ft.

Note:
Specifications are subject to change without notice.

FXZQ Accessories

Model Name	FXZQ07M7VJU	FXZQ09M7VJU	FXZQ12M7VJU	FXZQ18M7VJU
Navigation Remote Controller	BRC1E71	BRC1E71	BRC1E71	BRC1E71
Simplified Wired Remote Controller*	BRC2A71	BRC2A71	BRC2A71	BRC2A71
Remote Sensor Kit	KRCS01-1B	KRCS01-1B	KRCS01-1B	KRCS01-1B
Decoration Panel	BYFQ60BU	BYFQ60BU	BYFQ60BU	BYFQ60BU
Wiring Adaptor PCB (interface with aux/primary heater, humidifier, OA damper/fan)	KRP1B72	KRP1B72	KRP1B72	KRP1B72
Long-Life Replacement Filter	KAFQ441B60	KAFQ441B60	KAFQ441B60	KAFQ441B60
Sealing Member of Air Discharge Outlet	KDBHQ44B60	KDBHQ44B60	KDBHQ44B60	KDBHQ44B60
Panel Spacer	KDBQ44B60	KDBQ44B60	KDBQ44B60	KDBQ44B60
Fresh Air Intake Kit	KDDQ44XA60	KDDQ44XA60	KDDQ44XA60	KDDQ44XA60

* Optional face plates available to provide a more intuitive user interface and disable specific functions

FXZQ Installation Space

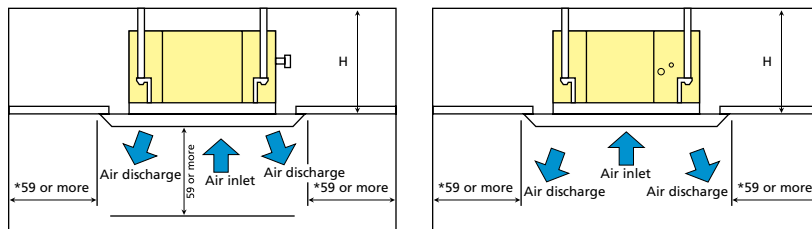

Model	H
FXZQ07-18M7VJU	11.6 or more (length: in.)

(NOTE) Leave 7 7/8 or more space where marked with the *, on sides where the air outlet is closed.

Wall-mounted Unit

FXAQ_MVJU

Stylish. Compact. Convenient. Comfortable.

Our wall-mounted units are ideal for cooling or heating smaller zones such as hotel rooms, stores, small offices and restaurants. The compact, stylish design lets the unit blend discreetly into any interior design, and airflow can be sent in any of five different directions and programmed via remote control.



Filter included



Features and Benefits

- Auto-swing mechanism ensures efficient air distribution via louvers that automatically close when the unit is turned off
- Wide air discharge outlet distributes a comfortable airflow throughout the entire space
- Horizontal louvers and front panel can be easily removed for cleaning
- Drain pipe can be easily hidden from sight
- Models range from 7.5 MBH to 24 MBH

Application

- Retail
- Restaurants
- Offices
- Hotels
- Multi-family residences



FXAQ Specifications

FXAQ Specifications		0.6-Ton	0.75-Ton	1-Ton	1.5-Ton	2-Ton
Model Name		FXAQ07MVJU	FXAQ09MVJU	FXAQ12MVJU	FXAQ18MVJU	FXAQ24MVJU
Power Supply	V/ph/Hz	208-230/1/60				
Cooling Capacity	Btu/h	7,500	9,500	12,000	18,000	24,000
Heating Capacity	Btu/h	8,500	10,500	13,500	20,000	27,000
Refrigerant		R-410A	R-410A	R-410A	R-410A	R-410A
Refrigerant Control		Electronic Expansion Valve				
Airflow Rate H/L	cfm	260/160	280/175	300/180	500/400	635/470
Unit Weight	lbs.	25	25	25	31	31
Unit Height	in.	11 3/8	11 3/8	11 3/8	11 3/8	11 3/8
Unit Width	in.	31 1/4	31 1/4	31 1/4	41 3/8	41 3/8
Unit Depth	in.	9	9	9	9	9
Sound Pressure H/L	dB(A)	36/31	37/31	38/31	43/37	47/40
Unit Condensate Connection	in. O.D.	11/16	11/16	11/16	11/16	11/16
Pipe Connections	Liquid	in.	1/4	1/4	1/4	3/8
	Gas	in.	1/2	1/2	1/2	5/8
External Finish		White Casing				
Protection Devices		Fuse				
		Fan Motor Thermal Protector				
Recommended Fuse/Breaker	A	15	15	15	15	15
Standard Filter Type		Resin Net (washable)				

Nominal Conditions:

Cooling Mode

Indoor: 80 °F DB / 67 °F WB
 Outdoor: 95 °F DB
 Pipe Length: 25 ft.
 Level Difference: 0 ft.

Heating Mode

Indoor: 70 °F DB
 Outdoor: 47 °F DB / 43 °F WB
 Pipe Length: 25 ft.
 Level Difference: 0 ft.

Note:

Specifications are subject to change without notice.

FXAQ Accessories

Model Name	FXAQ07MVJU	FXAQ09MVJU	FXAQ12MVJU	FXAQ18MVJU	FXAQ24MVJU
Navigation Remote Controller	BRC1E71	BRC1E71	BRC1E71	BRC1E71	BRC1E71
Simplified Wired Remote Controller*	BRC2A71	BRC2A71	BRC2A71	BRC2A71	BRC2A71
Wireless Remote Controller	BRC7E818	BRC7E818	BRC7E818	BRC7E818	BRC7E818
Remote Sensor Kit	KRCS01-1B	KRCS01-1B	KRCS01-1B	KRCS01-1B	KRCS01-1B
Group Control Adaptor PCB (connects to external BMS)	KRP4A71	KRP4A71	KRP4A71	KRP4A71	KRP4A71
Condensate Pump	DACA-CP1-1	DACA-CP1-1	DACA-CP1-1	DACA-CP1-1	DACA-CP1-1

* Optional face plates available to provide a more intuitive user interface and disable specific functions

FXAQ Installation Space

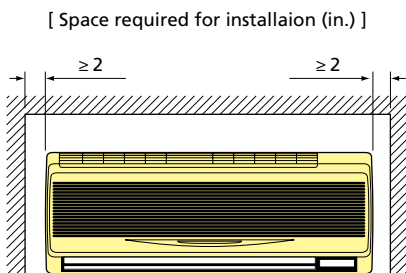

Fig.1

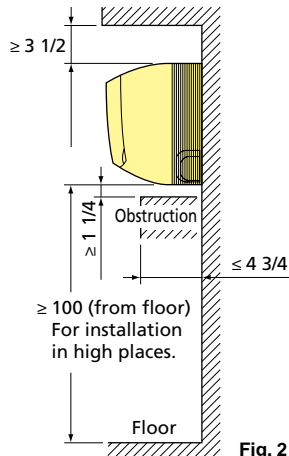

Fig. 2

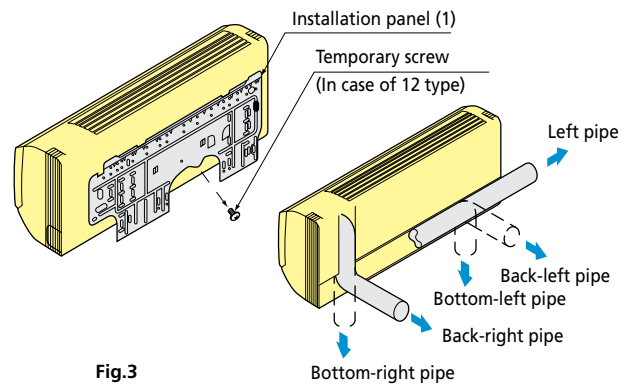

Fig.3

Ceiling Suspended Unit

FXHQ_MVJU

Slim. Efficient. Quiet. Easy to Maintain.

With its slim, elegant design, the FXHQ ceiling-suspended unit is a great fit for any light commercial space. Wide air openings provide a comfortable airflow and an innovative stream fan ensures quiet operation, making it ideal for retail stores, restaurants, classrooms and conference rooms.



Filter included



Application

- Retail/Shops
- Offices
- Restaurants

Features and Benefits

- One of our slimmest indoor units (less than 8") fits within any interior design
- Wide air discharge outlet distributes a comfortable airflow throughout the entire space
- Innovative stream fan technology keeps sound pressure levels low
- Installation is fast and optional drain-up kit can be added easily
- Bristle-free, non-dew flap and flat design make cleaning simple
- Long-life filter (maintenance-free for up to one year) is standard
- Models range from 12 MBH to 36 MBH

FXHQ Specifications

FXHQ Specifications		1-Ton	2-Ton	3-Ton
Model Name		FXHQ12MVJU	FXHQ24MVJU	FXHQ36MVJU
Power Supply	V/ph/Hz	208-230/1/60		
Cooling Capacity	Btu/h	12,000	24,000	36,000
Heating Capacity	Btu/h	13,500	27,000	40,000
Refrigerant		R-410A	R-410A	R-410A
Refrigerant Control		Electronic Expansion Valve		
Airflow Rate H/L	cfm	410/340	710/600	830/670
Unit Weight	lbs.	55	80	90
Unit Height	in.	7 11/16	7 11/16	7 11/16
Unit Width	in.	37 13/16	55 1/8	62 5/8
Unit Depth	in.	26 3/4	26 3/4	26 3/4
Sound Pressure H/L	dB(A)	42/33	44/36	46/41
Unit Condensate Connection	in. O.D.	1	1	1
Pipe Connections	Liquid	in.	1/4	3/8
	Gas	in.	1/2	5/8
External Finish		White Casing		
Protection Devices		Fuse		
		Fan Motor Thermal Protector		
Recommended Fuse/Breaker	A	15	15	15
Standard Filter Type		Resin Net (with Mold Resistant)		

Nominal Conditions:

Cooling Mode

Indoor: 80 °F DB / 67 °F WB
 Outdoor: 95 °F DB
 Pipe Length: 25 ft.
 Level Difference: 0 ft.

Heating Mode

Indoor: 70 °F DB
 Outdoor: 47 °F DB / 43 °F WB
 Pipe Length: 25 ft.
 Level Difference: 0 ft.

Note:

Specifications are subject to change without notice.

FXHQ Accessories				
Model Name	FXHQ12MVJU	FXHQ24MVJU	FXHQ36MVJU	
Navigation Remote Controller	BRC1E71	BRC1E71	BRC1E71	
Simplified Wired Remote Controller*	BRC2A71	BRC2A71	BRC2A71	
Wireless Remote Controller	BRC7E83	BRC7E83	BRC7E83	
Remote Sensor Kit	KRCS01-1B	KRCS01-1B	KRCS01-1B	
Wiring Adaptor PCB (interface with aux/primary heater, humidifier, OA damper/fan)	KRP1B71	KRP1B71	KRP1B71	
Group Control Adaptor PCB (connects to external BMS)	KRP4A72	KRP4A72	KRP4A72	
Replacement long-life filter	KAFJ501D56	KAFJ501D112	KAFJ501D160	
L-type piping kit	KHFP5M35	KHFP5M63	KHFP5M160	

* Optional face plates available to provide a more intuitive user interface and disable specific functions

FXHQ Installation Space

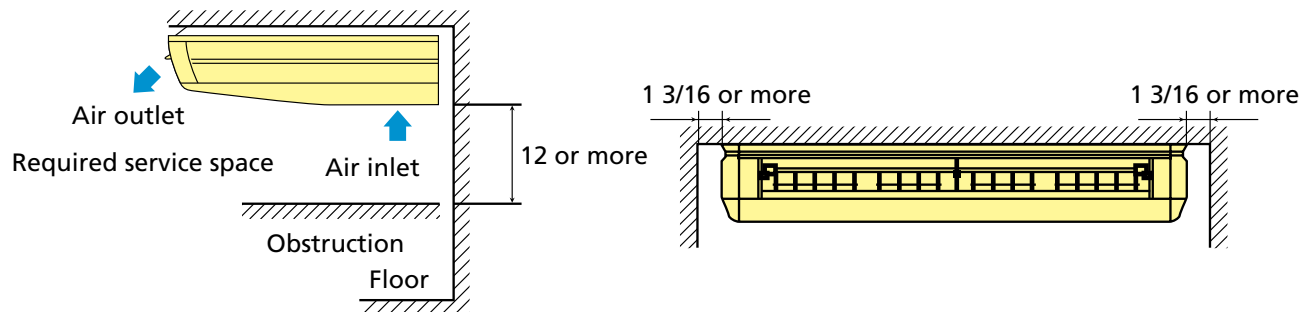

Floor-Standing Units

FXLQ_MVJU/FXNQ_MVJU

Versatile. Logical. Durable. Quiet.

The ideal way to save space, our floor-standing units can easily be installed along a perimeter wall – or concealed. The air distribution from these models will allow you to find the right balance for classrooms, hospital rooms, office hallways or similar spaces.



Outside air integration possible (FXNQ)



Filter included



FXLQ



FXNQ

Features and Benefits

- Ideal for installation beneath a window
- Unit requires minimal installation space
- Fitted with a washable long-life filter
- Remote-control options available
- Space-saving unit can be freestanding or wall-mounted, concealed or exposed
- Models range from 12 MBH to 24 MBH

Application

- Multi-family residences
- Single family residences
- Churches
- Historic buildings
- Schools
- Offices

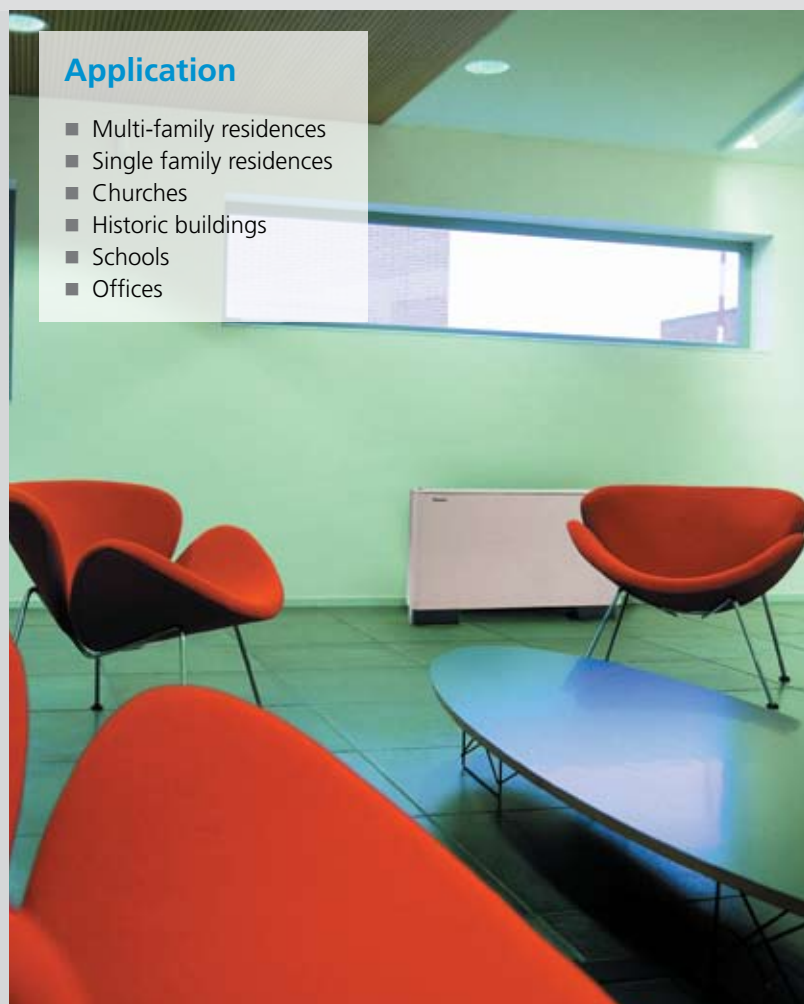

FXLQ/FXNQ Specifications

FXLQ/FXNQ Specifications		Exposed			Concealed		
		1-Ton	1.5-Ton	2-Ton	1-Ton	1.5-Ton	2-Ton
Model Name		FXLQ12MVJU	FXLQ18MVJU	FXLQ24MVJU	FXNQ12MVJU	FXNQ18MVJU	FXNQ24MVJU
Power Supply	V/ph/Hz	208-230/1/60			208-230/1/60		
Cooling Capacity	Btu/h	12,000	18,000	24,000	12,000	18,000	24,000
Heating Capacity	Btu/h	13,500	20,000	27,000	13,500	20,000	27,000
Refrigerant		R-410A	R-410A	R-410A	R-410A	R-410A	R-410A
Refrigerant Control		Electronic Expansion Valve			Electronic Expansion Valve		
Airflow Rate H/L	cfm	280/210	490/380	560/420	280/210	490/380	560/420
Unit Weight	lbs.	66	80	80	51	60	60
Unit Height	in.	23 5/8	23 5/8	23 5/8	24	24	24
Unit Width	in.	44 7/8	55 7/8	55 7/8	42 1/8	53 1/8	53 1/8
Unit Depth	in.	8 3/4	8 3/4	8 3/4	8 5/8	8 5/8	8 5/8
Sound Pressure H/L	dB(A)	36/33	40/35	41/36	36/33	40/35	41/36
Unit Condensate Connection	in. O.D.	27/32	27/32	27/32	27/32	27/32	27/32
Pipe Connections	Liquid	in.	1/4	1/4	3/8	1/4	3/8
	Gas	in.	1/2	1/2	5/8	1/2	5/8
External Finish		Ivory White Casing			Galvanized Steel Plate		
Protection Devices		Fuse			Fuse		
		Fan Motor Thermal Protector			Fan Motor Thermal Protector		
Recommended Fuse/Breaker	A	15	15	15	15	15	15
Standard Filter Type		Resin Net (with Mold Resistant)			Resin Net (with Mold Resistant)		

Nominal Conditions:

Cooling Mode

Indoor: 80 °F DB / 67 °F WB
 Outdoor: 95 °F DB
 Pipe Length: 25 ft.
 Level Difference: 0 ft.

Heating Mode

Indoor: 70 °F DB
 Outdoor: 47 °F DB / 43 °F WB
 Pipe Length: 25 ft.
 Level Difference: 0 ft.

Note:

Specifications are subject to change without notice.

FXLQ/FXNQ Accessories

Model Name	FXLQ12MVJU	FXLQ18MVJU	FXLQ24MVJU	FXNQ12MVJU	FXNQ18MVJU	FXNQ24MVJU
Navigation Remote Controller	BRC1E71	BRC1E71	BRC1E71	BRC1E71	BRC1E71	BRC1E71
Simplified Wired Remote Controller*	BRC2A71	BRC2A71	BRC2A71	BRC2A71	BRC2A71	BRC2A71
Wireless Remote Controller	BRC4C82	BRC4C82	BRC4C82	BRC4C82	BRC4C82	BRC4C82
Remote Sensor Kit	KRCS01-1B	KRCS01-1B	KRCS01-1B	KRCS01-1B	KRCS01-1B	KRCS01-1B
Wiring Adaptor PCB (interface with aux/primary heater, humidifier, OA damper/fan)	KRP1B71	KRP1B71	KRP1B71	KRP1B71	KRP1B71	KRP1B71
Group Control Adaptor PCB (connects to external BMS)	KRP4A71	KRP4A71	KRP4A71	KRP4A71	KRP4A71	KRP4A71

* Optional face plates available to provide a more intuitive user interface and disable specific functions

FXLQ/FXNQ Installation Space

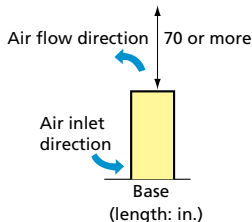
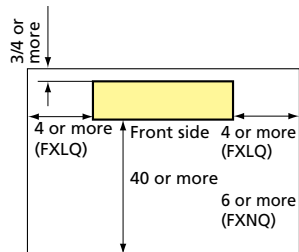
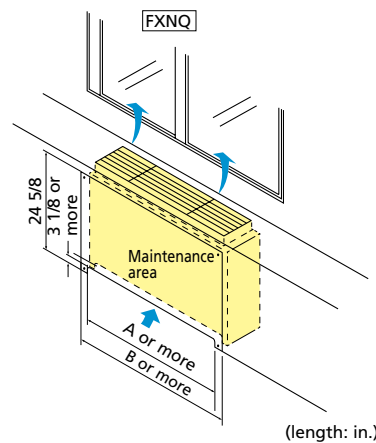
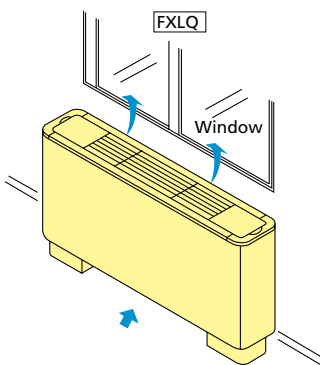

(IMPORTANT) Leave sufficient clearance for air inlet and maintenance.

Model	A (in.)	B (in.)
FXNQ12MVJU	28	46
FXNQ18 · 24MVJU	39	57

100% Outside Air Processing Unit

FXMQ_MFVJU

Concealed. Powerful. Compact. Quiet. Fresh Air Quality.

Both fresh air treatment and heating and cooling can be achieved successfully in a single system via heat pump technology without the usual design problems associated with balancing air supply and discharge. Fan coil units and outdoor air processing unit can be connected to the same refrigerant line, resulting in enhanced design flexibility and a significant reduction in total system costs.



Operational Characteristics

When the suction air temperature is between 66°F and 109°F the Outside Air Processing Unit operates in cooling, and when between 23°F and 59°F, it operates in heating. The OA processing unit will work in energy saving fan only between 59°F and 66°F; this is not configurable.

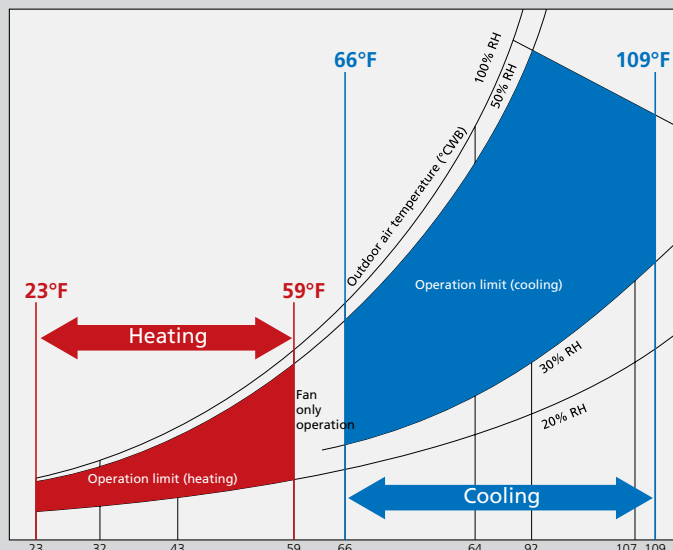

Features and Benefits

- Can be connected to all North American Daikin VRV systems
- Available in three capacities, nominal 48, 72 and 96 MBH
- The nominal airflow are 635, 988, and 1,236 CFM respectively
- External static pressure capabilities of up to 1.03" W.G. allows for flexibility with duct work and filtration choices
- The indoor unit is controlled to a set cooling and heating discharge air temperature allowing the flexibility to integrate with a standard Daikin indoor unit or duct directly to the space
- A low profile design of only 18.5" high reduces the required installation space and can eliminate mechanical rooms or additional structural supports associated with traditional OA systems
- Indoor Air Quality options include MERV 8 and 13 filters and filter boxes
- Connects directly and seamlessly into the Daikin local and centralized control suite

FXMQ_MFVJU Specifications

FXMQ_MFVJU Specifications		4-Ton	6-Ton	8-Ton
Model Name		FXMQ48MFVJU	FXMQ72MFVJU	FXMQ96MFVJU
Power Supply	V/ph/Hz	208-230/1/60		
Cooling Capacity	Btu/h	48,000	72,000	96,000
Heating Capacity	Btu/h	30,000	47,000	59,000
Airflow Rate	cfm	635	988	1,236
Unit Weight	lbs.	190	271	271
Unit Height	in.	18 1/2	18 1/2	18 1/2
Unit Width	in.	29 1/4	54 3/8	54 3/8
Unit Depth	in.	43 5/16	43 5/16	43 5/16
Sound Pressure	dB(A)	42	47	47
External Static Pressure	in. W.G.	0.88	0.96	1.03
Pipe Connections	Liquid	in.	3/8	3/8
	Gas	in.	5/8	3/4
External Finish		Galvanized Steel Plate		
Protection Devices		Fuse Fan Motor Thermal Protector		
Operating Range - Cooling	°F	66 DB/59 WB - 95 DB/90 WB		
Operating Range - Heating	°F	23 DB to 68 DB		
Discharge Air Temp. - Cooling	°F	55 - 77		
Discharge Air Temp. - Heating	°F	64 - 86		

Connection Rules

- When the Outside Air Processing Unit (OA processing unit) is used in conjunction with standard indoor unit(s) on a single piping network, the total combined connected capacity ratio of standard indoor unit(s) and OA processing unit must be equal or within 50% and 100% of the capacity of the condensing unit. In addition, the connected capacity of the OA processing unit must be equal or less than 30% of the capacity of the condensing unit.
- When the condensing unit is dedicated to the OA processing unit, the connected capacity of the OA processing unit must be equal or within 50% to 100% of the capacity of the condensing unit.

Nominal Conditions:

Cooling Mode

Discharge Set Temperature: 64 °F DB
Outdoor: 91 °F DB, 82 °F WB (68% RH)
Pipe Length: 25 ft.
Level Difference: 0 ft.

Heating Mode

Discharge Set Temperature: 77 °F DB
Outdoor: 32 °F DB, 27 °F WB (50% RH)
Pipe Length: 25 ft.
Level Difference: 0 ft.

Note:

Specifications are subject to change without notice.

FXMQ_MFVJU Accessories

Model Name	FXMQ48MFVJU	FXMQ72MFVJU	FXMQ96MFVJU
Navigation Remote Controller	BRC1E71	BRC1E71	BRC1E71
Wireless Remote Controller	BRC4C82	BRC4C82	BRC4C82
Remote Sensor Kit	KRCS01-1B	KRCS01-1B	KRCS01-1B
Wiring Adaptor PCB (interface with aux/primary heater, humidifier, OA damper/fan)	KRP1B71	KRP1B71	KRP1B71
Group Control Adaptor PCB (connects to external BMS)	KRP4A71	KRP4A71	KRP4A71
High Efficiency Filter Kit (MERV 13)	DACA-MQ48F-13-1K	DACA-MQ96F-13-1K	DACA-MQ96F-13-1K
High Efficiency Filter Kit (MERV 8)	DACA-MQ48F-8-1K	DACA-MQ96F-8-1K	DACA-MQ96F-8-1K

FXMQ_MFVJU Layout Example

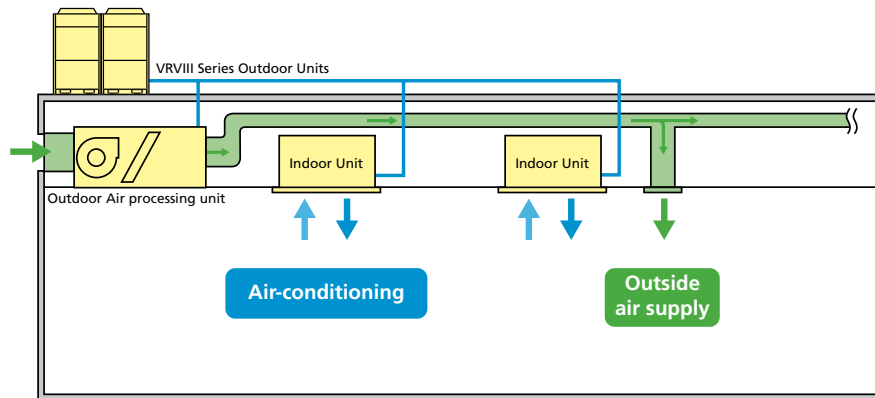

FXMQ_MFVJU Installation Space

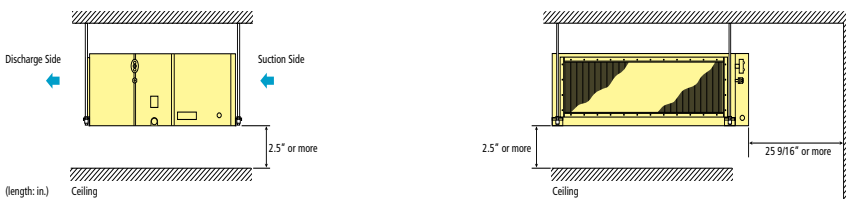



WARNINGS:

- Always use a licensed installer or contractor to install this product. Do not try to install the product yourself. Improper installation can result in water or refrigerant leakage, electrical shock, fire or explosion.
 - Use only those parts and accessories supplied or specified by Daikin. Ask a licensed contractor to install those parts and accessories. Use of unauthorized parts and accessories or improper installation of parts and accessories can result in water or refrigerant leakage, electrical shock, fire or explosion.
 - Read the User's Manual carefully before using this product. The User's Manual provides important safety instructions and warnings. Be sure to follow these instructions and warnings.
- For any inquiries, contact your local Daikin sales office.



© 2011 Daikin Industries, Limited.

Daikin®, Daikin AC Absolute Comfort®, and its design, VRV® and REFNET™ are trademarks pending or registered trademarks of Daikin Industries, Limited. All rights reserved. LonWorks® and LON® are registered trademarks of Echelon Corporation. BACnet® is a Data Communication Protocol for Building Automation and Control Networks, developed under the auspices of the American Society of Heating, Refrigerating and Air-Conditioning Engineers (ASHRAE).



JMI-0107

Organization:
DAIKIN INDUSTRIES, LTD.
AIR CONDITIONING MANUFACTURING DIVISION

Scope of Registration:
THE DESIGN/DEVELOPMENT AND MANUFACTURE OF COMMERCIAL AIR CONDITIONING, HEATING, COOLING, REFRIGERATING EQUIPMENT, COMMERCIAL HEATING EQUIPMENT, RESIDENTIAL AIR CONDITIONING EQUIPMENT, HEAT RECLAIM VENTILATION, AIR CLEANING EQUIPMENT, MARINE TYPE CONTAINER REFRIGERATION UNITS, COMPRESSORS AND VALVES.



JQA-1452

Organization:
DAIKIN INDUSTRIES
(THAILAND) LTD.

Scope of Registration:
THE DESIGN/DEVELOPMENT AND MANUFACTURE OF AIR CONDITIONERS AND THE COMPONENTS INCLUDING COMPRESSORS USED FOR THEM.



EC99J2044

All of the Daikin Group's business facilities and subsidiaries in Japan are certified under the ISO 14001 International standard for environmental management.

Dealer Information

Daikin AC (Americas), Inc.
 1645 Wallace Drive, Suite 110
 Carrollton, TX 75006 USA
www.daikinac.com
info@daikinac.com
 866-4DAIKIN
 972-245-1510

PCVINDUSE11-02C

Daikin's products are subject to continuous improvements. Daikin reserves the right to modify product design, specifications and information in this brochure without notice and without incurring any obligations.