



# Induction Melting Furnace Safety

Information That Might Save Your Life

**Paul Webber, Managing Director  
Inductotherm Group Canada Ltd.**



**WHAT  
NOT  
TO DO!**



**INDUCTOTHERM**

Note: Improper Charging and Improper PPE

# Safety First



	<b>! DANGER</b>
	Molten metal is inherently dangerous. The information provided in this guide must be followed. Failure to do so could result in injury or death.

	<b>! WARNING</b>
	Equipment must only be operated by a trained, qualified and authorized person who has read and understood all equipment manuals.

	<b>! DANGER</b>
	Personnel working in proximity to molten metal must wear appropriate Personal Protective Equipment (PPE).

	<b>! WARNING</b>
	Always read and understand the equipment instruction manuals before operating or maintaining the equipment.



*Foundry Safety Is A Shared Value*

# Foundry Safety is a Shared Value

- Working with molten metal has always been and will always be a dangerous profession.
- While it is impossible to remove the risk from melting metal, it is possible to make the melt shop an accident-free workplace.
- No matter how carefully equipment is manufactured, workers are trained or procedures are followed, the possibility of an accident can occur wherever molten metal is present.



*Foundry owners and managers must have a hazard assessment performed to determine the proper PPE for the job as required by OSHA.*

# Foundry Safety is a Shared Value

- Melt shop supervisors play a key role in assuring safe operation of equipment.
- Safety training needs to extend beyond melt shop workers.
- Management **MUST** make it a commitment to make safety a key corporate value.



*Working towards creating a safer work environment requires a true partnership between foundry managers/owners and the foundry workers who operate their equipment.*



## Your Safety is Important

- Adhere to all proper safety requirements from all equipment manufacturers (induction or otherwise).
- Listen to and follow all governing agencies and relevant associations rules and regulations.
- Create (and use) a plan.



## Written accident plans must clearly establish:

- Who will decide the extent of an emergency situation?
- What is the criteria for making that decision?
- Who will be in overall command?
- What will each person's responsibilities be during the emergency?



# Personal Protective Equipment (PPE)

The American Foundry Society (AFS) publishes: *A Guide for Selection and Use of Personal Protective Equipment (PPE) and Special Clothing for Foundry Operations*

	<p><b>! DANGER</b></p> <p>OSHA's Personal Protective Equipment Part 29 CFR (1910.132) states, "The employer shall assess the workplace to determine if hazards are likely to be present, which necessitate the use of Personal Protective Equipment (PPE)."</p>
---	---



*Typical Primary Protective Equipment*

# Suggested Agencies and Associations

## Consult With Relevant Governing Agencies and Industry Organizations

- Provincial Ministries of Labour (In Canada)
- Occupational Safety & Health Administration (OSHA in USA)
- National Fire Protection Agency
- American Foundry Society (AFS)
- ASTM International
- Local/ Municipal Safety Authority





# *Identifying and Preventing Induction Furnace Hazards*

# Typical Foundry Accident Causes

- Most foundry accidents happen due to one of the following:
  - Introduction of wet or damp material
  - Improper attention to charging
  - Failure to stand behind safety lines
  - Coming into contact with electrically charged components
  - Lack of operator skills and training



# Primary Molten Metal Splash

- Some primary causes of molten metal splash and furnace eruptions include:
  - Wet or damp charge material
  - Dropping heavy charge into a molten bath
  - Wet or damp tools or additives
  - Sealed scrap or centrifugally-cast scrap rolls



# Primary Protection Against Molten Metal Splash

- Use primary protection for molten metal splash and furnace eruptions when:
  - Scrap drying and preheating systems
  - Remote charging systems
  - Appropriate Personal Protective Equipment (PPE)
  - Distance/barriers



# Furnace Cooling

- Induction melting brings together three things—water, molten metal and electricity—that have the potential for concern if your furnace is not properly working.
  - Induction furnaces must have a water cooling system built into the coil itself.
  - Water picks up the heat caused by the current, as well as heat conducted from the metal through the refractory.
  - The water carries the heat to a heat exchanger for removal.

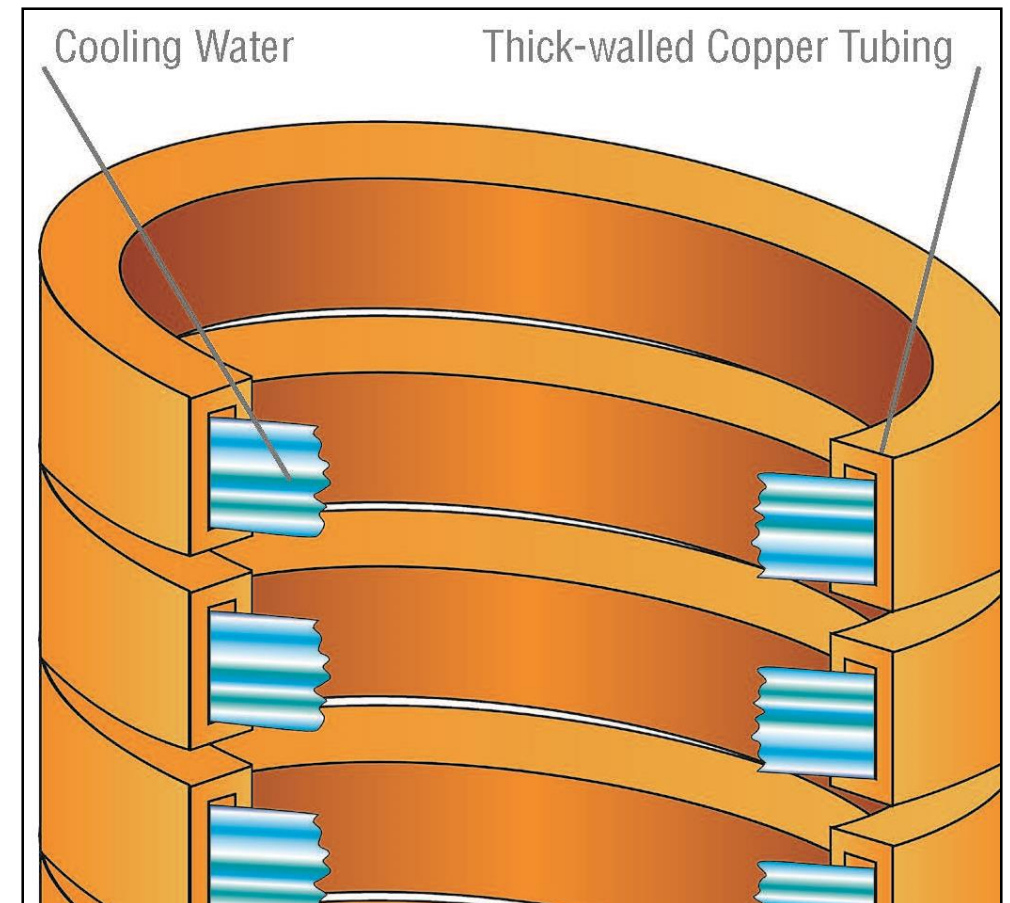

# Bridging Situations Require Immediate Attention

- It is important that care be taken during charging.
- If the charge does not feed into the molten pool properly, a bridge may occur and superheating below may occur and superheating below can erode the refractory, causing molten metal to penetrate to the coil.

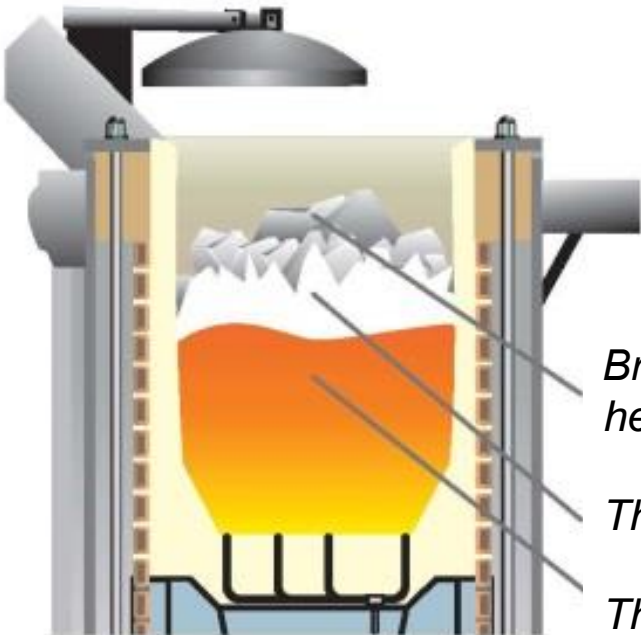

*Bridging occurs when a “cap” forms over the top of the furnace, allowing a buildup of superheated gases in the void below. If a bridge develops, power must be turned off immediately.*

*The void separating molten metal from the bridge of solid charge material acts as an insulator.*

*The molten metal will superheat and the temperature will rise rapidly.*



# Spill Pits

- Spill pits serve to contain any molten metal spilled as a result of accident, run out or dumping of the furnace in an emergency.
- Spill pits need to meet the following standards:
  - Adequate Capacity
  - Proper Construction
  - Absolutely Dry
  - Water Diversion System
  - Attentive Maintenance

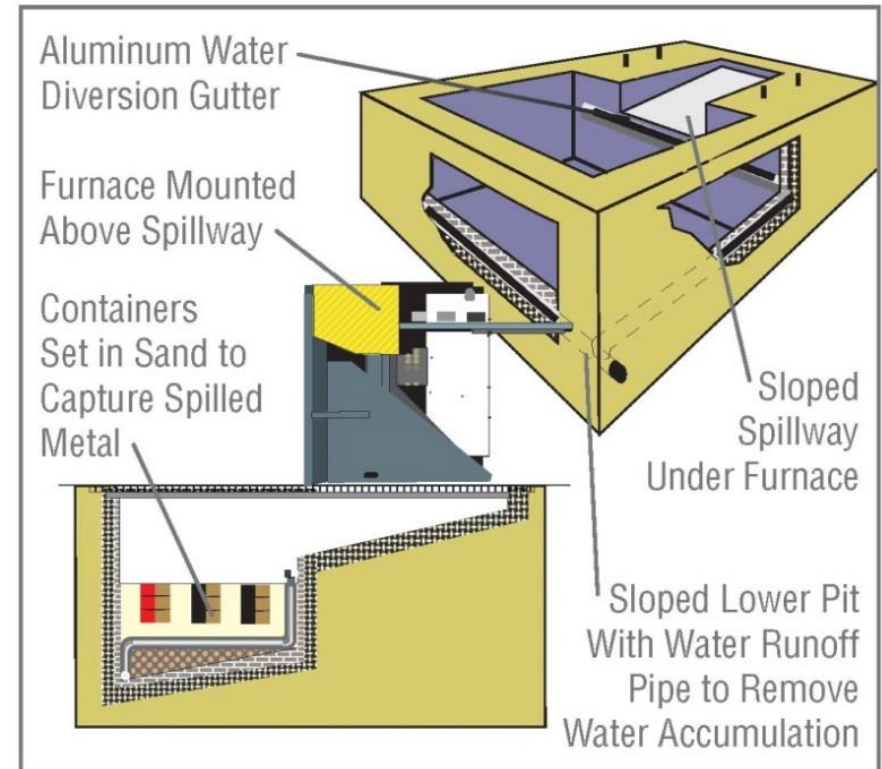

	<b>! DANGER</b>
	Metal poured into a pit or runout area where moisture, standing water, oils or other fluids are present can cause an explosion that could cause serious injury or death.

# Ground and Leak Detection

- GLD: A primary safety device
- If a leak is suspected at any time, cease operation, clear the melt deck area of all personnel and empty the furnace.
- Molten metal fins can penetrate worn or damaged refractory and come into contact with the coil.

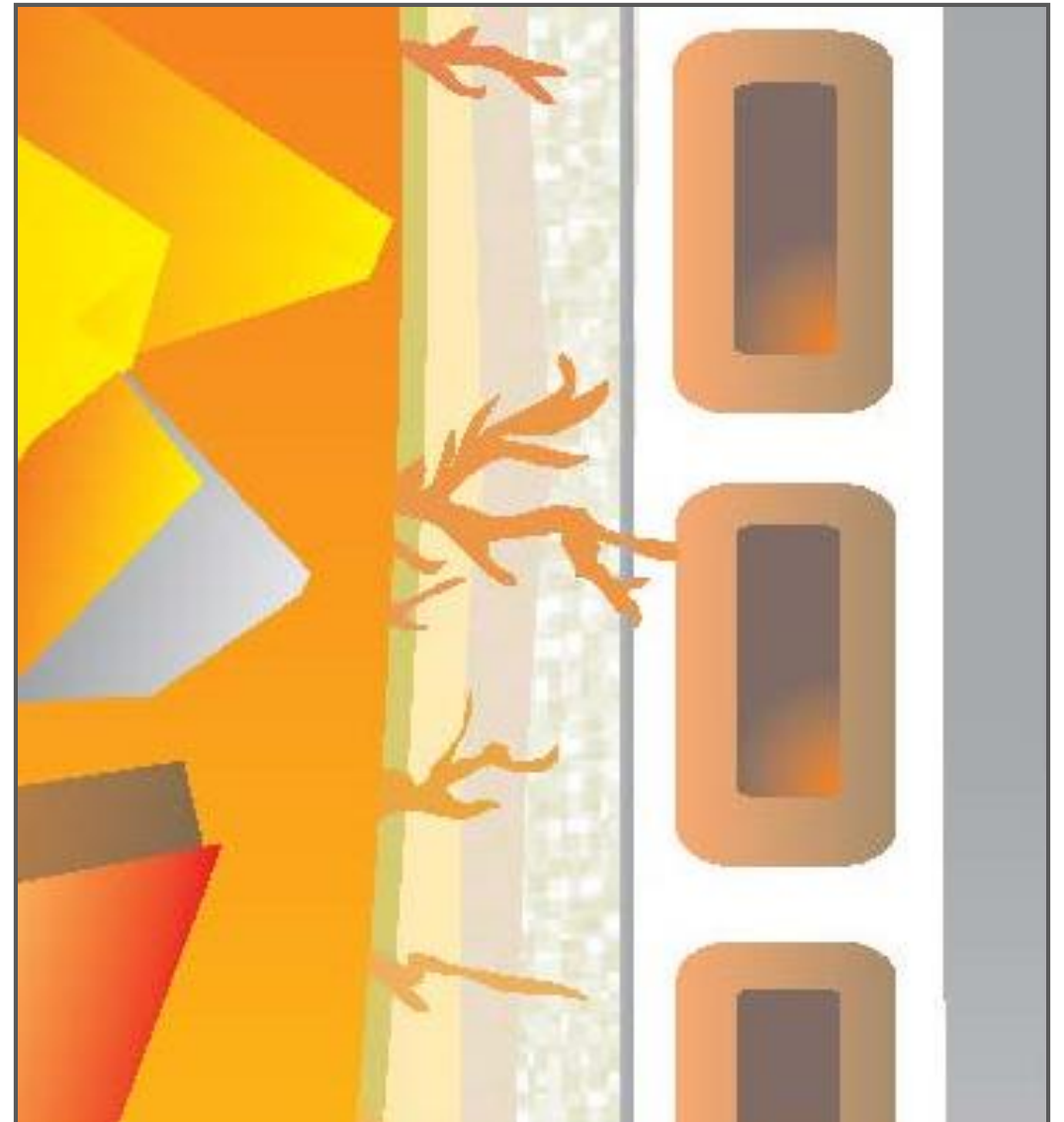
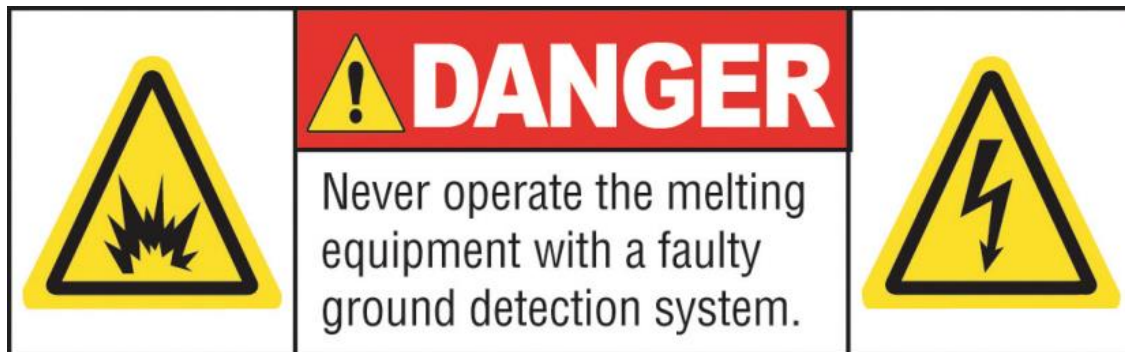

# Ground and Leak Detection

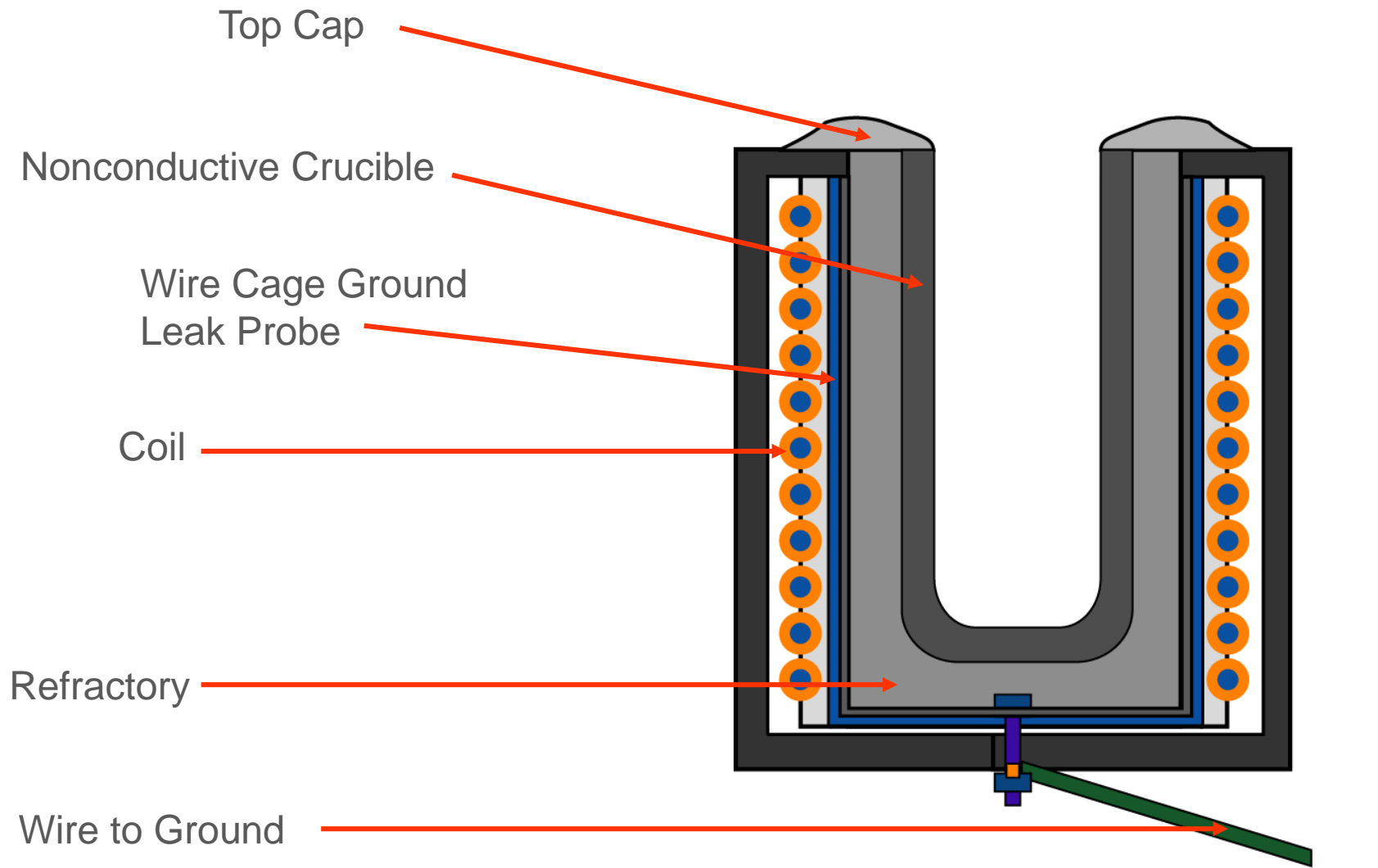

*Ground Leak Probe in Nonconductive Crucible*

# Ground and Leak Detection

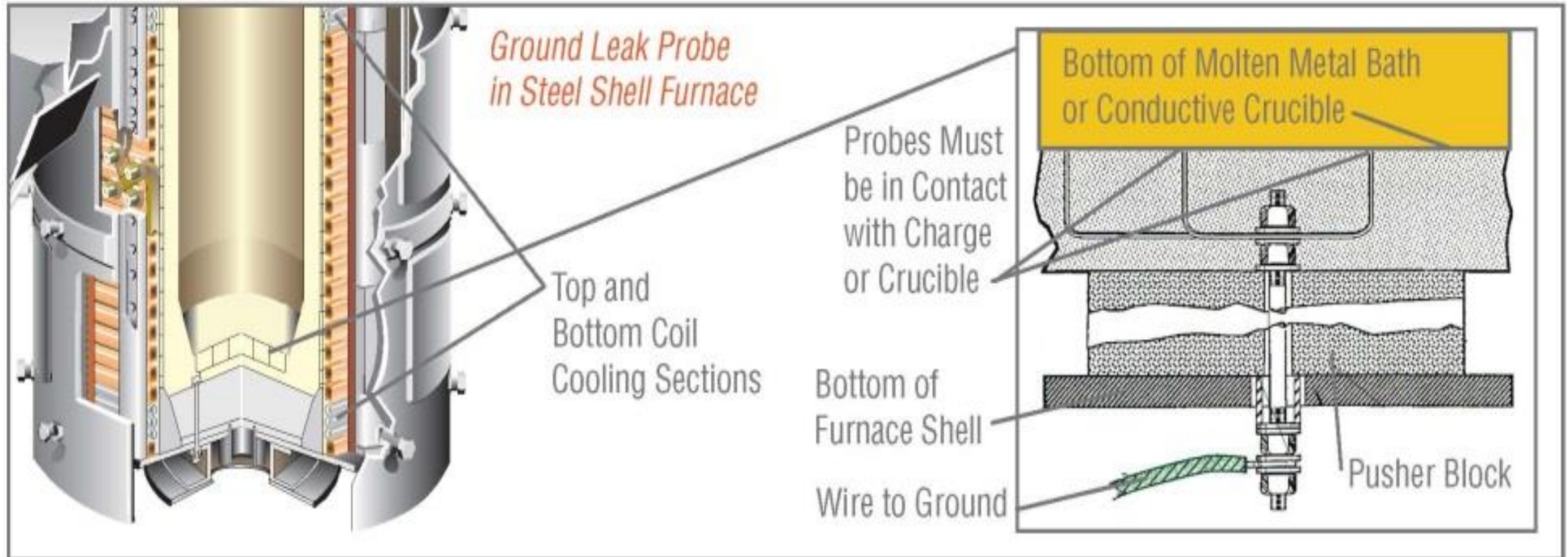

*Ground Leak Probe in Steel Shell Furnace*

# Last Line of Defense

- A handheld ground leak detector probe test verifies the integrity of the furnace's ground probe system.
- Note the use of appropriate Personal Protective Equipment (PPE).



# Proper Maintenance

- Inspect the following components regularly:
  - Structure and Welds
  - Hardware
  - Hydraulics and Pneumatics
  - Water Hoses
  - Water-Cooled Power Cables
  - Protective Barriers



*Inspections must not be performed if the equipment contains molten metal.*

# Automated Systems Create Safer Work Environments

- Automated systems distance foundry workers from molten metal
- From preheating to charging and slagging and pouring, there are many options available



# Moving Equipment Presents Additional Hazards

- A furnace or a close capture hood which suddenly swings down from a tilted position will cause injury or death.
  - Whenever you are working on a furnace or close capture hood when it is in the tilted position, be sure that it is supported with a structural brace that is strong enough to keep it from dropping if hydraulic pressure is lost.





# Trapping Hazards

- Trapping: The term for the situation where part or all of a worker's body becomes caught between moving equipment and another object or structure.

	<p><b>! WARNING</b></p> <p>Always watch for moving equipment. No one should be on or near the furnaces or charging equipment when they are in motion. The lift, tilt, indexing and swing movements could injure bystanders.</p>
---	---

	<p><b>! WARNING</b></p> <p>Do not stand or place any part of your body under the charge bucket while it is suspended.</p>
---	---



*A charge bucket carried by an overhead crane drops its charge into a charge car*

# Refractory Lining Failure

- In theory refractory wear should be uniform, however, in practice this never occurs.
- The most intense wear occurs:
  - At the slag/metal interface
  - Where sidewalls join the floor
  - On less dense areas caused by poor lining installation
  - The emptied furnace must be visually inspected



	<p><b>CAUTION</b></p> <p>It is mandatory that the refractory manufacturer's instructions for installation, curing, day-to-day maintenance and start-up procedure of the initial lining are followed. Refractory temperature must be properly controlled by using thermocouples during the sintering process.</p>
---	--

# Cause of Lining Failure

- Inadequate/improper installation of refractory material
- Inadequate/improper sintering of refractory material
- Failure to monitor/record normal lining wear
- Allowing the lining to become too thin
- Installation of the wrong refractory
- Inadequate/improper preheating of a used cold lining
- Failure to properly maintain the furnace
- The sudden or cumulative effects of physical shocks or mechanical stress
- Excessive slag or dross buildup

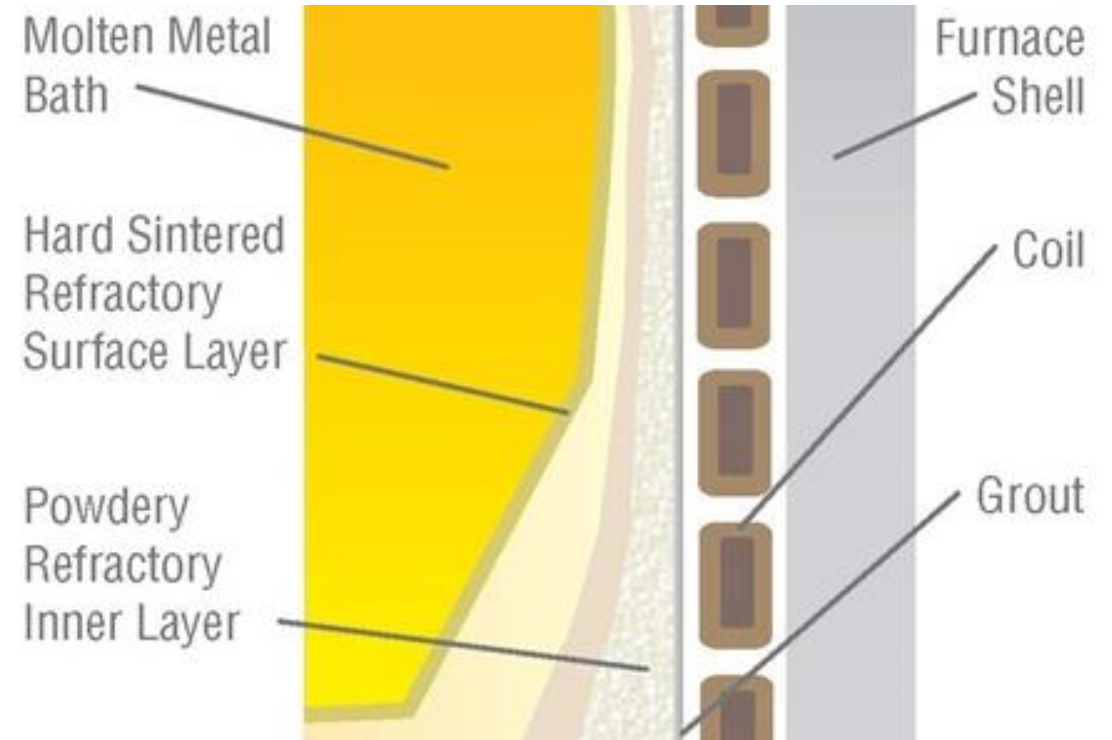

# The Future of Monitoring Normal Lining Wear

## IRIS™ System for Monitoring Lining Wear

### Scan, Monitor and Store Key Data in Real Time

The IRIS™ System can enhance safety, prolong the life of the induction coil and make furnace maintenance easier.

#### Digital Data Makes Sense

The IRIS™ (Inductotherm Refractory Image Scanning) System is an advanced, laser-based furnace refractory imaging and profiling system which can be used to detect general refractory wear or build-up on a furnace.

By scanning and monitoring the furnace lining routinely, the system provides many key benefits. The IRIS™ System scans over 400,000 data points on each furnace lining which creates important data that helps save time on lining inspections.

#### The System performs four operations and functions:

1. **The Baseline Scan** is the longest and is taken after a new lining is sintered.
2. **The Production Scan** is a quicker scan that is taken routinely during the life of the lining.
3. **Monitoring of the Lining** happens in real time. The HMI compares the latest production scan with the baseline scan to generate lining wear statistics and diagnostics.

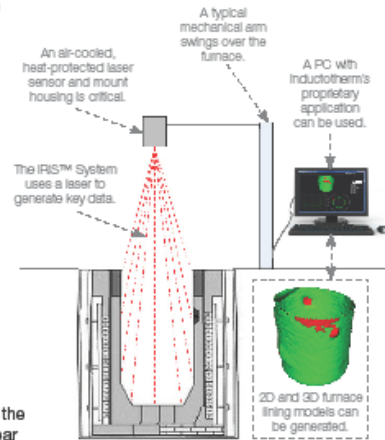

4. **Storing Data Analytics** is key. The IRIS™ System keeps a history of the latest scans for records and reports on past/current and predicted future lining wear or build-up.

#### Monitoring Lining Wear

Monitoring lining wear can help extend coil life. In theory wear on refractory should be uniform, however more wear often occurs at the slagging interface and where the sidewalls join the bottom. The benefits of the IRIS™ System and monitoring lining wear is to maximize furnace utilization while minimizing the risk of using a furnace with a lining in poor condition.

While nothing is better than visually inspecting the furnace lining after each melt for signs of lining wear and/or build-up, the IRIS™ System can be used to visualize the lining wear over time.

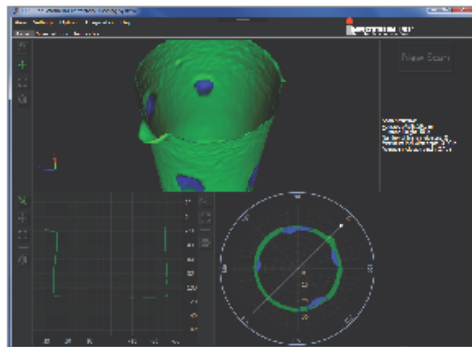

The IRIS™ System provides valuable data that can be used for analyzing the lining wear.

## IRIS

- Laser Based Refractory Scanning System
- Provides a Baseline scan of the lining
- Monitors wear and build up during the life of the lining
- Provides predicted future wear and build up.

# Melt Automation Technology

- Melt shop automation technology helps the operator to prevent accidental superheating and lining damage.
- These controls are designed to assist a fully trained and qualified operator in running the furnace and power supply.
- They are not a substitute for the direct, careful and continuous attention that an operator must give to the furnace and power supply whenever they are operating

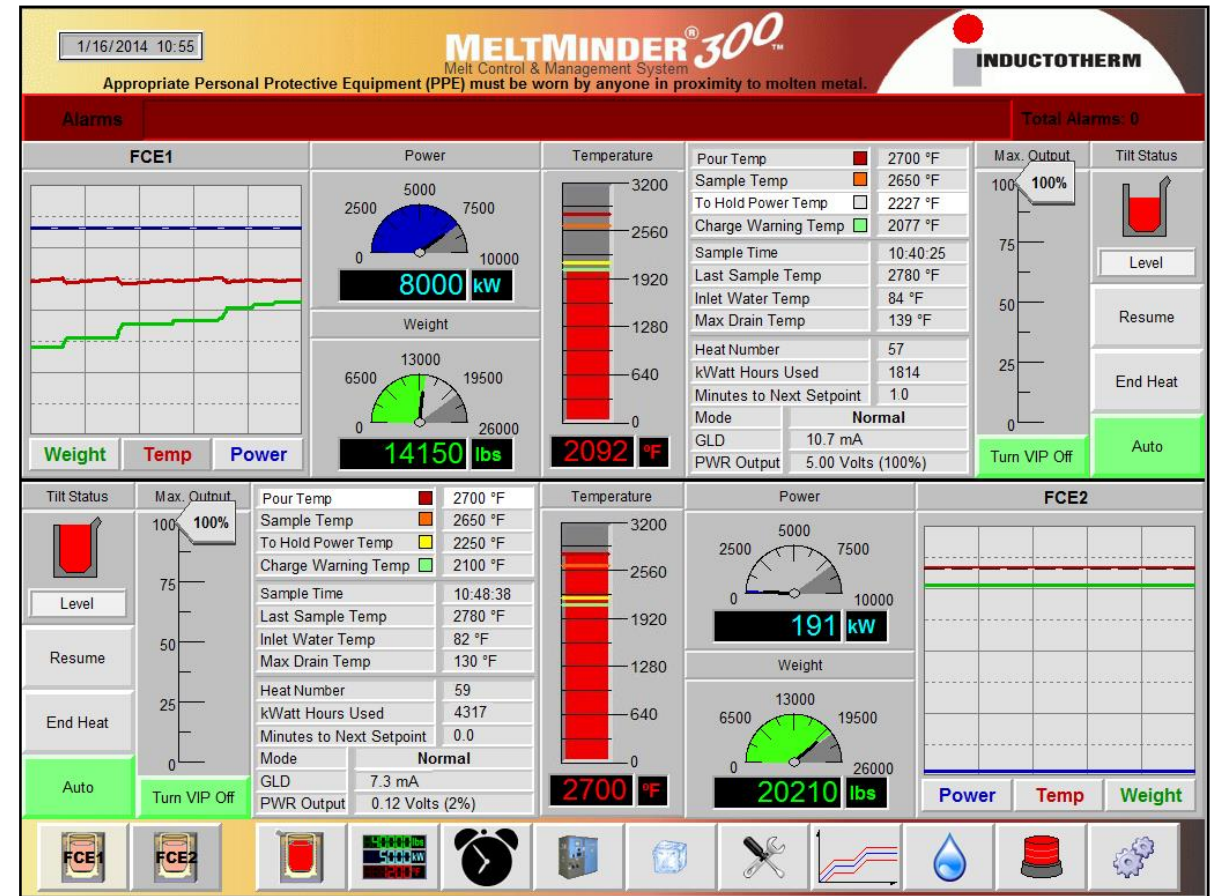

# Pouring Cradle

- Pouring cradles provide bottom support for crucibles.
- Should a crack in the crucible occur below the bottom ring support, the bottom of the crucible can drop and molten metal will spill and splash, possibly causing serious injury or death.
- To reduce this danger, a pouring cradle that provides bottom support for the crucible must be used.



# Push-Out Systems

- Minimize refractory dust during lining removal
- Furnaces equipped with these systems speed the lining removal process, which lessens the risk of damage to the coil and reduces worker exposure to refractory dust
- Make sure no one is standing near the furnace where they could be hit by material

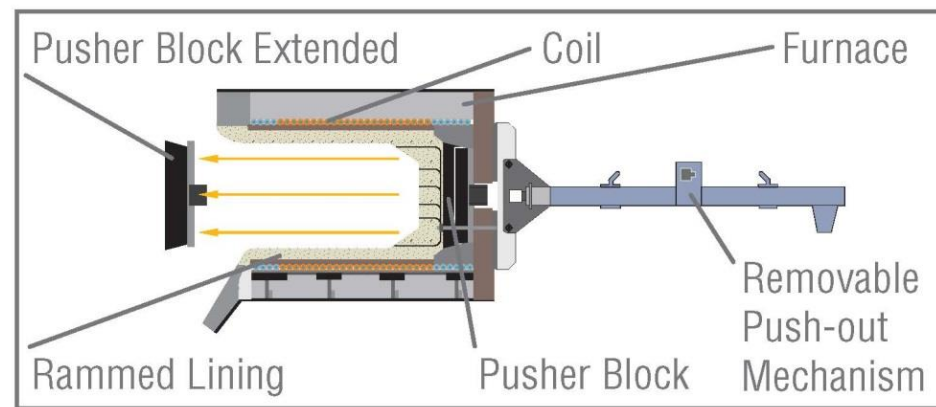

# Induction Electrical System Safety

- Power supply units must have safety locks and interlocks on all doors and access panels.
- Technicians who work with low-voltage devices must be made aware of the risk posed by high levels of voltage and current.
- Only trained and qualified personnel are to have access to high risk areas.
- Safety lockout systems are another effective measure to prevent electrical shock.

*High-current bus bar is enclosed to prevent accidental contact*



*This power cabinet door latching bar provides both a mechanical barrier to door opening and electrical interlock*

	<b>! DANGER</b>
	Power to the furnace must be turned off whenever any process involving contact with the metal bath, such as taking samples, checking metal temperature or slagging is taking place. This is to prevent electrocution if safety systems should fail and the bath is in conductive contact with the induction coil.



# Safety Lockouts / Tagouts

- To prevent power from being turned on accidentally while equipment is being serviced, a safety *LOTO* system is required.
- With this system the individual performing the service work uses a lock to secure the circuit interrupter in the OFF position.
- The same individual keeps the only key until the service work is complete and the equipment is ready to be restored to operation.



	<p>The lockout/tagout procedure must be followed before entering any remote and/or main control cabinet or enclosure or working on any equipment or system which has exposed or enclosed electrical motors or any electrically controlled solenoids.</p>

# Safety Systems are Critical

- Induction power units include some or all of these safety systems:
  - Safety interlocks
  - System self diagnostics
  - Ground and leak detector systems
  - Battery-operated DC pumps
  - Ultra-fast acting AC interrupter modules
  - Current limiting reactors and quick-acting circuit interrupter
  - Capacitor pressure switches
  - Line isolation



# Safety Systems are Critical

- Although rare, a fault may develop resulting in coil damage and power failure.
- The fault is typically caused by loose metallic chips that work their way between the coil and furnace structure.
- In this event the unit **MUST** trip immediately, prior to turn to turn arching which can cause water leakage

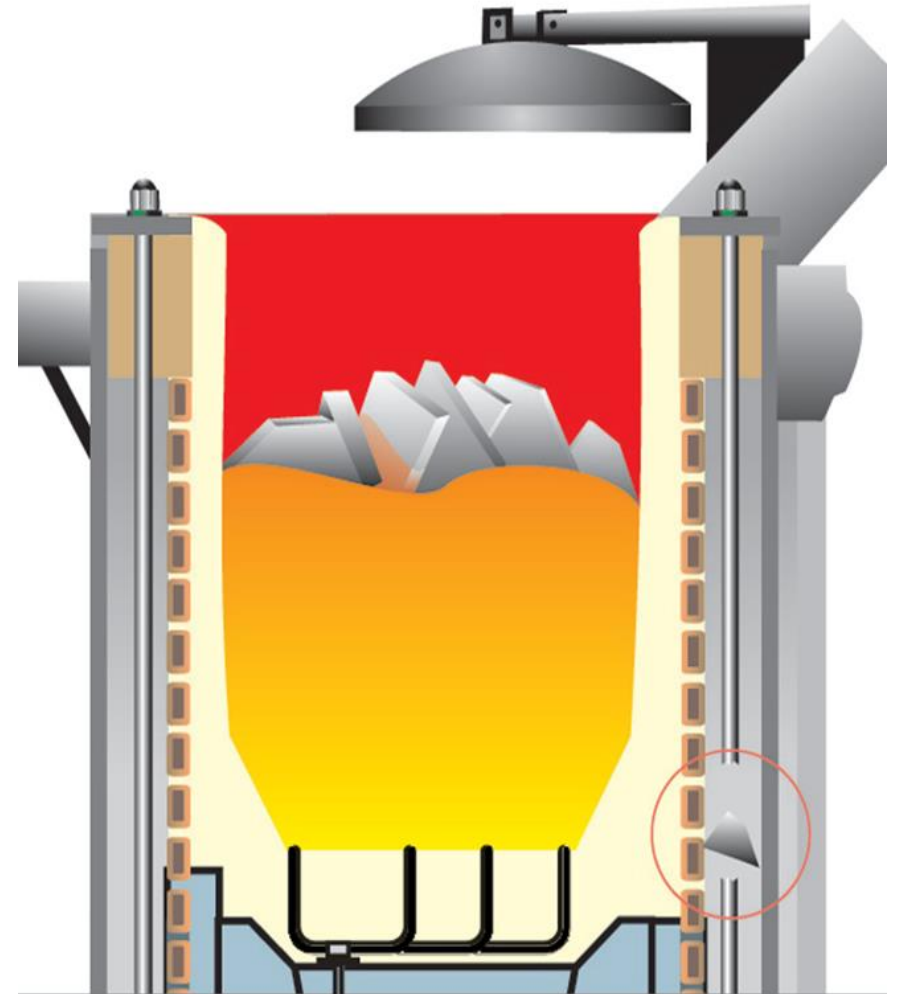



*In Conclusion*

# In Conclusion

Foundry Safety is an *IMPORTANT* and Shared Value

- Everyone needs safety training (and retraining)
- Safety starts on day one
- Melt shop supervisors and owners play a key role
- Specify safer equipment when possible
- Never bypass safety devices
- Be aware and stay alert to foundry hazards
- Always wear proper PPE



**THANK YOU !**

**QUESTIONS?**