

JAGXTREME[®]

Industrial Scale Terminal Technical Manual

This manual describes the operation and functionality of the JAGXTREME terminal. The software number ("B" revision) is displayed during the power-up sequence.

COPYRIGHT

Copyright 2003 Mettler-Toledo, Inc. This documentation contains proprietary information of Mettler-Toledo, Inc. It may not be copied in whole or in part without the express written consent of Mettler-Toledo, Inc.

METTLER TOLEDO reserves the right to make refinements or changes to the product or manual without notice.

U.S. Government Restricted Rights Legend: This software is furnished with Restricted Rights. Use, duplication, or disclosure of the Software by the U.S. Government is subject to the restrictions as set forth in subparagraph (C) (1) (ii) of the Rights in Technical Data and Computer Software clause at 40 C.F.R. Sec. 252.227-7013 or in subparagraphs (c) (1) and (2) of the Commercial Computer Software-Restricted Rights clause at 40 C.F.R. Sec. 52-227-19, as applicable.

FCC NOTICE

This device complies with Part 15 of the FCC Rules and the Radio Interference Requirements of the Canadian Department of Communications. Operation is subject to the following conditions: (1) this device may not cause harmful interference, and (2) this device must accept any interference received, including interference that may cause undesired operation.

This equipment has been tested and found to comply with the limits for a Class A digital device, pursuant to Part 15 of FCC Rules. These limits are designed to provide reasonable protection against harmful interference when the equipment is operated in a commercial environment. This equipment generates, uses, and can radiate radio frequency energy and, if not installed and used in accordance with the instruction manual, may cause harmful interference to radio communications. Operation of this equipment in a residential area is likely to cause harmful interference in which case the user will be required to correct the interference at his or her own expense.

ORDERING INFORMATION

It is most important that the correct part number is used when ordering parts. Parts orders are machine processed, using only the part number and quantity as shown on the order. Orders are not edited to determine if the part number and description agree.

TRADEMARKS

METTLER TOLEDO®, JAGUAR®, JAGXTREME and DigiTOL are registered trademarks of Mettler-Toledo, Inc. All other brand or product names are trademarks or registered trademarks of their respective companies.

FOLD THIS FLAP FIRST



NO POSTAGE
NECESSARY IF
MAILED IN THE
UNITED STATES

BUSINESS REPLY MAIL
FIRST CLASS PERMIT NO. 414 COLUMBUS, OH

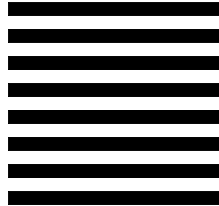

POSTAGE WILL BE PAID BY ADDRESSEE

Mettler-Toledo, Inc.
Quality Manager - MTWT
P.O. Box 1705
Columbus, OH 43216
USA



Please seal with tape.

DECLARATION OF CONFORMITY

Konformitätserklärung
 Déclaration de conformité
 Declaración de Conformidad
 Conformiteitsverklaring
 Dichiarazione di conformità



We/Wir/Nous/Wij/Noi: **Mettler-Toledo, Inc.**
1150 Dearborn Drive
Worthington, Ohio 43085
USA

declare under our sole responsibility that the product,
 erklären, in alleiniger Verantwortung, daß dieses Produkt,
 déclarons sous notre seule responsabilité que le produit,
 declaramos, bajo nuestra sola responsabilidad, que el producto,
 verklaren onder onze verantwoordelijkheid, dat het product,
 dichiariamo sotto nostra unica responsabilità, che il prodotto,

Model/Type: **Jaguar and JagXtreme**

to which this declaration relates is in conformity with the following standard(s) or other normative document(s).
 auf das sich diese Erklärung bezieht, mitder/den folgenden Norm(en) oder Richtlinie(n) übereinstimmt.
 Auquel se réfère cette déclaration est conforme à la (aux) norme(s) ou au(x) document(s) normatif(s).
 Al que se refiere esta declaración es conforme a la(s) norma(s) u otro(s) documento(s) normativo(s).
 Waarnaar deze verklaring verwijst, aan de volende norm(en) of richtlijn(en) beantwoordt.
 A cui si riferisce questa dichiarazione è conforme alla/e sequente/i norma/e o documento/i normativo/i.

in combination with a weighing platform produced by Mettler-Toledo is in conformity with the following directives and standards.

Council directive on the harmonization of the laws of the Member states:	standards:	Certificate number (if applicable)
relating to non-automatic weighing instruments (90/384/EEC) amended by directive (93/68/EEC)	EN 45501:1992 Article 1.2.a	TC 2618
relating to electromagnetic compatibility (89/336/EEC) amended by directive (93/68/EEC; 92/31/EEC)	EN 55022, B	
relating to electrical equipment designed for use within certain voltage limits (73/23/EEC amended by directive (93/68/EEC)	EN 60950	
Relating to electrical equipment designed for use in potentially explosive atmospheres (94/9/EC) (Refer to note 1)	EN 50021 : 1999 EN 50281-1-1 : 1998	KEMA 02ATEX1023 X (Refer to note 1)

Worthington, Ohio USA, April, 2003

Mettler-Toledo, Inc.

Darrell Flocken, Manager - Weights & Measures
 Office of Weights and Measures

Notes:

- 1. Certificate KEMA 02ATEX1023 X applies only to JagXtreme units only. Refer to Section (17) of the certificate for special conditions.**

Original issue: July, 1995
Revised: October, 1996 added compliance to Low Voltage Directive
 May, 2000 added JagXtreme
 April, 2003 added compliance to ATEX Directive.

PRECAUTIONS

READ this manual BEFORE operating or servicing this equipment.



FOLLOW these instructions carefully.

SAVE this manual for future reference.



DO NOT allow untrained personnel to operate, clean, inspect, maintain, service, or tamper with this equipment.

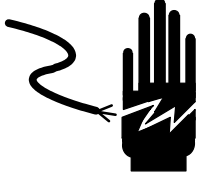

ALWAYS DISCONNECT this equipment from the power source before cleaning or performing maintenance.

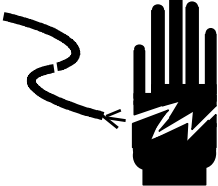

CALL METTLER TOLEDO for parts, information, and service.

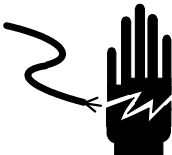

	 WARNING
	DISCONNECT ALL POWER TO THIS UNIT BEFORE INSTALLING, SERVICING, CLEANING, OR REMOVING THE FUSE. FAILURE TO DO SO COULD RESULT IN BODILY HARM AND/OR PROPERTY DAMAGE.



	 CAUTION
	OBSERVE PRECAUTIONS FOR HANDLING ELECTROSTATIC SENSITIVE DEVICES.

	 WARNING
	ONLY PERMIT QUALIFIED PERSONNEL TO SERVICE THIS EQUIPMENT. EXERCISE CARE WHEN MAKING CHECKS, TESTS AND ADJUSTMENTS THAT MUST BE MADE WITH POWER ON. FAILING TO OBSERVE THESE PRECAUTIONS CAN RESULT IN BODILY HARM.

	 WARNING
	FOR CONTINUED PROTECTION AGAINST SHOCK HAZARD, CONNECT TO PROPERLY GROUNDED OUTLET ONLY. DO NOT REMOVE THE GROUND PRONG.

	 WARNING
	<p>IN ORDER TO INSTALL THE DIVISION 2 APPROVED JAGXTREME PANEL-MOUNT OR HARSH TERMINAL UTILIZING THE FACTORY MUTUAL APPROVAL, METTLER TOLEDO CONTROL DRAWING 157043R MUST BE FOLLOWED WITHOUT EXCEPTION. IN ORDER TO INSTALL THE CATEGORY 3 JAGXTREME PANEL-MOUNT OR HARSH TERMINAL UTILIZING THE KEMA APPROVAL THE KEMA APPROVAL CERTIFICATE 02ATEX1023X AND ALL LOCAL REGULATIONS MUST BE FOLLOWED WITHOUT EXCEPTION. FAILURE TO DO SO COULD RESULT IN BODILY HARM AND/OR PROPERTY DAMAGE. REFER TO THE JAGXTREME DIVISION 2 AND ZONE 2/22 INSTALLATION GUIDE, 16088600A FOR ADDITIONAL INFORMATION.</p>

	 WARNING
	<p>EARLIER MODELS OF THE JAGXTREME TERMINAL THAT ARE NOT MARKED (FACTORY-LABELED) AS DIVISION 2 OR EUROPEAN CATEGORY 3 APPROVED MUST NOT BE INSTALLED IN A DIVISION 2 OR ZONE 2/22 ENVIRONMENT.</p>

	 WARNING
	<p>IF THE KEYBOARD, DISPLAY LENS OR ENCLOSURE IS DAMAGED ON A DIVISION 2 APPROVED OR CATEGORY 3 MARKED JAGXTREME PANEL-MOUNT OR HARSH TERMINAL THAT IS USED IN A DIVISION 2 OR ZONE 2/22 AREA, THE DEFECTIVE COMPONENT MUST BE REPAIRED IMMEDIATELY. REMOVE AC POWER IMMEDIATELY AND DO NOT REAPPLY AC POWER UNTIL THE DISPLAY LENS, KEYBOARD OR ENCLOSURE HAS BEEN REPAIRED OR REPLACED BY QUALIFIED SERVICE PERSONNEL. FAILURE TO DO SO COULD RESULT IN BODILY HARM AND/OR PROPERTY DAMAGE.</p>

CONTENTS

1

Introduction	1-1
Model Identification	1-1
References/Resources	1-2
Accessories	1-2
Other Compatible Products	1-6
Software	1-7
Specifications	1-8
Display and Keypad	1-9
Physical Dimensions	1-10
Power Requirements	1-15
Controller PCB	1-15
Temperature and Humidity	1-16
Environmental Protection	1-16
Standards Compliance	1-16
UL and cUL Listing	1-16
Weights and Measures Approvals	1-16
CE Conformity	1-17
Conducted and Radiated Emissions (RFI)	1-17
Radio Frequency Interference Susceptibility	1-17
AC Power Line Voltage Variation	1-17

2

Installation	2-1
Overview	2-1
Unpacking and Inspection	2-1
Standards Compliance	2-2
UL and cUL Listing	2-2
Environmental Considerations	2-2
Temperature and Humidity	2-2
Environmental Protection	2-2
Power Considerations	2-2
Connecting to the JAGXTREME Terminal	2-4
Connecting the Load Cell	2-4
Serial Port Connections Controller PCB	2-9
Discrete Wiring	2-13
Optional Multifunction I/O PCB Serial and Discrete Connections	2-15
Connecting the Power Cable	2-17
Installing the General Purpose Model	2-18
Installing the Panel Mount Model	2-20
Installing the Blind Panel Mount Unit	2-21
Installing the Harsh Environment Enclosure	2-22
Opening the Harsh Environment Terminal	2-22
Mounting the Harsh Environment Terminal	2-23
Ethernet Connection	2-24
JAGXTREME Terminal Jumper and Switch Settings	2-25

Controller PCB	2-25
Analog Load Cell PCB	2-26
Single Channel Analog Load Cell PCB	2-27
Dual Channel Analog Load Cell PCB	2-28
Allen-Bradley RIO PCB.....	2-28
POWERCELL PCB	2-29
MMR (IDNET) PCB.....	2-29
Multifunction I/O PCB	2-30
Installing Options.....	2-30
Apply Power.....	2-31
Power-up Sequence	2-32
Scale Build Determination.....	2-32
Minimum Increment Size for Bench and Portable Single DLC Scale Bases	2-32
Minimum Increment Size For Optional Analog Scale Input	2-33
Sample Calculation	2-34
Seal the Enclosure - Weights and Measures Applications.....	2-34
Panel Mount Enclosure.....	2-34
General Purpose Enclosure	2-35
Harsh Environment Enclosure.....	2-35

3

Programming and Calibration	3-1
General Information	3-1
Front Panel Display	3-1
Key Functions.....	3-2
Accessing Setup	3-3
Navigating	3-4
Audible Messages.....	3-5
Reset to Factory	3-5
Configuring Terminals With Multiple Scales and a Summing Scale.....	3-6
Alibi Memory	3-7
Program Block Overview.....	3-8
Scale Interface Program Block.....	3-9
1. Market Sub-block.....	3-10
2. Scale Type Sub-block.....	3-10
3. Calibration Unit Sub-block.....	3-12
4. Capacity Sub-block	3-12
5. Increment Size Sub-block.....	3-13
6. Shift Adjustment Sub-block.....	3-14
7. Linearity Correction Sub-block	3-14
8. Calibration Sub-block	3-14
9. Zero Adjustment Sub-block.....	3-16
10. Span Adjustment Sub-block.....	3-16
11. Scale Test Sub-block	3-16
12. Add in Sum Sub-block.....	3-16
13. Gravity Adjustment Sub-block	3-17
14. Reset to Factory Sub-block.....	3-17
Using the JAGXTREME with IDNET Bases	3-17
Service Mode for IDNET Bases.....	3-17

JAGXTREME IDNET Calibration procedure.....	3-18
NATION Sub-block	3-24
RESET Sub-block	3-24
SCALE PARAMETERS Sub-block	3-25
LINEARITY Sub-block.....	3-25
CALIBRATION Sub-block	3-26
SAVE PARAMETERS Program Sub-block.....	3-26
RETURN Sub-block.....	3-26
Application Environment Program Block	3-27
1. Character Set Sub-block.....	3-28
2. Language Sub-block	3-28
3. Keyboard Type Sub-block	3-28
4. Scale ID Sub-block.....	3-28
5. Time and Date Sub-block.....	3-29
6. Alternate Weight Units Sub-block.....	3-30
7. Power Up Operation Sub-block	3-31
8. Tare Operation Sub-block.....	3-32
9a. Zero Operation Sub-block.....	3-34
9b. Zero Operation Sub-block for IDNET Bases	3-35
10a. Stability Detect Sub-block	3-35
10b. Stability Detect Sub-block for IDNET Bases	3-35
11. Beeper Operation Sub-block	3-36
12. Inhibit Memory Sub-Block	3-36
13. Application Type Sub-block	3-36
14. Vibration Rejection Sub-block	3-37
14a. Vibration Rejection Sub-block for IDNET	3-38
Serial Interface Program Block	3-39
1. Configure Port Sub-block	3-40
2. Configure Template Sub-Block	3-44
Configure Discrete Program Block	3-49
1. Discrete Inputs Sub-block	3-50
2. Discrete Outputs Sub-block	3-51
3. Assign Setpoints Sub-block	3-52
Configure Memory Program Block.....	3-53
1. Configure Literals Sub-block.....	3-53
2. Configure Prompts Sub-block	3-54
3. Configure Consecutive Numbering Sub-block	3-55
4. Alibi Memory	3-56
Configure JagBASIC Program Block.....	3-57
1. Password Sub-block	3-58
2. Keyboard Sub-block.....	3-58
3. Display Sub-block.....	3-58
4. Auto Start Sub-block.....	3-59
5. Manual Start Sub-block	3-59
6. LPRINT Port.....	3-59
7. Send RAM Files Sub-block	3-59
8. Initialize RAM Disk Sub-block	3-60
9. Password Maintenance Sub-block	3-60
Configure Network Program Block	3-61
Network Overview	3-62

General Networking Considerations	3-63
IP addresses	3-63
Clustering JAGXTREME Terminals	3-64
1. Ethernet Sub-block	3-68
2. Name-Password Sub-block	3-68
3. Cluster IP Sub-block	3-69
4. PC Data Access (Reserved for Future Use)	3-69
5. Email	3-69
6. Web Server Sub-block	3-70
7. FTP Server Sub-block	3-70
8. PLC SP Control Sub-block	3-70
Configure Diagnostics Program Block	3-71
1. Memory Test Sub-block	3-72
2. Display Test Sub-block	3-72
3. Keyboard Test Sub-block	3-72
4. Scale Test Sub-block	3-73
5. Serial Test Sub-block	3-76
6. Parallel I/O Test Sub-block	3-77
7. Network Test Sub-block	3-78
8. Ethernet Send BRAM Sub-block	3-78
9. Zmodem Send BRAM Sub-Block	3-79
10. Print Setup Sub-block	3-79
11. Reset to Factory Sub-block	3-80
Configure Maintenance Program Block	3-81
1. Calibration Management Sub-block	3-82
2. Calib Chk Parm Sub-block	3-83
3. Calib Mon Parm Sub-block	3-84
Predictive Failure (Only for RAAD Box and POWERCELL Platforms) Sub-block	3-86
Calibrate Check Sub-block	3-88
Maintenance Reports Sub-block	3-89
Network Stats Sub-block	3-89
Reset to Factory	3-89
Options Program Block	3-90

4

Using the Web Server	4-1
System Requirements	4-1
Setup	4-1
Operating Modes	4-2
Navigation Bar Menu	4-2

5	The Optional JagMAX Application Software	5-1
	Application Setup	5-1
	Starting the Application	5-1
	Entering Application Setup	5-2
	Moving Through Application Setup	5-2
	General Setup	5-3
	Weigh Mode Setup	5-5
	Re-Weigh Mode Setup	5-6
	Double Mode Setup	5-7
	Triple Mode Setup	5-7
	Moving Van Mode Setup	5-8
	ID Mode Setup	5-8
	Send Setup File	5-10
	Print Setup	5-10
	Transaction Report	5-10
	In-Process Report	5-11
	Accumulation Report	5-12
	End Program	5-13
	Printing	5-13

6	Installing and Using JAGXFILES	6-1
	Hardware and Software Requirements	6-1
	Installing JAGXFILES	6-1
	Browser and JAGXTREME Setup	6-1
	Starting JAGXFILES	6-2
	Configuring JAGXFILES on Your PC	6-2
	Creating a Configuration File	6-2
	Configuring Option Boards	6-3
	Menu Items	6-4
	File	6-4
	Open	6-5
	Save	6-6
	Restore	6-7
	Backup	6-8
	All Other Menu Items	6-8
	Shutting Down JAGXFILES	6-8

7	Service and Maintenance	7-1
	Tools and Supplies	7-1
	Cleaning and Regular Maintenance	7-1
	Troubleshooting	7-1
	Status Lights	7-2
	Error Codes and Actions	7-2

Diagnostic Tests	7-18
AC Power Test	7-18
Voltage Test	7-18
Backup Battery Test.....	7-20
Ground Test	7-20
External Equipment Test.....	7-20
Internal Testing	7-21
20 mA /RS-232 Printer Tests.....	7-21
Replacing the Power Supply	7-22
Replacing the Battery Back-up	7-23

8

Parts and Accessories	8-1
Panel Mount Parts	8-2
General Purpose Parts (Front View)	8-4
General Purpose Parts (Rear View)	8-6
Harsh Environment Parts	8-7
Line Cord Assemblies.....	8-9
Controller PCB	8-10
Analog Load Cell PCB	8-11
Dual Analog Load Cell PCB.....	8-12
Power Supply	8-13
Allen-Bradley RIO Option	8-14
CIP Interface Card	8-15
PROFIBUS Option	8-15
MODBUS Plus PCB.....	8-16
Dual Analog Output Option.....	8-17
POWERCELL PCB.....	8-18
Multifunction PCB	8-19
IDNET PCB	8-20
Optional Accessories	8-21
Optional Panels	8-22
Recommended Spare Parts.....	8-22

9

Appendices.....	9-1
Appendix 1: Serial Interface Reference.....	9-1
Hardware Connections	9-2
Output Modes and Formats	9-3
Standard Status Bytes A, B, and C.....	9-4
4-Setpoint Status Bytes A, B, and C.....	9-5
Multi Cont 1	9-6
Multi Cont 2	9-6
Default Template Formats	9-9
Input Modes	9-11
ASCII Characters	9-16
Appendix 2: Discrete I/O Reference	9-20
Inputs.....	9-20

Outputs	9-21
Appendix 3: Network Reference	9-22
Keyboard/Display Sharing.....	9-22
Redirecting Serial Output.....	9-23
A-B RIO / PROFIBUS / MODBUS+ Option Sharing	9-24
Internet Explorer Proxy Server Setup.....	9-24
Appendix 4: Loading JAGXTREME Software	9-25
Using E_FLASH.....	9-25
E-FLASH Serial.....	9-26
E-FLASH Ethernet	9-27
FLASHPRO	9-27
Appendix 5: JAGXTREME Master Reset and Default Values	9-29
Appendix 6: Gravity Factors	9-35
Appendix 7: Multiple Range/Multi-Interval Operation	9-36
Multiple Range Operation	9-36
Multi-Interval Operation.....	9-37
Appendix 8: Market Destination (Finish) Codes	9-38

1 Introduction

Model Identification

The JAGXTREME® Internet-enabled scale terminal is designed to help companies provide cost-effective, flexible methods of production while maximizing engineering time and effort. It offers connectivity to all METTLER TOLEDO technologies, as well as open connectivity to the leading industry technologies, to facilitate communication and data exchange with companies' control, manufacturing execution, and enterprise systems.

The JAGXTREME terminal is available with various operator interfaces and enclosure types, as well as with the optional JAGXTREME operator interface and optional JAGMAX truck scale software. (Special instructions for programming the optional JAGMAX truck scale software are included in this manual. Separate documentation is available for the JAGXTREME operator interface). Please refer to the following Factory Number Reference chart to identify the JAGXTREME terminal with which you will be working. A detailed description of each designation is given to help you determine the specifications for each model. A brief description of the optional accessories appears on the next page.

If you are upgrading an existing METTLER TOLEDO JAGUAR® terminal to a new JAGXTREME terminal, refer to the instructions provided with your upgrade kit.

For users of the JAGXTREME terminal's predecessor, METTLER TOLEDO's JAGUAR terminal, please pay special attention to the programming and calibration section. Programming and calibration of the JAGXTREME terminal can be performed via the embedded web server as well as through the front panel of the unit.

FACTORY NUMBER REFERENCE CHART						
JAGXTREME TERMINAL MODEL CONFIGURATION						
JX	XX	X	X	X	X	XXX
Terminal	Enclosure Display	Slot #1 Accessory	Slot #2 Accessory	Slot #3 Accessory	Application Software	Destination Market
JAGXTREME Terminal	PB=Panel, Blind PA=Panel, A/N GA=General Purpose A/N HA=Harsh, A/N	0=Cover Plate 1=Analog Scale 2=RE* Analog Scale 3=POWERCELL® 4=IDNET A=Dual Analog Scale B=Dual RE* Analog Scale	0=Cover Plate 1=Analog Scale 2= RE*Analog Scale 3=POWERCELL 4=IDNET 7=Multifunction I/O A=Dual Analog Scale B=Dual RE* Analog Scale	0=Cover Plate 5=Modbus Plus 6=Allen Bradley RIO 7=Multi-function I/O 8=Dual Channel Analog Output 9=PROFIBUS C= CIP Interface**	0=Standard JagBASIC (included) 2 = JAGMAX™	000=USA See the Market Codes in the Appendix for additional destination codes

*RE – Reduced Excitation. JAGXTREME terminals with harsh environment enclosures are not approved for use in hazardous areas.

As an example, the factory number **JXPB-1002-000** denotes a JAGXTREME blind panel-mount terminal with analog scale card and JAGMAX software for use in the USA.

Note: To order a JAGXTREME operator interface, you must use a separate model number. Consult your METTLER TOLEDO representative or the JAGXTREME Operator Interface documentation.

** Note: CIP cannot be used with JXGA models.

References/Resources

This manual provides information for configuring and serving the JAGXTREME terminal. For information on installing the terminal, please refer to the Installation Guide that accompanies the terminal. An electronic copy is also included on the documentation CD-ROM that accompanies the unit. The CD-ROM includes the following resources:

- JAGXTREME Terminal Installation Guide
- JAGXTREME Terminal User's Guide
- JAGXTREME Terminal Technical Manual
- JAGXTREME Operator Interface Installation Guide
- JAGXTREME Operator Interface Technical Manual
- XTREMEBUILDER Software (with on-line help and programmer's reference guide)
- JagBASIC® Programmer's Guide
- JAGXTREME PLC Analog Output Interfaces Technical Manual
- CIP Interface Technical Manual
- JAGMAX Application Software User's Guide
- JAGMAX Application Software Printer Templates Guide
- JAGXFILES™ (utility)
- Eflash (utility)

For additional information, contact your authorized METTLER TOLEDO representative or go to: <http://www.mt.com>.

Accessories

A number of accessories are available for use with the JAGXTREME terminal. The model configurator designation number appears in parentheses. Please contact your authorized METTLER TOLEDO representative for more information.

Cover Plate (0)

This thin metal plate is used to cover the opening in the back of the regular or blind chassis panel-mount terminal if an optional PCB is not installed at this location.

Analog Scale (1)

This option is required when interfacing analog-type load cells. A 15-volt excitation voltage is used to power up to 16 350-ohm load cells from one analog PCB. A jumper is provided to select operation with 2 mV/V or 3 mV/V load cells. The JAGXTREME terminal will operate with load cells of impedances other than 350 ohms or other mV/V specifications, but the total scale resistance must not be less than 22 ohms. A quiet analog signal section, combined with a proprietary analog-to-digital converter and coprocessor implementing METTLER TOLEDO TraxDSP® filters, provides weighing and vibration rejection performance unequalled in the industry.

The zero temperature coefficient is 0.15 $\mu\text{V}/\text{degree C}$. The span temperature coefficient is 6 ppm/degree C. When using this option, the display update rate is limited to 10 updates per second. The actual A/D conversion rate exceeds 300 cycles per second. This high-speed process allows the terminal to filter out noise while providing a weight update rate of up to 50 updates per second for setpoint control and other functions.

Each analog scale option board has a removable EEPROM that stores calibration parameters for the scale. If an EEPROM is transferred to another board, all calibration parameters transfer. A detachable seven-position terminal strip is used to terminate the analog load cell cable on the rear of the PCB. Signal, excitation, sense, and shield connections are provided with easy-to-read descriptions. Two LEDs are visible through holes in the rear panel of the PCB to indicate the status of the analog PCB.

Reduced Excitation Analog Scale (2)

This option, when used with a protective load cell barrier, allows operation of the JAGXTREME terminal with analog load cells located in an area classified as hazardous by the National Electrical Code. This option is required if the terminal is to be used as a Division 2 or Category 3 approved terminal. The excitation voltage is lowered to 5 volts for this option. The standard JAGXTREME terminal cannot be located inside a Division 1 or Zone 0/1 hazardous area without special precautions. Purged enclosures are available from METTLER TOLEDO for applications which require the terminal to be located inside a Division 1 or Zone 0/1 classified area.

The zero temperature coefficient is 0.15 $\mu\text{V}/\text{degree C}$. The span temperature coefficient is 6 ppm/degree C. When using this option, the display update rate is limited to 10 updates per second. The actual A/D conversion rate exceeds 300 cycles per second. This high-speed process allows the terminal to filter out noise while providing a weight update rate of up to 50 updates per second for setpoint control and other functions.

Each option board has a removable EEPROM that stores calibration parameters for the scale. If an EEPROM is transferred to another board, all calibration parameters transfer as well. A detachable seven-position terminal strip is used to terminate the analog load cell cable on the rear of the PCB. Signal, excitation, sense, and shield connections are provided, each with an easy-to-read description. Two LEDs are visible through holes in the rear panel of the PCB to indicate its operating status.

POWERCELL (3)

The POWERCELL interface must be used when the JAGXTREME terminal is used with a METTLER TOLEDO POWERCELL load cell system or RAAD box(es). It supports up to a total of 24 DigiTOL POWERCELLs or six RAAD boxes. An external power supply is needed when using more than 14 POWERCELLs or three RAAD boxes. METTLER TOLEDO also offers intrinsically safe barriers for use with POWERCELL systems located in hazardous areas. Please contact your METTLER TOLEDO representative for more information about applications in hazardous environments.

IDNET (4)

The IDNET interface allows you to interface a METTLER TOLEDO multi-range base or lab balance with IDNET option with the JAGXTREME terminal. When utilizing this interface, the terminal acts as a "front end" for the base. Setup and calibration of the base is identical to the procedure used by the ID family of indicators. Scale-related information is stored in the scale base as well as the terminal, allowing its access by external devices such as a PLC.

Modbus Plus* (5)

The Modbus Plus interface enables the terminal to directly interface with Modbus Plus devices such as PLCs manufactured by MODICON. The JAGXTREME terminal interface acts as a single Modbus Plus node, which can support up to four scales, and has been fully certified by the Modicon Test Center.

Note: If a single IDNET card is installed, it has to be designated as Scale 1.

*Only one can be loaded into the JAGXTREME terminal.

Allen-Bradley RIO* (6)

This option allows the JAGXTREME terminal to exchange data with an Allen-Bradley PLC like a remote 1771 module on the Allen-Bradley remote I/O. A direct connection to an Allen-Bradley controller is possible via this "blue hose" connection. If the terminal has two or more scales installed, all share the same RIO option board. If multiple terminals are combined in a "cluster" using Ethernet, up to four scales can share the RIO option. Each scale requires one-quarter rack of RIO address space. JAGXTREME terminals support quarter rack addressing.

JAGXTREME terminals support discrete and block transfer modes of data interface. Both are bi-directional. Discrete mode is used for data, status, and command exchange. Block transfer allows more extensive data exchange and allows the PLC to write messages to the terminal's lower alphanumeric display. Connection to the RIO option is made via a detachable three-position terminal strip on the rear of the RIO option.

Multifunction I/O (7)

The Multifunction PCB option expands the number of serial and discrete input and output ports supported by the JAGXTREME terminal. The Multifunction PCB adds two serial ports. COM3 can be used for RS-232 communications. COM4 can be used for RS-232 or RS-422/RS-485 communications. COM4 can be used for a single DigitOL or UltraRes understructure interface. The Multifunction PCB adds eight programmable discrete inputs (PAR 3). Eight programmable discrete outputs (PAR 4). PAR 3 and PAR 4 assignments are user-configurable.

Dual Channel Analog Output* (8)

The Analog Output module provides two channels of analog output, one for each of up to two scales connected to the terminal. The channels may be selected to provide either a 0 to 10 V or a 4 to 20 mA analog output signal. The output is the result of a 16-bit digital to analog conversion.

PROFIBUS Interface* (9)

The JAGXTREME terminal with the PROFIBUS interface module is a fully L2-DP compliant device which can be used with a wide range of PROFIBUS compatible devices. This module provides the process control engineer with the ability to access weight information, status of the scale, and to download a setpoint or tare weight. The Profibus option has been fully certified by the Siemens Profibus Test Center.

Dual Analog Scale (A)

This option is required when interfacing analog-type load cells. A 15-volt excitation voltage is used to power up to 16 350-ohm load cells from one analog channel. The dual channel card can support a maximum of 20 load cells and up to four analog platforms. A jumper is provided to select operation with either 2mV/V or 3mV/V load cells. The terminal will operate with load cells of impedances other than 350 ohms or other mV/V specifications, but the total scale resistance must not be less than 22 ohms.

A quiet analog signal section, combined with an analog-to-digital converter and co-processor that use METTLER TOLEDO TraxDSP filters, provides weighing and vibration rejection performance unequalled in the industry. The zero temperature coefficient is 0.15 uV/degree C. The span temperature coefficient is 6 ppm/degree C.

When using this option, the display update rate is limited to 10 updates per second. The actual A/D conversion rate exceeds 300 cycles per second. The high-speed process allows the terminal to filter out noise while providing a weight update rate up to 50 updates per second for setpoint control and other functions.

*Only one can be loaded into the JAGXTREME terminal.

The dual channel analog scale option board has a removable EEPROM for each scale channel that stores calibration parameters for that scale channel. If an EEPROM is transferred to another board, all calibration parameters transfer as well.

A detachable seven-position terminal strip is used to terminate each analog load cell cable on the rear of the PCB. Signal, excitation, sense, and shield connections are provided with easy-to-read descriptions. Two LEDs are visible through holes in the rear panel of the PCB to indicate the status of the Analog PCB. The terminal supports up to two dual analog scale cards.

Reduced Excitation Dual Analog Scale (B)

This option is used with a protective load cell barrier to permit operation of a JAGXTREME terminal with analog load cells located in an area classified as hazardous by the National Electrical Code. It can support up to four analog platforms. The excitation voltage is lowered to 5 volts. A METTLER TOLEDO Reduced Excitation module is required for these applications. The standard terminal cannot be located inside the hazardous area as is. Purged enclosures are available from METTLER TOLEDO if the terminal must be located inside a hazardous area. The Reduced Excitation module can only support up to 12 analog load cells or a total resistance of 58 ohms. Jumpers are provided to select operation with 2mV/V or 3mV/V load cells. The terminal will operate with load cells of impedances other than 350 ohms or other mV/V specifications, but the total scale resistance must not be less than 22 ohms.

The zero temperature coefficient is 0.15 $\mu\text{V}/\text{degree C}$. The span temperature coefficient is 6 ppm/degree C. When using this option, the display update rate is limited to 10 updates per second. The actual A/D conversion rate exceeds 300 cycles per second. The high-speed process allows the terminal to filter out noise and still provide a weight update rate up to 50 updates per second for setpoint control and other scale functions.

The dual channel analog scale option board has a removable EEPROM for each scale channel that stores calibration parameters for that scale channel. If an EEPROM is transferred to another board, all calibration parameters transfer as well.

A detachable seven-position terminal strip is used to terminate each analog load cell cable on the rear of this PCB. Signal, excitation, sense, and shield connections are provided, each with an easy-to-read description. Two LEDs are visible through holes in the rear panel of this PCB to indicate the status of the Analog PCB. The JAGXTREME terminal will support one or two Reduced Excitation dual analog scale cards.

****CIP Network Interface (ControlNET) (C)**

The CIP network interface enables the JAGXTREME terminal to directly interface with a CIP network (ControlNet or Ethernet/IP). The JAGXTREME terminal interface supports both the ControlNet and Ethernet/IP network protocol utilizing the following types of message:

- Class 1, connected, scheduled messaging
- Connected, unscheduled, explicit messaging, using ControlNet Object, Instance, and Attributes ID's.

** Note: CIP card cannot be used with JXGA models due to ControlNet connector size.

Other Compatible Products

RAAD Box

METTLER TOLEDO's RAAD (Remote Addressable Analog to Digital) junction box is used to transform conventional strain gauge load cell systems into advanced sensor networks. Instead of analyzing the combined signal from every load cell in the system, the RAAD box embeds intelligence into each individual load cell, enabling you to analyze your system at the lowest level. When used with the JAGXTREME terminal, the RAAD box can detect failures immediately to help guard against costly downtime or product waste. The RAAD box can also be used with METTLER TOLEDO's COUGAR terminal.

8624 Remote Display

The METTLER TOLEDO 8624 Remote Display allows an operator to remotely view weight and status with the JAGXTREME terminal. The 8624 connects to the JAGXTREME serial port and can be located remote from the JAGXTREME chassis.

8618 Scoreboard

The METTLER TOLEDO 8618 scoreboard allows an operator to remotely view weight with the JAGXTREME terminal. The 8618 connects to one of the JAGXTREME serial ports and can be located remote from the JAGXTREME chassis.

Printers

METTLER TOLEDO offers a family of reliable printers well suited for industrial applications. The printers connect to one of the JAGXTREME serial ports and can be located remote from the JAGXTREME chassis.

DNB Module

The METTLER TOLEDO DNB module (DeviceNet bridge) allows a PLC to access weigh and status with the JAGXTREME terminal. The DNB module connects to the JAGXTREME serial port and can be located remote from the JAGXTREME chassis.

JAGXTREME Operator Interface (JXOI)

The JXOI is an Ethernet-enabled graphic terminal with object-based programming. It is available in pedestal and panel-mount versions (graphical display only) or a harsh environment terminal version (comprised of a blind JAGXTREME terminal and a graphical display in an enclosure.)

The JXOI features a 1/4 VGA, 240 x 320 pixels, STN color display. It uses a cold-cathode fluorescent backlight (CCFL). The CCFL provides high contrast and easy readability and is replaceable. The contrast is software-controlled and compensated for temperature.

The JXOI comes equipped with one RS-232 serial port with an Ethernet port and a PS/2 keyboard port. It stores the firmware and the user application in a compressed format in flash memory and then transfers them to RAM memory when the JXOI is powered on.

Software

JAGXTREME Operating System

The JAGXTREME operating system is available in four configurations. The configurations define the language of the HTML web pages and are determined by the country finish code of the terminal part number. The available configurations are:

- English/Chinese
- English/French
- English/German
- English/Spanish

JagBASIC

JagBASIC software is standard in the JAGXTREME terminal. JagBASIC is a tool for customizing the JAGXTREME industrial scale terminal. JagBASIC programs reside alongside the standard JAGXTREME terminal program. The JagBASIC interpreter runs as a separate task using the terminal's multi-tasking operating system. This allows the custom JagBASIC program to interact with the other JAGXTREME terminal tasks and resources using the terminal's exclusive shared memory design. For example, to monitor a scale gross weight, the JagBASIC program relates a BASIC variable to the terminal shared data variable for gross weight then uses the BASIC variable as desired. All of the shared memory in the terminal may be accessed by the JagBASIC program using this construct.

The high level of integration permits the programmer to exploit the standard functions in the JAGXTREME terminal, making it easier to implement solid solutions in record time. To print a standard ticket or report, a JagBASIC program can load data into a JAGXTREME terminal shared data variable then print by using a standard template that is designed in the terminal setup. Rather than monitoring setpoint coincidence in the JagBASIC program, a standard setpoint shared data variable can be loaded in the program then monitored by an associated JAGXTREME terminal scale task.

JAGMAX

The optional JAGMAX software enables the JAGXTREME terminal to be used in a truck stop weigh station application. With the JAGMAX software, trucks can be weighed in Idle Mode, Semi-Automatic Mode, and Automatic Mode.

Specifications

Model	General Purpose	Panel Mount	Panel Mount – Blind Chassis	Harsh Environment/Harsh with Graphical Display
Dimensions	10.05 in (255 mm) wide x 7.86 in (200 mm) high x 10.6 in (270 mm) deep	10.05 in (255 mm) x 5.6 in (140 mm) at front of terminal 9.5 in (240 mm) x 4.91 in (125 mm) at the rear 8.03 in (210 mm) deep	10.75 in (270 mm) x 4.91 in (124 mm) at base 10.25 in (260 mm) x 3.91 in (100 mm) c-c mounting 9.5 in (241 mm) x 5.00 in (130 mm) chassis	12.62 in (321 mm) x 9.56 (242.8) x 9.42 (239.3 mm)
Construction	Aluminum			Stainless steel
Mounting Options	Column, desktop	Panel	Blind panel	Wall, column
Degree of Protection	Designed to TYPE 4X standards	Designed to TYPE 4X standards (front panel)	Designed to TYPE 1 standards	CERTIFIED TYPE 4, TYPE 12
Ethernet Connection	10BASE-T. Uses crossover cable from RJ-45 Ethernet port on the back of the JAGXTREME terminal to a PC (point to-point connection) or standard cable to connect to other equipment through a hub.			
Attachable Platforms	4 analog, 4 POWERCELL® 2 IDNET, 2 DigiTOL®, 1 single analog and 1 single IDNET, 1 single analog and 1 DigiTOL, 1 single analog and up to 3 POWERCELLs, 2 analog and 2 POWERCELLs, 1 PC with 1 IDNET and 1 DigiTOL			
Display	Two vacuum fluorescent displays. Upper display: 7 segment 0.5" (13 mm); lower display: 16-character, 5 x 7 dot matrix display 0.25" (6 mm)			
Keypad	4 x 5 matrix tactile-feel keypad with 0-9, letters A-Z, and function keys			
Interfaces	Ethernet, serial, discrete, PLC, analog			
A/D Rate	>300 per second			
Digital Input/Output	Maximum 12 in/12 out			
Maintenance Monitoring	TraxEMT™ Embedded Maintenance Technician system for self-diagnosis and predictive failure analysis			
Signal Processing	TraxDSP® three-stage filtering			
Power Requirements	85 to 264 VAC with a line frequency of 47 to 63 Hz			
Setup	Via embedded web server, with the front keypad or using the JagXFILES tool box.			
Scripting Language	JagBASIC (standard)			
Operating Temperature	14° F to 104° F (-10° C to 40° C) at 10% to 95% relative humidity, non-condensing			
Storage Temperature	40° F to 140° F (-40° C to 60° C) at 10% to 95% relative humidity, non-condensing			
Options	Analog, Dual Analog, Analog Reduced Excitation, Dual Analog Reduced Excitation, Dual Analog Output, Modbus Plus, Profibus, A-B RIO, Multifunction I/O, IDNet, POWERCELL, PCJagBASIC EDITOR, JAGMAX Truck Scale Software, HMI Pedestal or Panel, ControlNet/Ethernet IP			
Approvals	CE Conformity 90/384/EU – Non-automatic Balances and Scales EN45501:1992 – Adopted European Standard 89/336/EU—EMC Directive EN55022, 1998, Class A Weights and Measures (US) Class III or IIII devices NTEP Certificate of Conformance No. 94-096A4 Weights and Measures (Canada) 10,000 division rating and approval AM-5041 Weights and Measures (Australia) Class III and IIII non-automatic weighing instruments as defined in the National Standards Commission, Document 100			

Display and Keypad

Alphanumeric Display (xA)

The JAGXTREME terminal contains two vacuum fluorescent displays and a 4 × 5 matrix tactile feel keypad in a diecast, zinc-aluminum alloy front housing.

The upper weight display is a seven-digit, seven-segment 0.5 in. (13 mm) high vacuum fluorescent numeric display used to indicate weight values. Each of the seven digits has a decimal point/comma and an annunciator associated with it. The annunciators are used to indicate gross or net weights, a preset tare value, pound or kilogram weights, the center of zero, and motion.

The lower display is a 16-character, 5×7 dot matrix, 0.25 in. (6 mm) high vacuum fluorescent alphanumeric display. Each character has a period/comma and an annunciator associated with it. This display is used to indicate tare, alternate weight units, operator prompting, errors and other messages. The first 10 annunciators are used to indicate which terminal number (1 through 6) and internal scale (A-D) are currently displayed. The remainder indicates summation and weighing range.

The lens on both the general purpose and panel-mount models are polycarbonate with hardcoating. The harsh environment model lens is polyester with hardcoating.

The keypad consists of a tactile-feel membrane switch covered with a polyester overlay. Audible beeps sound when a key is depressed. The keypad contains the numbers 0 -9 and the letters A - Z. Other function keys include Escape, Memory, Tare, Select, Clear, space, decimal point, Zero, Enter, and Function.

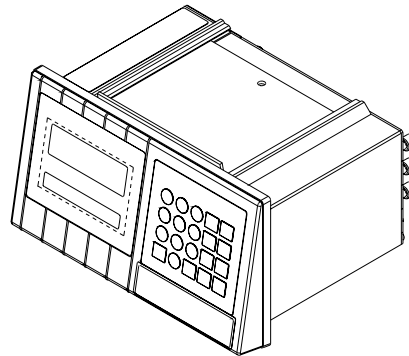

1-a: Display and keypad on panel-mount version of the JAGXTREME terminal

Physical Dimensions

Panel Mount Enclosure—Alphanumeric (PA)

Two integral brackets are used to mount this unit through a flat panel. The front panel and associated panel clamping mechanism are designed to provide a TYPE 4 seal and accommodate a panel thickness from 16 to 11 gauge.

The panel-mount model measures:

- 10.05 in. (255 mm) × 5.6 in. (140 mm) at the front of the terminal
- 9.5 in. (240 mm) × 4.91 in. (125 mm) at the rear
- 8.03 in. (210 mm) deep

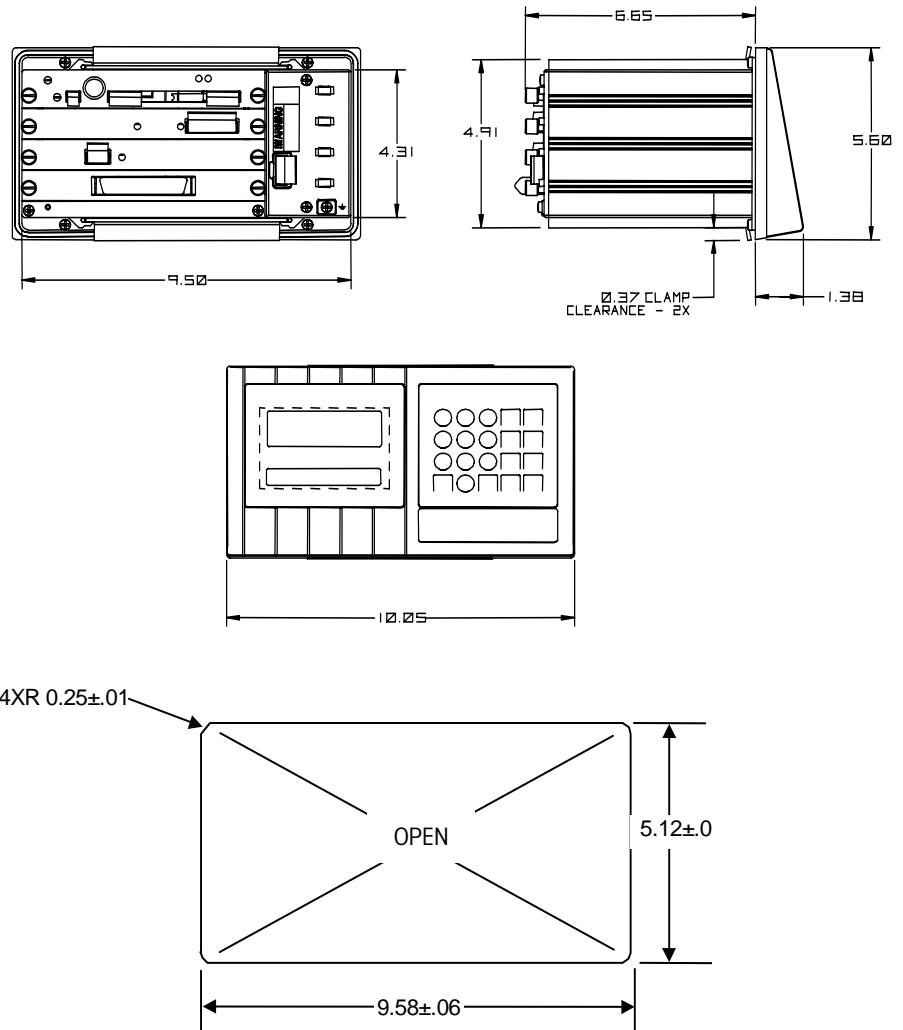

Figure 1-b: JAGXTREME Panel Mount Model and Cutout Dimensions

Panel Mount Enclosure—Blind Chassis (PB)

The front of the panel mount enclosure has a blank plate to cover the electronics and to provide a method of mounting. There is no keyboard or display on the front of the unit. This allows the terminal's use as a "blind" terminal (installed behind a panel,) sharing another JAGXTREME terminal's keyboard and display via the Ethernet connection. The terminal enclosure designed to TYPE 1 requirements with a "blind" front panel.

The blind chassis mount model measures:

- 10.75 in. (270 mm) × 4.91 in. (125 mm) at the base

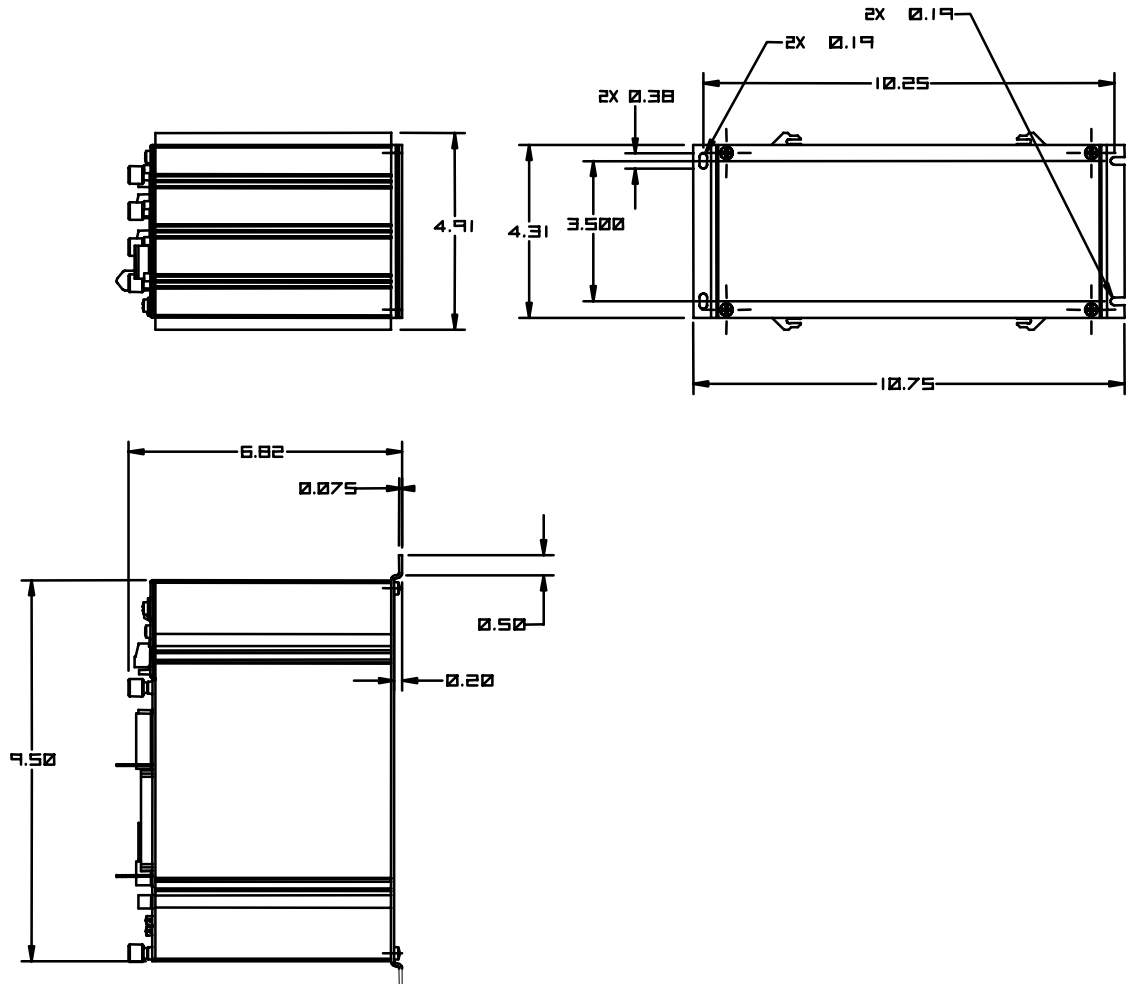

- 10.25 in. (260 mm) × 3.91 in. (100 mm) c-c mounting
- 9.5 in. (241 mm) × 5.00 in. (130 mm) chassis

Figure 1-c: JAGXTREME Blind Chassis Model Dimensions

General Purpose Enclosure (GA)

This enclosure, which is designed to provide TYPE 4X protection, is a die-cast zinc-aluminum alloy with an aliphatic urethane powder-coated finish. The unit is designed to sit on a flat surface or may be wall- or column-mounted with an accessory bracket kit (0917-0209). The rear cover contains grip bushings to seal all cables entering the enclosure.

The general-purpose JAGXTREME terminal model measures:

10.05 in. (255 mm) wide × 7.86 in. (200 mm) high x 10.6 in. (270 mm) deep

In figure 1-d, the top views show optional wall/column brackets (P/N 0917-0209).

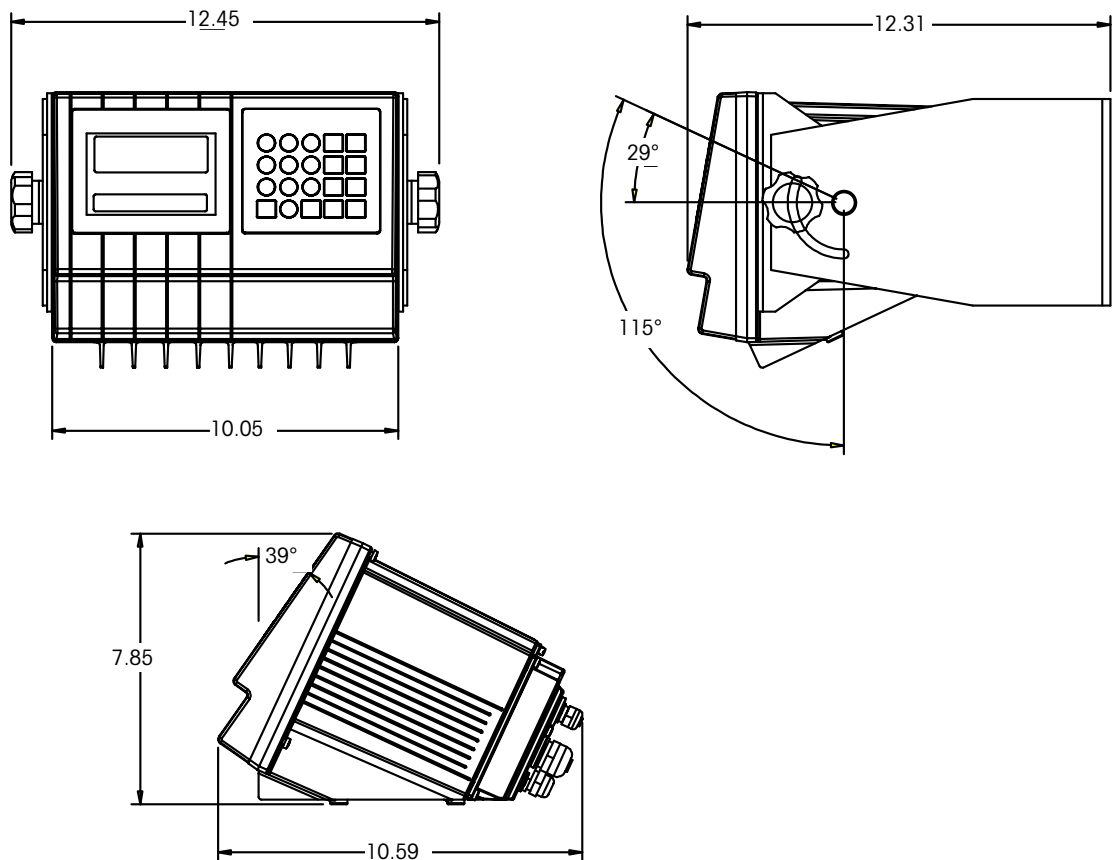

Figure 1-d: JAGXTREME General Purpose Model Dimensions

Harsh Environment Enclosure (HA)

The harsh environment enclosure is designed to provide TYPE 4 and TYPE 12 protection and is intended for applications in which the terminal is exposed to high humidity, direct washdown, or corrosive environments. It is constructed of 304L stainless steel and meets all US FDA and comparable European requirements.

A full 4-slot JAGXTREME terminal chassis is mounted inside the enclosure. All field wiring enters into the unit through cable seals that maintain the washdown protection of the enclosure. The cable seals are located at the bottom rear of the unit. Two brackets are provided for wall mount applications. An interface adapter (0917-0233) is available for column mount applications.

The harsh environment unit measures: 12.62 in (321 mm) x 9.56 (242.8 mm) x 9.42 (239.3 mm)

NOTE: Units sold prior to July, 2001 may have different dimensions. Refer to the previous revision of the JAGXTREME Terminal Technical Manual for information.

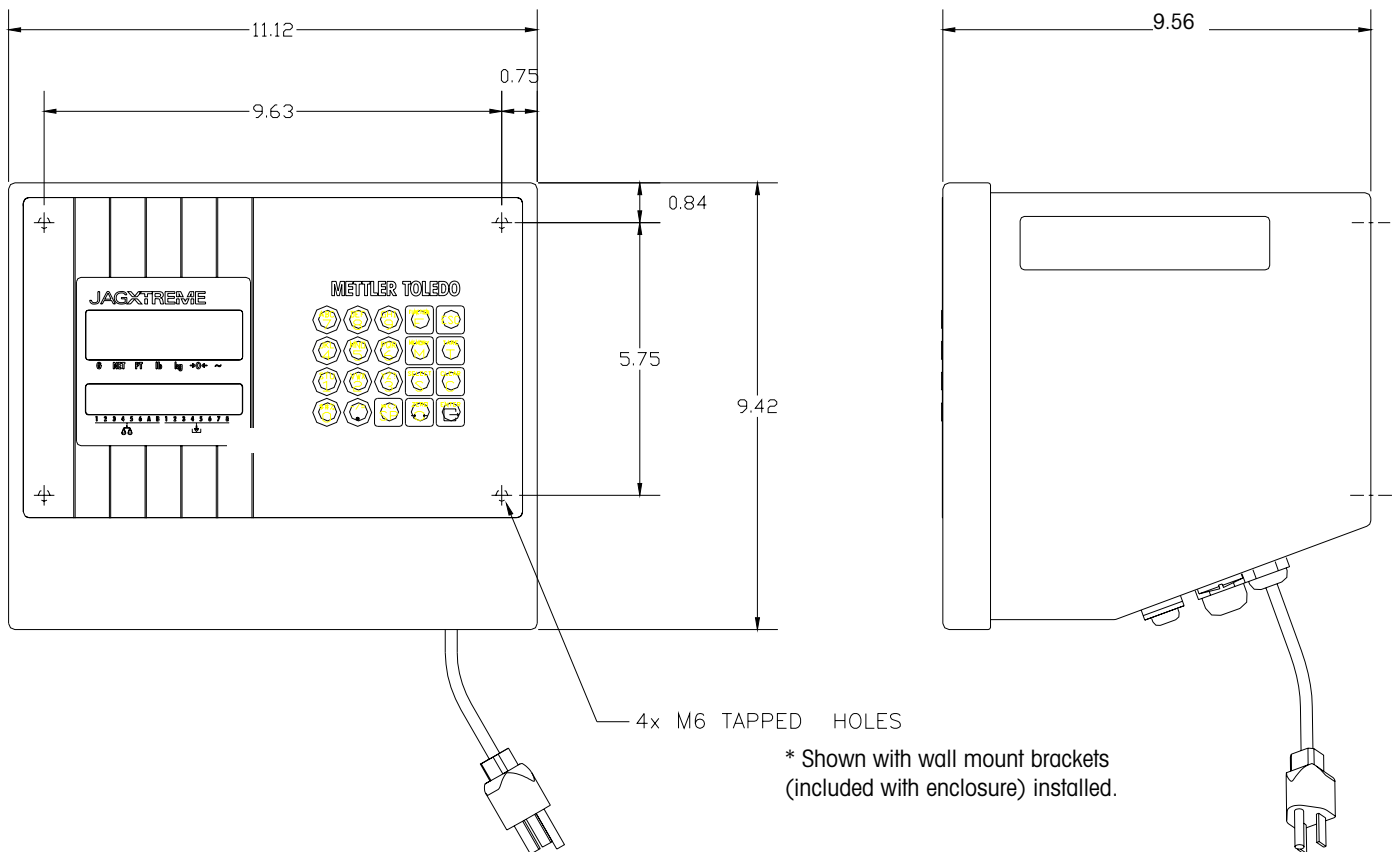

Figure 1-f: Harsh Environment Model Dimensions

Harsh Environment Enclosure (JXHG)

The JXHG (harsh environment enclosure with graphic display) is comprised of a JAGXTREME chassis and a graphical display housed in an enclosure.

Dimensions: 9.42 x 12.62" x 9.56" (239.3 x 321 x 242.8 mm)

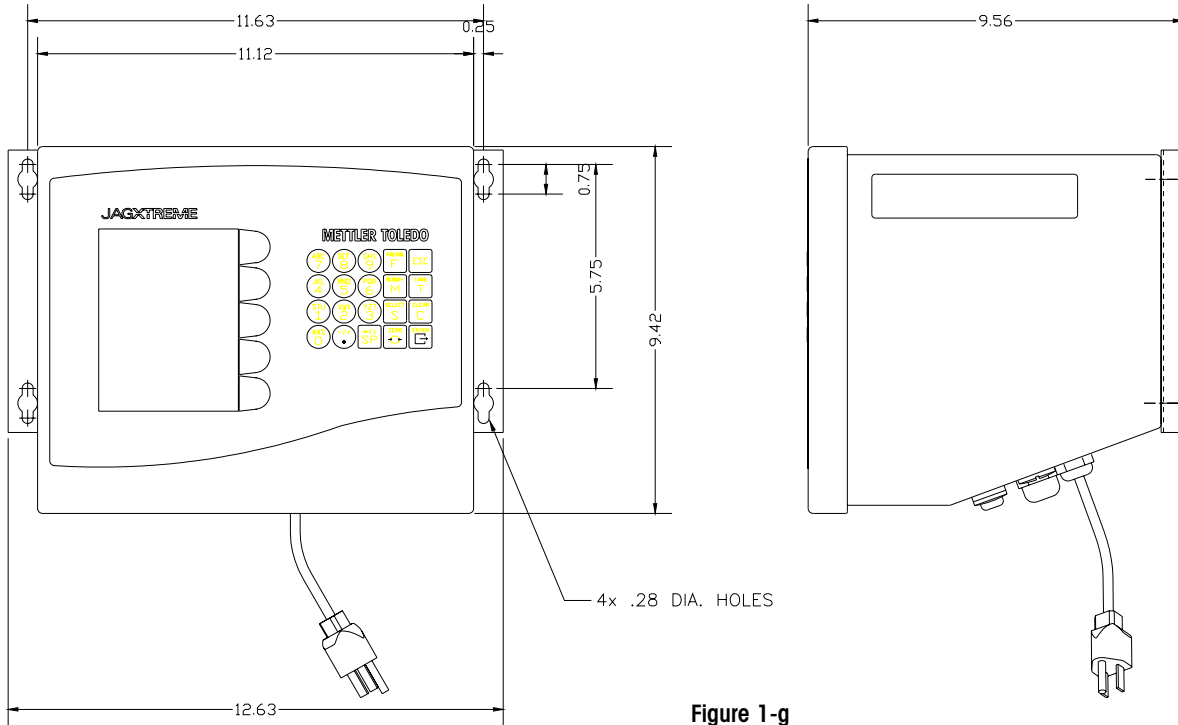

Figure 1-g

Power Requirements

- 85 to 264 VAC with a line frequency of 47 to 63 Hz.
- Power consumption -- 20 Watts maximum.
- Power termination -- single three-position removable terminal strip.
- The wire size range -- 12 to 16 AWG.

Note: The integrity of the power ground for equipment is important for both safety and dependable operation of the JAGXTREME terminal and its associated scale bases. A poor ground can result in an unsafe condition if an electrical short develops in the equipment. A good ground connection is needed to assure extraneous electrical noise pulses are minimized. It is important that equipment does not share power lines with noise generating equipment like heavy load switching, motor starter circuits, RF thermal heaters, inductive loads and the like.

To confirm ground integrity, a commercial branch circuit analyzer is recommended. This instrument uses a high amperage pulse to check ground resistance. It measures the voltage from the neutral wire to the ground connection and will provide an assessment of the line loading. Instructions with the instrument give guidelines about limits that assure good connections.

The power line for the JAGXTREME terminal must not be shared with equipment such as motors, relays, or heaters that generate line noise. If adverse power conditions exist, a dedicated power circuit or power line conditioner may be required.

When a Division 2 approved JagXtreme is installed in an area classified as Division 2 or Zone 2/22, special AC wiring requirements must be met. See document 16088600A, JagXtreme Panel Mount Division 2, Zone 2/22 Installation Guide.

Controller PCB

- Four discrete inputs (PAR1).
- Four discrete outputs (PAR2)(5 to 30 volts DC).
- The output current is 35 mA per discrete output up to 115 mA maximum total current draw on the +5 Volts DC supply.
- Inputs can be defined as clear (return to gross), tare, print, zero, and other keyboard functions.
- Outputs can be defined for coincidence setpoints or a variety of scale conditions.
- The COM1 serial port can be either RS-232 or 20 mA current loop active transmit. Both are available simultaneously.
- The COM2 serial port can be either RS-232 or RS-422/RS-485. This port is also used to support a DigiTOL or UltraRes scale interface.
- Keyboard input is a standard 6-pin PS2 type mini DIN connection for a compatible keyboard.
- The Ethernet network connection uses a RJ45 connection.
- Connections to the Controller PCB are made using four removable terminal strips. The wire size range is 16 to 22 AWG.
- The Controller PCB stores DigiTOL scale calibration parameters in its EEPROM. If analog load cell scale(s) are installed, the calibration parameters for each scale are stored in the EEPROM of the Analog PCB. IDNET calibration parameters are stored in

the base. POWERCELL (or RAAD box) parameters are stored on the POWERCELL PCB.

Temperature and Humidity

- Operating temperature: 14 to 104°F (-10 to 40°C) at 10% to 95% humidity, non-condensing.
- Storage temperature: -40 to 140°F (-40 to 60°C) at 10% to 95% humidity, noncondensing.
- The optional analog PCB zero temperature coefficient is 0.15 $\mu\text{V}/^\circ\text{C}$. Span temperature coefficient is 6 ppm/ $^\circ\text{C}$ maximum.

Environmental Protection

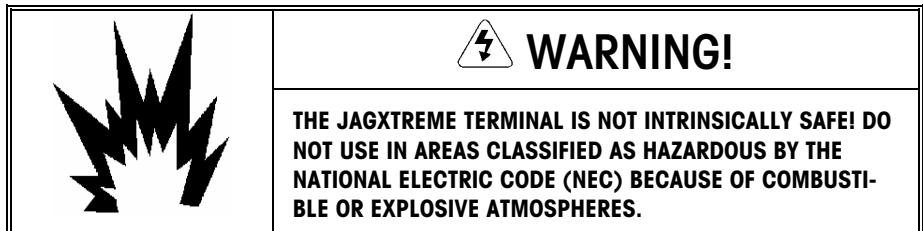

When a Division 2 approved JagXtreme is installed in an area classified as Division 2 or Zone 2/22, special AC wiring requirements must be met. See document 16088600A, JagXtreme Panel Mount Division 2, Zone 2/22 Installation Guide.

Standards Compliance

UL and cUL Listing

The JAGXTREME terminal has been tested and complies with UL 1950 and CSA 22.2 No. 950-M89. The JAGXTREME terminal carries the UL and cUL labels.

Weights and Measures Approvals

United States

The JAGXTREME terminal meets or exceeds requirements for Class III or IIIL devices. Certificate of Conformance No. 94-096A4 was issued under the National Type Evaluation Program of the National Conference on Weights and Measures.

Canada

The JAGXTREME terminal meets or exceeds requirements for a 10,000 division rating and approval AM-5041 has been issued by statutory authority of the Minister of Industry, Science and Technology of Canada.

Australia

The JAGXTREME terminal meets or exceeds the requirements for Class III and IIIL non-automatic weighing instruments as defined in the National Standards Commission,

Document 100. The National Standards Commission has approved the JAGXTREME terminal for use with approved and compatible platforms.

Europe

The JAGXTREME terminal was submitted for approval to The Nederlands Meetinstituut (NMI) in the Netherlands. After evaluation, the JAGXTREME terminal was found to meet and/or exceed the requirements for a Class III weighing instrument. EC type approval certificate TC2618 (Revision 5) was issued by the NMI in accordance to Council Directive 90/384/EEC.

CE Conformity

The JAGXTREME terminal conforms to the following European Union regulations:

- 90/384/EU—Non-automatic Balances and Scales
- EN45501:1992—Adopted European Standard
- 89/336/EU—EMC Directive
- EN55022:1998, Class A

Conducted and Radiated Emissions (RFI)

The JAGXTREME terminal meets or exceeds FCC Part 15 for conducted and radiated emissions requirements as a Class A digital device.

Radio Frequency Interference Susceptibility

The JAGXTREME terminal meets US, Canadian, and European requirements for RFI susceptibility as listed in the following table with a maximum of one display increment of change when calibrated for recommended builds.

Radio Interference Frequency	Field Strength
26-1000 MHz	3 volts/meter

AC Power Line Voltage Variation

The JAGXTREME terminal meets NIST H-44, Canadian Gazette Part 1, and OIML-SP7/SP2 line voltage variation specifications as listed in the following table.

AC Power Line Voltages						
Specification	AC Line Voltage			Line Frequency in Hz		
	Minimum	Nominal	Maximum	Minimum	Nominal	Maximum
NIST H-44	100	120	130	59.5	60	60.5
Canadian	108	120	132	58.8	60	61.2
OIML-SP7/SP2	102	120	132	58.8	60	61.2
	187	220	242	49.0	50	51
	204	264	264	49.0	50	51



For your notes

2

Installation

Overview

The following information provides instructions for installing and wiring the JAGXTREME terminal. This information is also found in the Installation Guide that accompanies the unit. In addition, this chapter provides information on setting the terminal's jumper and switch settings and on installing options.

Unpacking and Inspection

1. If upon delivery the shipping container for the terminal appears damaged, check for internal damage and file a freight claim with the carrier if required.
2. If the container is undamaged, unpack the terminal from its protective package and inspect each component for damage.
3. Verify that you have the correct package contents. To install the terminal, you need the terminal, the screwdriver provided, and these instructions. You may also need common hand tools, such as flat and Phillips head screwdrivers for the general-purpose unit and a drill and wrenches for use with the harsh environment unit. All other package contents should remain in the box.

Package contents for all JAGXTREME terminals include:

- JAGXTREME terminal
- Installation Guide
- Weights and Measures sealing screws
- Mating connectors for the I/O port
- Screwdriver
- Set of capacity labels
- JAGXTREME CD-ROM with documentation and utilities

Package contents for the panel mount and blind chassis JAGXTREME terminal also include:

- Hardware kit (*)15411600A

Package contents for the harsh environment JAGXTREME terminal include:

- 2 stainless steel wall mount brackets
- 4 stainless steel bolts for attaching the wall mount brackets
- Hardware kit (*)15411500A

Package contents for the general purpose JAGXTREME terminal includes:

- Hardware kit (*)15411400A

Standards Compliance

UL and cUL Listing

The JAGXTREME terminal has been tested and complies with UL 1950 and CSA 22.2 No. 950-M89. The JAGXTREME terminal carries the UL and cUL labels.



Environmental Considerations

Temperature and Humidity

- Operating temperature: 14 to 104°F (-10 to 40°C) at 10% to 95% humidity, non-condensing.
- Storage temperature: -40 to 140°F (-40 to 60°C) at 10% to 95% humidity, non-condensing.

Environmental Protection

The JAGXTREME terminal is not intrinsically safe and must not be installed in areas classified as hazardous by the National Electric Code (NEC) unless appropriate hazardous area options provided by METTLER TOLEDO are used and the installation is performed by a qualified service technician.

	 WARNING!
	THE JAGXTREME TERMINAL IS NOT INTRINSICALLY SAFE! DO NOT USE IN AREAS CLASSIFIED AS HAZARDOUS BY THE NATIONAL ELECTRIC CODE (NEC) BECAUSE OF COMBUSTIBLE OR EXPLOSIVE ATMOSPHERES.

When a Division 2 approved JagXtreme is installed in an area classified as Division 2 or Zone 2/22, special AC wiring requirements must be met. See document 16088600A, JagXtreme Panel Mount Division 2, Zone 2/22 Installation Guide.

Power Considerations



- 85 to 264 VAC with a line frequency of 47 to 63 Hz.
- Power consumption -- 20 Watts maximum.
- Power termination -- single three-position removable terminal strip (panel mount)
-- integral power cord (general purpose, harsh)
- The wire size range -- 12 to 16 AWG.

The integrity of the power ground for equipment is important for safety and for the dependable operation of the terminal and its associated scale bases. A poor ground can result in an unsafe condition if an electrical short develops in the equipment. A good

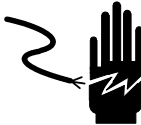

ground connection is needed to assure extraneous electrical noise pulses are minimized. The power line for the terminal must not be shared with equipment such as motors, relays, or heaters that generate line noise. If adverse power conditions exist, a dedicated power circuit or power line conditioner may be required.

To confirm ground integrity, a commercial branch circuit analyzer is recommended. This instrument uses a high amperage pulse to check ground resistance. It measures the voltage from the neutral wire to the ground connection and will provide an assessment of the line loading. Instructions with the instrument give guidelines about limits that assure good connections.

	 WARNING!
	USE ONLY THE POWER CORD SUPPLIED OR AN EQUIVALENT TYPE. U.S. MODELS USE UL APPROVED TYPE SJT CORD; EC MODELS USE HARMONIZED APPROVED TYPE H05VV-F CORDS.

	 WARNING!
	IMPROPER INSTALLATION OF THE POWER CABLE WILL RESULT IN PERSONAL INJURY AND/OR DAMAGE TO THE EQUIPMENT. THE HOT WIRE MUST BE APPLIED TO "L", NEUTRAL TO "N" AND GROUND TO \perp



 CAUTION	
FOR PANEL MOUNT INSTALLATIONS:	
<ul style="list-style-type: none">• INCLUDE A POWER DISCONNECT SWITCH IN AC POWER WIRING.• SWITCH MUST BE WITHIN 10 FEET (3 METERS) AND EASILY ACCESSIBLE TO OPERATOR.• SWITCH MUST BE CLEARLY IDENTIFIED AS DISCONNECT FOR TERMINAL POWER.• SWITCH AND/OR CIRCUIT BREAKER MUST COMPLY WITH APPROPRIATE ELECTRICAL CODES (FOR EC—IEC947).	
FOR DESK/WALL INSTALLATIONS:	
<ul style="list-style-type: none">• POWER CORD PLUG MUST BE CLEARLY IDENTIFIED AS DISCONNECT FOR TERMINAL POWER.• POWER CORD MUST BE PLUGGED INTO OUTLET WITHIN 10 FEET (3 METERS) AND EASILY ACCESSIBLE TO OPERATOR.	



	 CAUTION
	DO NOT APPLY AC POWER TO THE JAGXTREME TERMINAL. POWER SHOULD NOT BE APPLIED UNTIL ALL INTERNAL WIRING HAS BEEN COMPLETED BY A QUALIFIED SERVICE TECHNICIAN.



Connecting to the JAGXTREME Terminal

Connecting the Load Cell

Make the load cell connection to the Controller PCB (DigiTOL scales), the optional Analog A/D PCB (analog load cells), or the POWERCELL I/O PCB, following the instructions provided here.

	 WARNING!
	<p>IF AN ANALOG SCALE IS TO BE USED AND IT WILL BE LOCATED IN A HAZARDOUS (EXPLOSIVE) AREA, SPECIAL PRECAUTIONS MUST BE TAKEN. LOAD CELLS APPROVED FOR USE IN HAZARDOUS LOCATIONS MUST BE USED AND A LOAD CELL BARRIER AND/OR A LOW VOLTAGE ANALOG PCB MAY BE REQUIRED. CONTACT YOUR AUTHORIZED METTLER TOLEDO REPRESENTATIVE FOR DETAILS ON EACH SPECIFIC APPLICATION.</p>

	 CAUTION
	<p>TO AVOID DAMAGE TO THE PCB OR LOAD CELL, REMOVE POWER FROM THE JAGXTREME TERMINAL AND WAIT AT LEAST 30 SECONDS BEFORE CONNECTING OR DISCONNECTING ANY HARNESS.</p>

	 CAUTION
	<p>DO NOT ATTACH AN ANALOG LOAD CELL TO THE DIGITOL SCALE INPUT ON THE CONTROLLER PCB COM2. DO NOT ATTACH A DIGITOL SCALE TO THE ANALOG LOAD CELL INPUT ON THE OPTIONAL ANALOG A/D PCB. DOING SO MAY RESULT IN DAMAGE TO THE LOAD CELL OR PCB.</p>

Analog Load Cell Connections

The maximum cable length for analog load cell connections to the terminal depends on the total scale resistance (TSR) of the scale base. To calculate TSR:

$$TSR = \frac{\text{Load Cell Input Resistance (Ohms)}}{\text{\#Load Cells}}$$

The chart below gives recommended cable lengths based on TSR and cable gauge.

Recommended Maximum Cable Length			
TSR (Ohms)	24 Gauge* (feet/meters)	20 Gauge (feet/meters)	16 Gauge (feet/meters)
350	800/243.84	2000/609.6	4000/1219.2
87	200/60.96	600/182.88	1000/304.8
58	100/30.48	300/91.44	500/152.4
35	70/21.336	190/57.91	350/106.68

The following diagrams describe analog load cell terminal strip wiring for standard 6-wire cable and standard 4-wire cable.

Standard 6-wire Cable

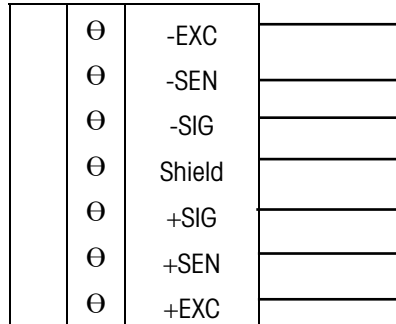

4-wire Cable

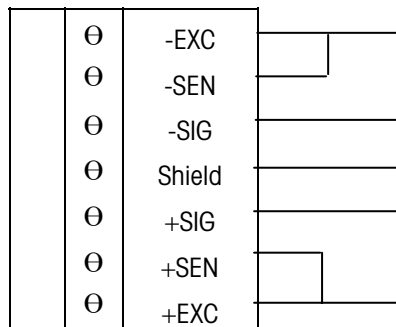

* If an increase in load results in a decrease in weight display, reverse the signal wires (+SIG and -SIG).

UltraRes and DigiTOL Load Cell Connections

The maximum recommended cable length for all DigiTOL bases is 50 feet (15 meters). The following diagram describes DigiTOL load cell terminal strip wiring.

JAGXTREME Terminal COM2 or COM4*

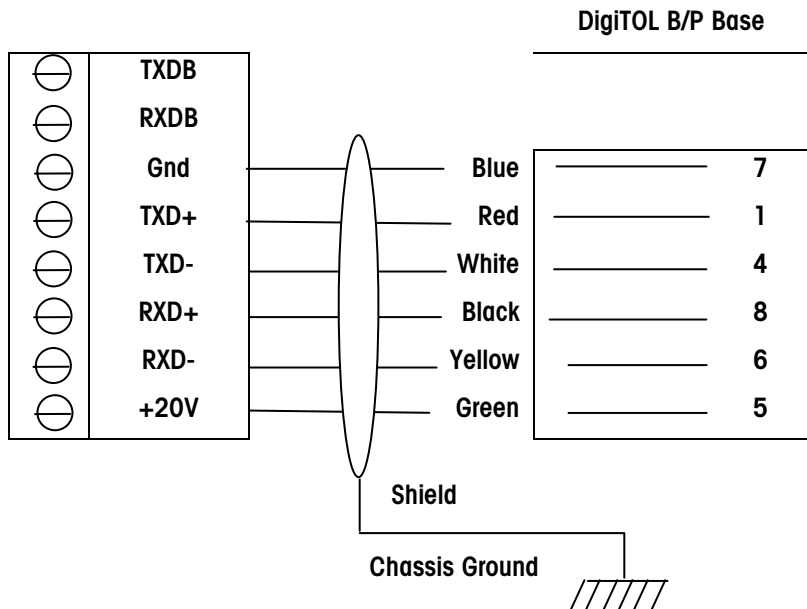

*When interfacing a DigiTOL or UltraRes base to COM4 (available on the optional Multifunction PCB), W2 must be set for 20V.

Enhanced DigiTOL J-Box Connections

Use the following table to determine the cable gauge and recommended distance between the JAGXTREME terminal and the Enhanced DigiTOL J-Box.

Cable Gauge	Cable Distance	Part Number
6 cond. 24 AWG	Up to 150 feet (45.72 meters)	510624370 or 14264100A
*6 cond. 20 AWG	Up to 300 feet (91.44 meters)	510620370

*6 conductor 16 AWG cable can also be used. The maximum cable distance remains 300 feet (91.4 meters).

The following diagrams describe DigiTOL terminal strip wiring.

**JAGXTREME Terminal
COM2 or COM4***

Enhanced DigiTOL J-Box

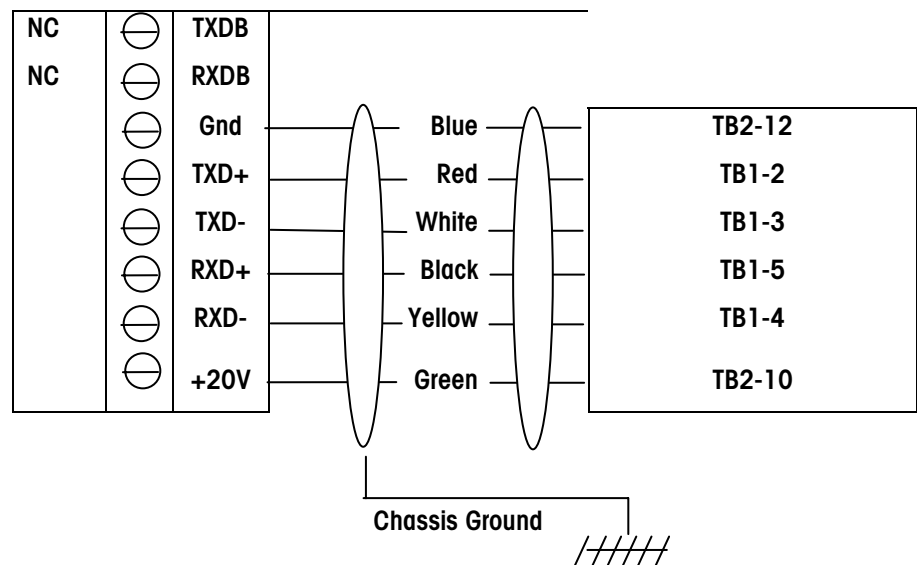

POWERCELL Connections (Non-Hazardous Area POWERCELL Applications)

Recommended maximum cable distance is 900 feet (274.32 meters) for all non-hazardous applications regardless of the number of cells (16 or 20 gauge wire). The following shows the connection to a RAAD box, MTX, or CMOS J-Box.

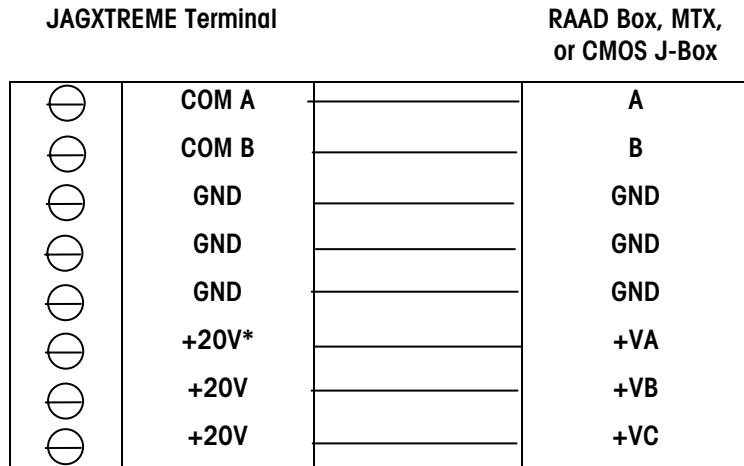

External power connector Pin 1 is +V and Pin 2 is ground.

POWERCELL Connections to DigiTOL Scales with NMOS POWERCELLS and Pit Power Supplies

For applications in which the POWERCELL PCB is connected to a DigiTOL Scale with NMOS POWERCELLS, the JAGXTREME terminal must be wired with the auxiliary power supply (P/N 0917-0168 for 100/110/120 VAC operation, 0917-0169 for 220/240 VAC operation).

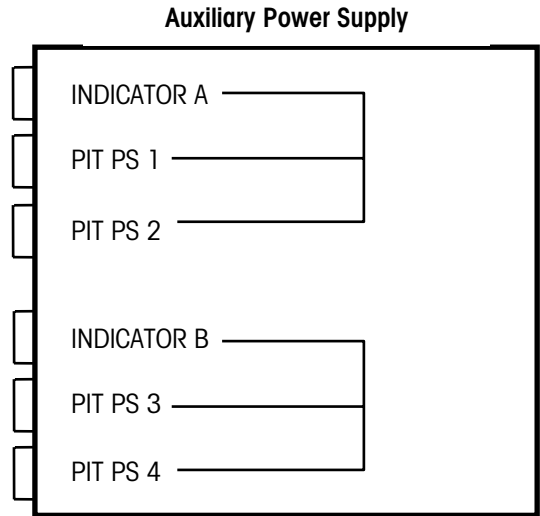

The purpose of the auxiliary power supply is to provide two identical circuits, each with a 24 VDC power supply output capable of driving up to two pit power supplies. Each pit power supply can drive a maximum of 12 load cells. As shown above, the INDICATOR A and B inputs are connected to the pit PS outputs. The two circuits are completely isolated. The only exception is the same 24 VDC power supply output being used for pit PS1 and 3. The second 24 VDC supply is shared between pit PS2 and 4.

If only one channel is needed, INDICATOR A must be used.

The W1 jumper is located on the printed circuit board in the auxiliary power supply. The W1 jumper enables and disables the circuit that senses voltage at the INDICATOR B

input. If this circuit is enabled (W1 removed) and input voltage at pin 5 of both INDICATOR A and B is not present, the 24 VDC output at pit PS 1, 2, 3, and 4 will be turned OFF. If only the INDICATOR A input is being used, jumper W1 must be inserted shorting both pins.

Connect the JAGXTREME terminal to the auxiliary power supply as follows:

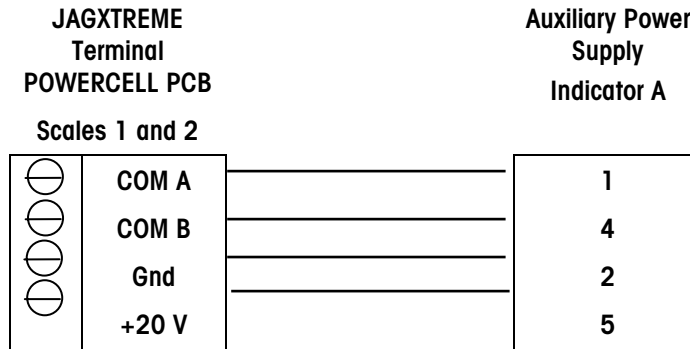

If a second JAGXTREME terminal exists, the interface cable between the second terminal and the auxiliary power supply would be wired the same. However, the interface cable would plug into the auxiliary power supply at INDICATOR B. The W1 jumper on the auxiliary power supply **must not** be shorting the two pins together.

Replacing an Existing 8146 or 8530 on a DigiTOL Scale having an Auxiliary Power Supply and Pit Power Supply(s)

Wire the JAGXTREME terminal POWERCELL PCB to the auxiliary power supply as shown previously. The home-run cables plugged into pit PS 1, 2, 3, or 4 can be left as is.

Replacing an Existing 8530 on a DigiTOL Scale with a Pit Power Supply and not having an Auxiliary Power Supply

An auxiliary power supply must be supplied. Wire the JAGXTREME terminal POWERCELL PCB to the auxiliary power supply as shown previously. Plug the home-run cable from the 8530 into pit PS 1.

Replacing an Existing 8146 or 8530 on a DigiTOL Scale if a Second Scale Is Present

The POWERCELL PCB should be programmed for two scales (Scale 1 + Scale 2 = 24 load cells maximum). The home-run cable(s) should be plugged into pit PS 1 (and pit PS 2 if a second home-run cable exists).

Replacing an Existing 8146 or 8530 on a DigiTOL Scale if a Third Scale Is Present

The first JAGXTREME terminal with a POWERCELL PCB should be wired as indicated previously. The second terminal with a POWERCELL PCB should be wired into INDICATOR B of the auxiliary power supply and the home-run cable going to the third scale should be plugged into pit PS 3 or 4.

Home-Run POWERCELL PCB Cable Maximum Length

The maximum cable distance from the pit Power Supply to the JAGXTREME terminal POWERCELL PCB depends on the number of POWERCELLs, home-run cable gauge,

Shield wire must be connected to chassis ground or "GND" terminal at the JAGXTREME terminal end for reliable operation.

You can purchase this adapter harness (0900-0284) or cut the base cables and wire directly to the terminals.

and the AC power voltage level. Use the following table to determine the cable gauge and recommended cable distance:

Number of RAAD Boxes	Number of CMOS or MTX Cells	Home-Run Cable Distance	
		20 Gauge (Feet/Meters)	16 Gauge (Feet/Meters)
1	4	900/274	900/274
2	6	712/217	900/274
2	8	475/144	900/274
3	10	332/101	878/267
3	12	237/72	644/196

High Precision Base Cable Connections

The maximum recommended cable length for IDNET bases is 300 feet (90 meters.)

The following diagram describes IDNET cell terminal strip wiring.

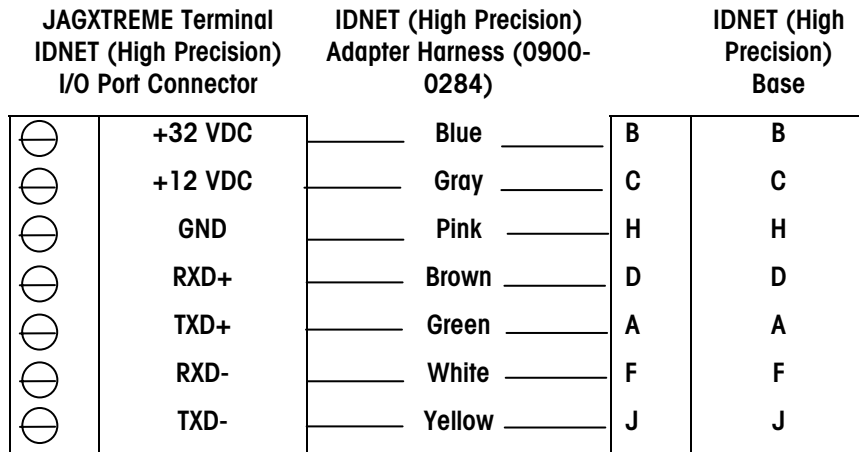

Serial Port Connections Controller PCB

Note: Keyboard wedges and other non-keyboard devices are not supported.

Refer to the following diagrams for proper cable connections to the JAGXTREME terminal's serial ports COM1 and COM2. COM1 and COM2 are located on the Controller board, which is positioned in the top slot.

The COM1 and COM2 terminal strips will accommodate wire sizes from 16 to 22 AWG. The terminal strips may be removed to facilitate wiring. Removal of the terminal strips permits easier viewing of the terminal designations printed on the board back plate.



For enclosures using the pass-through cable grips, you must pass the cable through the grip, grommet, and housing before wiring to the connector.

COM1 20 mA (Controller PCB Serial Port)

The following diagram and table describe COM1 pin-to-pin cable connections using a 20 mA loop. The maximum recommended cable length for 20 mA interfacing is 1000 feet (300 meters).

JAGXTREME Terminal COM1

⊖	TXDA	
⊖	RXDA	
⊖	Gnd	Signal Ground (Active Current Loop Transmit -)
⊖	CLTX+	Active Current Loop Transmit +
⊖	CLRX+	Current Loop Receive +
⊖	CLRX-	Current Loop Receive -

JAGXTREME Terminal COM1	8860	8623	8614 8616 8619	8618 9323 9325
TXDA	—	—	—	—
RXDA	—	—	—	—
GND	18	10	12	9
CLTX+	16	8	11	8
CLRX+	—	—	—	—
CLRX-	—	—	—	—

COM1 RS-232 (Controller PCB Serial Port)

The following diagram and table describe COM1 pin-to-pin cable connections using an RS-232 cable. Maximum recommended cable length is 50 feet (15 meters).

JAGXTREME Terminal COM 1

⊖	TXD	RS-232 Transmit
⊖	RXD	RS-232 Receive
⊖	GND	Signal Ground
⊖	CLTX+	
⊖	CLRX+	
⊖	CLRX-	

Pin Connection for METTLER TOLEDO Devices Using COM1 RS-232					
JAGXTREME Terminal COM1	8863	8846 8867	8806 8807 8808 8845 8856 8857 8860 8861 8865	9323-TB2 9325-TB2 8624	8618
TXDA	3	2	3	2	InputCom
RXDA	2	3	2	—	—
GND	5	7	7	3	RS232 Input
CLTX+			—	—	—
CLRX+			—	—	—
CLRX-			—	—	—

COM2/COM4 RS-232 (Controller PCB Serial Port)

The following describes COM2 pin-to-pin cable connections using an RS-232 cable and the connections to COM4 when an optional Multifunction I/O PCB is installed. The maximum recommended cable length for RS-232 is 50 feet (15 meters). Maximum recommended total distance for RS-422 and RS-485 is 2000 feet (600 meters).

JAGXTREME Terminal COM2/COM4

The COM4+20 V terminal voltage output is determined by the W2 jumper on the Multifunction I/O PCB.

⊖	TXD	RS-232 Transmit
⊖	RXD	RS-232 Receive
⊖	GND	Signal Ground
⊖	TXD+	RS-422/485 Transmit +
⊖	TXD-	RS-422/485 Transmit -
⊖	RXD+	RS-422/485 Receive +
⊖	RXD-	RS-422/485 Receive -
⊖	+20 V	+20 VDC Supply

Pin Connection for METTLER TOLEDO Devices Using COM2 RS-232/RS-485							
JAGXTREME Terminal COM2	8806	8807	8808	8846	8863	8617-TB2 9323-TB2 9325-TB2	8618
	8844	8845	8857	8867			
	8861	8865					
TXDB		3		2	3	2	—
RXDB		—		3	2	—	—
GND		7		7	5	3	—
TXD+		—				—	RS-485B
TXD-		—				—	RS-485A
RXD+		—				—	—
RXD-		—				—	—
+20 V		—				—	—

Discrete Wiring

For more information see the section entitled Inputs in Appendix 2 at the back of this manual.

For more information see the section entitled Outputs in Appendix 2 at the back of this manual.

The Controller PCB contains four discrete input and four discrete output connections.

PAR 1 Input Connections

The input connections must be referenced to ground. A switch or relay contact may be used to make this connection. The remote device should hold the input at logic ground for at least 100 ms. Scale functions are performed when the input is held to ground (leading edge triggered). The maximum recommended cable length between the remote device and the JAGXTREME terminal is 10 feet (3 meters).

Each of the four PAR 1 inputs can be configured for different remote inputs including input from the keypad for remote print, unit switching, alternate scale selection, or template selection. Polarity (switch to ground or open a ground connection to initiate remote input) can also be selected.

PAR 1 Terminal

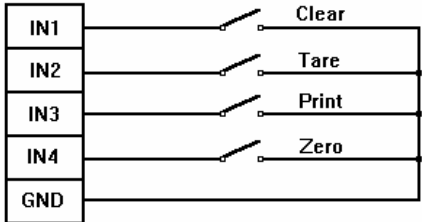
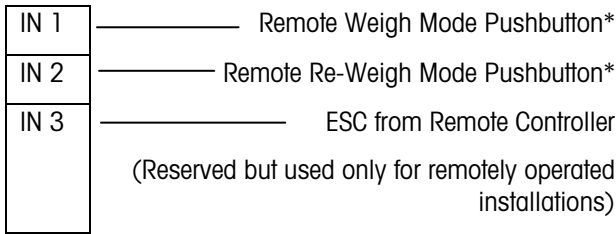

Figure 2-g: Input Wiring Example

When the JagMAX software is used, the terminal reserves inputs one and two for use with the optional traffic light controller. The terminal reserves input three for an optional pushbutton to return the terminal to local control. (Used only remotely operated installations.)



*See optional traffic light controller wiring diagram.

Figure 1-r: Input Wiring Example

PAR 2 Output Connections

Each of the four PAR 2 outputs can be configured to announce Setpoints 1 through 12 coincidence. The 12 setpoint outputs can be configured to request either Feed or Fast Feed, or announce setpoint tolerance status. The standard number of outputs is 4. Eight additional outputs are available if a multifunction PCB is installed.

PAR 2 outputs can be configured to announce "current scale status" conditions such as:

- Net or Gross Mode
- Motion
- Under Zero
- Gross Zero
- Over Capacity

Outputs are negative-true, open collector type.

PAR 2 outputs can be referenced to the 5 volt supply available on the PAR2 connector or can sink up to 35 mA of current and have a maximum voltage of 30 volts DC from an external source. The maximum cable length between the remote device and JAGXTREME terminal is 10 feet (3 meters).

PAR 2 Terminal

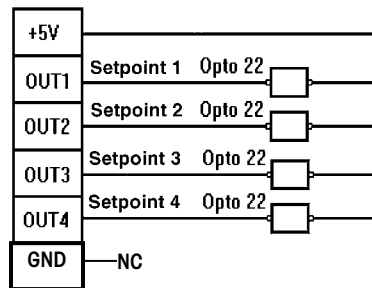

Output Wiring Example

JAGXTREME PAR 2		PLC Sourcing Input Card
+5V	- NC	
OUT1		IN1
OUT2		IN2
OUT3		IN3
OUT4		IN4
GND		GND

PLC Input Wiring Example

Optional JagMAX Software

When using the optional JagMAX software, the terminal reserves the first three outputs for use with the optional traffic light controller, and the fourth is reserved to indicate the center of zero for the summation scale for Canadian applications.

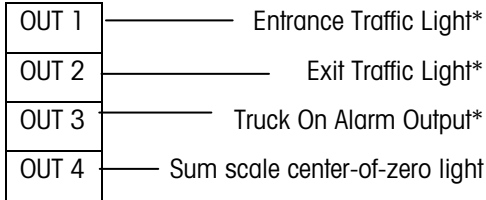

*See optional traffic light controller wiring diagram.

Figure 1-s

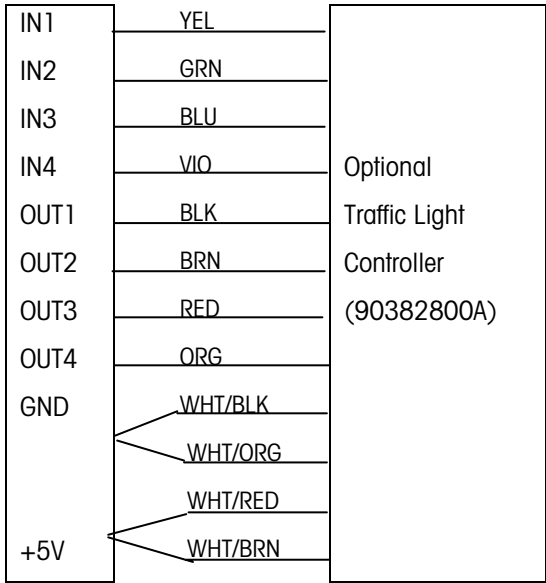

Traffic Light Controller Wiring Diagram

Optional Multifunction I/O PCB Serial and Discrete Connections



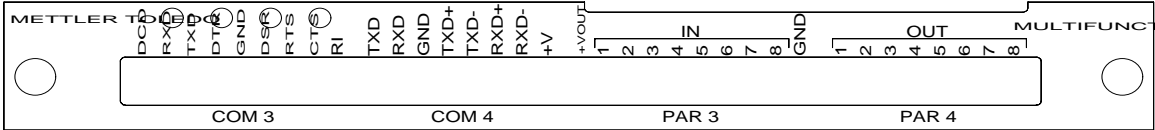





This section gives proper cable connections to COM 3, COM 4, PAR 3, AND PAR 4 which are located on the optional Multifunction I/O PCB.



COM3 Interconnect Wiring

COM3 supplies all inputs and outputs to allow full handshaking and modem interfacing. The COM3 port is only available with the optional Multifunction PCB. When interfacing COM3 to devices other than those listed for COM2 RS-232, refer to the documentation for the particular device for handshaking needs and suggested wiring. The following general interconnect options are offered for the 9 and 25 pin connectors.

COM3 With Full Handshaking

COM3		DB25	DB9	DCE
	DCD	—	—	
	RXD	2	2**	**This connection is only required for devices that input data to the terminal, such as devices that send ASCII "C, T, P, Z, or U".
	TXD	3	3	
	DTR	6	6	
	GND	7	5	
	DSR	20	4	
	RTS	5	8	
	CTS	4	7	
	RI	—	—	

COM4 Interconnect Wiring

The wiring instructions for the COM2 serial port apply to COM4 on the Multifunction PCB. Refer to the section presented earlier entitled COM2/COM4 RS-232 (Controller PCB Serial Port) to interface COM4 to DigiTOL scales and printers.

PAR 3 Discrete Input Port

Each of the eight PAR 3 inputs can be configured for different remote inputs including input from the JAGXTREME keypad (Tare, Clear, Zero, Select, Escape, and Enter). PAR 3 inputs can also be configured for remote print, unit switching, alternate scale selection, or template selection. Polarity (switch to ground or open a ground connection to initiate remote input) can also be selected.

The wiring instructions for the PAR 1 discrete inputs apply to PAR 3 on the Multifunction PCB. Refer to the section entitled PAR 1 Input Connections for wiring details.

PAR 4 Discrete Output Port

Each of the eight PAR 4 outputs can be configured to announce Setpoints 1 through 12 coincidence. The 12 setpoint outputs can be configured to request either Feed or Fast Feed, or to announce setpoint tolerance status. PAR 4 outputs can also be configured to announce "current scale status" conditions such as:

- Net or Gross Mode
- Gross Zero

- Motion
- Over Capacity
- Under Zero

The +VOUT terminal supplies a jumper selectable voltage of +5, +12, or +20 VDC.

The wiring instructions for the PAR 2 discrete outputs apply to PAR 4 on the Multifunction PCB. Please refer to the section entitled PAR 2 Output Connections for wiring details.

Connecting the Power Cable

A power cord is provided with the general purpose and harsh environment JAGXTREME terminals. Connection to the panel mount JAGXTREME terminal must be made at installation. The AC power connection must be wired as follows for harsh and general-purpose models:

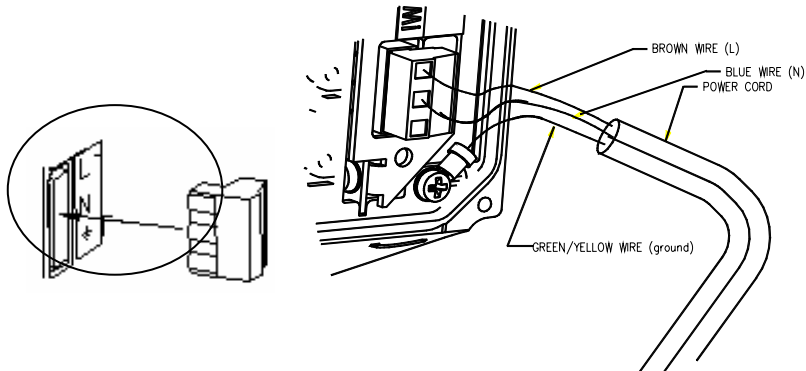

Note: Some regions and/or power cords may use different color codes than shown.

Power Connection for Harsh and General Purpose Terminal

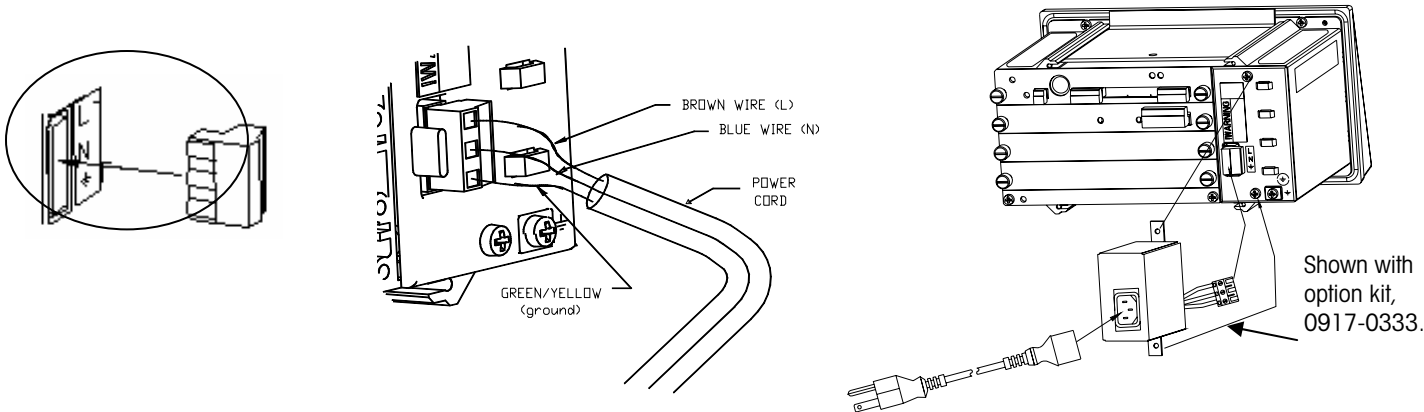

Power Connections for Panel-Mount Terminal and Blind Panel-Mount Terminal

The terminal strip will accommodate wire sizes from 12 to 16 AWG. The wire size used must meet all local and national electrical codes. On panel-mount models, you must secure the wiring with a cable tie as a strain relief. Cable ties are supplied loose. If the power terminal strip is removed from the terminal, reinsert it until it is completely seated in the jack at the rear of the enclosure.

An auxiliary chassis ground screw is located at the lower right corner of the power supply cabinet. This ground connection is provided for surge voltage protection applications and for chassis ground. On panel mount models (JXPx) you must connect a safety ground to this screw.

Installing the General Purpose Model

Dimensions:

- 10.05 in. (255 mm) wide x 7.86 in. (200 mm) high
- 10.6 in (270 mm) deep

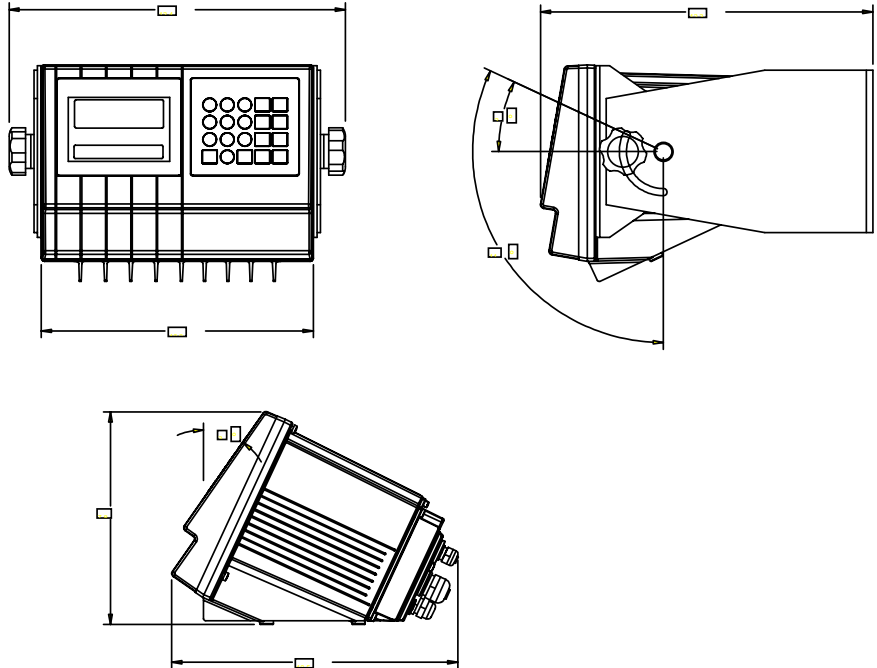

1. Place the terminal at the operating site. Refer to the illustrations on this page and the next when following the directions provided here.
2. Remove the four screws securing the rear access cover to the main housing using a Phillips head screwdriver.
3. With the rear access cover removed, you can now make connections to the unit. (Refer to the illustration and table below for suggested wire connections.)
4. Pass the cables that enter the enclosure through an appropriately sized cable grip before connecting the wires.
5. Tighten the cable grip to provide a water-tight seal around the cable after re-securing the back cover. This allows any internal cable slack to be received through the cable grip.
6. Connect a PS/2 type keyboard, if desired, using an optional external keyboard connector kit.

7. You can now make the electrical connections.

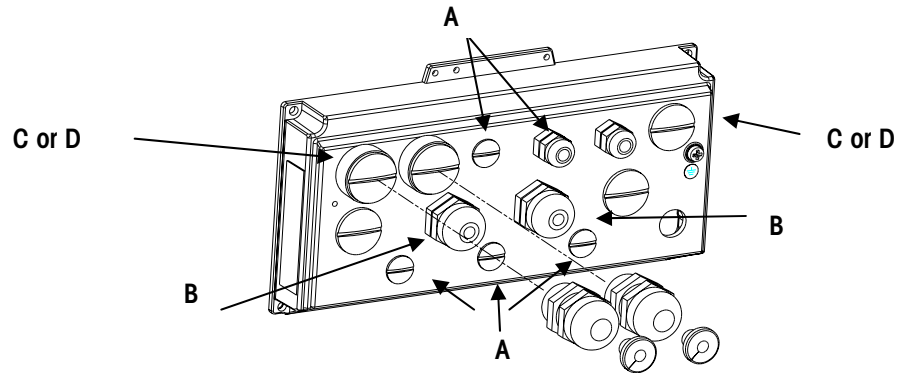

Reference Letter	Suggested Cable
A	Serial I/O Cables (Except DigiTOL) PLC I/F Cabling
B	Analog Load Cell Cabling DigiTOL Load Cell Cabling
C	Ethernet RJ-45 Category 5
D	QWERTY PS/2

General Purpose Model Wiring Connections and Cable

To make keyboard and/or Ethernet connections to the general-purpose model, follow these steps:

1. Remove the plugs from the back of the JAGXTREME terminal.
2. Remove the cap from the grip bushing assembly (supplied in the shipping kit that accompanies the harsh environment and general purpose JAGXTREME terminals).
3. Route the cable end through the cap of the grip bushing.
4. Route the cable end through the grip bushing.
5. Assemble the bushing to the appropriate hole in the access cover.
6. Plug in the cable to the appropriate port (Ethernet or keyboard) on the JAGXTREME terminal.
7. Reassemble the access cover to the JAGXTREME terminal.
8. Tighten the grip bushing cap to the grip bushing.

Installing the Panel Mount Model

Dimensions (Panel Mount):

- 10.05 in. (255 mm) x 5.6 in. (140 mm) at the front of the terminal
- 9.5 in. (240 mm) x 4.91 in. (125 mm) at the rear
- 8.03 in. (210 mm) deep

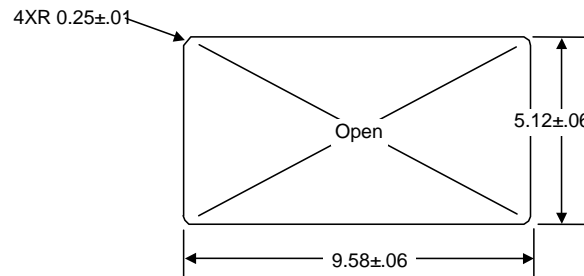
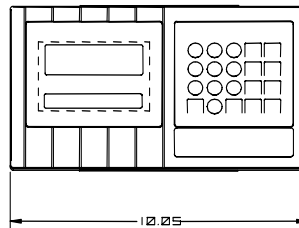
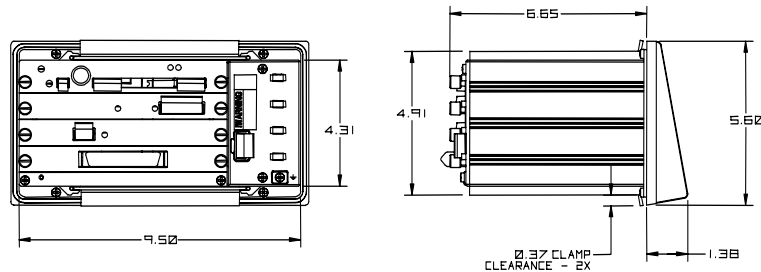

1. Refer to the illustrations provided.
2. Cut an opening 9.58 in. (243.3 mm) × 5.12 in. (130 mm) to accommodate the terminal. The tolerance for the panel cutout is ± 0.06 in. (0.15 cm).
3. Using the Allen wrench included, remove the four retaining set screws (A) located at the rear of the enclosure in the top and bottom mounting plate grooves.
4. Remove both mounting plates (B).
5. Insert the terminal through the panel opening from the front until it is flush against the panel. Confirm that the terminal is installed right side up.
6. Slide the top and bottom mounting plates back in the grooves. Push them flush against the panel from the back. The flared end of the plate should contact the back of the panel.
7. Holding the unit in place, replace the four set screws and tighten until the unit is secured and the front panel gasket is compressed.
8. Inspect the front of the terminal for a good seal to the front of the enclosure.

9. You can now make the electrical connections. (Ethernet and keyboard connections can be made directly to the Controller PCB.)

Installing the Blind Panel Mount Unit

Panel Mount Enclosure—Blind Chassis (PB)

The front of the panel mount enclosure has a blank plate to cover the electronics and to provide a method of mounting. There is no keyboard or display on the front of the unit. This allows the terminal's use as a "blind" terminal (installed behind a panel,) sharing another JAGXTREME terminal's keyboard and display via the Ethernet connection. The terminal enclosure has a NEMA 1 or IP30 rating with a "blind" front panel.

The blind chassis mount model measures:

- 10.75 in. (270 mm) × 4.91 in. (125 mm) at the base
- 10.25 in. (260 mm) × 3.91 in. (100 mm) c-c mounting
- 9.5 in. (241 mm) × 5.00 in. (103 mm) chassis

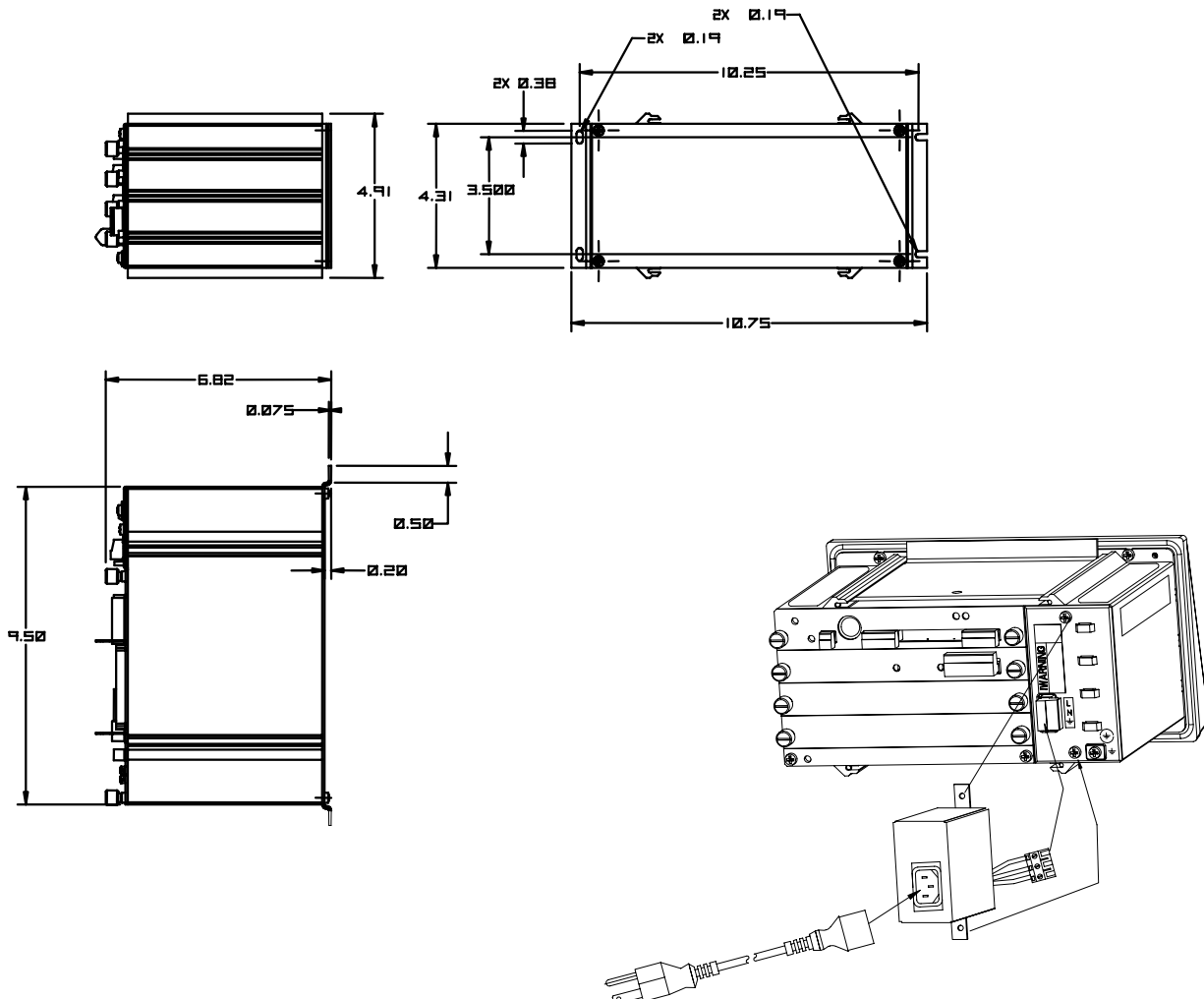

Installing the Harsh Environment Enclosure

Dimensions: 9.42 (239.3 mm) in x 12.62 in (321 mm) x 9 in (228.6 mm)*

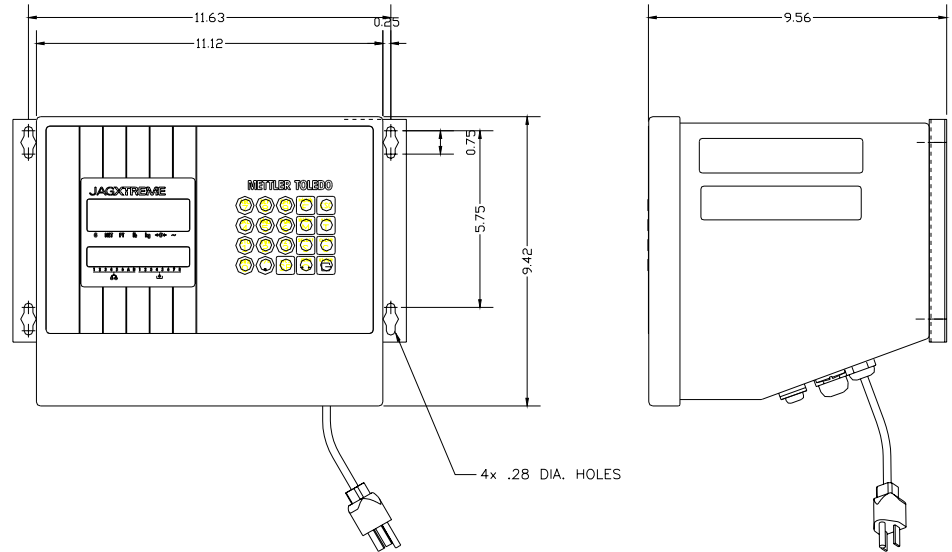

*Refers only to JAGXTREME harsh environment enclosures manufactured after July 15, 2001.

Opening the Harsh Environment Terminal

1. Disconnect power.
2. Locate the two slots on the bottom lip of the front of the harsh environment enclosure.
3. Gently insert the blade of a slotted screwdriver into one of the slots and press inward (toward the enclosure). This releases a pressure tab that allows the access panel of the enclosure to open slightly.
4. Repeat steps 2 and 3 for the other slot.
5. Remove the access panel away from the enclosure. The access panel is connected to the Controller PCB by a cable and cannot be removed without disconnecting the cable. You should be able to access the unit with the front panel connected.
6. With the access cover removed, you are now ready to make connections to the unit. The illustration and table that follow describe the recommended wiring connections.

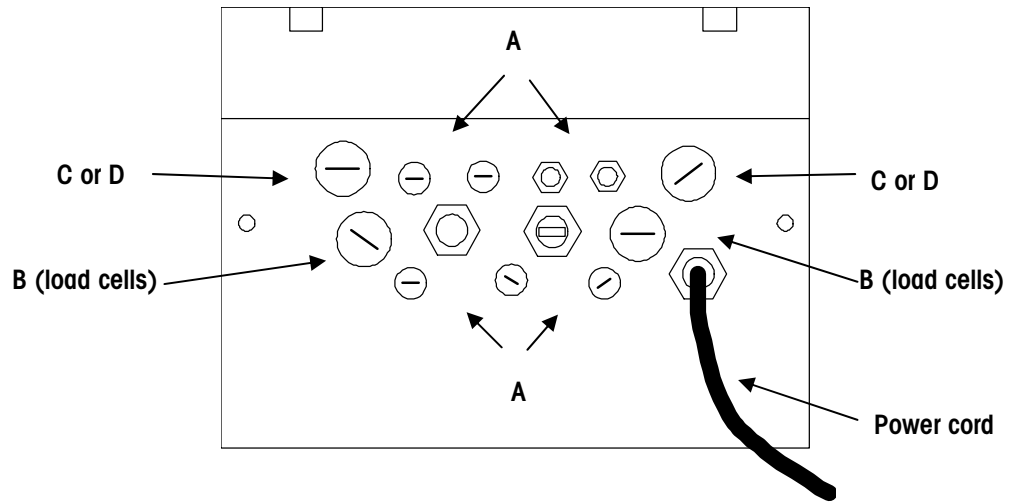

Reference Letter	Suggested Cable
A	Serial I/O Cables (Except DigiTOL) PLC I/F Cabling
B	Analog Load Cell Cabling DigiTOL Load Cell Cabling
C	Ethernet Cabling RJ-45 Category 5
D	QWERTY Keyboard PS/2

Mounting the Harsh Environment Terminal

1. Locate the two mounting brackets that came in the JAGXTREME terminal package.
2. Mount the brackets using the four stainless steel screws supplied with the unit. Refer to figure below and note the correct positioning of the brackets. The slotted holes must protrude beyond the enclosure and the bracket tabs must point toward the front as shown.

* Shown with wall mount brackets
(included with enclosure) installed.

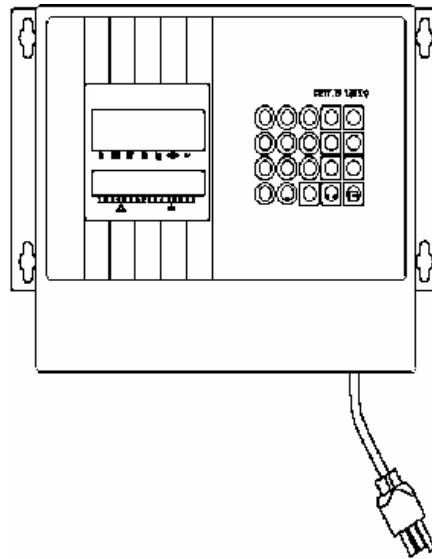

3. Tighten the brackets to the back of the enclosure (torque 25 inch pounds 2.83 N•m).
4. Using the dimensions above, prepare the mounting surface to accept the enclosure. The mounting surface and brackets must be able to support 45 lb (20 kg).
5. Place the enclosure on the mounting surface and secure with appropriate fasteners. You can now make the electrical connections.

Ethernet Connection

The JAGXTREME terminal can be connected to LAN, WAN, automation or enterprise systems using ETHERNET, a standard network hardware platform.

The ETHERNET connection on the rear of the JAGXTREME terminal Controller PCB is designed for an RJ45 connector. METTLER TOLEDO recommends using Category 5 cable, which provides unshielded, four twisted pair cable.

Depending upon the equipment to which the JAGXTREME terminal will be connected, either a “crossover” or standard cable is required.

- When connecting directly between a PC and a JAGXTREME terminal (point to point connection), a crossover cable is used.
- To connect the JAGXTREME terminal to other equipment through a hub, a standard cable is normally used as the hub provides the crossover connections. Refer to the specifications of the hub used to determine if a crossover cable is required.

JAGXTREME Terminal Jumper and Switch Settings

Jumper and switch settings for the Controller PCB, Analog PCB, and optional Allen-Bradley RIO PCB are described in the following sections.

Controller PCB

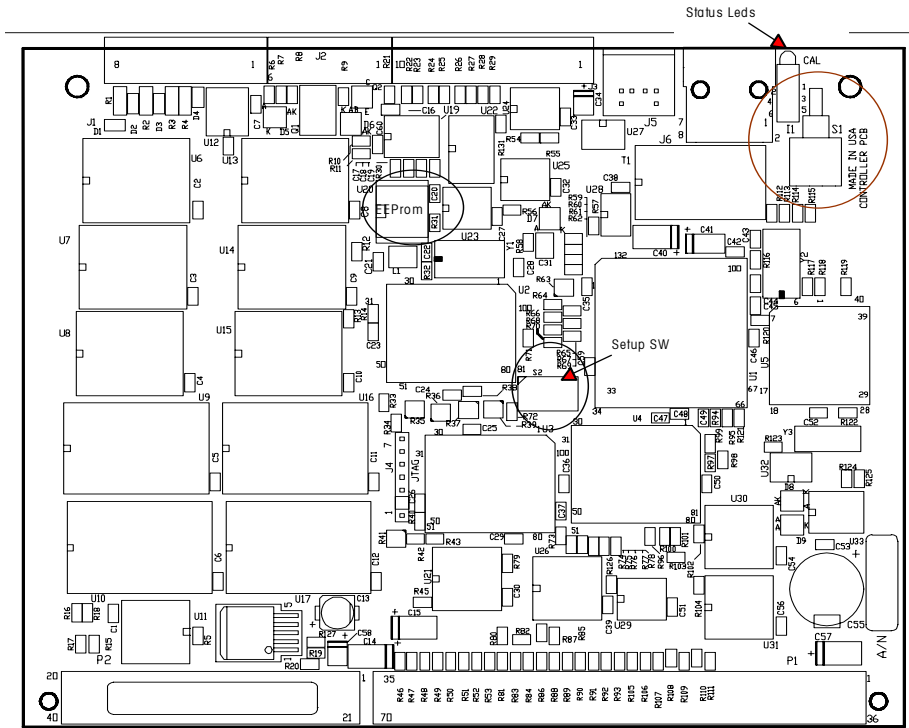

Figure 2-j: Controller PCB

CAL SW Pushbutton is used when new software is downloaded to the JAGXTREME terminal or to perform a Master Reset and to override SW 1 (below) and allow entry to setup.

Setup SW When switch 1 of switch block SW2 is ON, then access will be denied to Setup (also referred to as the Legal-for-Trade jumper). When SW2 is ON, the access to test mode is enabled. This overrides a JagBASIC program that has taken control of the keyboard and keypad.

LED A Indicates that the processor is running

LED LNK indicates that the Ethernet link is established

LED T/R indicates traffic across the Ethernet link

Analog Load Cell PCB

*14093000A

*14485300A (Reduced
 Excitation Version)

U28 on the Analog PCB must be "A" revision or newer to be used with JAGXTREME terminal software versions "C" or newer. Kit 0901-0392 must be ordered to supply U28 in "A" revision or newer to upgrade an existing Analog Load Cell PCB.

Jumpers on the Analog PCB should be set as follows:

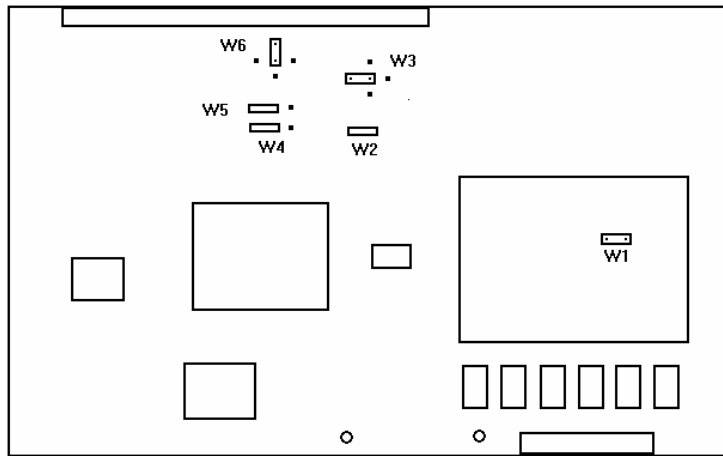

Figure 2-k: Analog Scale PCB

- **W1** should be OFF for 3 mV/V, ON for 2 mV/V. W1 is ON when the jumper is inserted over the two male pins.
- **W2** must be ON.
- **W3** (address) should be positioned to address the specific Analog PCB you are working with. If a single analog scale is used, you must position W3 so you can read the letters B1 under the jumper. If two analog scales are present, address the second Analog PCB as B2 as shown in the following diagram:

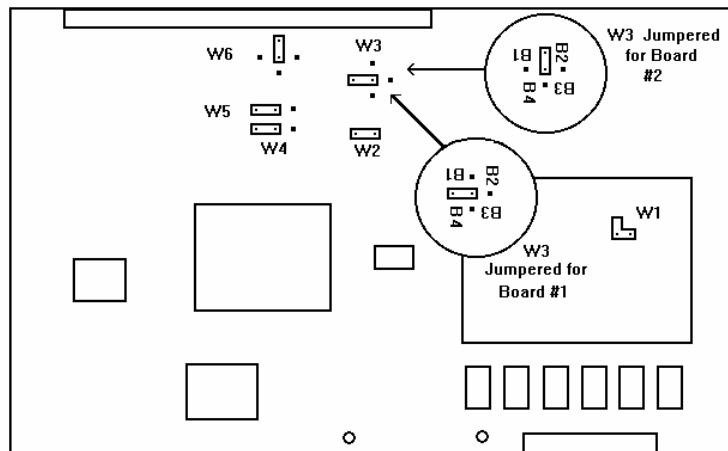

Figure 2-l: Analog Scale PCB — W3 Expanded View

- **W4 and W5** should be set to the jumper over pins 2 and 3.
- **W6** (interrupt) should be positioned as shown so the designation I7 can be read directly above the jumper.
- The Test 1-10 must be left OPEN for normal operation.

Single Channel Analog Load Cell PCB

*15345400A
 *15360200A (Reduced
 Excitation Version)

Jumpers on the Single Channel Analog Load Cell PCB should be set as follows:

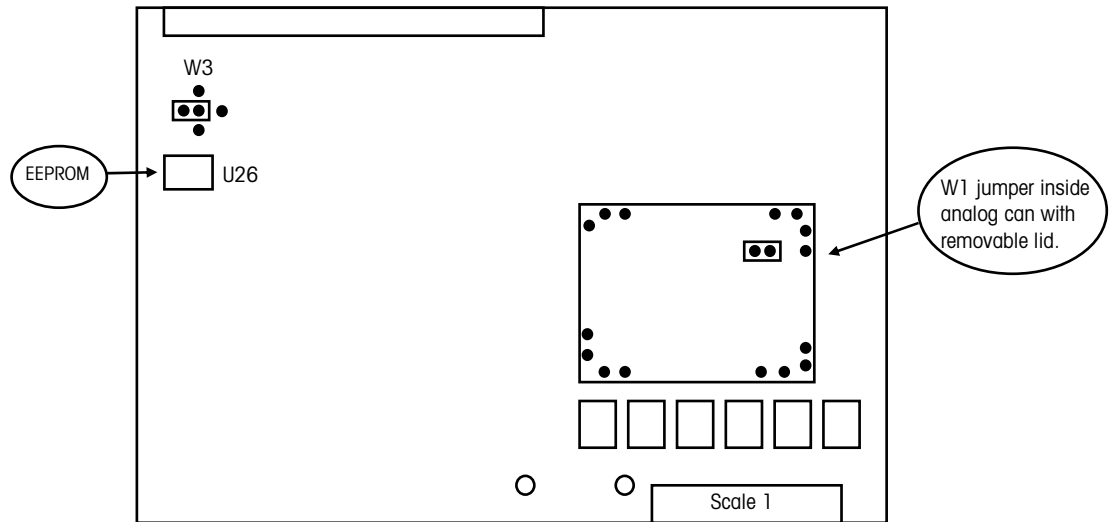

Figure 2-m: Single Channel Analog Load Cell PCB

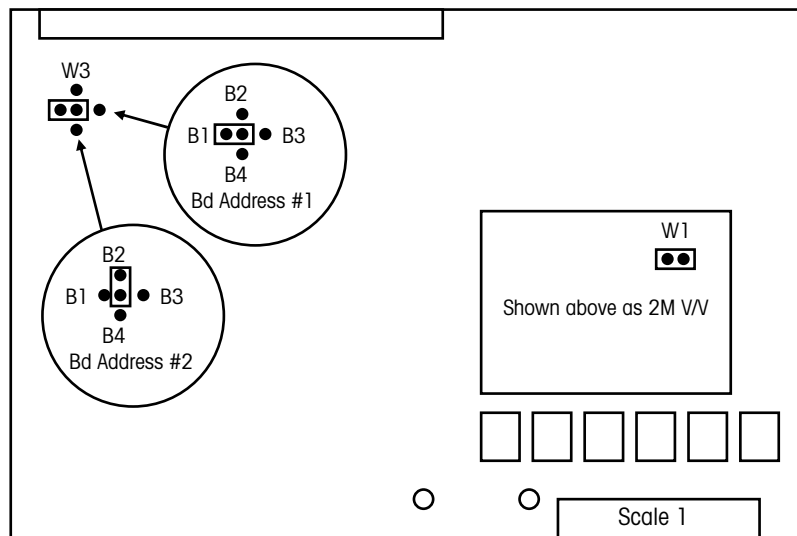

Figure 2-n: Single Channel Analog Load Cell PCB

W1 should be OFF for 3mV/V, ON for 2mV/V. W1 is on when the jumper is inserted over the two male pins.

W3 (Bd Address) should be positioned to address the specific Analog Load Cell PCB you are working with. If a single analog scale is used, you must position W3 so you can read the letters B1 under the jumper. If two analog scales are present, address the second Analog PCB as B2 as shown in the above diagram.

If a dual channel Analog PCB and a single channel PCB are present, address the dual channel Analog PCB as B1 and the single channel Analog PCB as B3.

Dual Channel Analog Load Cell PCB

*15290700A
 *15360100A (Reduced Excitation Version)

Jumpers on the Dual Channel Analog PCB must be set as follows:

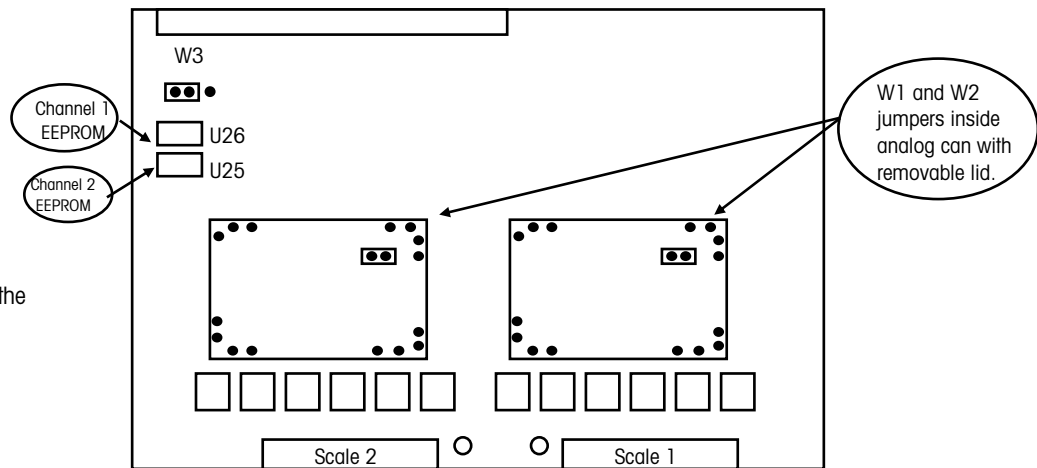

Note: If a POWERCELL fails, the weight display will blank.

Figure 2-o: Dual Channel Analog Load Cell PCB

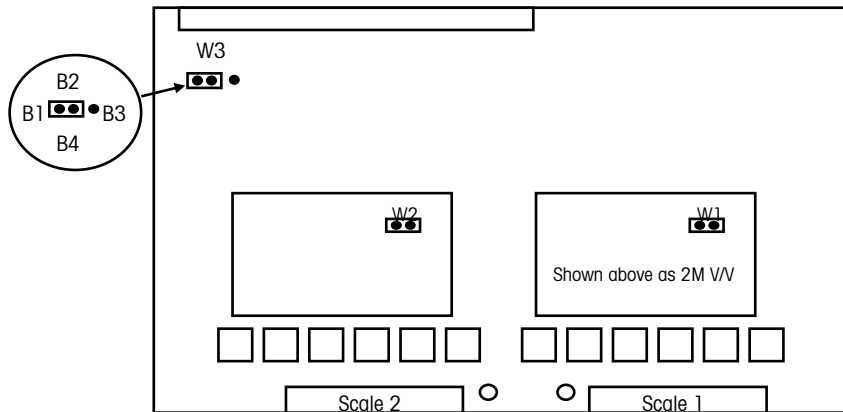

Figure 2-p: Dual Channel Analog Load Cell PCB

W1 should be OFF for 3mV/V, ON for 2mV/V for Scale 1. W1 is on when the jumper is inserted over the two male pins.

W2 should be OFF for 3mV/V, ON for 2mV/V for Scale 2.

W3 (Bd Address) must be positioned so you can read the letters B1 under the jumper.

Allen-Bradley RIO PCB

The Allen-Bradley PCB has three jumpers. W2 and W3 must be installed. W1 must be installed in the "I3" position.

POWERCELL PCB

Jumpers on the POWERCELL PCB should be set as shown below:

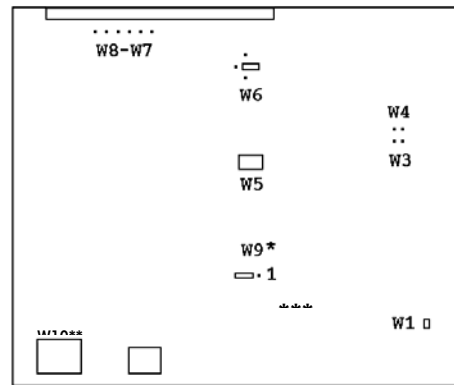

Figure 2-q: POWERCELL PCB

***W9** is shown in the "internal" position meaning that the POWERCELL I/F PCB is using the internal power supply to power the CMOS load cells. If the application contains more than 14 POWERCELLS, an External Power Supply (P/N 0917-0240) must be used.

****W10** is the line termination jumper. It should be set if there is a single homerun cable with the JAGXTREME terminal at the end of the cable.

*** **W5** jumper is removed if you have two scale cards, such as an Analog Card or an MMR (IDNET) Card and the POWERCELL Card. The W5 jumper should be installed on the MMR (IDNET) Card.

MMR (IDNET) PCB

Jumpers on the High Precision Module should be set as follows:

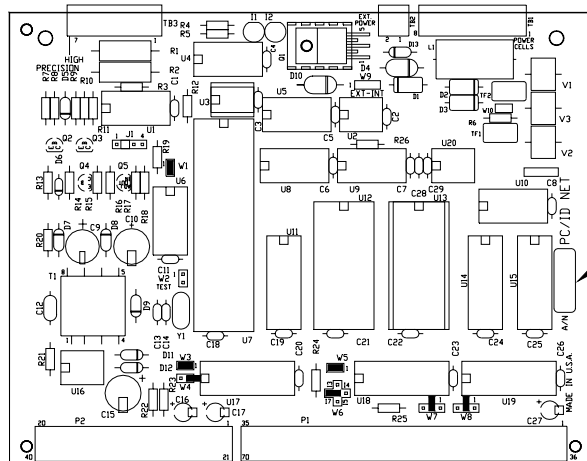

Figure 2-r: MMR (IDNET) PCB

- W1** ON
- W2** OFF
- W3** = ON, **W4** = OFF (Scale 1)
- W3** = ON, **W4** = ON (Scale 2 PCB)
- W5** Analog Scale PCB - W3 Jumper in B1 Position W5 =OFF
- Only Scale PCB, W5 = ON
- Two IDNET PCB's, One Set = ON, One Set = OFF
- W6** 17 (as shown in PCB drawing)
- W7** OFF
- W8** OFF

Multifunction I/O PCB

Jumpers on the Multifunction I/O PCB should be set as shown below:

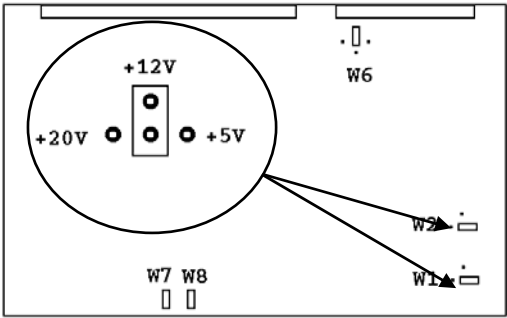

Figure 2-s: Multifunction I/O PCB

W1—must be set for the desired voltage that the selected PAR 3 and PAR 4 parallel outputs will be referenced to through 10 K ohm pull-up resistors resident on the Multifunction PCB. It is also the voltage that will be present on the V OUT terminal of PAR 3. The choices are +5 VDC, +12 VDC, and +20 VDC.

W2—selects the voltage that will be present at the +V terminal of the COM4 Port. The choices are +5 VDC, +12 VDC, and +20 VDC. Select +20 VDC when connecting a DigiTOL scale base to COM4.

W3—ON, test (unused)

W4—OFF

W5—ON, test (unused)

W6—IRQ 4

W7—ON

W8—ON

Installing Options

JAGXTREME terminals may be ordered with options already installed at the factory. Options may also be ordered separately and installed in the field. Remember when installing options that the Controller PCB must always be in the top slot. The remaining slots are for optional boards and can be used interchangeably.

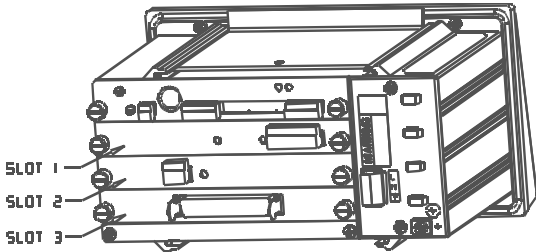



Figure 2-t: JAGXTREME Terminal Option Panel Slots

	CAUTION
	OBSERVE PRECAUTIONS FOR HANDLING ELECTROSTATIC DEVICES.

To install JAGXTREME terminal options:

1. Disconnect all power to the terminal



	 CAUTION
	REMOVING OR INSTALLING BOARDS WITH POWER APPLIED MAY RESULT IN DAMAGE TO ALL CIRCUIT BOARDS. REMOVE POWER THEN WAIT FOR AT LEAST 30 SECONDS PRIOR TO REMOVING OR INSTALLING BOARDS.

It is not necessary to use great force to push the PCB into the slot. Turning the thumb screws will help draw the PCB into its socket.



2. Remove the rear cover of a general-purpose model by removing the four screws securing the cover to the housing. For harsh environment enclosures, remove the front cover as described previously in this chapter.
3. Choose the available slot where the option will be installed, then remove the blank panel assembly by turning the two thumb screws counter-clockwise until the panel assembly comes off.
4. Evenly align the edges of the PCB option board assembly in the grooves on each side of the board slot and slide the board into the JAGXTREME terminal.
5. Gently press the PCB into the open slot with your hand until it is seated.
6. Turn the thumb screws clockwise to secure the panel assembly into the unit. Tighten these with your hand; a tool is not necessary.

Apply Power

Following the connection of all external wiring, configuration of circuit board jumpers, and installation and configuration of option boards, power may be applied to the JAGXTREME terminal. Visually inspect the terminal to verify that these steps have been properly carried out, and then apply power

	 WARNING!
	VERIFY POWER, NEUTRAL, AND GROUND WIRES ARE CORRECT AT THEIR SOURCE PRIOR TO APPLYING AC POWER. FAILURE TO DO SO MAY RESULT IN BODILY INJURY.

On general-purpose models, power is applied by plugging the line cord into a properly grounded AC power outlet. On panel or chassis mount models, power is applied by turning on the AC power switch for the power distribution system.

	 WARNING!
	AC POWER SOURCES MUST HAVE PROPER SHORT CIRCUIT AND OVER CURRENT PROTECTION IN ACCORDANCE WITH LOCAL AND NATIONAL ELECTRICAL REGULATIONS. FAILURE TO PROVIDE THIS MAY RESULT IN BODILY INJURY.

Power-up Sequence

See the appendix for information on loading software and power-up error messages and actions.

The software revision level is shown in the lower display area during power-up.

The JAGXTREME terminal goes through a series of self-tests when it is turned on. These tests confirm normal terminal operation. The power-up sequence is as follows:

1. All segments of the display windows are lit, verifying operation of all segments. The display shows dashes [---] in the upper display while the terminal performs internal diagnostic self-tests on memory and identifies optional boards that are installed. The terminal also checks the location of setup parameters and memory fields. If these have been moved or changed, an error message will appear before displaying the software part number.
2. After a delay, the terminal displays the software revision level and advances to normal operation mode.
3. Next, the terminal tests communication with the load cell. The terminal displays weight when successful communication is established. If the JAGXTREME terminal is unable to establish communication, an error is displayed.
4. Finally, if enabled, the JAGXTREME terminal power-up timer counts the minutes and seconds remaining before the terminal advances to normal operating mode. Power-up timer configuration is discussed in Chapter 3.

The basic power-up sequence requires approximately 20 seconds. The power-up sequence is analogous to the time required to “boot” a personal computer.

Scale Build Determination

If a standard, recommended scale build is used for your application, you can proceed to Chapter 3: Programming and Calibration. If a nonstandard build is desired or if the analog scale input is used with a mechanical lever system conversion, the minimum increment size for the scale base must be determined before calibration.

Minimum Increment Size for Bench and Portable Single DLC Scale Bases

Consult the DLC Bench Scale Serial Plate or Technical Manual for the capacity and increment size. POWERCELLs used with the POWERCELL PCB have a minimum allowable increment size of 5 lb. Standard truck scale applications use an increment size of 20 lb (10 kg). If these increment sizes differ for legal-for-trade applications using the POWERCELL load cell, consult with the presiding government agency.

Minimum Increment Size For Optional Analog Scale Input

Minimum increment size selection for an analog scale input is determined by calculating microvolts per increment for the desired build. To calculate microvolts per increment:

1. Solve the following equation for μV per increment (assumes using a standard analog load cell interface module with a 15 V excitation).

$$\mu\text{V per Increment} = \frac{\text{Increment Size} \times \text{cell output} \times 15000}{\text{Load Cell Capacity} \times \text{Ratio}}$$

Increment size, scale capacity, and load cell capacity must be measured in the same weight units, lb or kg. If the variables are listed in kg units, multiply by 2.2046 to convert to lb units. Load cell output is rated in mV/V (millivolts per volt of excitation), marked on the load cell data tag. METTLER TOLEDO load cells are typically 2 mV/V; others range from 1 mV/V to 4.5 mV/V. Load cell capacity is the rated capacity marked on the load cell data tag. Ratio is the number of load cells in the system or total lever ratio (if scale is a mechanical lever system conversion).

2. Calculate total increments by dividing calibrated capacity by increment size.
3. Use the microvolt build table that follows to determine if the μV per increment calculated in step 1 is within the range allowed for the total number of increments calculated in step 2. These parameters have demonstrated stable builds but smaller minimum μV per increment and larger total number of increments are possible.

Microvolt Build Table			
Total Number of Increments	Minimum μV per Increment	Maximum μV per Increment	
		2 mV/V	3 mV/V
600	5.0	43.3	63.3
1,000	3.0	26.0	38.0
1,200	2.5	21.7	31.7
1,500	2.0	17.3	25.3
2,000	1.5	13.0	19.0
2,500	1.2	10.4	15.2
3,000	1.0	8.7	12.7
4,000	0.75	6.5	9.5
5,000	0.6	5.2	7.6
6,000	0.5	4.4	6.4
8,000	0.375	3.3	4.8
10,000	0.3	2.6	3.8
12,000	0.25	2.2	3.2
15,000	0.2	1.7	2.5
16,000	0.18	1.6	2.4
20,000	0.15	1.3	1.9
25,000	0.12	1.0	1.5
30,000	0.1	0.87	1.3
32,000	0.1	0.81	1.2
35,000	0.1	0.74	1.1
40,000	0.1	0.65	0.95
45,000	0.1	0.58	0.84
48,000	0.1	0.54	0.80
50,000	0.1	0.52	0.76

The JAGXTREME terminal should never be programmed for less than 0.1 μV per increment. The JAGXTREME terminal CANNOT be calibrated for builds that exceed the maximum μV per increment listed in the microvolt build table.

Sample Calculation

1. Refer to the following example of μV per increment calculation for a Model 2158 floor scale installation.

Scale Capacity	5000 lb
Increment Size	0.5 lb
Load Cell Capacity	2500 lb
Number of Cells	4
Cell Output	2 mV/V
Excitation Voltage	15 VDC

2. Use the formula from step 1 to calculate the μV per increment.

$$\mu\text{V per Increment: } \frac{0.5 \text{ lb} \times 2 \text{ mV} / \text{V} \times 15000}{2500 \text{ lb} \times 4 \text{ load cells}} = 1.5 \mu\text{V/inc.}$$

3. Divide scale capacity by increment size to determine total number of increments.

$$\frac{5000 \text{ lb}}{0.5 \text{ lb}} = 10,000 \text{ total Increments}$$

4. Check the microvolt build table to see that 1.5 μV per increment build is within the acceptable range for 10,000 increments. It is, so this is an acceptable build.

Seal the Enclosure - Weights and Measures Applications

After setup is complete, most legal-for-trade applications require sealing the enclosure so modifications cannot be made. If the terminal is not used for legal-for-trade applications, skip this section. Make sure SW2-1 (setup access) is ON before sealing the enclosure.

Panel Mount Enclosure

1. Screw one through-hole sealing screw into the hole labeled "CAL" on the rear of the Controller PCB and two more into the threaded holes directly above, below and to the left of the "CAL" opening. (Refer to the illustration on the next page.)
2. Tighten the screws and run a wire seal through the holes in the screw heads.
3. Apply the lead seal.
4. Remove the two top screws near the front of the enclosure one at a time and replace them with special through-hole sealing screws.

Seal the Enclosure - Weights and Measures Applications

5. Screw a third sealing screw into the unused hole adjacent to the right side screw.
6. Run a wire seal through the holes in the heads of the screws.
7. Apply the lead seal.

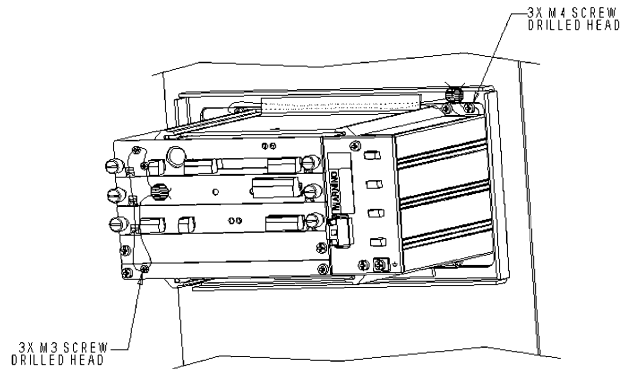

Figure 2-p: Sealing Panel Unit

General Purpose Enclosure

1. Screw a special through-hole sealing screw into all three holes at the top of the rear cover plate.
2. Tighten the screws and run a wire seal through the holes in the heads of the screws.
3. Apply the lead seal.

Harsh Environment Enclosure

1. Sealing holes are located on the left and right sides of the bottom of the enclosure.
2. With the front door firmly seated on the enclosure, run a wire seal through the door and tab holes.
3. Apply the lead seal.
4. Repeat for the opposite side.



For your notes

3

Programming and Calibration

Note: If you are using a JAGXTREME terminal with the optional JagMAX software, follow the instructions in this chapter for configuring the terminal and then refer to the chapter on setting up the application-specific parameters for JagMAX.

To program and calibrate the JAGXTREME terminal, you must enter setup (program) mode from the front panel of your terminal or via the embedded web server. (When the terminal is powered up, it comes up in run mode by default.) This chapter provides instructions for programming and calibrating the terminal from the front panel. Please refer to Chapter 4 of this manual if you wish to program and calibrate the terminal using the embedded web server.

Upon entering setup mode, you will find a series of program blocks that allow you to set the various parameters, which dictate how the terminal will work. (Refer to the chart on page 3-7 for an overview of these program blocks.)

Note: Whether you choose to program the terminal from the front panel or using the embedded web server, you should refer the information in this chapter as it provides important information about each of the program blocks.

General Information

Front Panel Display

The JAGXTREME terminal can be programmed using the keypad on the front panel of the terminal. The keypad consists of numeric keys 0 through 9, which contain alphabet characters and symbols, a decimal point (.), a space (SP) and eight function keys containing graphic symbols.

The front panel also contains an upper and lower display. In run mode, the top display shows the current gross or net weight values with annunciators that indicate the status of the display and the weighing mode (NET or GROSS). In setup mode, the bottom display shows the name of the program block or sub-block or a display prompt requesting an action by the programmer.

Key Functions

The numeric keys are used to input numeric entries such as threshold values and scale capacity. They are also used for alphanumeric entries unless a PC type keyboard is installed.



The FUNCTION key is used to enter setup mode and access the program blocks. Depending on the JAGXTREME terminal's setup configuration, the FUNCTION key is also used for Switch Units, Recall Tare, and Recall Gross.



The SELECT key is used to scroll through a list of choices. As the SELECT key is pressed, programming items appear in the lower display area.



The ENTER key is used to complete a response. Press ENTER after you have used the numeric keys to input data or the SELECT key to display an option.



The ESC key is used to exit the current location. The parameters you have configured prior to pressing ESC are saved when you exit. Each time you press ESC, you exit back to the previous level of setup. You may have to press ESC several times to return to a desired location.



Pressing the CLEAR key clears the last character of a response and allows you to re-key the response. This is similar to the backspace key on a computer keyboard.



Pressing the ZERO allows you to back up in the current program block and return to the previous step if you are in the first two levels of setup. The ZERO key does not function when you are beyond the second level in setup.



The TARE key is not used in setup mode. In normal operating mode, it is used to perform a pushbutton tare if that function is enabled in setup.



The MEMORY key is not used in setup mode. In normal operating mode, it is used to access memory functions, depending on the JAGXTREME terminal's setup configuration, including Prompt List, Consecutive Number, Enter Setpoint, Time, Date, and Alibi Memory.

Accessing Setup



The terminal is shipped from the factory with the legal-for-trade switch (S2-1) set in the 'OFF' position. Upon powering up the terminal, you should be able to directly enter setup mode.

1. Plug the terminal in. It will go through a power-up sequence during which time the lower display will first read **[METTLER TOLEDO]**, followed by the software number, and then **[lb GROSS]** on the lower display and **[0.000]** on the upper display.
2. Press the FUNCTION key then the SELECT key until **[Enter Setup?]** is displayed. If the **[Enter Setup?]** prompt is not displayed, try the following steps:
 - Remove AC power.
 - Remove the controller board and set S2-1 to the off position, or
 - Push in the CAL switch while entering setup.
 - Replace the controller board or option board.
 - Apply power to the terminal and repeat steps 1 and 2.
 - Perform a master reset.
3. Press ENTER. The first program block, **[Scale Interface]**, should be displayed. Once **[Scale Interface]** is displayed, press ENTER to open this block or press SELECT to move to the next program block.

Note: Use anti-static protection straps whenever touching electronics boards.

Note: Entering setup will terminate a JagBASIC program.

Setup also can be accessed from the HTML (web) pages by clicking on the "PROGRAM MODE" button on the left side of the screen. However, entering setup in the HTML pages can only be accomplished if the JagBASIC is program stopped.

Navigating



To move through the various program blocks and sub-blocks:

1. Press SELECT to scroll through the program blocks. When the desired block is displayed, press ENTER to open it.
2. Program blocks contain sub-blocks that handle specific areas of functionality. Once you are in a program block, press the SELECT key to move through the sub-blocks. Use the ENTER key to confirm your parameter option selection in the sub-blocks.
3. After configuring a sub-block, the terminal proceeds to the next sub-block. When you finish configuring the last sub-block in a program block, the terminal proceeds to the next program block. Continue through each program block until you have finished configuring each one.
4. To return to normal operation after configuring the parameters in each sub-block, press ESC several times until the prompt **[Exit Setup?]** is displayed.
5. Press ENTER to confirm that you want to exit setup mode.
6. If you do not wish to exit, press SELECT to choose another program block within setup mode.
7. To protect the setup parameters from being changed once you have configured them, power-down the terminal and set S2-1 to the ON position.

You can exit your position in a program block by pressing ESC several times at any time. Arrows in the upper display indicate your position within a program block. See the table below. (These arrows are also shown on the program block overviews in this manual.) You can also exit setup from the HTML (web) pages by clicking on the "Run Mode" button the left side of the screen.

Arrows	Block Position
1 Arrow ▼	You are in Setup Mode, top level.
2 Arrows ▼▼	You are in a Program Block.
3 Arrows ▼▼▼	You are in a sub-block.
4 Arrows ▼▼▼▼	You are configuring an element within a sub-block.

Audible Messages

Refer to the section of this manual on programming the Application Environment program block for instructions on enabling and disabling the beeper.

The JAGXTREME terminal has a system of audible beeps that give immediate feedback for each keystroke and terminal response. These audible messages can be programmed ON or OFF in setup. The terminal is programmed at the factory with the audible messages OFF and the alarm beeps ON.

Beep Description	Indication
One short beep	A key has been pressed and recognized.
One long beep	The keystroke(s) you have entered are invalid.
Three quick beeps	The entry is acknowledged and function is performed.

Reset to Factory

Note: You cannot reset a single value or specify only a few of the sub-block values.

Note: Using the reset option is the same for all program blocks except the Diagnostics program block.

The last sub-block in each program block is Reset to Factory. Selecting **Y(es)** at the **[Reset to Factory?]** prompt returns all parameters in the current block to the original factory settings.

The Diagnostics block has a Master Reset option that lets you reset all parameters in all blocks, including or excluding the Scale Interface program block. Refer to the section entitled Diagnostics Program Block at the end of this chapter. The default values for all program block parameters are listed in the appendix.

To reset the program block parameters:

1. Press ENTER at the **[Reset to Factory]** prompt. The terminal responds with the prompt **[Are You Sure?]**
2. Press SELECT to display **[Y(es)]** to confirm that you want to reset the terminal to the original factor settings. Press ESC to exit the sub-block.
3. Press SELECT to continue to the next program block. Use caution when resetting the values for the Scale Interface program block as all calibration values will be reset.

Configuring Terminals With Multiple Scales and a Summing Scale

NOTE: Each internal scale calibration must be selected prior to entering setup.

A JAGXTREME terminal can operate with one, two, three or four scales connected, as well as with the sum of the scales connected. It is possible to combine analog and DigiTOL scales. (Specific combinations are provided in the Specifications Table in Chapter 1.) The terminal is programmed for multiple-scale operation as follows:

1. Determine which scale is currently displayed. The cursor beneath the lower display will indicate which scale is selected. If a JAGXTREME terminal was previously programmed as a one-scale terminal, scale A should be displayed.
2. Enter setup mode and access the Scale Interface program block for scale A. Configure the **[# INTRNL SCL]S** parameter in the Scale Type sub-block as 1, 2, 3, 4 or 5, depending on how many scales you will be using. This allows you to select the next scale (Scale B) from the home position (outside setup mode) and another scale as a summing scale.
3. Finish configuring and calibrating scale A. Exit from setup.
4. From the home position, press SELECT until scale B appears in the lower display. Press ENTER to select scale B. The upper display will show weight from scale B. If no previous calibration exists for scale B, the upper display will show dashes.
5. Configure and calibrate scale B. Do not change the parameter **[# INTRNL SCLS]** back to 1. Make sure **[Add in Sum Y]** is selected for a summing scale.
6. Exit setup. From the home position, press SELECT until the third scale is displayed in the lower display. Press ENTER to select scale. The upper display will show dashes.
7. Configure the third scale as the summing scale (select "summing" as scale type) if you are only using two scales. Otherwise, configure the remaining scales, configuring the last one as the summing scale (select "summing" as scale type.)
8. Exit setup. You can now select scale A, B, C, D or the summing scale.

Alibi Memory

Alibi Memory records can be accessed from the keyboard panel:

1. Press the MEMORY key and then press SELECT to scroll to the **[Alibi Report?]** prompt.
2. Press ENTER and the prompt **[Edit Srch Key? N]** will appear. To examine the most current record in Alibi Memory, press ENTER and go to step 8. To search Alibi Memory based on a search key, press SELECT and then press ENTER.
3. The message **[Date Fmt: DDMMYY]** will appear momentarily to remind you that a date search must be entered as two digits for day, two digits for month, and two digits for year. The prompt **[Date?]** will then appear. Enter the desired date or just press ENTER if no date search key is required. Skip to step 5 if no date search key is required.
4. The message **[Time Fmt: HHMMSS]** will appear momentarily to remind you that a time search must be entered as two digits for hours, two digits for minutes, and two digits for seconds. The prompt **[Time?]** will then appear. Enter the desired time or just press ENTER if no time search key is required. Skip to step 5 if no time search key is required.
5. The prompt **[CnNbr?]** now prompts you to enter a specific consecutive number search key. If no consecutive number search key is required, then press ENTER only.
6. The prompt **[Net?]** now prompts you to enter a specific net weight search key. If no net weight search key is required, then press ENTER only.
7. The prompt **[Tare?]** now prompts you to enter a specific tare weight search key. If no tare weight search key is required, the press ENTER only.
8. The prompt **[Start Search Y]** is now displayed. To start the search, press ENTER, to abort the search, press SELECT to change search selection to no and then press ENTER.
9. If records are found that match the search key, then the message **[NNN Record Match]** is displayed momentarily. "NNN" are the number of records that matched the search key. If no records are found, the message **[No Record Match]** will be displayed.
10. If a record match occurred, then the date and time of the first record found is displayed. Press SELECT to scroll through the other fields (consecutive number, net wt, and tare wt) in this record. Press ENTER to access the next record and press SELECT to scroll through the other fields. After the last record is accessed, the display will return to normal weight mode.

Program Block Overview

The following chart shows the various program blocks and sub-blocks. Instructions for configuring each follow.

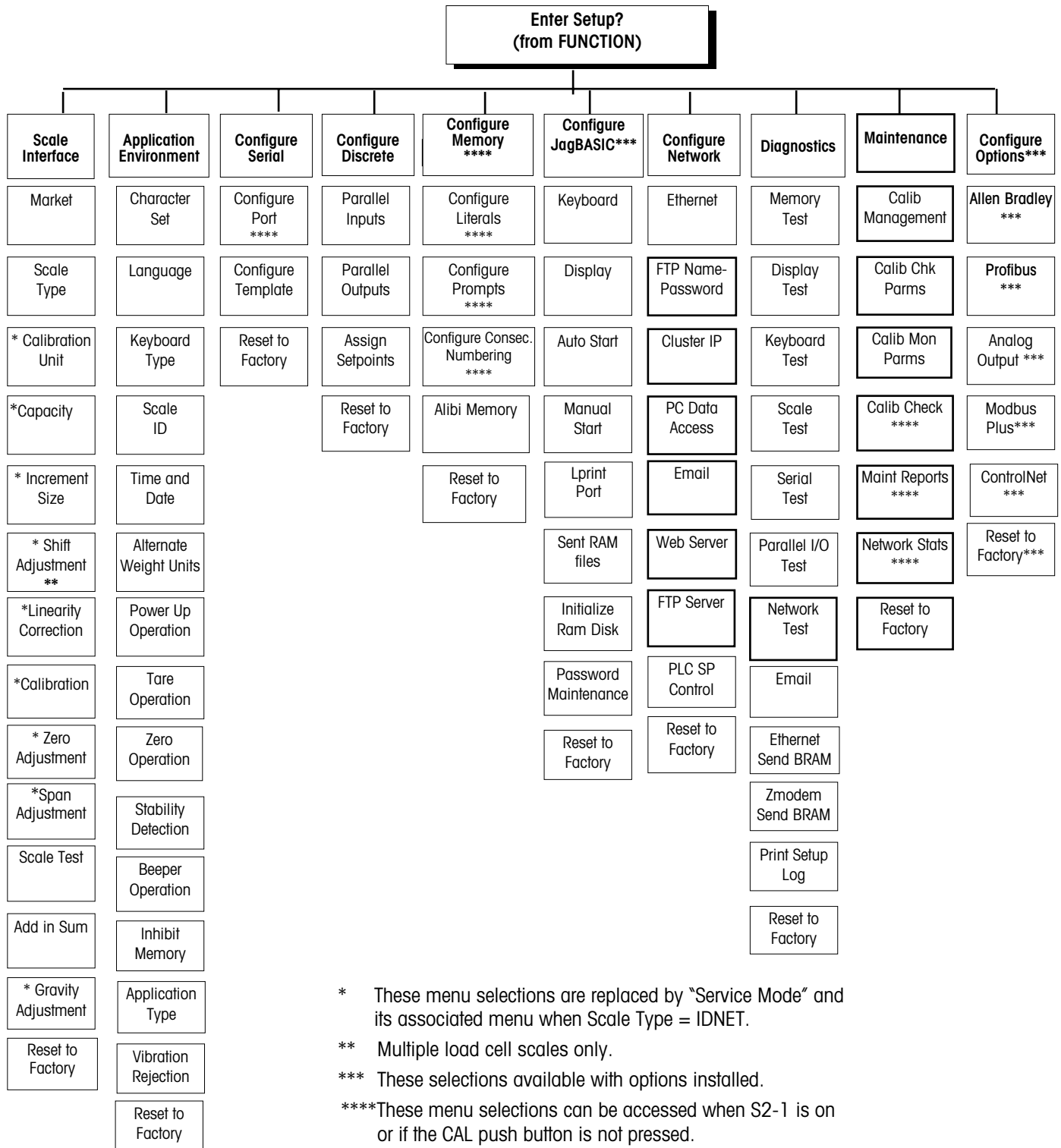

Scale Interface Program Block

The Scale Interface program block lets you set and calibrate the features that affect weighing performance. The following diagram describes this block. Press ENTER at the [Scale Interface] prompt to access the Scale Interface program block and configure the sub-blocks.

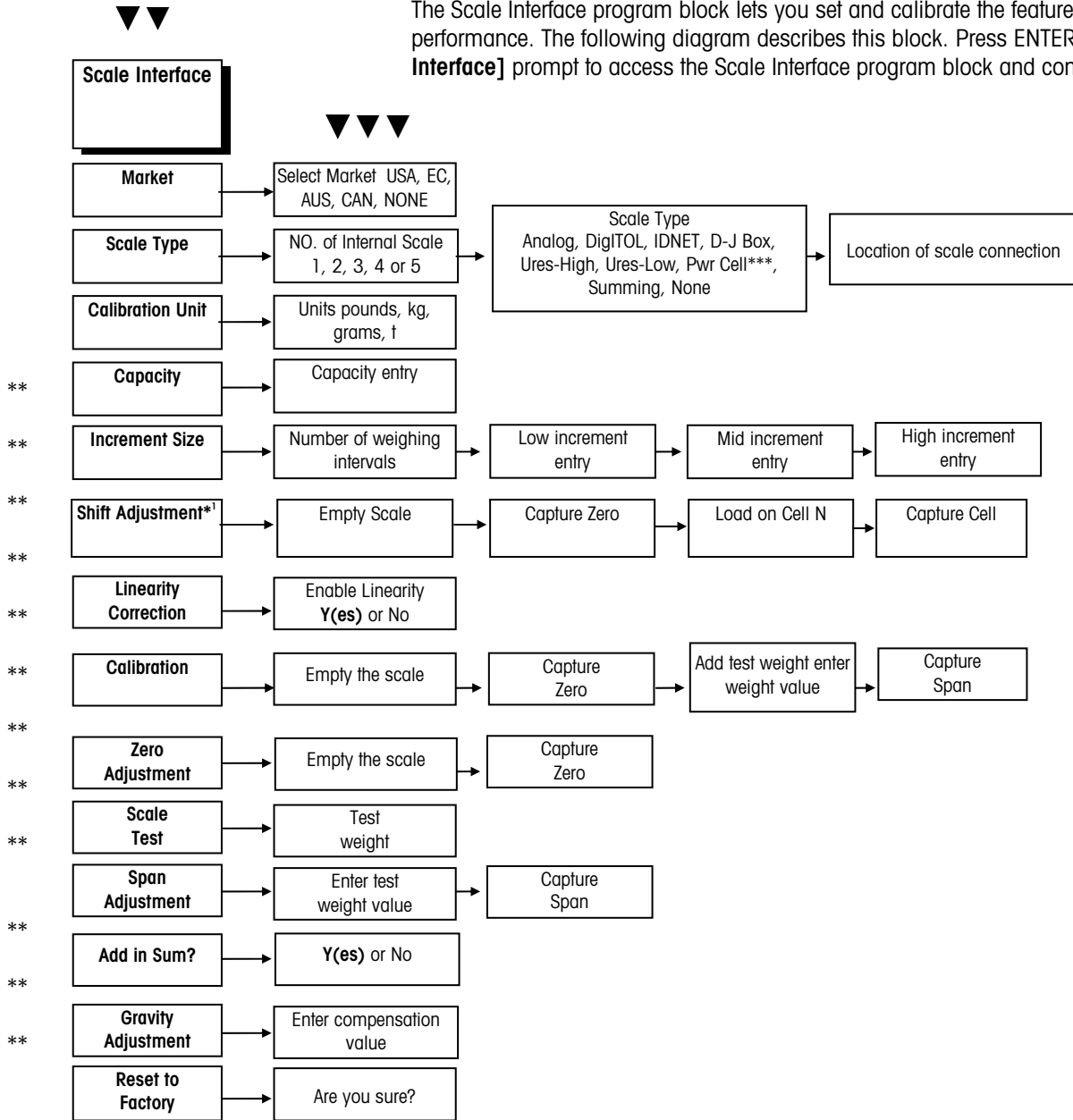

*Multiple load cell scales (POWERCELLs, RAAD Boxes) only.

**These menu selections are replaced by "Service mode" and its associated menu when Scale Type = IDNET.

***Applies to use of RAAD box(es)

1 Appears only if DigiTOL J-Box or POWERCELL (RAAD box) selected in Scale Type sub-block.

1. Market Sub-block

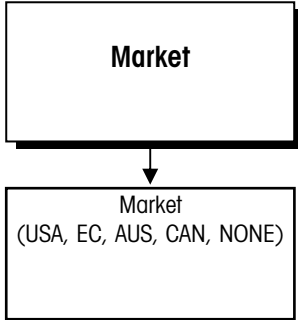

Note: You can exit the setup mode any time during configuration. You may need to press ESC several times to return to the **EXIT Setup?** prompt, then press ENTER.

The JAGXTREME terminal is factory set for the market you specified when you ordered the terminal. The Market sub-block lets you select a new country or market area and limit parameters that affect legal-for-trade programming options.

1. Press ENTER at the **[Market?]** prompt to access this sub-block.
2. Press SELECT until the desired market area is displayed, then press ENTER. Market areas include:
 - USA—United States
 - EC—European Community
 - AUS—Australia
 - CAN—Canada
 - NONE—disables legal-for-trade option
3. Continue to the next sub-block, or press ESC twice to exit the setup mode.

2. Scale Type Sub-block

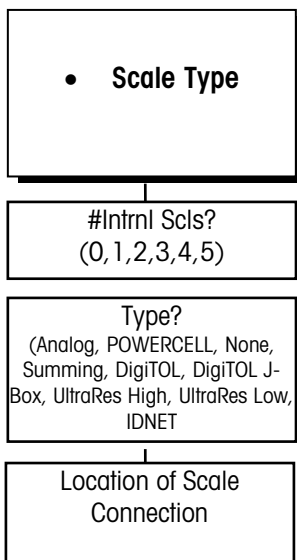

JAGXTREME terminals with a single analog scale must use Board #1 (BD1). When the board is selected. The JAGXTREME terminal proceeds to the next sub-block. Setting the number of internal scales to 0 will enable the JAGXTREME terminal to operate without any internal scales.

The Scale Type sub-block prompts you for the number of internal scales and type of scale that will be used.

1. Press ENTER at the **[Scale Type]** prompt to open the sub-block.
2. At the **[# Intrnl Scls?]** prompt, select the number of internal scales. Choose 1, 2, 3 or 4, (or 5 if a summing scale is desired), depending on the number of scales connected to the terminal. NOTE: Add one number to the number of scales if a summing scale is desired. The summing scale must be "E".

When configuring terminals with two or more scales, select the first scale (A) to calibrate by pressing SELECT (not in setup mode), then enter setup and calibrate scale A. To calibrate the second scale you must exit setup mode, select the second scale (B) with the SELECT key, then reenter setup and calibrate scale B. Follow the same procedure for any additional scales.

3. Press SELECT at the **[Type?]** prompt until the desired scale type is displayed, then press ENTER. Scale types include:
 - Analog
 - POWERCELL**
 - None
 - Summing
 - DigiTOL (bench or portable)*
 - DigiTOL Junction Box (J-Box)*
 - UltraRes High*
 - UltraRes Low*
 - IDNET

*Do not use these selections if you are using the JagMAX application software.

**Applies to use of RAAD box(es).

If Analog is Selected

Select board #1 (BD1) or board #2 (BD2), depending on the address of the Analog PCB connected to the scale. Jumper W3 on the Analog PCB determines the board address. If two analog PCBs are installed, they must have different board addresses. If two dual analog cards are installed, you may also select board #3 and board #4.

If POWERCELL (RAAD Box) is Selected

Example: If scale A of a two-scale JAGXTREME terminal has 6 cells and Scale B has 8 cells, Scale A would be addressed as 1 through 6. Scale B cells would be addressed as 31 through 38.

If a RAAD box is connected with four load cells as Scale #1, then the starting address for Scale A is POWERCELL #1.

1. At the [**Loc? Prompt**], select the address of the scale's first cell.
2. To address the cells of a single scale or Scale A, select [**PwrCell #1**]. To configure cells of the second scale (Scale B), select [**PwrCell #31**]. To configure cells of the third scale (Scale C), select [**PwrCell#61**]. To configure cells of the fourth scale (Scale D), select [**PwrCell #91**]. You must configure each scale of a two-scale JAGXTREME terminal separately.
3. At the [**# Load Cells?**] prompt, use the numeric keys to enter the number of load cells in the scale you are configuring.
4. At the [**Shift by?**] prompt, select to perform the shift procedure by single load cells or by pairs of cells (by section). Select [**Cells**] if there is an odd number of load cells. You must address the individual POWERCELLS or RAAD boxes through the Diagnostics program block. Proceed to the section entitled Scale Test sub-block in the Diagnostics program block.

If None is Selected

No scale is active. The JAGXTREME terminal will go to the Calibration Unit sub-block.

If DigiTOL, UltraRes High, or UltraRes Low is Selected

1. Select the Controller PCB COM port where the scale is connected.
2. Select COM2 or COM4 (if installed) then press ENTER. When the COM port is selected, the terminal exits the setup mode and goes through the power up sequence. Re-enter setup mode to continue configuring the program blocks.

If DigiTOL J-Box is Selected

1. Select the Controller PCB COM port where the scale is connected. Select COM2 or COM4 (if installed) then press ENTER. When the COM port is selected, the terminal exits the setup mode and goes through the power up sequence. You must reenter setup mode to continue configuring the program blocks.
2. At the [**# Load Cells?**] prompt, enter the number of load cells connected to the J-Box. (1, 2, 3, or 4).

If UltraRes High is Selected

No scale is active. The JAGXTREME terminal will go to the Calibration Unit sub-block.

If UltraRes Low is Selected

No scale is active. The JAGXTREME terminal will go to the Calibration Unit sub-block.

If IDNET is Selected

At the **Service Mode** prompt, you may enter the service mode for the understructure.

1. Press SELECT to choose between **Y(es)** and **N(o)**, allowing entry into the service mode or to quit without changing any parameters.
2. When the appropriate response is displayed, press ENTER .
3. If you choose to enter service mode, the sequence of operation follows the normal calibration sequence for an ID terminal. This is different from other scale types. If you are not entering service mode, the display will continue as described in the next section.

Service Mode

The service mode is used

- to enter weighing platform-specific parameters
- to calibrate the scale,
- to set the linearity,
- to reset the measuring cell parameters to the factory settings

Caution

The changeable parameters in the service mode are protected with certification. If the scale is set certifiable (APPROVE in program block SCALE), the ID code counter is increased by one when the changed parameters are saved. On a certified scale this corresponds to destroying the certification seal. As a result, recertification of the scale is required.

1.1 Overview of service mode

RETURN ?	Exit service mode without changing the set parameters and ID code counter.
RESET ?	Reset weighing platform parameters to factory settings, see Section 1.3.1
NATION ?	Country selection, see Section 1.3.2 This uses the certification specifications of the country automatically.
SCALE Parameters ?	Input the weighing platform-specific parameters certifiability, type maximum load And resolution, see Section 1.3.3
LINEARITY ?	Enter or measure linearity, see Section 1.3.4
CALIBRATION ?	Calibrate the weighing platform, see Section 1.3.5
ADAPTION	Enter application-specific parameters, see Section 1.3.6
SAVE PARAMETERS ?	Save the selected configuration.

The abbreviations on weighing terminals ID1 Plus, ID3s and ID5 are printed in **bold**.

1.2 Entering and operation

1.2.1 Entering service mode

Entering service mode is described in the service manual of the connected weighing terminal.

1.2.2 Service mode operation

In service mode, only the keys for YES or NO are active; the numeric keyboard is not available for use.

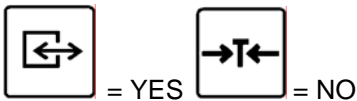

Example 1: Entering the maximum load 60 kg

- | | |
|----|--------|
| CA | 150 kg |
| NO | |
- The offered maximum load is not the desired maximum load.
Answer with **NO**.
- | | |
|----|---|
| | 0 |
| NO | |
- The digit 0 appears.
Us **NO** to increase the first digit to the desired value.
- | | |
|----|---|
| | 1 |
| NO | |
- ↓
- | | |
|-----|---|
| | 6 |
| YES | |
- is the desired first digit
Confirm with YES
- | | |
|-----|----|
| | 60 |
| Yes | |
- The digit 0 appears in the second place; 60 is the desired value.
Confirm with YES
- | | |
|----|-----|
| | 600 |
| NO | |
- An additional place appears, but is not required. Answer with NO
- | | |
|-----|-----|
| | 60. |
| YES | |
- 60. is the desired value.
Confirm with YES
- | | |
|----|-------|
| CA | 60 kg |
|----|-------|
- As a checking measure, the presently set value for maximum load is displayed
Confirm with YES and move on to the next program block.

Example 2: Entering the resolution 0.005 kg

- | | |
|----|----------|
| d | 0.001 kg |
| NO | |
- The offered resolution is not the desired resolution.
Answer with **NO**.
- | | |
|-----|---|
| | 0 |
| YES | |
- The digit 0 appears.
Confirm with YES
- | | |
|----|----|
| | 00 |
| NO | |
- An additional 0 appears before the comma, but is not required
Answer with NO.
- | | |
|-----|----|
| | 0. |
| YES | |
- The decimal point appears;
Confirm with YES
- | | |
|-----|-----|
| | 0.0 |
| YES | |
- Press YES to move additional places until the number of decimal places has
been reached.
- ↓
- | | |
|----|-------|
| | 0.000 |
| NO | |
- Select the desired resolution with NO.
- | | |
|----|-------|
| | 0.001 |
| NO | |
- 60. is the desired value.
Confirm with YES
- ↓
- | | |
|-----|-------|
| | 0.005 |
| YES | |
- 0.005 is the desired value.
Confirm with YES
- | | |
|---|----------|
| d | 0.005 kg |
|---|----------|
- As a checking measure, the presently set value for resolution is displayed.
Confirm with YES and move on to the next program block.

1.3 Settings in service mode

1.3.1 RESET – Resetting to factory default

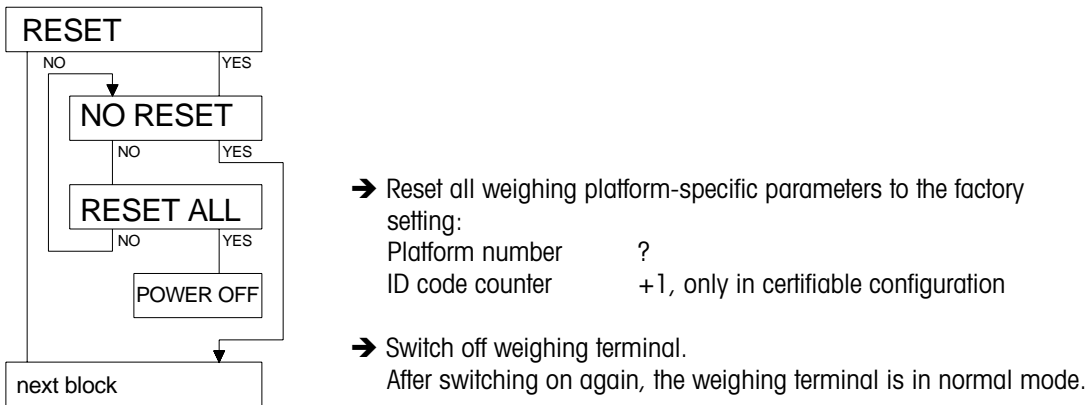
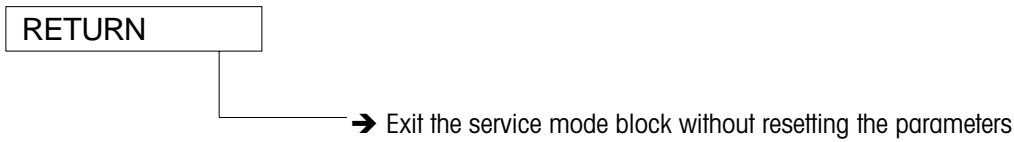

1.3.2 NATIONS – Country selection

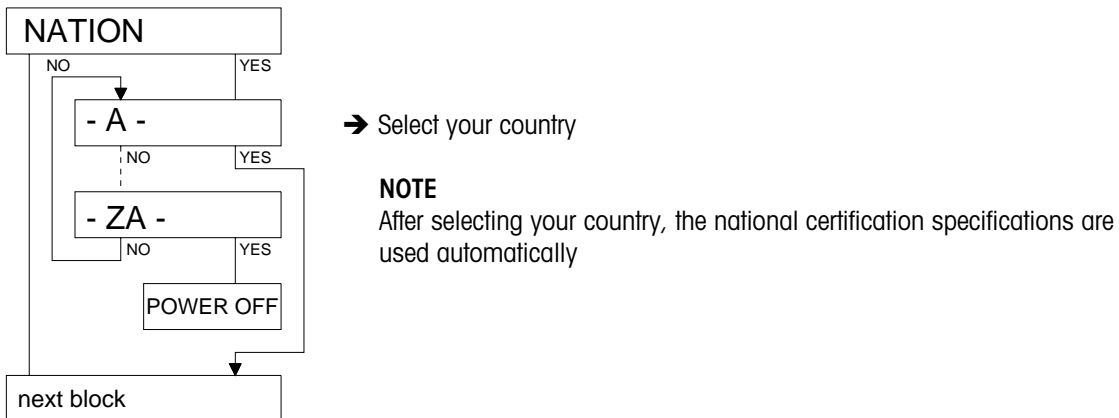

1.3.3 SCALE PARAMETERS –Selection of the weighing platform-specific parameters.

1. Select certifiability

- Certifiable scale
- Non-certifiable scale

2. Select type

Scroll through the menu selections until the correct model is found and press Enter. In addition to the listed K-base models, there is a selection entitled "Special Scale". Here it is possible to increase the weighing range beyond the normal weighing capacity of the scale model. (Bypass the "LEVER RATIO" PROMPT AND SET THE NUMBER OF Ranges, the readability and the increased capacity. The increased capacity will be limited to the normal weighing range, plus the assigned PRELOAD range. For example, the KA15s has a normal weighing range of 15 kg. The Preload range for this model is 6 kg (typical). Therefore, the maximum weighing range can be set to 21 kg. It may be necessary to perform a linearity adjustment when increasing the weighing range.

3. Select multi-interval or multi-range scale

The majority of K-Bases are used in the High Resolution Mode. In this mode, the selected readability remains the same throughout the entire weighing range. When used in the **single range** or **single interval** mode, there is no difference in the operation of the scale. However, these two modes operate differently when multiple ranges or intervals are selected.

- **Multi-interval scale with more than one interval**

When more than one interval is selected, an entry is requested for the capacity of the weighing interval, e.g., 15kg. This is followed by a request for the capacity of the first interval, e.g., 3kg. A request is then made for the readability of the first range, e.g., 0.001kg. These readabilities will differ depending on the scale model.

- **Operation in the multiple interval mode**

Using the above example, the selected readability will be maintained until the first range is exceeded. The readability will then switch to 0.002kg. This readability will then be maintained until the second interval is exceeded, at which time the readability will decrease to 0.005kg. If weight is removed from the scale, the finer readabilities will be displayed as the applied load is decreased through the defined intervals.

- **Effect of Taring**

If the selected weighing interval has been exceeded, and the readability has consequently changed, the highest readability can be regained by taring the scale. At this point the highest selected readability will be displayed until the applied load exceeds the first prescribed weighing interval.

- **Multi-range scale with more than one range**

When more than one range is selected, an entry is requested for the capacity of the weighing interval, e.g., 15kg. This is followed by a request for the capacity of the first interval, e.g., 3kg. A request is then made for the readability of the first range, e.g., 0.001kg. These readabilities will differ depending on the scale model.

- **Operation in the multiple range mode**

Using the above example, the selected readability will be maintained until the first range is exceeded. The readability will then switch to 0.002kg. This readability will then be maintained until the second interval is exceeded, at which time the readability will decrease to 0.005kg. If weight is removed from the scale, the coarsest readabilities achieved will be maintained until all weight is removed from the scale. For example, if 8kg was the loaded on the scale resulting in a readability of 0.005kg, and the weight was reved in incremental amounts, the readability of 0.005kg would be maintained until all weight was removed.

- **Effect of Taring**

If the selected weighing interval has been exceeded, and the readability has consequently changed, taring the scale will not recall the finer readability. The last readability will continue to be displayed as weight is removed with the negative value of the removed load displayed. The highest readability will not be regained until the full load is removed and the stored tare value erased by taring the scale.

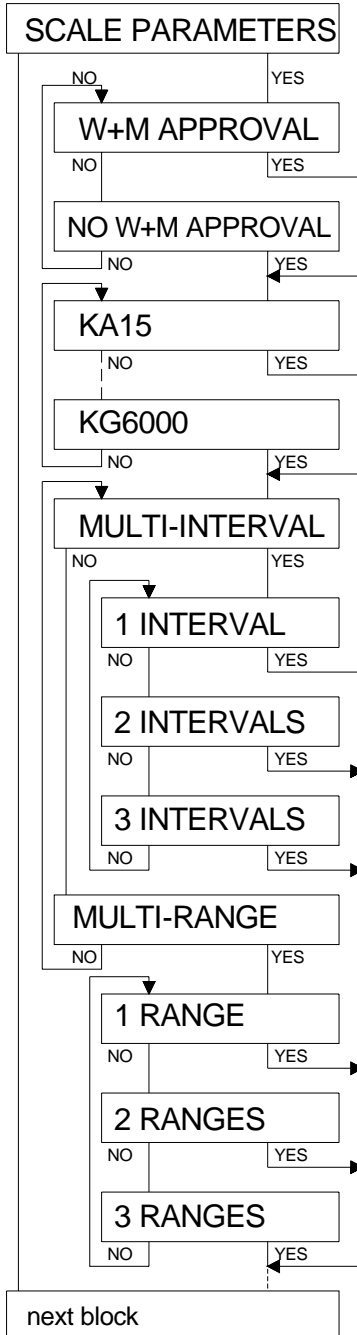

-- Continued --

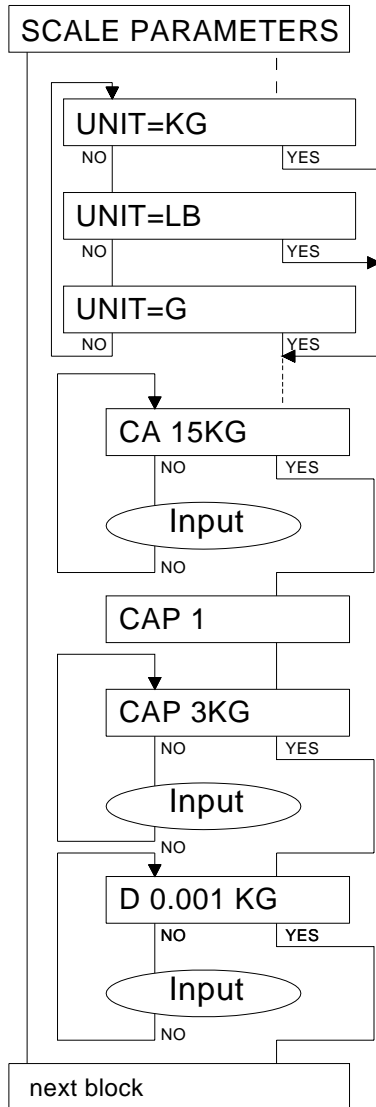

4. Select display and calibration unit

- Display in kg
- Display in lb, if permitted with certification
- Display in g

5. Select maximum load

- ➔ Accept currently set maximum load with YES
- or -
- ➔ Enter desired maximum load and confirm with YES

6. Define weighing ranges

(*only applicable for multi-range and multi-interval scales).

- ➔ Display for information: Weighing range 1.
- ➔ Accept currently set value for the first weighing range with YES
- or -
- ➔ Enter the desired value for the first weighing range and confirm with Yes

7. Select Interval value

- ➔ Accept currently set interval value for the first weighing range with YES
- With multi-range or multi-interval scales, the interval value of additional weighing ranges is determined automatically by the weighing terminal.
- or -
- ➔ Enter the desired interval value for the first weighing range and confirm with Yes

Note

The ERR_Rx message appears if one of the settings or a combination of settings was not permissible; x represents the weighing range. In this case, the program jumps back to Step 1.

1.3.4 LINEARITY – Measuring or entering the linearity

The linearity error can be compensated for in two ways:

- Via manual entry – for this, record the displayed weight value for the linearity weight before linearization and while still in normal weighing mode.
- or -
- Via measuring the supplied linearity weight.

Linearization should be performed with half of the selected maximum load.

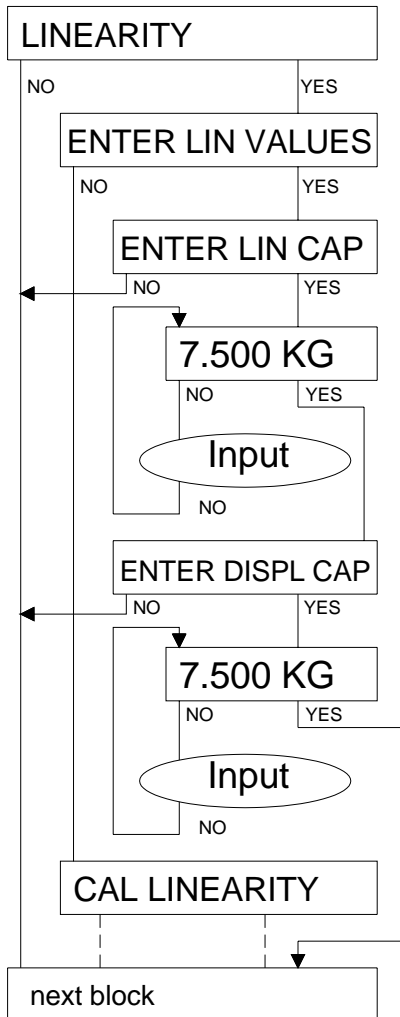

1. Linearization via manual entry

Enter linearity point or weight

- ➔ Accept currently set linearity weight, e.g. half-load with YES
- or -
- ➔ Enter desired linearity weight.

Enter linearity deviation

- ➔ Accept displayed weight value with YES
- or -
- ➔ Enter the weight value displayed when the previous linearity weight was applied and confirm with YES

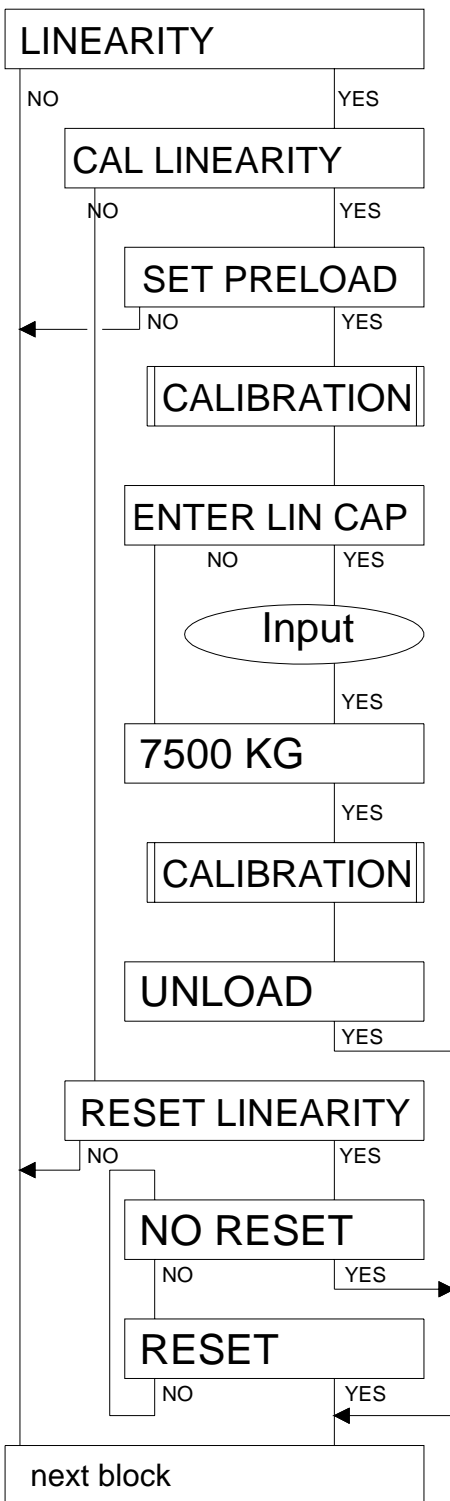

2. Linearization via measuring or applying the linearity weight

➔ Unload weighing platform, apply preload if available and confirm with YES

The weighing platform calibrates the zero point.

➔ Prompt: Enter linearity weight

➔ Enter the desired linearity weight and confirm with YES

➔ Apply linearity weight to weighing platform and confirm with YES

The weighing platform is calibrated with the linearity weight.

➔ Unload weighing platform and confirm with YES

3. Reset linearity compensation

➔ Do not reset the linearity compensation

➔ Completely reset the linearity of the weighing platform
Afterward, the weighing platform must be checked and, if necessary relinearized

1.3.5 CALIBRATION – Calibrating of the weighing platform

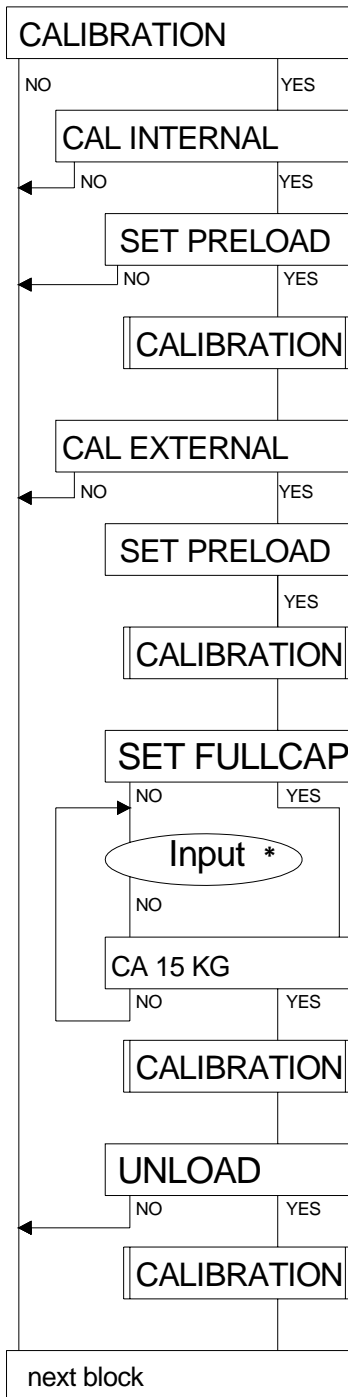

1. Calibrate the weighing platform internally with the in-built calibration weight.

➔ Load preload and confirm with YES

The weighing platform is calibrated internally.

2. Calibrate weighing platform with external weights

➔ Apply preload and confirm with YES

The weighing platform calibrates the zero point

➔ Prompt: Select full load.

➔ If desired, use NO to enter calibration weight smaller than the maximum load and confirm.

- or -

➔ Select the maximum load with YES

➔ Apply selected calibration weight to weighing platform and confirm with YES

The weighing platform calibrates the selected maximum load.

➔ Unload weighing platform and confirm with YES

The weighing platform rechecks the zero point

* Refer to Example 1 on page 3-13

1.3.6 ADAPTION –Setting application-specific parameters

The range adjustment for adjusting the endpoint (SPAN ADJUST), among other things, can be performed in this block. This adjustment can be performed in 2 ways:

- via manual entry – for this, record the displayed weight value for the test weight before adjustment
- or -
- via measuring the applied test weights

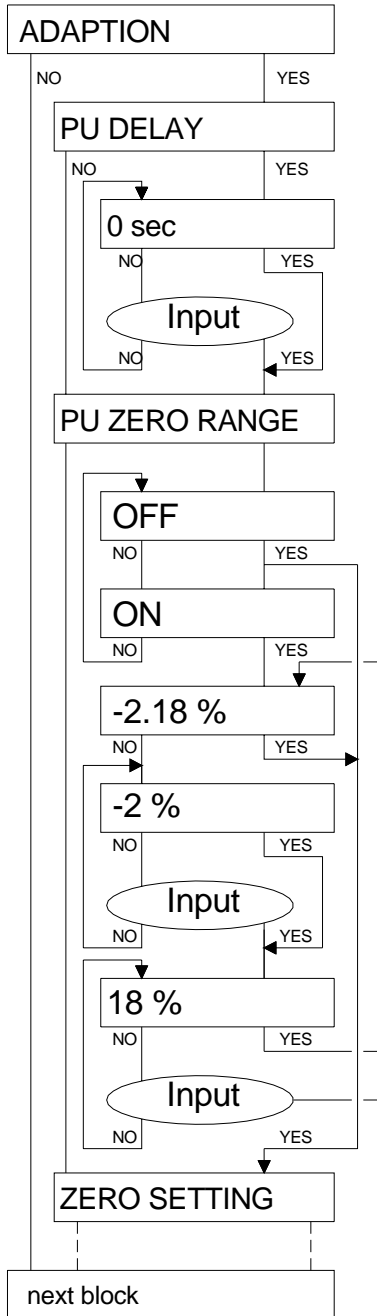

1. Delay time

- ➔ Enter additional delay time when switching on.

Depending on the environmental condition and degree of loading of the weighing platform, the system requires additional time for determining the switch-on zero point.

Possible settings: 0 ... 600 sec. if time delay is entered.

2. Zero-set range

- ➔ Deactivate the zero-set range:
With this the zero-set range can be shifted over the entire weighing range; only with a non-certifiable configuration.
- ➔ Activate the zero-set range:
The zero-set range is restricted to max. 20% of the weighing range in the **certifiable** configuration.
(from -19 % +1 % to -1 % + 19 %)
100 % of the weighing range is available for the zero-set range in the **non-certifiable** configuration
(from -99 % + 1 % to -1 % + 99 %)
- ➔ Change the lower limit of the zero-set range.
- ➔ Change the upper limit of the zero-set range.

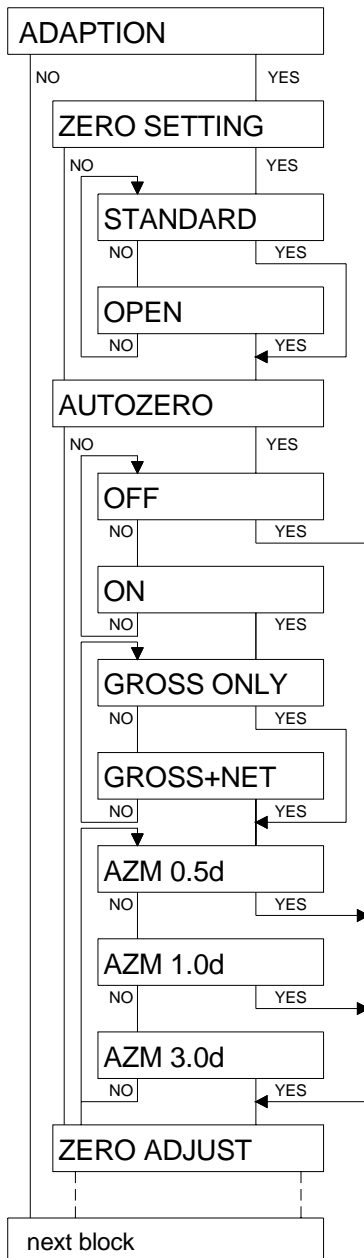

3. Select zero-set range

- Zero-set range of $\pm 2\%$ of the weighing range.
- Zero-setting over the entire weighing range is possible, but is only permissible in the non-certification configuration.

4. Activate/deactivate zero-point correction

- Automatic zero-point correction deactivated, but is only possible in the non-certifiable configuration.
- Automatic zero-point correction activated.
- Automatic zero-point correction for gross value.
- Automatic zero-point correction for gross and net value.
- Effective range of the automatic zero-point correction.
Only the value **AXM 0.5d** is permissible in the **certifiable** configuration.

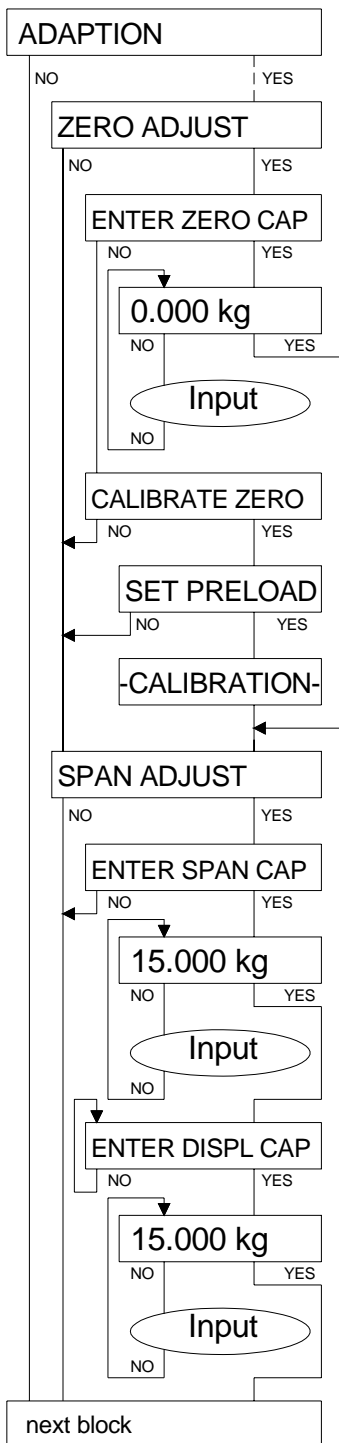

5. Zero-point shift

Note

Following a zero-point shift the weighing range must be checked again!

Via manual entry

- ➔ Enter weight value with sign and confirm with enter.
A positive sign raises the zero point, while a negative sign lowers it.

- or -

Zero-point shift with calibration

- ➔ Apply preload to weighing platform and confirm with YES

Weighing platform specifies new zero point.

6. Range adjustment

For adjusting the endpoint

- ➔ Prompt to select test weight
- ➔ Accept displayed test weight with YES
- or -
- ➔ Enter test weight and confirm with YES
- ➔ Prompt to enter previously read weight value for the test weight.
- ➔ Accept displayed value with YES
- or -
- ➔ Enter the read value for the test weight and confirm with YES.

Factory settings in the ADAPTION block

PU DELAY	Delay time	0 sec	
PU ZERO RANGE	Zero-set range	ON	
		Certifiable	-2.18 %
		Non-certifiable	-50 50 %
ZERO SETTING	Zero-set range	STANDARD (± 2 %)	
AUTOZERO	Auto zero-pt correction	ON	
		GROSS ONLY	
		AZM 0.5d	

1.3.7 SAVE PARAMETERS – Saving the selected configuration

The ID code counter is increased by one here. On certified scales, this corresponds to destroying a certification seal. A recertification is subsequently required.

1.4 ID code counter expired

The ID code counter runs to 99. Additional certifiable configurations are no longer possible after this, and the scale can then only be operated in a non-certifiable configuration.

The following messages appear in this case:

ERROR Acknowledge error message.

IDENT The error message then appears in plain text.

If Summing is Selected

1. No other parameters are entered in this sub-block. In the capacity sub-block, enter the total capacity of the summed scales. This value can be less than the total capacities of the individual scales. For a legal-for-trade summed scale, the calibration units and increment size should be identical for all scales.
2. Continue to the next sub-block or exit the setup mode.

3. Calibration Unit Sub-block

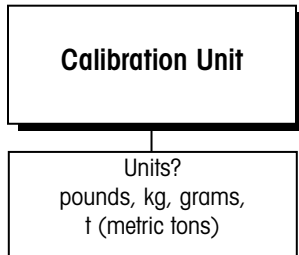

Note: The Calibration, Capacity and Increment Size sub-blocks appear only if summing scale was selected.

This sub-block lets you enter the units of measure to use when calibrating the scale and configuring capacity and increment size. Recalibration is required if you change the calibration unit.

1. Press ENTER at the **[Calibration Unit]** prompt to open the sub-block.
2. At the **[Units?]** prompt, press SELECT until the desired calibration unit is displayed, then press ENTER.

Calibration units include:

- Pounds
 - Kilograms
 - Grams
 - Metric Tons
3. Choices are limited to the current settings for the primary and secondary weight units specified in the Application Environment program block.
 4. Continue to the next sub-block or press ESC to exit the setup mode.

4. Capacity Sub-block

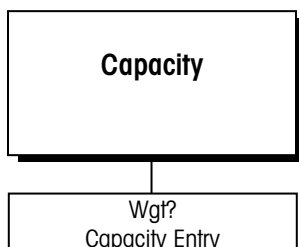

The Capacity sub-block lets you enter the maximum scale capacity. The capacity is given in the calibration units.

1. Press ENTER at the **[Capacity]** prompt to open the sub-block.
2. At the **[Wgt?]** prompt, input the desired scale capacity using the numeric keys.
3. Press ENTER to set the capacity.
4. Continue to the next sub-block or exit the setup mode.

5. Increment Size Sub-block

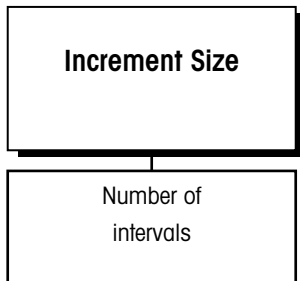

Note: W1, W2, and W3 on the display reflect the active weighing intervals in a multiranging configuration.

With a single weighing range configuration, the W1, W2, and W3 cursors are not used.

This sub-block lets you specify the increment size for one or more weighing intervals. Increment size is the smallest change in weight value that the terminal is able to display. For example, if the increment size is specified as 0.1 then, starting at 0.0 on the scale, adding an increasing load will cause the terminal to display 0.1, 0.2, 0.3 and so on through the entire weighing range of the scale.

If two or three intervals are selected, the operation is as described above except that two or three increments are now used over portions of the weighing range. For example, consider a scale configured for two intervals with the low increment specified as 0.1 and the high increment as 0.2. The scale displays weight by 0.1 increments through the first interval until the weight reaches the "low to high" (LoHi) threshold point, then by 0.2 increments through the second interval to capacity. Increments may count by 1, 2, or 5.

There are two types of multiple increment size operation. Multiple range weighing applies to all scale bases except METTLER TOLEDO's IDNET bases. Multi-interval weighing applies only to METTLER TOLEDO's IDNET bases. The terminal will determine which type of operation to use according to the scale type selected in setup.

To configure the increment size:

1. Press ENTER at the [**Increment Size**] prompt to open the sub-block.
2. At the [**Nbr of Intvls?**] prompt, use the SELECT key to choose 1, 2 or 3 intervals.

If 1 Interval Selected

At the [**Low?**] prompt, enter the low increment size (0.00001-100).

If 2 Intervals Selected

1. At the [**Low?**] prompt, enter the low increment size (0.00001-100).
2. At the [**High?**] prompt, enter the high increment size (0.00001-100). The high increment must be greater than the low increment.
3. At the [**LoHi?**] prompt, enter the weight value where the scale will switch from the low increment to the high increment.

If 3 Intervals Selected

1. At the [**Low?**] prompt, enter the low increment size (0.00001-100).
2. At the [**Mid?**] prompt, enter the mid increment size (0.00001-100). The mid increment must be greater than the low increment.
3. At the [**High?**] prompt, enter the high increment size (0.00001-100). The high increment must be greater than the mid increment.
4. At the [**LoMid?**] prompt, enter the weight value where the scale will switch from the low increment to the mid increment.
5. At the [**MidHi?**] prompt, enter the weight value where the scale will switch from the mid increment to the high increment. The MidHi threshold must be higher than the LoMid threshold. Continue to the next sub-block or exit the setup mode.

6. Shift Adjustment Sub-block

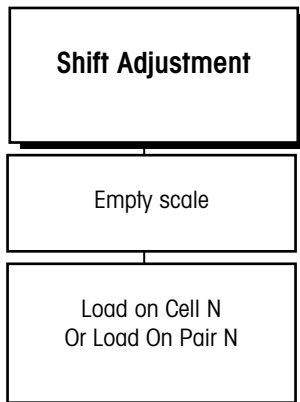

The Shift Adjustment sub-block lets you adjust multiple load cells connected to a DigiTOL J-Box or POWERCELL (or RAAD box) scale. NOTE: It only appears if you selected DigiTOL J-Box or POWERCELL in the Scale Type sub-block.

1. Press ENTER at the [**Shift Adjustment**] prompt to open the sub-block.
2. At the [**Empty the Scale**] prompt, remove any weight on the platform, then press ENTER. The display reads [**Capturing Zero**] as the terminal captures zero.
3. At the [**Load On Cell N**] or [**Load On Pair N**] prompt, place a test weight on the platform that weighs approximately 50% of the scale's capacity. The JAGXTREME terminal automatically shift adjusts the scale for the current load cell as the display reads [**Capturing Cell N**] or [**Capturing Pair N**].
4. Repeat steps 2 and 3 for each load cell/pair connected to the DigiTOL J-Box or POWERCELL (RAAD Box). When all load cells are shift adjusted, the terminal indicates [**Shift Complete**]. Continue to the next sub-block or exit setup.

7. Linearity Correction Sub-block

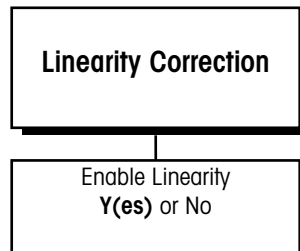

Linearity correction lets you calibrate the scale using reference weights at mid-scale and full-scale ranges. Linearity correction allows for compensation of the non-linear performance of a load cell(s) or weighing system. If linearity correction is enabled, the calibration process requires additional steps. The terminal must be calibrated or recalibrated after you enable linearity correction.

1. Press ENTER at the [**Linearity Corr**] prompt to open the sub-block.
2. Select [**Y(es)**] to enable or [**N(o)**] to disable linearity correction. Continue to the next sub-block or exit the setup mode.

8. Calibration Sub-block

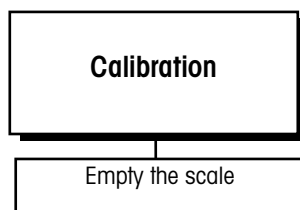

Calibration involves emptying the scale then placing a known test weight on an empty platform and allowing the JAGXTREME terminal to capture values for zero and span. You can calibrate a scale with or without linearity correction. The JAGXTREME terminal prompts you through the calibration.

If you are calibrating two internal scales, you must have two scales selected (Scale Type sub-block), then exit the setup mode after the first scale is calibrated. After exiting, select the second scale. Finally, enter setup mode to calibrate and set the other parameters associated with the scale.

Note: The prompts that follow the **Empty the Scale** prompt will be depend on if you are calibrating the scale with or without linearity correction.

Without Linearity Correction

1. Press ENTER at the [**Calibration**] prompt to open the sub-block.
2. At the [**Empty the Scale**] prompt, remove any weight on the platform, then press ENTER. The terminal automatically captures zero and the cursor moves across the lower display indicating the operation is in progress.
3. At the [**Add Test Weight**] prompt, place on the platform a test weight equaling the scale's capacity or another practical weight. Press ENTER.
4. A minimum of 20% of scale capacity is necessary for calibration; METTLER TOLEDO recommends 60 to 100%. A calibration error will result if insufficient weight is used.
5. At the [**Wgt?**] prompt, input the amount of weight you added in step 3. Press ENTER. The terminal automatically captures span and the cursor moves across the lower display indicating the operation is in progress.
6. When the display reads [**Calibration Successful**], continue to the next sub-block or exit the setup mode.

With Linearity Correction Enabled

1. Press ENTER at the [**Calibration**] prompt to open the sub-block.
2. At the [**Empty the Scale**] prompt, remove any weight on the platform then press ENTER. The terminal automatically captures zero and the cursor moves across the lower display indicating the operation is in progress.
3. At the [**Add MidScale Wgt**] prompt, place a weight on the platform equaling between 35% and 65% of the scale's capacity.
4. At the [**Wgt?**] prompt, input the amount of weight you added in step 3. Press ENTER. The terminal automatically captures mid-scale.
5. At the [**Add FullScale Wgt**] prompt, place weight on the platform equaling at least 90% of scale capacity or as much as is practical. Press ENTER.
6. At the [**Wgt?**] prompt, input the amount of weight you added in step 5. Press ENTER. The terminal automatically captures full scale and the cursor moves across the lower display indicating the operation is in progress.
7. When the terminal indicates [**Calibration Successful**], press ENTER. Continue to the next sub-block or exit the setup mode.

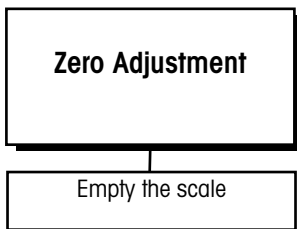
9. Zero Adjustment Sub-block

The zero value is the scale-empty reference as determined during calibration. The Zero Adjustment block lets you re-establish this value to compensate for any change since the last calibration. The scale must be empty before resetting the zero value.

1. Press ENTER at the [**Zero Adjust**] prompt to open the sub-block.
2. At the [**Empty the Scale**] prompt, remove any weight on the platform and press ENTER. The terminal automatically captures zero and displays the message [**Zero Adjusted**]. Continue to the next sub-block or exit the setup mode.

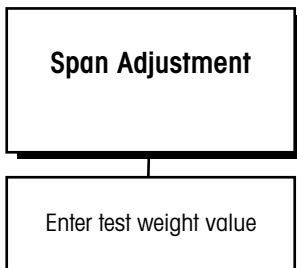
10. Span Adjustment Sub-block

The Span Adjustment sub-block lets you make minor span adjustments without completely recalibrating the scale.

1. Place a test weight on the platform and press ENTER at the [**Span Adjust**] prompt to open the sub-block.
2. At the [**Add Test Weight**] prompt, enter the amount of weight placed on the platform in step 1.
3. The terminal captures the new span. When finished the terminal displays the message [**Span Adjusted**]. Continue to the next sub-block or exit setup.

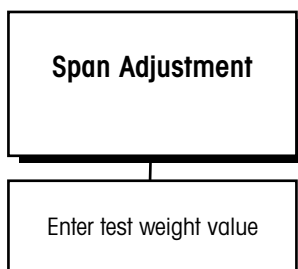
11. Scale Test Sub-block

This sub-block lets you view the actual weight on the scale without exiting setup. The top display will show the actual weight on the scale platform.

12. Add in Sum Sub-block

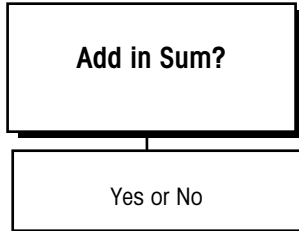

This sub-block allows you to include the selected scale's weight in the summing scale.

1. Select **[Y(es)]** to include the scale in the sum.
2. Select **[N(o)]** to exclude the scale from the sum.

13. Gravity Adjustment Sub-block

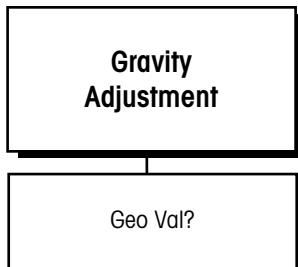

This sub-block allows you to enter a factor to compensate for gravitational differences between the factory calibration location and where the scale is currently located. If on-site calibration has already been performed, leave this value set to the factory default. When you access the Gravity Adjust sub-block, the current value is displayed.

1. Press ENTER at the **[Gravity Adjust]** prompt to open the sub-block. The display reads **[Geo Val?]** and shows the current adjustment value.
2. Press ENTER to accept the current factor or to enter a new gravitational factor. Use the GEO table in the appendix to determine the appropriate constant.
3. Return to the first sub-block or exit setup mode.

14. Reset to Factory Sub-block

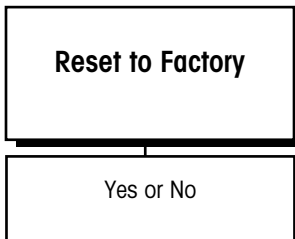

Reset to Factory returns all parameters in the current block to the original factory settings.

1. Select **[Y(es)]** to return all parameters to the original factory settings.
2. Select **[N(o)]** to retain the new parameters.

Using the JAGXTREME with IDNET Bases

Note: The JAGXTREME terminal does not support “open mode” operation of the IDNET bases.

The following procedure is for use with multi-range K-base only. By following the sequential steps listed below, you can calibrate a typical multi-range K-base with a JAGXTREME terminal. Note: For calibrating other compatible scales such as the PR/SR, PM/SM or others, see the appropriate menu. For more specific information on K-bases (IDNET bases), you should refer to the documentation for the specific base with which you are working.

Service Mode for IDNET Bases

The service mode for IDNET bases is used for:

- Input of parameters specific to the weighing platform after replacement of the measuring cell
- Calibration of the base with the calibration weight built into the measuring cell or externally by loading the base with the required weights
- Adjustment of linearity
- Resetting of the measuring cell parameters to the factory setting
- Clearing of a previously assigned scale number.

An IDNET base can generate three different types of communications errors and a general function failure indication during Service Mode operation. They may be cleared by pressing the ENTER or ESC keys.

JAGXTREME IDNET Calibration procedure

Use the procedure described on the next few pages to configure the JAGXTREME scale interface for use with IDNET bases.



The SERVICE mode is navigated by using a combination of the SELECT and ENTER keys as responses to the various displayed menu prompts.



The SETUP mode is entered by pressing the FUNCTION key. (SW2-1 is off).

To begin:



Press the FUNCTION key.

- SWITCH UNITS

The SWITCH UNITS block appears only if unit switching is enabled in the Application Environment program block.



Press the SELECT key.

- CAL VALUES

If CAL VALUES is selected, the contents of a counter will be displayed [IDENTCODE =] which indicates the number of times the scale has been calibrated if it has been configured as “Legal for Trade” (APPROVED). Non-certified scales will only show [-- --] following

Chapter 3: Programming and Calibration Using the JAGXTREME with IDNET Bases

[IDENTCODE =]. This selection will also show the software version installed in the K-cell. The ESC key must be used to exit this menu step.



Press the SELECT key.

If SELECT is pressed, the display will return to the normal weighing mode.



Press ENTER.

If SELECT is pressed, the menu choices will be diverted to the APPLICATION ENVIRONMENT menu. (Refer to Chapter 2, Programming and Configuration, for an overview of the options available in this menu.) Use the ESC key to escape from this menu and return to the SCALE INTERFACE menu.



Press ENTER.

If ENTER is selected, the operation of the terminal will be limited by the "Legal-for-Trade" requirements of the country selected.



Press SELECT.

If the SELECT key is pressed, the next three steps in the menu are by-passed and [SERVICE MODE] is displayed.



Press ENTER.
1 or 2



Use the SELECT key to select number of installed IDNet boards.

Note: In some models, the display may read
TYPE? HI PREC



Press ENTER.

Use the SELECT key to select IDNET.



Press ENTER.

Use the SELECT key to choose which scale board to configure.



Press ENTER.



If SELECT is pressed the menu loops on RESET to FACTORY, MARKET, and SCALE TYPE. Pressing ESC allows exit to the normal weighing mode.



Press ENTER.

Wait until the [RETURN] prompt appears on the **JAGXTREME** display.

- 

Press the ESC key to begin exiting the SETUP mode.
- 



Press either SELECT or ENTER to access the beginning of the SERVICE MODE menu.
- 

If ENTER is pressed, this step allows the scale number to be replaced by a question mark in preparation for reassigning a different scale number, as well as setting the scale parameters to the factory defaults.

RESET
- 

Press SELECT.

NATION

This allows you to select the country where the terminal is being used. As a result, the certification regulations of the country are set.
- 

Press SELECT.

SCALE
- 

Pressing ENTER allows the scale to be set for either APPROVED (legal-for-trade) or NON-APPROVED.
- 

Press ENTER.

NO APPR
- 

Press the SELECT key to configure scale as Approved or Legal-for-Trade. The operation of the scale will then be bound by the legal requirements of the country in which it is being installed. Be sure to select the appropriate country in the [NATION] step.
- 

Press ENTER.

Model e.g., KA15
- 

Pressing SELECT scrolls through the various scale model selections.
- 

Press ENTER.

CAP e.g., 15 kg
- 

Press SELECT to choose from various maximum weighing ranges in either pounds or Kilograms. This selection will determine the primary unit of weight.
- 

Press ENTER.

D=0.0001 kg
(readability)



Press SELECT to choose readability. The selections preceded by MR switch through three weight-dependent ranges (3X 3000 divisions) with the readability varying as the ranges change. The selections preceded by D are single-weight ranges in which the readability remains the same throughout the weighing range. Those platforms containing MONOBLOC cells permit the selection of grams as the primary unit. To select grams as the primary unit, select KG in the capacity step and grams in the readability step.



Press ENTER.

This menu step only appears when a MONOBLOC cell is installed in the weighing platform. The MONOBLOC cells can be recognized by the stainless steel case enclosing the weighing cell. Conventional weighing cells are enclosed in black, epoxy painted, cast aluminum housings. If the ENTER key is pressed, a selection of [OPEN] or [STANDARD] can be chosen. OPEN refers to "Open Zero", sometimes referred to as 100 % preload. This selection allows any weight within the normal weighing range plus the scale specific preload range to be zeroed on power up.



Press SELECT.

This allows the linearity of the scale to be corrected. This is a complex procedure and should only be performed by scale Technicians trained in the proper correction method.



Press SELECT.

This program sub-block is used to calibrate the scale. Calibration can be performed using either the internal calibration weight contained within the weighing cell (in those scale models that contain internal weights) or by using external calibration weights. If external weights are used, care should be given to the class of weights used. For example, K- bases should be calibrated with class F1 weights. If other scale types are used, e.g., SM/PM, RGB, refer to their respective operating instructions for the correct classification.



Press ENTER.

This step establishes the deadload (Initial) weight of K-base weighing platforms. This step cannot be bypassed. If a fixed load such as a container or roller track is to be kept on the scale base, it should be put in place now. The load may not exceed the preload specification for the platform currently being calibrated even though 100% preload software is installed in the base. This is also true if a monobloc cell is being installed and the mode is selected for "Open Zero". Refer to the sale base Operating Instruction for the maximum preload value. If no fixed load is to be used, simply press ENTER.



Press ENTER.

If the scale is to be calibrated using external calibration weights, press ENTER. To calibrate with the internal calibration weight in the weighing cell, press the SELECT key.



Press ENTER.

--CAL--

FULL CAP



If external calibration is to be performed using weights equal to the maximum capacity of the scale, press ENTER.

C (MAX CAPACITY)



Place calibration weights equivalent to the maximum weighing capacity of the scale and press ENTER.



Press SELECT.

C_ _ _ _ 0; UNIT



If the scale is to be calibrated with calibration weights that are less than full capacity, press the SELECT key.

The amount of weight to be used for calibration can be entered using a combination of the ENTER and SELECT keys according to the follow procedure:

- Use the ENTER key to fill in the spaces to the left of the right most zero.
- Pressing the SELECT key will increment the right most zero to the desired value.



Example: If a calibration weight value of 25 kg is to be entered, press the ENTER key three times so that the display will show C _ 0000:kg.

C_0000: KG



Press the SELECT key twice to increment the right most zero to a 2. The display will now show C_ 0002:kg.

C_0002: KG



If the digit is mistakenly incremented beyond 2, repeatedly press SELECT until the correct number is displayed. NOTE: The digit cannot be decremented.



Press ENTER to fill in another zero resulting in a display of C 0002: kg.

C00020: KG



Use the SELECT key to increment the right most digit to a 5. The display should now show C00025: kg.

C00025: KG



Place the 25 kg weight on the platform and press ENTER.

The scale goes through the calibration sequence.

--CAL--

Remove the calibration weights.

UNLOAD



Press ENTER.

--CAL--



By pressing ENTER, any changes made in the Service Mode will be saved.

SAVE



Press ENTER to access the scale summary parameter.

ADD IN SUM?

Y(es) adds this scale into the logical sum.

N(o) does not add the scale into the logical sum.



Press ENTER.



Press Esc to exit Setup mode.

NATION Sub-block

This program sub-block allows the selection of the country of use, which sets the certification regulations for that country. Use the SELECT key to display the various country codes. The codes and country names are listed below.

Code	Country	Code	Country	Code	Country
A	Austria	AS	Saudi Arabia	AUS	Australia
B	Belgium	BR	Brazil	CDN	Canada
CH	Switzerland	D	Federal Republic of Germany	DK	Denmark
E	Spain	ET	Egypt	F	France
FL	Liechtenstein	GB	Great Britain	GR	Greece
HK	Hong Kong	I	Italy	IL	Israel
IND	India	IRL	Ireland	IS	Iceland
J	Japan	JOR	Jordan	KWT	Kuwait
L	Luxembourg	MAL	Malaysia	MEX	Mexico
N	Norway	NL	Netherlands	NZ	New Zealand
P	Portugal	RA	Argentina	RC	Taiwan
RCH	Chile	S	Sweden	SF	Finland
SGP	Singapore	SUD	Sudan	T	Thailand
TJ	China	USA	United States	YU	Yugoslavia
ZA	South Africa	ZK	South Korea		

When the appropriate country code is displayed, press ENTER to accept the choice.

RESET Sub-block

In this program sub-block, the certification capability, maximum capacity, range and graduation size can be reset to the factory default settings.

1. To reset the parameters to factory default, press SELECT until the display shows [**Y(es)**].
2. Press ENTER. The display will show [**NO RES**].
3. To exit this sub-block, press ENTER. To reset the parameters, press SELECT until the display shows an [**N(o)**]. Press ENTER. The display will then show [**RES ALL Y**].
4. Press ENTER to confirm your choice. If you wish to exit without resetting the parameters, press SELECT then ENTER.
5. If you have chosen to reset to factory defaults, [**POWER OFF**] appears in the display. The terminal must be powered down and then power reapplied. The base will be calibrated internally. The weighing platform will be assigned a new scale number.

SCALE PARAMETERS Sub-block

The display shows **[SCALE]**, allowing you to set certification capability, maximum capacity, range, and graduation.

1. With **[Y(es)]** displayed, press ENTER.
2. The display shows **[NO APPR]** to allow selecting the scale for a non-certified mode of operation. Use the SELECT key to change to **[APPR]**, then confirm your choice by pressing ENTER.
3. The various types of K bases are displayed using the SELECT key. When the appropriate base model number appears in the display, use the ENTER key to select that choice.
4. The display shows **[CAP xxx kg]**, indicating the maximum capacity of the selected weighing platform. The maximum capacity at which the scale operates is selectable in three stages (full, half, or quarter). Press SELECT to step through the capacity choices. Press ENTER to choose the displayed answer.
5. The readability of the base can be set using the SELECT key. When the display shows **[MR]**, the display shows the display readability of the first range of a multirange scale. When the display shows **[D]**, the displayed accuracy of a single range base is shown.

Note: Depending on the country selected in the NATION sub-block, the capacity may be displayed in pounds.

LINEARITY Sub-block

After a measuring cell is replaced, or the stored linearity code is changed, it must be re-entered. The linearity code is located at the rear of the identcode bracket.

1. The display shows **[LINEA]**. Press ENTER to enter this sub-block.
2. The display indicates the current stored value **[LINEA +XXXX]**. Choose the sign of the linearity code by using the SELECT key. When the proper sign is displayed, use the ENTER key to confirm your choice.
3. Enter the linearity code using a combination of the SELECT key and the ENTER key. The ENTER key will insert zeros in place of the dashes.
4. The SELECT key is used to increment the right-most zero to the desired number. When the displayed value is correct, press ENTER.

CALIBRATION Sub-block

This program sub-block is used to calibrate the scale.

1. The display shows **[PRELOAD]**. Empty the scale. If a vessel or other container is to be included, place this on the weighing platform. Press ENTER. The display shows **[CALIB]**, and internally calibrates.
2. The display shows **[CAL EXT]**. If calibration using test weights is desired, press ENTER. To go on to internal calibration, press SELECT.
3. If external calibration has been selected, the display shows **[FULL CAP]**. Press ENTER to calibrate using test weights equal to the maximum capacity of the base. Press SELECT to use the selected capacity of the base. Press SELECT again to enter a calibration weight other than the preset values. Enter the test weight value using a combination of the SELECT key and the ENTER key as follows:
 - Press the ENTER key to insert zeros from right to left.
 - Press the SELECT key to increment the required position.
4. When the desired weight value is displayed, place the corresponding test weights on the platform and press ENTER.
5. The base completes the calibration process with the test weight. The display then shows **[UNLOAD]**. Remove the test weight. The base re-establishes the zero value when you press ENTER.

SAVE PARAMETERS Program Sub-block

To save the programmed values, press ENTER. For certified scale applications (legal for trade), the identcode counter increments by one after confirmation (pressing of the ENTER key). This corresponds to destroying the certification seal. Recertification of the scale must be implemented according to local regulations.

RETURN Sub-block

If the parameters were not stored using the previous program sub-block, you may return to normal operation by pressing ENTER at this step. Changes to parameters and calibration will NOT be stored, and the identcode counter will not increment.

Application Environment Program Block

The Application Environment program block lets you set the features of the scale that are specific to the customer's application. The following diagram describes this block:

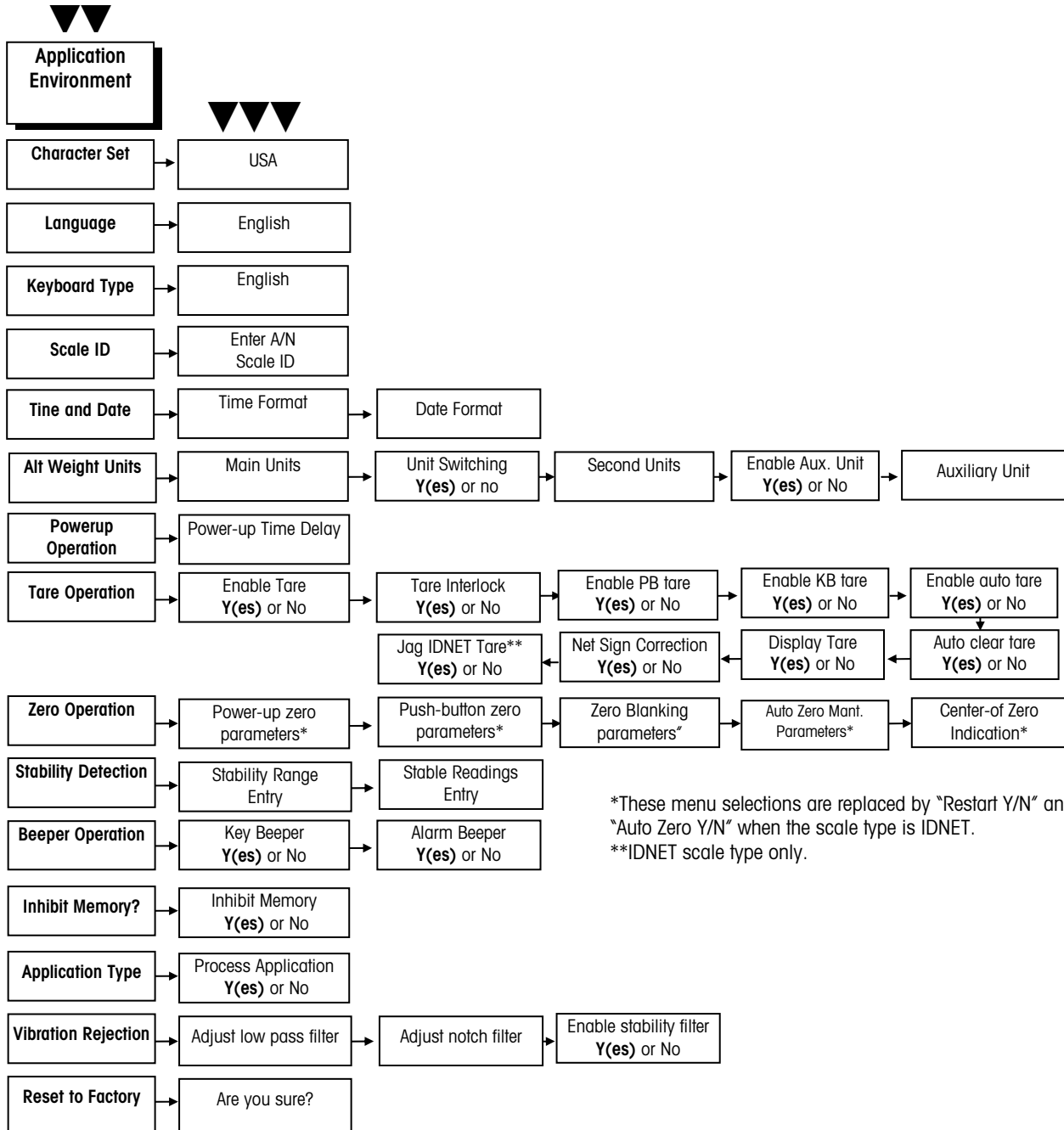

*These menu selections are replaced by "Restart Y/N" and "Auto Zero Y/N" when the scale type is IDNET.
 **IDNET scale type only.

1. Character Set Sub-block

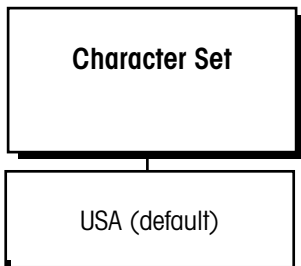

The Character Set sub-block lets you select a display character set appropriate for the location where the terminal is used. Depending on the character set, some ASCII characters will be replaced with specific international characters.

To configure the sub-block:

1. Press ENTER at the [**Character Set**] prompt.
2. At the [**USA**] prompt, press SELECT to display the desired character set.
3. Press ENTER to continue to the next sub-block or ESC to exit setup.

2. Language Sub-block

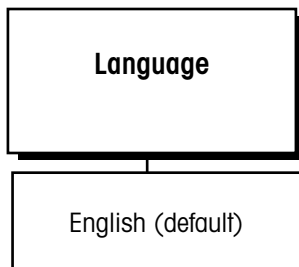

The Language sub-block lets you select the language in which all JAGXTREME terminal prompts and messages are displayed.

To configure the sub-block:

1. Press ENTER at the [**Language**] prompt.
2. At the [**English**] prompt, press SELECT to display the desired language:
 - English
 - French
 - German
 - Spanish
3. Press ENTER to continue to the next sub-block or ESC to exit setup.

3. Keyboard Type Sub-block

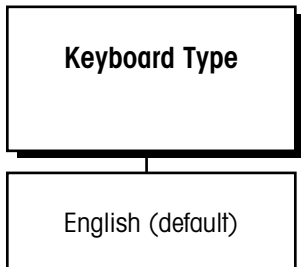

The Keyboard Type sub-block lets you select the type of alternate computer-type keyboard (if used). It does not configure the JAGXTREME terminal keypad.

1. Press ENTER at the [**Keyboard Type**] prompt.
2. At the [**English**] prompt, press SELECT to display the desired keyboard type:
 - English
 - French
 - German
 - Spanish
3. Press ENTER to continue to the next sub-block or ESC to exit setup.

4. Scale ID Sub-block

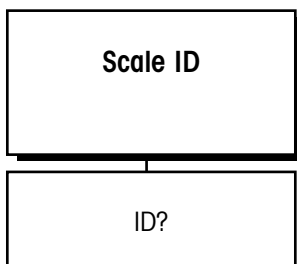

The Scale ID sub-block lets you assign an identification code to a scale for use in printing and when selecting a scale for operator viewing or interaction. The Scale ID can be up to 8 alphanumeric characters.

1. Press ENTER at the [**Scale ID**] prompt.
2. At the [**ID?**] prompt you can either select a predefined scale identification or create a new ID using the numeric keys to enter the scale identification label.
3. Press ENTER to continue to the next sub-block or ESC to exit setup.

5. Time and Date Sub-block

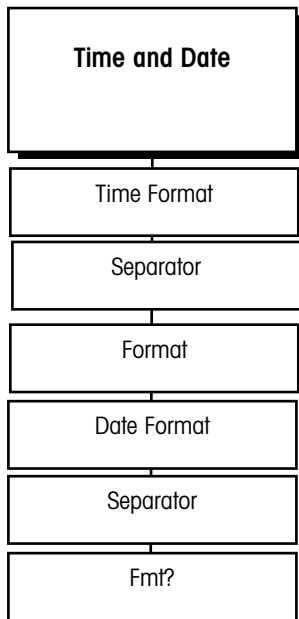

This sub-block lets you set the time and date format. If you do not select a format, the default time and date format based on the Market location will be used.

To configure the sub-block:

1. Press ENTER at the [**Time and Date**] prompt and again at [**Time Format?**]
2. At the [**Separator?**] prompt, select a character to separate hour, minutes, and seconds:
 - (:) colon
 - (-) dash
 - (.) period
 - (sp) space
 - None
3. At the [**Format?**] prompt, select the desired time format:
 - 24:MM 24 hour clock, no seconds
 - 24:MM:SS 24 hour clock with seconds
 - 12:MM 12 hour clock, no seconds
 - 12:MM:SS 12 hour clock with seconds
 - None Time disabled through MEMORY key
4. Press ENTER at the [**Date Format?**] prompt.
5. At the [**Separator?**] prompt, select a character to separate month, day, and year:
 - (:) colon
 - (-) dash
 - (.) period
 - (sp) space
 - (/) slash
 - None
6. At the [**Fmf?**] prompt, select the desired date format:
 - DD/MMM/YYYY Day (num), Month (alpha), Year (4 digits)
 - DD/MM/YY Day (num), Month (num), Year (2 digits)
 - MM/DD/YY Month (num), Day (num), Year (2 digits)
 - MMM/DD/YYYY Month (alpha), Day (num), Year (4 digits)
 - YY/MM/DD Year (2 digits), Month (num), Day (num)
 - YYYY/MMM/DD Year (4 digits), Month (alpha), Day (num)
 - None Date disabled through MEMORY key
7. Press ENTER to continue to the next sub-block or press ESC to exit the setup mode.

Note: The time format choices are given with the separator you selected in step 2.

A Julian date is maintained by the terminal and is available for printing.

The date format choices are given with the separator you selected in step 5.

6. Alternate Weight Units Sub-block

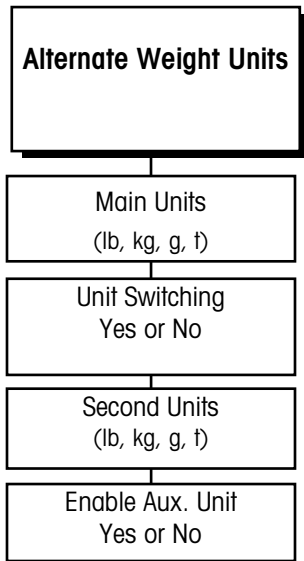

Note: After the **Enable Aux Unit** prompt, the prompts will depend on whether or not auxiliary units were enabled or disabled and if a custom unit was selected.

The unit selected for calibration must be either main or secondary units.

If auxiliary units are enabled, tare cannot be displayed in the lower display.

Alternate weight units selection is reset to factory default under the Scale Interface Program Block, NOT the Application Environment Program Block.

Note: Auxiliary Units must be enabled to use the rate function.

The Alternate Weight Units sub-block lets you select the unit(s) of measure for the top weight display, enable or disable units switching, or specify another unit of measure for the lower display in addition to the main units shown in the top display. You can select an alternate weight unit from various pre-programmed standard units or create a special unit with a custom name and conversion factor.

To configure the sub-block:

1. Press ENTER at the **[Alt Weight Units]** prompt to open the sub-block.
2. At the **[Main Units?]** prompt, select a main unit. Choose one:
 - lb (pounds)
 - kg (kilograms)
 - g (grams)—a decal over the kg legend is required
 - t (metric tons)—a decal is required
3. At the **[Unit Switching?]** prompt, select **[Y(es)]** or **[N(o)]** to enable or disable unit switching. If unit switching is enabled, it will switch between Main Units and Second Units. METTLER TOLEDO recommends disabling unit switching to avoid confusion if setpoints are used.
4. At the **[Second Units?]** prompt, select a secondary weight unit. Choose one:
 - lb (pounds)
 - kg (kilograms)
 - g (grams)—a decal over the kg legend is required
 - t (metric tons)—a decal is required
5. If the main units selected above are not the calibration units (as selected in the Scale Interface Program Block, Calibration Units Sub-Block), this choice is restricted to the Calibration Units.
6. At the **[Enbl Aux Unit?]** prompt, select **[Y(es)]** or **[N(o)]** to enable or disable the display of another unit of measure on the bottom display.

If Auxiliary Units Are Enabled

1. At the **[Aux Unit?]** prompt, select the desired pre-programmed auxiliary unit conversion factor or define a custom unit. The auxiliary unit selected here also applies to the rate function. Selections include:

• lb	• dwt
• kg	• t
• g	• ton
• oz	• custom
• lb-oz	• ozf

If Custom Unit Is Selected

1. At the **[Factor?]** prompt, enter a conversion factor. This factor is the number that will be multiplied by the main units to calculate the custom unit. Some rounding error may occur since this calculation uses a higher internal resolution to determine the converted value. Make sure that the maximum converted value does not exceed the display capacity of the lower display.
2. At the **[Name?]** prompt, enter the name for the custom unit, up to six characters.
3. At the **[Rate Enabled?]** prompt, select **[Y(es)]** or **[N(o)]** to enable or disable the rate parameters for the custom unit. Rate parameters define the period of time JAGXTREME terminal uses when displaying average weight change. If disabled, JAGXTREME terminal continues to the next sub-block. If enabled, configure the next two parameters.

4. At the **[Time Units?]** prompt, select the rate function time units. Options include:
 - Sec—average weight change per second
 - Min—average weight change per minute
 - Hour—average weight change per hour
5. At the **[Int Period?]** prompt, use the numeric keys to enter the sampling period (in seconds) that the terminal will use to calculate the average weight change for the time units selected above. You must enter a value between 1 and 60.
6. At the **[Interval?]** prompt, use the SELECT key to select 1/2 sec(ond), 1 sec(ond), or 5 sec(onds). This determines how often the terminal calculates a new rate value. Use 1 sec if you have a fast process which requires the most current rate value. Use 5 sec when you want a smoother rate value.
7. Continue to the next sub-block or exit the setup mode.

7. Power Up Operation Sub-block

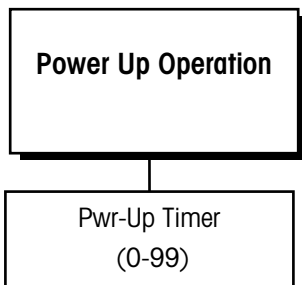

The Power Up Operation sub-block lets you specify a time delay before the scale is operational. This allows a sufficient warm-up period for stabilizing the scale and load cell electronics. The terminal displays a countdown clock indicating the time remaining in the specified warm-up period.

To configure the sub-block:

1. Press ENTER at the **[Power-Up Oper]** prompt.
2. At the **[Pwr-Up Timer?]** prompt, enter the number of minutes (0-99) that the terminal will delay before indicating the weight in normal operating mode. Power up zero capture is delayed while the timer runs.
3. Continue to the next sub-block or exit the setup mode.

8. Tare Operation Sub-block

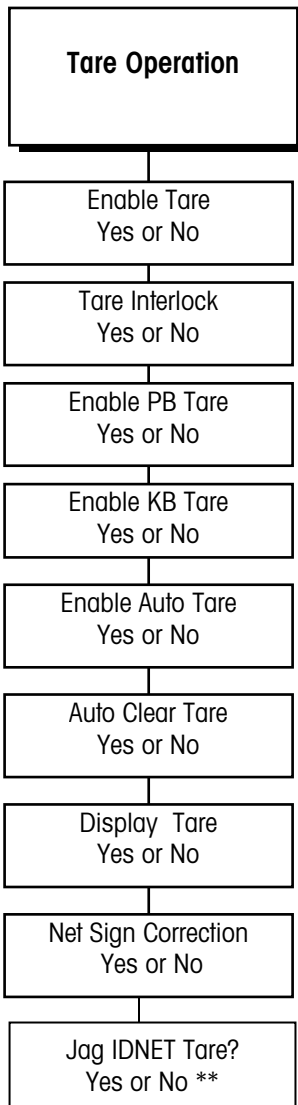

The Tare Operation sub-block lets you enable or disable the various tare options offered in the JAGXTREME terminal.

Pushbutton Tare—If enabled, pushbutton tare subtracts the weight of an empty container on the scale when the TARE key is pressed. The JAGXTREME terminal displays the net weight when a sample is placed in the container.

Keyboard Tare—If keyboard tare (preset tare) is enabled, you can enter the known tare weight of a filled container, then press the ENTER key to subtract the container tare weight from the gross weight and display the net weight of the sample.

Auto Tare—If auto tare is enabled the terminal automatically tares the scale when the load on the platform exceeds a predetermined threshold value.

You can also configure:

Auto Clear Tare—If auto clear tare is enabled tare is automatically cleared and the indicator returns to gross mode when the weight goes above, then drops below a predetermined threshold value. You can also specify that tare be automatically cleared after a print operation.

Tare Interlock—If tare interlock is enabled limits are placed on how tare values can be cleared and entered in legal-for-trade applications.

Net Sign Correction—If you enable the Net Sign Correction feature, A Truck In/Out facility can handle two situations:

Weighing a full truck first and, after emptying the truck, taking the tare weight of the empty truck to find the net weight of its contents.

Taking the tare weight of an empty truck and, after loading the truck, taking the full weight of the truck to find the net weight of its contents.

Net Sign Correction delays the decision of which weighment is the gross weight and which weighment is the tare weight until the operator prints the ticket. At that time, the JAGXTREME terminal compares the two weighments and takes the lower weight value as the tare weight. The net weight is always a positive value.

To configure the Tare Operation sub-block:

1. Press ENTER at the [**Tare Operations**] prompt to open the sub-block.
2. At the [**Enable Tare?**] prompt, select [**Y(es)**] or [**N(o)**] to enable or disable tare. If you select [**N(o)**], the terminal proceeds to the Zero Operation sub-block. Access to other tare features is not possible if tare is disabled.
3. At the [**Tare Interlock?**] prompt, select [**Y(es)**] or [**N(o)**] to enable or disable tare interlock.
4. At the [**Enabl PB Tare?**] prompt, select [**Y(es)**] or [**N(o)**] to enable or disable pushbutton tare.
5. At the [**Enabl KB Tare?**] prompt, select [**Y(es)**] or [**N(o)**] to enable or disable keyboard tare.
6. At the [**Enab Auto Tare?**] prompt, select [**Y(es)**] or [**N(o)**] to enable or disable auto tare.

**Applies only to IDNET bases.

If Auto Tare Is Enabled

1. Press ENTER at the [**Tare Threshold**] prompt; at the [**Wgt?**] prompt, enter the desired threshold value. The threshold value is a unit value such as 1.5 pounds. When weight on the platform exceeds the threshold value, then settles to no-motion, the terminal automatically tares.
2. Press ENTER at the [**Reset Threshold**] prompt. At the [**Wgt?**] prompt, enter the desired reset threshold value. This is a unit value and must be less than the tare threshold. When weight on the platform falls below the reset threshold value, as when the load has been removed, the terminal automatically rearms the auto tare trigger.
3. At the [**Check Motion?**] prompt, select [**Y(es)**] or [**N(o)**] to enable or disable the motion check. If enabled, the terminal checks for stability of the load on the platform before resetting the auto tare trigger.
4. At the [**Auto Clr Tare**] prompt, select [**Y(es)**] or [**N(o)**] to enable or disable auto clear tare. Auto clear tare depends on the tare interlock condition.

Note: Printing and tare operations will wait until a stable condition exists before proceeding with the action. See Stability Detect sub-block in this chapter for more information on setting the sensitivity.

Tare will clear only at gross zero if tare interlock and auto clear tare are both enabled.

If Tare Interlock and Auto Clear Tare Are Enabled

The terminal proceeds to the [**Display Tare**] prompt. Continue to step 8.

If Tare Interlock Is Disabled, and Auto Clear Tare Is Enabled

At the [**After Print?**] prompt, select [**Y(es)**] to clear tare after a print command is issued, or select [**N(o)**] to clear tare at a predetermined threshold value.

Note: If auto clear tare is enabled, the terminal does not display the **Clear Threshold** prompt.

Tare will not be displayed if an auxiliary unit is selected. Otherwise, tare is displayed in the lower display area.

If Auto Clear Tare After Print Is Disabled

1. Press ENTER at the [**Clear Threshold**] prompt; at the [**Wgt?**] prompt enter a unit value. When the gross scale weight exceeds then falls below the threshold value, the terminal automatically clears tare and returns to gross mode.
2. At the [**Check Motion?**] prompt, select [**Y(es)**] or [**N(o)**] to enable or disable the motion check. If enabled, the terminal checks for stability of the load on the platform before proceeding with auto clear tare.
3. At the [**Display Tare?**] prompt, select [**Y(es)**] or [**N(o)**] to enable or disable the tare display. If enabled, the terminal displays the current tare value on the lower display, provided the display is not showing other operator messages.
4. At the [**Net Sign Corr?**] prompt, select [**Y(es)**] or [**N(o)**] to enable or disable the net sign correction feature.
5. At the [**JagIDNET Tare?**] prompt, select [**Y(es)**] or [**N(o)**] to enable or disable this feature. NOTE: This prompt only occurs when you have an IDNET base. If you enable this feature, Tare is done in the terminal. If you disable this feature, Tare is done in the IDNET base.
 - When Tare is done in the terminal, the command is executed immediately. Tare is not successful when there is motion on the scale or if there is zero or negative weight on the scale. The DataOK bit is never turned off during this operation.
 - When Tare is done in the IDNET base, the terminal sends the Tare command to the IDNET base. If the scale is in motion, the IDNET base holds the tare command and suspends communications with the terminal. If communication is suspended for more than four seconds, the terminal turns off the DataOK bit and blanks the display. When motion stops, the IDNET base completes the tare operation and resumes communications with the JAGXTREME terminal. The terminal then turns on the DataOK bit.
6. Press ENTER to continue to the next sub-block or ESC to exit setup.

9a. Zero Operation Sub-block

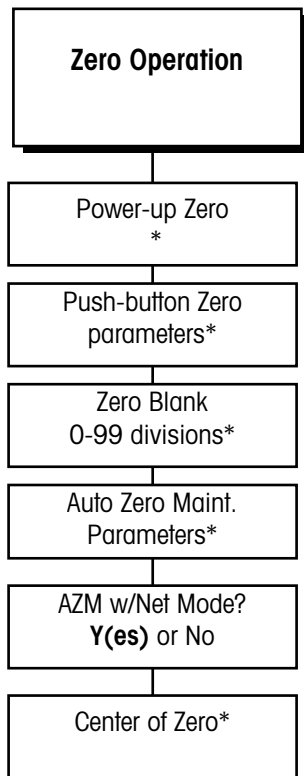

*These menu selections are replaced by "Restart? Y/N" when Scale Type is IDNET.

Note: A pre-determined number of consecutive readings from the scale must fall within the range specified before the scale compensates for changes in the zero reference.

Power-up zero should be disabled by setting the positive and negative ranges to 0% for scales such as tanks and hoppers which may lose power in the middle of a control process.

Pushbutton zero values are stored in the JAGXTREME terminal's memory. In case of power loss, the terminal will display an accurate weight when power is restored.

The Zero Operation sub-block lets you set the zero reference parameters. For terminals connected to an IDNET base, only the Auto Zero Maintenance portion of the sub-block is accessed. For all other scale base types, you can configure any or all of these options:

Power-up Zero—automatically zeros the terminal at power-up if weight on the scale is within a given range. If the weight on the scale is beyond the designated range, the display will not read zero until weight falls within the range.

Pushbutton Zero—manually compensates for material build-up on the scale and recaptures zero.

Zero Blank—determines when the display will go blank if weight falls below zero.

Auto Zero Maintenance (AZM)—automatically compensates for small changes in zero resulting from material build-up on the scale or temperature fluctuations.

AZM w/Net Mode—automatically corrects zero close to net zero and gross zero.

Center of Zero—determines if the center-of-zero annunciator lights at gross zero only or at gross and net zero.

Power-up zero capture and pushbutton zero ranges are based on the actual calibrated zero. If the positive and/or negative range value for power-up zero is greater than that for pushbutton zero, it is possible for the scale to automatically capture more weight on power-up than can be compensated for manually.

To configure the sub-block:

1. Press ENTER at the [**Zero Operation**] prompt to open the sub-block, then press ENTER at the [**Power Up Zero**] prompt to configure the power up zero option.
2. At the [**Positive Rng?**] prompt, enter a numeric value for the positive range of zero capture. This value is a percent of scale capacity.
3. At the [**Negative Rng?**] prompt, enter a numeric value for the negative range of zero capture. This value is also a percent of scale capacity.
4. Press ENTER at the [**Pushbutton Zero?**] prompt to access these parameters.
5. At the [**Positive Rng?**] prompt, enter a numeric value for the positive capture range. This value is a percent of scale capacity.
6. At the [**Negative Rng?**] prompt, enter a numeric value for the negative capture range. This value is also a percent of scale capacity.
7. At the [**Zero Blank?**] prompt, enter 0-98 to specify the display divisions behind zero before display blanking. The default is 5. A setting of 99 programs the terminal to display up to 50% of the calibrated capacity under gross zero.
8. Press ENTER at the [**Auto Zero Maint?**] prompt to enable the option.
9. At the [**Range?**] prompt, enter a range (in divisions) within which the JAGXTREME terminal adjusts for small changes in zero. Enter divisions +/- 0.1 - 10. Adjustments are made at a rate of 0.03 increments per second.
10. At the [**AZM w/Net Mode?**] prompt, select [**Y(es)**] to automatically correct zero close to net zero and gross zero. Select [**N(o)**] for AZM to function only near gross zero.
11. At the [**COZ?**] prompt, select if the center-of-zero annunciator should illuminate at Gross Only or at Gross and Net zero.
12. Press ENTER to continue to the next sub-block or ESC to exit setup.

9b. Zero Operation Sub-block for IDNET Bases

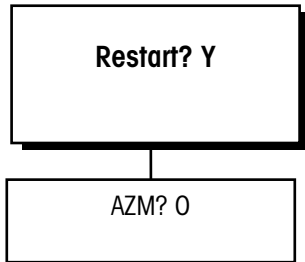

Scale zeroing is done within the IDNET base. The terminal sends the Zero command to the base. If the scale is in motion, the base holds the zero command and suspends communication with the terminal. If communication is suspended for more than four seconds, the terminal turns off the DataOK bit and blanks the display. When motion stops, the base completes the zero operation, resuming communications with the terminal. The terminal then turns on the DataOK bit and the display.

To configure the sub-block:

1. At the [**Restart? Y**] prompt press ENTER to accept or SELECT, followed by ENTER to change the response to [**N(o)**] and to accept that selection. When the restart feature is enabled, the current zero setting is saved and restored after a power loss. When the restart feature is NOT selected, the IDNET base "re-zeroes" at power up.
2. Press ENTER at the [**AZM? 0**] prompt to turn autozero maintenance OFF. To turn it ON, press SELECT until the prompt displays a [**1**]. Press ENTER.

10a. Stability Detect Sub-block

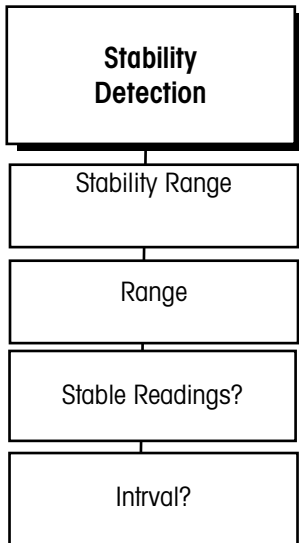

The stability detection feature determines when a no-motion condition exists on the scale. The sensitivity level determines what is considered stable. Printing and tare operations will wait for scale stability before carrying out a command.

Stability detection occurs over a predefined period of time and allows a predetermined "acceptable" amount of motion in scale divisions. The acceptable amount of motion is considered the range and the period of time is called the interval. When the JAGXTREME terminal is used with an IDNET base, there are four settings of stability filtering available.

To configure the sub-block:

1. Press ENTER at the [**Stability Detect**] prompt and again at the [**Stability Range?**] prompt.
2. At the [**Range?**] prompt, enter the acceptable motion range (+/- 0.1 to 9.9 divisions).
3. Press ENTER at the [**Stable Readings?**] prompt to configure the stability parameters.
4. At the [**Intrval?**] prompt, enter the number of seconds (0 to 9.9) that the weight must remain within the range values for a no-motion condition.
5. Continue to the next sub-block or exit the setup mode.

10b. Stability Detect Sub-block for IDNET Bases

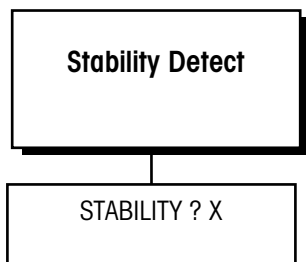

Stability Detection of an MMR (IDNET) base is determined by the base electronics. The stability detection feature determines when a no-motion condition exists on the weighing platform. The sensitivity level determines what is considered stable. Printing and tare operations will wait for scale stability before carrying out the command.

The only prompt that will appear will be [**STABILITY ? X**]. Use the SELECT key to change the value of the stability filter from 0 (no stability detection) or 1 (fast indication of weight) through 4 (slow indication of weight).

11. Beeper Operation Sub-block

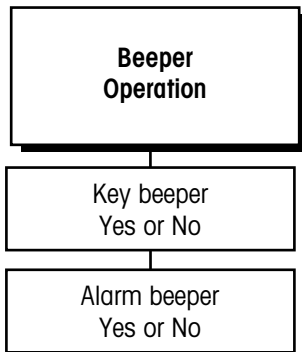

The JAGXTREME terminal is capable of making an audible beep each time a key is pressed and an error alarm when an inappropriate key is pressed. This sub-block lets you enable or disable the keyboard sound.

To configure the sub-block:

1. Press ENTER at the [**Beeper Operation**] prompt to open the sub-block.
2. At the [**Key Beeper?**] prompt, select [**Y(es)**] or [**N(o)**] to enable or disable sound when a key is pressed, as well as the double beep acknowledgment message.
3. At the [**Alarm Beeper**] prompt, select [**Y(es)**] or [**N(o)**] to enable or disable an alarm that sounds when an error occurs or an inappropriate button is pressed.
4. Continue to the next sub-block or exit the setup mode.

12. Inhibit Memory Sub-Block

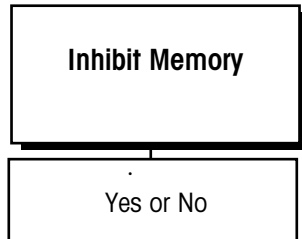

The Inhibit Memory sub-block is used to disable the MEMORY key on the JAGXTREME terminal keypad. If [**Y(es)**] is selected, the MEMORY key will be disabled. If [**N(o)**] is selected, the key will function as normal.

13. Application Type Sub-block

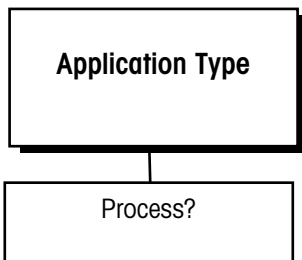

The Application Type sub-block indicates whether or not the scale is used for a process application. This sub-block affects the A/D rate and the ability to enable and/or disable the stability filter. To configure the sub-block:

At the [**Process?**] prompt,

1. Select [**Low**] – The stability filter can be enabled or disabled. The A/D rate is 10 updates per second. The continuous output is at 5 Hz.
2. Select [**Mid**]. The stability filter can be enabled or disabled. For analog load cells, the A/D and setpoint comparison rates are 20 Hz, and the standard continuous output updates the weight 10 times per second for all scale types. If the A/D update rate is less than 10, the continuous output will be at the A/D update rate. For Ultra-Res, DigiTOL, IDNET, or POWERCELL load cells, the A/D rate is the rate of which the load cell is capable, and the standard continuous output update rate is the same as the A/D rate.
3. Select [**High**]. The stability filter cannot be enabled. For analog load cells, the A/D rate is 17 Hz and the setpoint comparison rate is 50 Hz, and the standard continuous output updates the weight 17 times per second.

14. Vibration Rejection Sub-block

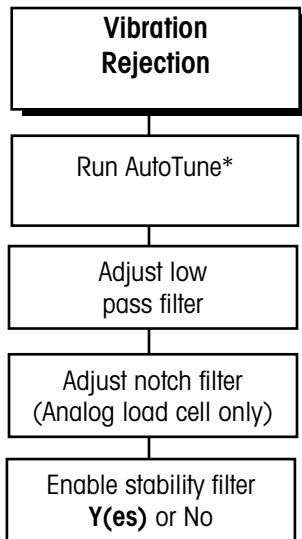

*Only appears if using an analog scale.

Note: Autotune is available only with analog load cell scale I/P PCBs of the revisions (or higher) listed below:

- A15290700A Dual Analog Load Cell
- B15345400A Single Analog Load Cell
- B15360100A Reduced Excitation Dual Analog Load Cell
- B15360200A Reduced Excitation Single Analog Load Cell

Note: The Adjust Notch parameter appears only if you are configuring an analog load cell. If configuring a DigiTOL or other scale, JAGXTREME proceeds to step 6.

The JAGXTREME terminal has several filters to compensate for environmental disturbances such as vibration or noise. This sub-block lets you configure the TraxDSP filters for optimum vibration/disturbance rejection.

The Vibration Rejection sub-block allows programming of values including:

- **Low Pass Filter Frequency**—Low Pass Frequency is the frequency above which all disturbances are filtered out. The lower the frequency, the better the disturbance rejection, but the longer the settling time required for the scale.
- **Poles**—The number of poles determines the slope of the filtering cutoff. For most applications, a slope value of 8 is acceptable; however, decreasing this number will improve settling time slightly. Do not enter a value lower than 4 for this parameter.
- **Notch Filter Frequency**—The Notch Filter allows selection of one specific frequency below the lowpass filter value that can also be filtered out. This enables setting the lowpass filter higher to filter out all but one frequency (that the notch filter will handle) and obtain a faster settling time.
- **Stability Filter**—The Stability Filter eliminates weight changes within a given range around a stable weight reading. This filter eliminates fluctuations in the weight display created by movement. You cannot enable the stability filter if the Process Application Type parameter is configured High for dynamic weighing such as batching or filling applications. The stability filter uses very stiff filtering as long as there is no motion on the scale so that the weight display changes slowly. There is minimal jitter on the weight display. Once the terminal detects a "motion" condition, it switches the stability filter to the standard lowpass filter. As a result, the weight quickly moves to its final value.

TraxDSP™ filtering is not available with IDNET bases. These bases allow you to select between three types of process applications and three filter settings.

To configure the sub-block:

1. Press ENTER at the [**Vibration Reject**] prompt to open the sub-block.
2. At the [**Run Autotune?**] prompt, select [**N(o)**] to bypass the auto tune process or select [**Y(es)**] to automatically tune the low pass and notch filters for analog scales only.
 - If [**Y(es)**] is selected, the display reads [**Adjust 1**] and the cursor moves across the display while the terminal measures the vibration under current conditions. The terminal automatically displays [**Measure 1**] and the cursor moves across the display while the terminal adjusts the vibration filter accordingly.
 - The terminal can repeat the measure and adjust process up to six times, depending on the amount and regularity of the vibration. When the vibration adjustment is made, the terminal indicates either [**Success**] or [**Auto Tune Failed**] then continues to the next prompt.
3. Press ENTER at the [**Adjust Lowpass?**] prompt to configure the parameters governing the low pass filter. Disturbances falling below these parameters pass through the filter; disturbances above the parameters are filtered out.
4. At the [**Frequency?**] prompt, enter the frequency above which disturbances are filtered out.
5. At the [**Poles?**] prompt, enter the number of poles.
6. At the [**Adjust Notch?**] prompt, press ENTER to configure the parameters governing selective filtering.
7. At the [**Frequency?**] prompt, enter the frequency at which any disturbance is filtered out.
8. You cannot enable the stability filter if the [**Process Application**] parameter is configured [**Y(es)**] for dynamic weighing such as batching or filling applications.

- At the **[Stable Filter?]** prompt, select **[Y(es)]** or **[N(o)]** to enable or disable the stability filter. Use this for static weighing applications only.

The default values for vibration rejection that are programmed in the factory are good for most applications; however, if you find that the weight display is still unstable, the following steps may help:

- Set the Low Pass filter to 9.9, poles to 8, and the Notch Filter to 0.0.
- Lower the frequency setting of the Low Pass Filter by increments of 1.0 and observe the amount of variation at each setting. When you see a noticeable improvement in display stability, vary the Low Pass Filter setting slightly below the frequency setting in increments of 0.1 for minimum fluctuation.
- Record the frequency and approximate number of increments variation for the settings that show noticeable reduction in display fluctuation. This is the lowest frequency of vibration causing the display to fluctuate.
- Set the Low Pass Filter back to 9.9.
- Set the Notch Filter to the frequency that caused the largest reduction in increments change (recorded in step c.).
- If the display is still fluctuating too much, repeat step b. observing the display fluctuation. Reduce the Low Pass Filter setting until the display is acceptable.
- Always check the weight display update time after each filter adjustment to be sure that the update rate is fast enough for the application.

14a. Vibration Rejection Sub-block for IDNET

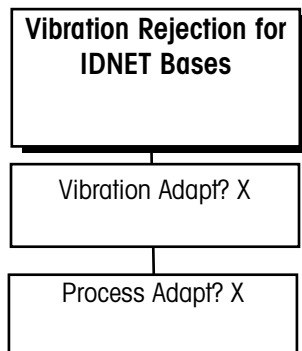

When the JAGXTREME terminal is used with an IDNET base, the following prompts and selections are possible:

- Press ENTER at the **[VIBRATION ADAPT? X]** prompt to select the type of vibration filtering:
 - Use the SELECT key to display the appropriate filter level, then press ENTER. Options include:
 - 1 (low), use for virtually disturbance free, stable surroundings. The indicator responds quicker to changes in weight, and is more sensitive to external conditions.
 - 2 (med), use for normal ambient conditions. This is the factory default setting.
 - 3 (high), use for unstable surroundings. The scale is less responsive than the factory default setting, and is less sensitive to external influences.
- Press ENTER at the **[PROCESS ADAPT? X]** prompt, then select the desired option:
 - 1—use for the dispensing of liquids or powders.
 - 2—use for all types of normal weighing applications. This is the factory default setting.
 - 3—use for checkweighing types of applications.

Serial Interface Program Block

The Serial Interface program block lets you set parameters to control data flow across the JAGXTREME terminal's serial communication (COM) ports. This includes assigning port parameters and adding or and deleting a connection.

The input and output COM ports are used to communicate data on demand or continuously. COM ports may also be used for information exchange between a PC and the terminal.

JAGXTREME terminals have two serial I/O ports (COM1 and COM2). While one port might be used to support a DigiTOL type scale, another may be used for data output as needed. If an optional Multifunction PCB is connected, two additional serial I/O ports are available (COM3 and COM4).

A DigiTOL scale can be connected to COM2 or COM4 and is configured through the Scale Interface block. The port to which the DigiTOL scale is connected is not available for any other application. When DigiTOL or DJ-Box is selected in the Scale Type sub-block (Scale Interface program block), the serial port (COM2 or COM4) is automatically set for communications to a DigiTOL base.

The following diagram describes the Serial Interface program block:

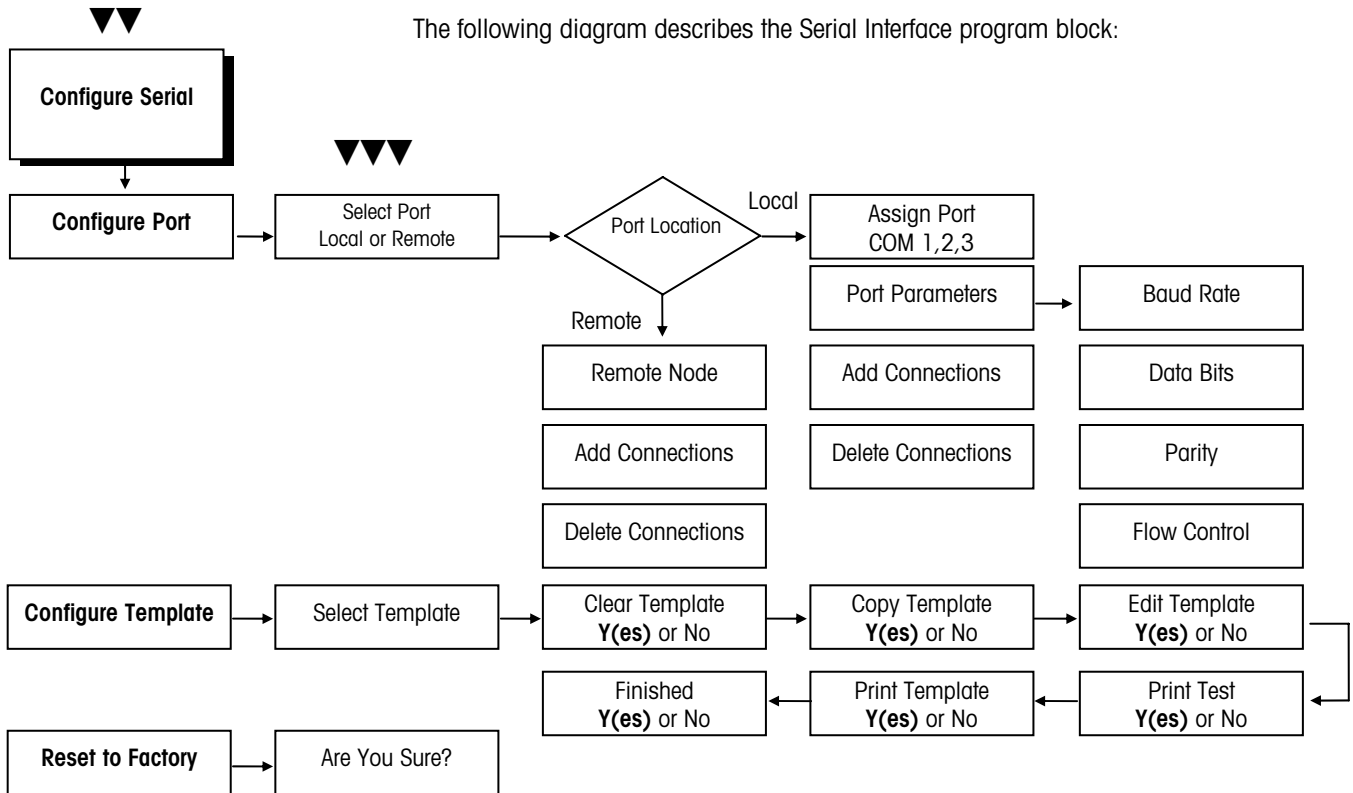

1. Configure Port Sub-block

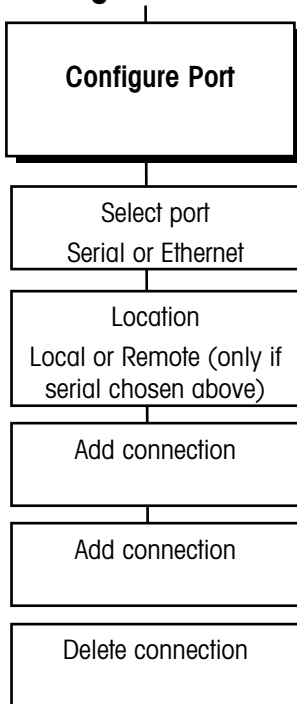

This sub-block lets you configure the serial ports on your local terminal for data exchange. You can configure only those ports that are physically available. For example, on a standard JAGXTREME terminal with a single analog scale, you may have a remote display connected to COM 1 and a printer connected to COM 2. To configure the program block:

1. Press ENTER at the [**Configure Serial**] prompt to open the program block. Press ENTER at the [**Configure Port**] prompt. Press ENTER at the [**Select Port**] prompt.
2. At the [**Location?**] prompt, select [**Local**] or [**Remote**]. Local refers to COM ports on the JAGXTREME terminal you are working with at the time. Remote refers to COM ports on other terminals connected in an Ethernet cluster.
3. Add the connection you just configured. It may be necessary to delete an existing connection that conflicts with the new one. For example, to connect a printer you must configure a COM port and add that port before the terminal can communicate with the printer.

If You Select Local

Configuring a local COM port involves defining the parameters that govern how data is transmitted through the port. You can configure communication parameters only for your local terminal. Communication parameters for remote terminals must be configured at the remote locations.

1. At the [**Assign Prt?**] prompt, select the local COM port to be configured (COM1 or COM2). COM3 and COM4 are available if an optional Multifunction PCB is installed.
2. Press ENTER at the [**Port Parameters?**] prompt. Configure these parameters:
 - Interface Type (COM2 only)
 - Baud Rate
 - Data Bits
 - Parity

Interface Type

If COM2 is being configured, you must identify the interface type. The interface type prompt does not appear if you are configuring COM1.

1. At the [**I/F Type?**] prompt, select the desired interface type. Choices include:
 - RS-232
 - RS-422
 - RS-485

Baud Rate

The baud rate is the rate of information transfer in bits-per-second.

1. At the [**Baud Rate?**] prompt, select the desired rate for the selected port:
 - 300
 - 600
 - 1200
 - 2400
 - 4800
 - 9600
 - 19.2k
 - 38.4k
 - 57.6k
 - 76.8k
 - 115.2k

Data Bits

Data bits refers to the number of bits that make up an ASCII character that is transferred between units. Most METTLER TOLEDO equipment communicates using 7 data bits.

1. At the [**Data Bits?**] prompt, select 7 or 8 data bits.

Note: COM1 and COM2 always have 1 stop bit.

XON/XOFF requires character input. It will only work if the serial port has no other input connections. For example, you cannot configure CTPZSU In.

The remote terminal's communication parameters, such as baud rate, are configured in the remote terminal. You cannot configure remote communication parameters through this program block.

If you see the CONFLICT EXISTS error, you must first delete the existing connection before adding a new connection.

Note: You must include a summing scale when using Multi Cont 1 or 2. If Multi Cont 1 or 2 is used, no other port connection can be made to continuous or Multi Cont 1 or 2.

Parity

Parity is an error checking mechanism for each byte.

- At the **[Parity?]** prompt, select the desired option. Parity options include:
 - **Even**—the terminal sends an even number of logic 1 data bits. If the sum is odd, an eighth logic 1 bit is added for an even total. If the sum is even, a 0 bit is included to leave it unchanged.
 - **Odd**—the terminal sends an odd number of logic 1 data bits. If the sum is even, a logic 1 bit is added for an odd total. If the sum is odd, a 0 bit is included to leave it unchanged.
 - **None**—for use with eight data bits.

Flow

The flow parameter lets you control data flow from the selected port to a peripheral device that supports XON/XOFF data flow. If enabled, the JAGXTREME terminal monitors the XON/XOFF characters and controls data flow to help eliminate buffer overflow problems that can cause printing errors.

- At the **[Flow?]** prompt, select the desired data flow option:
 - **None**—The JAGXTREME terminal does not respond to XON/XOFF.
 - **XON/XOFF**—The JAGXTREME terminal stops transmission on receipt of the XOFF character (13h) and resumes on receipt of the XON character (11h).

If You Select Remote

The following steps will identify and list remote JAGXTREME terminals with which your terminal can communicate through its serial ports.

- At the **[Node?]** prompt, select the remote terminal with which you will communicate. Five are available; the terminal you are configuring is excluded. Terminal numbers are configured in the "Cluster IP" sub-block.
- At the **[Assign Prt?]** prompt, select the COM port through which communication will take place. COM1, 2, 3 and 4 are available.

Add a Connection

The JAGXTREME terminal is programmed at the factory for COM1 to output scale 1 data on demand. COM2 is not configured at the factory. Before adding connections, METTLER TOLEDO recommends deleting the existing COM1 connection.

- Press ENTER at the **[Add Connection?]** prompt.
- At the **[Type?]** prompt, select the type of serial connection for the scale:
 - Serial Out
 - Cust Print from template (1-5)
 - Multi Cont 1
 - Multi Cont 2
 - BasTerminal*
 - CTPZSU In*
 - Bar Code In*
 - Keyboard In*
 - TDC3000*

*Do not use these selections if using the JagMAX software.

Note: To print data for both scales in a two-scale system regardless of the scale displayed, you must make a connection for scale A and an identical connection for B. Scale E is used for the summing scale connections.

Templates determine the data to be sent for demand printing and are discussed in the Configure Template sub-block.

The minimum print and print interlock features are related to the scale, not the connection. Programming these features applies to any demand connection for that scale.

To change any of these parameters, you must delete the entire connection then recreate the connection. It is not possible to reenter setup and change a parameter.

Refer to the appendix for complete status byte information.

If you assign Scale A and Scale B to the same continuous output port, the currently selected scale data is output to the continuous port.

Control characters affect the selected scale unless preceded by a specific scale designation character (A or B).

Refer to the appendix for more details on CTPZSU and remote ASCII control character input.

If Serial Out is Selected

1. At the **[Enter Scale#?]** prompt, select the internal scale (A, B, or E).
2. Press ENTER. The scale selected must be displayed on the terminal in order to use the PRINT key to complete the operation.
3. At the **[Mode?]** prompt, select **[Demand]** (information that is sent upon request) or **Continuous** (a constant stream of information that is sent from the remote terminal).

Serial Out — Demand Mode

1. Press ENTER at the **[Flexible Print?]** prompt. Select **[Y(es)]** or **[N(o)]** at each of the prompts **[Template 1-5?]** indicating which template(s) you will print.
2. At the **[Minimum Print?]** prompt, select **[Y(es)]** or **[N(o)]** to enable or disable minimum print. If you select **[Y(es)]**, at the **[Wgt?]** prompt, enter a weight value below which printing cannot be initiated.
3. At the **[Print Interlock?]** prompt, select **[Y(es)]** or **[N(o)]** to enable or disable feature.

If Y(es), Print interlock allows only one print operation if scale weight is above a threshold value. To print again, the weight must fall below the reset threshold value then settle above the threshold value. Print interlock must be enabled to access the Auto Print feature.

4. Configure the following parameters if print interlock is enabled:
 - **Print Threshold**—Press ENTER at the **[Print Threshold?]** prompt. At the **[Wgt?]** prompt, enter the weight value that must be reached before printing can begin.
 - **Reset Threshold**—Press ENTER at the **[Reset Threshold?]** prompt. At the **[Wgt?]** prompt, enter the weight value below which the weight on the scale must fall before enabling the next print operation.
 - **Check Motion**—Select **[Y(es)]** or **[N(o)]** to enable or disable this parameter. If enabled, check motion prohibits the next print operation until weight on the scale stabilizes (no-motion) below the reset threshold.
 - **Auto-Print**—Select **[Y(es)]** or **[N(o)]** to enable or disable automatic printing. If enabled, printing will begin when a no-motion condition exists and scale weight is above the print threshold. Auto-print requires the weight to drop below the reset threshold before another auto print operation can take place. If N(o), Continue to the next sub-block or exit setup.

Serial Out — Continuous Mode

1. At the **[Status?]** prompt, select the mode for the status bits in continuous mode:
 - **Standard**—for continuous mode to operate normally.
 - **Setpnt**—to include the status of setpoints 1 through 4 in the continuous output format. If enabled, the first setpoint assigned to a scale becomes the first setpoint in the continuous output.
 - **Template**—to use one of the five print templates for continuous output. Select the desired template (1 through 5).
2. At the **[Checksum?]** prompt, select **[Y(es)]** or **[N(o)]** to enable or disable checksum. Checksum is a method of checking each line of data transmitted by encoding a check digit character at the end of the string. The receiving device must be able to calculate and compare this character to verify the data is correct. Checksum is the 2s complement of the 7 low-order bits of the binary sum of all characters preceding the checksum, including control characters. Bit 8 is the parity bit (if enabled) of the 7 low-order bits of the checksum character.

If CTPZSU In is Selected

No further parameters need to be configured. CTPZSU In is a serial connection enabling the terminal to perform several basic functions when specific ASCII control characters are received through the serial port.

Control characters affect the selected scale unless preceded by a specific scale designation character (A, B, or E). E indicates the summing scale.

C —clears the scale to gross	S —selects the scale
T —tares the scale	U1 —selects primary units
P —initiates a print command	U2 —selects secondary units
Z —zeros the scale	

A Keyboard Tare can be entered by preceding the "T" with a numeric value. For example, 10.5T enters a Tare value of 10.5. If there is no preceding numeric value, "T" causes a Pushbutton Tare.

If Bar Code In is Selected

This connection type is used for input of serial data (requested from a prompt list step) The prompt list response source, configured in the Memory program block, must be Serial or Both. Refer to Appendix 1 for more information. No additional parameters need to be configured.

If Keyboard In is Selected

This connection is used to receive serial characters emulating keyboard input. Refer to the appendix. No additional parameters need to be configured.

If Custom Print from Template is Selected

This connection directs the serial port to output the selected characters and information from the corresponding template (Templates 1 through 5). This selection differs from the demand custom template print. The demand custom template print will cause the template to be sent serially when:

- The print button is pressed.
- An ASCII "P" command is sent to a COM port configured for "CTPZSU" input.
- A discrete input command to print is given.
- A print command is sent via a PLC interface.
- A demand print is triggered through JagBASIC.
- A Custom Print from Template will only cause the template to be sent serially when a cust_prt discrete input for that template is used, or a JagBASIC program triggers the custom template print.

1. At the [**Template 1?**] prompt, select [**Y(es)**] or [**N(o)**] to include the template in the output. You must select Y(es) or N(o) for each template 1 through 5.

If TDC3000 is Selected

The serial port is assigned to a special Honeywell protocol. Refer to the appendix.

If BasTerminal is Selected

JagBASIC supports a serial terminal, such as a dumb terminal or a PC running a terminal emulator, as a console for JagBASIC program development and debugging. You can type commands at the serial terminal keyboard then view them on the serial terminal display. You must attach the serial terminal to a serial port on the local JAGXTREME terminal. See the appendix for more information.

Configuring BasTerminal

The Configure Serial menu allows you to set up the JagBASIC keyboard input from a serial port. You select the appropriate COM port and assign the BasTerminal connection to it. When you assign the BasTerminal connection port, the input characters from the serial port are routed to JagBASIC. This connection is for keyboard input to the JagBASIC interpreter. The Interpreter displays the "BASIC:" prompt and input keystrokes to the BasTerminal. You must assign the keyboard to JagBASIC in the JagBASIC setup menus.

If Multi Cont (1 or 2) is Selected

Multiplexed Continuous Outputs in two formats to interface with scoreboards and other devices. The continuous output message contains weight data for all local scales. Select the connection you wish to delete through the Select Port, Location, and Assign Port steps.

1. Press SELECT until the **[Delete Connect?]** prompt is displayed, then press ENTER. The terminal displays the name of the port you have chosen. If the connection you want to delete is not displayed, press SELECT to display the desired connection.
2. Press ENTER to delete the connection.
3. Press ENTER to continue to the next sub-block or press ESC to setup.

Note: Refer to the appendix for information on output format.

2. Configure Template Sub-Block

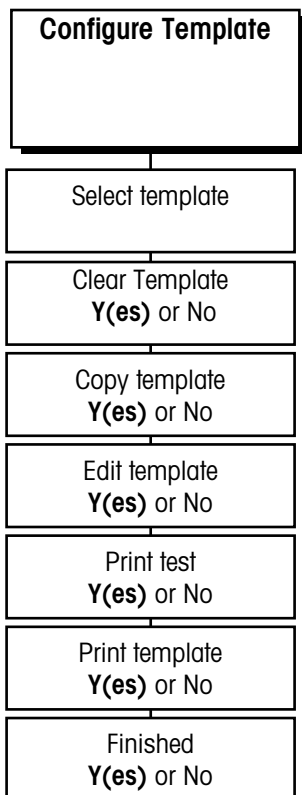

This sub-block lets you define up to five flexible templates. Templates are preconfigured output strings that are transmitted when a print operation is requested. Appendix 1 lists the default templates. You can use the five stored default templates as given, edit them, or clear them and create custom templates.

Templates are composed of any printed character, special character, or field. Each template can store up to 400 format characters. When configuring a template, you should occasionally test print since the terminal cannot determine if it has run out of space until it "compiles" all the data in the template and tries to print it. If you do overfill the allocated space, a **[TEMPLATE OVERFLOW]** error will be displayed. Any data exceeding the 400-character limit will be lost.

The elements are recorded then sent sequentially when the template is used when a demand print request is received.

The configuration steps that follow pertain to the currently selected scale.

1. Press ENTER at the **[Config Template?]** prompt to open the sub-block.
2. At the **[Temp?]** prompt, press SELECT to choose the number and name of the template you wish to edit or create. If an existing template has a customized name assigned to it, the name appears to the right of the prompt: **[Temp? 1 Mettler]**.
3. Select the action you want to take with the selected template. Actions include:
 - Clear Template
 - Copy Template
 - Edit/Create Template
4. You must respond Y(es) or N(o) to each prompt.

Clear Template

1. Select **[Y(es)]** or **[N(o)]** at the **[Clear Template?]** prompt.
2. If Y(es), you must confirm your decision at the **[Are You Sure?]** prompt.

Copy Template

1. Select Y(es) or N(o) to copy another template into the current template.
2. If Y(es), select the new template ID number. Confirm your decision at the **[Are You Sure?]** prompt. The current template will be cleared before the new one is copied.

Edit/Create Template

1. Select Y(es) or N(o) if you wish to edit the current template.
2. If Y(es), you can edit the template name and/or edit, insert, or delete template components. The display reads **[Name?]** with the current name of the template given to the right of the prompt.
3. Change the template name by entering a new name (maximum 8 characters), or keep the current name by pressing ENTER.
4. The JAGXTREME terminal displays **[E001]** in the top display indicating that the first element of the template is displayed in the lower display area. If **[End of Template]** appears on the lower display, the template is empty.
5. Press SELECT to display the next element in the template. Press ZERO to display the previous element in the template. You can access any element in the template using the SELECT and ZERO keys.
6. You can also access specific elements by entering the number of the desired element. After entering the first digit of a new element, the lower display reads **[Element? X]**. X is the digit just entered. When the complete element number has been entered, press ENTER to access it.
7. Press ENTER to begin editing the displayed element. You can also begin editing at the End of Template position.
8. At the **[Action?]** prompt, select an editing option.
 - **EDIT** allows you to "replace" the current element with new data. The current element is automatically deleted.
 - **INSERT** allows you to insert a new field or character before the currently displayed element. The elements that follow are moved back one element number.
 - **DELETE** deletes the current element and moves each remaining element up one element number.
 - **DEL END** deletes all remaining elements from the displayed position to the end of the template.
9. If you are editing or inserting, at the **[What?]** prompt, select a data type. Data can be field information, printable ASCII characters, or special characters.
10. **FIELD** refers to actual data fields available through the terminal such as time, date, prompts, literals and weight data. Enter a field code from the table on the next page. NOTE: Although the table shows codes in lower case, the JAGXTREME terminal accepts field codes entered in upper or lower case.

If you are creating multiple templates that are similar to each other, use the copy and edit template features to save time.

If the element number you enter is greater than the last element number in the template, the JAGXTREME automatically displays the last element in the template.

Note: The lengths shown in the table reflect the length of the field when matching the template to the desired result. When calculating the number of elements in the template, JAGXTREME data fields only take up seven characters.

JAGXTREME Data Field	Field Code*	Length
Tare Source	wsx07	1 N (0=none, 1=pb, 2=kb, 3=auto)**
Scale ID	csx18	8 A/N
Setpoint Value x = setpoint 1-8	spx05	10 A/N
Current Time ¹	jag20	11 A/N
Current Date ¹	jag19	11 A/N
Day of Week ¹	jag21	10 A/N
Julian Date ¹	jag07	5 A/N
Consecutive Number	jag09	8 N
Literal 01 [†]	lit01	40 A/N
Literal 02 [†] , etc	lit02, lit..	40 A/N
Prompt 01 [‡]	pmt01	16 A/N
Prompt 02 [‡] , etc	pmt02, pmt..	16 A/N
Prompt 01 Response	var01	As Programmed
Prompt 02 Response, etc	var02, var..	As Programmed
Template 1 ^{***}	ptp01	As Programmed
Template 2 ^{***} , etc	ptp02, ptp..	As Programmed

* The "x" character in a code represents the number of the internal scale from which data will come (unless otherwise noted). Number 1 represents internal Scale A, 2 represents internal Scale B, and 5 represents scale E, which is the summing scale. For example, to print the scale ID for scale A, the field code is "cs118."

** pb = pushbutton tare, kb = keyboard (preset) tare.

† Refer to the section entitled Configure Literals Sub-block in the Configure Memory program block later in this chapter for more information on entering literals.

‡ Refer to the section entitled Configure Prompts Sub-block in the Configure Memory Program Block later in this chapter for more information on entering prompts.

*** Using a template field code within a template will insert the entire template into the output.

¹ Updated only at "print" time.

Although the Weight Data field table shows codes in lower case, the JAGXTREME terminal accepts field codes entered in upper or lower case.

NOTE: For a complete list of field codes, refer to the JAGBASIC Programmer's Guide.

Weight Data Field	Field Code*	Length
Gross WT.	wtx01	12 A/N
Tare WT.	wsx02	12 A/N
Net WT.	wtx02	12 A/N
WT. Units	wtx03	2 A/N
Auxiliary Gross WT.	wtx04	12 A/N
Auxiliary Tare WT.	wsx03	12 A/N
Auxiliary NetWT.	wtx05	12 A/N
Auxiliary WT. Units	wtx06	6 A/N
Scale Mode (Gross/Net)	wsx01	1 A/N (G or N)
Custom Unit Conversion Factor	csx03	8 A/N
Custom Unit Name	csx02	6 A/N

The "x" character in each code represents the number of the internal scale from which data will come (unless otherwise noted). Number 1 represents internal Scale A, 2 represents internal Scale B, and 5 represents scale E, which is the summing scale. For example, to print the displayed gross weight for scale A, the field code is "wt101."

The lengths shown in the table reflect the length of the field when matching the template to the desired result.

When calculating the elements in the template, the JagMAX data fields only take up seven characters. The JagMAX accepts field codes entered in upper or lower case.

JagMAX	Field Code	Length
• Axle 1 weight	pmt01	6 A/N
Axle 2 weight	pmt02	6 A/N
Axle 3 weight	pmt03	6 A/N
Axle 4 weight	pmt04	6 A/N
Axle 5 weight	pmt05	6 A/N
Axle 6 weight	pmt06	6 A/N
Axle 7 weight	pmt07	6 A/N
Axle 8 weight	pmt08	6 A/N
Axle 9 weight	pmt09	6 A/N
Summed gross weight	var01	6 A/N
Summed tare weight	var02	6 A/N
Summed net weight	var03	6 A/N
Weight unit	var04	2 A/N
Ticket number	var05	6 A/N
ID ⁴	var06	8 A/N
Transaction Mode ¹	var07	10 A/N
Fee	var08	7 A/N
Date ⁵	var09	11 A/N
Time ⁵	var10	8 A/N
Site ID ²	var11	8 A/N
Text 1 ²	var12	45 A/N
Text 2 ²	var13	45 A/N
Text 3 ²	var14	45 A/N
Comment ³	var15	45 A/N
Literal 1	lit01	40 A/N
Literal 2 - 20	lit02 - lit20	40 A/N (each)

¹ The transaction mode will be a description of the type of transaction that has been completed. Depending on the mode selected, the data in this field could be: Weigh, Re-Weigh, Double, Triple, Dbl ReWgh, Trpl ReWgh, Moving Van, Inbound, Outbound.

² Site ID, Text 1, Text 2, and Text 3 will contain the data configured in the application setup for these items.

³ If the Comment field is enabled in the application setup, the data in this field will contain the information entered by the operator.

⁴ If the ID field is enabled in the application setup, the data in this field will contain the information entered by the operator.

⁵ The Date and Time fields will be formatted as configured in the Application Environment program block of System Setup.

At the **[Format?]** prompt, select the data position (justification) and field width. If field width is less than the code length default specified in the Field Code tables (above), characters will be stripped off automatically. Justification choices include:

- **DEFAULT** prints data as defined by Mettler-Toledo default.
- Format options Left, Center, and Right use more memory than Default. Each justification takes up six characters in the template.
- **LEFT** prints data left justified within the field width. At the **[Field Width?]** prompt, enter the number of characters to define the field width.
- **CENTER** prints data centered within the field. At the **[Field Width?]** prompt, enter the number of characters to define the field width.
- **RIGHT** prints data right justified within the field. At the **[Field Width?]** prompt, enter the number of characters to define the field width.

CHAR refers to normal printable ASCII characters and CR/LF (carriage return and line feed) characters. You can enter ASCII characters from the remote QWERTY keyboard or the JAGXTREME terminal keypad. CR/LF makes terminating a printed line faster than selecting each character individually. It also allows quick addition of multiple new lines to advance to the end of the page or to position a line on a page. To choose CR/LF as a character, press SELECT at the **[Character?]** prompt.

SPEC CHAR refers to "special" control characters that are not printable ASCII characters such as ASCII SO (shift out - OE hex) which may be used for printer control. Special characters include lower case letters and various punctuation not available on the standard JAGXTREME terminal keypad. Use the JAGXTREME terminal's SELECT and ZERO keys to scroll through the list of these characters and choose a character, or use the numeric keys to enter the decimal value of any special character between 0-255.

At the **[Format?]** prompt, select the data position (justification) and field width. If field width is less than the code length default specified in the Field Code tables (above), characters will be stripped off automatically. Justification choices include:

- **DEFAULT** prints data as defined by METTLER TOLEDO default.
- **LEFT** prints data left justified within the field width. At the **[Field Width?]** prompt, enter the number of characters to define the field width.
- **CENTER** prints data centered within the field. At the **[Field Width?]** prompt, enter the number of characters to define the field width.
- **RIGHT** prints data right justified within the field. At the **[Field Width?]** prompt, enter the number of characters to define the field width.

Note: When calculating the number of elements in the template, the individual ASCII characters and special ASCII characters take up one character each. CR/LF and repeat characters take up six characters each.

Refer to the appendix for a list of special characters and their decimal equivalents.

Formatting options allow you to customize the appearance of printed data and helps align data on the page. You can also limit the data field width which can help to eliminate unwanted characters.

Format options Left, Center, and Right use more memory than Default. Each justification takes up six characters in the template.

When the element is viewed on the lower display, the data is shortened to fit in the display area. The following examples illustrate the displayed data format.

Example 1: /wt101 L 15 where:

"/" indicates a JAGXTREME Data Field. The other possibility is "A" for ASCII character.

"wt101" is the gross weight field code for Scale A.

"L" indicates the field is left justified. "R" means right, "C" means center.

"15" is the specified field width.

Example 2: A 'G' 001 where:

"A" indicates an ASCII character. The other possibility is "/" for a JAGXTREME terminal Data Field.

"G" is the ASCII character selected.

"001" is the quantity of the "G" character to be transmitted. Printing multiple characters is a quick way to add spacing or create custom printouts. For example, multiple underscores (_) can create a signature line.

Note: Print test allows you to check your data output without exiting the template sub-block.

Print template gives a hard-copy record of the template configuration that can be useful for "debugging" a format as you configure the template.

The setpoints that are available correspond to the selected scale.

1. At the [Print Test?] prompt, select [Y(es)] or [N(o)] to initiate or skip a test print of the template. If Y(es), the data defined by the template will be output to the first COM port selected for Demand Mode.
2. At the [Print Temp?] prompt, select [Y(es)] or [N(o)] to print the template elements. If Y(es), template elements are output in the shortened format described above to the first COM port selected for Demand Mode.
3. At the [Finished?] prompt, select Y(es) if you are finished or N(o) to continue editing.
4. Continue to the Reset to Factory sub-block or exit setup mode.

Configure Discrete Program Block

The Configure Discrete program block lets you configure inputs and outputs for PAR 1 and PAR 2 ports. (PAR 3 and PAR 4 are available if an optional Multifunction PCB is installed). This program block also lets you control the terminal's setpoints. PAR 1 has four discrete inputs; PAR 2 has four discrete outputs. The JAGXTREME terminal has 12 setpoints. Setpoints are assigned to an internal scale (A,B,C,D or E) or can be disabled. When a setpoint is assigned to a scale, the operator can use the MEMORY key to access the setpoint and set its value.

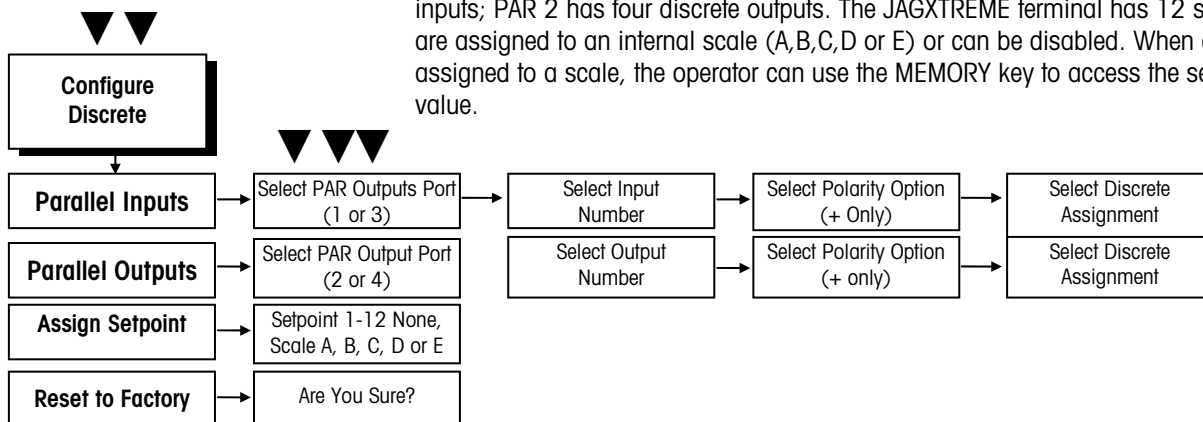

1. Discrete Inputs Sub-block

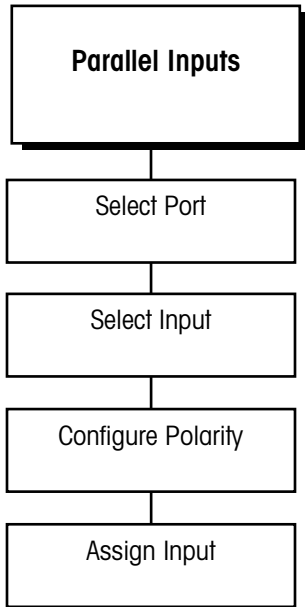

The Discrete Inputs sub-block lets you configure each of the four discrete inputs through PAR 1 (and an additional 8 on PAR 3 if an optional Multifunction PCB is installed).

1. Press ENTER at the [**Config Discrete**] prompt and again at [**Parallel Inputs**].
2. At the [**Port?**] prompt, select [**PAR 1**] or [**PAR 3**].
3. At the [**Discrete?**] prompt, select the specific input number (1 through 4 for PAR 1; 1 through 8 for PAR 3) to configure.
4. At the [**Polarity?**] prompt, select the input polarity option that defines the input active state. Options include:
 - **Positive (+)** —The assigned action will take place when the input IN 1-12 is grounded to the GND terminal on PAR 1 (or PAR 3).
 - **Negative (-)** —The assigned action will take place when the connection between the GND terminal on PAR 1 or PAR 3 and the input IN 1-12 is open.
5. At the [**Assign?**] prompt, select the action corresponding to the input you are configuring. The assigned action will happen when the input becomes active.

Tare—causes the terminal to tare a load on the scale when the input is active.

Clear—causes the terminal to clear the scale to gross zero when input is active.

Print—initiates a print command when the input is active.

Zero—causes the terminal to zero the scale when the input is active.

Pri Unit—changes the weight unit to the primary unit when the input is active.

Sec Unit—changes weight unit to secondary unit when the input is active.

Sw Units—toggles between the primary and secondary weighing units when the input is active.

Sel Scale—causes the terminal to display the second scale data (from scale A or B) when the input is active.

Sel Key—corresponds to pressing SELECT when the input is active.

Escape—corresponds to pressing ESC when the input is active.

Enter—corresponds to pressing ENTER when the input is active.

Cust_Prt (1 through 5)—initiates a command to print the contents of the selected template when the input is active.

Blank Display—puts dashes in upper display.

DisSetup—disables Setup Entry.

DisKeyPad—disables Keypad.

Prompts—start prompts remotely.

None—assigns no function to the input when it is active.

DisRnFit – disables “run flat” operation

AlarmAck – causes the terminal to silence the Alarm Output

6. At the [**Scale?**] prompt, press SELECT to choose the scale from which discrete data will come. Options include:

Active—the scale selected during normal operation

A—Scale A

B—Scale B

C—Scale C

D—Scale D

E—Summing

7. When you have finished configuring the first input assignment, JAGXTREME terminal returns to the **[Port?]** prompt where you can repeat steps 2 through 5 for each additional input you wish to configure.
8. When you are finished configuring all input assignments, at the **Port?** prompt, press ESC to return to the **[Parallel Inputs]** prompt. Press SELECT to display the **[Parallel Outputs]** prompt and continue.

If you are using the JagMAX application software, the application controls the use of PAR1 (discrete inputs). PAR3 (on the optional Multifunction PCB) should not be used.

2. Discrete Outputs Sub-block

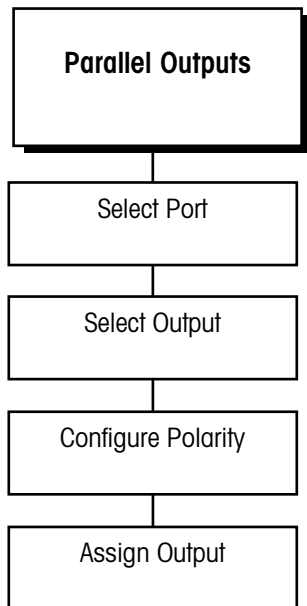

The Discrete Outputs sub-block lets you configure each of the four discrete outputs through PAR 2 (and an additional eight outputs for PAR 4 if an optional Multifunction PCB is installed). To configure outputs:

1. Press ENTER at the **[Parallel Outputs]** prompt.
2. At the **[Port?]** prompt, select PAR 2 or PAR 4 for the port you wish to configure.
3. At the **[Discrete?]** prompt, select the output number (1 through 12) to configure.
4. At the **[Polarity?]** prompt, select the output polarity option that defines the output active state. Options include:
5. **+ only**—in the active state, the output is actually switched to ground internally showing 0 VDC and supplying a ground as an output.
6. At the **[Assign?]** prompt, select the output action corresponding to the output you are configuring. The condition exists when the output becomes active. Options include:

Alarm – output is active when the JAGXTREME terminal is in an alarm condition as defined by the monitoring triggers.

- **Net Gross**—output is active when the JAGXTREME terminal is in the net mode.
- **Zero**—output is active when the displayed weight of the scale is within ± 0.25 increment of gross zero.
- **Motion**—output is active when the terminal is experiencing a motion condition.
- **Over Cap**—indicates weight on the scale exceeds the calibrated capacity when the output is active.
- **Undr Zero**—indicates the JAGXTREME terminal is displaying weight that is below gross zero when the output is active.
- **Setpoint**—indicates weight on scale reached a predetermined target weight.
- **None**—assigns no function to the output when it is active.

If you are using the JagMAX application software, the application controls the use of PAR2 (discrete outputs). PAR4 (on the optional Multifunction PCB) should not be used.

If Setpoint is Selected

1. At the **[Setpoint?]** prompt, select the particular output setpoint (1 through 12) you wish to configure.
2. At the **[Out?]** prompt, select the desired setpoint function. Options include:
 - **Feed**—the output turns the feeder off when weight on the scale reaches a predetermined cutoff value.
 - **Fast Feed**—the output controls the transition from fast to slow speed in dual-speed batching applications.
 - **Tolerance**—the output indicates whether residual weight on the scale is within a predetermined tolerance value. Please refer to the section entitled Memory Key Operations in chapter 4 for more information.

If An Assignment Other Than Setpoint is Selected

Note: Dribble value is equal to the target value minus the preact and dribble value.

1. At the **[Scale?]** prompt, select the scale to which the output refers (Scale A, Scale B, Scale C, Scale D or Summing Scale E).
2. When you have finished configuring the first output assignment, JAGXTREME terminal returns to the **[Port?]** prompt where you can repeat steps 2 through 5 for each additional output you wish to configure.
3. When you are finished configuring all output assignments, at the **[Port?]** prompt, press ESC to return to the **[Parallel Outputs]** prompt. Press SELECT to display the **[Assign Setpoints]** prompt and continue.

3. Assign Setpoints Sub-block

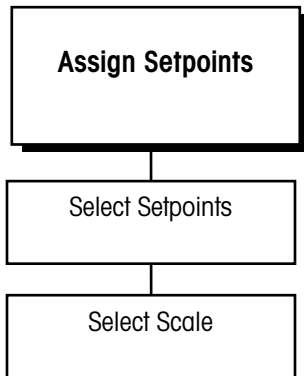

This sub-block lets you assign the terminal's setpoints to a scale or to disable setpoints.

To configure setpoints:

1. Press ENTER at the **[Assign Setpoints]** prompt.
2. At the **[Point?]** prompt, select the setpoint you wish to configure (1 through 12).
3. At the **[Scale?]** prompt, select Scl A, Scl B, Scl C, Scl D, Scl E, or None to assign the setpoint selected in step 2 to scale A-D, summing scale, or to disable the setpoint (none).
4. At the **[Name?]** prompt, use the numeric keys to enter a description for this setpoint. Please refer to the section entitled Alphabetical and Special Character Entry in Chapter 4 for more information on entering alphanumeric characters.
5. At the **[Source?]** prompt, select a scale reference to which the setpoint will respond. Options include:
 - **Net**—the net weight of the selected scale.
 - **Gross**—the gross weight of the selected scale.
 - **Rate**—the calculated rate of weight change over a predetermined period of time as configured in the Alternate Weight Units sub-block.
6. At the **[Type?]** prompt, select the setpoint operation condition. Options include:
 - **Fill**—if the setpoint will work when weight on the scale is increasing.
 - **Discharge**—if the setpoint will work when weight on the scale is decreasing.
7. When you have finished assigning the first setpoint, the JAGXTREME terminal returns to the **[Point?]** prompt where you can repeat steps 2 and 3 for each additional setpoint you wish to assign.
8. After you finish assigning all setpoints, at the **[Point?]** prompt press ESC to return to the **[Assign Setpoints]** prompt. Press ESC to return to the **[Config Discrete]** prompt. Then press SELECT to continue to the Configure Memory program block.

If you are using the optional JagMAX application software, the application uses and configures setpoint 1. The other setpoints cannot be used.

Configure Memory Program Block

This program block lets you configure literals, prompt lists, and consecutive numbers. These items are accessed when an operator presses the MEMORY key in Normal Operation mode. The following diagram describes the Configure Memory program block:

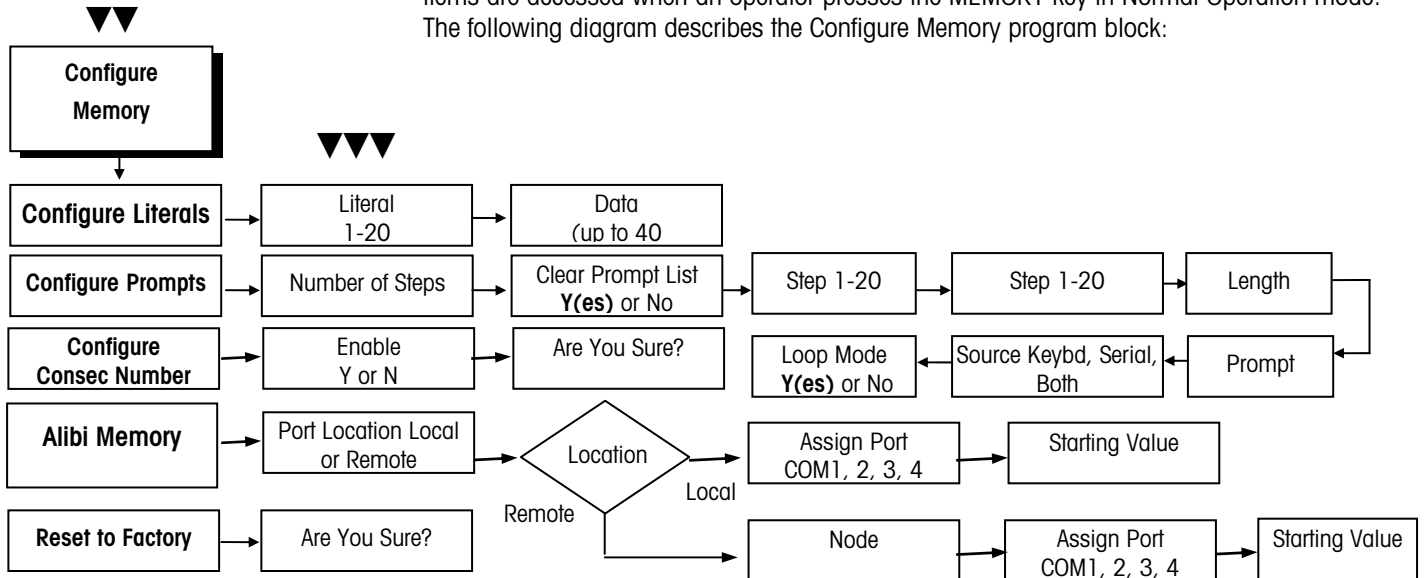

1. Configure Literals Sub-block

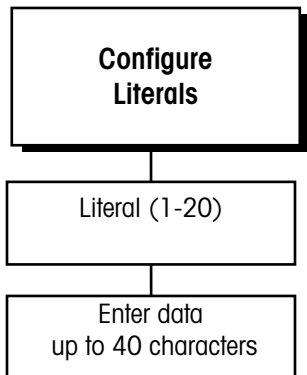

Literals are text strings, such as site name or address, that can be printed in a template. They can be up to 40 characters in length and are referenced by a field code (see the Configure Template Sub-block in this chapter). You can program up to 20 literals.

To configure literals:

1. Press ENTER at the **[Config Literals?]** prompt to open the sub-block.
2. At the **[Literal? 0]** prompt, enter a number for the literal you are creating or editing (01-20).
3. At the **[Data?]** prompt, enter the text for the literal. You can enter up to 40 alphanumeric characters. To enter lowercase letters and characters other than those on the JAGXTREME terminal keypad, you will need a QWERTY keyboard. Repeat steps 2 and 3 for each literal you wish to configure.
4. Press ENTER to continue to the next sub-block or ESC to exit the setup mode.

2. Configure Prompts Sub-block

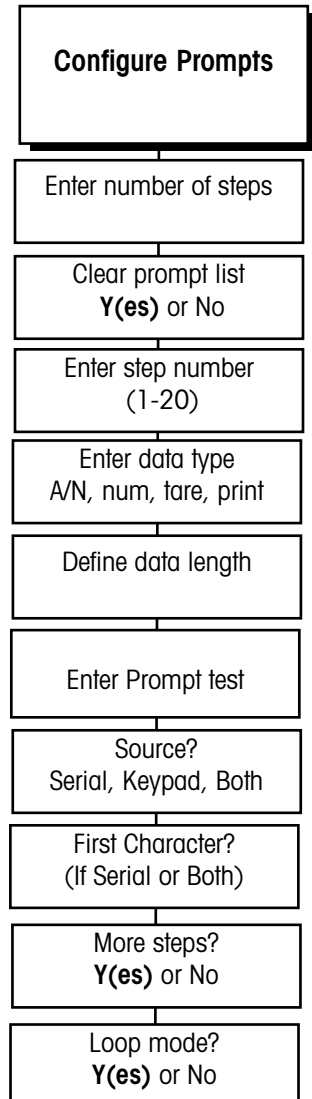

A prompt list displays written cues for an operator to perform a task while in Normal Operation mode. You can include up to 20 steps in a prompt list.

1. Press ENTER at the **[Config Prompts?]** prompt to open the sub-block.
2. Press ENTER at the **N(o) of Steps** prompt. This number tells you how many steps are in the current prompt list.
3. At the **[Clr Prmpt Lst?]** prompt, select **Y(es)** if you wish to clear the existing prompt list and reset the step number to 0, or select **N(o)** if you want to edit or add steps in the existing prompt list.

If Y(es), at the **[Are You Sure?]** prompt, select **Y(es)** or **N(o)** to clear or keep the current prompt list.

If N(o), at the **Step 1** prompt, begin entering data. If you are editing an existing prompt list, you must scroll through each step in the list to get to the desired step you wish to edit or create.

4. At the **[Data Type?]** prompt, select the type of data that will be entered by the operator in response to the prompt. Choices include:

Option	Data Type	Max. Length
A/N	Alpha-numeric	40 characters
Num	Numeric	8 numbers
Tare	Tare Weight	N/A
Print	N/A	N/A

Numeric data type prohibits the operator from entering anything other than numbers or a decimal point. Tare data type allows a preset (keyboard), or pushbutton tare entry. Print data type causes a print output to occur when the operator presses ENTER at a print step in the template. If no prompt is entered, print output will occur automatically.

1. At the **[Length?]** prompt, enter the maximum number of characters that the operator will enter in response to the prompt according to the type of data selected above.
2. Press ENTER at the **[Prompt?]** prompt, then input the actual text for the operator prompt (up to 16 characters). Press ENTER to accept the text after you finish keying the string.
3. At the **Source?** prompt, select the entry source for the data. Options include:
 - **Serial**—Data input will be from a JAGXTREME terminal serial port such as from a bar code reader
 - **Kybd**—Data input will be from the JAGXTREME keypad or an external PC keyboard
 - **Both**—Data input will be from a keyboard or serial port source
 - METTLER TOLEDO recommends using both to accommodate input regardless of specific source.

If Serial or Both

1. At the **[First Character?]** prompt, enter the number of the first character position to be used by the JAGXTREME terminal for the prompt response. For example, consider the prompt response "1521" that is received in the following serial input string: <STX> <SP> <SP> <SP> 1521 <CR>
2. The first character of the response ("1") is the fifth character in the string, so you would enter "5" at the **[First Character?]** prompt. Refer to Appendix 1 for more information.

3. At the **[More Steps?]** prompt, select **Y(es)** or **N(o)** if more steps will be entered in the prompt list. If **Y(es)**, the terminal automatically increments to the next step.
4. At the **[Loop Mode?]** prompt, select **Y(es)** or **N(o)** to enable or disable the prompt list loop mode. This feature causes the JAGXTREME terminal to remain in the prompt list (in normal operating mode) until the operator presses ESC.
5. Continue to the next sub-block or press ESC to exit setup mode.

3. Configure Consecutive Numbering Sub-block

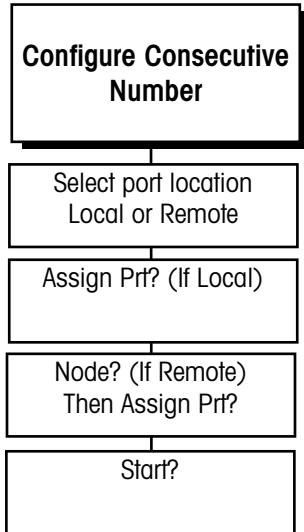

Consecutive numbering is used for sequencing purposes. The JAGXTREME terminal automatically increments the number from a defined starting point.

To configure consecutive numbering:

1. Press ENTER at the **[Configure CN?]** prompt to open the sub-block.
2. At the **[Port Loc?]** prompt, select the port location through which data will flow triggering the next consecutive number. You must select a port configured for demand output from this specific JAGXTREME terminal. Choose local or remote.

If Local

At the **[Assign Prt?]** prompt, select the appropriate COM port.

If Remote

At the **[Node?]** prompt, select the appropriate remote JAGXTREME terminal (1-6), then select the COM port at the **[Assign Prt?]** prompt as for local.

3. At the **[Start?]** prompt, enter the first consecutive number to be used (0-99999999) after a reset.
4. Press ENTER to continue to the next sub-block or press ESC to exit setup mode.

4. Alibi Memory

Note: Alibi memory is available only in JAGXTREME revision A or higher.

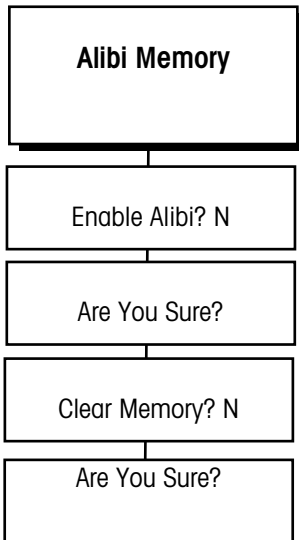

Alibi memory enables the JAGXTREME terminal to provide an audit trail for transactions. (It is a metrological requirement for OIML markets). The JAGXTREME terminal's alibi memory stores the last 65,536 Demand Print Transactions, including the time, date, consecutive number, scale identifier, net weight and tare weight for each.

Using the control panel or web page menus, you can search for and recover specific transactions. Date-time, consecutive number, net weight and tare weight can be used as the search keys. The entire alibi memory file can be extracted from the JAGXTREME terminal using the FTP server.

Alibi memory uses 1 megabyte of RAM disk space when configured. This reduces the amount of RAM disk space available for JagBASIC and system log files to approximately 900K bytes. When configuring alibi memory, you may lose any existing files in the RAM disk. Before configuring alibi memory, you should use FTP or Zmodem to backup any files you wish to keep.

1. Press ENTER at the **[Alibi Memory]** prompt to open the sub-block.
2. At the **[Enable Alibi?]** prompt, press ENTER to choose N(o) or press SELECT and then ENTER to choose Y(es). You must press the Cal. Switch in and hold it in before you press ENTER to accept Y(es). Failure to hold in the Cal. Switch will result with the message **[Cal. Switch Off]**.

If successful, the terminal will automatically reboot and then power-up in Run mode. The user will have to access setup again to finish alibi memory installation. To clear the memory:

At **[Clear Memory?N]**, toggle to Y(es) and press ENTER to continue.

At **[Are You Sure?N]**, toggle to Y(es). Press the cal switch and hold it while you press ENTER to clear the memory.

Configure JagBASIC Program Block

This sub-block details how to configure JagBASIC.

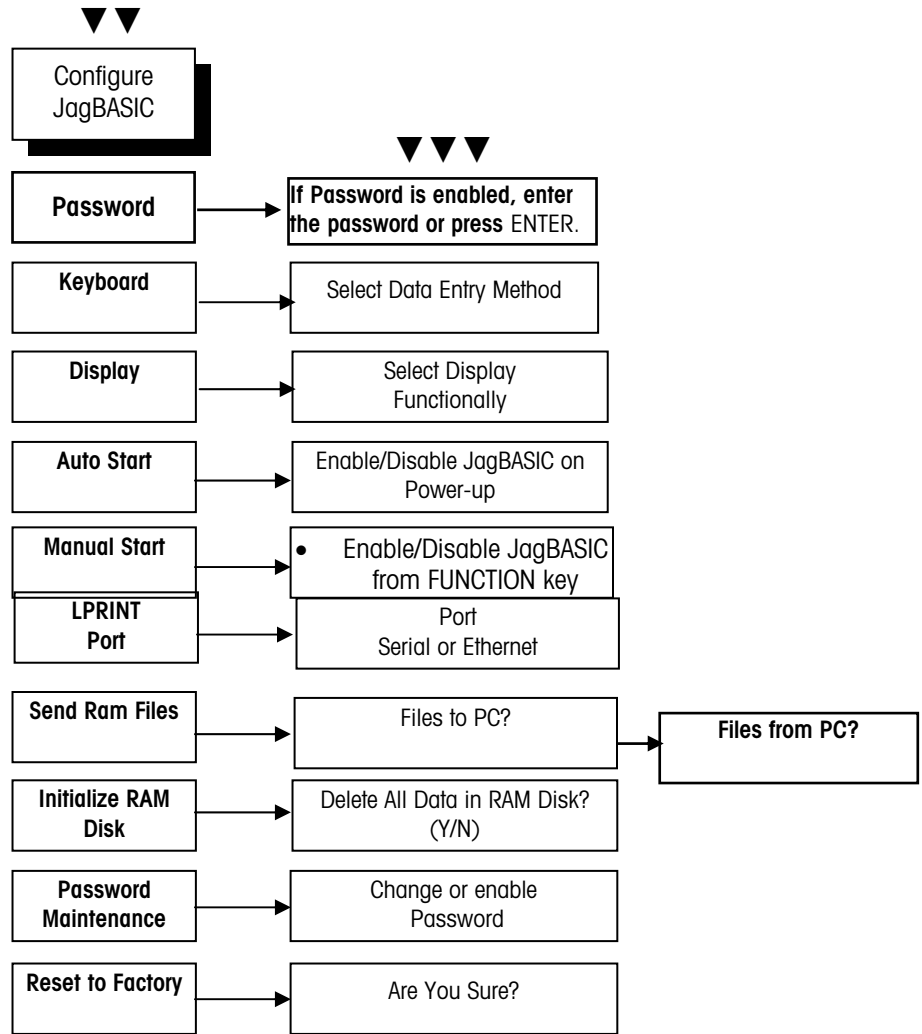

Enter the JagBASIC password to access the program block. If none has been entered since the last Master Reset, press ENTER to access the program block.

1. Password Sub-block

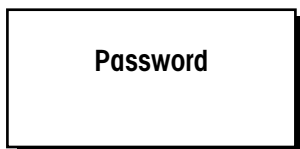

The first sub-block is the password security block. Password security is available to allow the JagBASIC programs to be protected from unauthorized changes. Enter the password at the [Passwd?] prompt, then press ENTER. Or, just press ENTER if no password has been previously configured. Entry of an incorrect password will cause the JAGXTREME terminal to display the message [Access Denied].

2. Keyboard Sub-block

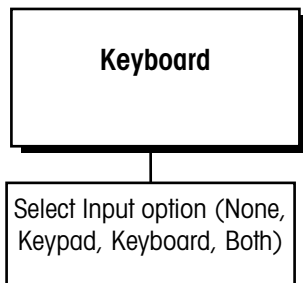

The Keyboard sub-block lets you select the type of device that will be used to input data to JagBASIC at an input or inkey prompt. The selected device is also used for BASIC command line mode.

To configure the Keyboard sub-block:

1. Press ENTER at the [Config JagBASIC] prompt to access the program block.
2. Press ENTER at the [Keyboard] prompt, then select the desired input device:
 - **None**—No keyboard input is required. This option is used with programs designed to operate in the background and monitor data input and output without operator intervention.
 - **Keypad**—The JAGXTREME terminal keypad will be used for JagBASIC input **and** standard JAGXTREME terminal functions.
 - **Kboard**—An optional PC-type QWERTY keyboard will be used for JagBASIC input **and** standard JAGXTREME terminal functions.
 - **Both**—The JAGXTREME terminal keypad and an optional keyboard will be used for JagBASIC input.
 - If Both is selected, standard terminal functions (including setup) cannot be accessed with the keyboard. If you need to access setup with both keyboard and keypad selected, turn switch 2 off, then power up to enter setup and change this option to Keyboard. Turn switch 2 on when finished.
3. Press ENTER to continue to the next sub-block or ESC to exit the setup mode.

3. Display Sub-block

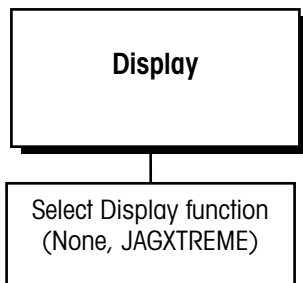

This sub-block lets you select the display area to be used by a Jag BASIC program when a Print statement is executed.

To configure the sub-block:

1. Press ENTER at the [Display] prompt, then select the display area for JagBASIC output:
 - **None**—JagBASIC output is not displayed.
 - **JAGXTREME terminal**—The JAGXTREME terminal lower display area shows JagBASIC output and standard JAGXTREME terminal output.
2. Press ENTER to select the display option and continue to the next sub-block.

4. Auto Start Sub-block

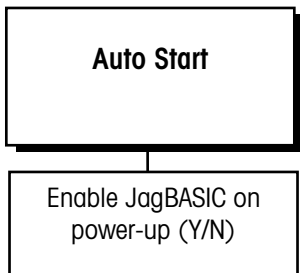

The Auto Start sub-block lets you start the JagBASIC program (file1 .bas) automatically on power-up.

To configure the sub-block:

1. Press ENTER at the [**Autostart**] prompt, then press SELECT to display Y(es) or N(o). If enabled Y(es), the JagBASIC program will automatically start each time power is applied to the JAGXTREME terminal.
2. Press ENTER to select the auto start option and continue to the next sub-block.

5. Manual Start Sub-block

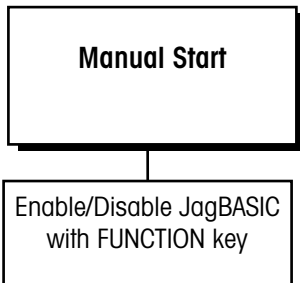

The Manual Start sub-block lets you configure JagBASIC as an operation associated with the FUNCTION key.

To configure the sub-block:

1. Press ENTER at the [**Manual Start**] prompt, then press SELECT to display Enable or Disable. If enabled, JagBASIC programs can be started manually when the operator presses the FUNCTION key.
2. Press ENTER to select the manual start option and continue to the next sub-block.

6. LPRINT Port

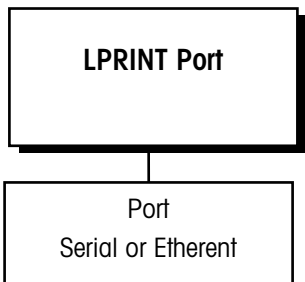

This sub-block directs where "LPRINT" commands should send the data in a JAGXTREME program. The selections are serial or Ethernet. If you choose serial, the commands will process through the serial port defined with a "Basterminal" connection.

7. Send RAM Files Sub-block

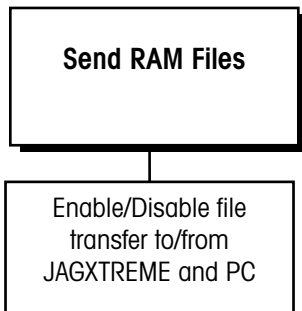

This sub-block works with the JagBASIC send and receive programs that must be installed in your PC and lets you configure file transfer to and from the terminal and your PC. File transfer is initiated and transferred in setup mode.

Communications must be established between the PC and JAGXTREME terminal to transfer files. If communications are not established, the terminal will time-out and return to the beginning of this sub-block.

To transfer files:

1. Press ENTER at the [**Send RAM Files**] prompt.
2. At the [**Files to PC?**] prompt, select [**Y(es)**] if you want to enable file transfer from the terminal to your PC, or [**N(o)**] if you do not want file transfer in this direction.

Refer to the JagBASIC Programmer's Guide for more details.

If Y(es) is Selected

- At the [**Are You Sure?**] prompt, select [**Y(es)**] to enable the JAGXTREME terminal to transfer files from its RAM disk to your PC. If you respond [**N(o)**] to this prompt, JAGXTREME terminal prompts [**Files From PC?**]

If N(o) is Selected

- At the [**Files From PC?**] prompt, select [**Y(es)**] to enable file transfer from your PC to the JAGXTREME terminal, then respond [**Y(es)**] at the [**Are You Sure?**] prompt. The terminal displays [**Receiving from PC.**]

3. Press ENTER to continue to the next sub-block.

8. Initialize RAM Disk Sub-block

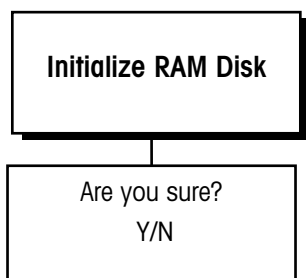

This sub-block lets you delete all files in the JAGXTREME terminal's RAM disk and initialize it for new files.

1. Press ENTER at the [**Init RAM Disk?**] prompt.
2. At the [**Are You Sure?**] prompt, select [**Y(es)**] to delete the RAM disk files. Select **N(o)** if you do not wish to erase all files on the RAM disk at this time.
3. Use caution if you select Y(es) to delete all RAM disk files. These files cannot be recovered once they are deleted.
4. Press ENTER to continue to the next sub-block.

9. Password Maintenance Sub-block

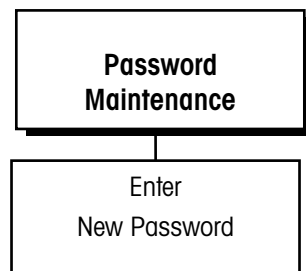

The Password Maintenance sub-block lets you enter a password that must be used each time the JagBASIC program block is accessed. The password secures the JagBASIC programs against unauthorized access and changes.

To configure the sub-block:

1. Press ENTER at the [**Password Maint**] prompt.
2. At the [**Passwd?**] prompt, enter a unique password (up to eight characters).
3. Press ENTER to accept the password and continue to the next sub-block.

After exiting the Configure JagBASIC program block the first time, you must use the password each time you reenter the program block.

Please record the password and keep it in a secure location. If the password is lost, the only way to access the JagBASIC program block again is by performing a Master Reset which will return all JAGXTREME terminal configuration parameters to default values and clears the RAMDISK which stores any JagBASIC programs.

METTLER TOLEDO recommends that you distribute the password to only those who need access to the JagBASIC program block.

Configure Network Program Block

The JAGXTREME terminal can be configured as a network device on a local area network (LAN). The Network Interface block lets you configure the network port and identify which terminal nodes it may access. The following diagram describes this block:

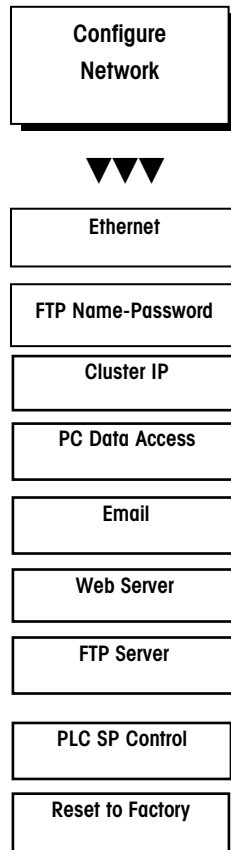

To successfully connect to a JAGXTREME terminal and browse it via Internet Explorer (4.0 or higher only) over a network that is using a proxy server, make sure that the terminal's IP address is added to the Internet Explorer LAN connection Proxy Server Settings Exceptions list.

Network Overview

Before configuring the Network program block, you should review the following information which provides an overview of the terminology and concepts involved in networking.

TCP (Transmission Control Protocol) is a robust communication protocol that provides high quality, in-sequence, and error-free service. TCP provides a means of connecting multiple computers together and exchanging data between them. TCP could be considered the pipeline used to transport other protocols including SMTP and FTP.

IP (Internet Protocol) is a low-level protocol that routes messages through a network. TCP and all other higher-level protocols use IP. IP packets are not guaranteed to arrive in sequence and rely on TCP to rebuild them in sequence.

SMTP (Simple Mail Transfer Protocol) is a TCP/IP protocol used in sending and receiving e-mail.

FTP (File Transfer Protocol) is a standard Internet protocol. It is the simplest way to exchange files between computers on the Internet. Like the Simple Mail Transfer Protocol (SMTP), which transfers e-mail, FTP is an application protocol that uses the Internet's TCP/IP protocols. FTP is commonly used to transfer program and data files from the computer that acts as their server for everyone on the Internet. It's also commonly used to download programs and other files to your computer from other servers.

Web Server is a computer that delivers or serves up web pages. Every web server has an IP address and possibly a domain name. Any computer can be turned into a web server by installing server software and connecting the machine to the Internet. The web server uses the Hypertext Transfer Protocol (HTTP), which transfers displayable web pages and related files.

Network refers to a group of two or more computers that are linked together. There are many types of networks, including:

- **Local area networks** (LAN): The computers are geographically close together and are typically housed in the same building.
- **Wide-area networks** (WANs): The computers are farther apart and are connected by telephone lines, fiber optic cables, or radio waves.

In addition to these types, the following characteristics are used to categorize different types of networks:

Topology: The geometric arrangement of a computer system. Common topologies include a bus, star, and ring.

Protocol: The protocol defines a common set of rules and signals that computers on the network use to communicate. One of the most popular protocols for LANs is called Ethernet. Another popular LAN protocol for computers is the token-ring network.

Architecture: Networks can be broadly classified as using either a peer-to-peer or client/server architecture.

Nodes: Computers on a network are sometimes called nodes.

Servers: Computers and devices that allocate resources for a network are called servers.

Clients: Computers and devices that use these resources are called clients.

Networking features supported in the JAGXTREME terminal:

- Clustering
- Embedded Web Server
- FTP Server
- SMTP Client
- TCP/IP
- Ethernet
- JagBASIC Client and Server Application Interface

General Networking Considerations

IP addresses

WARNING: If your JAGXTREME terminal(s) is/are connected to a local area network (LAN) having other devices already connected, do not choose IP addresses without consulting with the owner of the LAN. Serious network service problems can occur if you inadvertently choose an IP address that is already in use.

IP addresses are 32-bit numbers that are often broken down for easier reading into octets. An octet is a 3-digit number between 0 and 255. An IP address contains 4 octets. The network identifier is typically defined in the first 3 octets. The last octet is usually an identifier of the individual node.

A unique IP address is required for each individual node on the network. For example, when a JAGXTREME terminal uses TCP/IP protocol, the IP addresses must be unique for both. These IP addresses must also be unique to the other nodes such as computers, other JAGXTREME terminals or other devices.

An end user must configure TCP/IP with the following information:

- The IP address.
- The Subnet Mask. This defines how much of the IP address is used for identifying the local network and how much of the IP address is used to identify the node on that network.

Example: A JAGXTREME terminal has the following IP address: 130.132.59.234. If the first three bytes or octets designate the Local Area Network (LAN) address, then the Subnet Mask must be defined as 255.255.255.0 (255 is the largest byte value and represents the number with all bits turned on).

JAGXTREME terminal's IP address: 130.132.59.234

Subnet mask for the JAGXTREME and all other members of its LAN on: 255.255.255.0

The Computer's IP address: 130.132.59.233

The subnet denotes that any other machine with an IP address beginning 130.132.59.* is on the same LAN, so messages are sent to it directly. Any IP address beginning with a different value can only be accessed indirectly by sending the message through a gateway or router (which ties the JAGXTREME terminal's LAN to other LAN's).

Clustering JAGXTREME Terminals

Clustering is a means of networking up to six individual JAGXTREME terminals together on a peer-to-peer Ethernet network. This is accomplished by assigning each JAGXTREME terminal an IP address and a terminal number.

Cluster IP Setup

You can configure the Cluster IP sub-block to allow one or more JAGXTREME terminals to act as a console terminal for the other terminals in a cluster. It is possible to have more than one network console in a cluster. Up to six (6) terminals can be members of a cluster. Note: Each terminal must have a unique IP address for the terminals within the cluster to communicate properly.

Hardware Requirements:

- JAGXTREME terminal(s)
- Ethernet cable(s)
- Ethernet hub(s)







Terminal Setup:

1. Enter setup, select **[Network]** then press ENTER.
2. Select **[Cluster IP]** and press ENTER.
3. At the **[Net Console? N]** prompt, press ENTER if this terminal is not the network console of a JAGXTREME cluster (although it might participate in a cluster for another console device). Select **Y(es)** if this device will be the network console for a JAGXTREME cluster. Selecting **Y(es)** at the Net Console prompt enables the JAGXTREME terminal to communicate with and have full access to the other terminals in the cluster.
4. At the **[This Term?]** prompt, use the numeric keys to enter a cluster ID number (1-6) for this JAGXTREME terminal.
5. At the **[Terminal #? Y]** prompt, press ENTER to confirm that you are assigning one of the five (5) other terminals to this device as a network console. Repeat steps 2 and 3 as needed for the other terminals. Or, select **N(o)** to skip this section.
6. At the **[IP? 111111111111]** prompt, enter the permanent IP address of each JAGXTREME terminal assigned to the console. Enter the address in decimal octets but without decimal points. Press enter.
7. Repeat this process for each terminal in the cluster. Make sure that each terminal has a unique IP address, perhaps by incrementing the last digit in the number by 1 so that each terminal has a unique IP address. Cycle power on the JAGXTREME terminal after setting the IP addresses.

Example: The IP address of the first JAGXTREME terminal in a cluster of three JAGXTREME terminals is 200.200.200.201. Increment the last digit in this number (in this example, the 1) for the next terminal in the cluster so that its IP address is 200.200.200.202. Increment the last digit by 1 again so that the IP address for the third JAGXTREME terminal is 200.200.200.203. Each of the three terminals now has a unique IP address.

Note: In order for two JAGXTREME terminals to talk to each other in a cluster, they both must be setup with each other's IP address in the cluster setup.

Cluster IP Example Setup Chart

Description	Term #1	Term #2	Term #3	Term #4	Term #5	Term #6	Network Hub
Standard Ethernet RJ-45							
IP Address	200.200.200.201	200.200.200.202	200.200.200.203	200.200.200.204	200.200.200.205	200.200.200.206	N/A
Sub-Net Mask	255.255.255.000	255.255.255.000	255.255.255.000	255.255.255.000	255.255.255.000	255.255.255.000	N/A
Gateway	000.000.000.000	000.000.000.000	000.000.000.000	000.000.000.000	000.000.000.000	000.000.000.000	N/A
Net Console	Y	Y	Y	Y	Y	Y	N/A
Web Server	Y	Y	Y	Y	Y	Y	N/A
PC Data Access	Y	Y	Y	Y	Y	Y	N/A

PC Data Access

PC Data Access gives PC applications access to the JAGXTREME Shared Data. The physical connection is an Ethernet connection. It also allows access of scale information via MT Connections. For additional information consult the MT Connections documentation. To enable this feature, enter setup. At the **[Config Network]** display, select **[PC Data Access]**, press ENTER, and then choose **Y(es)** at the **[Host Node?]** prompt.

SMTP Setup

SMTP allows the terminal to send emails via an Ethernet connection to a dedicated mail server (on a computer network).

Requirements for the Server:

- The server must have a mail server program that supports SMTP. The server must have a means (network) of forwarding the Email to it's intended recipient.
- This feature requires an advanced knowledge of mail servers and networking and should be configured by a network administrator.

Setup in the Server:

The server setup is dependent upon the operating system and the Email server used. This should be handled by a network administrator.

Setup in the JAGXTREME Terminal:

1. Enter setup mode. Select **Config Network** and press ENTER.
2. Select **Email** and press ENTER.
3. At the **Enable Email** prompt, select **Y(es)** and press ENTER.
4. At the **IP** prompt, enter the IP address of the mail server and press ENTER.
5. At the **name** prompt, enter the name of your terminal and press ENTER.
6. At the **Addr** prompt, enter the Email address of the JAGXTREME terminal.
7. At the **Subj? Automated** prompt, press ENTER.

8. At the **TCP Port** prompt, enter the TCP port number. Note that the default is **25** and is the most the common setting for Email configurations. Consult your network administrator before changing this setting.
9. At the **Email Recip? 1** prompt, press ENTER.
10. At the **Addr?** prompt, enter the Email recipient's address. Note: The JAGXTREME terminal and the recipient must have accounts already configured in the Email server in order to send Email from the JAGXTREME terminal.
11. At the **Calib. Check** prompt, select **Y(es)** or **N(o)** and press ENTER. When enabled, this feature is used to automatically send an Email if a calibration check fails.
12. At the **Predict Fail?** prompt, select **Y(es)** or **N(o)** and press ENTER. When enabled, this feature allows POWERCELL scale interface users to automatically generate an Email based on the Predictive Failure Analysis settings in maintenance mode.
13. At the **Done** prompt, select **Y(es)**.

Note: If problems are encountered with Email messaging, have a network administrator check the Email server setup and make any necessary corrections.

Testing the Email

You can test the Email function in the diagnostics section.

1. Enter setup. Choose **Diagnostics** and press ENTER.
2. Select **Email** and press ENTER.
3. At the **Test Email?** prompt, select **Y(es)** and press ENTER to send a test message.
4. A message should appear that says **Email Msg Queued**. This indicates that the message has been sent from the JAGXTREME terminal.

FTP

FTP (file transfer protocol) is used to upload and download files to and from the JAGXTREME terminal. This feature can allow remote editing of JagBASIC programs and data acquisition of calibration check information. The FTP server in the JAGXTREME terminal can be accessed through most any FTP client. Typically, this is done via DOS prompt, Internet Explorer, or Windows PC FTP utility. The following commands are supported:

- dir
- send
- rec
- quit

Note that an Ethernet network can be used for FTP.

If you want to delete a file, you can go to the JagBASIC command line and type KILL "filename". If you want to delete ALL files, you can select INIT RAMDISK under the JagBASIC selection.

JAGXTREME Setup:

1. Enter setup. Select **Config Network** and press ENTER.
2. Select **FTP Server** and press ENTER.
3. At the **Enable FTP Ser** prompt, select **Y(es)** and press ENTER.

If you do not want anonymous login, you must setup a user and password in the JAGXTREME terminal. To log on, point the FTP client to the JAGXTREME terminal's IP address. Enter a name and password.

User and Password in the JAGXTREME

1. Enter setup. Select **Config Network** and press ENTER.
2. Select **Name-Password** and press ENTER.
3. At the **Action?** Prompt, select **Find Name** or **New Name** and press ENTER.
4. Enter a new name or select from the pre-defined names.
 - If a new name is chosen, enter the password and exit setup.
 - If a pre-defined name is chosen, select **Y(es)** to edit the password.
5. The other users should be deleted at this point in order to have a secure configuration.
6. Exit setup.

Embedded Web Server

This tool provides access to the JAGXTREME terminal via an Ethernet connection using a web browser. To access it, Ethernet access must be configured.

JAGXTREME Setup:

1. Enter setup. Select **Config Network** and press ENTER.
2. Select **Web Server** and press ENTER.
3. At the **Enable Web Server** prompt, select **Y(es)** and exit.
4. Make sure the JAGXTREME terminal has a unique IP Address and the correct Subnet Mask.

Browser Considerations:

- Must be Internet Explorer 4.0 or higher revision.
- Disable proxy server.
- Enable cookies.
- You can specify the address to bypass the proxy for the JAGXTREME terminal. If you are unsure about these settings, consult with your network administrator.
- To connect to the JAGXTREME terminal, type in the IP address in the URL window and push ENTER. Example: `http://146.207.105.206`
- Test communications by pinging the JAGXTREME terminal. From the DOS prompt type: `PING xxx.xxx.xxx.xxx. xxx.xxx.xxx.xxx` is the IP address of the terminal.
- Make sure a crossover Ethernet cable is used if you are connecting directly to the JAGXTREME terminal.
- Always ensure the JAGXTREME terminal has a unique IP address.

1. Ethernet Sub-block

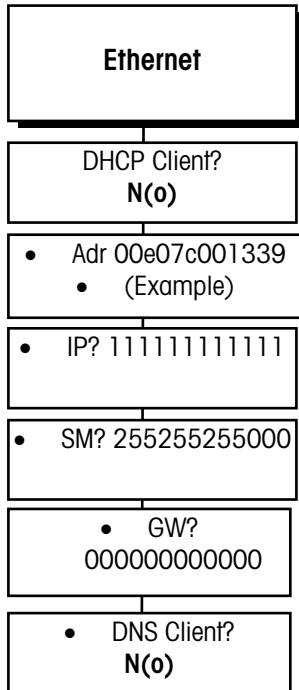

This sub-block lets you configure the TCP/IP Ethernet Address options. To configure this sub-block:

1. Press ENTER at the [**Configure Network**] prompt, then press ENTER again at the [**Ethernet**] prompt. The display will read **Adr 00e07c001339** (example only). This is the Ethernet MAC address entered at the factory. It cannot be modified in the field. Press ENTER.
2. At the [**DHCP Client?**] prompt, you must select **N(o)** to indicate that the JAGXTREME terminal will use the permanently assigned IP address, sub mask, and gateway address entered in the next steps. **Do not select Y(es)**. Press ENTER.
3. The display reads [**IP? 111111111111**]. This is the permanent IP address that will be used for the web server and for JagBASIC access to the terminal. Enter your desired IP address and press ENTER.
4. The display reads [**SM? 255255255000**]. This is the IP address sub-mask. Enter your desired sub-mask and press ENTER.
5. The display reads [**GW? 000000000000**]. This is the gateway IP address. Enter your desired gateway address (if any) and press ENTER.
6. At the [**DNS Client?**] prompt, select **N(o)**. This indicates that the JAGXTREME terminal does not use Domain Name Server services.

2. Name-Password Sub-block

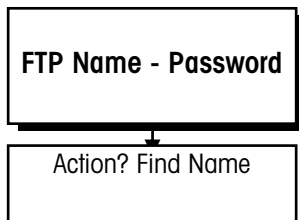

This sub-block allows you to edit a list of six name-password pairs. The name-password pairs are used to authenticate access to the JAGXTREME terminal via the FTP server.

1. At the [**Action?Find Name**] prompt, press ENTER to find an existing name-password pair or press SELECT to create a new pair.
2. If you press ENTER to find an existing name-password, the display reads [**Name0 xxxxxx**]. Press ENTER. The display reads [**This Name? N**]
3. Press ENTER to confirm **N(o)** and return to the [**Action?**] prompt. Or, press SELECT for **Y(es)** then ENTER to edit this name.
4. If you selected to change the name, the display will read [**Action? Change**]. Press ENTER. The display will read [**Pswd? xxxxxxxx**]. Enter the new password here.

3. Cluster IP Sub-block

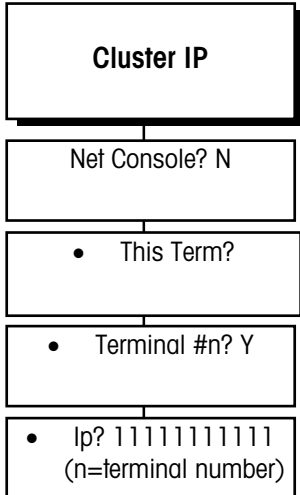

Configuring the Cluster IP sub-block allows one JAGXTREME terminal to act as a console terminal for other JAGXTREME terminals. Up to six (6) terminals can be members of a cluster.

1. At the [**Net Console? N**] prompt, press ENTER if this terminal is not the network console of a JAGXTREME cluster (although it might participate in a cluster for some other network console device). Select **Y(es)** if this device will be the network console for a JAGXTREME cluster.
2. At the [**This Term?**] prompt, use the numeric keys to enter a cluster ID number (1-6) to this JAGXTREME Terminal.
3. At the [**Terminal #n? Y**] prompt, press ENTER to confirm that you are assigning one of five (5) possible other terminals to this device as a network console. Repeat as needed until completed with all other terminals. Select **N(o)** to skip this section.
4. At the [**IP? 1111111111n**] prompt (where n= the terminal number), enter the IP address of the other terminal(s) assigned to this console.

4. PC Data Access (Reserved for Future Use)

5. Email

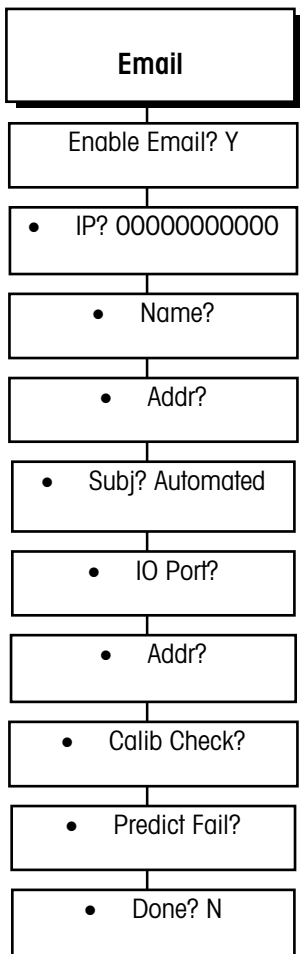

1. At the [**Enable Email? Y**] prompt, select **Y(es)** to enable Email Alerter, a send-only Email client. Select **N(o)** to disable and skip this section.
2. If you selected **Y(es)**, press ENTER. The display will read **IP? 000000000000**. This is the IP address for the SMTP server that will forward the Email. Enter the IP address and then press ENTER.
3. The display will now read [**Name?**] Use the numeric keys to enter the name that will be used in the Email message "Sender" field. Press ENTER.
4. At the [**Addr?**] prompt, enter the Email address to use in the Email "Sender's Email Address" field. The JAGXTREME terminal cannot accept return Email. However, entering this address is useful for identifying the sending machine. Press ENTER.
5. At the [**Subj? Automated**] prompt, enter the string to use in the Email message "Subject" field. Press ENTER.
6. At the [**IO Port?**] prompt, press ENTER to send out Email via Ethernet.
7. The display will read [**Addr?**]. Enter the Email address for the recipient number selected in the previous step. Press ENTER.
8. The display will read [**Calib Check?**] Press ENTER to select **N(o)** and disable Email transmission for all calibration check failures for this recipient. Press SELECT then ENTER to select **Y(es)** and send Email for all configured alerts to this recipient.
9. The display reads [**Predict Fail?**] Press ENTER to select **N(o)** and disable Email transmission for all predictive failure conditions for this recipient. Press SELECT then ENTER to choose **Y(es)** and send an Email for all predictive failure conditions for this recipient.
10. The display reads [**Done? N**] Press ENTER to select **N(o)** and loop back to ask for another recipient. Press SELECT then ENTER to choose **Y(es)** and exit this section.

6. Web Server Sub-block

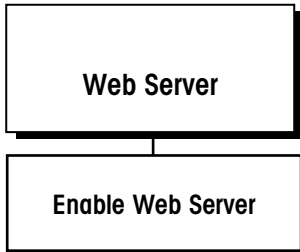

1. At the [**Web Server**] display, press ENTER.
2. The display will read [**Enable Web Ser? Y**] Press ENTER to select **Y(es)** and enable remote access via the embedded web server. Or, press SELECT then ENTER to choose **N(o)** and disable the web server. Press ENTER to move to the next sub-block.

7. FTP Server Sub-block

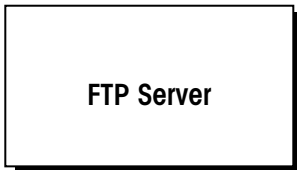

At the [**Enable FTP Ser?**] prompt, select **Y(es)** to enable remote file transfer access via the embedded FTP Server. Select **N(o)** to disable the FTP server.

8. PLC SP Control Sub-block



The PLC SP Control sub-block is used to let the PLC control setpoints. To configure the sub-block:

1. Press ENTER at the [**PLC SP Control**] prompt.
2. Select **Y(es)** to control setpoints through the PLC option (in either a local or remote terminal). Select **N(o)** if no control.
3. Press ENTER to continue to the next sub-block or ESC to exit the setup mode.

Configure Diagnostics Program Block

Every JAGXTREME terminal can perform a series of diagnostic tests. The tests are done through this block while you are in the setup mode. The following diagram describes this block:

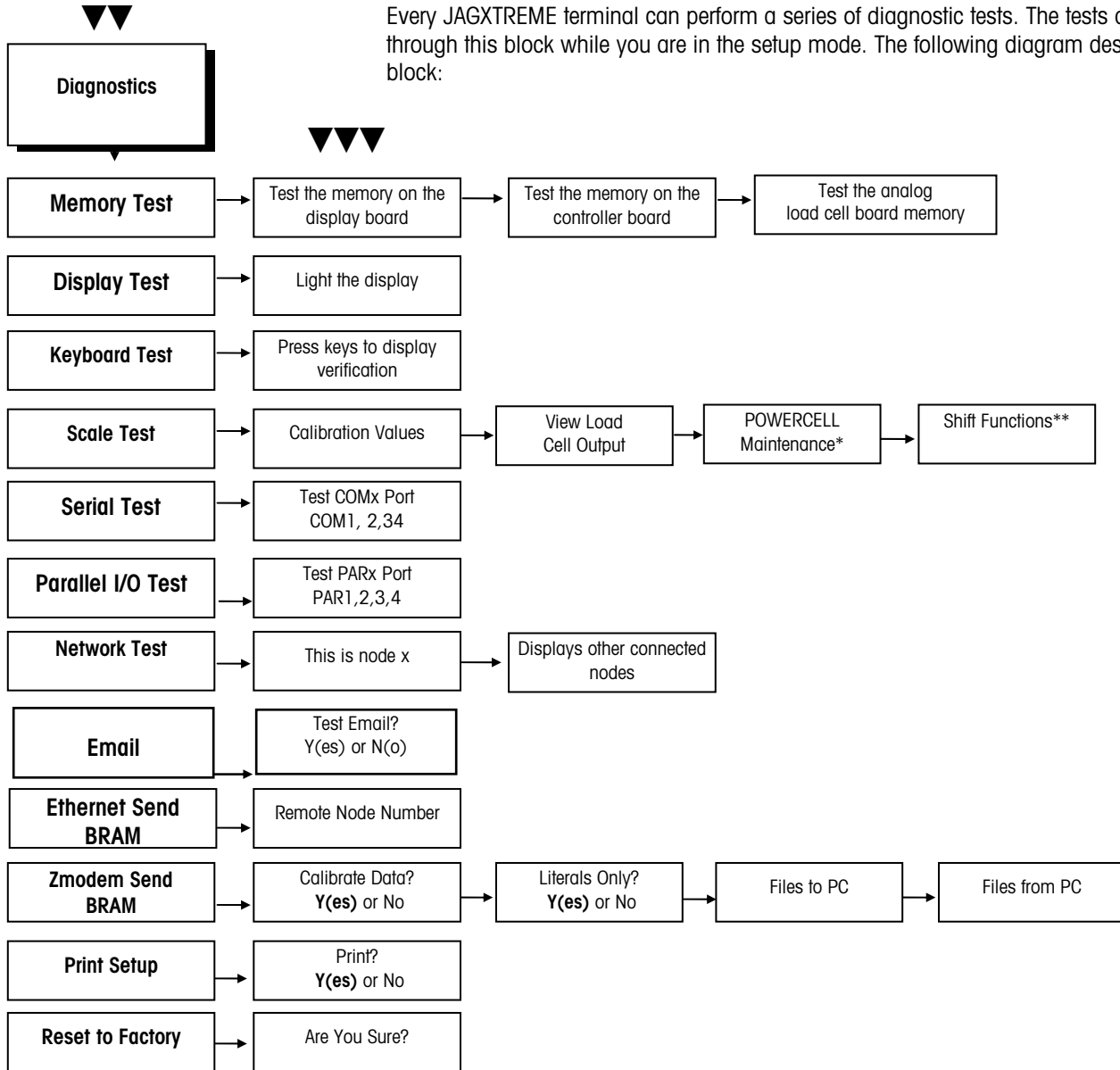

*If scale type POWERCELL (RAAD Box) is selected. **If scale type POWERCELL (RAAD box) or DigiTOL J-Box is selected.

1. Memory Test Sub-block

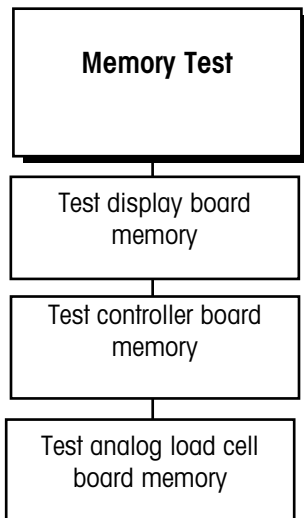

The Memory Test sub-block tests the terminal's internal memory. These diagnostics test the Flash memory, RAM, and EEPROM on the Controller board and any optional boards that are installed. The results of the memory tests are displayed on the terminal.

To execute the memory tests:

1. Press ENTER at the **Memory Test** prompt. The JAGXTREME terminal automatically tests the Controller board, and proceeds to any optional boards that are installed. The terminal flashes the software revision and part number of the component currently being tested and its status.
2. As the tests are complete, the terminal flashes the results on the lower display.
3. Continue to the next sub-block or exit the setup mode.

2. Display Test Sub-block

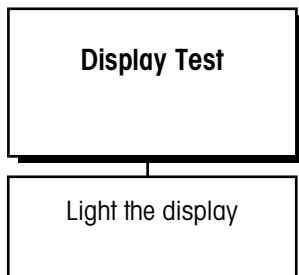

This sub-block tests the upper and lower display areas of the terminal and tests display ROM and RAM.

1. Press ENTER at the [**Display Test**] prompt to initiate the display test. The terminal automatically tests the display by lighting each segment. The terminal then displays the software revision and part number, tests display ROM and RAM, and flashes the results on the lower display.
2. When the test is finished, continue to the next sub-block or exit setup.

3. Keyboard Test Sub-block

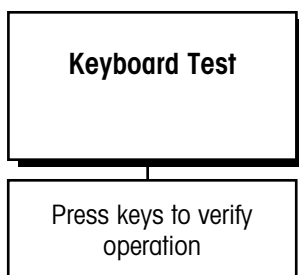

The keyboard test verifies the operation of each key on the JAGXTREME terminal keypad or an externally connected PS/2 keyboard.

1. Press ENTER at the [**Keyboard Test**] prompt to initiate the test. You can press ESC to exit the keyboard test.
2. Press each key on the JAGXTREME terminal keyboard or PC keyboard if attached. If the depressed key works, the key name is displayed. If the depressed key does not work, the terminal does not respond.
3. For example, to test the MEMORY key, press MEMORY on the keypad. If it works properly, the display reads [**Memory**]. If it is inoperative, the display remains blank.
4. Repeat step 2 to test as many keys as you like.
5. When finished, exit the keyboard test by pressing ESC.

4. Scale Test Sub-block

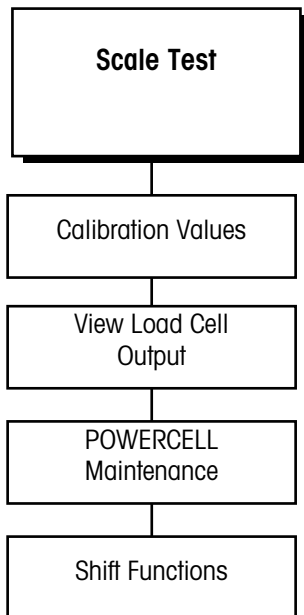

This sub-block holds several scale operation and calibration parameters that were used when you calibrated the scale through the Scale Interface program block. You can use this sub-block to:

- View and record calibration values.
- Reenter the values quickly when you replace the load cell, or if the load cell fails.
- Verify the IDENTCODE value and software version of a connected IDNET base.

If you need to re-enter calibration values due to a failure, this program block lets you get the scale back into operation. You may experience error in linearity or zero reference up to 2% until the scale is recalibrated.

If the scale type is POWERCELL (or RAAD box), the scale test sub-block lets you address each individual POWERCELL or RAAD box at the time of installation and configuration, or you can re-address POWERCELLs or RAAD boxes if necessary.

IDNET Scale Bases

If the terminal is connected to an IDNET base, you may confirm the IDENTICODE number and software version number:

- **IDENTCODE** - indicates the number of times the scale has been calibrated (only in approval mode).
- **S/W** - indicates the software version currently installed in the base.

Use the SELECT key to alternate between the above two choices. Press ESC to exit.

DigiTOL J-Box, POWERCELL Bases or RAAD Box

If the scale type is DigiTOL J-Box or POWERCELL (or RAAD Box), the scale test sub-block lets you reset the shift value.

1. Press ENTER at the [**Scale Test**] prompt.
2. Press ENTER at the [**Cal Values**] prompt, then view or enter new calibration values for the following:

ZeroCnts—View/enter the zero reference number at gross zero.

If linearity correction is disabled:

- **HighWt**—is the test weight used for calibration
- **HighCnts**—is the analog count at the high weight

If linearity correction is enabled:

- **MidWt**—is the test weight used for mid weight during calibration
- **MidCnts**—is the analog count at mid weight
- **HighWt**—is the test weight used for calibration
- **HighCnts**—is the analog count at the high weight
- **Cell 01-4**—View/enter a shift constant for load cells 1 through 4 for DigiTOL J-Box applications. For CMOS POWERCELL or RAAD box applications, the prompt may read Cells 1-24 for scale 1, 31-35 for scale 2, 61-89 for scale 3 or 91-124 for scale 4, depending on the number of scales and the number of cells in each scale.

3. Press ENTER at the [**View LC Output**] prompt to view the output count of the Analog PCB. For DigiTOL load cells connected to COM2 or COM4, the load cell output is the raw count from the load cell. For DigiTOL J-box, POWERCELL or RAAD box scales, you can view each load cell individually.
4. Press ENTER at the [**Cell Counts**] prompt to view the raw count data. The Cell Counts feature is useful for observing scale output for slow drift, shift adjustment, or for locating an unstable load cell.

Note: The **PwrCell Maint.** prompt appears only if POWERCELL is selected as the scale type. Choose POWERCELL if you will be using RAAD boxes.

The re-address feature lets you address CMOS POWERCELLs or RAAD boxes when you install a new scale.

5. Press ENTER at the **PwrCell Maint.** prompt, then select the maintenance procedure to perform. POWERCELL (or RAAD box) maintenance options include Re-Address Cell, Diagnose Cell, AutoAddress Cell, and Address All 240.

If Re-Address Cell is Selected

1. Press ENTER at the [**Re-Address Cell**] prompt. The terminal disconnects power to the POWERCELL or RAAD box and displays [**Power Now Off**].
2. With the power disconnected to the POWERCELL or RAAD box, connect the first cell to be addressed (cell 1 for a single scale configuration, cell 31 for a second scale, cell 61 for a third scale or cell 91 for a fourth scale). NOTE: No cells other than the POWERCELL or RAAD box to be addressed should be connected at this time.
3. Press ENTER at the [**Power Now Off**] prompt when the cell is connected.
4. At the [**What Addr? 0**] prompt, use the numeric keys to enter the first cell's address. Enter 1 for a single scale configuration or 31 for the first cell in a second scale. While the cell address is being changed, the display will show [**Addressing X**], where X is the cell address which has been entered. When the terminal has re-addressed the POWERCELL or RAAD box, it displays the message "Addressed OK." When you press ENTER, the terminal re-displays the message [**Power Now Off**].
5. At the [**Power Now Off**] prompt, disconnect the first cell, then connect the second cell to be addressed.
6. Repeat this procedure to address or re-address each POWERCELL or RAAD box. When all cells have been addressed and with the [**Power Now Off**] message displayed, reconnect all cells.

If Diagnose Cell is Selected

1. Press ENTER at the [**Diagnose Cell**] prompt. The JAGXTREME terminal disconnects power to the POWERCELL or RAAD box and displays the message [**Power Now Off**].
2. With the power disconnected to the POWERCELL or RAAD box, connect the first cell to be diagnosed (cell 1 for a single scale configuration or cell 31 for a second scale). No cells other than the POWERCELL or the RAAD box to be diagnosed should be connected at this time.
3. Press ENTER at the [**Power Now Off**] prompt when the cell is connected. The terminal will search for the cell and confirm its correct address with the message [**Address=address found**]. An error message appears if the cell address is not correct. The terminal displays cell counts on the upper display. When the cell is diagnosed, the terminal re-displays the message [**Power Now Off**].
4. At the [**Power Now Off**] prompt, disconnect the first cell then connect the second cell to be diagnosed.
5. Repeat for each POWERCELL or RAAD box. When all cells have been diagnosed and with the [**Power Now Off**] message displayed, reconnect all cells.

If AutoAddressing POWERCELLs (or RAAD Boxes) is Selected

The AutoAddressing Menu Selection helps you to address RAAD boxes or the POWERCELLs in a new POWERCELL scale or to replace a single POWERCELL in an existing POWERCELL scale. AutoAddressing searches POWERCELL or RAAD box addresses in the network, finds the first missing address in the addressing sequence, and readdresses a POWERCELL or RAAD box with address #240 to the missing address. You can have only one POWERCELL or RAAD box with address #240 on-line at a time. New POWERCELLs or RAAD boxes have address #240.

The beginning of the searching sequence for a POWERCELL scale or RAAD box is address #1 or #31, whichever is the starting address of the for RAAD boxes or the POWERCELLs in the scale. You select the starting address for the scale in the [**Scale Interface, Scale Type, Loc?**] menu selection.

Use the following procedure to address the RAAD boxes or the POWERCELLS in a new POWERCELL scale:

1. Press ENTER at the [**AutoAddress**] prompt. The terminal turns off the electrical power to the network and displays the message [**Power Now Off**].
2. Connect POWERCELL #1 (or RAAD box #1) to the network. It must have default address #240.
3. Press ENTER. The terminal displays the message [**Searching...**] while it is searching for the first missing cell. Once it finds #1 is the missing cell, the terminal displays [**Addressing 1**]. When it completes addressing the cell, the terminal displays [**Addressed OK**].
4. Press ENTER. The terminal turns off the network and displays [**Power Now Off.**]
5. Connect the next POWERCELL or RAAD box, #N, to the network. #N represents the sequence of cell addresses #2, #3, #4 up to all cells in the scale. #N must have default address #240.
6. Press ENTER. The terminal displays the message [**Searching...**] while it is searching for the first missing cell. Once it finds that #N is the missing cell, the terminal displays [**Addressing N**]. When it completes addressing the cell, the terminal displays [**Addressed OK**].
7. Repeat steps 5-7 until you have addressed all the POWERCELLS or RAAD boxes. If the terminal does not find any missing cells when it is doing the search in Step 7, the terminal displays [**N(o) Missing Cell!**].
8. Use the following procedure to replace a RAAD box or a POWERCELL in a POWERCELL scale:
 - Go to Diagnostics, Scale Test, PwrCell Maint, AutoAddress in the terminal setup menus.
 - Press ENTER. The JAGXTREME terminal turns off the electrical power to the POWERCELL network and displays the message [**Power Now Off**].
 - Replace the POWERCELL or RAAD box, #N, in the network. #N represents the cell to be replaced. It must have default address #240. Do not disconnect the other POWERCELLS or RAAD boxes.
 - Press ENTER. The JAGXTREME terminal displays the message [**Searching...**] while it is searching for the first missing cell. Once it finds that #N is the missing cell, the terminal displays [**Addressing N**]. When it completes addressing the cell, the terminal displays [**Addressed OK**].

Note: Do not disconnect POWERCELLS or RAAD boxes that you have already addressed.

Note: These shift adjust functions allow you quickly reset all the shift adjust parameters or to do a quick shift adjust approximation when a single bad cell is replaced. We recommend that you go through the full shift adjust procedure in the Scale Interface Setup section.

If Address All 240 is Selected

- When you press ENTER, the terminal displays [**Power Now Off**].
- Connect all POWERCELLS or RAAD boxes to the network that you want to re-address to 240.
- When you press ENTER, the terminal displays the message [**Addressing 240**]. It can take a few minutes to re-address all cells depending on the number of cells and their old addresses.
- When addressing is complete, the JAGXTREME terminal displays [**Addressed OK**].

If Shift Functions is Selected

- Press ENTER at the[**Shift Functions**] prompt to access the shift functions.
- At the [**Reset Shift**] prompt, press ENTER to reset the shift adjustment factors for a DigiTOL J-Box 1.0 or POWERCELL or RAAD box (resets all to 1.0.)

- At the [**Are You Sure?**] prompt, select **Y(es)** or **N(o)** to confirm or abort the reset operation.

If Adjust Cell/Pair is selected

- Press ENTER at the [**Adjust Cell/Pair**] prompt to begin the DigitOL J-Box/POWERCELL/RAAD box adjustment procedure.
- At the [**What Cell?**] prompt, enter the number of the cell or pair of cells to be adjusted.
- At the [**Empty the Scale**] prompt, remove any weight on the platform, then press ENTER. The display reads [**Capturing Zero**] as the terminal captures zero.
- At the [**Load On Cell N**] or [**Load On Pair N**] prompt, place on the platform a test weight equaling approximately 50% of the scale's capacity.

The terminal automatically shift adjusts the scale for the current load cell as the display reads [**Capturing Cell N**] or [**Capturing Pair N**]. The single-cell shift adjust procedure described here allows you to perform a quick approximation of the shift adjust value when a single, bad cell is being replaced on the scale. A complete shift adjust is more accurate and should be used if more than one POWERCELL or RAAD box is being replaced on the scale.

- Continue to the next sub-block or exit the setup mode.

5. Serial Test Sub-block

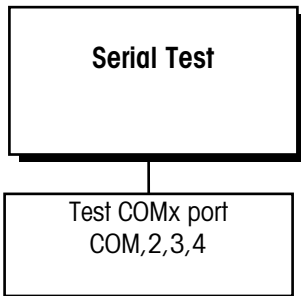

Note: After testing, remember to change the scale type back to DigiTOL and verify that calibration is correct by applying weight to the scale.

The Serial Test sub-block tests the serial I/O ports. You can transmit a test string of data to a designated port, or receive a string of input data. The input data scrolls across the lower display as received. You may see special characters representing control characters in the test string.

1. Press ENTER at the [**Serial Test**] prompt to test serial ports.
2. At the [**Test COM Port?**] prompt, press SELECT to choose the serial port you wish to test (COM1 or COM2).
3. You can test only COM ports that are physically available on your JAGXTREME terminal. You cannot test remotely located ports.
4. The lower display reads [**Testing COMx:**] until a serial input is received. When input is received, the characters are displayed in the lower display. The terminal is constantly outputting the string [**Testing COMx: NN**] where x is the COM port number and NN is a transmission number beginning at 00 and counting through 99.

The serial test cannot test COM2 if it is associated with a DigiTOL scale. Change the DigiTOL scale type to Analog or None through the Scale Interface program block before performing a serial test.

If a jumper wire is placed between the transmit and receive terminals on the serial port being tested, you can test both the input and output of a port and view the string of data being transmitted on the lower display.

The following diagram shows how to connect the output to the input for both serial ports and all types of communication.

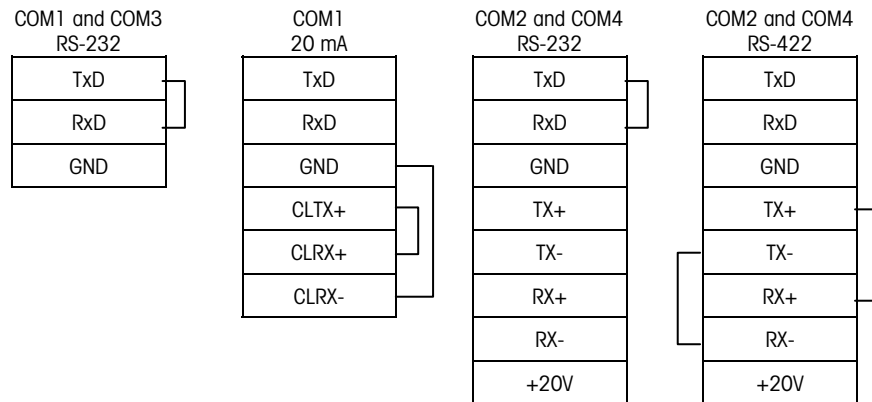

1. Press ESC to exit the serial test when you are finished.
2. Repeat steps 2 and 3 to test additional COM ports.
3. Continue to the next sub-block or exit the setup mode.

6. Parallel I/O Test Sub-block

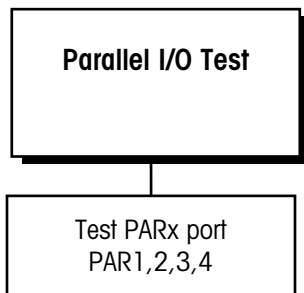

The Parallel I/O Test sub-block tests the discrete I/O ports. The test can “turn on” each output and monitors inputs. Refer to the appendix for more information.

1. When you enter the Parallel I/O test, the [**!WARNING!**] message is flashed on the display four times. The prompt [**Are You Sure?**] is displayed. Select **Y(es)** to continue or **N(o)** to exit the test.
2. At the [**Test Par Port**] prompt, select the desired port to test. The terminal only offers parallel ports that are physically available on your JAGXTREME terminal.

**WARNING!**

THIS TEST ALLOWS YOU TO TURN THE OUTPUTS ON AND OFF FROM THE TERMINAL KEYBOARD. IT IS UNRELATED TO THE WEIGHT. IF ELECTRICAL EQUIPMENT IS CONNECTED TO THE OUTPUT OF THE JAGXTREME TERMINAL DURING THIS TEST, IT MAY START AUTOMATICALLY. TAKE ALL APPROPRIATE PRECAUTIONS TO PREVENT PERSONAL INJURY DURING THIS TEST. METTLER TOLEDO SUGGESTS UNPLUGGING THE DISCRETE I/O CONNECTOR FROM THE TERMINAL AND USING LEDS OR A VOLT METER TO VERIFY CORRECT OPERATION OF THESE OUTPUTS.

Note: PN 082523020 LED/SWITCH simulator is available for testing PAR 1/PAR 2.

PAR 1 or PAR 3 (Discrete Input)

The display will read [PAR 1 = FFFF] or [PAR 3 = FFFFFFFF] indicating that the four or eight discrete inputs are all false or off. When one of the inputs is held to logic ground for 100 ms or longer, the F will change to a T to indicate a true or on condition. When done, press ESC to exit the test routine for the discrete inputs.

PAR 2 or PAR 4 (Discrete Output)

The display will read [PAR 2 = 0000] or [PAR 4 = 00000000] indicating that the 4 or 8 setpoint outputs are all logic 0 or "OFF". The first digit will blink, indicating that output 1 is the active output to be changed for test.

1. To turn this output on, press the "1" key. Pressing "0" returns the output to the off condition. To move to the next output (output 2), press SELECT. The second digit now blinks. Each setpoint output can be turned on or off.
2. Press ESC to exit the test routine for the discrete outputs.
3. Press ESC to exit the parallel I/O test and continue to the next sub-block, or exit the setup mode.

7. Network Test Sub-block

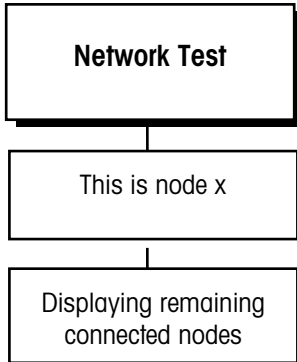

This sub-block tests the network connections. The test is done by first displaying the number of the local terminal, then requesting and receiving the node number and type of all other active nodes on the network.

1. Press ENTER at the [**Network Test**] prompt. The terminal automatically acquires the local network connection information. Connection information is displayed in the lower display area.
This is node x refers to the local terminal being tested.
2. Node x Connected where "x" is the address of the next terminal in the network. This process continues until all active nodes in the cluster have been identified, then the display sequence starts over again.
3. To end the test, press ESC. Continue to the next sub-block or exit the setup mode.

8. Ethernet Send BRAM Sub-block

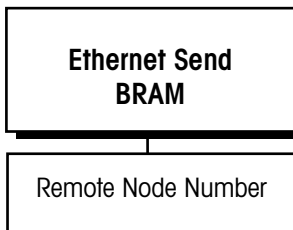

This sub-block allows you to send the Shared Data BRAM parameters from one terminal to another over the Ethernet LAN. You can setup the BRAM parameters on one terminal and duplicate them on another. Scale calibration parameters are NOT sent.

1. Press ENTER at the [**Ethernet Send BRAM**] prompt.
2. Select the appropriate node and press ENTER.

9. Zmodem Send BRAM Sub-Block

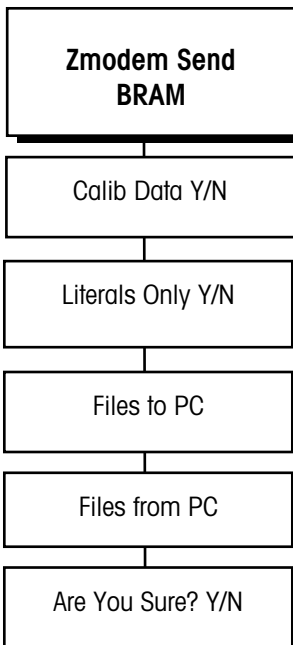

This sub-block allows you to upload or download the Shared Data BRAM parameters from one terminal to a PC via Zmodem communications from COM1. The data transferred can include or exclude calibration data. Literals only can be selected to have prompt loop, user variable, literal, and template data transferred only.

1. Press ENTER at the [**Zmodem Send BRAM**] prompt.
2. Select **Y(es)** at the [**Calib Data Y/N**] prompt to transfer scale calibration data.
3. Select **Y(es)** at the [**Literals Only Y/N**] prompt if you wish to transfer only the prompt loop, user variable, literal, and template data.
4. At the [**Files to PC?**] prompt, select **Y(es)** if you want to enable the transfer from the terminal to your PC, or select **N(o)** if you do not want the transfer in this direction.
If **Y(es)** is selected, at the [**Are You Sure?**] prompt, select **Y(es)** to enable the JAGXTREME terminal to transfer the selected data. If you select **N(o)**, the transfer will not occur and the [**Files from PC?**] prompt is displayed.
5. At the [**Files from PC?**] prompt, select **Y(es)** to enable the transfer from your PC to the terminal, or **N(o)** if you do not want the transfer in this direction. If **Y(es)** is selected, at the [**Are You Sure?**] prompt, select **Y(es)** to enable the transfer from your PC to the terminal. If **N(o)** is selected, the transfer will not occur.

NOTE: Zmodem of BRAM data requires a huge portion of available heap space. If there is not enough space to complete the transfer, an [**Out Of Memory**] message will be displayed. The terminal will go through a power reset operation. Once the power reset is complete, the Zmodem transfer will occur. If JAGBRAM.DAT file already exists, the transfer will abort with no error.

10. Print Setup Sub-block

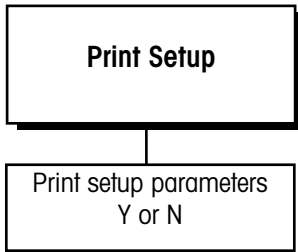

Note: If METTLER TOLEDO model 8857 is used at 9600 baud, connect both TXD and RXD lines. Configure the port for XON/XOFF operation.

The Print Setup sub-block prints the terminal setup information as it is defined in the program blocks. It may be useful to have a hard copy of each terminal's setup parameters as back-up. Print setup data will be sent out the port that has been selected for demand output. If a network port has been selected, the data is sent through it.

1. Press ENTER at the [**Print Setup**] prompt. Press ENTER again at the [**Print?**] prompt if you wish to print the setup parameters as defined in the program blocks for this terminal. If you do not want to print the setup, press ESC.

Setup data is printed in a 40-column format that is compatible with the METTLER TOLEDO 8857 Strip Printer. A standard 80-column printer will also work. Label printers are not acceptable devices for printing this information since there are many lines of data.

Press ENTER at the [**Reset to Factory**] prompt to continue or exit setup.

11. Reset to Factory Sub-block

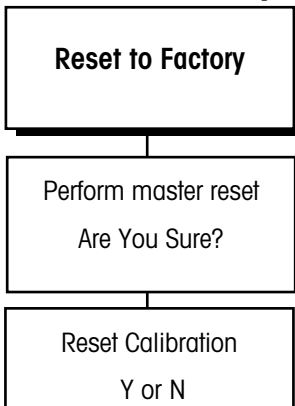

1. Note: Reset to Factory clears the RAM Disk! YOU WILL LOSE ALL JAGBASIC PROGRAMS AND DATA FILES.

The Reset to Factory sub-block in this program block differs from other blocks. Because this program block has no unique parameters to set, Reset to Factory performs a master reset which returns all of the parameters for all blocks to their original settings.

To perform a master reset:

1. Press ENTER at the [**Reset to Factory**] prompt.
2. Select **Y(es)** at the [**Are You Sure?**] prompt to confirm your intention to reset. Or, select **N(o)** to exit without resetting all parameters.

If **Y(es)**, at the [**Reset Calib?**] prompt select **N(o)** to reset all parameters except calibration or **Y(es)** to reset all parameters including the scale calibration parameters.

If you choose to reset the calibration values, the current scale capacity, increment size, and span and zero values will all be lost and scale recalibration will be required. The terminal displays [**Performing Reset**] and all parameters are returned to factory settings.

3. After resetting, the JAGXTREME terminal will perform its normal power-up sequence.

Configure Maintenance Program Block

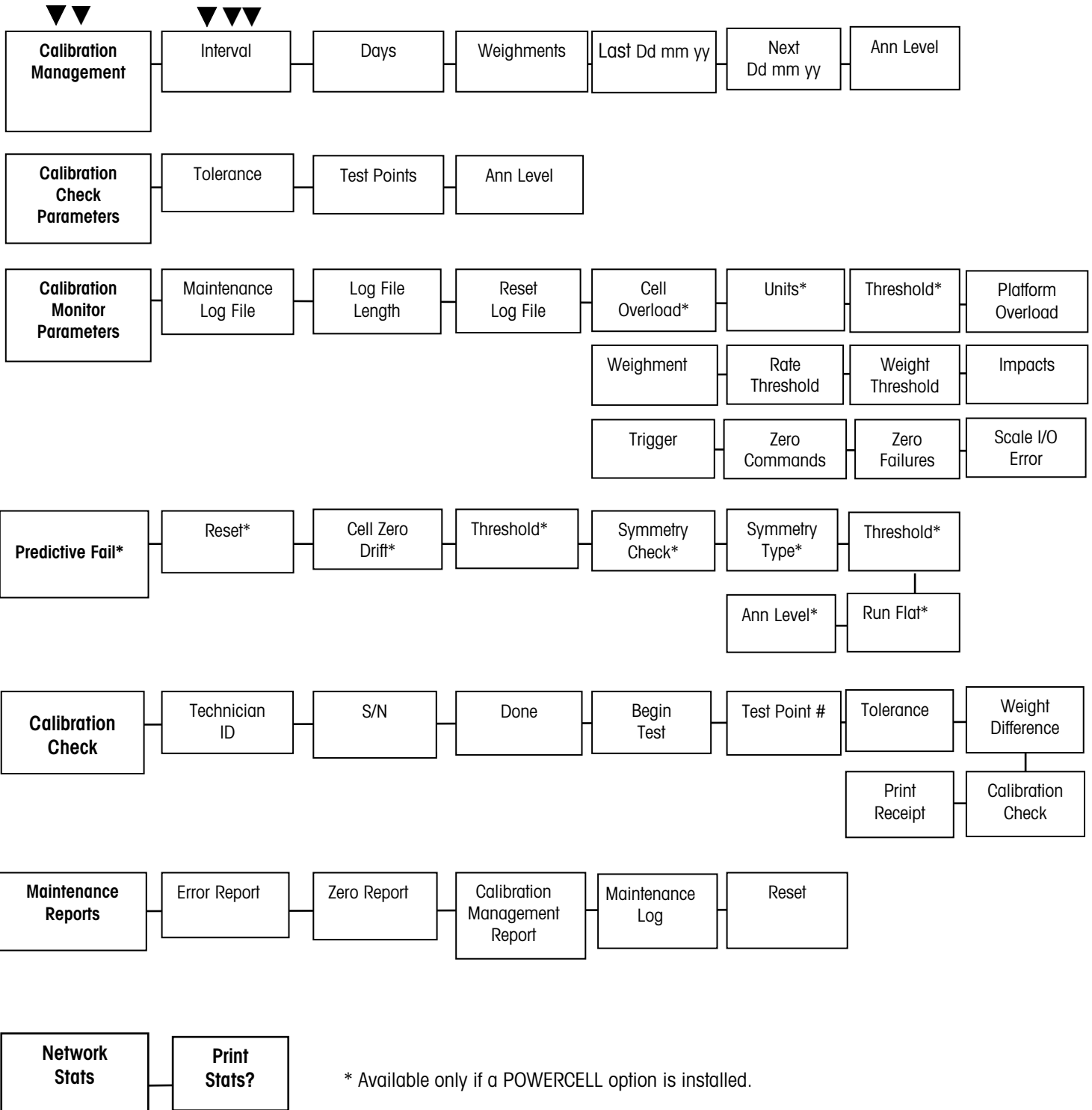

1. Calibration Management

Sub-block

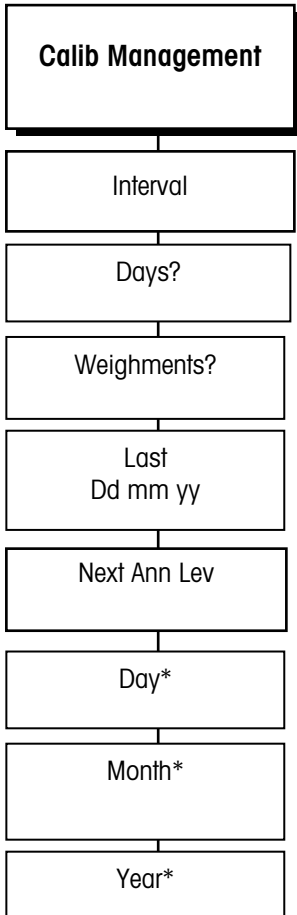

*Appear only if there is valid late date.

The Calibration Management sub-block section enables users to specify the calibration checking interval (by time or use) that the terminal will use to notify the user that the scale needs to be checked and verified with test weights. (A calibration test weight check is manually performed on the complete weighing system to determine accuracy). The terminal has incorporated the calibration test weight check into its operating system under the "Calibration Check" sub-block to assist the user through the calibration test. The parameters below specify the interval or when the test is to be performed.

1. Press **ENTER** at the [**Interval**] prompt to specify how often the scale will require calibration checking. The checking interval can be expressed in days of use, number of weighments, or both.
2. At [**Days?**] enter the number of days allowed between calibration checks (0-999).
3. At the [**Weighments?**] prompt, enter the number of weighments between calibration checks (0-99999).
4. The [**Last dd mm yyyy**] prompt shows the last date of the last calibration check. If the date comes up as dashes, then the next series of prompts will ask the user to enter the date of the last calibration check. (Day, Month, Year)
5. The [**Next dd mm yyyy**] prompt shows the date of the next calibration check (based on date of last calibration and number of days allowed between calibration).
6. At the [**Ann Lev?**] prompt, use the **SELECT** key to choose the action to be performed when the calibration interval has expired.
 - **Alarm** (alarm displayed on lower display)
 - **Log only** (alarm displayed on lower display and recorded in log file)
 - **Disable Scale** (alarm displayed on lower display and scale disabled)
 - **Email** (alarm displayed on lower display and Email sent)
7. Press **ENTER** to continue to the next sub-block or **ESC** to exit setup.

2. Calib Chk Parm's Sub-block

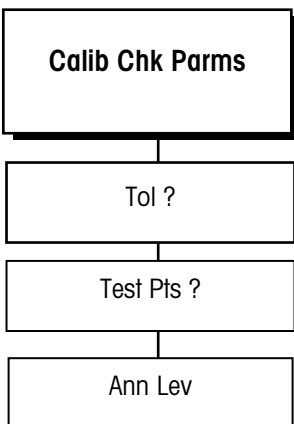

The Calibration Check Parameters sub-block enables you to specify the test parameters (default tolerance, number of test weight checks and alarm level) used in the calibration check procedure. The user will enter the number of test points and the starting value of the tolerance permitted between the test weight and the weight displayed on the scale.

1. Press **ENTER** at the [**Calib Chk Parm's**] prompt to configure this sub-block.
2. At the [**Tol ?**] prompt, enter the calibration check tolerance in weighing units.
3. At the [**Test Pts ?**] prompt, enter the number of test points to be used for the calibration check (0-99).
4. At the [**Ann Lev?**] prompt use the **SELECT** keys to choose the announcement level action to be performed when the calibration interval has expired.
 - **Alarm** (alarm displayed on lower display)
 - **Log only** (alarm displayed on lower display and recorded in log file)
 - **Disable Scale** (alarm displayed on lower display and scale disabled)
 - **Email** (alarm displayed on lower display and Email sent)
5. Press **ENTER** to continue to the next sub-block or **ESC** to exit setup.

3. Calib Mon Parms Sub-block

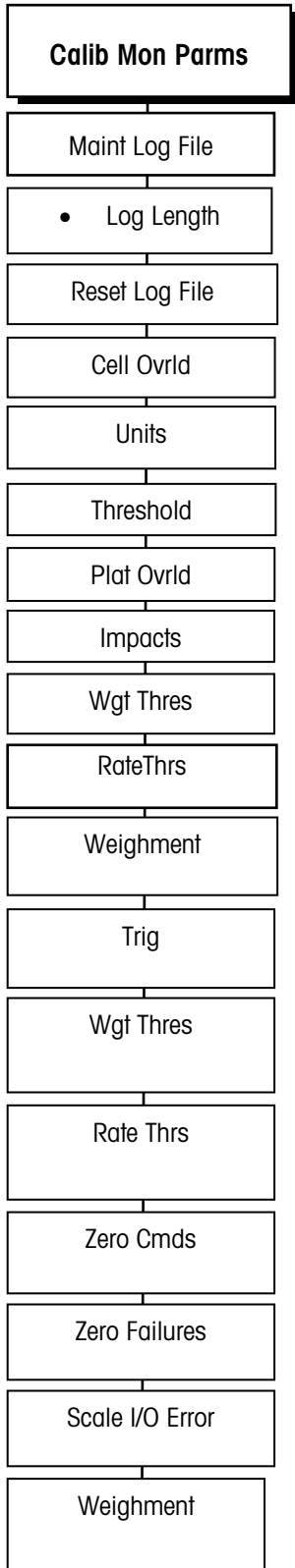

This sub-block enables the user to specify equipment condition monitoring activities (cell overload, weighing platform overload, weighing platform impacts, zero drift). To ensure maximum uptime, the terminal performs equipment condition monitoring during its normal operation based on comparisons made against installer-selected thresholds configured in this sub-block. If the terminal determines that the equipment is operating outside the selected thresholds, a record will be added to the maintenance log file

1. At the [**Calib Mon Parms**] prompt, press ENTER to set up the calibration monitoring parameters
2. At the [**Maint Log File?**] prompt, select **Y(es)** to enable Maintenance Log file usage or **N(o)** to disable logging and go to the Calibrate Check sub-block.
3. At the [**Log Length?**] prompt, enter the number of log files record to maintain. The file is a circular buffer. When the file is full, the oldest record will be written over by the next log entry. The file can be 1-9999 records in length.
4. At the [**Reset?**] prompt, select **Y(es)** to reset the log file and erase any old data. You will be asked to confirm your choice with an [**Are You Sure?**] prompt, or select **N(o)** to not reset the log file and continue.

Note: If a POWERCELL interface option is not installed, skip to the [**Plat OvrlD**] prompt.

5. At the [**Cell OvrlD?**] prompt, select **N(o)** to disable individual POWERCELL load cell overload monitoring and move to [**Plat OvrlD?**] (step 3.8). Or select:
 - **Cnt** to count individual cell overloads.
 - **Log** to log the file for each occurrence.
6. [**Units?**] prompt, enter how you want the load cell counts expressed. Choose:
 - load cell Counts weighing units
 - load cell Primary weighing units.
7. At the [**Threshold?**] prompt, enter the value of the threshold using the units selected in step 6. (0-999999)
8. At the [**Plat OvrlD?**] prompt, you can select:
 - **Cnt** to count scale platform overload conditions.
 - **Log** to count and log the file for each overload
9. At the [**Impacts?**] prompt, you can select:
 - **N(o)** to disable impact load monitoring and move to step 12.
 - **Cnt** to count impact loads.
 - **Log** to log and count impact loads.
10. At the [**WgtThres? Xxx**] prompt, enter the threshold weight in primary weight units.(0-999999)
11. At the [**RateThrs? Xxx**] prompt by entering a rate of change threshold value in primary weight units/second.(0-999999)
12. At the [**Weighment**] prompt, select:
 - **N(o)** to disable weighment monitoring and move to Zero Commands.
 - **Cnt** to count weighments.
 - **Log** to log and count weighments.
13. Press **ENTER**.

14. At [**Trig?**] prompt, you can choose:
 - **Print Cmd** to trigger the completion of a weighment when ever a PRINT is initiated
 - **UpSci WtG** to trigger the completion of a weighment when ever the gross scale weight goes above threshold
 - **UpSci WtN** to trigger the completion of a weighment when ever the net scale weight goes above threshold
 - **DwnSci WtG** to trigger the completion of a weighment when ever the gross scale goes above a threshold and below a reset threshold
 - **DwnSci WtN** to trigger the completion of a weighment when ever the net scale weight scale goes above a threshold and below a reset threshold
15. At the [**Wgt Thres? X.xxx**] prompt, enter the threshold weight that must be exceeded to set the trigger point defined in step 14.
16. At the [**Rset Thres? X.xxx**] prompt, enter the threshold weight the scale must return to set the trigger point defined in step 14.
17. At the [**Zero Cmds?**] prompt, you can select:
 - **Cnt** to count scale zero commands.
 - **Log** to log and count scale zero commands.
18. At the [**Zero Fail?**] prompt, you can choose:
 - **Cnt** to count scale zero command failures.
 - **Log** to log and count scale zero command failures.
19. At the [**Sci I/O Err?**] prompt, you can choose:
 - **Cnt** to count Scale I/O errors.
 - **Log** to count and log Scale I/O errors.

Predictive Failure (Only for RAAD Box and POWERCELL Platforms) Sub-block

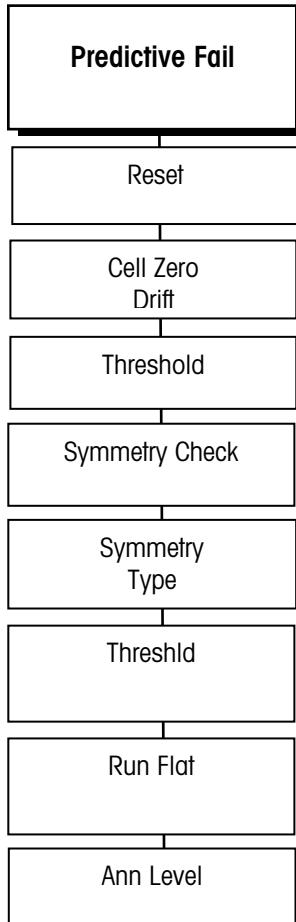

This sub-block enables the user to configure the predictive failure algorithms and “run flat” operation. This enables the terminal to monitor and predict the operating condition of each load cell in a POWERCELL or RAAD box weighing system by comparing current operating parameters against empirical data stored in the terminal at the time of calibration. It compares the current load cell readings to the readings established when the scale was calibrated. A shift in the load cell output may indicate either current or impending load cell failure. The JAGXTREME terminal has selectable levels of alerting the scale operator or scale technician when it detects a potential fault.

If the JAGXTREME terminal determines that a load cell is operating out of tolerance, it can invoke the “Run Flat” algorithm to compensate for it until a replacement is made. Successful operation of the run flat algorithm requires symmetry in the installation of the load cells (pair or radial arrangement). If you are unsure of your load cell arrangement, consult your METTLER TOLEDO representative. The JAGXTREME terminal will monitor the individual load cell ZERO DRIFT and SYMMETRY based on parameters set in this sub-block.

If a POWERCELL or RAAD box has individual load cells arranged in a logical symmetry, the JAGXTREME scale monitoring can periodically cross-check the fitness of the individual load cells. The JAGXTREME terminal determines the likely reading for an individual cell by using the readings from one or more cells that are symmetrical to it. If the readings do not match within a tolerance, a fault condition is likely.

Example of left-right symmetry: A railroad track scale or vehicle scale exemplifies left-right symmetry. The scale has two or more pairs of load cells. Since each cell of a pair usually sees the same loading pattern, the scale monitoring can cross-check individual readings from the pair.

Example of radial symmetry. Cylindrical tank or hopper scales often have identical net weight loading on all load cells, although they may have an off-center dead load due to the mounting of the discharge feeder machinery. This symmetry is especially true if liquid or powder materials are being weighted. The JAGXTREME terminal can cross check readings from all the individual cells.

Example of no symmetry. A floor scale or an overhead monorail scale provides an example of no symmetry. A load could be placed at any location and any single cell could see all, some or none of the load. The JAGXTREME scale monitoring cannot cross check readings from individuals cells in these scales.

1. At the [**Predictive Fail**] prompt, press ENTER to setup the Predictive Failure monitoring parameters
2. At the [**Reset?**] prompt, press **Y(es)** if you replaced the defective load cell and want to reset the predictive failure and run flat analysis. Press **N(o)** if you do not want to reset them.

If a scale periodically returns to zero, the JAGXTREME terminal automatically tests the individual load cell readings when the scale is at zero. If the current zero reading does not match the calibrated zero values within a tolerance, it is likely there is a fault condition. However, there are many scales that cannot be verified at zero. For example, a hopper scale may accumulate material on the hopper surfaces. In storage tanks, the scale may never be at zero.

3. At the **[Cell Zr Drf?]** prompt, the user may select:
 - **Cnt** to count individual load cell zero drifts.
 - **Log** to log and count individual load cell zero drifts
 - **No** to ignore individual load cell zero drifts.
4. If you selected **Cnt** or **Log**, the **[Threshold]** prompt will be displayed. At the **[Threshold]** prompt, enter the zero drift tolerance as a percentage of load cell span.
5. At the **[Symmetry Chk?]** prompt, the user may select:
 - **Cnt** to count individual load cell symmetry errors.
 - **Log** to log and count individual load cell symmetry error.
 - **No** to ignore individual load cell symmetry errors
6. At the **[Symmetry Typ?]** prompt, the user may select:
 - **Rad** for load cells arranged in a radial symmetry.
 - **Pair** for load cells arranged as pairs.
7. At the **[Start Threshld?]** prompt, the user enters the maximum acceptable deviation tolerance, in percent, that any individual load cell can be compared to the other load cells in the system.
8. At the **[Diff Thres%?]** prompt, enter the percentage of span in percent, the difference between symmetrical cells.
9. At the **[Run Flat?]** prompt, press **Y(es)** to enable the "Run Flat" algorithm; press **N(o)** to disable the "Run Flat" algorithm. If you selected **Y(es)**, the display will read **[Apply To Cel?]**. A value of 0 will let the JAGXTREME terminal decide which cell to replace. A value other than 1 will tell the JAGXTREME terminal to replace that cell with the estimate "run flat" value.
10. At the **[Ann Lev?]** prompt, use the SELECT key to choose the announcement level action to be performed when the predictive failure system detects an error.
 - **Alarm** (alarm displayed on lower display)
 - **Log** (alarm displayed on lower display and recorded in log file)
 - **Email** (alarm displayed on lower display and Email sent)
 - **Disable Scale** (alarm displayed on lower display and scale disabled)
 - **None**

Note: Run flat can only detect one bad load cell per logical scale.

Calibrate Check Sub-block

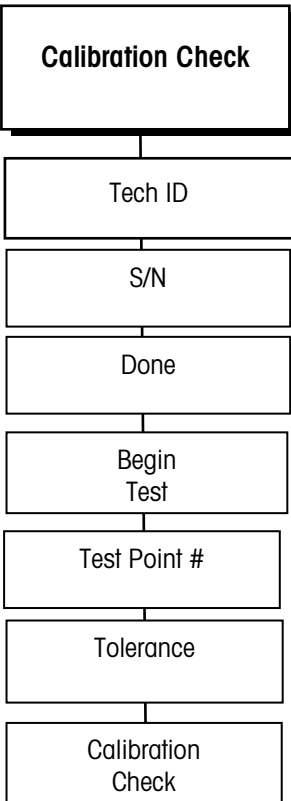

The Calibration Check sub-block section enables the user to perform the calibration test weight check with assistance from the JAGXTREME terminal. The terminal will instruct the user through the test based on parameters entered in the Calibration Check Parameters section.

At the [**Calibrate Check**] prompt, you can request that the JAGXTREME terminal check the calibration of its scale(s). Doing so here will reset the calibration management interval conditions

1. At the [**Tech ID?**] prompt, enter the Technician ID (1-6 characters).
2. At the [**S/N?**] prompt, enter the serial number for a test weight to be used (1-10 characters)
3. At the [**Done?**] prompt, select **Y(es)** to confirm that all test weight serial numbers entered, then proceed to step 5. Or, press **N(o)** to indicate there are more test weight serial numbers to enter. (The [**S/N?**] prompt will keep appearing until you have entered all test weight serial numbers and then pushed **Y(es)**). Repeat step 3 until you have entered all test weight serial numbers.
4. At the [**Begin Test?**] prompt select **Y(es)** to start the test.
5. At the prompt [**Tst Pt01? X.xxx**], enter the value of the 1st test weigh load. The test weight value will be displayed in order to perform a build-up test.
6. At the [**Tol?**] prompt, enter the tolerance.
7. At the prompt [**Wt01 Dif Y.yyy**]. The deviation between the entered weight and the scale reading is displayed and recorded

Note: These two steps are repeated until all test points are completed.

8. Upon completion, the display will show the [**Calib Chk**] prompt and then whether the calibration check passed or failed. Press ENTER
9. The display reads [**Print Receipt?**] You can select:
 - **Y(es)** to print receipt
 - **N(o)** to not print receipt

Maintenance Reports Sub-block

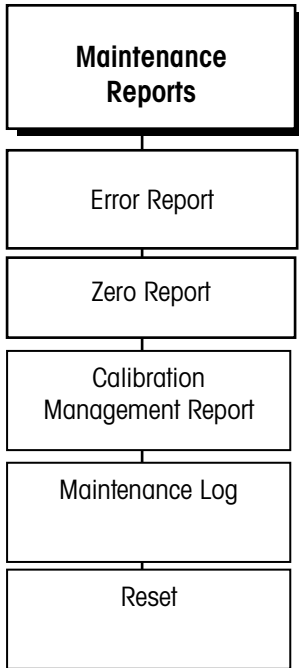

1. Press ENTER to configure this sub-block. The display reads [**Error Report?**] Select **Y(es)** to print the report or **N(o)** to not print it and move on to the next step.
2. The prompt reads [**Zero Report?**] Press **Y(es)** to print or **N(o)** to not print the calibration management report.
3. At the [**Cal Mng Report?**] prompt, press **Y(es)** to print or **N(o)** to not print the report.
4. At the [**Maint Log?**] prompt, press **Y(es)** to print or **N(o)** to not print the maintenance log report.
5. At the [**Reset?**] prompt, press **Y(es)** to reset the report log file and counters. You will be asked to confirm your choice at the [**Are You Sure?**] prompt. Press **N(o)** to not reset the report log and counters.

Network Stats Sub-block

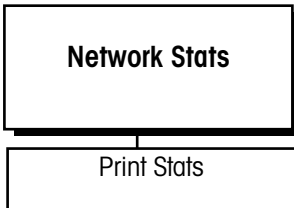

1. At the [**Network Stats**] prompt, press ENTER to configure this block.
2. At the [**Print Stats?**] prompt, press **Y(es)** to print the Network Statistics report or **N(o)** to not print the report. Press ENTER.

Reset to Factory

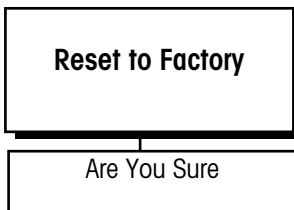

1. At the [**Reset to Factory**] prompt, select **Y(es)** to reset this block to factory default values.
2. You will be asked to confirm your choice at the [**Are You Sure?**] prompt. Select **N(o)** to not reset this block.

Note: **Reset to factory** is not the same as a **Master Reset**. Refer to Appendix 5 for master reset.

Options Program Block

JAGXTREME terminals with a PLC Interface Module installed have an additional program block for configuration. The terminal is available with an Allen-Bradley RIO, PROFIBUS, Modbus Plus or Dual Analog Output Module. Only one of these options may be installed. The program block will not appear if one of these options is not installed. The following diagram describes this program block:

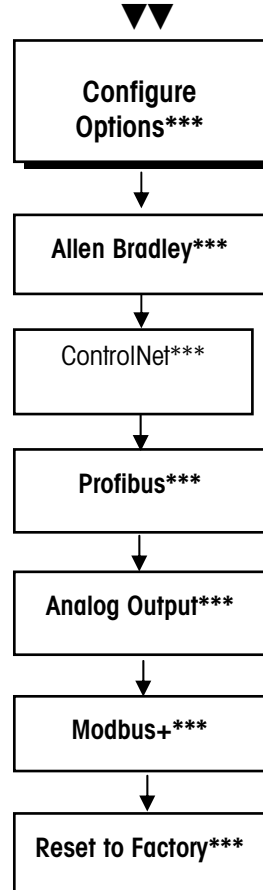

For specific details on these interfaces and how they may be configured, refer to the JAGXTREME Terminal PLC and Analog Output Interface Technical Manual.

*** These selections available with options installed.

4

Using the Web Server

System Requirements

The JAGXTREME terminal has an embedded web server, allowing you to program and calibrate a scale from anywhere within a facility – and from anywhere in the world – via the Internet. To use this feature, you must have the following:

- A connection to the terminal via modem or Ethernet with the appropriate communications protocols configured. (A crossover cable is required for a direct connection via Ethernet.)
- Internet Explorer 4.0 or higher revision.

In addition, you must:

- Disable or bypass the proxy server.
- Enable cookies and active scripting.
- Specify the address to bypass the proxy for the JAGXTREME terminal. If you are unsure about these settings consult with your network administrator.
- Type in the IP address in the URL window and push ENTER to connect to the JAGXTREME terminal. An example looks like this: <http://111.111.111.111>. Make sure the JAGXTREME terminal has a unique IP address.

You can test the communications by pinging the JAGXTREME terminal. From any Windows based PC:

- Go to Start, Programs, MS-DOS prompt
- Type ping xxx.xxx.xxx.xxx (where x's denote the IP address)
- The device should return four replies with no timeout.

If the ping times out, verify that the proper cable is being used by consulting the networking overview section of this manual.

You may find it helpful to review Chapter 3 of this manual to better understand the various program blocks and options for configuring the scale. More in-depth information on networking is provided in the appendix.

Setup

Note: The JAGXTREME web pages will not permit the user to enter setup when there is a JagBASIC program running.

On the JAGXTREME terminal, enter setup (press FUNCTION and SELECT) and go to the Configure Network program block. Press ENTER.

- Select **Web Server** and press ENTER.
- At the [**Enable Web Server**] prompt, select **Y(es)** and exit.
- Make sure the JAGXTREME terminal has a unique IP Address and the correct Subnet Mask.

Operating Modes

Run Mode is the standard operating mode. You cannot make changes to the JAGXTREME terminal's setup in this mode. To change modes, simply click on the mode wish to use. The active mode will appear at the top of the navigation bar. (See the illustration on the next page under Navigation Bar.)

Program Mode enables you to make changes to the JAGXTREME terminal's setup.

Navigation Bar Menu

When using the embedded web server, a series of web pages will guide you through the setup process. All JAGXTREME web pages include a navigation bar at the left side of the screen (see below). The information on the following pages describes the various icons that appear in the navigation bar. Clicking on them will lead you to the various screens that will guide you through the setup and configuration processes. Descriptions of each menu item can also be found by clicking on the **Help** icon.

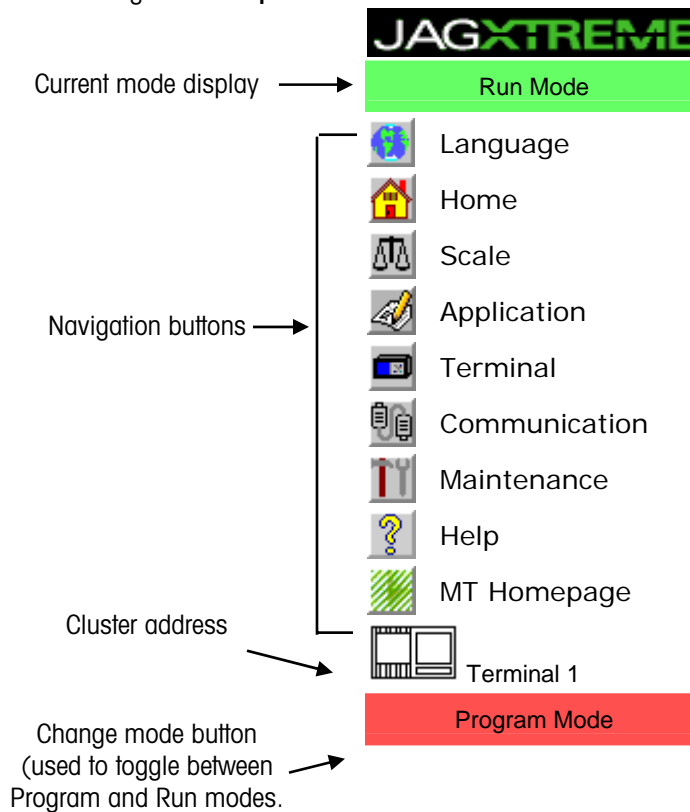

 **Language**

The JAGXTREME operating system is available in four configurations that define the language of the web pages. The country finish code at the end of the terminal part number identifies the language configuration. The configurations are:

- English/Spanish
- English/German
- English/French
- English/Chinese

After typing in the IP address, the JAGXTREME home page will open up in the browser. The default language is English. (See Figure 4-1). Pressing the **Language** button will bring the home page and all subsequent pages up in the alternate language. (Figure 4-2 shows the home page in Spanish).

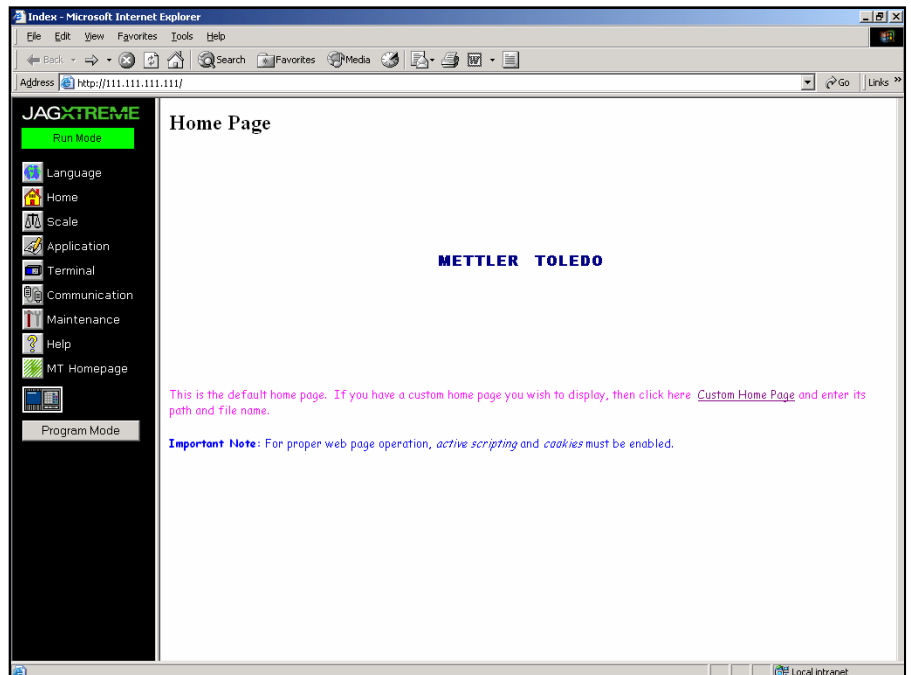



Home

This is the default home page that is displayed when you connect to the JAGXTREME terminal via an Internet browser. Clicking on the **Home** icon in the Navigation Bar at any time will take you back to this screen. The default home page can be changed by clicking on the **Custom Homepage** link. (See the screen shot that follows.)

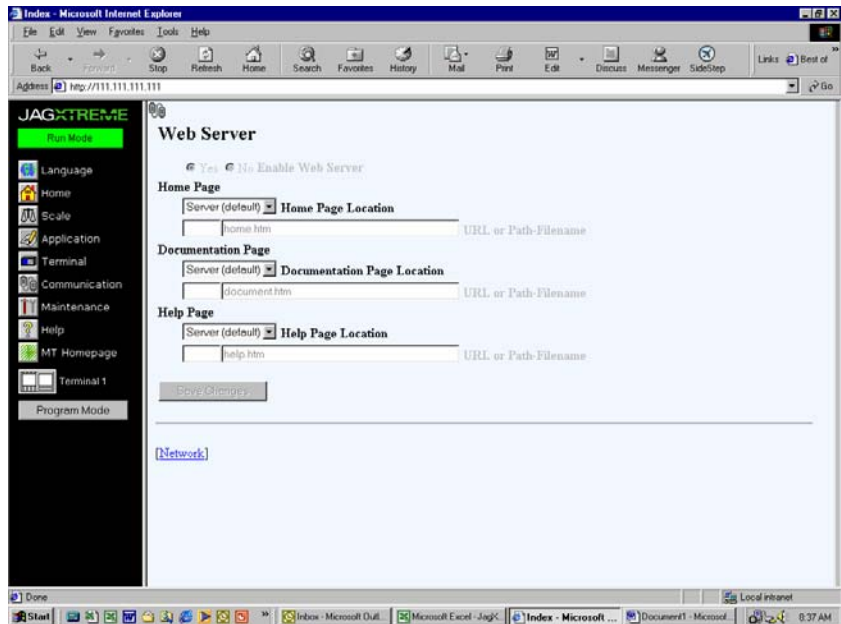
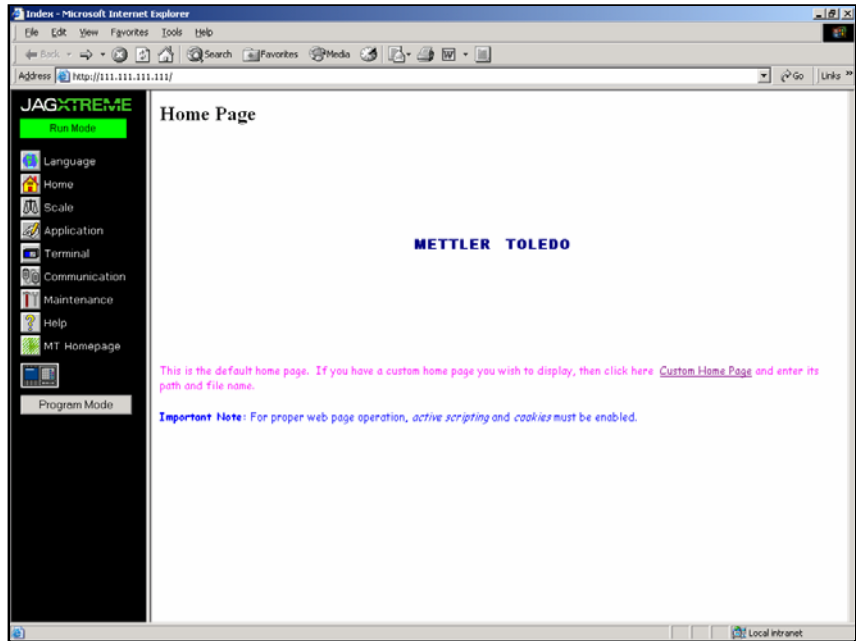



Note: Changing the home page only changes what is displayed on the right side of the screen. The Navigation Bar icons on the left side of the screen remain constant.

The user has the choice of pointing to a file on the browsing PC or to a URL, which can be located anywhere on the Internet. To change the pages, the terminal must be in Program Mode. Enter setup and type in the path to the file or URL. Click on **Save Changes**.

 Scale

Clicking on the **Scale** icon takes you to the scale setup screen. While in **Run Mode**, all information is read-only. While in **Program Mode**, Read-Write access is allowed. This section can be changed on the fly but will reset the terminal to initiate changes.



Clicking on the **Scale Setup** button takes you to the following screen. Click on **Save Changes** after setting up each step. A screen will appear that denotes the step has been completed.  Click on the Next arrow button to go to the next step. 

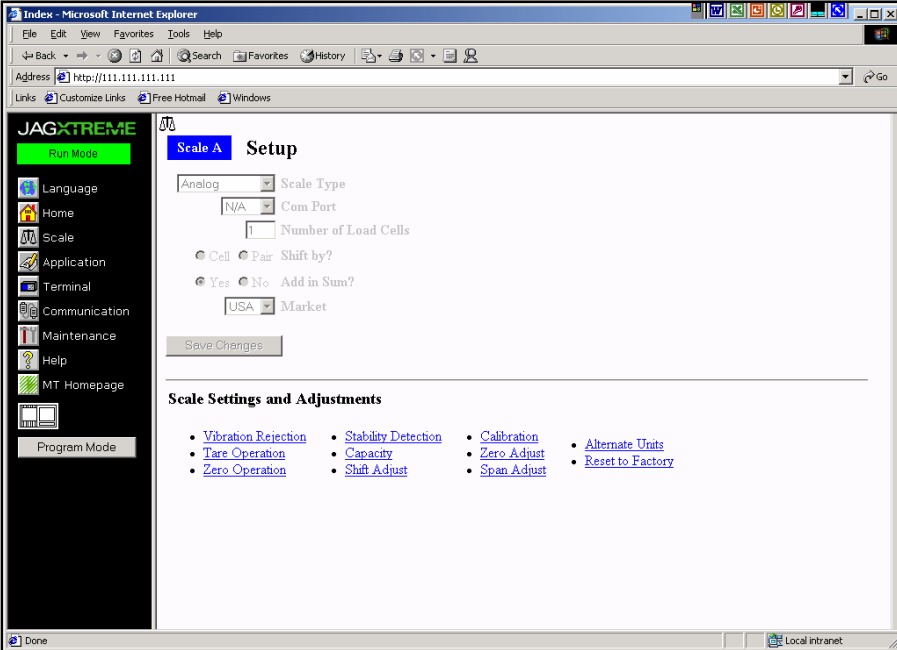



Application

Clicking on the **Application** icon leads you to the Application screen where you will find the Prompts, Discrete I/O, and JagBASIC menus. While in **Run Mode**, all information is read-only. While in **Program Mode**, Read-Write access is allowed. Remember to click on **Save Changes** after each step.

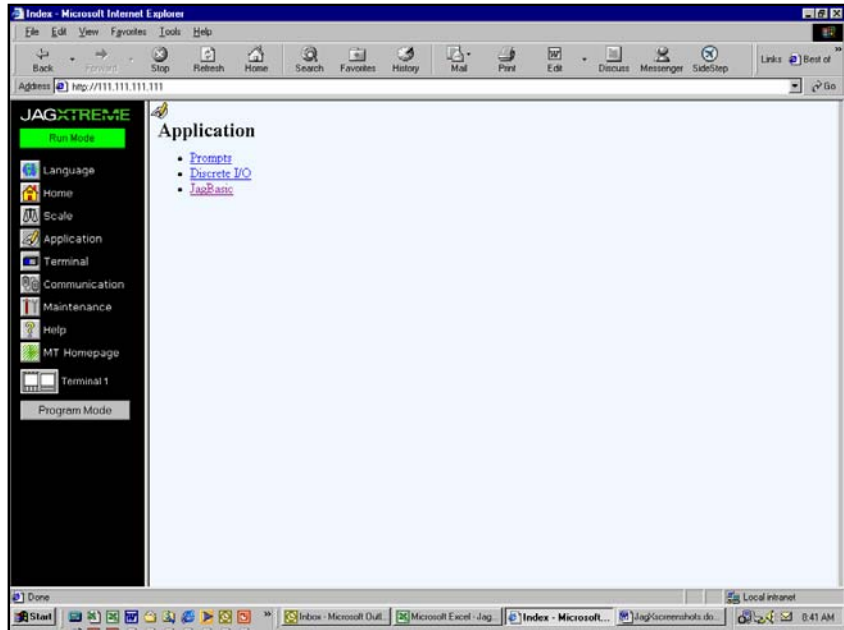

Terminal

Clicking on the **Terminal** icon takes you to the terminal setup screen. It contains sub-menus for Terminal Environment, Date and Time, Consecutive Number, and Literals. You can also switch to another terminal in the cluster.

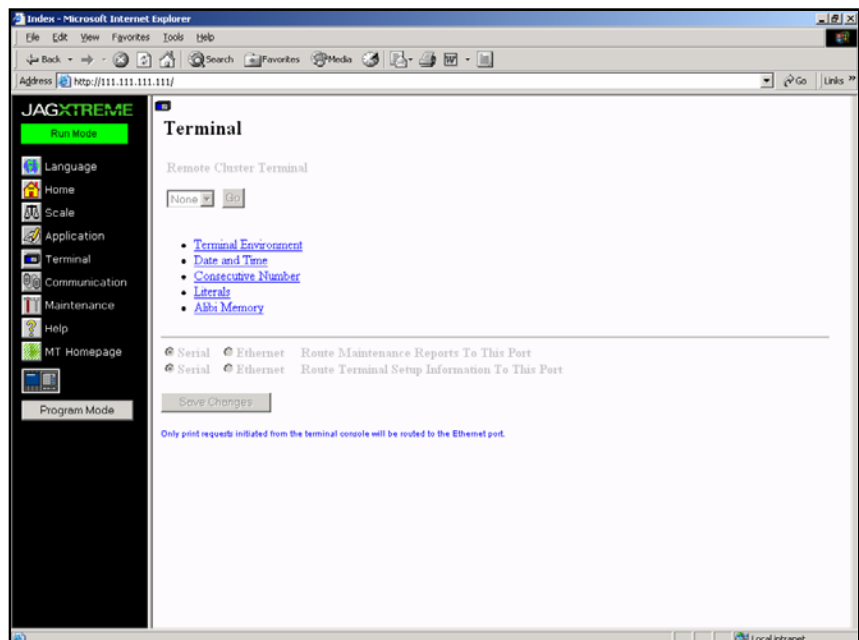

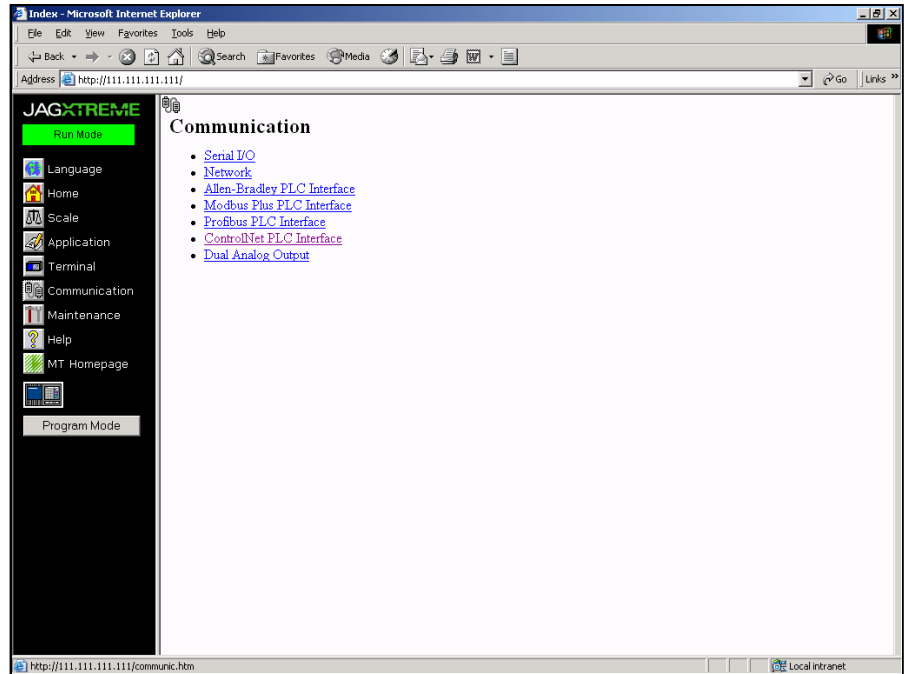
 **Communication**

Clicking on the **Communication** icon takes you to the communication setup screen. The sub-menus are:

- Serial I/O
- Network
- ControlNet
- Allen-Bradley PLC Interface
- Modbus PLC Interface
- Profibus PLC Interface
- Dual Analog Output

You can only configure these screens only if the appropriate interfaces are installed on the JAGXTREME terminal.

Maintenance

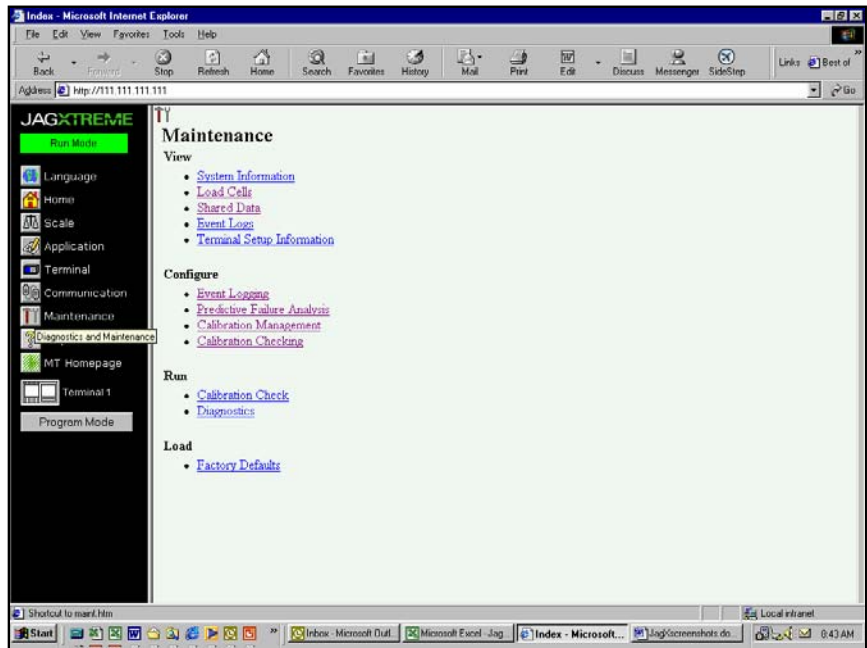

Clicking on the **Maintenance** icon leads to the maintenance section, which contains four main categories:

View

- System Information
- Load Cells
- Shared Data
- Event Log
- Terminal Setup Information

Configure

- Event Logging
- Predictive Failure Analysis
- Calibration Management
- Calibration Checking

Run

- Calibration Check
- Diagnostics

Load

- Factory Defaults

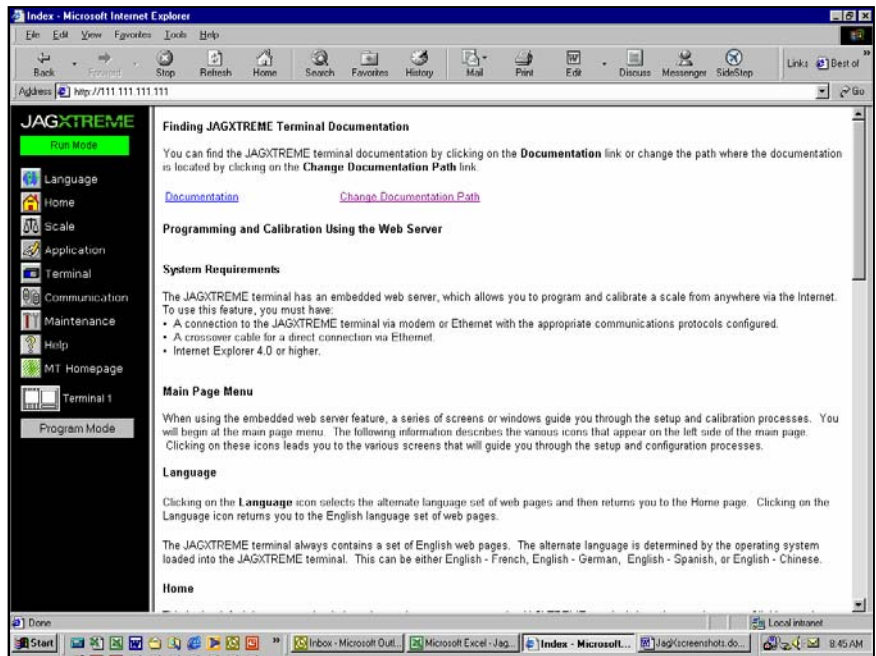

Clicking on the **Help** icon takes you the screen shown here. Instructions are provided for finding technical documentation or changing the document path. Clicking on **Documentation** takes you to the following screen.

Or, click on **Change Document Path** for instructions to change the document path. This is done by entering the local PC file path or Internet URL to the document. The link is saved to the JAGXTREME terminal. The JAGXTREME terminal's web server redirects the local computer's browser to the document. Typically, the configuration would point to the technical manual stored locally on the PC or on a CD. The terminal must be in the **Program Mode**.

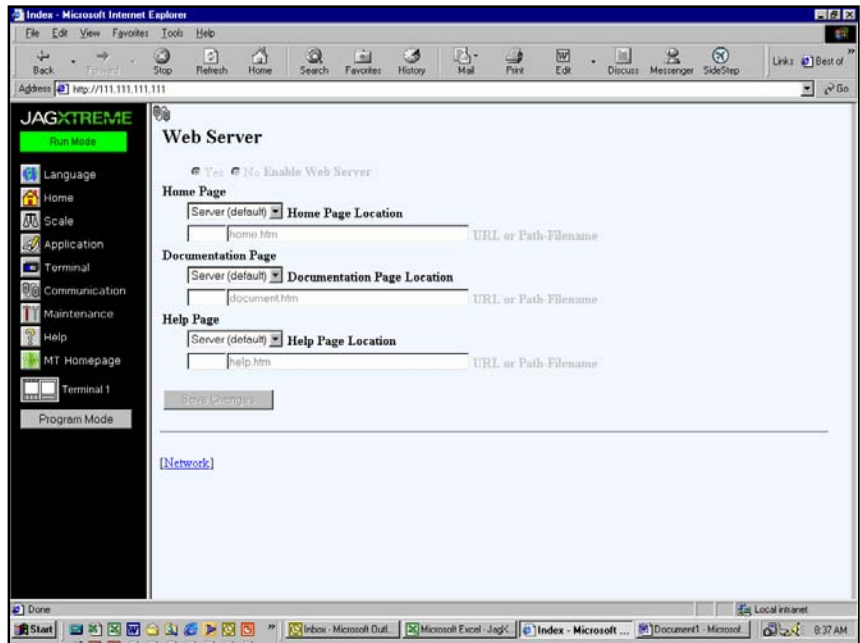

The Help screen also provides an overview of the system requirements and a brief description of each of the menu items found on the left side of the screen.



METTLER TOLEDO Home Page

If your PC is connected to the Internet, clicking on METTLER TOLEDO icon connects you the METTLER TOLEDO web site where you can find additional information on the company and its products.

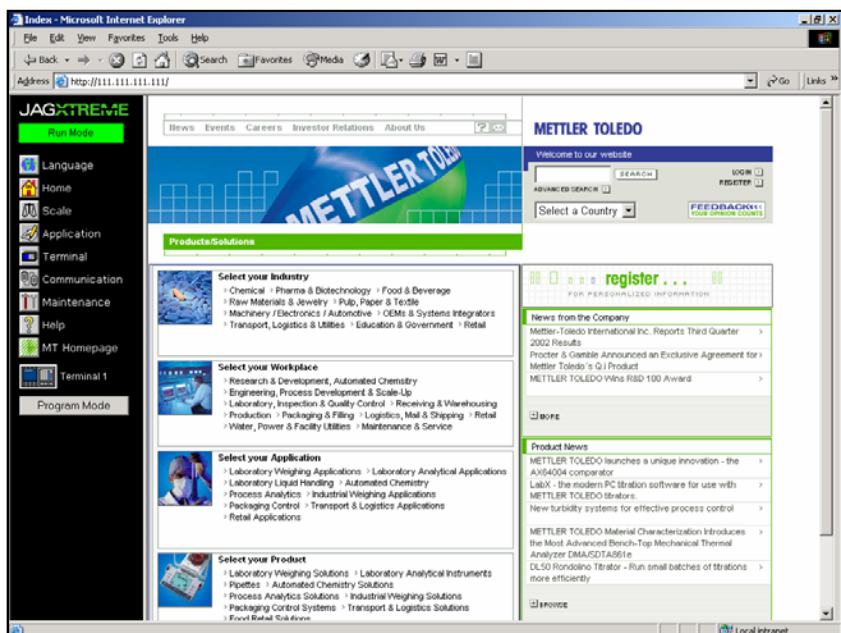



5

The Optional JagMAX Application Software

Application Setup

Note: JagMAX software is only available in North America.

Refer to the JAGXTREME Installation Guide for specific installation and wiring instructions related to use of the JagMAX software. An application guide is also included with the JagMAX software.

	 WARNING
	<p>ONLY PERMIT QUALIFIED PERSONNEL TO SERVICE THIS EQUIPMENT. EXERCISE CARE WHEN MAKING CHECKS, TESTS AND ADJUSTMENTS THAT MUST BE MADE WITH POWER ON. FAILING TO OBSERVE THESE PRECAUTIONS CAN RESULT IN BODILY HARM AND/OR PROPERTY DAMAGE.</p>

This section describes how to set up the application-specific parameters if you are using the optional JagMAX application software (available only in North America). During application setup, you can program what you want the terminal to do and allow or restrict operator access to functions.

Template

If the JagMAX software option is included with the JAGXTREME terminal, a template (legend) will be included for use with the software. It is placed above the function (F) keys on the keyboard attached to the terminal so the operator will know how to use the keys for various truck scale weighing operations. The template is also used for application set up.

APPLICATION SETUP	TRANS. REPORT	DR-PROCESS TRUCKS RPT	ACQNL. REPORT	MAINTENANCE MODE						NORMAL OPER.		METTLER TOLEDO
F1	F2	F3	F4	F5	F6	F7	F8	F9	F10	F11	F12	
				NORMAL OPERATION								<i>JagMAX</i>
WEIGH	RS-WEIGH	DOUBLE	TRIPLE	MOVING VEH	ID			SCROLL SCALES	RS-PRINT	SHARE SCREEN	VOID TRUCK	

Starting the Application

The following steps are needed to configure the JagMAX application software. Enter the JAGXTREME terminal setup and complete the following steps. Refer to Chapter 2 for more detailed information:

1. Calibrate scales A-C.
 - Configure the number of intervals = 1
 - Configure the increment sizes to match for each scale.
 - Enable unit switching between lb/kg if desired
 - Repeat the steps above for scales A-C.
2. Configure the sum scale.
 - Configure the number of intervals = 1
 - Configure the increment sizes to match for each scale.
 - Enable unit switching between lb/kg if desired.
3. Set time and date.
 - Time and date is accessed and set using the Memory key. Refer to Chapter 1, JAGXTREME keypad for more information.
4. Configure templates and COM ports (if printers, scoreboards or special templates will be used)
 - Configure the serial settings
 - Configure Custom Print Templates

5. Configure JagBASIC setup
 - Keyboard = Kboard
 - Display=Jaguar
 - Auto start = Y
 - Manual start = Y
6. Start JagBASIC
 - Select the Function Key
 - At the **[Run Program#?]** prompt, select 1.
 - The lower display will show **[Please Wait_]** for five minutes.
 - When the application is running, the display will show **[Select Function]**
7. Configure the application setup information using the directions that follow in the next section.

Entering Application Setup

The JagMAX template above the function keys will help you in using the program.

NOTE: The default is "no password". Just press ENTER. If you use a password, make sure you keep your password in a secure place. There is no "back door" access to passwords when using the JagMAX software.

To access the application setup mode when the JAGXTREME terminal is in normal operation (processing trucks):

- Press **(F11)** to enter Maintenance Mode. **[Maint. Functions]** will be displayed. The traffic light(s) will turn red.
- Press **(F1)** to enter Application Mode.

Once you are in Application Mode, the lower display on the terminal will read **[Applic. Setup]** for two seconds then move on to the **[Password:]** prompt.

At the **[Password:]** prompt, enter the setup password (which can have up to six characters).

- If the correct password is entered, the display will show **[NewPW: XXXXXXX]** with XXXXXX being the current password. Enter a new password if desired, or press **ENTER** to keep the existing password.
- If an incorrect password is entered, the **[Incorrect Passwd]** prompt will be displayed for two seconds, then the display will return to **[Maint. Functions]**.

Moving Through Application Setup

After setting the password, the display will read **[GENERAL]**, indicating that you are now at the first category of application setup. ***Please be sure to read the following information before proceeding.*** Application setup includes the following categories:

- GENERAL
- WEIGH MODE
- RE-WEIGH MODE
- DOUBLE MODE
- TRIPLE MODE
- MOVING VAN MODE
- ID MODE
- SEND SETUP FILE
- PRINT SETUP

Within each category, you will be asked to determine how you want the JAGXTREME terminal to function. All entries are made using a QWERTY keyboard attached to the terminal.

While a category name is displayed, the following keys may be used to move through the Application Setup:

- Press **ENTER** to access the current category.
- Press **(F9)** or the space bar to scroll through the setup categories.
- Press **(Esc)** to exit application setup and return to *Maintenance Functions*.
- Press **(F11)** to exit *Maintenance to Process Trucks*.

General Setup

To enter the General category: press **ENTER** at the **[GENERAL]** prompt. **[Thresh: XXXXXX]** will be displayed.

Enter a threshold weight value or press **ENTER** to keep the current value. The JagMAX application assumes that a truck is on the scale when the summed weight exceeds the threshold weight value, and is properly positioned on the scales when the weight on scale A exceeds this value. The maximum length of the weight value is six characters.

At the **[Alarm On: XXXXXX]** prompt, enter the Alarm On time or press **ENTER** to keep the current value.

- This value is the number of whole seconds that the Alarm On Output will stay on after a truck enters the scale (when the threshold value is exceeded). The maximum value is 60 (alarm output on for 60 seconds).
- Entering **(0)** will keep the output from turning on.

At the **[Site ID: XXXXXXXX]** prompt, enter eight alpha-numeric characters for a site ID or press **ENTER** to keep the current value. The site ID can be printed on tickets, and is included with records sent to a host PC.

[Text 1: XXXXXXXX] is displayed, where XXXXXXXX represents the first eight characters of the current Text 1 value. Enter up to 45 alpha-numeric characters for the first line of the address/header information that can be used on tickets or press **ENTER** to keep the existing Text 1.

[Text 2: XXXXXXXX] is displayed, where XXXXXXXX represents the first eight characters of the current Text 2 value. Enter up to 45 alpha-numeric characters for the second line of the address/header information that can be used on tickets or just press **ENTER** to keep the existing Text 2.

[Text 3: XXXXXXXX] is displayed, where XXXXXXXX represents the first eight characters of the current Text 3 value. Enter up to 45 alpha-numeric characters for the third line of address/header information that can be used on tickets or press **ENTER** to keep the existing Text 3.

At the **[Ticket: XXXXXXXX]** prompt, enter the ticket number (up to 6 digits) or press **ENTER** to keep the current ticket number. This ticket number will be assigned to the next ticket printed.

At the **[Aud Tr (A/S/N):X]** prompt, press **(F9)** or the space bar to toggle between **[A]** (Automatic), **[S]** (Semi-automatic), and **[N]** (None).

- Press **ENTER** to accept the current selection.
- Select **[A]** for Automatic audit trail printing for each transaction.
- Select **[S]** for Semi-automatic audit trail printing.
- Select **[N]** for No audit trail printing.

If **[N]** was selected for no audit trail printing, the program will skip the following prompt, going directly to the **[Report Port:X]** prompt.

At the **[Audit Tr Port: X]** prompt:

- Press **ENTER** to accept the current selection.
- Press **(F9)** or the space bar to scroll through the valid port numbers. Select the desired audit trail port number. The valid range is 1-2 if the multi-function card is not installed; 1-4 if the multi-function card is installed.

At the **[Report Port: X]** prompt:

- Press **ENTER** to accept the current selection.
- Press **(F9)** or the space bar to scroll through the valid port numbers. Select the port number to be used for reports. Valid numbers are 1-2 if no multi-function card is installed; 1-4 if a multi-function card is installed.

At the **[Save Trans: X]** prompt:

- Press **ENTER** to accept the current selection.
- Press **(F9)** or the space bar to toggle between **[Y]** and **[N]**.
- Select **[Y]** to save transaction data in the transaction file.
- Select **[N]** to disable transaction data being saved in the transaction file. If **[N]** is selected, tickets cannot be reprinted, transactions cannot be voided, and the transaction report cannot be printed or sent to the host.

At the **[Max Trans: XXX]** prompt, enter the maximum number of transactions to store or press **ENTER** to keep the current value.

This is the maximum number of records that will be stored in the data file. When the file is full, the system will begin overwriting records, starting with the oldest record. Valid values are 300 to 3000 records. Larger file sizes will cause the system to run slower.

- If this value is changed, the following prompt will appear: **[CLEAR RECORDS? X]**
- Press **ENTER** to accept the current selection. Press **(F9)** or the space bar to toggle between **[Y]** and **[N]**.
- Select **[N]** to keep the existing records. The maximum number of transactions **WILL NOT** be changed. **[SIZE NOT CHANGED]** will be displayed.
- Select **[Y]** to delete the existing records and change the maximum number of transactions. **[CHANGING SIZE]** will be displayed.

At the **[Max Inproc: XXX]** prompt, enter the maximum number of in-process records to store or press **ENTER** to keep the current value. This is the maximum number of in-process records (ID mode inbound weighments) that will be stored in the data file. When the file is full, the system will display an error and not allow any additional ID mode inbound weighments to be stored until some are removed by deleting them or completing the ID mode outbound weighments. Valid values are 300 to 1000 records. Larger file sizes will cause the system to run slower.

If this value is changed, the following prompt will appear: **[CLEAR RECORDS? X]**

- Press **ENTER** to accept the current selection.
- Press **(F9)** or the space bar to toggle between **[Y]** and **[N]**.
- Select **[N]** to keep the existing records. The maximum number of in-process records **WILL NOT** be changed. **[SIZE NOT CHANGED]** will be displayed.
- Select **[Y]** to delete the existing records and change the maximum number of in-process records. **[CHANGING SIZE]** will be displayed.

At the [**Host Port: X**] prompt:

- Press **ENTER** to accept the current selection.
- Press **(F9)** or the space bar to scroll through the valid port numbers and 0.
- Select the port number to be used for host communications. Valid ports are 1-2 if no multi-function card is installed; 1-4 if a multi-function card is installed.
- Select **(0)** to disable the host port function.

At the [**Scrbd Tk#Port: X**] prompt:

- Press **ENTER** to accept the current selection.
- Press **(F9)** or the space bar to scroll through the valid port numbers and 0.
- Select the port number to be used with a scoreboard to display the current ticket number. Valid ports are 1-2 if no multi-function card is installed; 1-4 if a multi-function card is installed.
- Select **[0]** to disable.

At the [**TrafficLights: X**] prompt:

- Press **F9** or the space bar to toggle between **[Y]** and **[N]**.
- Press **(ENTER)** to accept the current selection.
- Select **[Y]** if traffic light(s) will be used in this application. In this mode, tailgating is not permitted. The last weighed truck must completely exit the scale before the next truck pulls onto the scale.
- Select **[N]** if traffic lights will not be used in this application. This mode allows tailgating.

After entering the appropriate information at this prompt, the display will advance to the [**WEIGH MODE**] category display. Press **(ENTER)** to set up this category, **(F9)** to move to the next category, **(Esc)** to exit application setup and return to [**Maint. Functions**], or **(F11)** to go back to [**Process Trucks**].

Weigh Mode Setup

Weigh Mode is used for quick processing of standard semi trucks, printing axle and gross weights, and charging the Weigh Mode fee. At this stage of setup, you have the opportunity to setup the JAGXTREME terminal to automatically use this mode of operation or to allow the operator to use this mode of operation. You can also determine if the terminal should prompt for an ID or the entry of a comment.

Press **ENTER** at the [**WEIGH MODE**] display to access this category. At the [**Auto Weigh: X**] prompt:

- Press **ENTER** to accept current selection.
- Press **(F9)** or the space bar to toggle between **[Y]** and **[N]**.
- Select **[Y]** if automatic Weigh Mode is to be enabled. In Automatic Weigh Mode when a truck comes on to the scale, the terminal executes a Weigh Mode transaction. The F1 key does not have to be pressed to select Weigh Mode, and no other transaction modes may be used.
- Select **[N]** if automatic Weigh Mode is to be disabled

If **[Y]** is selected, the program will skip the following prompt, going directly to the [**Weigh ID:X**] prompt.

At the **[Weigh Mode: X]** prompt, press **(F9)** or the space bar to toggle between **[Y]** and **[N]**. Press **ENTER** to accept the current selection.

- Select **[Y]** if Weigh Mode is to be used. The program advances to the **[Weigh ID: X]** display.
- Select **[N]** if Weigh Mode is not allowed. If **[N]** is selected, the program will advance to the next category display, **[REWEIGH MODE]**.

At the **[Weigh ID: X]** prompt, press **(F9)** or the space bar to toggle between **[Y]** and **[N]**. Press **ENTER** to accept the current selection.

- Select **[Y]** if Weigh mode should prompt for ID.
- Select **[N]** to disable IDs in Weigh mode.

At the **[Weigh Comment: X]** prompt, press **(F9)** or the space bar to toggle between **[Y]** and **[N]**. Press **ENTER** to accept the current selection.

- Select **[Y]** if Weigh mode should prompt for comments.
- Select **[N]** to disable comments in Weigh Mode.

At the **[Wgh Fee: XXXX.XX]** prompt, enter the fee (in dollars and cents) to be charged for a Weigh Mode transaction. Press **ENTER** to accept the current value.

At the **[Weigh CustPrf: X]** prompt, press **(F9)** or the space bar to scroll through the valid custom print numbers 1-5. Press **ENTER** to accept the current selection. Select the custom print number to be used for a Weigh Mode ticket.

The program will advance to the **[REWEIGH MODE]** category display. Press **(ENTER)** to set up this category, **(F9)** to move to the next category, **(Esc)** to exit application setup and return to **[Maint. Functions]**, or **(F11)** to go back to **[Process Trucks]**.

Re-Weigh Mode Setup

Re-Weigh mode is used for quick re-processing of standard trucks, printing axle and gross weights, and charging the reduced Re-Weigh Mode fee. Press **ENTER** at the **[REWEIGH MODE]** display to access this category.

At the **[Re-Weigh Mode: X]** prompt, press **(F9)** or the space bar to toggle between **[Y]** and **[N]**. Press **ENTER** to accept the current selection.

- Select **[Y]** if Re-Weigh Mode is to be used. (This enables Re-Weigh, Double Re-Weigh, and Triple Re-Weigh modes.)
- Select **[N]** if Re-Weigh Mode is not allowed. The program will advance to the **[DOUBLE MODE]** category display.

At the **[RWgh Fee:XXXX.XX]** prompt, enter the fee to be charged for a Re-Weigh Mode transaction, or press **ENTER** to accept the current value. (This fee will be used for Re-Weigh, Double Re-Weigh, and Triple Re-Weigh.)

The program will advance to the **[DOUBLE MODE]** category display. Press **(ENTER)** to access this category, **(F9)** to move to the next category, **(Esc)** to exit application setup and return to **[Maint. Functions]**, or **(F11)** to go back to **[Process Trucks]**.

Double Mode Setup

Double Mode is used for processing or re-processing trucks with two trailers (maximum of nine axles), printing axle and gross weights, and charging either the Double Mode or Re-Weigh Mode fee. Press **ENTER** at **[DOUBLE MODE]** to access this category.

At the **[Double Mode: X]** prompt, press **(F9)** or the space bar to toggle between **[Y]** and **[N]**. Press **ENTER** to accept the current selection.

- Select **[Y]** if Double Mode is to be used.
- Select **[N]** if Double Mode is not allowed. The program will advance to the **[TRIPLE MODE]** category display.

At the **[Double ID: X]** prompt, press **(F9)** or the space bar to toggle between **[Y]** and **[N]**. Press **ENTER** to accept the current selection.

- Select **[Y]** if Double mode should prompt for ID.
- Select **[N]** to disable IDs in Double mode.

At the **[Double Comment:X]** prompt, press **(F9)** or the space bar to toggle between **[Y]** and **[N]**. Press **ENTER** to accept the current selection.

- Select **[Y]** if Double mode should prompt for comments.
- Select **[N]** to disable comments in Double Mode.

At the **[Dbf Fee: XXXX.XX]** prompt, enter the fee to be charged for a Double Mode transaction or press **ENTER** to accept the current value.

At the **[Dbf Cust Prt: X]** prompt, press **(F9)** or the space bar to scroll through the valid custom print numbers 1-5. Press **ENTER** to accept the current selection. Select the custom print number to be used for a Double Mode ticket. The program will advance to the **[TRIPLE MODE]** category display.

Press **(ENTER)** to setup this category, **(F9)** to move to the next category, **(Esc)** to exit setup and return to **[Maint. Functions]**, or **(F11)** to go back to **[Process Trucks]**.

Triple Mode Setup

Triple Mode is used for processing or re-processing trucks with three trailers (maximum of nine axles), printing axle and gross weights, and charging the Triple Mode or Re-Weigh Mode fee. Press **ENTER** at the **[TRIPLE MODE]** display to access this category.

At the **[Triple Mode: X]** prompt, press **(F9)** or the space bar to toggle between **[Y]** and **[N]**. Press **ENTER** to accept the current selection.

- Select **[Y]** if Triple Mode is to be used.
- Select **[N]** if Triple Mode is not allowed. The program will advance to the **[MOVING VAN MODE]** category display.

At the **[Triple ID: X]** prompt, press **(F9)** or the space bar to toggle between **[Y]** and **[N]**. Press **ENTER** to accept the current selection.

- Select **[Y]** if Triple mode should prompt for ID.
- Select **[N]** to disable IDs in Triple mode.

At the **[Triple Comment:X]** prompt, press **(F9)** or the space bar to toggle between **[Y]** and **[N]**. Press **ENTER** to accept the current selection.

- Select **[Y]** if Triple mode should prompt for comments.
- Select **[N]** to disable comments in Triple mode.

At the **[Trpl Fee:XXXX.XX]** prompt, enter the fee to be charged for a Triple Mode transaction or press **ENTER** to accept the current value.

At the **[Trpl Cust Prt: X]** prompt, press **(F9)** or the space bar to scroll through the valid custom print numbers 1-5. Press **ENTER** to accept the current selection. Select the custom print number to be used for a Triple Mode ticket. The display will advance to the **[MOVING VAN MODE]** category display.

Press **(ENTER)** to set up the category, **(F9)** to move to the next category, **(Esc)** to exit setup and return to **[Maint. Functions]**, or **(F11)** to go back to **[Process Trucks]**.

Moving Van Mode Setup

Moving Van Mode is used for processing moving van type trucks, printing axle and gross weights, and charging the Moving Van Mode fee. Press **ENTER** at the **[MOVING VAN MODE]** display to access this category.

At the **[Moving Mode: X]** prompt, press **(F9)** or the space bar to toggle between **[Y]** and **[N]**. Press **ENTER** to accept the current selection.

- Select **[Y]** if Moving Van Mode is to be used.
- Select **[N]** if Moving Van Mode is not allowed. The program will advance to the **[ID MODE]** category display.

At the **[Moving ID: X]** prompt, press **(F9)** or the space bar to toggle between **[Y]** and **[N]**. Press **ENTER** to accept the current selection.

- Select **[Y]** if Moving Van mode should prompt for ID.
- Select **[N]** to disable IDs in Moving Van mode.

At the **[Mov Comment: X]** prompt, press **(F9)** or the space bar to toggle between **[Y]** and **[N]**. Press **ENTER** to accept the current selection.

- Select **[Y]** if Moving Van mode should prompt for comments.
- Select **[N]** to disable comments in Moving Van mode.

At the **[Mov Fee: XXXX.XX]** prompt, enter the fee to be charged for a Moving Van Mode transaction. Press **ENTER** to keep the current value.

At the **[Mov Cust Prt: X]** prompt, press **(F9)** or the space bar to scroll through the valid custom print numbers 1-5. Press **ENTER** to accept the current selection. Select the custom print number to be used for a Moving Van Mode ticket. The program will advance to the **[ID MODE]** category display.

Press **(ENTER)** to set up this category, **(F9)** to move to the next category, **(Esc)** to exit setup and return to **[Maint. Functions]**, or **(F11)** to go back to **[Process Trucks]**.

ID Mode Setup

ID Mode is used for processing a truck, storing a weighment (a printout may not be required for the inbound or first weighment) and recalling that stored weight at the second weighment. A gross/tare/net weight ticket will then be printed and the ID Mode fee will be charged. The outbound axle weights may also be printed on the ticket. Press **ENTER** at the **[ID MODE]** display to access this category.

At **[ID Mode: X]**, press **(F9)** or the space bar to toggle between **[Y]** and **[N]**.

- Press **ENTER** to accept the current selection.

- Select **[Y]** if ID Mode is to be used.
- Select **[N]** if ID Mode is not allowed. The program will advance to the **[SEND SETUP FILE]** category display.

At **[Auto Assign ID:X]**, press **(F9)** or the space bar to toggle between **[Y]** and **[N]**.

- Press **ENTER** to accept the current selection.
- Select **[Y]** if ID's may be Auto Assigned. Auto Assigned ID's use the format XXXXAUTO, where XXXX is a four-digit counter (0001AUTO to 9999AUTO).
- Select **[N]** if only manual entry of ID's is allowed.

At **[ID In Print: X]**, press **(F9)** or the space bar to toggle between **[Y]** and **[N]**.

- Press **ENTER** to accept the current selection.
- Select **[Y]** if a ticket should be printed for an ID Mode inbound truck (first weighment in ID mode).
- Select **[N]** if no ticket is required for an ID Mode inbound truck. The next two prompts will be skipped. **[ID in Comment]** will be automatically set to No, and the program will advance to the **[ID Out Comment:X]** prompt.

At the **[ID In Comment: X]** prompt, press **(F9)** or the space bar to toggle between **[Y]** and **[N]**.

- Press **ENTER** to accept the current selection.
- Select **[Y]** if ID mode inbound should prompt for comments.
- Select **[N]** to disable comments in ID mode inbound.

At the **[ID In Fee: XXXX.XX]** prompt, enter the fee to be charged for an ID Mode transaction, or press **ENTER** to keep the current value. The fee is charged on the inbound (first) weighment.

At the **[ID In CustPrt: X]** prompt, press **(F9)** or the space bar to scroll through the valid custom print numbers 1-5.

- Press **ENTER** to accept the current selection.
- Select the custom print number to be used for an ID Mode inbound ticket.

At the **[ID Out Comment:X]** prompt, press **(F9)** or the space bar to toggle between **[Y]** and **[N]**.

- Press **ENTER** to accept the current selection.
- Select **[Y]** if ID Mode outbound should prompt for comments.
- Select **[N]** to disable comments in ID Mode outbound.

At the **[ID Out Fee: XXXX.XX]** prompt, enter the fee to be charged for an ID Mode transaction, or press **ENTER** to keep the current value. The fee is charged on the outbound (second) weighment.

At the **[ID Out CustPrt:X]** prompt, press **(F9)** or the space bar to scroll through the valid custom print numbers 1-5.

- Press **ENTER** to accept the current selection.
- Select the custom print number to be used for an ID Mode outbound ticket. The program will advance to the **[SEND SETUP FILE]** category display.

Press **(ENTER)** to access this category, **(F9)** to move to the next category, **(Esc)** to exit setup and return to **[Maint. Functions]**, or **(F11)** to go back to **[Process Trucks]**.

Send Setup File

This category allows the setup file to be sent to a PC. The setup file can be used to restore setup values or to duplicate setups on other JAGXTREME terminals. Press **ENTER** at the **[SEND SETUP FILE]** display to access this category.

At **[Send file? N]**, press **(F9)** or the space bar to toggle between **[Y]** and **[N]**.

- Press **ENTER** to accept the current selection.
- Select **[Y]** to initiate sending the setup file to a PC using Zmodem file transfer through serial port 1. **[Sending to PC]** followed by **[SETUP]** will be displayed on the lower display while the file is sent.

When complete, the program will advance to the **[PRINT SETUP]** category display.

- Select **[N]** to skip transmitting the setup file. The program advances to the **[PRINT SETUP]** category display.

Press **(ENTER)** to access this category, **(F9)** to move to the next category, **(Esc)** to exit setup and return to **[Maint. Functions]** or **(F11)** to go back to **[Process Trucks]**.

Print Setup

Note: If **[Load Paper+Enter]** is displayed, the printer is not accepting data from the terminal. Check the printer, load paper if needed, and press **(ENTER)**.

This category allows the Application Setup parameters to be printed through the Report Port. Press **ENTER** at the **[PRINT SETUP]** display to access this category.

At the **[Print File? N]** prompt, press **(F9)** or the **(Space Bar)** to toggle between **[N]** and **[Y]**. Press **(ENTER)** to accept the current selection.

- Select **[Y]** initiate printing. **[Printing...]** will be displayed while the Application Setup parameters are printed.
- Select **[N]** to skip printing the Application Setup parameters.
- Since this is the last category in Application Setup, the display will return to the **[GENERAL]** category display. Press **ENTER** to set up this category, **(F9)** to move to the next category, **(ESC)** to exit setup and return to **[Maint. Functions]**, or **(F11)** to go back to **[Process Trucks]**.
- End the JagMAX application.

Transaction Report

NOTE: The default is no password. Just press **ENTER**. If you use a password, make sure you keep your password in a secure place. There is no "back door" access to passwords in the terminal.

The Transaction Report section of Maintenance Mode allows the transaction report to be printed, the transaction file to be sent to a PC, and all transactions to be cleared. From the normal operating mode, press **(F11)** to enter Maintenance Mode. Then press **(F2)** to enter the Transaction Report section. **[Transaction Rpt]** will be displayed for 2 seconds.

At the **[Password:]** prompt, enter the report password (up to six characters). **[New PW: XXXXXX]** is displayed, where XXXXXX is the current password. Enter a new password if desired, or just press **ENTER** to keep the existing password.

If there are no records in the transaction file, **[NO TRANSACTIONS]** will be displayed for two seconds. Then the program will return to **[Maint. Functions]** prompt.

At the **[Print Trans?]** prompt, press **(F9)** or the space bar to toggle between **[Y]** and **[N]**. Press **ENTER** to accept the current selection.

- Select **[N]** to skip printing the transaction report and return to the **[Maint. Functions]** prompt.

Chapter 5: The Optional JagMAX Application Software Transaction Report

- Select **[Y]** to print the transaction report. **[Printing . . .]** is displayed while the transaction report is being printed. The report will print on the device attached to the report port (as defined in setup).

At the **[Send file?]** prompt, press **(F9)** or the space bar to toggle between **[Y]** and **[N]**. Press **ENTER** to accept the current selection.

- Select **[Y]** to initiate sending the transaction file to a PC using Zmodem file transfer through serial port 1. **[Sending to PC]** followed by **[TRANS]** will be displayed on the lower display while the file is sent.
- Select **[N]** to skip transmitting the transaction file.

At the **[Clear Trans?]** prompt, press **F9** or the spacebar to toggle between **[Y]** and **[N]**. Press **ENTER** to accept the current selection.

- Select **[N]** to keep the transaction data. The program will return to the **[Maint. Functions]** prompt.

- Select **[Y]** to clear the transaction data.

At the **[Are You Sure? N]** prompt, press **(F9)** or the spacebar to toggle between **[Y]** or **[No]**. Press **ENTER** to accept the current selection.

- Select **[N]** to keep the transaction data. The program will return to the **[Maint. Functions]** prompt.
- Select **[Y]** to clear all transaction data. **[Processing]** will be displayed while the system is deleting the transaction data. The program will return to the **[Maint. Functions]** prompt.

In-Process Report

NOTE: The default is no password. Just press **ENTER**. If you use a password, make sure you keep your password in a secure place. There is no “back door” access to passwords in the terminal.

The In-Process Trucks Report section of Maintenance Mode allows the in-process report to be printed, sent to a PC, and individual in-process records to be deleted. (The in-process file contains data for ID Mode inbound trucks which have not yet weighed out.) From normal operating mode, press **(F11)** to enter Maintenance Mode. Press **(F3)** to enter the In-Process Trucks Report section. **[In-Process Rpt]** will be displayed for 2 seconds.

At the **[Password:]** prompt, enter the report password (up to six characters). **[NewPW: XXXXXX]** is displayed, where XXXXXX is the current password. Enter a new password if desired, or just press **ENTER** to keep the existing password.

If there are no records in the in-process file, **[NONE IN-PROCESS]** will be displayed for two seconds. Then the program will return to the **[Maint. Functions]** prompt.

At the **[Print In-Proc? Y]** prompt, press **(F9)** or the space bar to toggle between **[Y]** and **[N]**. Press **ENTER** to accept the current selection.

- Select **[N]** to skip printing the in-process trucks report and return to the **[Maint. Functions]** prompt.

- Select **[Y]** to print the in-process trucks report.

[Printing . . .] will be displayed while the in-process report is printed. The report will print on the device attached to the report port (as defined in setup).

At the **[Send file? N]** prompt, press **(F9)** or the space bar to toggle between **[Y]** and **[N]**. Press **ENTER** to accept the current selection.

- Select **[Y]** to initiate sending the in-process file to a PC using Zmodem file transfer through serial port 1. **[Sending to PC]** followed by **[INPROC]** will be displayed on the lower display while the file is sent.
- Select **[N]** to skip transmitting the in-process file.

At the **[Delete Rec? N]** prompt, press **(F9)** or the space bar to toggle between **[Y]** and **[N]**. Press **ENTER** to accept the current selection.

- Select **[N]** to keep the in-process records. The program will return to the **[Maint. Functions]** prompt.
- Select **[Y]** to delete an in-process record.

At the **[ID / Ticket: Tkt]** prompt, press **(F9)** or the space bar to toggle between **[ID]** and **[Tkt]**.

- Select **[Tkt]** to identify the in-process record to delete by ticket number. **[Ticket:]** will be displayed. Type the ticket number of the in-process record to delete and press **ENTER**.
- Select **[ID]** to identify the in-process record to delete by ID. **[ID:]** will be displayed. Type the ID of the in-process record to delete and press **ENTER**.

If **no matching record** is found, **[NO MATCHES]** will be displayed for two seconds. The program will return to the **[Delete Rec? N]** prompt.

If **more than one matching record** is found, the date and time of the first matching record will be displayed. Press **(F9)** or the space bar to view the date and time of the next matching record. If another record is found, its date and time are displayed. If you have scrolled through all of the matching records **[REPEATING]** is displayed for two seconds. Then the date and time of the first matching record is displayed. When the date and time of the record that you want to delete is displayed, press **ENTER** to select it.

After selecting the record to delete by its date and time, or if there is **only one matching record**, **[Are You Sure? N]** will be displayed. Press **(F9)** or the space bar to toggle between **[Y]** and **[N]**. Press **ENTER** to accept the current selection.

- Select **[N]** to keep the selected in-process record. The program will return to the **[Delete Rec? N]** prompt.
- Select **[Y]** to delete the selected in-process record. **[RECORD DELETED]** will be displayed for two seconds.

If all in-process records have been deleted, **[NONE IN-PROCESS]** will be displayed for two seconds, then the program will return to the **[Maint. Functions]** prompt.

If there are still records in the in-process file, the program will return to the **[Delete Rec? N]** prompt.

Accumulation Report

NOTE: The default is no password. Just press **ENTER**. If you use a password, make sure you keep your password in a secure place. There is no "back door" access to passwords in the terminal.

The Accumulation Report section of Maintenance Mode allows the accumulation report to be printed, the accumulation file to be sent to a PC, and the accumulators to be cleared. From normal operating mode, press **(F11)** to enter Maintenance Mode. Press **(F4)** to enter the Accumulation Report section. **[Accumulation Rpt]** will be displayed for 2 seconds.

At the **[Password:]** prompt, enter the report password (up to six characters).

[NewPW: XXXXXX] is displayed, with XXXXXX as the current password. Enter a new password if desired, or press **ENTER** to keep the existing password.

At the **[Print Accum? Y]** prompt, press **(F9)** or the space bar to toggle between **[Y]** and **[N]**. Press **ENTER** to accept the current selection.

- Select **[N]** to skip printing the accumulation report. The program will return to the **[Maint. Functions]** prompt.
- Select **[Y]** to print the accumulation report. **[Printing . . .]** will be displayed while the accumulation report is printed. The report will print on the device attached to the report port (as defined in setup).

At the **[Send file? N]** prompt, press **F9** or the space bar to toggle between **[Y]** and **[N]**. Press **ENTER** to accept the current selection.

- Select **[Y]** to initiate sending the accumulation file to a PC using Zmodem file transfer through serial port 1. **[Sending to PC]** followed by **[ACCUM]** will be displayed on the lower display while the file is sent.
- Select **[N]** to skip transmitting the accumulation file.

At the **[Clear Accum? N]** prompt, press **(F9)** or the space bar to toggle between **[Y]** and **[N]**. Press **ENTER** to accept the current selection.

- Select **[N]** to keep the accumulation data. The program will return to the **[Maint. Functions]** prompt.
- Select **[Y]** to clear the accumulation data.

At the **[Are You Sure? N]** prompt, press **(F9)** or the space bar to toggle between **[Y]** and **[N]**. Press **ENTER** to accept the current selection.

- Select **[N]** to keep the accumulation data and return to the **[Maint. Functions]** prompt.
- Select **[Y]** to clear the accumulation data. **[Processing]** will be displayed while the system is clearing the accumulators. The program will return to the **[Maint. Functions]** prompt.

End Program

NOTE: The default is no password. Just press **ENTER**. If you use a password, make sure you keep your password in a secure place. There is no "back door" access to passwords in the terminal.

The End Program feature in Maintenance Mode allows you to end the JagMAX program and to use the JAGXTREME terminal keypad to enter setup and perform operations such as scale calibration.

From the normal operating mode, press **(F11)** to enter Maintenance Mode. Press **(F5)** to enter the End Program feature.

[End Program] will be displayed for two seconds.

At the **[Password:]** prompt, enter the end program password (up to six characters).

[New PW: XXXXXX] is displayed with the XXXXXX as the current password. Enter a new password if desired, or press **ENTER** to keep the existing password. The program will terminate.

Printing

The display will read **[LOAD PAPER+ENTER]** while printing an Audit Trail record or the Transaction, In-Process, or Accumulation reports if the printer being used is unable to receive the data as it is sent by the JAGXTREME terminal. Most likely, the printer is out of paper. Check the printer, load paper if necessary, and press **ENTER** to continue printing. 300 Baud should not be used for print operations.



For your notes

6



Installing and Using JAGXFILES

The documentation CD-ROM included with the JAGXTREME terminal includes JAGXFILES. JAGXFILES is a utility that simulates the embedded web server in the JAGXTREME terminal, allowing you to create and save individual JAGXTREME configuration files and then download them into another JAGXTREME terminal or terminals via the web server. With JAGXFILES, you can also copy a configuration file from a JAGXTREME terminal, save it to your PC in a backup file and then download it back to that terminal if the original configuration file is lost.

Hardware and Software Requirements

NOTE: JAGXFILES version 1.0 works with JAGXTREME versions 0.1 – 0.3. JAGXFILES version 1.2 works with JAGXTREME version A.

A PC with:

- Windows 95/98/NT/2000 Operating System
- Internet Explorer 4.0 or higher
- Ethernet card
- Ethernet cable for the JAGXTREME terminal

Installing JAGXFILES

After inserting the documentation/utilities CD-ROM into your computer, open the JAGXFILES folder and double-click on **Setup.exe**. Screen instructions will appear that guide you through the process of installing the JAGXFILES utility on your hard drive.

Browser and JAGXTREME Setup

Refer to the networking section of the JAGXTREME terminal technical manual for setup information. Once the web server is accessed, JAGXFILES can communicate to a JAGXTREME terminal. Note: Internet Explorer must be configured to bypass a proxy server for the IP address of the local computer in order for JAGXFILES to work.

JAGXFILES provides a web server as part of its operation. If your PC is already running a web server, it must be stopped before starting JAGXFILES.

Starting JAGXFILES

To start JAGXFILES:

- Point your cursor to and then click on **Start, Programs, Mettler Toledo**. You will have the option of opening **JAGXFILES** or the *Getting Started Guide*. It is recommended that you read the *Getting Started Guide* before opening JAGXFILES.
- After reviewing the guide, go back to **Start, Programs, Mettler Toledo**.
- Choose **JAGXFILES**. Two screens will appear. The second screen, **JAGXFILES Startup**, should contain the Ethernet IP address of the computer on which you are working. If not, type in the IP address.
- If you are not sure about your IP address, right click on the JAGXFILES icon in the system tray (lower right hand corner of your computer screen).
- Select **IP Address Help**. This will display your computer's IP address. Go back and insert this address on the startup screen.
- Click on **Startup**. JAGXFILES should immediately launch your browser and the JAGXFILES home page (which is the same as the JAGXTREME embedded web server home page), should appear.

Configuring JAGXFILES on Your PC

If JAGXFILES does not automatically launch Internet Explorer, the following steps will allow you to manually configure JAGXFILES on your PC.

- Open **JAGXFILES** from the program group.
- Right-click on the **JAGXFILES** icon in the system tray.
- Select **IP Address Help** and note your computer's IP address or name.
- Right-click on the **Internet Explorer icon** and select **Properties**.
- Go to the **Connections** tab and select the type of connection used to interface the JAGXTREME terminal (LAN). Make sure that the proxy server is either not used or set it so you bypass it for your computer's IP address. To bypass the proxy, go to the **Advanced** field under **Proxy Server** and type in the IP address under **Exceptions**.
- Open **Internet Explorer** and type in your computer's IP address in the URL window and press **Enter**. JAGXFILES should appear in your browser's window.

Creating a Configuration File

JAGXFILES can be used to create a configuration file that can be downloaded into a JAGXTREME terminal locally or at a remote location by emailing the file and then downloading it to a terminal at that location. It can also be used to save a configuration file from a JAGXTREME terminal in a backup file that can be reloaded if the original file is lost or corrupted.

Configuring Option Boards

If you wish to create a new configuration file for a JAGXTREME terminal, you must configure any option boards to be installed in the target JAGXTREME terminal prior to setting up the configuration file. To configure the boards that will be installed:

- First, click on the **File** icon and then click on **Save the currently open backup file to disk with a new file name**. Type in the name of the new file you will be rating then click **Save**.
- The filename you created will appear at the bottom of the navigation bar on the left side of the screen and will have a **.dmt** extension.
- Click on the **Maintenance** icon.  Click on the **System Information** link.
- Click on the **Change** button. Select the board type for slots 1,2, and 3 (if applicable) and then click on the **Save Changes** button. The changes you input will be made to the file you have open.

You can now go back through the other icons on the navigation bar to configure the scale terminal parameters that apply to your system. The screens are self-explanatory and should provide you with all the information needed to configure a file. Once you have completed the configuration, the new configuration will be saved to the file you have open. (The following pages contain more detailed information on creating, storing, and sending configuration files.)

Menu Items

The navigation bar menu icons that appear when using JAGXFILES are the same as those on the JAGXTREME terminal's embedded web server with the exception of the product name (JAGXFILES instead of JAGXTREME), a designation for the open file (in place of the **Program** or **Run** mode buttons), and the **File** icon. Note: Some of the features that are available via the embedded web server may not be configurable using JAGXFILES.

	JAGXFILES	JAGXTREME
	Language	Language
	Home	Home
	Scale	Scale
	Application	Application
	Terminal	Terminal
	Communication	Communication
	Maintenance	Maintenance
	Help	Help
	MT Homepage	MT Homepage
Create, save, transfer or backup configuration files →		
	Default.dmt	
Name of open file →		
		Run Mode

File

Clicking on the **File** icon takes you to the screen that allows you to:

- Open** an existing backup file for local browsing/editing on your PC.
- Save** the currently open backup file with a new file name.
- Restore** a backup file to a connected JAGXTREME terminal.
- Backup** the setup data from a connected JAGXTREME terminal to a file.

Instructions for each function follow.

Open

Clicking on **Open an existing backup file for local browsing/editing on your PC** allows you to open an existing configuration file or the default configuration file (default.dmt) that can then be edited on your PC.

To create a new custom configuration, open the default.dmt (the name of the open file will appear on the left side of the screen), make the desired changes, and then save the file as a different file name. The file can then be downloaded to a JAGXTREME terminal or saved for future use.

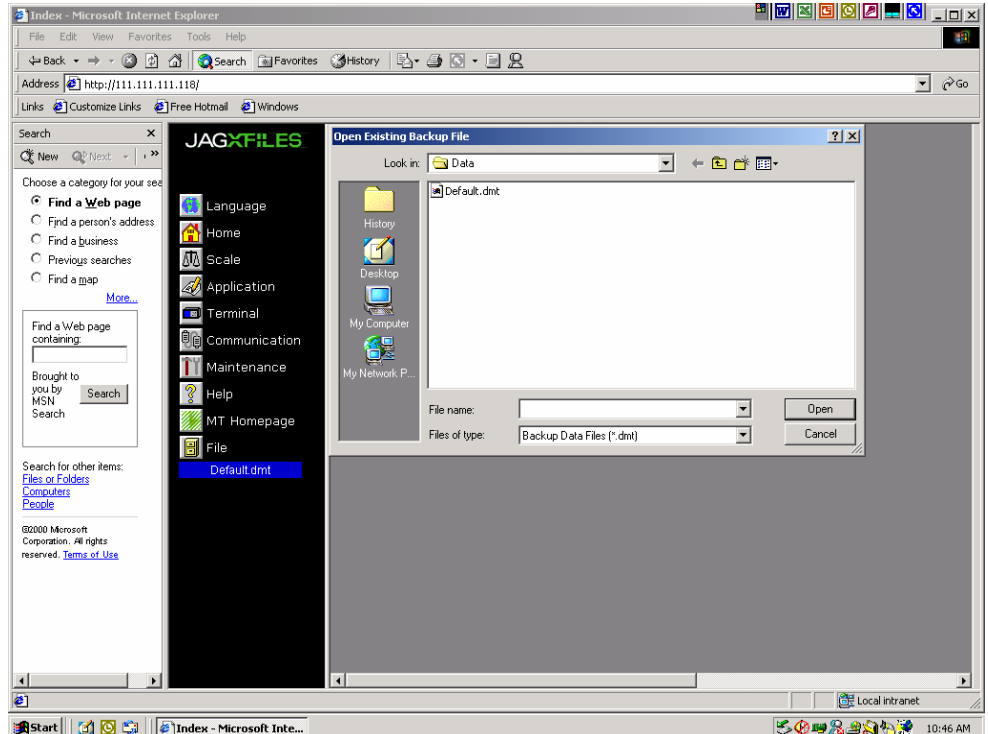

Save

Clicking on **Save** the currently open backup file to disk with a new file name allows you to save the currently open configuration file (the .dmt file that appears on the left side of your screen below the navigation bar) with the existing name or with a new name. Note: Any changes you make to the configuration file will be saved to the open file.

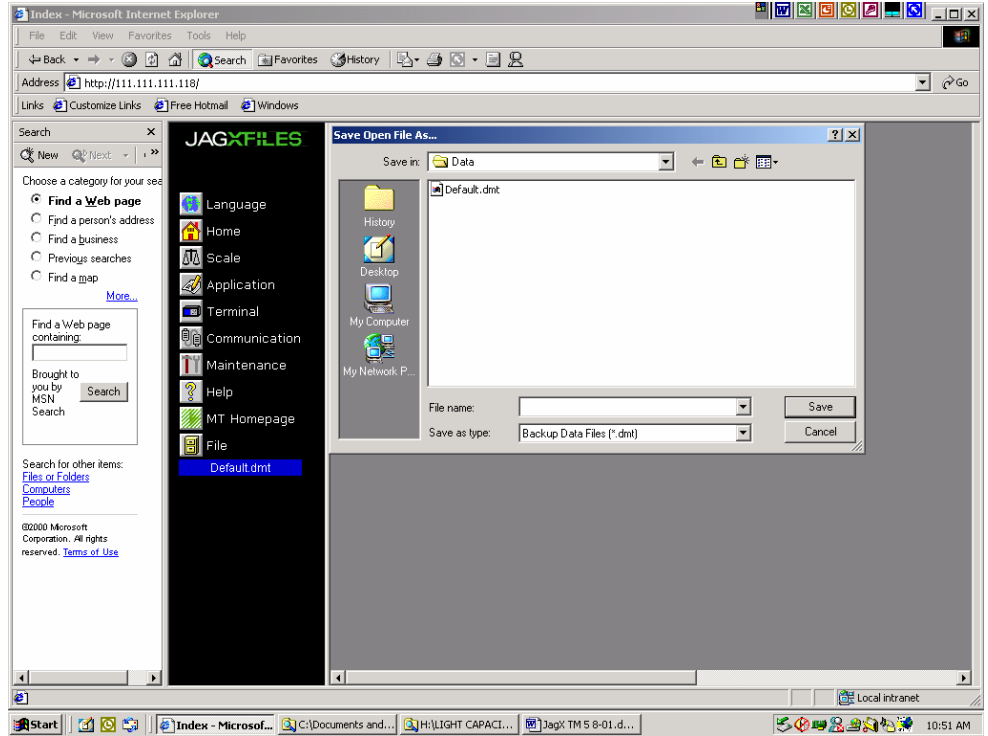

Restore

Clicking on **Restore a backup file to a connected JAGXTREME terminal** allows you to download a configuration file to a terminal via the web server.

You can create a file for each of any number of JAGXTREME terminals then download each file to a specific terminal connected to your PC, or you can email them to a remote location and they can then be downloaded to terminals at that destination. This reduces the time it takes to configure multiple JAGXTREME terminals. You will be given the option of:

- Restore ALL data, including scale calibrations
- Transferring all data EXCEPT scale calibrations
- Transferring ONLY printer templates, prompts, and literals.

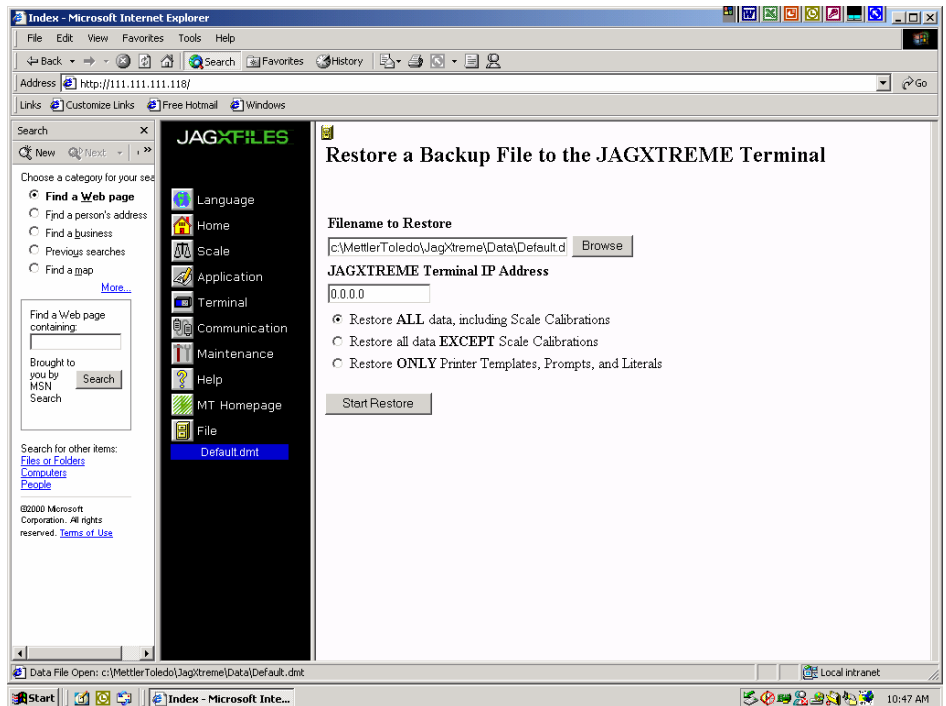

Backup

Clicking on **Backup the setup data from a connected JAGXTREME terminal to a file** allows you to backup (upload) a JAGXTREME terminal configuration from a JAGXTREME terminal to a local PC for storage. This file can then be used to configure other JAGXTREME terminals or to restore a configuration file in the event of a hardware or software failure.

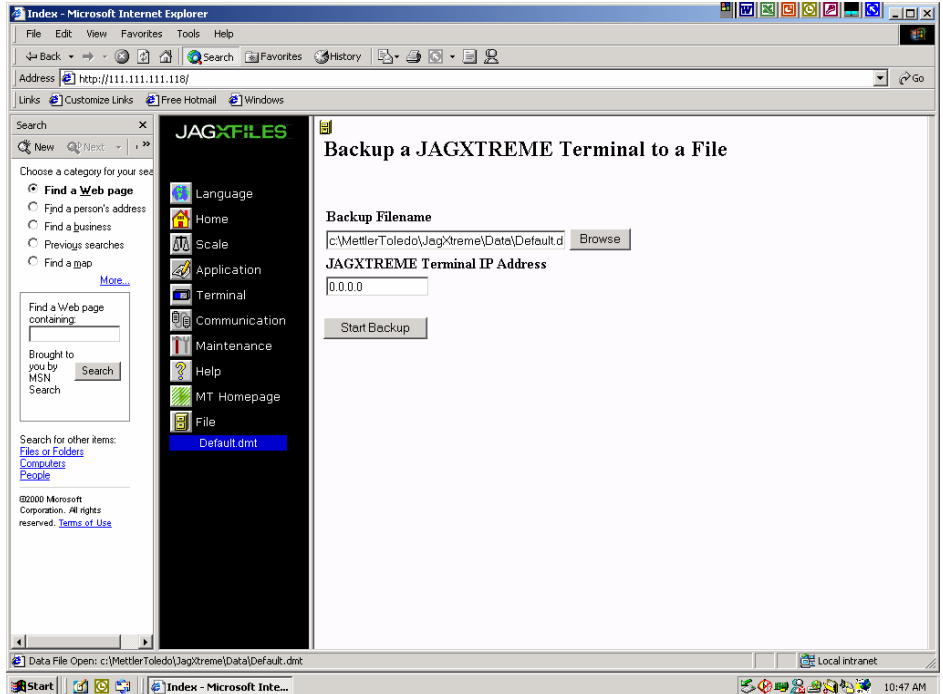

All Other Menu Items

Consult the chapters on programming and calibration and using the web browser in the technical manual for additional configuration information.

Shutting Down JAGXFILES

Closing your browser (even when it contains a JAGXFILES screen) will not shut down the JAGXFILES utility. To close JAGXFILES, you **MUST** right-click on the JAGXFILES icon in the system tray in the lower right-hand corner of your computer screen and choose **Shut Down JAGXFILES**.

7

Service and Maintenance



Tools and Supplies

Keep the following items on hand for service and maintenance of the JAGXTREME terminal. Common hand tools may also be required.

- Volt-Ohm meter
- Single DigiTOL load cell simulator 0917-0178 (if a DigiTOL scale is used)
- Analog load cell simulator - Part Number 8245100A (variable) or 10086500A (10-step) if an analog load cell scale is used
- Soft, lint-free cleaning cloth
- Antistatic bags for PCBs - Part Number (*)14006300A (5x8)
- Antistatic wrist strap and mat
- METTLER TOLEDO screwdriver Part Number (*)14476100A
- Phillips head screw driver
- Allen wrench (2 mm)

Cleaning and Regular Maintenance

Wipe the keyboard and covers with a clean, soft cloth that has been dampened with a mild glass cleaner. Do not use any type of industrial solvent such as toluene or isopropanol (IPA) as they may damage the terminal's finish. Do not spray cleaner directly onto the terminal.

Regular maintenance inspections by a qualified service technician are recommended.

Troubleshooting

If problems occur, do not attempt to repair the scale or terminal before you have determined the source of the problem. Record as much information as possible about what has happened including any error messages and physical responses of the terminal and/or scale. If the JAGXTREME terminal is malfunctioning, perform the troubleshooting tests detailed in this chapter to identify the problem.

Status Lights

The two red lights on the back of the Analog A/D board are diagnostic tools and indicate the status of the terminal. The following table describes the possible light indications. Refer to the Error Codes and Actions section for corrective action suggestions.

A	B	Status
Blink	Blink	OK
On	On	RAM Error
On	Off	EPROM Error
Off	On	MELSI Error
Off	Blink	MMR Cell Error

The Allen-Bradley option board has a status LED with three modes:

- ON—indicates normal operation
- Flashing—indicates the PLC is in Program Mode
- OFF—indicates a communication problem with the PLC

Error Codes and Actions

The following table lists the JAGXTREME terminal's error messages, probable cause, and remedy.

Error Message	Description	Probable Cause	Remedy
AB_BAD_DISP_MODE	Bad Display Mode Command in Allen-Bradley Block Transfer Message.	PLC Programming Error.	Correct PLC Program.
AB_BAD_FLD_NAME1	Bad Shared Data Field Name in field 1 of Allen-Bradley Block Transfer Message.	PLC Programming Error.	Correct PLC Program.
AB_BAD_FLD_NAME2	Bad Shared Data Field Name in field 2 of Allen-Bradley Block Transfer Message.	PLC Programming Error.	Correct PLC Program.
AB_BAD_FLD_NAME3	Bad Shared Data Field Name in field 3 of Allen-Bradley Block Transfer Message.	PLC Programming Error.	Correct PLC Program.
AB_BAD_FLD_NAME4	Bad Shared Data Field Name in field 4 of Allen-Bradley Block Transfer Message.	PLC Programming Error.	Correct PLC Program.

Error Message	Description	Probable Cause	Remedy
AB_WRITE_DISABLE	PLC attempted to write a Shared Data Field that is write protected. When the JAGXTREME is in legal-for-trade mode, restricted Shared Data fields cannot be written.	PLC Programming.	If necessary, you can access restricted parameters by removing the legal-for-trade jumper.
ALC_EE_CHKSM_ER	A Checksum Error was detected in accessing the Scale Calibration parameters on the analog load cell card.	Static, power problems, inductive noise. Bad EEPROM.	Reset to Factory in Scale Interface Menu. Recalibrate scale. If problem persists, replace the analog load cell card.
ALC_EE_NO_ACCESS	The JAGXTREME terminal cannot access Scale Calibration parameters on the analog load cell card.	You have configured the JAGXTREME terminal for a nonexistent analog load cell card; the analog load cell card is not jumpered properly; the analog load cell is not seated properly; or the analog load cell card is not working.	Check your configuration; check the jumpers on the load cell card; reseal the load cell card. If none of these actions correct the problem, put in a new analog load cell card.
ALC_EEPROM_ERROR	Analog load cell EEPROM memory error.	Static, power problems, inductive noise. Bad EEPROM.	Re-power and recalibrate. Check for good power, suppress noise; take static precautions. Replace analog PCB.
ALC_EPROM_ERROR	Analog load cell EEPROM memory error.	Defective analog PCB.	Replace appropriate analog PCB.
ALC_MELSI_ERROR	Analog load cell A/D error.	A/D error has occurred.	Re-power the unit. Check with weight simulator. If error persists, replace Analog PCB.
ALC_NO_RESPONSE	Analog load cell A/D communications error.	A/D error has occurred.	Re-power the unit. Check all ALC jumpers. Check with weight simulator. If error persists, replace analog PCB.
ALC_RAM_ERROR	Analog load cell A/D RAM error.	Static, power problems, inductive noise. Bad analog PCB.	Re-power and recalibrate. Check for good power, suppress noise; take static precautions. Replace analog PCB.
ALC_RESPONSE_ERR	Analog load cell A/D communications response error.	Internal error.	Re-power the unit. Check with weight simulator. If error persists, replace analog PCB.
ALC_UNDEFINED_ERR	Analog load cell A/D undefined error.	Analog load cell A/D memory error has occurred.	Verify programming and jumpers for analog PCB are correct. If error persists in software prior to "B" revision, upgrade software to "C" revision or later.

METTLER TOLEDO JAGXTREME Terminal Technical Manual

Error Message	Description	Probable Cause	Remedy
BAD_NUMBER_CELLS	The terminal has been configured with an illegal number of load cells in a POWERCELL scale or J-Box scale.	Improper setup.	Check number of load cells configured for both scales. Correct the setup.
BRAM Bad - Rst?	Battery-backed RAM error.	Setup parameters in battery-backed RAM have been corrupted. Most likely causes are too long of storage for the terminal, power removed from the terminal memory too long, battery failure, or hardware failure.	Respond Y(es) to reset to factory settings. Reprogram setup parameters. If problem persists, you may have to replace battery, power supply, or controller card.
BRAM CKSUM ERROR	Setup variables corrupt.	Electrical malfunction. Power removed from the terminal memory for too long. The battery and super-cap on the controller card drained.	Press ENTER to continue. Check setup parameters for desired settings.
BRAM Err - Rst? Y (Will appear during power-up sequence only after loading new software.) BRAM VERSION ERR	Different program version detected. Storage locations for setup parameters and memory locations have been moved in a new software up date.	New software version has been downloaded to the JAGXTREME terminal.	Press ENTER to accept the reset default Y (es) response. All parameters will be reset to factory default values. Reprogram the terminal's setup parameters.
CALIBRATION_ERR	Calibration error.	Improper setup or calibration sequence, or bad load cell.	Check wiring. Check with simulator. Check load cell and recalibrate. Verify calibration setup parameters.
Can't redim. var	JagBASIC programming error.	Once a JagBASIC application has declared a variable or an array, it cannot be re-dimensioned to a different size array.	Correct JagBASIC program.
CELL CALIB ERROR	CELL CALIBRATION ERROR	The calibration counts for the cell are in error,	Either the POWERCELL is bad or you did an invalid scale calibration.
CELL ZERO ERR	CELL ZERO DRIFT FAILURE	An individual POWERCELL zero has exceeded its established zero limits	Check the individual POWERCELL indicated in error message. You should perform diagnostics checks on the cell. You may have to replace the cell.
CELL ZERO OK	CELL_ZERO_DRIFT_OK	Previous cell zero drift error has now gone back within the established limits	There may still be a potential POWERCELL hardware problem. You should perform diagnostics checks the cell.

Error Message	Description	Probable Cause	Remedy
CHANGE PWCEL ERR	There was an error when attempting to change a POWERCELL address.	Communications error with POWERCELL.	Run the cell diagnostics to verify the POWERCELL address. If it is still at its old address, try changing the address. If the problem persists, replace the POWERCELL.
CLEAR_TARE_AT_0	According to the scale setup parameters, the scale must be at gross zero in order to clear tare.	If you select Tare Interlock, the scale must be at gross 0 in order to clear tare.	Check local legal-for-trade requirements. If you do not want this feature, turn off the Tare Interlock selection.
Command error	An error occurred in trying to access a file from the JagBASIC interpreter.	Most likely, you tried to access a file that does not exist. It is also possible that the file system has been corrupted.	Use the DIR command from the JagBASIC Interpreter to verify the directory of the RAM disk. If the file system has been corrupted, you need to re-initialize it from the JagBASIC setup menus and rebuild it from the backup files you are maintaining on a PC.
BRAM Power Fail!	The JAGXTREME terminal detected low power supply voltage while attempting to write permanent data to BRAM Shared Data.	You have an early version of the JAGXTREME terminal power supply or a bad power supply.	Upgrade the power supply on the terminal with the latest version.
CONNECT_NOT_FOUND	Serial connection not found.	Improper serial setup.	Reset serial programming block to factory defaults. Reprogram serial setup parameters.
CTL_EE_CHKSM_ERR	Checksum error on accessing the EEPROM on the Controller Board. This EEPROM holds the calibration parameters for single-cell DigiTOL and J-Box scales.	Electrical noise, static discharge, or bad EEPROM chip.	Recalibrate DigiTOL scale. If problem persists, replace the EEPROM on the controller board or the controller board itself.
CTL_EE_NO_ACCESS	Physical error on accessing the EEPROM on the Controller Board. This EEPROM holds the calibration parameters for single-cell DigiTOL and J-Box scales.	Hardware malfunction.	Power down/up the terminal. If problem persists, replace the EEPROM on the controller board or the controller board itself.
DEST_NOT_CONNECT	The remote JAGXTREME terminal that is the destination for a cluster communications message is not connect ed.	The remote terminal that is the destination for a cluster communications message is not connected.	Verify network setup; verify Ethernet wiring, addresses, and terminations.
Device error	JagBASIC programming error.	The JagBASIC program has referred to an illegal device or a device that is not open.	Correct the JagBASIC program.

METTLER TOLEDO JAGXTREME Terminal Technical Manual

Error Message	Description	Probable Cause	Remedy
DIM not array	JagBASIC programming error.	The JagBASIC program has attempted to dimension a variable that is not an array.	Correct the JagBASIC program.
Divide by zero	JagBASIC programming error.	The JagBASIC program has attempted to divide a number by zero.	Correct the JagBASIC program.
DLC_ERR_NO_COMM	No communication or an intermittent communication failure to the DigiTOL load cell.	Bad DigiTOL base, interconnect cable, or serial port.	Check voltages. Check with simulator. Verify serial out put port. Check cable/cell.
DLC_BAD_PROTOCOL	The JAGXTREME has detected a bad protocol exchange with a DigiTOL load cell.	Noise being generated on cable between the terminal and DigiTOL load cell.	Check cabling, grounding, and connections at the terminal and at DigiTOL base.
DLC_INVALID_CHNL	DigiTOL load cell in valid channel.	Communications port as signed to the DigiTOL load cell is invalid.	Check COM port selection in setup. If setup appears correct, reset JAGXTREME to factory setup. Reprogram the setup parameters.
DLC_PARITY_ERROR	Parity error has been detected in communication between terminal and DigiTOL load cell.	Possible bad load cell, in correct wiring, or electrical interference.	Check DigiTOL base, wiring, grounding, and power source.
EE A CErr - Rst? Y EE B CErr - Rst? Y	EEPROM Checksum Error. The scale calibration parameters stored on the EEPROM have been corrupted.	Hardware failure.	Press ENTER to accept the reset default Y(es) response. You must recalibrate JAGXTREME scale.
EE A VErr - Rst? Y EE B VErr - Rst? Y EE VERSION ERROR	Version number in the EEPROM does not match that expected by the operating system.	Terminal was calibrated with an earlier version of the operating system.	Press ENTER to accept the reset default Y(es) response. You must recalibrate the scale.
EE Reset Error	An attempt to access the EEPROM for the selected scale has failed.	Terminal improperly configured with nonexistent scale devices. It can be also be caused by an improperly seated scale board or a hardware malfunction on the scale board.	Check your scale configuration in setup. You may have to do Reset to Factory. Try reseating the boards. If these efforts fail, replace the scale board.
EF	Functional error in the weighing cell of an MMR (IDNET) base.	Static, power problems, inductive noise or unexpected operation.	Press the ESC key to continue. Take steps to eliminate probable cause.
EL	A command transmitted to an MMR (IDNET) base has been received, but cannot be executed.	Static, power problems, inductive noise or unexpected operation.	Press the ESC key to continue. Take steps to eliminate probable cause.
END_OF_FILE	End of File encountered while reading Shared Data.	End of File encountered while reading Shared Data.	None.

Error Message	Description	Probable Cause	Remedy
END_OF_SHIFT_ADJ	Last load cell or pair completed during shift adjust procedure.	Last load cell or pair completed during shift adjust procedure.	None.
ERROR in line	JagBASIC programming error. This message indicates the line in which the error occurred.	JagBASIC programming error. There will also be an error code indicating the type of programming error.	Correct the JagBASIC program.
ES	A command or string transmitted to an MMR (IDNET) base has been received, but is not a recognized command.	Static, power problems, inductive noise or unexpected operation.	Press the ESC key to continue. Take steps to eliminate probable cause.
ET	A transmission to an MMR (IDNET) base was received with a transmission error such as a parity, stop- or start-bit, or over flow error.	Static, power problems, inductive noise or unexpected operation.	Press the ESC key to continue. Take steps to eliminate probable cause.
ETHERNET_BAD_ADDRS ETHERNET_DUP_ADDRS	You have configured the Ethernet address with either a duplicate address with another node on the network or an illegal Ethernet address.	The Ethernet address is not set up properly.	Check network address on JAGXTREME terminal.
ETHERNET_TEST_ERR	The standard power up testing of the Ethernet adapter failed.	Ethernet Adapter Failure.	Re-power up the JAGXTREME terminal. If problem persists, replace the controller card.
Event def error	JagBASIC programming error.	There is a programming error in defining an event.	Correct JagBASIC program.
File open failed	JagBASIC programming error.	Most likely, the JagBASIC program has attempted to open a nonexistent RAM disk file or serial communications device.	Correct JagBASIC program.
FOS_RESP_TIMEOUT	The Formatted Output Server (FOS) generates demand print and continuous print messages. They may be directed to a local or remote serial port. This error occurs when the FOS does not receive a response serial port driver within a specified amount of time.	This error usually occurs when print data is directed to a remote serial port. If the Ethernet LAN is disconnected while the FOS is waiting for a response, this error may occur.	Check Ethernet wiring.

METTLER TOLEDO JAGXTREME Terminal Technical Manual

Error Message	Description	Probable Cause	Remedy
FTP COMM ERROR	FTP COMMUNICATION ERROR	An FTP communication error occurred,	If the problem persists, carefully record the conditions that cause the error and contact the METTLER TOLEDO Technical Support.
FTP COMMAND ERR	FTP COMMAND ERROR	The FTP server received a command that it does not support.	Do not use the command that caused this error.
FTP FILE ERROR	FTP FILE ERROR	The FTP server detected an error in accessing a file	If the problem persists, carefully record the conditions that cause the error and contact the METTLER TOLEDO Technical Support.
IDN BUFF OVRFLOW	Excessive data.	Unexpected operation.	Power down, then up. If error still occurs, reset the JAGXTREME terminal to factory settings and reprogram setup parameters.
IDN EPROM ERROR	Damaged EPROM chip.	Electrical malfunction.	Replace IDNET PCB.
IDN NO RESPONSE	No response from base.	Bad wiring or pcb(s).	Check wiring. Replace IDNET PCB. Replace IDNET base.
IDN RAM ERROR	Damaged RAM chip.	Electrical malfunction.	Replace IDNET PCB.
IDN RESPNSE ERR	Unexpected response.	Unexpected operation.	Power down, then up. If error still occurs, reset the JAGXTREME terminal to factory settings and repro gram setup parameters.
Illegal command	JagBASIC programming error.	The JagBASIC program has issued a command that is not a legal command.	Correct the JagBASIC program.
ILLEGL_QUAR_RACK	An illegal quarter rack value has been specified for the Allen-Bradley RIO option.	Invalid setup.	Check the Allen-Bradley set up.
Incomplete line	JagBASIC programming error.	The JagBASIC program contains a line that does not have the full syntax required for a line.	Correct JagBASIC program.
INCRM_CHAIN_TARE	A decreasing chain tare was attempted in a market where only incremental chain taring is permitted.	Chain taring that causes a decrease in the tare weight is not permitted in some markets in legal-for-trade applications. An incremental chain tare is a new tare on top of an already existing tare value where the new tare value is greater than the old tare value.	Check the market setting in setup. Check the "tare interlock" setting in setup. Check the legal-for-trade switch on the controller board. Verify that these are set properly.

Chapter 7: Service and Maintenance
Error Codes and Actions

Error Message	Description	Probable Cause	Remedy
Internal Errors 1 Through 13	Various errors.	Programming failure, hardware failure.	Power down, then up. If error still occurs, reset the JAGXTREME terminal to factory settings and reprogram setup parameters. Replace controller or analog PCB.
Invalid device #	JagBASIC programming error.	The JagBASIC program is referencing a device # that is not open.	Correct the JagBASIC program.
Invalid SD name	JagBASIC programming error.	The JagBASIC program is referencing an invalid Shared Data name.	Correct the JagBASIC program.
INVALID_FILE_NAME	There was an attempt to access Shared Data with an invalid file name.	This could be caused by an internal or external access of Shared Data.	Determine if an internal or external access caused the error. If an external access is causing the error correct the PLC or Host PC program. If an internal source appears to be causing the problem, power down, then up. If error still occurs, reset the terminal to factory settings and reprogram setup parameters.
LADDER_EMPTY	Discrete I/O setup error.	User attempted to delete a rung from the ladder that is empty.	Reset discrete configuration to factory and setup discretes.
LADDER_FULL	Discrete I/O setup error.	User attempted to add a rung to the ladder that is full.	Reset discrete configuration to factory and setup discretes.
Line # invalid	JagBASIC programming error.	The JagBASIC program contains a line number greater than 30000 or a duplicate of an existing number.	Correct the JagBASIC program.
Line too big	JagBASIC programming error.	The size of a JagBASIC line is greater than 80 characters.	Correct the JagBASIC program.
LOAD::no filename	JagBASIC programming error.	The LOAD command does not contain a file name.	Correct the JagBASIC command.
Memory find fail	JagBASIC programming error.	The JagBASIC program has exceeded the memory limits of the system.	Reduce memory usage of a JagBASIC program by reducing the number of lines, eliminating unnecessary spaces in the program, reducing the number of variables, or reducing the size of the arrays. When chaining JagBASIC programs, always load largest program first to reduce memory fragmentation.
MODEM CONNECT	MODEM_CONNECT	The modem successfully connected to a remote modem.	This is not an error, but an alert to the event.

METTLER TOLEDO JAGXTREME Terminal Technical Manual

Error Message	Description	Probable Cause	Remedy
MODEM DISCONNECT	MODEM_DISCONNECT	The modem has disconnected from a remote modem after successfully connecting.	This likely not an error, but an alert to the event.
MODEM DIAL ERROR	MODEM DIALING ERROR	An error was detected in sending the dialing command to the modem.	You will need to verify the modem setup.
MODEM INIT ERROR	MODEM INITIALIZATION ERROR	An error was detected in initializing the modem.	Make sure that the modem is powered on and the modem cable is securely attached to both the JAGXTREME and the modem. If the problem persists, you need to verify the modem setup and cabling.
MN THRESHOLD ERR	WEIGHTMENT MONITORING THRESHOLD ERROR	Error in setting the weight thresholds used for monitoring weighments.	Check your setup for these thresholds.
NETWORK PRINT ERR	There was a network error in attempting to print a demand print, continuous print, or setup report.	This error typically occurs when the demand print or continuous print is directed to a remote JAGXTREME. It occurs when Ethernet network messaging fails.	Check network setup, addresses, wiring, terminations, and connections.
NETWORK_XMIT_ERR	Ethernet communications transmission error.	Faulty Ethernet addresses, wiring, line termination, or adapter.	Check the Ethernet wiring for bad connections, wiring breaks, or improper line terminations.
NEXT without FOR	JagBASIC programming error.	There is a NEXT statement without the required FOR statement.	Correct JagBASIC program.
No line number	JagBASIC programming error.	The program line does not have a line number.	Correct JagBASIC program.
No Remote Access	JagBASIC programming error.	The program is attempting to access a device that is already in use by a serial connection or by another JagBASIC program in the JAGXTREME terminal cluster.	To access a serial device, remove all serial connections to the device in setup. To share a serial device among JagBASIC programs, set up a scheme where only one program has the device open at a time.
No Scale A Type No Scale B Type No Scale E Type	Scale type definition is missing.	No scale type entered in Scale Interface menu.	Go to "Scale Interface" setup menu and set scale type.
NO_CHAIN_TARE	User attempted to take a second or "chain" tare after a tare was already taken.	When the tare interlock is selected in setup, chain taring is illegal in certain markets.	Check the local "legal for trade" requirements. Check the market selection and tare interlock settings in setup. The system will continue to operate properly but will not allow the chain tare.

Chapter 7: Service and Maintenance
Error Codes and Actions

Error Message	Description	Probable Cause	Remedy
NO_DISCRETE_CBCK	There are no more discrete callback structures available.	The setup of this system and the JagBASIC application has exceeded this system limit.	Power down, then up. If error still occurs, reset the terminal to factory settings and reprogram setup parameters.
NO_DMD_PRNT_CON	There is demand print connection configured in setup.	No demand print entered in the "Configure Serial, Configure Port" menu.	Change setup parameters.
NO_KEYBOARD_TARE	Keyboard tare disabled.	Keyboard Tare is disabled in the "Application Env, Tare Operation" setup menu.	Change setup parameters to enable this feature.
NO_PUSHBUTT_TARE	Pushbutton tare disabled.	Pushbutton Tare is disabled in the "Application Env, Tare Operation" setup menu.	Change setup to enable this feature.
NO_PWCEL_OLD_ADR	POWERCELL readdressing error.	When readdressing a POWERCELL, no POWERCELL was found at the specified old address. This problem could be caused by a entering an invalid address or by a POWERCELL communications error.	Run the cell diagnostics to verify the POWERCELL address. If the cell is at its old address, try changing the address again. If the problem persists, you may have to replace the POWERCELL.
NO_SECOND_UNITS	Secondary units not specified.	No secondary units selected in "Application Env, Alt Weight Units" mode setup.	Change setup to enable the feature.
OFF LINE ERROR	The JAGXTREME terminal on ETHERNET network not responding	Loss of communication between JAGXTREME terminals	Check Ethernet cabling. Check JAGXTREME terminals on network. Power down, then up affected JAGXTREME terminals.
ON no GOSUB	JagBASIC programming error.	ON statement is present without required GOSUB.	Correct JagBASIC program.
Oper. File Error	Cannot read language messages file.	Unexpected operation.	Power down, then up. If error still occurs, reset the JAGXTREME to factory settings and reprogram setup parameters.
OPTION BASE->DIM	JagBASIC programming error.	The program must define the OPTION BASE before dimensioning an array.	Correct JagBASIC program.
Out of data	JagBASIC programming error.	The JagBASIC program has issued more READ commands to initialize system variables than there is data specified in DATA statements.	Correct JagBASIC program.

METTLER TOLEDO JAGXTREME Terminal Technical Manual

Error Message	Description	Probable Cause	Remedy
OUT_OF_COMM_BUFS	Cluster communications error.	The system has exceeded the fixed limit on the number of communication buffers that can be used at one time. Most likely one JAGXTREME is sending messages to a second faster than the second can process them.	Power down, then up. If error still occurs, reset the terminal to factory settings and reprogram setup parameters.
OUT_OF_MEMORY	The JAGXTREME software cannot get the dynamic memory it needs to continue running.	The system is using more dynamic "heap" memory than is available or the heap memory has become fragmented.	Reduce the size of a JagBASIC program. Eliminate unnecessary spaces in the program. Reduce the number of variables. Reduce the size of the arrays. When chaining JagBASIC programs, always chain in the largest program first to reduce memory fragmentation. Eliminate unused network connections, serial connections, and printer templates.
OUT_OF_ZERO_RANG	Operator has attempted to zero the scale outside of the legal zeroing range.	The zeroing limits are set up in the "Application Env'n, Zero Operation" menu.	Change zeroing range in set up, if necessary.
Overflow	JagBASIC programming error.	A JagBASIC program causes an overflow error by exceeding certain system limits. The maximum size of the "gosub" stack, the "for-next" stack, and the "while-wend" stack is 9 entries each. Overflow errors can also be caused by particular language syntax errors.	Correct JagBASIC program.
PLC_COMM_ERROR	There was a timeout in the communications between the terminal and a PLC. This error is only reported after there has been a successful connection and communication fails.	The most likely cause is improper wiring or wiring termination, or there was a fault at the PLC. Entering and exiting setup at the terminal can also cause this error because the PLC adapter is reset.	Check wiring and wiring terminations. Verify PLC operation. Note: The JAGXTREME terminal will automatically recover communications after an intermittent failure.
Prbus config err	Attempts to configure the Profibus card failed.	Most likely, this error is caused by a Profibus card hardware failure.	If problem persists, replace the Profibus card.
PRINT REQUESTED	The operator has requested a Demand Print through the Control Panel.	None.	None.

Chapter 7: Service and Maintenance
Error Codes and Actions

Error Message	Description	Probable Cause	Remedy
PRINT_IN_PROGRES	The operator has requested a second demand print while the first is in progress.	None.	None.
PRINT_NOT_READY	Scale is in motion while attempting to print.	None.	None.
Profibus init err	The Profibus card could not be initialized.	Bad Profibus card.	Replace Profibus card.
Program too big	JagBASIC programming error.	First problem: The program exceeds 400 text lines or 18KB. Second problem: This error can also occur while you are typing in a JagBASIC program when the temporary program buffer becomes full.	For the first problem, separate the program into smaller files that can be run independently or chained together. When chaining, always start execution with the largest program to avoid memory fragmentation. For the second problem, save the current program and load it in again. This will cause a larger temporary program buffer to be allocated.
PWC_PROTOCOL_ERR PWC_TIMEOUT_ERR PWC_UNDEFIND_ERR PWC_BUFF_OVERFLOW	Communication Error between controller card and POWERCELL card.	Bad POWERCELL card.	If error persists, replace the POWERCELL card.
PWC_CHECKSUM_ERR	Checksum error on firmware on POWERCELL card.	Bad POWERCELL card.	If error persists, replace the POWERCELL card.
PWC_EEPROM_ACCES	Unable to access EE PROM on POWERCELL card.	Bad POWERCELL card.	If error persists, replace the POWERCELL card.
PWC_EEPROM_ERR PWC_EEPROM_CHECK	Checksum error on power scale calibration data stored on EEPROM on POWERCELL card.	New version of JAGXTREME software. Hardware failure caused corruption of EEPROM data.	Recalibrate scale. If problem persists, replace the POWERCELL card.
PWC_NO_ERROR PWC_NO_ERROR2	None.	None.	None.
PWC_RAM_ERR	RAM memory error on POWERCELL card.	Bad POWERCELL card.	If error persists, replace the POWERCELL card.
PWCEL_AT_NEW_ADR	You attempted to readdress a POWERCELL to a new address that already exists on the POWERCELL network.	Your addressing procedure for the POWERCELLs has created duplicate addresses.	Recheck your addressing scheme. If necessary, reset all POWERCELL addresses to the factory default address of 240. Begin addressing the cells again. Use the AutoAddress capability to minimize addressing errors.

METTLER TOLEDO JAGXTREME Terminal Technical Manual

Error Message	Description	Probable Cause	Remedy
PWCEL_BAD_FMT	The format of the data from the remote POWERCELL is invalid.	Most likely, this is a communication error or power supply problem for the remote POWERCELLS. Bad remote POWERCELL.	If problem persists, validate wiring, line terminations, and power in the POWERCELL network. Replace the remote POWERCELL, if necessary
PWCEL_EEP_ERR	The remote POWERCELL has reported a checksum error in its EEPROM.	Bad remote POWERCELL.	Replace remote POWERCELL.
PWCEL_NEG_RNG	The weight reported by a remote POWERCELL is in the negative weight range.	Bad remote POWERCELL.	Replace remote POWERCELL.
PWCEL_NO_DATA	No weight data is being reported by a remote POWERCELL.	Most likely, this is a communication error or power supply problem for the remote POWERCELLS. It could also be caused by a bad remote POWERCELL.	If problem persists, validate wiring, line terminations, and power in the POWERCELL network. Replace the remote POWERCELL, if necessary
PWCEL_NO_RESP	The remote POWERCELL is not responding to polls from the JAGXTREME terminal.	Most likely, this is a communication error or power supply problem for the remote POWERCELLS. It could also be caused by a bad remote POWERCELL.	If problem persists, validate wiring, line terminations, and power in the POWERCELL network. Replace the remote POWERCELL, if necessary
PWCEL_ROM_ERR PWCEL_RAM_ERR	The remote POWERCELL is reporting an error in its local memory.	Bad remote POWERCELL.	Replace remote POWERCELL.
PWCEL_RESTART	The JAGXTREME terminal has restarted a remote POWERCELL after the POWERCELL has not responded with valid data.	Most likely, this is a communication error or power supply problem for the remote POWERCELLS. It could also be caused by a bad remote POWERCELL.	If problem persists, validate wiring, line terminations, and power in the POWERCELL network. Replace the remote POWERCELL, if necessary
Record not found	JagBASIC programming error.	A record specified in GET statement for an indexed sequential file could not be found in the file.	There should be an ON ERROR statement in the JagBASIC program to handle these potential situations.
Resource in use	JagBASIC programming error.	The JagBASIC application tried to access a system resource that is already in use by another JAGXTREME task. In particular, a JagBASIC application cannot open a serial port that has been assigned to a serial port connection in setup. Also, when two or more JagBASIC applications are sharing a remote serial port, only one application can have the port open at a time.	Correct JagBASIC application. To share remote serial ports between multiple JagBASIC applications, you will have to develop sharing logic that checks for this specific error code.

Chapter 7: Service and Maintenance
Error Codes and Actions

Error Message	Description	Probable Cause	Remedy
RETURN no GOSUB	JagBASIC programming error.	RETURN statement is present without required GOSUB.	Correct JagBASIC application.
SCALE_IN_MOTION	Scale in motion. This is a normal occurrence and not necessarily an error.	Motion on the scale during taring or zeroing the scale.	Try mechanical methods to stabilize the scale base first. Then, try changing the filtering to a stiffer setting in set up. Then, try changing the motion stability settings to make it less sensitive.
SCALE_UNDER_ZERO	The scale gross weight has gone more than "n" divisions below the current zero. The default "n" is 5, but it can be adjusted in set up.	The zero value for the scale could have been re set by hitting the zero but ton. There could be a connection problem to the base, particularly, with an analog base.	Take all weight off the scale base and reset the zero value. Zero settings in setup determine the range of how far from the calibrated zero that you can set a new zero value. If your weighing process uses below zero weight values, you can disable the under zero by setting the zero blanking value to 99 divisions. Check the analog base wiring.
SCL_OVERCAPACITY	The weight on the scale exceeds the calibrated capacity of the scale by more than 5 divisions.	There is too much weight on the scale based on calibration parameters.	Reduce the weight on the scale.
SD string > max.	JagBASIC programming error.	JagBASIC can only access Shared Data fields whose length is less than the maximum JagBASIC string size of 80 bytes.	Correct JagBASIC program.
SD_BAD_BUFFER	There was an invalid access to Shared Data.	A Shared Data access re quest provided a buffer that is not long enough.	Make sure that the external agency is providing a large enough buffer to match the requested Shared Data field.
SD_WRITE_DISABLE	There was an invalid access to Shared Data.	An external agency at tempted to access a protected Shared Data field in legal-for-trade mode.	Check external agency program.
SER CONST ERROR	The JAGXTREME could not start or restart a logical serial connection.	JAGXTREME software error.	Power down, then up. If error still occurs, reset the JAGXTREME terminal to factory settings and reprogram setup parameters.
SER_BUFFER_FULL	The JAGXTREME demand print buffer is full.	JAGXTREME software error.	Power down, then up. If error still occurs, reset the JAGXTREME terminal to factory settings and reprogram setup parameters.

METTLER TOLEDO JAGXTREME Terminal Technical Manual

Error Message	Description	Probable Cause	Remedy
SER_IN_TIMEOUT	There was a timeout waiting for serial input.	The serial device talking to the terminal has not sent the required input to the terminal. This could also be caused by communication errors.	Verify message exchange between the JAGXTREME terminal and serial device.
SER_MSG_SEQ_ERR	There was an error in the sequencing of demand print messages.	Most likely, when one terminal is printing at a remote terminal, a message was lost in the Ethernet communications.	If problem persists, check Ethernet wiring, terminations, and connections.
SERIAL_MSG_ERROR	The Serial Services software modules got an invalid request.	JAGXTREME software error.	Power down, then up. If error still occurs, reset the JAGXTREME terminal to factory settings and reprogram setup parameters.
SETPOINT_NO_RATE	The user has configured a rate setpoint, but has not configured rate calculation.	The user has not configured the rate calculation.	Configure the rate function in the Alternate Weight Units sub-block.
SHIFT_ADJUST_ERROR	The shift adjustment factors could not be calculated.	The weight placements during the shift adjust procedure was incorrect.	Carefully redo the shift adjustment, perhaps, with bigger weights.
SPX_NET_ERROR	SPX returned a network error status.	Most likely, there is a problem with the Ethernet wiring.	Check the network setup, wiring, connections, addressing, and terminations.
SYMMETRY OK	SYMMETRY CHECK OK	Previous symmetry error has now gone back within the established limits,	There may still be a potential POWERCELL hardware problem. You should perform diagnostics checks the individual cells in the symmetry set.
Syntax error	JagBASIC programming error.	The JagBASIC program has a syntax error.	Correct the JagBASIC program.
TARE_ABOVE_LIMIT	Tare value exceeds the allowed limit.	In a legal for trade environment in certain markets, the tare value cannot exceed the highest weight in the lowest range of a multi-range scale.	Check local legal-for-trade requirements.
TARE_NOT_IN_INCR	Keyboard Tare is not entered in a rounded value to the nearest increment.	In certain markets, the keyboard tare value must be entered in as a value rounded to the nearest increment.	Make sure the keyboard tare value is rounded to the nearest increment.
TARE_OVER_CAPCTY	Tare exceeds the capacity of the scale.	The tare value cannot exceed the capacity of the scale.	Make sure the tare value is less than the capacity of the scale.
TARE_TOO_SMALL	Pushbutton tare value is less than one division.	Weight on scale must be at least one division when taking Pushbutton tare.	Make sure scale has at least one division of weight before taking pushbutton tare.
TARE_UNDER_ZERO	Attempted to take tare when scale is under zero and has an invalid weight.	Cannot take tare when scale is under zero.	Make sure scale has valid weight before taking tare.

Chapter 7: Service and Maintenance
Error Codes and Actions

Error Message	Description	Probable Cause	Remedy
TEMPLATE_ERROR	Template error.	Error detected in template configuration.	Check template configuration. Correct it as necessary. If problem persists, reset template to factory and reenter template.
Too many dims.	JagBASIC programming error.	JagBASIC arrays can have at most three dimensions.	Correct the JagBASIC program.
TOO_SMALL_INCRMT	Increment size is too small.	The scale increment size is too small so that you are asking for more resolution than the scale base is capable of supporting.	Choose a larger increment size parameter in setup and recalibrate the scale.
Type mismatch	JagBASIC programming error.	JagBASIC statement is using an invalid data type or is relating two in compatible data types.	Correct the JagBASIC program.
Undefined funct.	JagBASIC programming error.	JagBASIC statement referring to an undefined function.	Correct the JagBASIC program.
Value out range	JagBASIC programming error.	The JagBASIC statement is referring to a value out of the range of acceptable values.	Correct the JagBASIC program.
WRONG SCALE MODE	Zeroing scale in net mode.	User attempted to zero the scale in net mode.	Clear tare to put scale in gross mode before zeroing scale.
ZERO_NOT_CAPTURED	Tare attempted before power up zero value was captured.	Tare attempted before power up zero value was captured.	Wait a few seconds after power up before attempting a tare.
SYMMETRY ERR	SYMMETRY DRIFT ERROR	POWERCELL symmetry has drifted beyond the established limits	Check the POWERCELL load cells for the symmetry set indicated in the error message. You should perform diagnostics checks the cells. You may have to replace a bad cell.

Diagnostic Tests

AC Power Test

Using the Volt-Ohm meter, check the AC input power. Input power must be within -15% to +10% of the nominal AC line voltage.

Voltage Test

	 WARNING
<p>ONLY PERMIT QUALIFIED PERSONNEL TO SERVICE THIS EQUIPMENT. EXERCISE CARE WHEN MAKING CHECKS, TESTS AND ADJUSTMENTS THAT MUST BE MADE WITH POWER ON. FAILING TO OBSERVE THESE PRECAUTIONS CAN RESULT IN BODILY HARM.</p>	

Power Supply Voltage

When testing power supply voltages, remove the power supply from the JAGXTREME enclosure. Extreme caution must be taken since the PCB components will be exposed.

1. Unplug the JAGXTREME terminal from the external power source.
2. Remove the power supply assembly from the enclosure and lay it component side down on a non-conductive surface.
3. Verify that the fuse located on the power supply PCB is good before testing any of the voltages. If the fuse is bad, replace it and recheck the power wiring and connections for damage.
4. Locate the 12 solder connections for the connector which plugs into the back panel connector PCB. Refer to Figure 5-a. Use caution not to short adjacent pins.
5. Reapply AC power to the power supply using extreme caution.

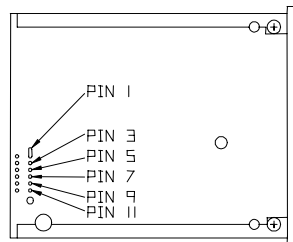

Test Points	Voltage Readings
Chassis GND & Pin 1	4.75 to 5.2 VDC
Chassis GND & Pin 3	4.75 to 5.2 VDC
Chassis GND & Pin 5	4.75 to 5.2 VDC
Chassis GND & Pin 7	4.75 to 5.2 VDC
Chassis GND & Pin 9	18 to 22 VDC
Chassis GND & Pin 11	4.75 to 5.2 VDC

Figure 5-a: Power Supply Test Points (viewed from solder side) and Voltage Chart

If any of the test point voltages listed are missing or incorrect, verify that the power supply fuse and AC line voltage input are OK. If they are good, replace the power supply PCB and retest.

Analog PCB Voltage

The only place to test output from the Analog PCB is at the load cell connection. Verify voltage of 15 VDC between + and - Excitation (DC volts). If the JAGXTREME terminal has power and the analog PCB has no voltage, replace the PCB.

DigiTOL Output Voltage

Voltages to the DigiTOL scale can be measured at the COM2 connector on the Controller PCB. Refer to Figure 5-b. Disconnect the load cell prior to this test.

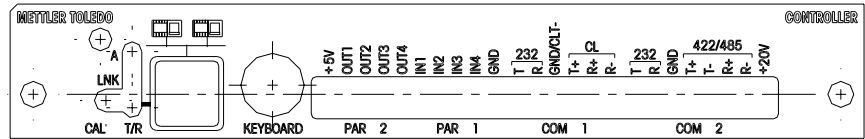

Test Points	Voltage Readings
GND & +20V	20 VDC
TXD+	5 VDC
RXD+ (with no load applied)	2.5 VDC
RXD- (with no load applied)	2.5 VDC

Figure 5-b: Controller Panel and Voltage Chart

Discrete Output Voltage

1. With no load applied and the terminal at zero the following voltages should be measured. Refer to the controller panel diagram and the following table.

Test Points	Voltage Readings
GND & +5 VDC	5 VDC*
+5 VDC & OUT1	5 VDC*
+5 VDC & OUT2	5 VDC*
+5 VDC & OUT3	5 VDC*
+5 VDC & OUT4	5 VDC*

*If voltages are not within the +4.5 to +5.2 VDC range, check for:

- Correct wiring.
- Correct programming parameter configuration.
- Correct setpoint weight values.

QWERTY Keyboard Voltage

1. Test the voltages at the keyboard jack on the Controller PCB panel with the keyboard plug removed. Refer to Figure 5-c.

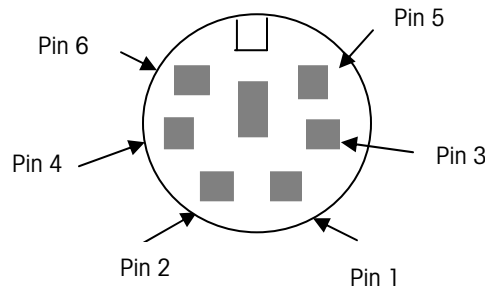

Test Points	Voltage Readings
PIN 1 & PIN 3	5 VDC
PIN 5 & PIN 3	5 VDC
PINS 4 & 3	5 VDC

Figure 5-c: QWERTY Plug Jack and Voltage Chart

2. If the voltages are correct and the keyboard still does not work, try connecting another keyboard.

Backup Battery Test

Disconnect the connector plug from J3 of the power supply PCB and put your voltmeter leads at pin 1 (+ red) and pin 4 (- black). If your reading is between 3.7 volts and 4.2 volts, the battery should be considered operational.

Ground Test

If the ground is insufficient, the JAGXTREME terminal may lock up frequently or give unstable weight readings.

To confirm ground integrity, a commercial branch circuit analyzer is recommended. This instrument uses a high amperage pulse to check ground resistance. It measures the voltage from the neutral wire to the ground connection and will provide an assessment of the line loading. Instructions with the instrument give guidelines about limits that assure good connections. Visual inspections and a query of the user will provide information about equipment sharing the power line.

Using a Volt-Ohm meter to check for excessive voltage between neutral and ground on the AC input is not suitable to confirm power grounding integrity. In some cases, a power line conditioner may help to correct adverse power conditions.

External Equipment Test

1. Disconnect all nonessential external equipment and retest the scale.
2. Reconnect one at a time to isolate a problem with peripheral equipment.
3. If the analog scale option is installed, connect an analog load cell simulator to the I/O port point assigned to this option.
4. Verify that the positive sense is connected to the positive excitation and the negative sense is connected to the negative excitation.

Internal Testing

Access the Diagnostics program block and perform the tests to detect internal problems.

- **Memory**—to test memory on the controller board, flash memory, RAM, and the EEPROM.
- **Display**—to test each segment of the upper and lower display areas and the display ROM and RAM.
- **Keyboard**—to test each key of the keypad, and/or an external PC keyboard.
- **Scale**—to test the weighing functions of a scale that is connected or simulate weighing functions in the expanded x 10 display mode.
- **Serial ports**—to test the serial I/O ports, including a loop back test.
- **Parallel ports**—to test the discrete I/O ports.
- **Network**—to test the network connections.

20 mA /RS-232 Printer Tests

When measuring the higher baud rates in the Demand mode, the meter display will fluctuate for a shorter period of time.

20 mA Terminal Output Test

If you suspect the terminal may not be transmitting data to the printer when using 20 mA current loop, follow this test procedure:

1. Remove power from the terminal and the printer and disconnect the data cable from the printer.
2. Connect the red voltmeter lead to the + 20 mA receive pin on the printer end of the cable.
3. Connect the black voltmeter lead to the - 20 mA receive pin on the printer end of the cable. Set the meter to read DC milliamps.
4. Apply power. The meter should read as follows:
 - For 300 to 9600 baud in Demand mode, the meter should display a stable reading between 18.0 and 40.0 mA. Any reading below 18.0 mA or above 40.0 mA indicates a malfunction in the sending device.
 - For 2400 to 9600 in Continuous mode, the meter should fluctuate continuously between 16 mA and 22 mA. The constant fluctuation on the meter display indicates the scale/indicator is transmitting information. To test the Demand baud rates, press PRINT on the terminal. The display should fluctuate from 1/2 to 3/4 of the initial reading, then become stable again. This indicates the terminal has transmitted data.

RS-232 Terminal Output Test

Use the following procedure to determine if the RS-232 serial port is operational.

1. Remove power from the terminal and the printer and disconnect the data cable from the printer.
2. Set the voltmeter to read 20 volts DC.
3. Connect the red lead to pin 2 of the printer end of the data cable and connect the black lead to pin 7.
4. Apply power. The meter should read as follows:
 - For 300 to 9600 baud in Demand mode, the meter should read between -5 and -15 with no fluctuation.
 - For 2400 to 9600 baud in Continuous mode, the meter should fluctuate between -5 and +5 continuously. The constant fluctuation on the meter display indicates the scale/indicator is transmitting information.

When measuring the higher baud rates in the Demand mode, the meter display will fluctuate for a shorter period of time.

To test the Demand baud rates, press PRINT on the JAGXTREME terminal. The display should fluctuate between -5 volts and +5 volts for the duration of the transmission, then become stable again. This indicates the terminal has transmitted data.

Replacing the Power Supply

Follow the instructions in this section if you should ever need to replace the power supply due to damage from power surges or malfunction.



DISCONNECTING BOTH THE POWER SUPPLY AND THE BATTERY BACK-UP CAN RESULT IN LOSS OF ALL PROGRAMMING.

It may be necessary to loosen the PCB right thumbscrews and gently pry the power supply assembly away from the panel mount unit.

The Controller board has a Super Action Cap that supports its RAM for up to 24 hours. It is unlikely that disconnecting the power supply or battery will result in loss of setup data; however, you should have a record of the setup parameters for added security.

To replace the JAGXTREME terminal's power supply unit:

1. Disconnect AC power to the terminal.
2. Disconnect the power cable at the rear of the unit. For general purpose units, remove the back cover.
3. Using a Phillips head screwdriver, remove the two screws located on the top and bottom of the power supply assembly, freeing it from the power supply housing. General Purpose units have only a top screw.
4. Carefully pull the power supply assembly toward you and slide the assembly from the JAGXTREME enclosure. Disconnect the battery harness from J3.
5. Remove the two screws holding the Power Supply PCB to the power supply back panel assembly.
6. Attach the new PCB to the back panel, then reattach the battery harness to J3 and slide the assembly back into the JAGXTREME terminal.
7. Replace and tighten the power supply retention screws removed in step 3.

8. Reconnect the power cable, replace cover (general purpose), and reapply power.

 WARNING!
IMPROPER INSTALLATION OF THE POWER CABLE WILL RESULT IN APPLYING 120 VAC TO GROUND. THE HOT WIRE MUST BE ON TOP. THE TERMINAL SCREWS SHOULD FACE AWAY FROM THE OPTION CIRCUIT BOARD SLOTS.

Replacing the Battery Back-up

JAGXTREME terminals use a standard PC-type battery which is available in most computer service centers.

A 4.5 volt alkaline battery (Part Number 145486 00A) is installed as a back-up in case the power to the unit should fail. You should check the battery periodically to ensure it is working properly and change it as necessary. Refer to the Battery Back-up Test section later in this chapter.

 CAUTION
DISCONNECTING BOTH THE POWER SUPPLY AND THE BATTERY BACK-UP CAN RESULT IN LOSS OF ALL PROGRAMMING.

To replace the battery back-up:

1. Disconnect AC power to the terminal.
2. Disconnect the power cable at the rear of the unit. Remove the back cover for General Purpose units.
3. Using a Phillips head screwdriver, remove the two screws located on the top and bottom of the power supply assembly, freeing it from the power supply housing. General Purpose units have only a top screw.
4. Carefully pull the power supply assembly toward you and slide the assembly from the JAGXTREME terminal's enclosure. Disconnect the battery harness from J3.

 CAUTION
BATTERY MAY EXPLODE OR LEAK IF INSERTED IMPROPERLY, RECHARGED, OR DISPOSED OF IN FIRE. DISPOSE OF BATTERY PROPERLY.

5. Remove the old battery and install the new battery ensuring that pin 1 on J3 is on the (+) side (red wire) of the battery. Connect the battery harness to J3 on the power supply and slide it back into the JAGXTREME terminal.
6. Replace and tighten the power supply retention screws removed in step 3.
7. Reconnect the power cable, replace the cover if working with a general purpose unit, and reapply power.

 WARNING!
IMPROPER INSTALLATION OF THE POWER CABLE WILL RESULT IN APPLYING 120 VAC TO GROUND. THE HOT WIRE MUST BE ON TOP. THE TERMINAL SCREWS SHOULD FACE AWAY FROM THE OPTION CIRCUIT BOARD SLOTS.



For your notes

8

Parts and Accessories

Refer to the following diagrams and data tables when ordering parts and accessories for the JAGXTREME terminal.

Panel Mount Parts

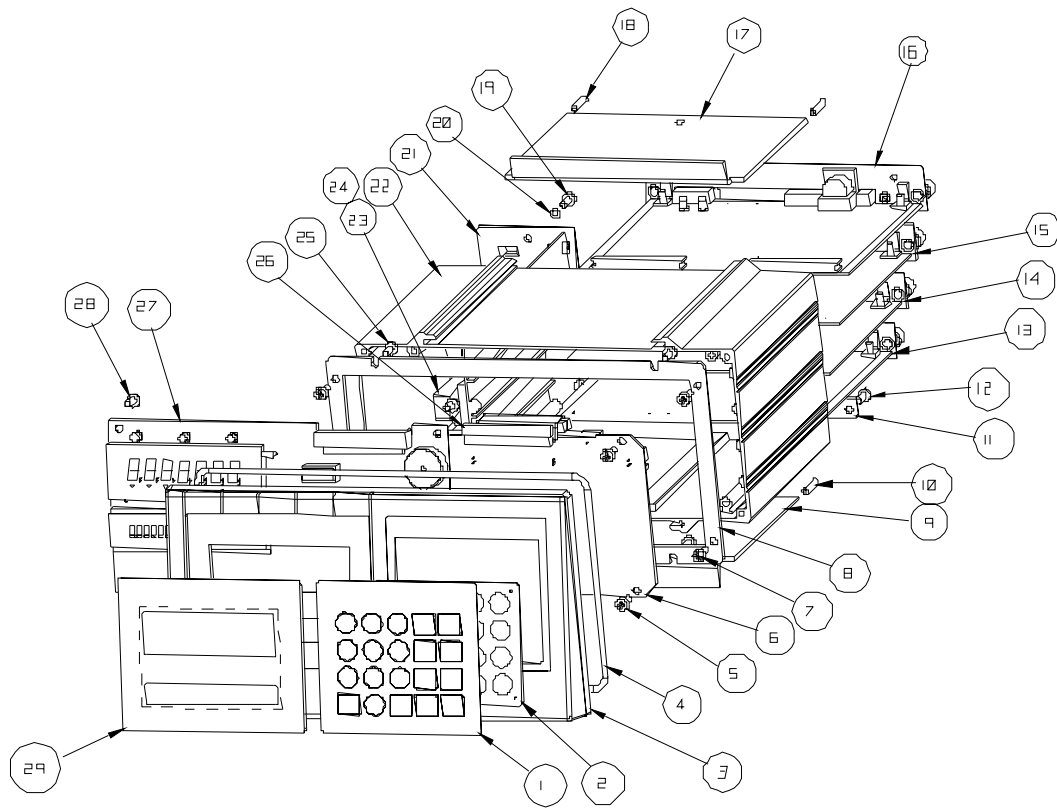

Figure 6-a: Panel Mount Model Parts

Parts List—Panel Mount			
Ref #	Part Number	Description	Qty
1 and 2	(*)14538600A	Keyboard Assembly	1
3	(*)14162800A	Front Panel	1
4	(*)14016100A	Seal, Panel O-Ring	1
5	R0511100A	Screw, M4 x 10 Taptite	4
6	(*)14146200A	Connector (mother) PCB	1
7	R051100A	Screw, M4 x 10 Taptite	4
8	(*)14014100A	Plate, Interface	1
9	(*)14015200A	Clamp Bracket	1
10	R0511300A	Screw, Set M4 x 20	2
11	(*)14015800A	Rear Cover Plate, Bottom	1
12	R0511100A	Screw, M4 10 Taptite	4
13	Slot 3 Refer to the Optional Panels Table**		1
14	Slot 2 Refer to the Optional Panels Table**		1
15	Slot 1 Refer to the Optional Panels Table**		1
16	(*)15740100A	Controller PCB Assembly	1
17	(*)14015200A	Bracket Clamp	1
18	R0511300A	Screw, Set M4 x 20	2
19	R0511100A	Screw, M4 x 10 Taptite	3
20	R00589130	Lock washer, #8 Int. Tooth	2
21	(*)14163600A	Power Supply Assembly	1
22	(*)14546400A	Indicator Chassis	1
23	(*)14901700A	Capacity Label	1
24	(*)14548600A	Battery 4.5 Volt	1
25	R0511100A	Screw, M4 x 10 Taptite	4
26	(*)14015900A	Harness	1
27	(*)14091800A	Display PCB	1
28	R0511100A	Screw, M4 x 10 Taptite	4
29	(*)14015300A	Display Lens	1

(*) May have a revision level prefix.

** Table is located near the end of this chapter.

*** Refer to the section entitled Controller PCB in this chapter for part numbers and details.

General Purpose Parts (Front View)

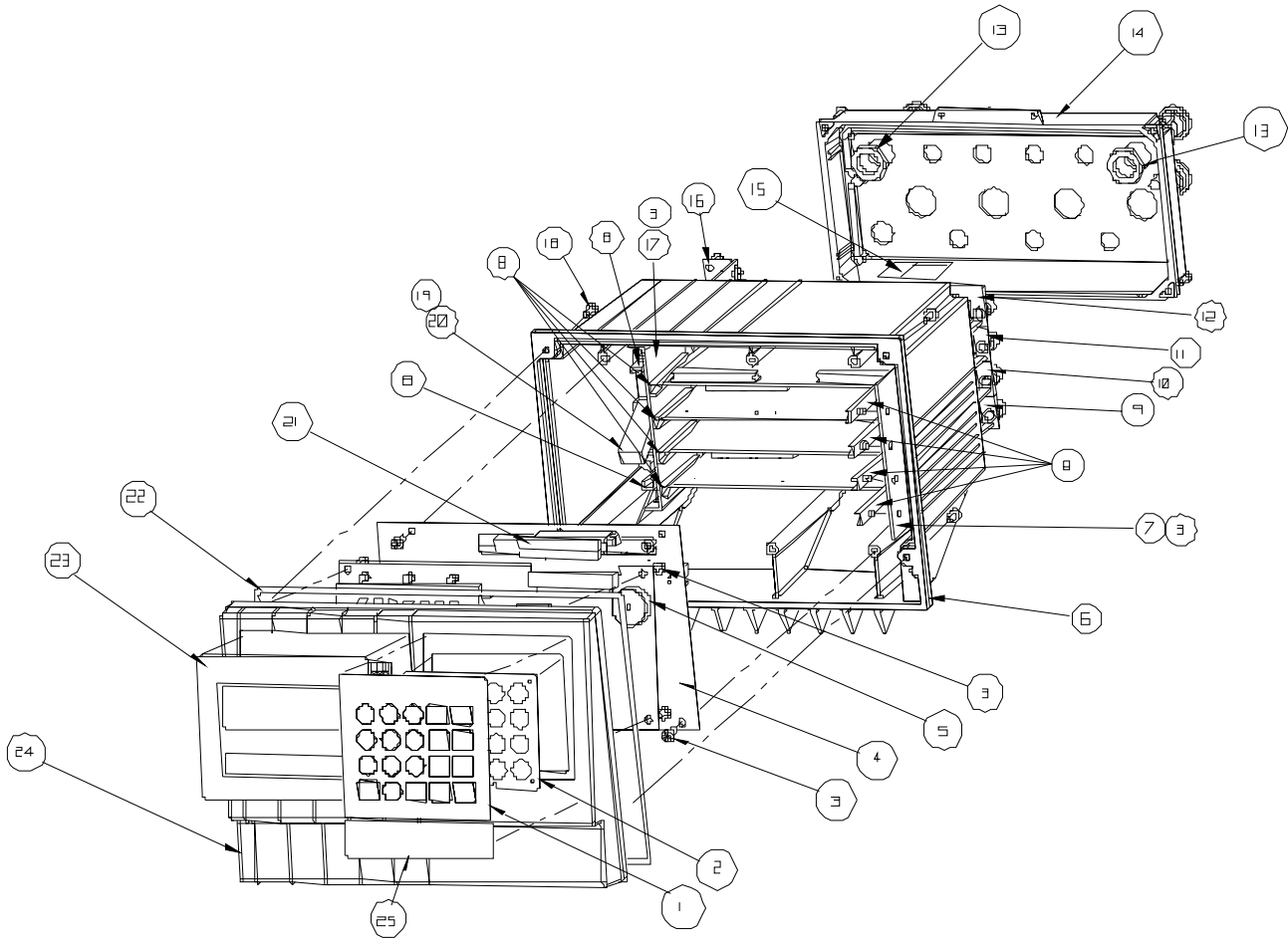

Figure 6-b: General Purpose Model Parts (Front)

Parts List—General Purpose (Front View)			
Ref #	Part Number	Description	Qty
1 and 2	(*)14538600A	Keyboard Assembly	1
3	R0511100A	Screw, M4 x 10 Taptite	14
4	(*)14411000A	Connector (mother) PCB Assembly	1
5	(*)14091800A	VF Display PCB Assembly	1
6	(*)14398800A	Enclosure Assembly, Wall/Desk	1
7	(*)14546800A	Bracket, PCB Guide, Right	1
8	(*)14399400A	Card Guide, 2.5"	2
9	Slot 3 - Refer to the Optional Panels Table**		
10	Slot 2 - Refer to the Optional Panels Table**		
11	Slot 1 - Refer to the Optional Panels Table**		
12	(*)15740100A	Controller Assembly	1
13	(*)14400300A	Hex Nut, PG9, Nylon	2
14	(*)14398700A	Rear Access Cover	1
16	(*)14399600A	Power Supply Assembly	1
17	(*)14546900A	Bracket, PCB Guide, Left	1
18	R0516900A	Seal Screw, M4 x 10 PHD	4
19	(*)14724100A	Hex Nut, Pg11, Nylon	1
20	(*)14548600A	Battery, 4.5 Volt	1
21	(*)14015900A	Harness, VF Display	1
22	(*)14399800A	O-Ring, Sponge	1
23	(*)14015300A	Display Lens, VF	1
24	(*)14398600A	Front Panel, Alpha-numeric	1
25	(*)14901700A	Capacity Label	1

(*) May have a revision level prefix.

** Table is located near the end of this chapter.

*** Refer to the section entitled Controller PCB in this chapter for part numbers and details.

General Purpose Parts (Rear View)

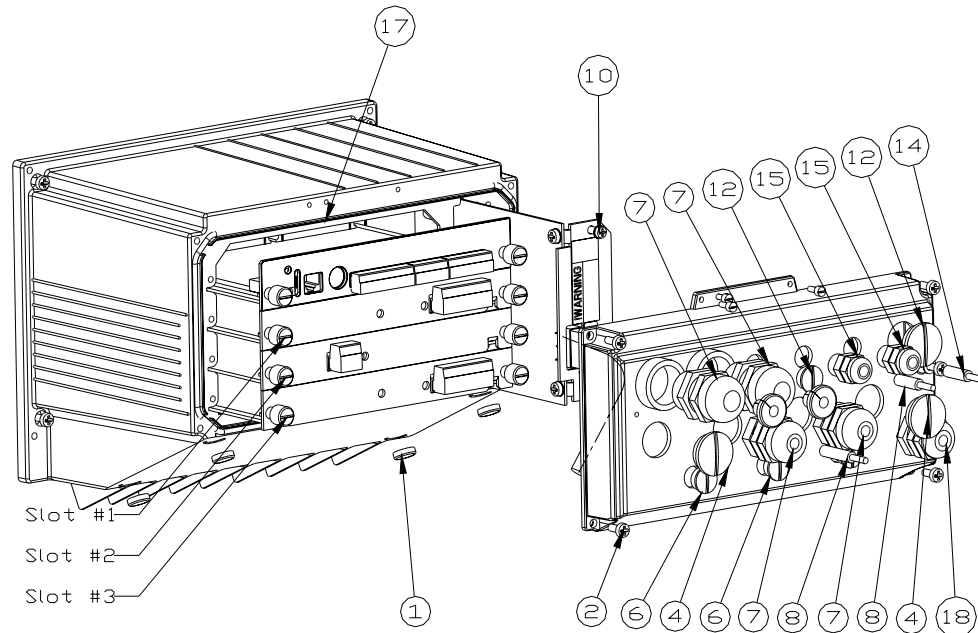

Figure 6-c: General Purpose Model Parts (Rear)

Parts List—General Purpose (Rear View)			
Ref #	Part Number	Description	Qty
1	(*)10839700A	Foot, Stick On	4
2	R0511100A	Screw, M4 10 Taptite	4
4	(*)14400100A	Hole Plug, PG13.5	2
6	(*)14399900A	Hole Plug PG7	5
7	(*)12903900A	Connector, Cord, w/lock nut	2
8	(*)14467600A	Hole Plug .24/.38 diameter	3
10	R0541500A	Screw, M4 x 10 w/lw	2
12	(*)14724400A	Hole Plug, 16 mm ID	2
15	(*)12901800A	Connector, Cord w/lock nut	2
17	(*)14399700A	O-Ring, sponge, 7.5 ID	1
18	Line Cord	Refer to the Line Cord Assemblies Table	1
20	(*)14636400A	Connector, Terminal Block, Plug 3 Pos.	1

(*) May have a revision level prefix.

Harsh Environment Parts

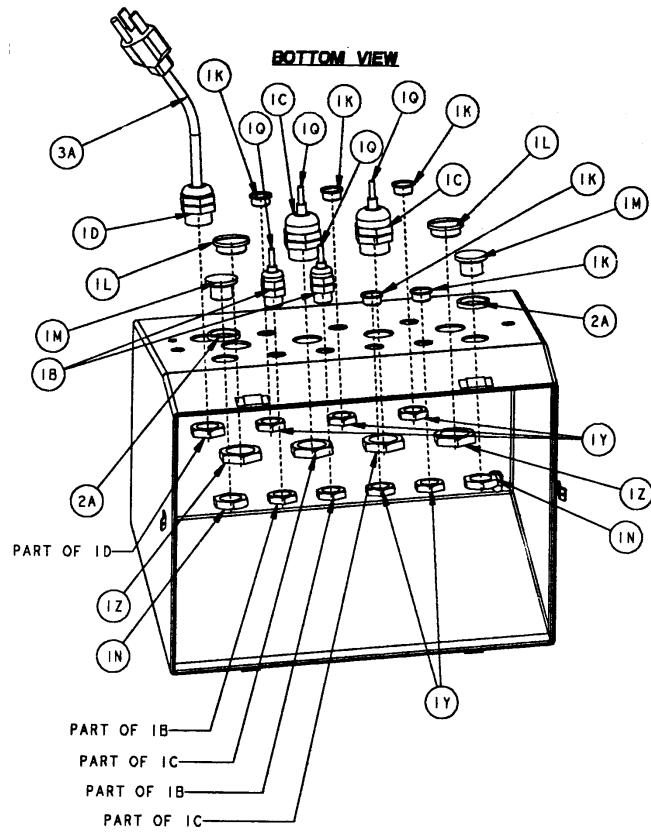

Figure 6-d: Harsh Environment Parts (Bottom View)

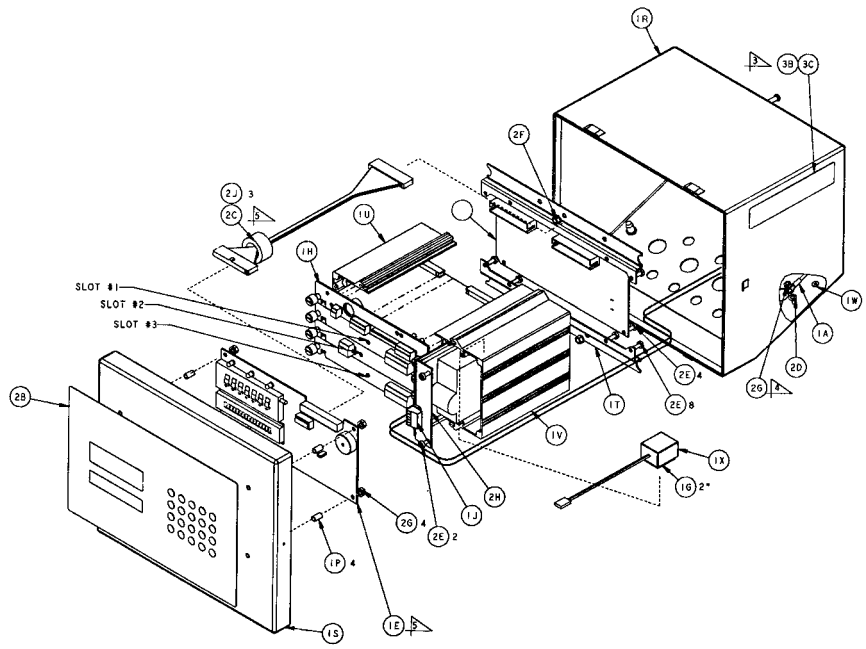

Figure 6-e: Harsh Environment Parts (Top/Front View)

METTLER TOLEDO JAGXTREME Terminal Technical Manual

Parts List—Harsh Environment			
Ref #	Part Number	Description	Qty
1B	(*)12901800A	Conn. Cord w/ Lock nut (0.118-0.255)	2
1C	(*)12903900A	Conn. Cord w/ Lock nut (0.240-0.470)	2
1E	(*)14091800A	PCB Assembly, VF Display	1
1F	(*)14146200A	PCB Assembly, Connector	1
1H	(*)15740100A	Controller PCB	1
1J	(*)14636400A	Conn. Term. Plug	1
1K	(*)14399900A	Hole Plug (PG7)	5
1L	(*)14400100A	Hole Plug (PG13.5)	2
1M	(*)14400200A	Hole Plug, 18 mm	2
1N	(*)14400300A	Hex Nut, PG9	2
1P	(*)14465900A	Spacer, RD, M4	4
1Q	(*)14467600A	Hole Plug (.24/.38 Diameter)	4
1R	(*)16058800A	Enclosure Assembly (Bottom)	1
1S	(*)14519900A	Enclosure Assembly (Top)	1
1T	(*)14520200A	Bracket, Mounting	2
1U	(*)14520600A	Card Guide (Left)	1
1V	(*)14528600A	Card Guide (Right)	1
1W	(*)14531400A	Label, Ground BSI	1
1X	(*)14548600A	Battery, Alkaline, 4.5 V	1
1Y	(*)14577900A	Hex Nut, PG7	5
1Z	(*)14578000A	Hex Nut PG 13.5	2
2A	(*)14578300A	Gasket, Grip	2
2B	(*)14579900A	Assembly Keyboard/SW (JTHx)	1
2C	(*)14636500A	Harness, Display	1
2D	R00589130	Washer #8 I.T. Lock	1
2E	R0511100A	Screw, Pan HD M4x10, PH, TapTite	14
2F	R0519200A	Nut, Hex KEPS, M5	3
2G	R0519600A	Nut, Hex KEPS M4	5
2H	(*)14130400A	Power Supply	1
2J	(*)09827100A	Cable Tie	2
3A	Line Cord	Refer to Line Cord Assemblies Table	
3B	(*)148000000A	Label, Data, Blank (no available for re-order)	1
3C	(*)14801800A	Shield, Data Label	2
3D	(*)13971000A	FCC Label	1
3E	(*)14724100A	Nut, PG11	1
Slot 1	Slot 1	Refer to Optional Panels Table	1
Slot 2	Slot 2	Refer to Optional Panels Table	1
Slot 3	Slot 3	Refer to Optional Panels Table	1
Not Shown	(*)14520400A	Wall Mounting Bracket	2
Not Shown	R0520600A	Wall Mounting Hardware (SS "Hex Head" screw M6 8)	4

(*) May have revision level prefix.

Line Cord Assemblies

Line Cord Assemblies - General Purpose			
Part Number	Destination Description	Market Number	Qty
(*)14962000A	Line Cord - North America	Various	1
(*) 14962100A	Line Cord - United Kingdom	003, 041, 046,053, 096	1
(*) 14962400A	Line Cord - Chile	022	1
(*) 15428400A	Line Cord - Switzerland	005, 007	1
(*) 14962200A	Line Cord - Cont. Europe	Various	1
(*) 14962300A	Line Cord - Australia	009, 010, 023, 057	1
(*)15428200A	Line Cord – Denmark	002	1
(*)15399300A	Line Cord – South Africa	073	1

Line Cord Assemblies – Harsh Environment			
Part Number	Destination Description	Market Number	Qty
(*)15003100A	Line Cord - North America	Various	1
(*) 15003300A	Line Cord - United Kingdom	003, 046,053, 071	1
(*)15003500A	Line Cord - Italy	022	1
(*) 15432100A	Line Cord - Switzerland	005, 007	1
(*) 15003200A	Line Cord - Cont. Europe	Various	1
(*) 15003400A	Line Cord - Australia	009, 010, 023, 057	1
(*)15431900A	Line Cord – Denmark	002	1

Controller PCB

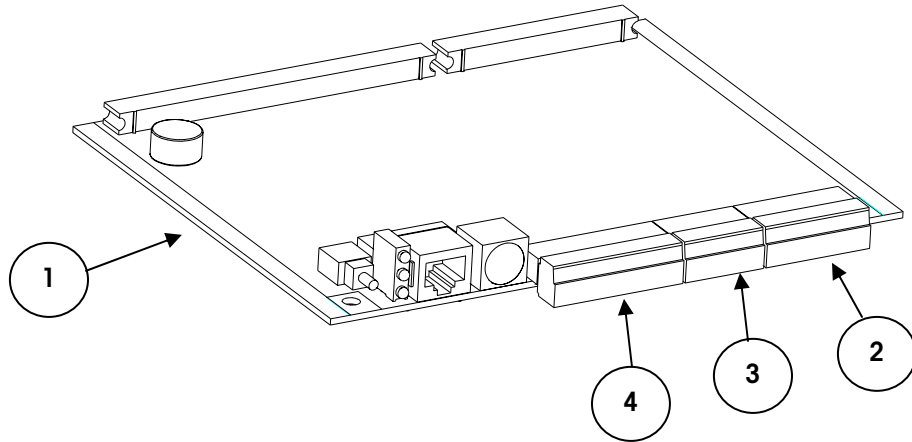

Figure 6-f: Controller PCB Assembly

Parts List—Controller PCB			
Ref #	Part Number	Description	Qty
1	(*)15905900A	JAGXTREME Controller PCB, Latest Revision Operating Software (w/o parts Ref #2-6)	1
2	(*)14113300A	Connector, 8 Position Terminal Block	1
3	(*)14113100A	Connector, 6 Position Terminal Block	1
4	(*)14113400A	Connector, 10 Position Terminal Block	1
5	(*) 15740200A	I/O Plate Assembly, Controller (not shown)	1
6	R0511100A	Screw, M4 x 10 Taptite	2
**1	(*)15740100A	JAGXTREME Controller PCB (w/ parts Ref #2-6)	1
NS	(*)16407800A	JAGMAX Enabled Controller PCB (w/o parts)	1

(*) May have a revision level prefix.

* If a Controller PCB (w/o parts Ref #2-6) is needed with a different version of software, order 14849200A and specify the desired software version. A surcharge will be added for the software change.

** If a Controller PCB (w/ parts Ref #2-6) is needed with a different version of software, order 14849400A and specify the desired software version. A surcharge will be added for the software change.

N/S Not shown

Analog Load Cell PCB

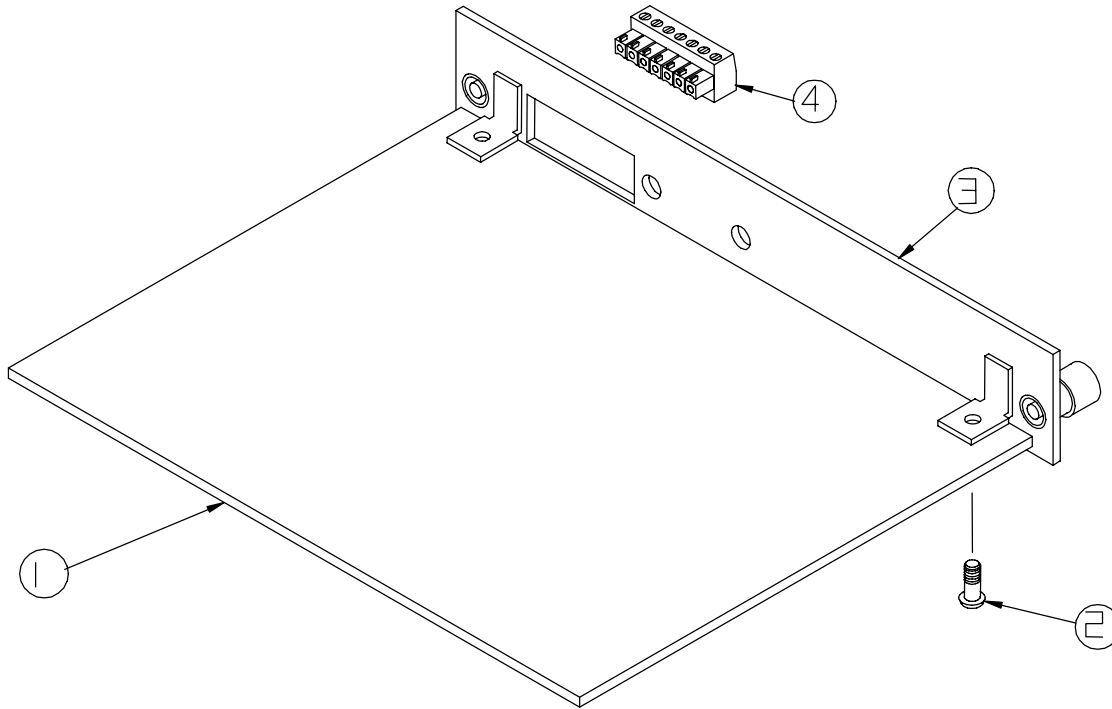

Figure 6-g: Analog Load Cell PCB Assembly

Parts List—Analog Load Cell PCB			
Ref #	Part Number	Description	Qty
1	(*)15345400A (*)15360200A	PCB Assembly, Single Analog, JAGXTREME (w/o Ref # 2-4) PCB Assembly, Reduced Excitation Analog L/C JAGXTREME (w/o Ref # 2-4)	1
2	R0511100A	Screw, M4 x 10 Taptite	2
3	(*)15359000A (*)15360800A	I/O Plate Assembly, Analog I/O Plate Assembly, Reduced Excitation Analog	1
4	(*)11924100A	Connector, 7 Position Terminal Block	1
**	(*)14163300A (*)14490200A	Panel Assembly, Analog L/C, JAGXTREME Panel Assembly, Reduced Excitation L/C, Analog JAGXTREME	1

(*) May have a revision level prefix.

** Includes all parts listed as a complete assembly.

Dual Analog Load Cell PCB

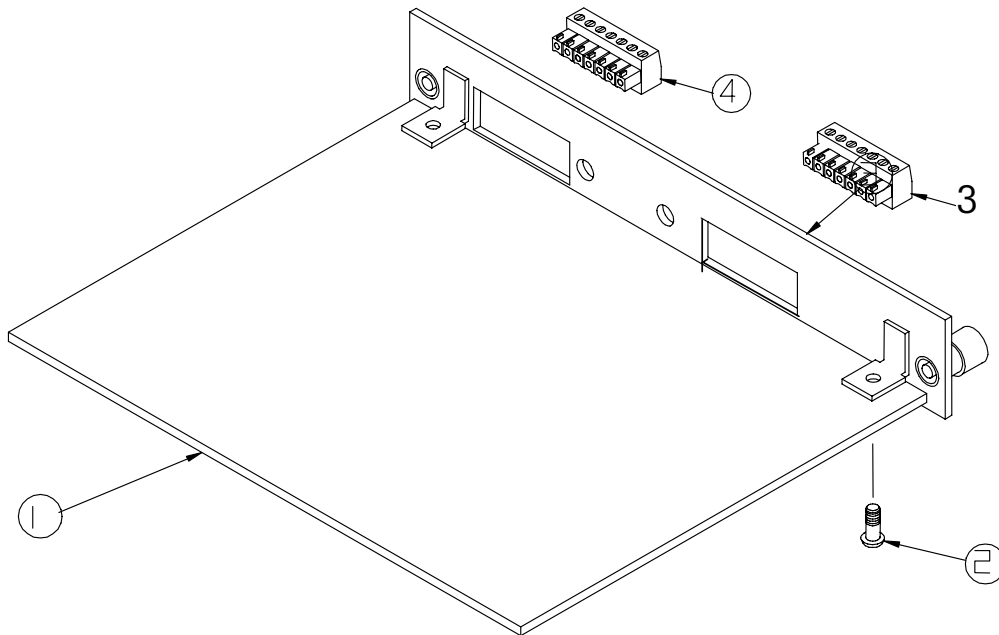

Figure 6-h: Dual Analog Load Cell PCB Assembly

Parts List—Analog Load Cell PCB			
Ref #	Part Number	Description	Qty
1	(*)15290700A	PCB Assembly, Dual Analog Load Cell, JAGXTREME (w/o Ref # 2-4)	1
	(*)15360100A	PCB Assembly, Reduced Excitation Dual Analog PCB (w/o Ref # 2-4)	
2	R0511100A	Screw, M4 x 10 Taptite	2
3	(*)14517500A	I/O Plate Assembly, Analog L/C	1
	(*)15360700A	I/O Plate Assembly, Reduced Excitation Analog L/C	
4	(*)11924100A	Connector, 7 Position Terminal Block	2
**	(*)14517700A	I/O Assembly, Dual Analog PCB Assembly, Non-hazardous	1
	(*)15360300A	I/O Assembly, Dual Analog PCB Assembly, Reduced Excitation	

(*) May have a revision level prefix.

** Includes all parts listed as a complete assembly.

Power Supply

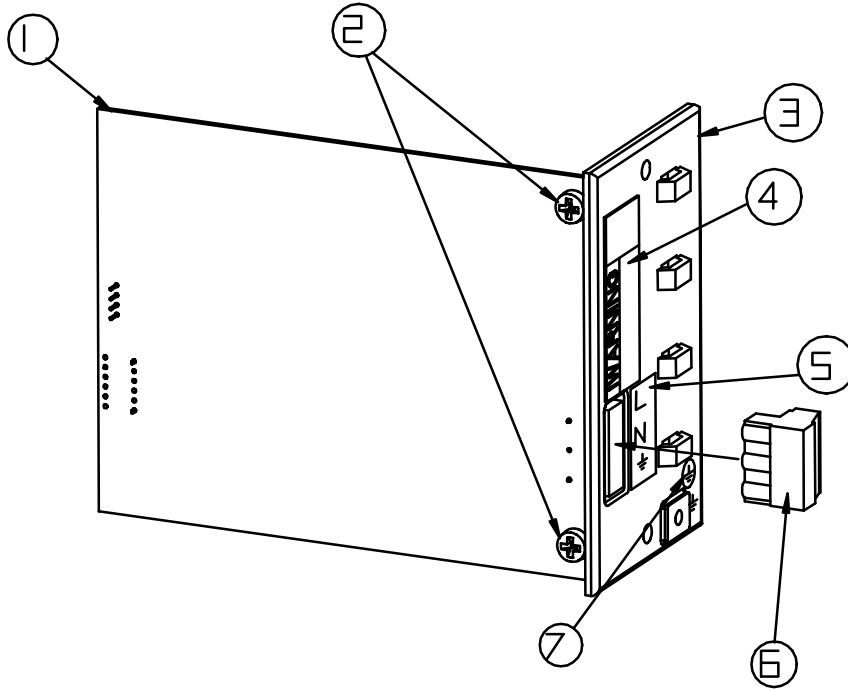

Figure 6-i: Power Supply Assembly

Parts List—Power Supply			
Ref #	Part Number	Description	Qty
1	(*)14200200A	Power Supply PCB	1
2	R0511100A	Screw, M4 x 10 Tapite	2
3	(*)14015100A	Panel Assembly, Power Supply (Panel Mount)	1
	(*)14520300A	Bracket, Power Supply (Harsh Environment)	1
	(*)14399500A	Panel, Power Supply (Desk/Wall)	
4	(*)12699700A	Label, Warning – Power	1
5	(*)14400500A	Label, AC Power In	1
6	(*)14636400A	Connector, 3 Position Terminal Block	1
7	(*)145531400A	Label, Ground, BSI	1
*	(*)14163600A	Power Supply PCB Assembly, Panel/Blind	1
*	(*)14399600A	Power Supply PCB Assembly, Desk/Wall	1
*	(*)14130400A	Power Supply PCB Assembly, Harsh	1

(*) May have revision level prefix.

* Includes all parts listed above as an assembly.

Allen-Bradley RIO Option

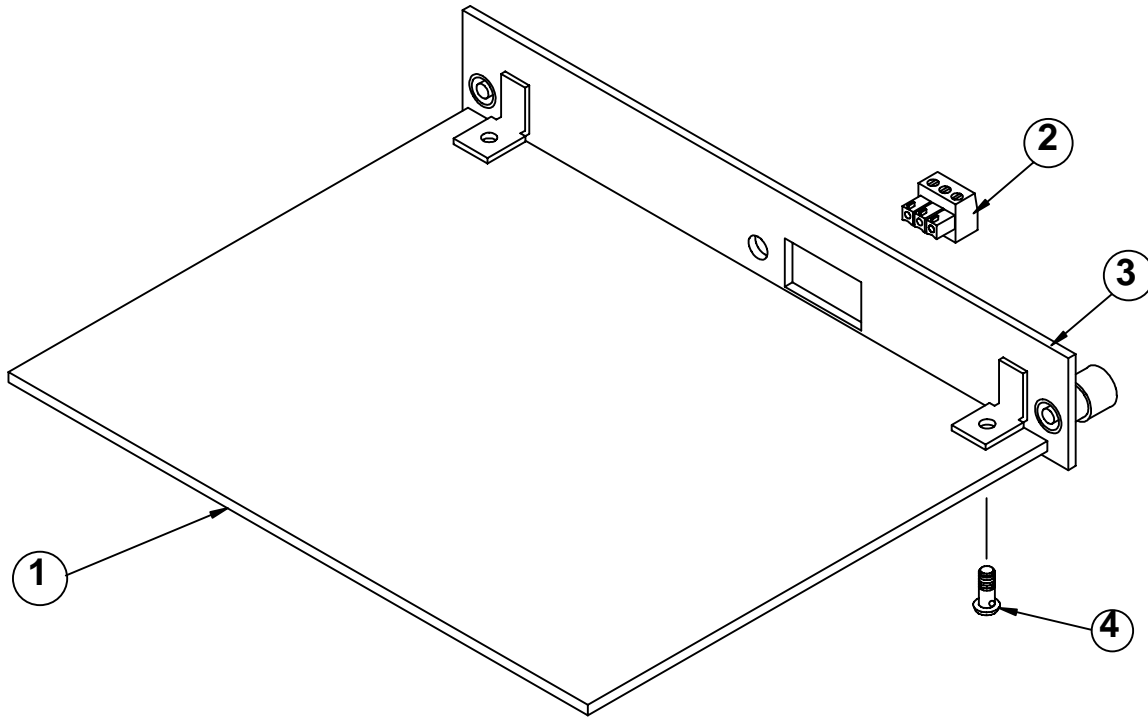

Figure 6-j: Allen-Bradley RIO Assembly

Ref #	Part Number	Description	Qty
1	(*)14093400A	Allen Bradley I/O PCB	1
2	(*)14217400A	Connector, 3 Position Terminal Block	1
3	(*)14162400A	Plate Assembly, Allen Bradley I/O	1
4	R0511100A	Screw, M4 x 10 Tapite	2
*	(*)14163400A	Allen Bradley I/O PCB Assembly	1

(*) May have a revision level prefix.

* Includes all parts listed above as an assembly.

CIP Interface Card

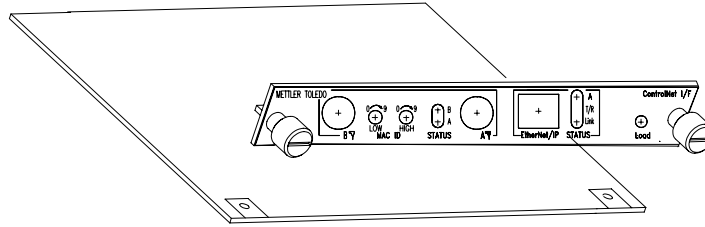

Parts List—CIP Interface Card			
Ref #	Part Number	Description	Qty
1	(*)16280200A	ControlNet I/O Plate	1
2	(*)16119600A	ControlNet PCB Assembly	1
3	R0511100A	Screw, M4 x 10 Taptite	2
4	(*)16280100A	ControlNet PCB/Panel Assembly	1

PROFIBUS Option

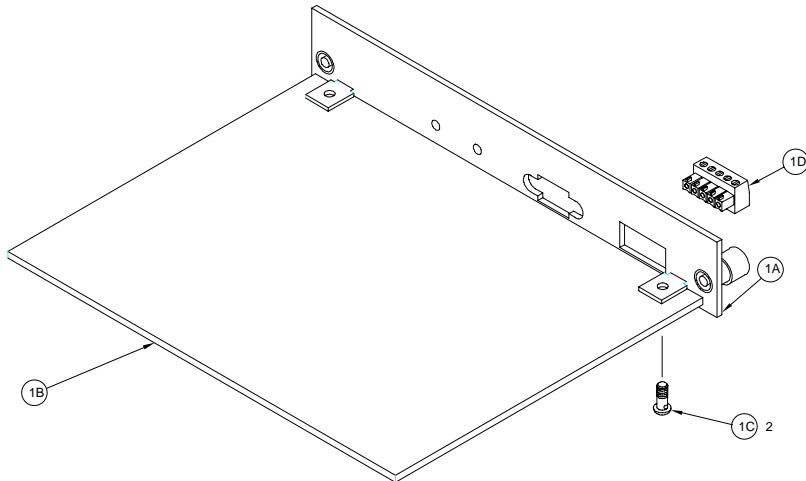

Figure 6-k PROFIBUS I/F Assembly

Ref #	Part Number	Description	Qty
1A	(*)14517000A	I/O Plate	1
1B	(*)14688900A	PCB, PROFIBUS (w/o Hardware)	1
1C	R0511100A	Screw, M4 x 10 Taptite	2
1D	(*)14374900A	Connector, 5-Position Terminal Block**	0
*	(*)14517100A	PROFIBUS PCB/Panel Assembly	1

(*) May have a revision level prefix.

* Includes all parts listed above as an assembly.

**Supplied with 0900-0311 PROFIBUS Pigtail Cable only.

MODBUS Plus PCB

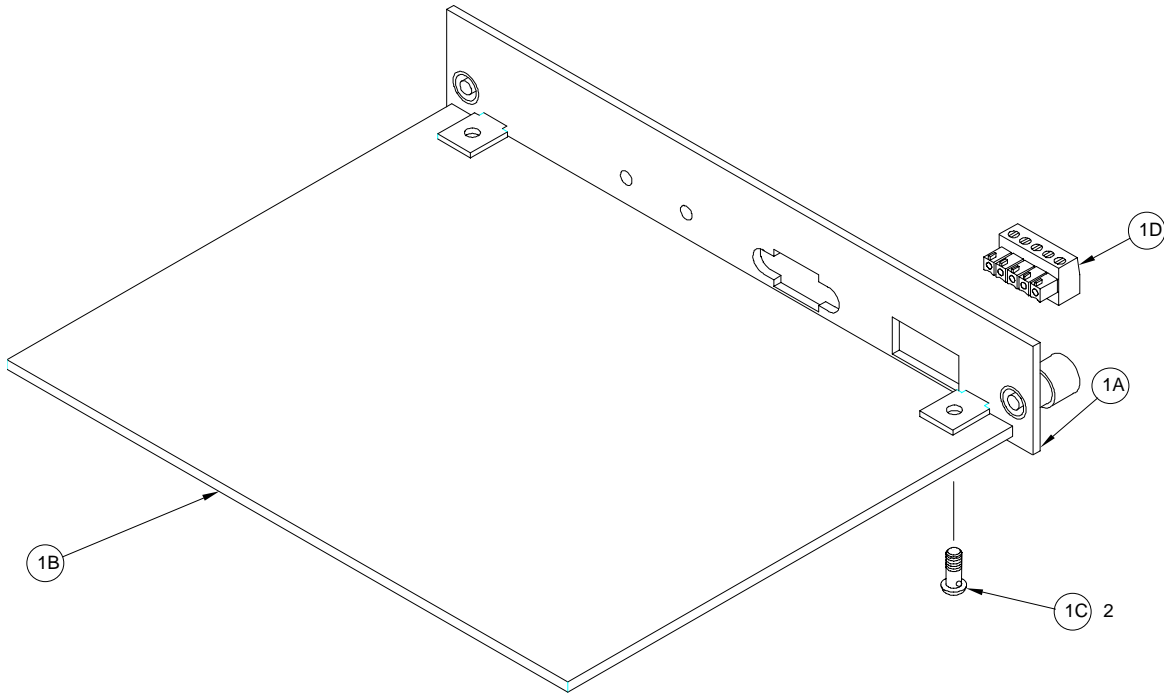

Figure 6-I: MODBUS Plus PCB Assembly

Ref #	Part Number	Description	Qty
1A	(*)145478000A	I/O Plate	1
1B	(*)15084900A	PCB, Modbus Plus (w/o Hardware)	1
1C	R0511100A	Screw, M4 x 10 Taptite	2
1D	(*)14113000A	Connector, 4-Position Terminal Block**	0
*	(*)14547700A	MODBUS Plus PCB/Panel Assembly	1

*Includes all parts listed above as an assembly.

**Supplied with 0900-0320-00A MODBUS PLUS cable.

Dual Analog Output Option

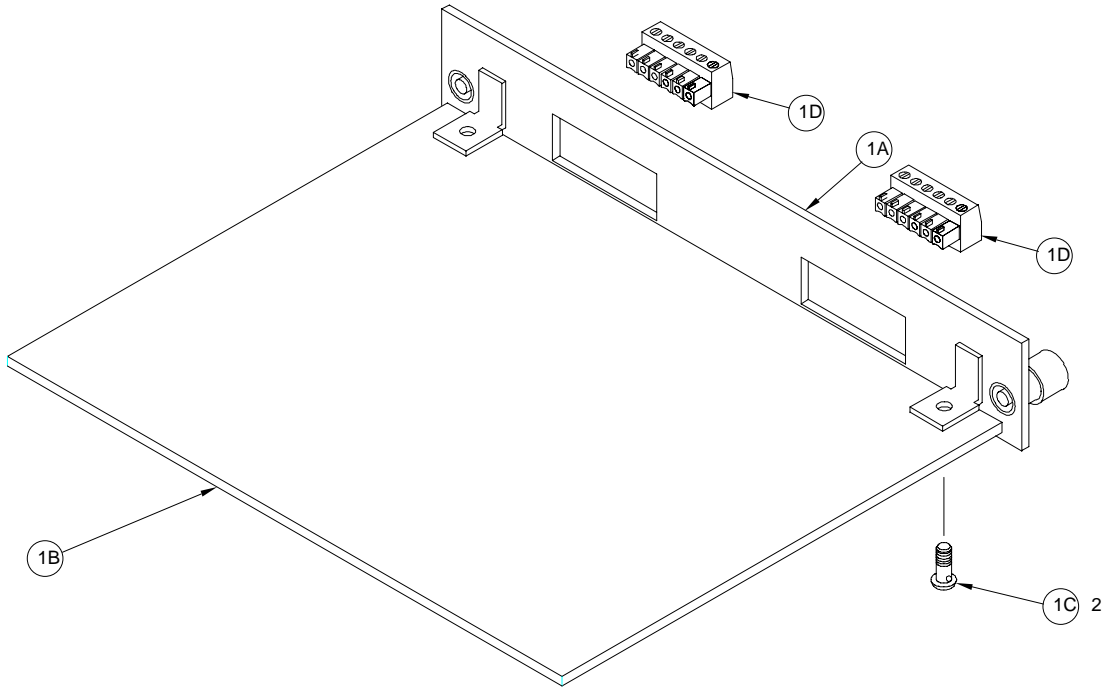

Figure 6-m: Dual Analog Output Assembly

Ref #	Part Number	Description	Qty
1A	(*)14547400A	I/O Plate, Dual Analog Output	1
1B	(*)14095000A	PCB, Dual Analog Output (w/o Hardware)	1
1C	R0511100A	Screw, M4 x 10 Tapite	2
1D	(*)13162500A	Connector, 6-Position Terminal Block	1
*	(*)14164100A	Dual Analog Output PCB/Panel Assembly	1

(*) May have a revision level prefix.

* Includes all parts listed above as an assembly.

POWERCELL PCB

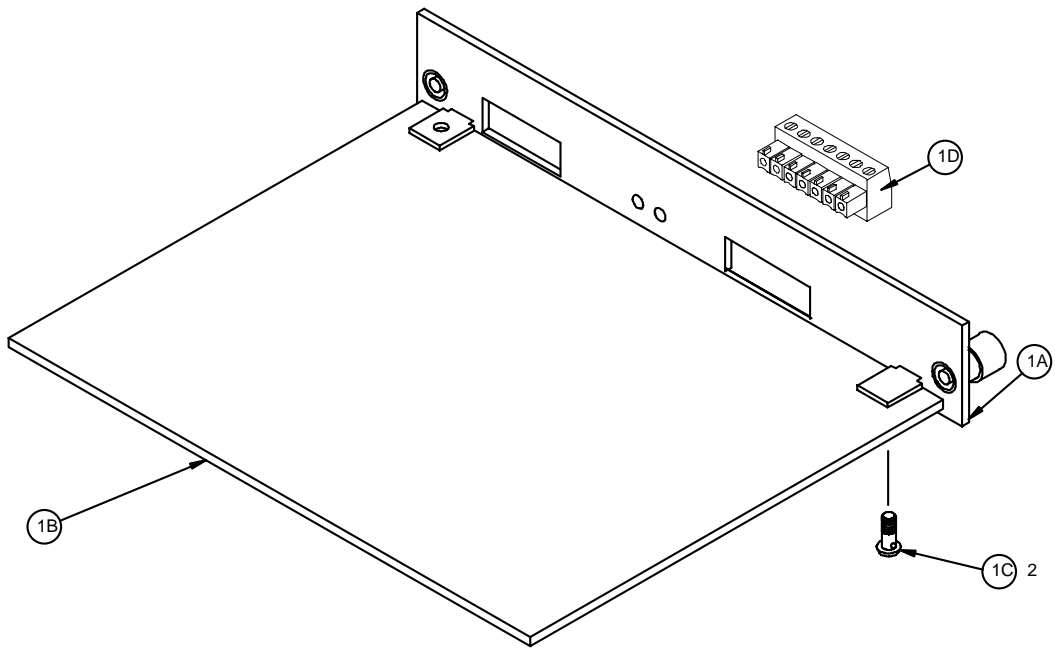

Figure 6-n: POWERCELL PCB

Ref #	Part Number	Description	Qty
1A	(*)14546100A	POWERCELL Assembly I/O Plate	1
1B	(*)14092600A	POWERCELL PCB Assembly (w/o hardware)	1
1C	R0511100A	Screw, M4 x 10, ST PHD	2
1D	(*)14113300A	Connector, 8 Pos. Terminal Block	1
Not Shown	0917-0240 14749600A	External Power Supply (for applications with more than 14 cells per POWERCELL PCB)	1
*	(*)14546200A	POWERCELL PCB Panel Assembly	1

(*) May have a revision level prefix.

* Includes all parts listed above as an assembly.

Multifunction PCB

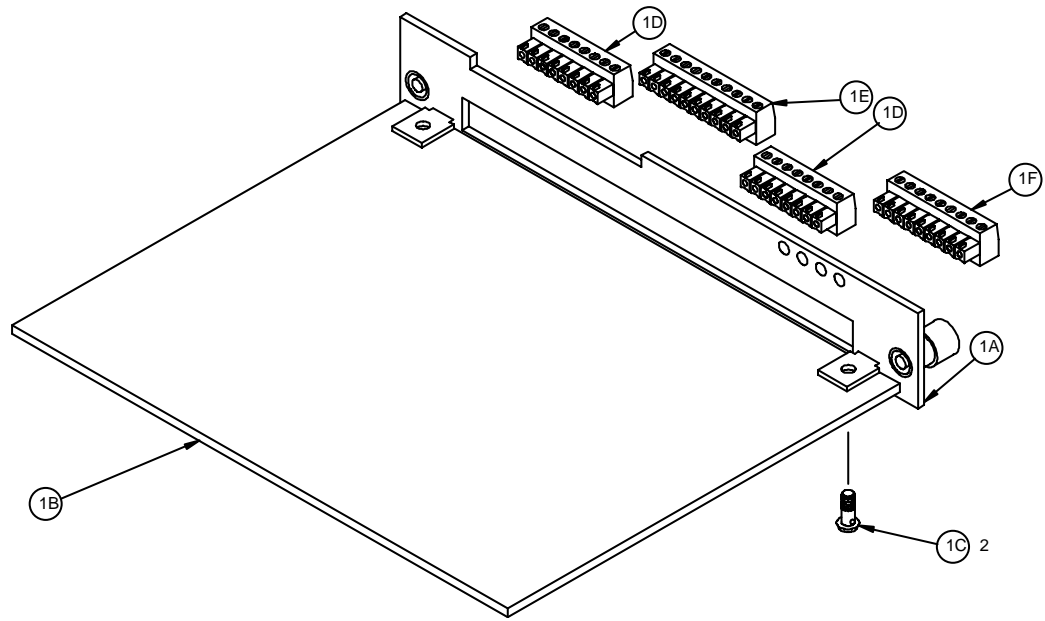

Figure 6-o: Multifunction PCB

Ref #	Part Number	Description	Qty
1A	(*)14164900A	Multifunction I/O Plate	1
1B	(*)14094200A	Multifunction PCB Assembly (w/o hardware)	1
1C	R0511100A	Screw, M4 x 10 Tapite	2
1D	(*)14113300A	Connector, 8 Pos. Terminal Block	2
1E	(*)14113400A	Connector, 10 Pos. Terminal Block	1
1F	(*)14405300A	Connector, 9 Pos. Terminal Block	1
*	(*)14164000A	Multifunction PCB Panel Assembly	1

(*) May have a revision level prefix.

* Includes all parts listed above as an assembly.

IDNET PCB

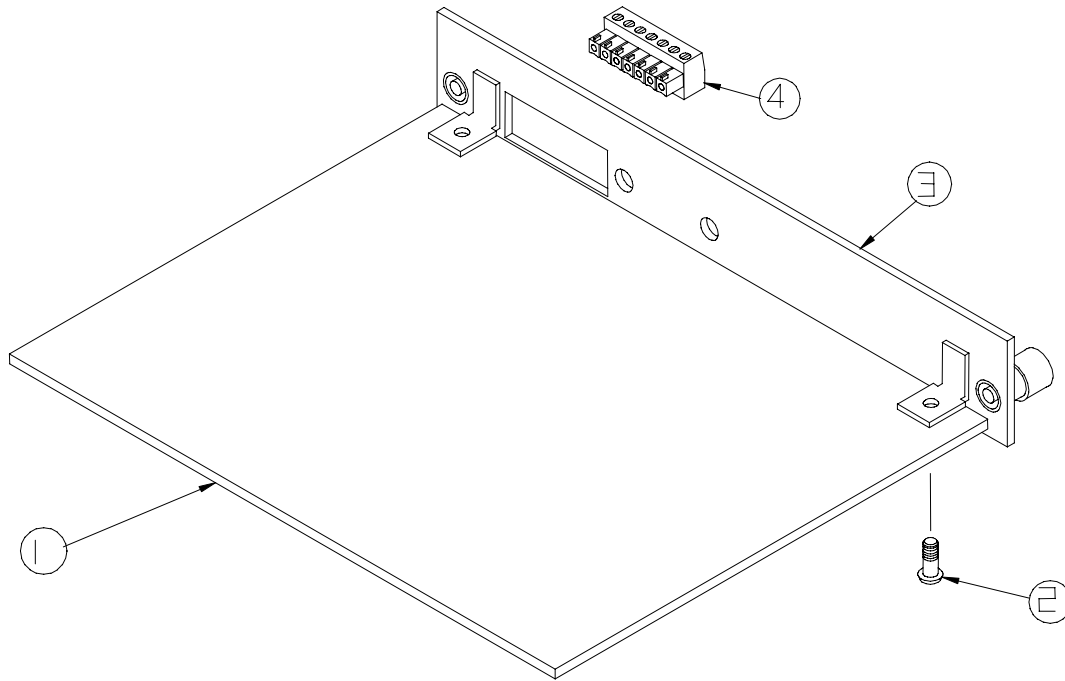

Figure 6-p: IDNET PCB Assembly

Parts List—IDNET PCB			
Ref #	Part Number	Description	Qty
1	(*)14714800A	IDNET I/F PCB (w/o hardware)	1
2	R0511100A	Screw, M4 x 10 Tapite	2
3	(*)14547300A	I/O Plate Assembly, High Precision	1
4	(*)14113200A	Connector, 7 Position Terminal Block	1
*	(*)14547500A	IDNET PCB Panel Assembly	1

(*) May have a revision level prefix.

* Includes all parts listed as a complete assembly.

Optional Accessories

Optional Accessories		
Part Number	Description	Factory Number
(*)14526100A	Wall/Column Bracket - GP Model	0917-0209
(*)14528400A	Blank Plate For Open Slot	0917-0210
(*)14512800A	Analog Load Cell Kit	0917-0211
(*)14534600A	Reduced Excitation Analog Load Cell Kit	0917-0212
(*)14510000A	Allen-Bradley Remote I/O Kit	0917-0213
(*)14528500A	Kit To Convert Blind Unit To JTPA	0917-0214
(*)13446000A	DigiTOL Load Cell Simulator	0917-0178
082451 JAG	Analog Load Cell Simulator (variable)	---
(*)14476100A	METTLER TOLEDO Screw Driver	---
(*)14411800A	2mm Allen Wrench For JTPA Models	---
(*)90093600A	RS-232/20 mA Converter	0964-0065
(*)14690100A	Multifunction Kit	0917-0223
(*)14690200A	POWERCELL Kit	0917-0224
(*)14875800A	Dual Channel Analog Output Kit	0917-0242
(*)14866600A	PROFIBUS Interface Kit	0917-0243
(*)14866500A	High Precision (IDNET) Kit	0917-0244
(*)13823300A	High Precision Cable Adapter	0900-0284
(*)15567500A	External Power Supply	0917-0240
(*)15648700A	QWERTY Keyboard	0917-0274
(*)14839500A	JagBASIC Programmer's Kit	0917-0230
(*)14863100A	PROFIBUS Pigtail Kit	0900-0311
(*)15158600A	Modbus Plus Pigtail Kit	0900-0320
(*)15035500A	PROFIBUS Type File	0917-0250
(*)13406300A	NMOS POWERCELL Aux Power Supply 100/110/120 VAC	0917-0168
(*)13406400A	NMOS POWERCELL Aux Power Supply 220/240 VAC	0917-0169
(*)15151300A	Modbus Plus Kit	0917-0254
A082568020	4 Cell POWERCELL Simulator	---

Optional Panels

Optional Panels		
Slot Number	Part Number	Description
Slot 1	(*)14163100A (*)14163300A (*)14490200A (*)14546200A (*)14517700A (*)15360300A (*)14164000A (*)14547500A	Blank Panel Assembly Analog Load Cell PCB Panel Assembly Reduced Excitation Analog PCB Panel Assembly POWERCELL PCB Panel Assembly Dual Analog Load Cell PCB Assembly Reduced Excitation Dual Analog Load Cell PCB Panel Assembly Multifunction PCB Panel Assembly High Precision PCB Panel Assembly
Slot 2	(*)14163100A (*)14163300A (*)14490200A (*)15360300A (*)14163400A (*)14164000A (*)14547500A	Blank Panel Assembly Analog PCB Panel Assembly Reduced Excitation Analog PCB Panel Assembly Reduced Excitation Dual Analog Load Cell PCB Assembly Allen Bradley I/O Panel Assembly Multifunction PCB Panel Assembly High Precision PCB Panel Assembly
Slot 3	(*)14163100A (*)14163400A (*)14164100A (*)14547700A (*)14164100A (*)14517100A	Blank Panel Assembly Allen Bradley I/O PCB Panel Assembly Multifunction PCB Panel Assembly MODBUS PLUS PCB Panel Assembly Dual Analog Out PCB Panel Assembly Profibus PCB Panel Assembly

(*) May have a revision level prefix.

Recommended Spare Parts

Recommended Spare Parts		
Part Number	Description	Qty
(*)15905900A	Controller PCB	1
(*)14200200A	Power Supply PCB	1
(*)15345400A	Analog Load Cell PCB (if used)	1
(*)14485300A	Reduced Excitation Analog PCB (if used)	1
(*)15290700A	Dual Analog PCB (if used)	1
(*)15360100A	Reduced Excitation Dual Analog PCB (if used)	1
(*)14092600A	POWERCELL PCB (if used)	1
()14094200A	Multifunction PCB (if used)	1
(*)14538600A	Keyboard Assembly	1
()14548600A	4.5 Volt Battery	1
(*)14016100A	Front Seal, Panel O-Ring	1

(*) May have a revision level prefix.

* For specific part numbers and details on each PCB, refer to the section in this chapter describing the specific PCB.

** For part numbers for the different enclosure types, refer to the enclosure assemblies in the front of this chapter.

9

Appendices

Appendix 1: Serial Interface Reference

Two serial ports are standard on the JAGXTREME industrial terminal Controller PCB. They are designated COM1 and COM2.

- COM1 provides both RS-232 and 20 mA current loop interfaces. Both types of interfaces can be output simultaneously; however, only one input can be connected.
- COM2 provides either RS-232, RS-422 or RS-485 interfaces. Both RS-232 and RS-422 can be output simultaneously; however, only one input can be connected. If RS-485 is selected for COM2, it is the only type of interface that can be used. COM2 is also used for DigiTOL scale interface. If a DigiTOL scale is connected to COM2, that port cannot be used for any other purpose.

Two additional serial ports (COM3 and COM4) are available on optional Multifunction PCB. COM3 has the same functionality as COM1 but COM 3 does not have 20mA; COM4 has the same functionality as COM2.

Character framing is programmable in the setup mode. Framing can be:

- 1 start bit
- 7 or 8 ASCII data bits (selectable)
- 0 or 1 parity bit (even, odd, or none)
- 1 stop bit

You can also configure the baud rate (from 300 to 115.2k baud) and checksum character interface parameters.

The JAGXTREME terminal uses software handshaking to control data flow commonly referred to as XON/XOFF handshaking. When a receiving device (typically a printer) is getting information from a JAGXTREME terminal and cannot receive any more in its buffer, it sends an ASCII XOFF (13h) telling the JAGXTREME terminal to temporarily stop sending data until its buffer clears.

When the device can receive more data, it sends an ASCII XON (11h) telling the JAGXTREME terminal to begin sending data again. This process can occur as often as required by receiving device.

The XON/XOFF method is the only type of handshaking supported by the JAGXTREME terminal at this time.

Hardware Connections

All connections to the serial ports on the JAGXTREME terminal are made using terminal strips. The terminal strips are removable for ease of connection or replacement of the PCB.

The general purpose enclosure has grip bushings on the rear cover to properly secure and seal around the serial cable. The panel mount enclosure has loops on the rear of the power supply assembly allowing you to secure cables with nylon wire ties.

The standard 15-foot (4.57 m) RS-232 printer cable available for the JAGXTREME terminal (Factory Number 0900-0258, part number 133218 00A) is wired as shown below:

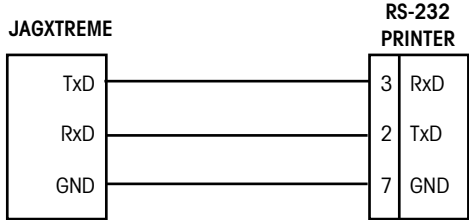

Figure A1-1: RS-232 Printer Cable Wiring

A custom cable can also be used. METTLER TOLEDO recommends using either 20 or 22 gauge wire size. The maximum cable length is determined by the interface type used. As a rule, the following limitations apply:

Cable	Maximum Length	
RS-232	50 feet	15.24 m
20 mA	1000 feet	304.8 m
RS-422	2000 feet	609.6 m
RS-485	2000 feet	609.6 m

Connections other than RS-232 are shown in the section entitled Serial Port Connections in Chapter 2. A custom cable to a computer (or other RS-232 device) should be configured as shown below:

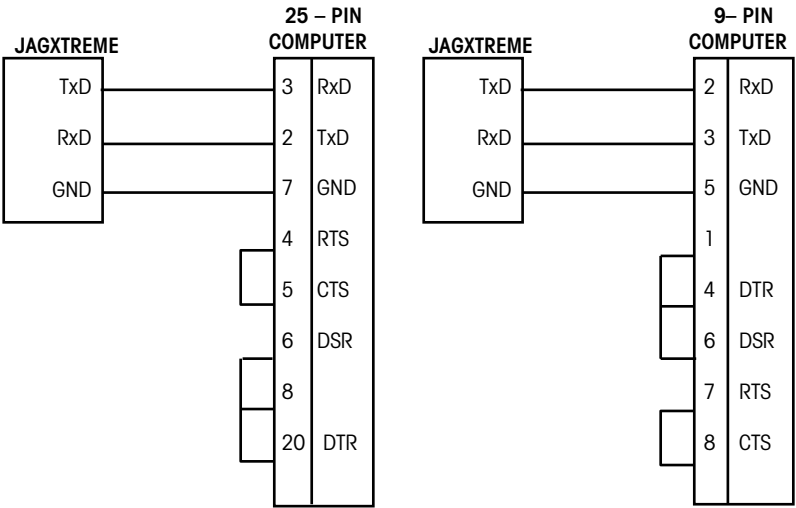

Figure A1-2: Custom Cable Configuration

Output Modes and Formats

The JAGXTREME terminal supports two different modes of data output—demand or continuous.

The demand mode transmits data only if the **ENTER** key is pressed, an auto-print command is received from the optional Allen-Bradley interface, or if discrete input IN3 is grounded. When triggered, data is transmitted in a string selected in the template editing portion of setup. If no templates are selected, a single line output of gross, tare, and net weight will be sent to the demand port. Demand mode is used typically when sending data to a printer.

Continuous mode transmits a predetermined 18-byte string of data from the serial port five or more times a second (without any request). This mode is used typically when continuous monitoring of the scale weight is required by an external device. Typically, continuous output is used to drive a remote display, scoreboard or PC interface.

If **4 Setpnt** status is selected in the Serial Interface program block, setpoints one through four will be included in the continuous output format. The first setpoint assigned to a scale becomes the first setpoint in the continuous output. For example, if the JAGXTREME terminal's setpoints 5 through 8 are assigned to scale A, then setpoints 5 through 8 are mapped to continuous setpoint bits 1 through 4.

The continuous output format is the same for standard mode and 4-setpoint status mode. This format is shown below:

STX	SW A	SW B	SW C	X	X	X	X	X	X	X	X	X	X	X	X	CR	CKS
1	2 STATUS BYTES			3 GROSS / NET WEIGHT						4 TARE WEIGHT				5	6		

Table Notes

1. <STX> ASCII Start of Text Character, Hex 02.
2. <SWA>, <SWB>, <SWC> Status Word Bytes A, B, and C. Refer to the Bit Identification Tables for individual bit definition.
3. Displayed weight, either Gross or Net weight. Six digits, no decimal point or sign. Non-significant leading zeros are replaced with spaces.
4. Tare weight. Six digits, no decimal point or sign.
5. <CR> ASCII Carriage Return, Hex 0d.
6. <CKS> Checksum character, 2's complement of the 7 low order bits of the binary sum of all characters on a line preceding the checksum, including the STX and CR.

Standard Status Bytes A, B, and C

The mode of operation for the status bytes A, B, and C (standard or 4-setpoint) is determined when the continuous connection is made in the Configure Serial program block.

The following tables detail the standard status bytes for continuous output.

Bit Identification Table for Status Byte A			
Bits 0, 1, and 2			
0	1	2	Decimal Point Location
0	0	0	XXXX00
1	0	0	XXXXX0
0	1	0	XXXXXX
1	1	0	XXXXX.X
0	0	1	XXXX.XX
1	0	1	XXX.XXX
0	1	1	XX.XXXX
1	1	1	X.XXXXX
Bits 3 and 4			Build Code
3	4		
1	0		X1
0	1		X2
1	1		X5
Bit 5			Always = 1
Bit 6			Always = 0

Bit Identification Table for Status Byte B	
Status Bits	Function
Bit 0	Gross = 0, Net = 1
Bit 1	Sign, Positive = 0, Negative = 1
Bit 2	Out of Range = 1 (Over capacity or Under Zero)
Bit 3	Motion = 1
Bit 4	lb = 0, kg = 1 (see also Status Byte C, bits 0-2)
Bit 5	Always = 1
Bit 6	In Power Up = 1

Bit Identification Table for Status Byte C			
Bits 0, 1, and 2			Weight Description
0	1	2	
0	0	0	lb or kg, selected by Status Byte B, bit 4 Grams (g)
1	0	0	
Bit 3			Print Request = 1
Bit 4			Expand Data x 10 = 1
Bit 5			Always = 1
Bit 6			Always = 0

4-Setpoint Status Bytes A, B, and C

The mode of operation for the status bytes A, B, and C (standard or 4-setpoint) is determined when the continuous connection is made in the configure Serial program block.

The following tables detail the 4-setpoint status bytes for continuous output.

Bit Identification Table for Status Byte A			
Bits 0, 1, and 2			
0	1	2	Decimal Point Location
0	0	0	XXXX00
1	0	0	XXXXX0
0	1	0	XXXXXX
1	1	0	XXXXX.X
0	0	1	XXXX.XX
1	0	1	XXX.XXX
0	1	1	XX.XXXX
1	1	1	X.XXXXX
Bit 3	Setpoint 1 (1st assigned to this scale), Feeding = 0		
Bit 4	Setpoint 2 (2nd assigned to this scale), Feeding = 0		
Bit 5	Always = 1		
Bit 6	Setpoint 3 (3rd assigned to this scale), Feeding = 0		

Bit Identification Table for Status Byte B	
Status Bits	Function
Bit 0	Gross = 0, Net = 1
Bit 1	Sign, Positive = 0, Negative = 1
Bit 2	Out of Range = 1 (Over capacity or Under Zero)
Bit 3	Motion = 1
Bit 4	lb = 0, kg = 1 (see also Status Byte C, bits 0-2)
Bit 5	Always = 1
Bit 6	In Power Up = 1

Bit Identification Table for Status Byte C			
Bits 0, 1, and 2			Weight Description
0	1	2	
0	0	0	lb or kg, selected by Status Byte B, bit 4
1	0	0	Grams (g)
Bit 3	Print Request = 1		
Bit 4	Setpoint 4 (4th assigned to this scale), Feeding = 0		
Bit 5	Always = 1		
Bit 6	Always = 0		

Multi Cont 1

This continuous output is used with multi-scale scoreboards (except 8616). The string consists of separate messages for every enabled scale and the sum of the structure for each scale's message is shown below:

ADR	SW A	SW B	SW C	X	X	X	X	X	X	X	X	X	X	X	X	CR	CKS
1	2 STATUS BYTES			3 GROSS / NET WEIGHT						4 TARE WEIGHT						5	6

Table Notes

1. ASCII Character in hex that represents the scale address 01=scale A, 02=scale B, 03=scale C, 04=scale D, 05=scale E (sum)
2. <SWA>, <SWB>, <SWC> Status Word Bytes A, B, and C. Refer to the Standard Bit Identification Tables for individual bit definition.
3. Displayed weight, either Gross or Net weight. Six digits, no decimal point or sign. Non significant leading zeros are replaced with spaces.
4. Tare weight. Six digits, no decimal point or sign.
5. <CR> ASCII Carriage Return, Hex 0d.
6. <CKS> Checksum character, 2's complement of the 7 low order bits of the binary sum of all characters on a line preceding the checksum, including the STX and CR.

Multi Cont 2

This continuous output is used with multi-scale remote displays and 8618 scoreboard (set for protocol P:22). The string consists of separate messages for every enabled scale and the sum of the structure for each scale's message is shown below:

STX	SW A	SW B	SW C	X	X	X	X	X	X	X	X	X	X	X	X	CR	CKS
1	2 STATUS BYTES			3 GROSS / NET WEIGHT						4 TARE WEIGHT						5	6

Note: The scale must be set up for sum and cannot have continuous output selected on any other port.

Table Notes

1. <STX> ASCII Start of Text Character, Hex 02.
2. <SWA>, <SWB>, <SWC> Status Word Bytes A, B, and C. Refer to the Bit Identification Tables for individual bit definition.
3. Displayed weight, either Gross or Net weight. Six digits, no decimal point or sign. Non-significant leading zeros are replaced with spaces.
4. Tare weight. Six digits, no decimal point or sign.
5. <CR> ASCII Carriage Return, Hex 0d.
6. <CKS> Checksum character, 2's complement of the 7 low order bits of the binary sum of all characters on a line preceding the checksum, including the STX and CR.

The following tables detail the standard status bytes for continuous output.

Bit Identification Table for Status Byte A				
Bits 0, 1, and 2				
0	1	2	Decimal Point Location	
0	0	0	XXXX00	
1	0	0	XXXXX0	
0	1	0	XXXXXX	
1	1	0	XXXXX.X	
0	0	1	XXXX.XX	
1	0	1	XXX.XXX	
0	1	1	XX.XXXX	
1	1	1	X.XXXXX	
Bits 3 and 4			Build Code	
3	4			
1	0			X1
0	1			X2
1	1			X5
Bit 5			Always = 1	
Bit 6			Always = 0	

Bit Identification Table for Status Byte B	
Status Bits	Function
Bit 0	Gross=0, Net=1
Bit 1	Sign, Positive=0, Negative=1
Bit 2	Out of Range =1 (Over capacity or under zero)
Bit 3	Motion=1
Bit 4	lb=0, kg=1 (see also Status Byte C, bits 0-2)
Bit 5	Always=1
Bit 6	In Power Up=1

Bit Identification Table for Status Byte C			
Bits 0- 2			Weight Description
0	1	2	
1	0	0	Scale A
0	1	0	Scale B
1	1	0	Scale C
0	0	1	Scale D
1	0	1	Scale E (Sum)
Bit 3			Print Request=1
Bit 4			Expand Data x 10= 1
Bit 5			Always=1
Bit 6			Always=0

Default Template Formats

Default templates 1 through 4 contain weight data from Scale A only. Template 5 contains weight data from Scale B only. Do not select template 5 unless you have a scale B or unless you have cleared template 5 and created your own format using an existing scale.

Template 1

Gross Weight: XX.XX lb
Tare Weight: XX.XX lb
Net Weight: XX.XX lb

Template 2

Current Date	Current Time	Scale ID
Gross Weight:	XX.XX lb	
Tare Weight:	XX.XX lb	
Net Weight:	XX.XX lb	

Template 3

Current Date	Current Time	Scale ID CN
Literal #1		
Literal #2		
Gross Weight:	XX.XX lb	
Tare Weight:	XX.XX lb	
Net Weight:	XX.XX lb	

Template 4

Current Date	Current Time	Scale ID CN
Literal #1		
Literal #2		
Literal #3		
Prompt #1	Response #1	
Prompt #2	Response #2	
Prompt #3	Response #3	
Prompt #4	Response #4	
Gross Weight:	XX.XX lb	
Tare Weight:	XX.XX lb	
Net Weight:	XX.XX lb	

Template 5

Template 5 is the same as Template 3 except Template 5 contains weight data from summing scale.

Current Date	Current Time	Scale ID CN
Literal #1		
Literal #2		
Gross Weight:		XX.XX lb
Tare Weight:		XX.XX lb
Net Weight:		XX.XX lb

You can use the JAGXTREME terminal and weight data in templates. The JAGXTREME terminal's templates are limited to 400 characters. The total number of characters used by each template can be calculated using the following chart:

Print Field	Space Used
JAGXTREME Data Field	7 characters
ASCII Character	1 character
Special ASCII Character	1 character
Justify a Field	2 characters + justify letter (L, R, C) + space limit (1, 2, or 3 characters)
CR/LF Characters	6 characters + quantity (1 or 2)
Repeat Character	5 characters

Consider the following example where a customer ticket has three centered literals in a 40 character-wide field, and an asterisk underline. You can calculate how much of the template remains for field data as follows:

MAXINE'S SHIPPING SERVICES
BOXES ● PACK ● SHIP ● FAX
GREAT PRICES

The space required for this ticket heading information is

Character Description	Character Total
Literal 1	7 (JAGXTREME data field)
Centered (Justify in 40 character field)	2 + 1 (letter C) + 2 (two digits for quantity 40)
CR/LF	6 + 1 (one digit for quantity 1)
Total space required (each line)	19
Total for all three lines (19 x 3)	57
ASCII (*)	1 (ASCII character)
Repeat (*) 40 times	5 (repeat function)
CR/LF	6 + 1 (one digit for quantity 1)
Total space for line of asterisks	13
Grand total of characters (57 + 13)	70
Therefore 330 characters remain in this template (400-70)	

The following hints apply to template space calculation:

- Regardless of the number of characters in a JAGXTREME terminal's data field, a template uses only seven characters (the field code).
- Use the CR then the LF special ASCII characters (two characters) instead of the CR/LF combination (7 to 8 characters).
- Justification uses four to six characters that are not used if the field remains unjustified.

Input Modes

ASCII control characters can be sent in upper or lower case.

Characters other than those listed at right are ignored.

If a scale designation character (A or B) is used, it must be followed by the command character(s) within three seconds or the command will be discarded.

This section gives additional information pertaining to the CTPZSU, Bar Code, and Keyboard input modes supported by the JAGXTREME terminal.

CTPZSU In Remote ASCII Control Character Input

The Serial Interface program block gives you the option of configuring a CTPZSU In serial connection that allows the JAGXTREME terminal to perform several basic functions when a control character is received. Remote ASCII control characters and the JAGXTREME terminal's responses include:

- C**—clears the scale to gross
- T**—tares the scale
- P**—initiates a print command
- Z**—zeros the scale
- S**—selects a scale
- U1**—selects primary units
- U2**—selects secondary units

The ASCII control character pertains to the scale currently selected unless a scale designation character is included in the ASCII control command. You can specify a scale to receive the control character by preceding the command character(s) with the designation A, B, C, D or E.

For example, to take a Pushbutton tare on scale A regardless of which scale is selected, send the command AT. Alternately, the command BT takes a Pushbutton tare on scale B regardless of the selected scale.

You can enter Keyboard Tare by preceding the "T" with a numeric value. For example, 10.5T enters a tare value of 10.5 on the currently selected scale. For two scales, enter Keyboard Tare using the designation A, B, or E before the tare value. For example, A2000T enters a tare of 2000 on Scale A. If there is no preceding numeric value, "T" causes a Pushbutton Tare.

Bar Code In

The JAGXTREME terminal supports serial data input from bar code readers if the serial type connection is configured as Serial or Both in the Configure Port Sub-block.

The bar code reader must be a type that sends decoded bar code data as ASCII, and RS-232 data as an output string. Most bar code readers are of this type.

Power to the bar code reader can be supplied by the reader vendor as an auxiliary power supply, or power can be supplied by the JAGXTREME terminal through the PAR 2 connector on the controller board (5 VDC, 115 mA maximum current).

Keyboard In

The JAGXTREME terminal supports serial input that emulates keyboard input. The serial characters are received and acted upon exactly as if using a keyboard. The terminal's operating mode is important because it can affect how the input is read. For example, the "Enter" serial character received in normal operating mode has a different result than if that same character is received when the JAGXTREME terminal is in setup mode. The following serial characters are received:

Serial Character	JAGXTREME Key Emulated
0-9	Numeric Keys
A-Z, ?, \$, #, %, -, /, =, *, (,)	Alpha Keys
Ctrl + A*	FUNCTION
Ctrl + B*	ESCAPE
Ctrl + C*	MEMORY
Ctrl + D*	TARE
Ctrl + E*	SELECT
Ctrl + F*	CLEAR
Ctrl + G*	ZERO
Ctrl + H*	ENTER
Other printable characters	May be input to prompts that accept alpha-numeric input
Non-printable characters	Not used

* Press and hold the Control (Ctrl) key as you press the desired function letter key.

TDC3000 Protocol

The JAGXTREME terminal also supports TDC3000 connections as described below.

- **TDC3000 Communications Specifications**—The JAGXTREME terminal supports up to two TDC3000 connections (one for each scale). Using the Serial Setup menus, the operator may connect each scale to a specific serial port that supports the TDC3000 protocol.
- **Physical Channel**—The serial channel is an EIA RS 232 C, point-to-point connection, using the Transmit, Receive, and Ground pins. The baud rate is 9600 bits per second; character format is 7 data bits + even parity. There is no flow control.
- **Setpoint Operation**—The terminal supports two setpoints for each TDC3000 connection, a coincidence weight setpoint and a rate alarm setpoint. The TDC3000 Host loads the values of these setpoints using the "S" and "A" commands. The Host must also send the "M" command to indicate whether the coincidence weight setpoint is in "filling" or "discharging" mode. In the JAGXTREME terminal, setpoints 1 and 2 are the coincidence and alarm setpoints for Scale A; and setpoints 3 and 4 are the coincidence and alarm setpoints for Scale B.

The terminal does not activate the coincidence setpoint until it receives the "B" command. The TDC3000 Host may frequently send setpoint "S" commands to change the value of the coincidence weight. In filling mode, while the terminal weight is less than the current coincidence weight, the terminal turns on the "feed output". Once the terminal weight is greater or equal to the current coincidence weight, the terminal turns off the "feed output" and "latches" it. That is, the terminal will only turn on the "feed output" again when the terminal receives another "B" command from the host. The terminal turns on the "alarm setpoint output" when the flow rate exceeds the alarm setpoint rate.

- **Single-Character Host Commands**

Format: X (1 character message)

where X =	W-Send Weight Command
	R-Send Flow Rate Command
	B-Begin Feeding Command
	D-Send Decimal Point Location Command

When the terminal receives the "W" command, the terminal responds back with the Weight Message defined later.

When the terminal receives the "R" command, the terminal responds back with the Flow Rate Message defined later.

When the terminal receives the "B" command, the terminal turns on the setpoints, restarts the rate calculation, and sends an <ACK>.

When the terminal receives the "D" command, the terminal responds with a message containing the number of digits to the right of the decimal point in weight messages plus one. The format of the message is:

<D> <NUMBER OF DIGITS + 1> <BCC>

When the terminal does not recognize the Host message, it does not respond.

- **Host Setpoint Download Messages**

Format: XmmmmmmC (8 character message)

where X =	S-Setpoint Download Command
	A-Alarm Rate Download Command
mmmmmm =	Setpoint or Alarm Value (i.e. 051253 for 5,125.3 lbs.)
C=	Block Check Character

When the terminal receives the "S" or "A" command, the terminal loads the new coincidence weight setpoint or alarm rate setpoint value, respectively, and responds with an <ACK>. The setpoint and alarm values have an implied decimal point that the terminal specifies when it responds to the "D" command. For example, if there is one digit to the right of the decimal point is specified in the "D" message, the "S" message value of "051253" becomes 5125.3 pounds.

If the terminal does not receive or recognize an entire message, the terminal will send a <NAK> after 0.1 seconds of no activity on the receive line.

- **Host Filter Selection Command**

Format: XmC (3 character message)

where X=	F-Filter Message Command
m=	Filter Selection (0 to 4)
C=	Block Check Character

Upon receiving this, the terminal takes no action but responds with an ACK.

- **Host Setpoint Mode Selection**

Format: XmC (3 character message)

where X=	M-Mode Message Command
m=	A-Ascending or Filling Cutoff Mode
	D-Descending or Discharging Cutoff Mode
C=	Block Check Character

When the terminal receives the "M" command, the terminal sets the mode of the setpoint and responds with an <ACK>.

If the terminal does not receive or recognize an entire message, the terminal will send a <NAK> after 0.1 seconds of no activity on the receive line.

- **Terminal Weight and Flow Rate Messages**

Format: XmmmmmmfC (9 character message)

where X=	W-Gross Weight Value Message
	R-Flow Rate Value Message
mmmmmm=	Weight or Flow Value (i.e. 051253 for 5,125.3 lbs.)
	UUUUUU if weight is under zero
	HHHHHH if weight is over capacity
f=	A-if the alarm setpoint is on.
	F-Setpoint Output On (Feeding)
	X-Setpoint Output Off
C=	Block Check Character

When the terminal receives the "W" or "R" command, the terminal responds back with the appropriate message. There is no decimal point in the message, but its position is specified in the terminal's response to the "D" command.

The host system uses the block check to determine if it received the message correctly; however, it does not send an <ACK> or <NAK>. If the message is wrong, the host makes a new request.

- **Block Check Characters**

The Block Check Character (BCC) is the binary sum of the lower 7 bits of the message characters. The BCC is sent with even parity, as other message characters.

BasTerminal Protocol

The JagBASIC commands and special keys used with the BasTerminal are listed below.

- **TPRINT command**

You can output messages to the BasTerminal from a BASIC application using the TPRINT command. It has the same syntax as the PRINT and LPRINT commands.

For example, this is a simple program for entering data and echoing it to BasTerminal using the inkey\$ function and tprint.

```

10 tprint "enter line"           70 x$=x$+c$
20 x$=""                       80 goto 30
30 c$=inkey$                   90 tprint ""
40 if c$="" then goto 30        100 nt "input line= ";x$
50 if c$=chr$(08) then goto 90 110 goto 10
60 tprint c$;
```

- **Configuring LPRINT**

The Configure Serial menus also allow you to setup the LPRINT device for JagBASIC. The LPRINT device is the first demand print port for Scale A. When you assign the LPRINT device and the BasTerminal connection to the same serial port, then that serial port operates as an interactive serial port for JagBASIC.

- **Special Keys**

BasTerminal translates the following standard serial input keys to these JAGXTREME internal key values.

Serial input character		Translated JAGXTREME character	
backspace	0x08	delete	0x7f
tab	0x09	select	0x05
escape	0x1b	escape	0x02
enter	0x0d	enter	0x08

You can use these following keys on a standard serial keyboard to simulate the function keys on the JAGXTREME terminal's keypad.

Ctrl+a function
Ctrl+b escape
Ctrl+c memory
Ctrl+d tare
Ctrl+e select
Ctrl+f clear
Ctrl+g zero
Ctrl+h enter

- **Sending and Receiving Files**

Two JagBASIC commands allow you to exchange JagBASIC files between a JAGXTREME and a PC running a terminal emulator. The JagBASIC command "rz" initiates receiving files at the JAGXTREME terminal from a PC using the ZMODEM protocol over the BasTerminal serial communication line. The JagBASIC command "sz" initiates sending files from the JAGXTREME terminal to a PC. If you want to use the rz and sz commands from the BasTerminal, you need to set up the serial communications to use the "8 bits, No Parity" data format.

ASCII Characters

The charts on the following pages list the ASCII Standard and Control characters and ASCII Special characters that are used in the JAGXTREME terminal's templates.

The first chart below gives replacement characters for display (and printing) purposes depending on the character set selected in the Application Environment program block (see Chapter 3) and the printer setup selection.

The second chart, ASCII Standard and Control Characters, gives the ASCII character, decimal (Dec.), and hexadecimal (Hex.) value for each ASCII character from 00 to 127 hex.

The third chart, ASCII Characters in Special Character Set, gives the ASCII character, name, and hexadecimal (Hex.) value for the characters that can be used as "special characters" in template programming. These include all of the characters not already available on the standard JAGXTREME terminal's keypad.

ASCII Character (Hexadecimal)												
Country	23h	24h	40h	5Bh	5Ch	5Dh	5Eh	60h	7Bh	7Ch	7Dh	7Eh
USA	#	\$	@	[\]	^	`	{		}	~
France	#	\$	à	°	ç	§	^	`	é	ù	è	¨
Germany	#	\$	§	Ä	Ö	Ü	^	`	ä	ö	ü	ß
England	£	\$	@	[\]	^	`	{		}	~
Denmark-1	#	\$	@	Æ	Ø	Å	^	`	æ	ø	å	~
Sweden	#	α	É	Ä	Ö	Å	Ü	é	ä	ö	å	ü
Italy	#	\$	@	°	\	é	^	ù	à	ò	è	ì
Spain-1	₠	\$	@	ı	Ñ	¿	^	`	¨	ñ	}	~
Japan	#	\$	@	[¥]	^	`	{		}	~
Norway	#	α	É	Æ	Ø	Å	Ü	é	æ	ø	å	ü
Denmark-2	#	\$	É	Æ	Ø	Å	Ü	é	æ	ø	å	ü
Spain-2	#	\$	á	ı	Ñ	¿	é	`	ı	ñ	ó	ú
Latin Am.	#	\$	á	ı	Ñ	¿	é	ü	ı	ñ	ó	ú

ASCII Standard and Control Characters											
Char.	Dec.	Hex.	Char.	Dec.	Hex.	Char.	Dec.	Hex.	Char.	Dec.	Hex.
NUL	0	00	SP	32	20	@	64	40	`	96	60
SOH	1	01	!	33	21	A	65	41	a	97	61
STX	2	02	"	34	22	B	66	42	b	98	62
ETX	3	03	#	35	23	C	67	43	c	99	63
EOT	4	04	\$	36	24	D	68	44	d	100	64
ENQ	5	05	%	37	25	E	69	45	e	101	65
ACK	6	06	&	38	26	F	70	46	f	102	66
BEL	7	07	'	39	27	G	71	47	g	103	67
BS	8	08	(40	28	H	72	48	h	104	68
HT	9	09)	41	29	I	73	49	i	105	69
LF	10	0A	*	42	2A	J	74	4A	j	106	6A
VT	11	0B	+	43	2B	K	75	4B	k	107	6B
FF	12	0C	,	44	2C	L	76	4C	l	108	6C
CR	13	0D	-	45	2D	M	77	4D	m	109	6D
SO	14	0E	.	46	2E	N	78	4E	n	110	6E
SI	15	0F	/	47	2F	O	79	4F	o	111	6F
DLE	16	10	0	48	30	P	80	50	p	112	70
DC1	17	11	1	49	31	Q	81	51	q	113	71
DC2	18	12	2	50	32	R	82	52	r	114	72
DC3	19	13	3	51	33	S	83	53	s	115	73
DC4	20	14	4	52	34	T	84	54	t	116	74
NAK	21	15	5	53	35	U	85	55	u	117	75
SYN	22	16	6	54	36	V	86	56	v	118	76
ETB	23	17	7	55	37	W	87	57	w	119	77
CAN	24	18	8	56	38	X	88	58	x	120	78
EM	25	19	9	57	39	Y	89	59	y	121	79
SUB	26	1A	:	58	3A	Z	90	5A	z	122	7A
ESC	27	1B	;	59	3B	[91	5B	{	123	7B
FS	28	1C	<	60	3C	\	92	5C		124	7C
GS	29	1D	=	61	3D]	93	5D	}	125	7D
RS	30	1E	>	62	3E	^	94	5E	~	126	7E
US	31	1F	?	63	3F	_	95	5F		127	7F

ASCII Standard and Control Characters											
Char.	Dec.	Hex.	Char.	Dec.	Hex.	Char.	Dec.	Hex.	Char.	Dec.	Hex.
Ç	128	80	á	160	A0	lb	192	C0	°	248	F8
ü	129	81	í	161	A1		193	C1	¨	249	F9
é	130	82	ó	162	A2		194	C2		250	FA
ã	131	83	ú	163	A3		195	C3	§	251	FB
ä	132	84	ñ	164	A4	oz	196	C4		252	FC
à	133	85	Ñ	165	A5		197	C5		253	FD
â	134	86		166	A6		198	C6		254	FE
ç	135	87		167	A7		199	C7		255	FF
	136	88	¿	168	A8		224	E0			
ë	137	89		169	A9	ß	225	E1			
è	138	8A		170	AA		226	E2			
ï	139	8B		171	AB		227	E3			
î	140	8C		172	AC		228	E4			
ì	141	8D	¡	173	AD		229	E5			
Ä	142	8E	«	174	AE		230	E6			
Å	143	8F	»	175	AF		231	E7			
É	144	90		176	B0		232	E8			
æ	145	91		177	B1		233	E9			
Æ	146	92		178	B2		234	EA			
ô	147	93		179	B3		235	EB			
ö	148	94		180	B4		236	EC			
ò	149	95		181	B5		237	ED			
û	150	96		182	B6		238	EE			
ù	151	97		183	B7		239	EF			
_	152	98		184	B8	•	240	F0			
ö	153	99		185	B9	•	241	F1			
Û	154	9A		186	BA	•	242	F2			
	155	9B		187	BB		243	F3			
	156	9C		188	BC	∅	244	F4			
	157	9D		189	BD	ø	245	F5			
Pt	158	9E		190	BE	•	246	F6			
f	159	9F		191	BF		247	F7			

ASCII Characters in Special Character Set

Char.	Name	Hex.	Char.	Name	Hex.	Char.	Name	Hex.
NUL	Null	00	SP	Space	20	`	Left Single Quote	60
SOH	Start of Header	01	!	Exclamation	21	a		61
STX	Start of Text	02	"	Quote	22	b		62
ETX	End of Text	03	#	Number Sign	23	c		63
EOT	End of Trans.	04	\$	Dollar	24	d		64
ENQ	Enquire	05	%	Percent	25	e		65
ACK	Acknowledge	06	&	Ampersand	26	f		66
BEL	Bell	07	'	Apostrophe	27	g		67
BS	Backspace	08	(Left Parenthesis	28	h		68
HT	Horizontal Tab	09)	Right Parenthesis	29	i		69
LF	Line Feed	0A	*	Asterisk	2A	j		6A
VT	Vertical Tab	0B	+	Plus	2B	k		6B
FF	Form Feed	0C	,	Comma	2C	l		6C
CR	Carriage Return	0D	-	Hyphen	2D	m		6D
SO	Shift Out	0E	.	Period	2E	n		6E
SI	Shift In	0F	/	Forward Slash	2F	o		6F
DLE	Data Link Escape	10	:	Colon	3A	p		70
DC1	Device Control 1	11	;	Semicolon	3B	q		71
DC2	Device Control 2	12	<	Less Than	3C	r		72
DC3	Device Control 3	13	=	Equal	3D	s		73
DC4	Device Control 4	14	>	Greater Than	3E	t		74
NAK	Negative Ack.	15	?	Question	3F	u		75
SYN	Synchronous Idle	16	@	At	40	v		76
ETB	End Trans. Block	17	[Left Bracket	5B	w		77
CAN	Cancel	18	\	Back Slash	5C	x		78
EM	End of Medium	19]	Right Bracket	5D	y		79
SUB	Substitute	1A	^	Caret	5E	z		7A
ESC	Escape	1B	_	Underline	5F	{	Left Brace	7B
FS	Field Separator	1C					Pipe	7C
GS	Group Separator	1D				}	Right Brace	7D
RS	Record Separator	1E				~	Tilde	7E
US	Unit Separator	1F				DEL	Delete	7F

Appendix 2: Discrete I/O Reference

The JAGXTREME terminal has a discrete I/O port with four input terminals and four setpoint output terminals on the controller board. The default input assignments are:

- IN1—Clear
- IN2—Tare
- IN3—Print
- IN4—Zero

These input assignments can be changed in the Configure Discrete program block in setup.

The default outputs represent Setpoints 1, 2, 3, and 4 respectively. Outputs are configured in the Configure Discrete program block in setup.

Inputs

The inputs are TTL compatible and are capable of handling from 5- to 30-volt DC signals. To initiate one of the inputs, you must ground the input terminal for the desired function and hold the input at logic ground level for at least 100 ms. The inputs are leading edge triggered. The maximum recommended "ON" time for an input is 1 second.

It is not necessary to supply any voltage to the inputs when not triggering (grounding). Internally, a 5-volt power supply with a pull-up resistor keeps the inputs in the "OFF" condition.

Because the signals are low level, the maximum recommended distance between the JAGXTREME terminal and the device triggering the input (a switch or relay contact) is 10 feet (3 meters) or less. The JAGXTREME terminal has an internal diagnostic test to verify that each input is functional. The following diagram shows a typical wiring scheme.

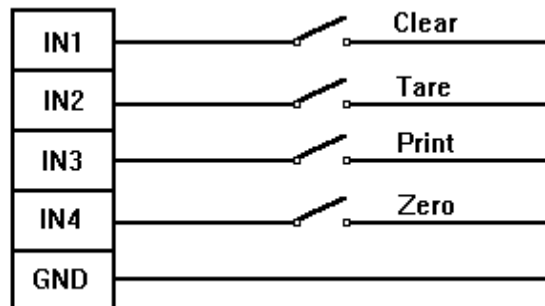

Outputs

The outputs are TTL compatible, current-sinking components, which can handle from 5- to 30-volt DC signals at a maximum of 35 mA current. A solid-state relay or Opto 22 is typically connected to buffer the JAGXTREME outputs to a 120 or 220-volt AC signal.

An output terminal supplies a 5 volt DC signal for reference to the setpoint outputs. Because the supply is rated at 115 mA of DC current, make sure that the current draw from the devices used (relays or optos) do not exceed this limit. If the calculated current draw exceeds 115 mA, an external power supply is required. External power supplies are available from your authorized METTLER TOLEDO representative.

The outputs are negative true and "ON" when the displayed weight is below the setpoint coincidence value. The setpoints operate on the absolute value of the setpoint value so they can be used for weigh-in and weigh-out processes. There are no interlocks or relay logic included with the standard JAGXTREME terminal. If start-stop logic is required, METTLER TOLEDO recommends that you purchase this hardware (and design) through your local authorized METTLER TOLEDO representative.

The JAGXTREME terminal has an internal diagnostic test to verify that each output is functional. The following diagram shows a typical wiring scheme.

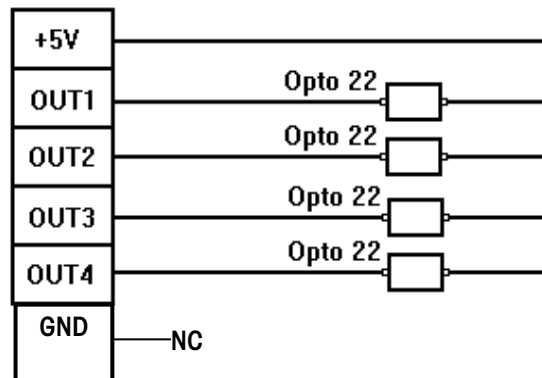

Output Wiring Example

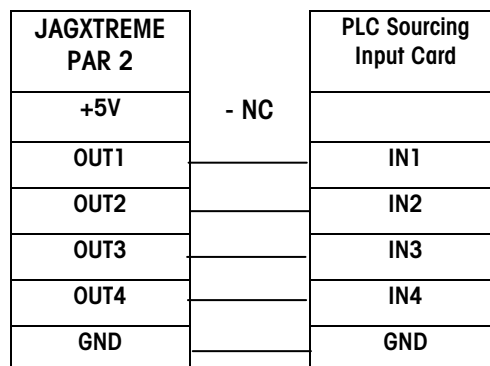







PLC Input Wiring Example

Appendix 3: Network Reference

The JAGXTREME terminal provides an Ethernet local area network connection. This connection allows JAGXTREME terminals to be combined to share display/keyboards and serial ports, and to exchange data with personal computers and file servers.

Keyboard/Display Sharing

Cluster IP Example Setup Chart

Description	Term #1	Term #2	Term #3	Term #4	Term #5	Term #6	Network Hub
Standard Ethernet RJ-45							
IP Address	200.200.200.201	200.200.200.202	200.200.200.203	200.200.200.204	200.200.200.205	200.200.200.206	N/A
Sub-Net Mask	255.255.255.000	255.255.255.000	255.255.255.000	255.255.255.000	255.255.255.000	255.255.255.000	N/A
Gateway	000.000.000.000	000.000.000.000	000.000.000.000	000.000.000.000	000.000.000.000	000.000.000.000	N/A
Net Console	Y	Y	Y	Y	Y	Y	N/A
Web Server	Y	Y	Y	Y	Y	Y	N/A
PC Data Access	Y	Y	Y	Y	Y	Y	N/A

You can press **ESCAPE** at the JAGXTREME 2 terminal to unlock the keyboard when another JAGXTREME controls the terminal.

Any JAGXTREME terminal that has a keyboard/display may be used to interact with any other JAGXTREME terminal in its cluster. A JAGXTREME terminal with the keyboard/display must be configured as a network console, and it must be set up to have access to the other JAGXTREME terminals. If Terminal 1 is to be used as a network console and can access Terminals 2, 3, and 6, Terminal 1 will be set up as follows:

Terminal 1 Network Set Up	
Net Console	YES
Terminal #2	YES
Terminal #3	YES
Terminal #4	NO
Terminal #5	NO
Terminal #6	YES

Terminal 1 does not appear in this list since a JAGXTREME terminal always has access to its own internal scale(s).

The other terminals (2, 3, 6) that Terminal 1 can access must have Terminal 1 marked as YES in their Terminal lists. In other words, each pair of terminals that need to interact with each other across Ethernet must have the other's terminal number marked YES in its Configure Network program block. This rule also applies to two terminals that must exchange print data.

Using the previous example:

Terminal 2 Network Set Up	
Net Console	NO
Terminal #1	YES
Terminal #3	NO
Terminal #4	NO
Terminal #5	NO
Terminal #6	YES

Notice that Terminal 2 is configured to allow access from Terminals 1 and 6. Terminal 1 is used as the keyboard/display for Terminal 2 which has its printer output redirected to Terminal 6.

Terminal 2 is a blind terminal so its net console parameter is set to No. Blind terminals power up with defaults allowing data access from all other terminals. These defaults permit other terminals access to the blind terminal for setup.

NOTE: It is important to set up a blind terminal so that all other terminals that do NOT need access to it are turned off in its Configure Network program block. Failure to do this will result in lower performance of the blind terminal and network.

Refer to Chapter 3 for details on how to set these parameters.

Selecting a Network Scale for Interaction

The **SELECT** key is used to connect to another JAGXTREME terminal from a keyboard/display. For example, if you wish to connect to Terminal 2 from Terminal 1:

1. Press **SELECT** until the name for Terminal 2's Scale A is displayed.
2. Press **ENTER** to select.

You are now connected to JAGXTREME 2 Scale A. The annunciators under the lower display point to **2** and to **A**, reminding you which scale is current. Interacting with this scale is now identical to interacting with an internal scale.

Redirecting Serial Output

Any serial port on any JAGXTREME terminal in a cluster, except those connected to a DigiTOL scale, can be used to output serial data from other JAGXTREME terminals in the same cluster. The same demand port can be used by multiple terminals.

In the previous illustration, Terminal 6 has a printer connected to COM1. The set up of COM1's communication port parameters, such as baud rate, are set up on Terminal 6. Let's assume that this printer will be shared by Terminal 1 as an audit trail printer. The preceding table entitled "Terminal 1 Network Set Up" shows that Terminal 6 has been marked YES. Terminal 6's Configure Network program block must also have Terminal 1 marked YES.

Example

To redirect the data output from Terminal 1 to Terminal 6 you must also make a connection for this output. This is done on Terminal 1 in the Configure Serial program block as follows:

1. Access setup mode.
2. Press SELECT until Configure Serial is displayed, then press **ENTER** to access this program block.
3. Press ENTER to access the Configure Port sub-block.
4. Press ENTER at the **Select Port?** prompt to select the desired port.
5. Press SELECT to display **Location? Remote** and press **ENTER**.
6. Press SELECT to display **Node? Terminal 6** and press **ENTER**.
7. Press ENTER to acknowledge **Assign Port? COM1**.
8. Open the **Add Connection?** sub-block and select the desired scale (A or B), demand print template, and demand print options.

With this configuration you can now print from Terminal 1 to the printer connected to Terminal 6 COM1 by selecting the appropriate scale connected to Terminal 6, (A or B) and pressing ENTER.

The Auto Print or discrete print input features can also be used to initiate the print output. For more details on setup of the serial port, refer to Chapter 2.

A-B RIO / PROFIBUS / MODBUS+ Option Sharing

The JAGXTREME terminal's remote scale sharing feature makes it possible for up to four networked scales to share one A-B RIO, PROFIBUS, or MODBUS+ interface. The first scale must be in the same terminal as the option module; the second, third, and fourth scale can be either local or remote.

Please refer to the JAGXTREME PLC and Analog Output Interface manual for additional information.

Internet Explorer Proxy Server Setup

To successfully connect to a JAGXTREME terminal and browse it via Internet Explorer (4.0 or higher only) over a network that is using a proxy server, make sure that the terminal's IP address is added to the Internet Explorer LAN connection Proxy Server Settings Exceptions list.

In Internet Explorer, pull down the Tools menu, select Internet Options, Connections tab, LAN Settings button, then Advanced button to reach Proxy Settings.

Appendix 4: Loading JAGXTREME Software

The JAGXTREME terminal is designed for easy software installation and upgrade. Using METTLER TOLEDO's EFLASH or "Flashpro" installation programs from a personal computer (PC), you can load the latest version of JAGXTREME software and burn it into the terminal's flash memory. Upgrade software is available from METTLER TOLEDO as model 0901-0391 (14602B 00A).

STOP!

If the JAGXTREME terminal you are upgrading has one or more analog load cell scales attached, you must first verify that the program on the Analog PCB(s) has been upgraded to "A" revision or higher. Refer to the instructions supplied with the model 0901-0392 (146070 00A) "A" revision analog software kit for complete instructions.

The JAGXTREME terminal must be reprogrammed and calibrated after you load new software.

Using E_FLASH

E-FLASH is a windows program utility designed to download JAGXTREME software from a personnel computer to a JAGXTREME terminal. E-FLASH can be configured to download the software point-point via the JAGXTREME RS232 COM 2 serial port, or through the JAGXTREME Ethernet port. It is provided free of charge on the JAGXTREME documentation CD shipped with every JAGXTREME terminal.

E-FLASH is launched from the windows START menu under the METTLER TOLEDO program tree.

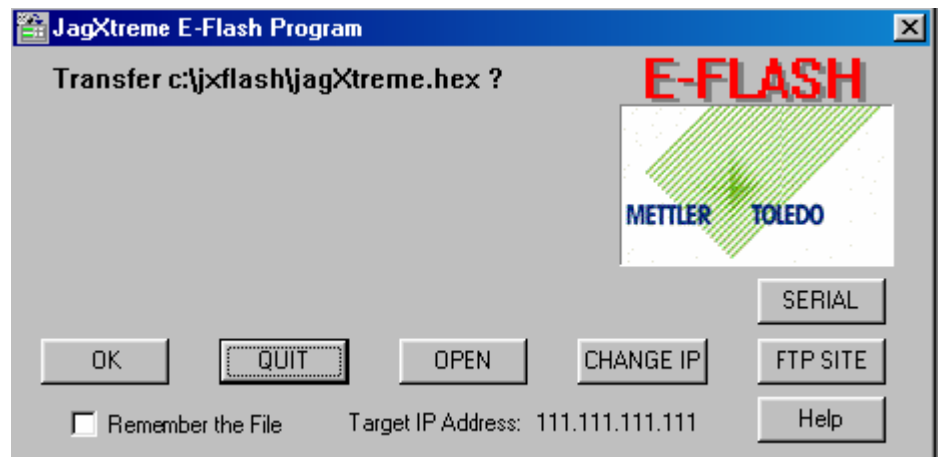

Navigation of the E-FLASH utility is through the seven "hot button" located on the E-FLASH dialogue box. The "hot buttons" perform the following functions:

OK - starts the Ethernet file transfer

QUIT - exits E-FLASH program utility

OPEN - accesses the personal computer filing system to locate the JAGXTREME program to be transferred

CHANGE IP - allows the entry of the JAGXTREME IP address

SERIAL - configures the PC serial port and starts the serial port file transfer

FTP SITE - configures a file transfer using Ethernet FTP(file transfer protocol) and starts the FTP transfer

HELP- provides online help into the operation of E-FLASH

E-FLASH Serial

Disconnect power to the JAGXTREME terminal.

Connect a bi-directional RS-232 cable from the PC to the JAGXTREME terminal's COM2 serial port. Wire the cable.

1. Open the file to be downloaded on the PC using E-FLASH.
2. Configure the PC serial port in E-FLASH.
3. Using a small, non-conducting object, press and hold the pushbutton switch behind the CAL opening on the back of the JAGXTREME controller PCB. Apply power to the terminal. The lower display of the terminal will begin flashing its IP address, Subnet Mask and Gateway IP address.
4. With CAL switch still depressed, start the serial transfer from the PC.
5. Once the transfer has begun the lower display of the terminal will begin showing a "% Complete" counter. At this point the CAL switch can be released on the terminal.
6. Continue as in the "flash pro procedure".

E-FLASH Ethernet

1. Disconnect power to the JAGXTREME terminal.
2. Connect a 10BaseT cross over cable between the PC and the terminal.
3. Open the file to be downloaded on the PC using E-FLASH.
4. Enter the JAGXTREME IP address into E-FLASH.
5. Using a small, non-conducting object, press and hold the pushbutton switch behind the CAL opening on the back of the JAGXTREME controller PCB. Apply power to the terminal. The lower display of the JAGXTREME will begin flashing its IP address, Subnet Mask and Gateway IP address.
6. With CAL switch still depressed, start the serial transfer from the PC.
7. Once the transfer has begun the lower display of the terminal will begin showing a "% Complete" counter, at this point the CAL switch can be released on the terminal.

FLASHPRO

Do not perform the file download from within the Windows environment. Exit Windows and perform the following steps from the DOS prompt.

Note: You may download the latest JAGXTREME operating software from the METTLER TOLEDO Field Service FTP site on the Internet.

For the JAGXTREME terminal, you will need two diskettes to contain the entire O/S in compressed format.

Extract the new files onto the PC:

1. Create a directory and go to the directory on the PC where the new files will be stored. Use the DOS MD command or Windows Explorer if you need to create a new directory to hold the JAGXTREME terminal's files.
2. Insert the diskette with the new software files into the floppy disk drive A or B. The files on this diskette are compressed into a single file named JAGXTREME.EXE. Copy this file into the directory that you created in step 1.
3. At the DOS prompt, type JAGXTREME then press ENTER. Or, double click on the file name in Windows. The compressed files will automatically extract themselves from JAGXTREME.EXE into the designated directory on the computer. The extracted files require approximately 5 MB of storage space on the PC's hard drive.
4. Edit the FP.BAT file using the DOS text editor or another and verify the new software name and serial port are correct. The FP.BAT file resembles the example below. Edit only the -t and -com elements.

Example:

```
flashpro -tSYS9_16.HEX -b115.2 -com1 -pe -d7 -s1
```

where:

-t is followed by the file name to be saved such as SYS9_16.HEX.

-b is the baud rate (in kbaud). The software is transferred at 115.2 kbaud. DO NOT CHANGE THIS PARAMETER.

-com is the serial com port on the PC that will be used to transfer the new software to the JAGXTREME terminal.

-p is the parity. The parity is set to even. DO NOT CHANGE THIS PARAMETER.

-d is the number of data bits used. Data bits are set to seven. DO NOT CHANGE THIS PARAMETER.

-s is the number of stop bits used. Stop bits are set to one. DO NOT CHANGE THIS PARAMETER.

You are now ready to use the flashpro batch file (FP.BAT) to load the software into the JAGXTREME terminal's flash memory. To load JAGXTREME software:

1. Disconnect power to the JAGXTREME terminal.
2. Connect a bi-directional RS-232 cable from a PC to the JAGXTREME terminal's COM2 serial port. Wire the cable as follows:

JAGXTREME COM2	9-pin COM	25-pin COM
TxD B	2	3
RxD B	3	2
Gnd	5	7
Jumpers	4 to 6, 7 to 8	4 to 5, 6 to 20

3. With the cursor in the directory containing the new JAGXTREME files, type FP at the DOS prompt, but DO NOT press **ENTER** to execute the command.

If a DigiTOL base is installed, be sure to disconnect all wires prior to connecting the RS-232 cable.

4. Using a small, non-conducting object such as a bare Q-Tip, press and hold the pushbutton switch behind the CAL opening on the back of the Controller PCB.
5. With the CAL switch still depressed, apply power to the JAGXTREME then press ENTER or RETURN on your computer immediately to execute the flashpro installation program.
6. Release the CAL switch when a framed box scrolling a string of A's appears on the computer monitor indicating the installation has begun.

The box will continue to scroll A's until the installation procedure is complete. This process will continue with brief pauses occasionally for about 10 to 15 minutes. If the box with A's does not appear, press ESCAPE on the computer and remove power from the JAGXTREME terminal. Repeat steps 4 through 7.

If the new software was downloaded successfully, the DOS prompt will be restored on the computer and the JAGXTREME terminal will perform a power-up sequence.

During the power-up sequence, the storage locations for setup parameters and memory fields are checked. If any have been moved or added in the new version of software, you must respond Yes to the following prompts:

BRAM Bad - Rst? Y or BRAM Err - Rst? Y

EError - Reset? Y or EE A Err - Rst? Y

7. Press ENTER to reset the JAGXTREME terminal's program block parameters to factory defaults. If you select N(o), you will encounter scale errors.

If **BRAM Err - Rst? Y** is displayed, you must reconfigure the JAGXTREME terminal.

If **EError - Reset** is displayed, you must recalibrate the scale.

If **EE A Err - Rst? Y** is displayed, you must recalibrate the scale.

8. Disconnect power, then reconnect power to the JAGXTREME terminal. When the JAGXTREME terminal lights all display segments in the power-up sequence, press and hold the CAL pushbutton (as described in step 5) until the terminal displays the **Master Reset!!!** prompt. This returns all program block parameters to factory defaults.

Also applies to E-Flash method on previous page

Appendix 5: JAGXTREME Default Values

Master Reset on the JAGXTREME Terminal

The JAGXTREME Terminal has more than one Master Reset. The most thorough of these involves using the CAL switch on the controller card. This Master Reset will clear **ALL** setup, templates, JagBASIC files, system log files, and calibration of DigiTOL bench scales. Analog scales, POWERCELL scales, and High Precision scales using the IDNet interface will retain their calibration parameters as long as no scale error occurs.

To perform a Master Reset, it is best to use a non-conductive item. A nylon pop rivet works well. A long M2 screw may be used, but do not use a screwdriver to insert it. Gently using your fingers is more than adequate to depress the switch.

On a JAGXTREME with a display, apply power. When the upper display shows "8888888", press and hold the CAL switch on the controller card. Hold the switch until the words "Master Reset" is displayed on the lower display. Release the switch. After a few seconds, the JAGXTREME will restart.

ON a blind JAGXTREME or JXHG, apply power. Wait 3 seconds, then press and hold the CAL switch on the controller card. Hold the switch for 10 seconds. Release the switch. After a few seconds, the JAGXTREME will restart. Wait 30 seconds for the JAGXTREME to fully reboot.

The following lists the factory default values for each program block. Use the As Configured column to record your actual setup configuration.

Scale Interface program block			
Default	As Configured	Default	As Configured
Market - USA		Linearity Correction - No	
Scale Type		Calibration - No defaults	
# Internal Scales - 1		Zero Adjustment - No defaults	
Type - Analog		Zero Adjustments - No defaults	
Location - Analog Bd 1		Span Adjustment - No defaults	
Calibration Unit - Pounds		Gravity Adjust - 1.0	
Capacity - 2.0 lb			
Increment Size			
Number of Intervals - 1			
Low - 0.001			

Application Environment program block			
Default	As Configured	Default	As Configured
Character Set – USA		Zero Operation	
		Power-up Zero	
Language – English		Positive Range - 0%	
		Negative Range - 0%	
Keyboard Type – English		Pushbutton Zero	
		Positive Range - 2%	
Scale ID – SCALExA		Negative Range - 2%	
		Blank Zero - 5 divisions	
Time and Date Format		Auto Zero Maintenance	
Time Separator - :		Range - 1.00 divisions	
Time Format - 24:MM:SS		AZM w/ Net Mode - N	
Date Separator – space		Center of Zero - Gross Only	
Date Format - DD MMM YYYY		Stability Detection	
Alternate Weight Units		Stability Range - 1.0 divisions	
Main Units – pounds		Stability Readings - 0.3 sec	
Unit Switching – Yes		Beeper Operation	
Second Units – kilograms		Key Beeper - N	
Enable Aux. Units – No		Alarm Beeper - Y	
Power-up Operations		Process Application	
Timer – 0		Process - High	
Tare Operation		Vibration Rejection	
Enable Tare – Y		Adjust Lowpass	
Tare Interlock – N		Frequency - 2.0	
Enable Pushbutton Tare - Y		Poles - 8	
Enable Keyboard Tare - Y		Adjust Notch	
Enable Auto Tare – N		Frequency - 30.0	
Auto Clear Tare – N		Stable Filter - N	
Display Tare – Y			
Net Sign Correction - N			
Jag IDNET Tare - N			

Configure Serial program block			
Default	As Configured	Default	As Configured
Configure Port		Flexible Print	
Select Port Location - Local		Template 1 - N	
Assign Port - COM1		Template 2 - N	
Port Parameters		Template 3 - N	
Baud Rate - 9600		Template 4 - N	
Data Bits - 7		Template 5- N	
Parity - Even		Minimum Print - N	
Flow - XON/XOFF		Print Interlock - N	
COM1 Add Connection		COM2 Connection	
Type - Serial Out		No connections	
Mode - Demand			

Configure Template program block	
Default	As Configured
Defaults given in Appendix 1	

Configure Discrete program block			
Default	As Configured	Default	As Configured
Assign Setpoints			
Setpoint 1 - None		Setpoint 5 - None	
Setpoint 2 - None		Setpoint 6 - None	
Setpoint 3 - None		Setpoint 7 - None	
Setpoint 4 - None		Setpoint 8 - None	

Configuration of Discrete Inputs and Outputs			
Discrete Inputs	As Configured	Discrete Outputs	As Configured
Controller Card		Controller Card	
PAR 1.1 Clear		PAR 2.1 Setpt 1	
PAR 1.2 Tare		PAR 2.2 Setpt 2	
PAR 1.3 Print		PAR 2.3 Setpt 3	
PAR 1.4 Zero		PAR 2.4 Setpt 4	
Multifunction Card		Multifunction Card	
PAR 3.1		PAR 4.1	
PAR 3.2		PAR 4.2	
PAR 3.3		PAR 4.3	
PAR 3.4		PAR 4.4	
PAR 3.5		PAR 4.5	
PAR 3.6		PAR 4.6	
PAR 3.7		PAR 4.7	
PAR 3.8		PAR 4.8	

Configure Memory program block			
Default	As Configured	Default	As Configured
Configure Literals		Configure CN	
All literals blank (literals 11-20 are preset literals)		Port Location - Local	
Configure Prompts		Assign Port - COM1	
All prompts blank		Start - 0	

Literals and Prompts as Programmed			
Literals		Prompts	
1		1	
2		2	
3		3	
4		4	
5		5	
6		6	
7		7	
8		8	
9		9	
10		10	
11		11	
12		12	
13		13	
14		14	
15		15	
16		16	
17		17	
18		18	
19		19	
20		20	

Configure JagBASiC			
Default	As Configured	Default	As Configured
Keyboard – None		Send RAM Files	
		Files to PC - N	
Display – None		Files From PC - N	
		Initialize RAM Disk	
Auto Start – N		Delete RAM Disk Files - N	
		Password Maintenance	
Manual Start – N		Password - N/A	

Configure Network program block			
Default	As Configured	Default	As Configured
Ethernet IP Address -- 111.111.111.111		WebServer Home Page -- home.htm	
Ethernet Subnet Mask -- 255.255.255.000		WebServer Document Page -- document.htm	
Ether. Gateway IP Address -- 0.0.0.0		WebServer Help Page -- help.htm	
PPP IP Address -- 0.0.0.0		FTP User Name 1 -- SUPERVISOR	
PPP Subnet Mask – 255.255.255.000		FTP User Password 1 -- ----	
PPP Gateway IP Address -- 0.0.0.0		FTP User Password 5 -- ----	
PPP Timeout – 600 seconds		FTP User Name 6 -- ----	
Local PPP User Name -- ----		FTP User Password 6 -- ----	
Local PPP User Password -- ----		Node Number -- 1	
Remote PPP User Name -- ----		Cluster IP Address 1 – 111.111.111.111	
Remote PPP User Password -- ----		Cluster IP Address 2 – 111.111.111.112	
PPP Dial Phone Number -- ----		Cluster IP Address 3 – 111.111.111.113	
PPP Modem AT InitString -- AT&U0&N10		Cluster IP Address 4 – 111.111.111.114	
SMTP Server IP Address -- 0.0.0.0		Cluster IP Address 5 – 111.111.111.115	
Email Machine Name -- Jaguar		Cluster IP Address 6 – 111.111.111.116	
Sender Email Address -- jaguar@xx.com		Host IP Address – 0.0.0.0	
Email Subject -- Automated Email Alert		Enable DHCP Client -- 0	
SMTP Server TCP Port -- 25			

* Defaults for Blind Terminals are Y(es)

Diagnostics and Maintenance program block			
Default	As Configured	Default	As Configured

Allen-Bradley RIO program block			
Default	As Configured	Default	As Configured
Scale Setup		Node Communications	
Data Format - Weight		Rack Address - 01	
Number of Scales - 1		Starting Quarter - 1	
Block Transfer - N		Last Rack - Y	
Setpoints - Eight		Data Rate - 57.6k	

PROFIBUS program block			
Default	As Configured	Default	As Configured
Scale Setup		Node Communications	
Data Format - Weight		Rack Address - 01	
Number of Scales - 1			

Configure Analog Output program block			
Default	As Configured	Default	As Configured
Output Channel A		Output Channel B	
Source - Gross		Source - Gross	
Zero Preset - 0.0		Zero Preset - 0.0	
Span Preset - Capacity		Span Preset - Capacity	
Zero Trim - No Defaults		Zero Trim - No Defaults	
Span Trim - No Defaults		Span Trim - No Defaults	

MODBUS Plus			
Default	As Configured	Default	As Configured
Scale Setup		Node Communications	
Data Format - Weight		Rack Address - jumpered on board	
Number of Scales - 1			
Globals - N			

Appendix 6: Gravity Factors

Use the chart and equation below to calculate the Gravity Adjust Factor:

$$\text{Gravity Adjust} = 1.0000 - (\text{calibrated location} - \text{destination location}) \times 0.0002$$

For example, if the calibrated location is Geo code 16 and the destination is Hawaii (latitude 19 degrees and 43 minutes), then use Geo code 8.

$$\text{Gravity Adjust} = 1.0000 - ((16-8) \times 0.0002) = 0.9984$$

The minimum/maximum values are .9938 and 1.0062.

Geo Value Table North or south latitude in degrees and minutes	Height above sea level in meters										
	0	325	650	975	1300	1625	1950	2275	2600	2925	3250
	Height above sea level in feet										
	0	1060	2130	3200	4260	5330	6400	7460	8530	9600	10660
0° 0' - 5° 46'	5	4	4	3	3	2	2	1	1	0	0
5° 46' - 9° 52'	5	5	4	4	3	3	2	2	1	1	0
9° 52' - 12° 44'	6	5	5	4	4	3	3	2	2	1	1
12° 44' - 15° 6'	6	6	5	5	4	4	3	3	2	2	1
15° 6' - 17° 10'	7	6	6	5	5	4	4	3	3	2	2
17° 10' - 19° 2'	7	7	6	6	5	5	4	4	3	3	2
19° 2' - 20° 45'	8	7	7	6	6	5	5	4	4	3	3
20° 45' - 22° 22'	8	8	7	7	6	6	5	5	4	4	3
22° 22' - 23° 54'	9	8	8	7	7	6	6	5	5	4	4
23° 54' - 25° 21'	9	9	8	8	7	7	6	6	5	5	4
25° 21' - 26° 45'	10	9	9	8	8	7	7	6	6	5	5
26° 45' - 28° 6'	10	10	9	9	8	8	7	7	6	6	5
28° 6' - 29° 25'	11	10	10	9	9	8	8	7	7	6	6
29° 25' - 30° 41'	11	11	10	10	9	9	8	8	7	7	6
30° 41' - 31° 56'	12	11	11	10	10	9	9	8	8	7	7
31° 56' - 33° 9'	12	12	11	11	10	10	9	9	8	8	7
33° 9' - 34° 21'	13	12	12	11	11	10	10	9	9	8	8
34° 21' - 35° 31'	13	13	12	12	11	11	10	10	9	9	8
35° 31' - 36° 41'	14	13	13	12	12	11	11	10	10	9	9
36° 41' - 37° 50'	14	14	13	13	12	12	11	11	10	10	9
37° 50' - 38° 58'	15	14	14	13	13	12	12	11	11	10	10
38° 58' - 40° 5'	15	15	14	14	13	13	12	12	11	11	10
40° 5' - 41° 12'	16	15	15	14	14	13	13	12	12	11	11
41° 12' - 42° 19'	16	16	15	15	14	14	13	13	12	12	11
42° 19' - 43° 26'	17	16	16	15	15	14	14	13	13	12	12
43° 26' - 44° 32'	17	17	16	16	15	15	14	14	13	13	12
44° 32' - 45° 38'	18	17	17	16	16	15	15	14	14	13	13
45° 38' - 46° 45'	18	18	17	17	16	16	15	15	14	14	13
46° 45' - 47° 51'	19	18	18	17	17	16	16	15	15	14	14
47° 51' - 48° 58'	19	19	18	18	17	17	16	16	15	15	14
48° 58' - 50° 6'	20	19	19	18	18	17	17	16	16	15	15
50° 6' - 51° 13'	20	20	19	19	18	18	17	17	16	16	15
51° 13' - 52° 22'	21	20	20	19	19	18	18	17	17	16	16
52° 22' - 53° 31'	21	21	20	20	19	19	18	18	17	17	16
53° 31' - 54° 41'	22	21	21	20	20	19	19	18	18	17	17
54° 41' - 55° 52'	22	22	21	21	20	20	19	19	18	18	17
55° 52' - 57° 4'	23	22	22	21	21	20	20	19	19	18	18
57° 4' - 58° 17'	23	23	22	22	21	21	20	20	19	19	18
58° 17' - 59° 32'	24	23	23	22	22	21	21	20	20	19	19
59° 32' - 60° 49'	24	24	23	23	22	22	21	21	20	20	19
60° 49' - 62° 9'	25	24	24	23	23	22	22	21	21	20	20
62° 9' - 63° 30'	25	25	24	24	23	23	22	22	21	21	20
63° 30' - 64° 55'	26	25	25	24	24	23	23	22	22	21	21
64° 55' - 66° 24'	26	26	25	25	24	24	23	23	22	22	21
66° 24' - 67° 57'	27	26	26	25	25	24	24	23	23	22	22
67° 57' - 69° 35'	27	27	26	26	25	25	24	24	23	23	22
69° 35' - 71° 21'	28	27	27	26	26	25	25	24	24	23	23
71° 21' - 73° 16'	28	28	27	27	26	26	25	25	24	24	23
73° 16' - 75° 24'	29	28	28	27	27	26	26	25	25	24	24
75° 24' - 77° 52'	29	29	28	28	27	27	26	26	25	25	24
77° 52' - 80° 56'	30	29	29	28	28	27	27	26	26	25	25
80° 56' - 85° 45'	30	30	29	29	28	28	27	27	26	26	25
85° 45' - 90° 0'	31	30	30	29	29	28	28	27	27	26	26

Appendix 7: Multiple Range/Multi-Interval Operation

Multiple Range Operation

With multiple range weighing, there can be up to three weighing ranges and each has a threshold. Each weighing range extends from zero to its range threshold. Each range has an associated increment size. The increment size and threshold value are larger for each successive weighing range from the lowest to highest ranges. The difference between the largest and smallest increment size is at most one decimal place. You manually set the increment sizes and thresholds in setup.

The JAGXTREME terminal only supports automatic selection of the "current weighing range". When weight is increasing, the current weighing range proceeds from the lower range to the next higher range once the weight exceeds the range threshold. Switchover to the next higher range occurs at the range threshold. When weight is decreasing, the current weighing range returns from the current weighing range to the lowest range only when the weight falls within half-a-division of zero.

The terminal has a permanent display that clearly indicates the current weighing range. The terminal indicates weighing ranges 1, 2, and 3 respectively. As of this printing, a new display overlay identifies these cursors as weighing range indicators. The terminal maintains the same decimal point position in the Displayed Weight even when the current weighing range changes. There is at most one trailing, non-significant "0". When right of the decimal point, the non-significant "0" must be in the third place to the right of the decimal point. Manually set this in setup. A Tare may be taken in any weighing range. The Displayed Weight and Printed Weight are always the same.

In Gross Mode

The JAGXTREME terminal determines the current weighing range by comparing the Fine Gross Weight to the range thresholds. If scale is within half-a-division of zero, the terminal returns to the lowest weighing range as the current weighing range. The JAGXTREME terminal calculates the Displayed Gross Weight by rounding the Fine Gross Weight to the nearest weight increment for the current weighing range.

In Net Mode

- The terminal determines current weighing range by comparing the Fine Gross Weight to the range thresholds. If the scale is within half-a-division of zero for gross mode: the terminal returns to the lowest weighing range as the current weighing range.
- The JAGXTREME terminal calculates the Displayed Net Weight by rounding the Fine Net Weight to the nearest weight increment for the current weighing range.
- The JAGXTREME terminal calculates the Displayed Tare Weight by rounding the Fine Tare Weight to the nearest weight increment for the current weighing range.

Displayed Gross Weight = Displayed Tare Weight + Displayed Net Weight

When you select the "Div" or divisions weight option in the <Config Options><plc type><Scale Setup><Data Format?> menu selection, the JAGXTREME terminal only reports the number of divisions calculated from the increment size of the highest weighing range to the PLC since there is no interface to report the current weighing range. You can select the "Wgt", "Fit" or "Ext" options to report weight to the PLC that reflects weight calculated in the actual weighing range.

Multi-Interval Operation

The JAGXTREME terminal uses multi-interval weighing rules only when the scale base is a Mettler high precision base. There can be up to three weighing intervals. Each weighing interval has a threshold. Each weighing interval extends from the threshold of the next lower interval to its threshold. Each interval has an associated increment size. The increment size and threshold value are larger for each successive weighing interval from the lowest to highest intervals. The METTLER TOLEDO high precision base sets the increment sizes and thresholds.

The terminal only supports automatic selection of "current weighing interval". When weight is increasing, the current weighing interval proceeds from the lower interval to the next higher interval when the weight exceeds the interval threshold. The terminal uses setpoint cursors 6, 7, and 8 to indicate weighing ranges 1, 2, and 3 respectively. As of this printing, there is a new display overlay to identify these cursors as weighing range indicators. The terminal enforces taking tare through the high precision base when the Legal-for-Trade SW1 is ON. The Legal For Trade option takes precedence over <Application Env><Tare Operation><Jag IDNET Tare> menu selection.

The <Application Env><Zero Operation><Restart> setup menu selects the power up operation of the base. When Restart=N is selected, the JAGXTREME terminal/high precision base clears the current tare and enforces a re-zeroing of the base after a restart of the base. When Restart=Y, the JAGXTREME terminal/high precision base preserves the current zero and tare values after a restart of the base.

In Europe and Australia, Pushbutton and AutoTare may be taken in any interval. In legal for trade mode, Preset Tare entries must be within the lowest interval. The terminal generates an error message when the entry is too large. If not in legal for trade mode, Preset Tare entries may be in any interval. In the U.S. legal-for-trade mode, all tare entries must be in the lowest weighing range. Displayed Weight and Printed Weight are always the same.

In Gross Mode

The JAGXTREME terminal determines the current weighing interval by comparing the Fine Gross Weight to the interval thresholds. The terminal calculates the Displayed Gross Weight by rounding the Fine Gross Weight to the nearest weight increment for the current weighing interval.

In Net Mode

The JAGXTREME terminal determines the "net weight current weighing interval" by comparing the Fine Net Weight to the interval thresholds. It calculates the Displayed Net Weight by rounding the Fine Net Weight to the nearest weight increment for the "net weight current weighing interval".

The terminal determines the "tare weight current weighing interval" by comparing the Fine Tare Weight to the interval thresholds. It calculates the Displayed Tare Weight by rounding the Fine Net Weight to the nearest weight increment for the "tare weight current weighing interval".

Displayed Gross Weight = Displayed Tare Weight + Displayed Net Weight

When you select the "Div" or divisions weight option in the <Config Options><plc type><Scale Setup><Data Format?> menu selection, the JAGXTREME terminal only reports the number of divisions calculated from the increment size of the highest weighing interval to the PLC since there is no interface to report the current weighing interval. You can select the "Wgt", "Flt" or "Ext" options to report weight to the PLC that reflects weight calculated in the actual weighing interval.

Appendix 8: Market Destination (Finish) Codes

Use the following table to determine the finish code for a particular market destination.

FINISH CODE	DESTINATION MARKET	PREFERRED LANGUAGE	ALTERNATE LANGUAGE	VOLTAGE & FREQUENCY	PWR CORD CONFIG	WEIGHT UNIT	RETAIL CURRENCY	CURRENCY ABBREV
000	UNITED STATES	ENGLISH	ENGLISH	120/60	A	LB	DOLLAR	\$
001	UNITED STATES	ENGLISH	ENGLISH	220/60	K	LB	DOLLAR	\$
002	DENMARK	DANISH	SWED/NORW	230/50	B	KG	DAN KRONE	Kr
003	UK	ENGLISH	ENGLISH	240/50	C	KG	POUND ST	£
004	ITALY	ITALIAN	ENGLISH	230/50	B	KG	LIRE (LIT)	L
005	SWITZERLAND	GERMAN	ENGLISH	230/50	B	KG	SWISS FRC	Fr
006	SWITZERLAND	ITALIAN	ENGLISH	230/50	B	KG	SWISS FRC	Fr
007	SWITZERLAND	FRENCH	ENGLISH	230/50	B	KG	SWISS FRC	Fr
008	AMER. SAMOA	ENGLISH	ENGLISH	120/60	A	LB	DOLLAR	\$
009	ARGENTINA	SPANISH	ENGLISH	220/50	D	KG	PESO	\$
010	AUSTRALIA	ENGLISH	ENGLISH	240/50	D	KG	AUS DOLLAR	\$
011	AUSTRIA	GERMAN	—	230/50	B	KG	SCHILLING	S
012	BARBADOS	ENGLISH	ENGLISH	120/50	A	KG	B ' DOS \$	\$
013	BELGIUM	FLEMISH	DUTCH	230/50	B	KG	BEL.FRANC	Fr
014	BELGIUM	FRENCH	ENGLISH	230/50	B	KG	BEL. FRANC	fr
015	BERMUDA	ENGLISH	ENGLISH	115/60	A	LB	DOLLAR	\$
016	BERMUDA	ENGLISH	ENGLISH	115/60	A	KG	DOLLAR	\$
017	BRAZIL	PORTUG.	ENGLISH	120/60	A	KG	REAL \$	R\$
018	BRAZIL	PORTUG.	ENGLISH	220/60	A	KG	REAL \$	R\$
019	CANADA	ENGLISH	ENGLISH	120/60	A	LB	CAN DOLLAR	\$
020	CANADA	FRENCH	ENGLISH	120/60	A	KG	CAN DOLLAR	\$
021	CZECH REP.	CZECH	ENGLISH	230/50	B	KG	KORUNA	Kcs **
022	CHILE	SPANISH	ENGLISH	220/50	E	KG	CHILE PESO	\$
023	CHINA	CHINESE	ENGLISH	220/50	F	KG	RENMINBI	RMB
024	COLOMBIA	SPANISH	ENGLISH	120/60	A	KG	PESO	\$
025	COSTA RICA	SPANISH	ENGLISH	120/60	A	KG	COLON	¢
026	CURACAO	DUTCH	ENGLISH	120/50	A	KG	GUILDER	ANG
027	DOM. REPUBLIC	SPANISH	ENGLISH	120/60	A	LB	RD DOLLAR	RD\$
028	DOM. REPUBLIC	SPANISH	ENGLISH	120/60	A	KG	RD DOLLAR	RD\$
029	ECUADOR	SPANISH	ENGLISH	120/60	A	KG	SUCRE	SI.
030	EGYPT	ARABIC	ENGLISH	220/50	F	KG	POUNDS	£
031	EL SALVADOR	SPANISH	ENGLISH	120/60	A	LB	COLON	¢
032	EL SALVADOR	SPANISH	ENGLISH	120/60	A	KG	COLON	¢
033	FINLAND	FINNISH	ENGLISH	230/50	B	KG	MARRKA	MK
034	FRANCE	FRENCH	—	230/50	B	KG	FR. FRANC	F
035	GERMANY	GERMAN	—	230/50	B	KG	D. MARKS	DM
036	GREECE	GREEK	ENGLISH	230/50	B	KG	DRACHMA	Dr
037	GUATEMALA	SPANISH	ENGLISH	120/60	A	SPAN. LB	QUETZALES	Q
038	GUATEMALA	SPANISH	ENGLISH	120/60	A	KG	QUETZALES	Q
039	HONDURAS	SPANISH	ENGLISH	120/60	A	LB	LEMPIRAS	L
040	HONDURAS	SPANISH	ENGLISH	120/60	A	KG	LEMPIRAS	L

Chapter 9: Appendices
Appendix 8: Market Destination (Finish) Codes

FINISH CODE	DESTINATION MARKET	PREFERRED LANGUAGE	ALTERNATE LANGUAGE	VOLTAGE & FREQUENCY	PWR CORD CONFIG	WEIGHT UNIT	RETAIL CURRENCY	CURRENCY ABBREV
041	HONG KONG	CHINESE	ENGLISH*	200/50	C	KG	HK DOLLAR	\$
042	HUNGARY	ENGLISH	—	230/50	B	KG	FORINT	F
043	ICELAND	ENGLISH	ENGLISH	230/50	B	KG	KRONA	Kr.
044	INDIA	—	ENGLISH*	240/50	G	KG	RUPEE	Re
045	INDONESIA	—	ENGLISH*	220/50	F	KG	RUPIAH	Rp
046	IRELAND	ENGLISH	ENGLISH	230/50	C	KG	PUNT	£
047	ISRAEL	HEBREW	ENGLISH	230/50	H	KG	SHEKEL	NIS
048	JAMAICA	ENGLISH	ENGLISH	110/50	A	LB	JAM DOLLAR	\$
049	JAMAICA	ENGLISH	ENGLISH	110/50	A	KG	JAM DOLLAR	\$
050	JAPAN	JAPANESE	—	100/50,60	I	KG	YEN	¥
051	JORDAN	ARABIC	ENGLISH*	220/50	C	KG	JD	JD
052	LEBANON	ARABIC	ENGLISH*	110/50	F	KG	L POUND	L£
053	MALAYSIA	MALAY	ENGLISH*	240/50	C	KG	RINGGIT	M\$
054	MEXICO	SPANISH	ENGLISH	120/60	A	KG	PESO	N\$
055	MOROCCO	ARABIC	—	230/50	B	KG	DIRHAM	***
056	NETHERLANDS	DUTCH	GERMAN	230/50	B	KG	D. GUILDER	G
057	NEW ZEALAND	ENGLISH	ENGLISH	230/50	D	KG	NZ DOLLAR	\$
058	NICARAGUA	SPANISH	ENGLISH	120/60	A	KG	NIO	C\$
059	NORWAY	NORWEIG	SWED/DAN	230/50	B	KG	KRONE	Kr
060	PAKISTAN	PAKISTANI	ENGLISH*	240/50	G	KG	RUPEE	PRe
061	PANAMA	SPANISH	ENGLISH	120/60	A	KG	DOLLAR	\$
062	PARAGUAY	SPANISH	PORTUGUESE	220/50	A	KG	GUARANI	G.
063	PERU	SPANISH	ENGLISH	220/60	A	KG	NUEVOS SOLES	S/.
064	PHILIPPINES	FILIPINO	ENGLISH*	115/60	A	KG	PESO	PP
065	POLAND	POLISH	GERMAN	230/50	B	KG	ZLOTY	Z
066	PORTUGAL	PORTUG.	SPANISH	230/50	B	KG	ESCUDO	\$
067	PUERTO RICO	ENGLISH	SPANISH	120/60	A	LB	DOLLAR	\$
068	PUERTO RICO	ENGLISH	SPANISH	120/60	A	KG	DOLLAR	\$
069	RUSSIA (CIS)	RUSSIAN	ENGLISH	230/50	B	KG	RUBLE	R
070	SAUDI ARABIA	ARABIC	ENGLISH*	127/60	A	KG	SR	SR
071	SINGAPORE	CHINESE	ENGLISH*	230/50	F,C	KG	S DOLLAR	S\$
072	SLOVAK REP.	GERMAN	ENGLISH	230/50	B	KG	KORUNA	Kcs **
073	SOUTH AFRICA	ENGLISH	ENGLISH	220/50	G	KG	RAND	R
074	SOUTH KOREA	KOREAN	ENGLISH	110/60	A	KG	WON	W****
075	SPAIN	SPANISH	ENGLISH	230/50	B	KG	PESETAS	Pta
076	SWEDEN	SWEDISH	NORW/DAN	230/50	B	KG	KRONER	Kr
077	TAIWAN	CHINESE	ENGLISH*	110/60	A	KG	NEW TAI DOLLAR	NT\$
078	THAILAND	THAI	ENGLISH*	220/50	F	KG	BAHT	B
079	TRINIDAD	ENGLISH	ENGLISH	120/60	A	KG	\$	\$
080	TURKEY	ARABIC	—	230/50	B	KG	LIRA	£
081	TURKEY	TURKISH	—	230/50	B	KG	LIRA	£
082	URUGUAY	SPANISH	ENGLISH	220/50	D	KG	PESO	\$
083	VENEZUELA	SPANISH	ENGLISH	120/60	A	KG	BOLIVARES	Bs.
084	VIRGIN ISLANDS	ENGLISH	ENGLISH	120/60	A	LB	DOLLAR	\$

Chapter 9: Appendices
Appendix 8: Market Destination (Finish) Codes

FINISH CODE	DESTINATION MARKET	PREFERRED LANGUAGE	ALTERNATE LANGUAGE	VOLTAGE & FREQUENCY	PWR CORD CONFIG	WEIGHT UNIT	RETAIL CURRENCY	CURRENCY ABBREV
085	VIRGIN ISLANDS	ENGLISH	ENGLISH	120/60	A	KG	DOLLAR	\$
086	UK	ENGLISH	ENGLISH	120/50	C	KG	POUND ST	£
090	ROMANIA	ROMANIAN	ENGLISH	220/50	B	KG	LEU	ROL
091	BOLIVIA	SPANISH	ENGLISH	220/50	A	KG	BOLIVIANO	BOB
092	LATVIA	ENGLISH	ENGLISH	230/50	B	KG	LATAS	Lv
093	LITHUANIA	ENGLISH	ENGLISH	230/50	B	KG	LITAS	Lt
094	CROATIA	ENGLISH	ENGLISH	230/50	B	KG	KUNA	kn
999	W/O FINISH	NONE	NONE	NONE	NONE	NONE	NONE	NONE

TABLE NOTES

* - ENGLISH OKAY FOR TECHNICAL DOCUMENTATION

** - Kcs HAS A SMALL "v" ABOVE THE LETTER "c".

*** - CURRENCY ABBREVIATION IS NOT KNOWN - NO RETAIL MARKET.

**** - THE LETTER "W" FOR WON HAS A DOUBLE LINE (=) THROUGH THE MIDDLE.

PREFERRED LANGUAGE - Language that is normally accepted in that region.

ALTERNATE LANGUAGE - Language (Eng, Span, Fren, Germ) that is also acceptable.

PWR CORD CONFIG - The "one" configuration most accepted in that region.

RETAIL CURRENCY - The full official name of the currency used.

CURRENCY ABBREV - The currency abbreviation that should appear on keys and displays.



METTLER TOLEDO

1900 Polaris Parkway
Columbus, Ohio 43240

Phone: (US and Canada) (800) 786-0038
(614) 438-4511

Phone: (All Other Countries) (614) 438-4888

www.mt.com/support

P/N: D15896200A

(03/05).00

METTLER TOLEDO®, JAGXTREME® and DigiTOL® are registered trademarks
of Mettler-Toledo, Inc. All other product names are trademarks of their respective companies.

©2005 Mettler-Toledo, Inc.

Printed in USA