

Industrial Solutions

Technology Services

Polyester and Polyamide

UIF Polycondensation Technologies
Optimization of
existing production plants



thyssenkrupp



Technology Services

Optimization of polyester and polyamide plants

Service concept

With the polymer industry facing increased cost pressure world-wide, state-of-the-art technology helps to live up to the technological and economic challenges.

With a wide range of tailor-made services and innovative technologies, we offer efficient solutions for optimizing the process technology and performance of polyester and polyamide plants throughout their service lives.

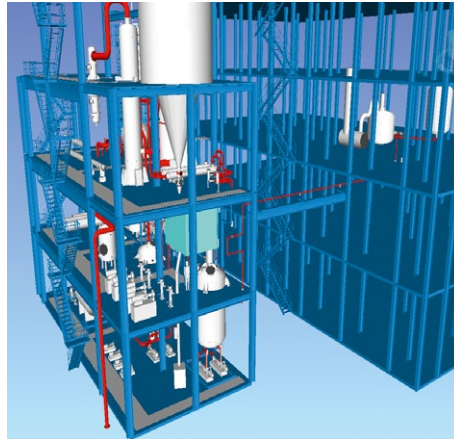

Performance services

- Capacity increases
- Optimization of energy and feedstock efficiency
- Product change and improvement in product quality
- Feedstock change
- Recycling technologies
- Retrofitting with MTR® (Melt-To-Resin) technology



System services

- Inspection, maintenance and repair work
- Leakage detection at plants that are in operation
- Spare parts services
- Erection, commissioning support and supervision

Consulting services

- Technical studies
- Engineering
- Pilot plant tests
- Training programs for operating personnel
- Production of sample material
- Testing of additives and catalysts
- Lab services

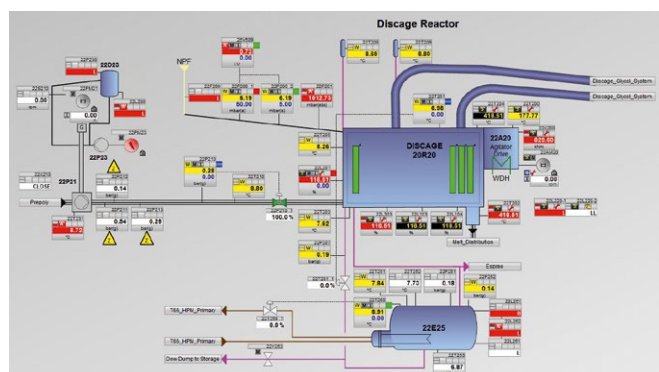

Technical Study

Engineering

Implementation

Performance Services

Revamps

Tailor-made service solutions

We offer a wealth of proprietary patented technologies and processes to improve and optimize the performance of polyester and polyamide plants. These enable our customers to optimize their plants by implementing individual technical solutions.

Capacity increases

- Production capacity increases can be achieved at a relatively low investment cost through debottlenecking and optimizing polyester and polyamide plants.

Optimization of energy and feedstock efficiency

- The energy demand of a PET plant can be considerably reduced by using the steam released during esterification.
- The reaction efficiency of the processes can be greatly improved by installing additional heat exchangers and new or modified reactors. At the same time, feedstock efficiency can also be improved.

Product change and improvement in product quality

- Switching production from polyester fiber to bottle-grade polyester or vice versa increases the market opportunities of a customer.
- Small-scale fiber and PET plants can be converted to produce special polyesters, such as PTT, PBT, PBS, PEN and copolyesters.
- Revamping polyamide plants with the oligomer degradation process (OMDP[®]) allows all of the caprolactam feedstock to be processed into high-quality chips for textile or technical applications. This technology reduces the level of cyclic oligomers in the products, thus greatly improving overall product quality.

Feedstock change

- Changing the feedstock used in the production of polyester from DMT to PTA enables customers to tailor their plants to new market requirements.
- We offer polyamide 6.6 plant revamps to integrate a continuous process for the production of the required AH-salt feedstock from hexamethylene diamine and adipic acid.

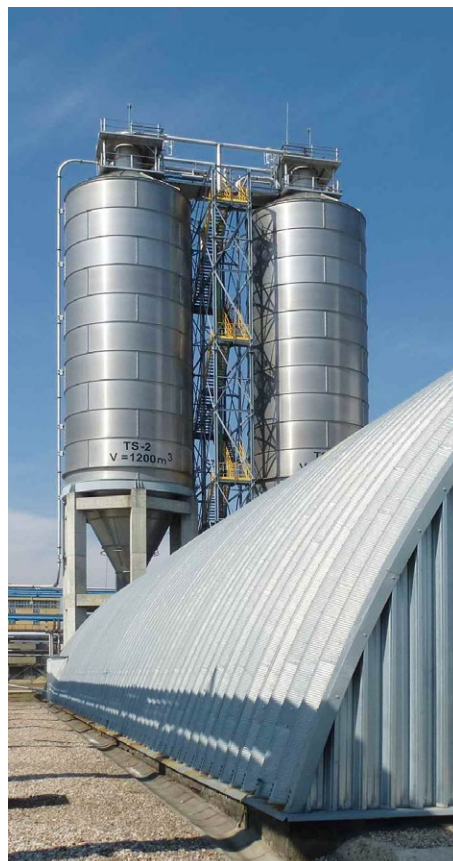

Recycling technologies

- The FTR[®] polyester process ensures the production of top-quality pellets with recycled content. This technology can be integrated into existing polymerization plants and uses up to 50% of recycled bottle flakes as feedstock.

Retrofit with MTR[®] (Melt-To-Resin) Technology

- Existing PET polycondensation plants are retrofitted with MTR[®] (Melt-To-Resin) technology to eliminate the solid state postcondensation step with its high energy demand. Additionally, a capacity increase can be achieved.



Performance Services

An investment that pays off

Improvement in plant performance

We provide our customers with professional services to unlock the full potential of their production plants. Within the scope of a service project, our specialists can draw up a concept study to describe and analyze potential technical solutions. Against this background, we carry out an investment appraisal to compare different variants and supply the customer with the optimum service.

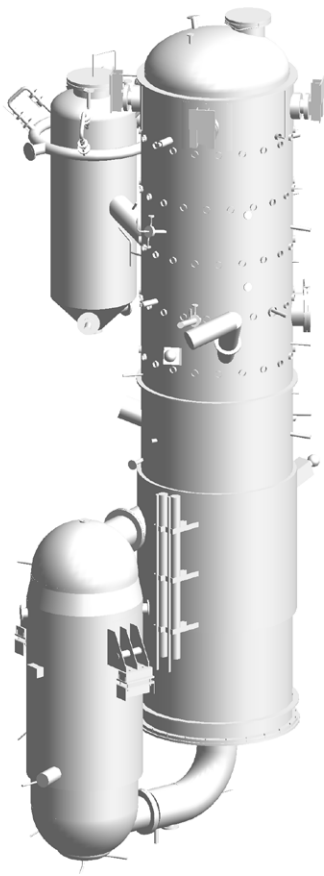

Tailor-made reactors for process revamps

Case study 1: Debottlenecking a PET production plant

This case study concerns a polyester plant capacity expansion from 500 t/day to 650 t/day. The investment would break even after less than 3 years. After only 4 years the expanded plant would achieve a total extra profit of approximately 10%.

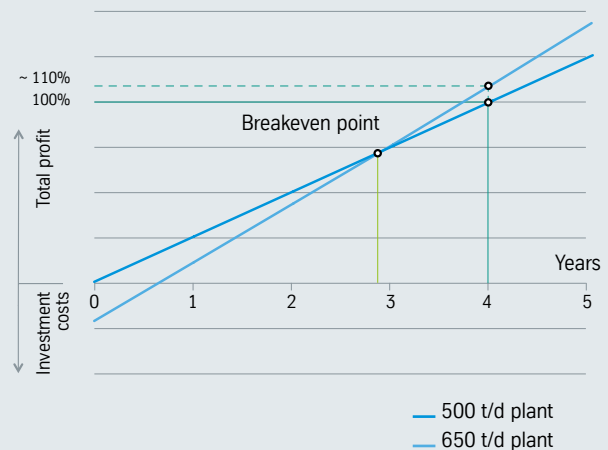

Case study 2: Improvement in product quality in a polyamide plant

This case study concerns a 150 t/day polyamide plant revamp using the oligomer degradation process (OMDP®). Use of the OMDP® process would significantly improve the quality of the material produced and increase the sales price. The breakeven point would already be achieved after less than 2 years. The revamped plant would achieve an total extra profit of over 10% after 4 years.

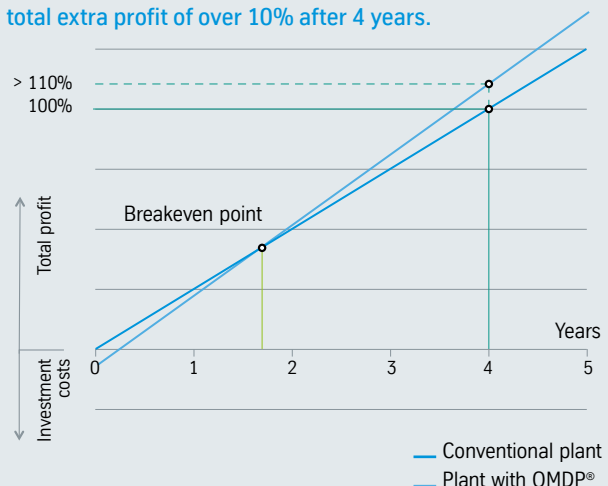

System Services

Service solutions from the technology provider

Global services

Our service teams of experienced process engineers, fitters and welders are active throughout the world, supporting our customers with on-the-spot inspection, maintenance and repair work. As part of the global thyssenkrupp Industrial Solutions network with engineering offices in all key markets, we offer country-specific competences and thus individual, tailored services.

Inspection, maintenance and repair work

- Specific knowledge about the technology and condition of the respective plant
- Analysis of the whole process chain for early detection of potential faults
- Prompt and competent elimination of potential faults
- Maintenance and overhaul of patented process vessels and equipment items by specialists
- Leak detection at plants in operation

Spare parts services

- Procurement and supply of spare parts
- Rapid availability of key equipment items owing to proprietary warehousing facilities

Erection, commissioning support and supervision

- Professional project management
- Supervision of erection and commissioning
- Training of customers' operating personnel by experienced UIF Polycondensation Technologies operation experts
- Provision of consultants to support customers with plant operation

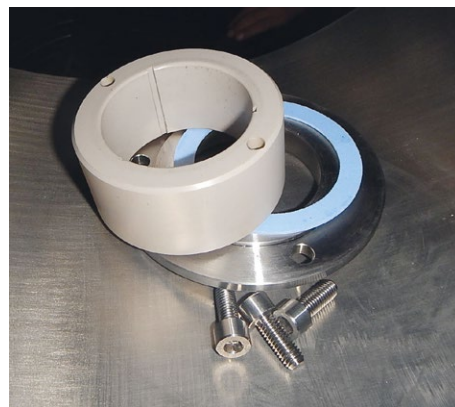

Consulting Services

Scientific expertise for your business success

Technical studies

For each phase of a plant project, highly specialized engineers prepare customer-tailored concept studies with recommendations to help the customer make a decision with respect to plant engineering, selection of the technology and process, and conceptual design.

- Identification and detailed analysis of technical parameters and customer requirements
- Technical comparison of revamp concepts
- Identification of constraints, initial assessment of technical scope of revamp and initial estimates with regard to project investment cost and schedule
- Examination of technical feasibility
- Description of processes and technologies

Pilot plant tests and lab services

The polymerization plants built by us are based on patented process technologies and key components which have been developed at our own pilot plants and are subject to constant optimization.

Pilot plants for the production of PET, PA, PBT, copolyester and PLA enable customers to try out our proprietary processes through pilot tests, the production of sample material and the testing of additives and catalysts.

In addition, we offer our customers consulting services regarding the installation and equipment of research and analysis laboratories as well as other technological matters. We also provide training programs for the customers' personnel.



The Power Of True Efficiency

Optimal solutions for specific requirements

thyssenkrupp Industrial Solutions is one of the world's leading engineering companies for licensing, planning and constructing high-tech chemical plants. Around 19,000 specialists at over 70 locations around the globe ensure the highest degree of productivity as well as cost-effective, innovative and custom-made solutions to meet the technological and economic challenges of our customers. We offer a comprehensive array of services covering the entire life cycle of a plant.

UIF Polycondensation Technologies offer our proprietary, cutting-edge polycondensation technologies for producing various grades of polyesters, polyamides and sustainable biopolymers, such as polylactic acids, with customizable viscosity levels ranging from high to medium to low. These technologies are based on Uhde Inventa-Fischer's know-how, the engineering experience gained in the construction of more than 450 polymer plants worldwide since 1924 and through intensive research and development work in close cooperation with prominent scientific and industrial

partners. UIF Polycondensation Technologies has successfully established a large variety of self-developed, patented technologies and processes in the global market. Our customers can take advantage of these technologies to gain an edge over their competitors.

UIF Polycondensation Technologies, as part of thyssenkrupp Industrial Solution's polymer division, are located in Berlin, Germany and Domat/Ems, Switzerland. Around 150 polymerization specialists and engineers cover the entire field of professional project execution, from plant engineering with the delivery of proprietary and key equipment only up to procurement and construction services for turnkey EPC projects, working in close cooperation with local organizations of thyssenkrupp Industrial Solutions.

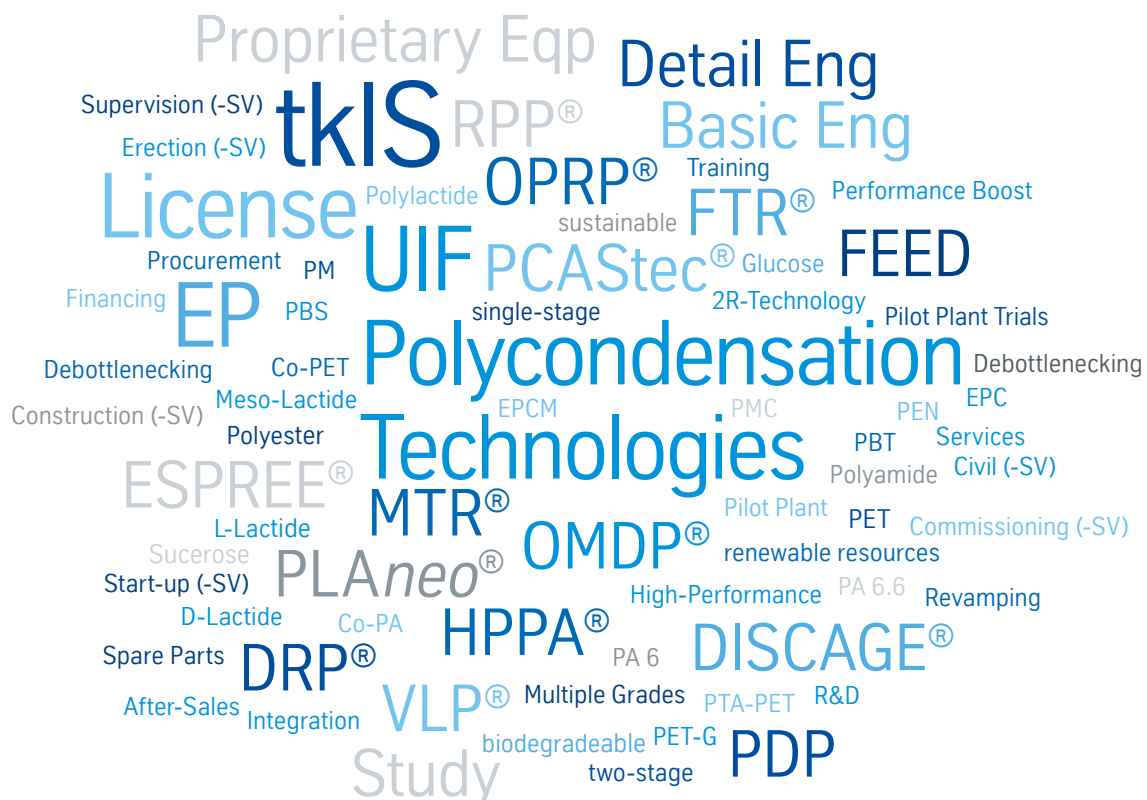

thyssenkrupp Industrial Solutions AG

Uhde Inventa-Fischer GmbH
Holzhauser Strasse 157–159
13509 Berlin, Germany
P: +49 30 43 567 5
F: +49 30 43 567 699

Uhde Inventa-Fischer AG
Via Innovativa 31
7013 Domat/Ems, Switzerland
P: +41 81 632 63 11
F: +41 81 632 74 03

www.uhde-inventa-fischer.com
info@uhde-inventa-fischer.com

engineering.tomorrow.together.