

Q·LOGIC 3^e

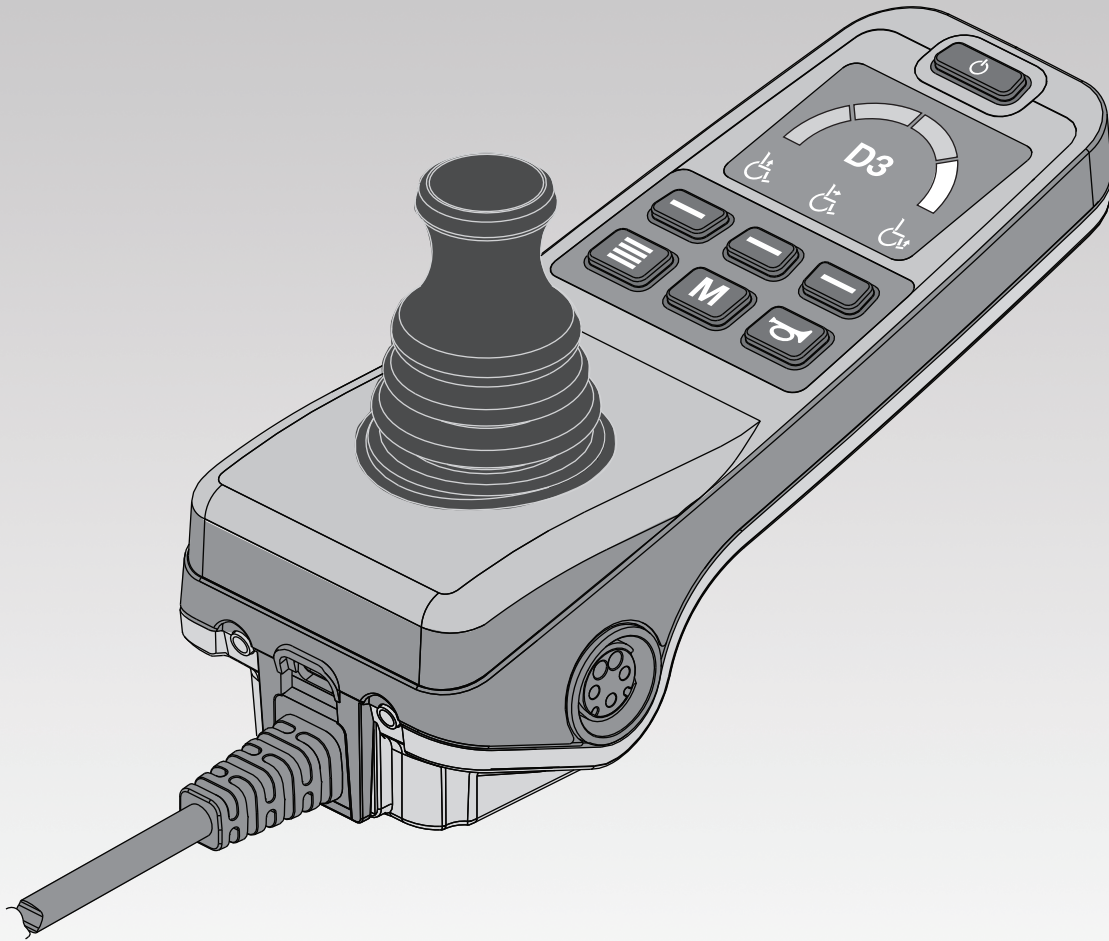

QUANTUM[®]

PROVIDING GREATER INDEPENDENCE

IDENTIFICATION KEY

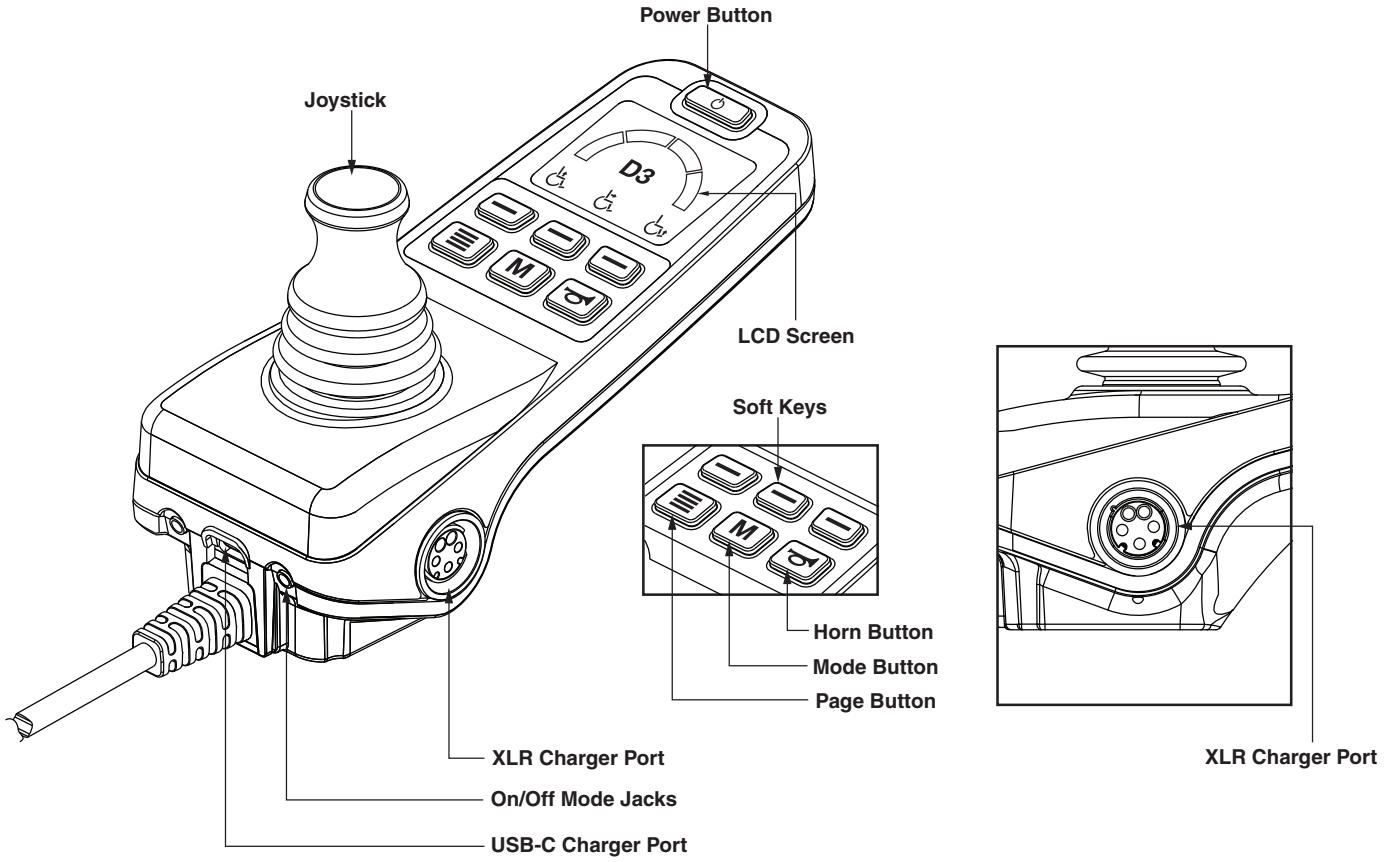

Attendant Control

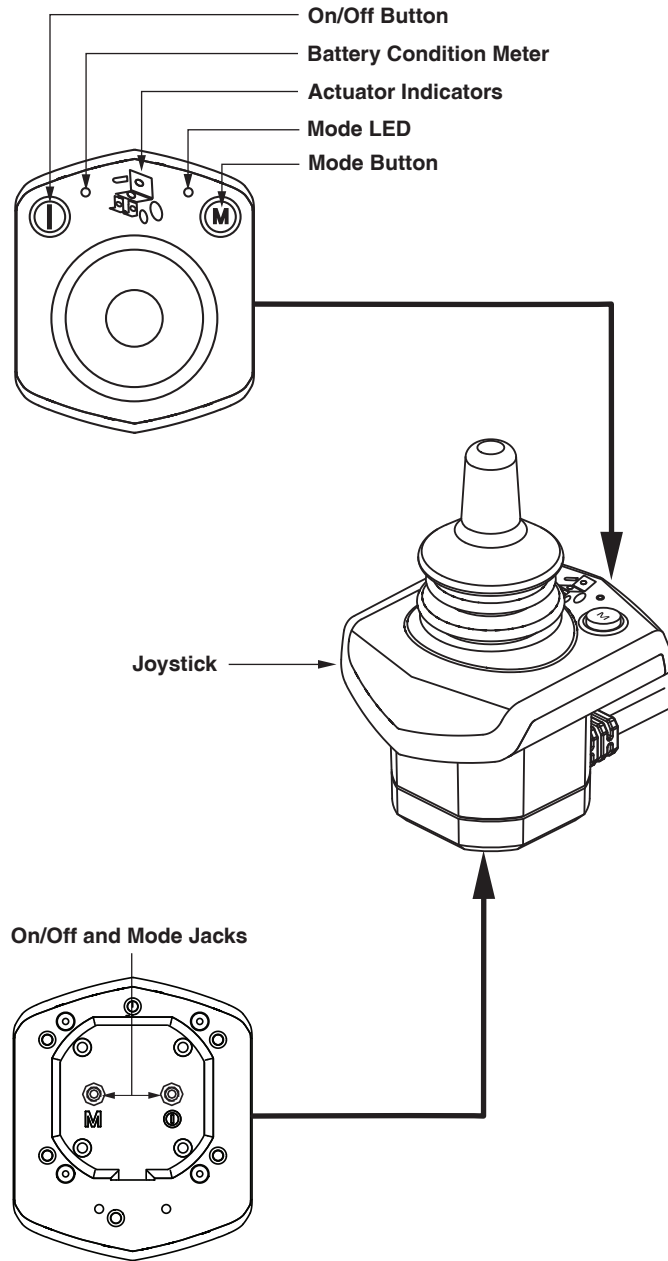

Safety Guidelines

WARNING!

A Quantum Rehab Provider or a qualified technician must perform the initial setup of this product and must perform all of the instructions in this manual.

The symbols below are used throughout this owner's manual and on the power chair to identify warnings and important information. It is very important for you to read them and understand them completely.

WARNING!

Indicates a potentially hazardous condition/situation. Failure to follow designated procedures can cause either personal injury, component damage, or malfunction. On the product, this icon is represented as a black symbol on a yellow triangle with a black border.

MANDATORY!

These actions should be performed as specified. Failure to perform mandatory actions can cause personal injury and/or equipment damage. On the product, this icon is represented as a white symbol on a blue dot with a white border.

PROHIBITED!

These actions are prohibited. These actions should not be performed at any time or in any circumstances. Performing a prohibited action can cause personal injury and/or equipment damage. On the product, this icon is represented as a black symbol with a red circle and a red slash.

Intended Use

A wheelchair component is a device intended for medical purposes that is generally sold as an integral part of a wheelchair, but may also be sold separately as a replacement part.

Regarding Devices for Prescription Use

WARNING!

CAUTION! Federal law restricts this device to sale by or on the order of a physician or other certified personnel licensed by the law of the State (US only) or region in which this personnel practices to use or order the use of the device.

NOTE: These instructions are compiled from the latest specifications and product information available at the time of publication. We reserve the right to make changes as they become necessary. Any changes to our products may cause slight variations between the illustrations and explanations in this manual and the product you have purchased. The latest/current version of this manual is available on our website.

NOTE: This product is compliant with WEEE, RoHS, and REACH directives and requirements.

NOTE: This product meets IPX4 classification (IEC 60529).

NOTE: The Q-Logic 3e Controller and its components are not made with natural rubber latex. Consult with the manufacturer regarding any after-market accessories.

Table of Contents

Product Safety Symbols 5

The Q-Logic 3e Controller 6

Precautionary Guidelines 6

Operating the Q-Logic 3e Controller 6

On/Off Button..... 6

Joystick..... 6

Lock/Unlock Procedure 6

Speed Adjustment 6

Keypad..... 7

Horn Button 7

Mode Button 7

Page Button 7

Soft Keys 7

Light Soft Keys..... 7

Left/Right Turn Indicator Soft Keys 7

LCD Screen 8

Drive Profile Selection 9

Actuator Adjustment (Seat Screen) 9

iLevel® Feature (Optional)..... 10

Settings Screen 12

USB Charging..... 13

Bluetooth Functions..... 13

Interactive Assist 13

Attendant Control 14

Thermal Rollback..... 14

Battery Condition Meter..... 14

Battery Life Indicator..... 15

Q-Logic 3e Error Codes 15

Care and Maintenance 16

Temperature 16

Warranty 16

Graphic User Interface Icons..... 17

Product Safety Symbols

The symbols below are used on the controller to identify warnings, mandatory actions, and prohibited actions. It is very important for you to read and understand them completely.



Read and follow the instructions in the owner's manual.



Avoid exposure to rain, snow, ice, salt, or standing water whenever possible. Maintain and store in a clean and dry condition.



EMI/RFI - This product has been tested and passed at an immunity level of 20 V/m.



Disposal and recycling - Contact your Quantum Rehab Provider for information on proper disposal and recycling of your Quantum product and its packaging.

The Q-Logic 3e Controller

The Q-Logic 3e Controller is a fully programmable, modular electronic controller system that allows you to operate your power chair. The hand control will primarily be discussed in this manual along with references to the Attendant Control. Contact your Quantum Rehab Provider for more information.

The controller has been pre-programmed to meet a typical user's needs. The program is adjusted using either a personal computer with software provided by the controller manufacturer or with a handheld programmer, also provided by the controller manufacturer, by your Quantum Rehab Provider or a trained service technician.

WARNING!

The controller program can affect speed acceleration, deceleration, dynamic stability, and braking. If it is programmed incorrectly or outside of the safe limits as determined by your healthcare professional, it can create a dangerous situation. Only your Quantum Rehab Provider or a trained technician should program your controller.

Precautionary Guidelines

Before operating the Q-Logic 3e Controller please read the following. These guidelines are provided for your benefit and will aid you in the safe operation of the seating system.

- Turn off the power to the controller before you are seated in your power chair.
- Always have assistance when you are being seated in your power chair.
- Follow all of the procedures and heed the warnings as explained in your power chair owner's manual and Consumer Safety Guide.

Operating the Q-Logic 3e Controller

The Q-Logic 3e hand control is used to operate your power chair and all of its components.

On/Off Button

The On/Off button turns the system on and off. It also resets the controller if the LCD screen shows a prompt of a finger pressing the power button when programming has been updated

WARNING!

When faced with an emergency situation, release the joystick, then press the on/off to stop the power chair. Use caution. Be advised that pressing the on/off button may cause the power chair to stop abruptly.

Always turn the power off when you are stationary to prevent unexpected movement.

Joystick

The joystick controls the driving speed and direction of the power chair and is used to navigate the menus on the LCD screen. When the joystick is at rest, it is in the neutral (center) position and the chair is stationary. In order to drive the chair, the joystick must be taken out of neutral. Moving the joystick in any direction will switch the chair from neutral to drive, and the chair will move in the direction indicated by the joystick position. The farther away from the neutral position the joystick is, the faster the chair will move in that direction. To stop chair movement, simply release the joystick or move it back to the neutral position. The chair's electromagnetic brakes will engage after the chair has come to a controlled stop.

Lock/Unlock Procedure

The Q-Logic 3e Controller comes with a programmable lock/unlock option.

NOTE: The lock-out feature is not programmed at the factory. To have this feature added, contact your Quantum Rehab Provider.

To lock the controller:

1. Push the On/Off Button once to power on the chair and the controller.
2. Push and hold the Mode Button **M** until the controller turns off. The controller is now locked.

To unlock the controller:

1. Push the On/Off Button  once to power on the chair and the controller. The "System Lock Icon" will appear on the display screen.
2. Move the joystick to the full forward position until you hear a beep.

NOTE: This will take several seconds.

3. Move the joystick to the full reverse position until you hear a beep.

NOTE: This will take several seconds.

4. Release the joystick. The controller is now unlocked.

Speed Adjustment

The speed adjustment is used to control the speed of the power chair.

To change the speed:

1. Push the On/Off Button once to power on the chair and the controller.
2. To increase your speed, press the speed up soft key.
3. To decrease your speed, press speed down soft key.

The speed indicator arc will increase and decrease as the speed arc keys are pressed, providing a visual display of how fast the chair will move.

Keypad

The keypad is located directly in front of the joystick. It contains the components that you will use to control your power chair.

Horn Button 

The horn button activates a warning horn.

Mode Button 

The mode button is used to cycle through Drive Profiles, Seat Mode (if equipped) and Settings Mode.

Page Button 

The page button is used to cycle through the soft key pages.

NOTE: The soft key pages can be changed by your Quantum Rehab Provider.

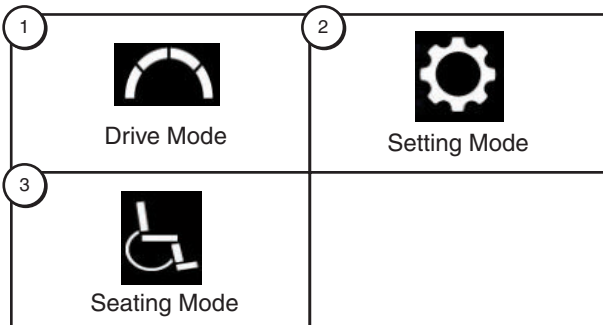
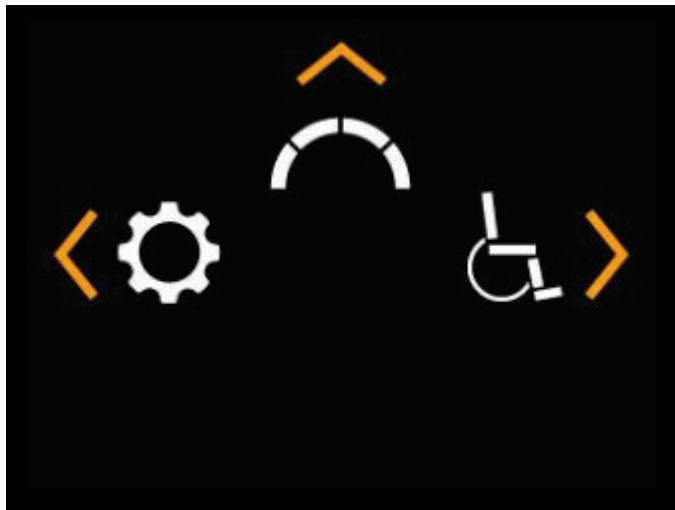

Soft Keys 

The soft keys will perform the action depicted directly above them. This action may change depending on the screen and it will change with the page button.

NOTE: If your Q-Logic 3e Controller is equipped with a lighting system, the soft key buttons will default to a light and left/right turn indicator.

Light Soft Key 

The light soft key controls the front headlights and rear running lights.

To operate the lights:

1. Push the On/Off Button once to power on the chair and the controller.
2. Press the light soft keys button once to activate the front headlights and rear running lights.
3. Press the light soft key button again to turn off the lighting system.

NOTE: On the Drive Screens a light icon will be displayed above the speed arc when the headlights are on.

Left/Right Turn Indicator Soft Keys

The left/right turn indicator soft keys toggle either the left or right turn indicators.

To operate the turn indicators:  

1. Push the On/Off Button once to power on the chair and the controller.
2. Press the desired turn indicator soft key once to turn on that indicator.
3. Press the same turn indicator soft key again to turn off that indicator.



NOTE: If the left turn indicator is activated, pressing the right indicator soft key will turn off the left indicator and activate the right indicator.

NOTE: On the Drive Screens a Left/Right turn indicator icon will be displayed next to the speed arc when the Left/Right turn indicator is on.

NOTE: The turn indicator soft keys also control the hazard lights. Press both turn indicator soft keys at the same time to activate the hazard lights and press both buttons again to turn off the hazard lights. If the hazard lights are left on and the controller is turned off, the hazard lights will continue to flash. The Q-Logic 3e must be turned back on and both turn indicator buttons must be pressed to deactivate the hazard lights.

LCD Screen 

The Q-Logic 3e provides the user with easily intuited feedback information via the LCD screen. The top left corner of the screen will indicate any drive restrictions.

No icon		Full drive speed
Yellow Caution Icon		Limited Drive Speed
Red Warning Icon		Full Drive Lockout

Outdoor Graphic User Interface 

The Q-Logic 3e includes an outdoor Graphic User Interface that increases the contrast of the screen to make it easier to be seen in natural light.

To switch from the indoor to outdoor Graphic User Interface or from the outdoor to indoor Graphic User Interface, press and hold page button until the screen changes. 

Drive Screen

The LCD screen, provides the current profile, drive operation, and the speed adjustment settings.

Drive/Function Inhibit status is depicted as an icon at the top left of the screen. Actuator adjustment will affect the inhibit status. As your seat and/or back angle increases, a red icon will indicate full drive lockout. If your power chair is equipped with a seating system lift, a yellow icon will indicate speed reduction as the seat is elevated. To return your power chair to full speed, reverse operation.

To Access the Drive Screen from the Home Screen 

1. Push the joystick up for the "Drive Screen."

NOTE: To access the Drive Screen from any other screen, press the Mode Button  until the desired Drive Profile is reached.

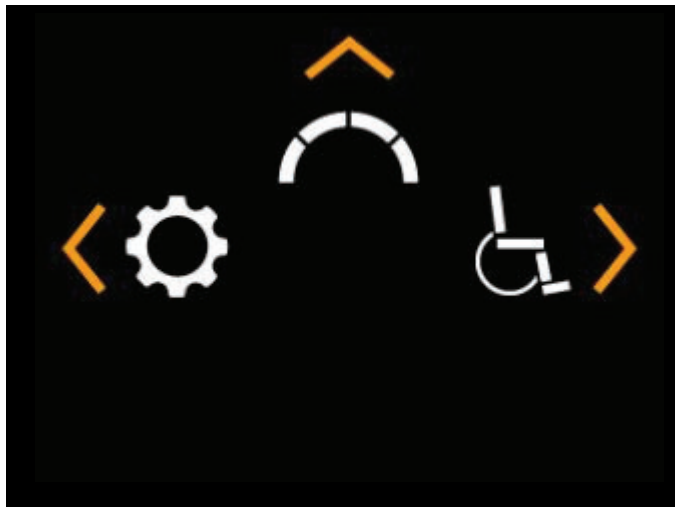
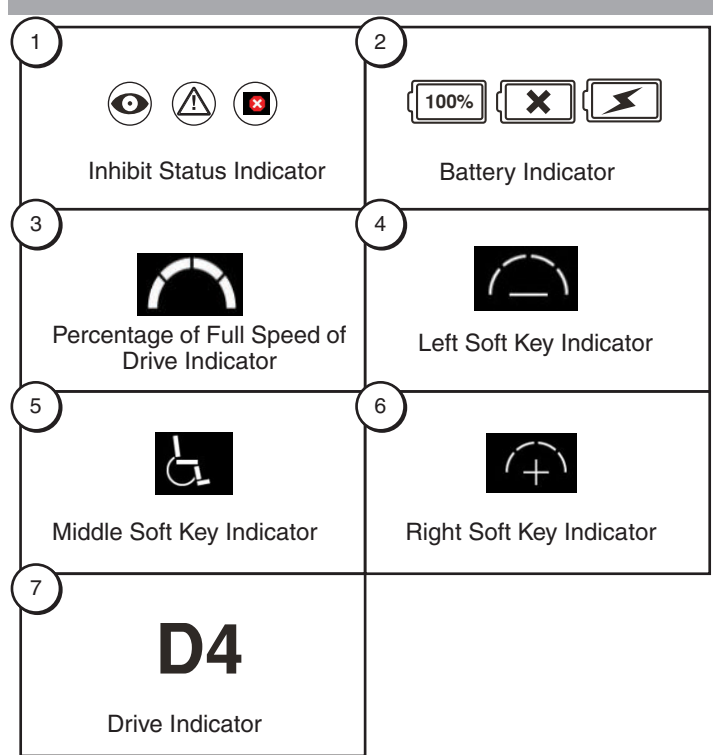

Drive Profile Selection

Your Q-Logic 3e Controller may be programmed for up to four drive profiles that allow the system to be custom-tailored to your environment. Profiles 1 – 3 may be selected by pressing the Mode button. The selected profile is displayed on the Drive Screen.

NOTE: Drive profiles are set by your Quantum Rehab Provider. Contact your Quantum Rehab Provider to change or add a drive profile.

To select a profile setting using the Mode Button:

1. Push the On/Off Button once to power on the chair and the controller.
2. Push the Mode Button to select a drive profile. Cycle through the four available drive profiles.
3. Continuing to push the button will cycle through the Setting screen and Seat screen (if power positioning is present), then back to Drive profile 1.

WARNING!

Drive/Function Inhibit status is read-only in your actuator adjustment (seat screen). This function is disabled in drive mode in order to prevent unintended loss of function in your power chair. Take caution when negotiating, obstacles, ramps, and inclines. Whenever possible, use an attendant in these conditions.

Operating your power chair on inclines and/or with tilt/recline function will affect your power chair's stability.

Actuator Adjustment (Seat Screen)

The Q-Logic 3e Controller can control five power seat actuators, using the mode button and the joystick.

To select and adjust an actuator:

1. Push the On/Off Button once to power on the chair and the controller.
2. Push the Mode Button several times until the seat screen is displayed on the LCD or push the middle soft key button once to go directly to actuator mode.
3. Push the joystick to the left or right to cycle through the available actuators until the desired actuators are illuminated on the actuator indicator. **See figure 1.**
4. When the desired actuator is selected, give a forward command to the joystick to adjust position in one direction or give a reverse command to the joystick to adjust position in the opposite direction. If you continue to push the Mode Button, it will cycle through the Drive screens and Auxiliary screen, and then return to Seat Screen.
5. Push the Mode Button until you return to the desired drive profile.

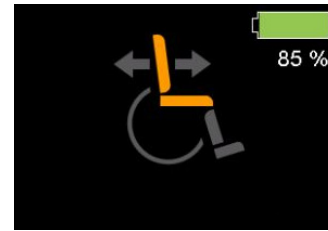

Tilt Mode



Recline Mode



Elevating Seat Mode



Recline & ELR/ ALR Mode (both)

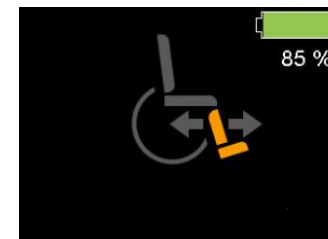

Articulating Foot Platform

Figure 1. Actuator Selection

NOTE: The Drive/Function Inhibit status is affected only in the actuator adjustment (seat screen).

iLevel Feature (Optional)

Your power chair may be equipped with the iLevel feature that will be used in conjunction with your seating system. The iLevel feature is mounted on a Quantum power base for enhanced stability when the seating system is elevated.

There are certain situations, including some medical conditions, where the power chair user will need to practice operating the power chair equipped with iLevel in the presence of a trained attendant. A trained attendant can be defined as a family member or care professional specially trained in assisting a power chair user in various daily living activities.

As you begin using iLevel during daily activities, you will probably encounter situations in which you will need some practice. Simply take your time and you will soon be in full and confident control.

Elevation (Seat Screen)

The iLevel feature can be activated by selecting the elevating seat actuator.

To select and adjust the seat elevation using the Q-Logic 3e Controller:

1. Push the On/Off Button once to power on the chair and the controller.
2. Push the Mode Button several times until the seat screen is displayed on the LCD or push the middle soft key button once to go directly to seat screen. **See figure 1.**
3. Push the joystick to the left or right to cycle through to the elevating seat mode, this is illuminated on the actuator indicator.

NOTE: If your Q-Logic 3e settings are different than those described, contact your Quantum Rehab Provider. Your Quantum Rehab Provider may have changed the programming of your Q-Logic 3e Controller.

4. When the elevating seat mode is selected, give a forward command to the joystick to adjust position in one direction or give a reverse command to the joystick to adjust position in the opposite direction.
5. If you want to return to another profile, push the Mode Button to return to the desired drive profile.

To activate the iLevel using a single switch:

1. Press once and hold the single switch once to raise the seat and activate iLevel.
2. Press and hold the single switch to lower the seat.

NOTE: The iLevel feature is automatically engaged when the power elevating seat is activated and the iLevel indicator is displayed on your controller. See figure 2.

The power chair should be used on an indoor, level surface, such as malls, offices, and/or medical facilities to activate iLevel. Once the seating system actuator is started, the iLevel boots inhibit movement on the front caster arms. The seating system can be reclined or tilted up to 20° while the iLevel feature is activated.

WARNING!

The iLevel feature should be used only on a flat, level, indoor surface, such as in malls, offices, and/or medical facilities. Never raise the seat from its lowest position on an inclined surface. Failure to heed this warning can result in the power chair tipping over.

The iLevel feature is intended for limited outdoor use on only flat level, hardscape surfaces. If you are unsure of your environment, do not use iLevel outdoors.

Never raise the seat into iLevel when operating your power chair on bumpy or uneven surfaces. Failure to heed this warning can result in the power chair tipping over.

Always fasten the positioning belt when operating the power chair.

Do not operate the iLevel or change the seat height in any way while your power chair is positioned under a fixed object, such as a table or a desk. Keep area clear prior to and during movement.

PROHIBITED!



Never use the iLevel outdoors on uneven terrain (gravel, hills or other uneven, non-compact terrain) or in fields.

Never use iLevel while ascending or descending a curb or uneven surface of any height.

NOTE: The iLevel feature is equipped with a system that allows the power chair to drive at a predetermined, safe speed when the seat is elevated. Always check to be sure this system is operating properly before using your power chair.

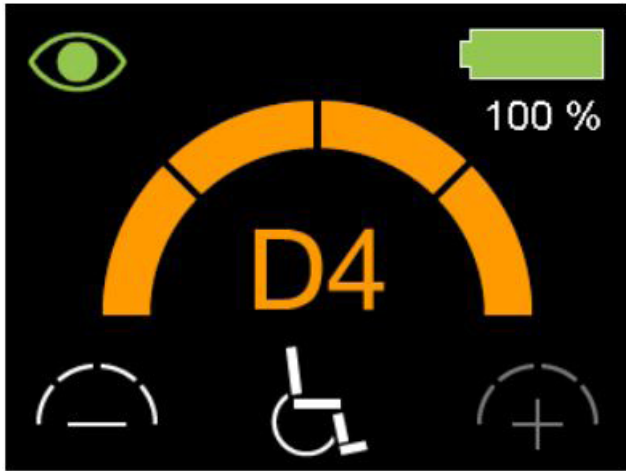
NOTE: If a warning or visual indicator appears on your controller stating that iLevel is not engaged, the power chair's speed will be reduced to 25% when elevated. If this warning appears while on level ground, please discontinue use of iLevel feature and consult your Quantum Rehab Provider for assistance.



<p>1a</p>  <p>Safe Elevation</p>	<p>1b</p>  <p>Reduced speed restriction</p>
<p>1c</p>  <p>Full drive lockout</p>	

Definitions of Indicators

- 1a - Safe Elevation
- 1b - Reduced speed restriction
- 1c - Full drive lockout



iLevel not engaged



Figure 2. Q-Logic 3e Controller Indicators

Settings Screens 

The following pages explain the various screens you will use with the Q-Logic 3e Controller. Contact your Quantum Rehab Provider with any questions you may have.

NOTE: Some screens in this Basic Operating Instructions may differ from your system depending on configuration and options selected.

To change the horn volume: 

1. Push the Mode button, until setting screen is displayed.
2. Push the joystick up to enter the available setting subjects. Push left or right to change the settings.
3. When the desired subject is displayed on the screen, push the joystick up or down to adjust that setting.

After "Horn" is displayed, an up command will increase volume, a down command will decrease volume.

NOTE: Any time a setting is changed, the system will back up the configuration to the power base. When the system is turned off, "parameter backup"  will be displayed on the screen before the system turns off.

To change the display brightness:

1. Push the Mode button, until setting screen is displayed.
2. Push the joystick up to enter the available setting subjects. Push left or right to change settings subject.
3. When the desired subject is displayed on the screen, push the joystick up or down to adjust that subject.

After "Display Brightness" is displayed, an up command will increase brightness and a down command will decrease brightness.

To change the horn volume: 

1.



Drive Screen

2.

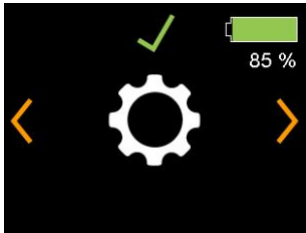

Settings

3.

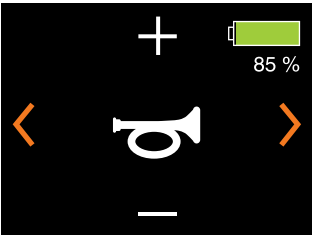

Sound

To change the display setting:

1.



Drive Screen

2.



Settings

3.

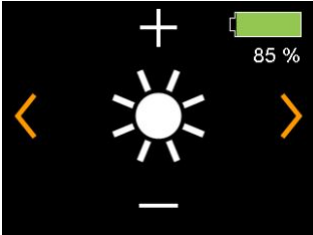

Brightness

USB Charging Port

The Q-Logic 3e hand control includes a USB-C port for charging small devices.

The USB port will output up to 1.5 Amps depending on the adaptor.

The Q-Logic 3e system includes Bluetooth that can be used to program the Q-Logic 3e electronics.

If a programmer is connected to the power chair, the Q-Logic 3e screen will ask the user to accept Bluetooth access by programming device.

1. To accept the Bluetooth connection, perform a forward command on the power chair's input device.

Interactive Assist

The Interactive Assist uses the Q-Logic 3e's Bluetooth connection to allow your provider access to the Q-Logic 3e's Diagnostic information. The connection requires the user to accept access similar to the Bluetooth programming. Refer to the Interactive Assist manual for details.

To accept Bluetooth access by programming device:

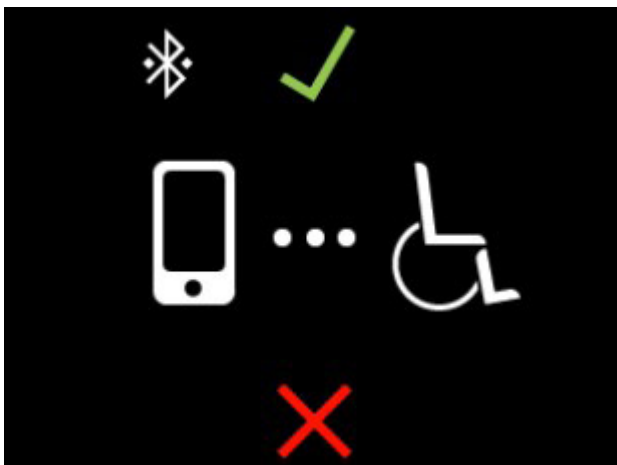

NOTE: This product has been tested for Electromagnetic and Radio Frequency Interference (EMI/RFI) and has met standard requirements. Please refer to the Consumer Safety Guide for more information regarding EMI/RFI. Although we do not recommend using a cell phone while operating a power chair, the system is capable of receiving and/or making calls through a cell phone device, accessing music files or contact lists, and navigating a device menu.

Bluetooth Electronic Specifications

Bluetooth Output Power	10 mW
Operation Range	40 m LOS (Line of Sight)
Operating Temperature	-40°F to 185°F / -40°C to 85°C
Storage Temperature	-67°F to 302°F / -55°C to 150°C
RF Wireless Technology Type	Co-existence with IEEE 802.11 (AWMA, AFH)
Encryption Security	128-bit

EMC Testing on Sample Wheelchair

Susceptibility	Tested to 20V/m to IEC 61000-4-3
Emissions	To CISPR11, Group 1, Class B
ESD	To IEC 61000-4-2

FCC ID

FCC Information contains transmitter module

FCC ID:	T7V1316
IC:	216Q-1316

Attendant Control

For more information on this applications, contact your Quantum Rehab Provider.

The Attendant Control is laid out:

- On/Off Button
Enables/disables power
- Mode Button
Cycle through Drive Profiles and Seat Mode (if equipped)
- Battery Condition Meter
Indicates battery charge
- Actuator LEDs
Indicates actuators in use
- Mode LED
Used for profile selection
- Joystick
They joystick controls speed and direction in Drive mode. Push the joystick to the right to select actuators in Seat mode. Move the joystick forward or backward to activate the desired actuator(s).
- On/Off and Mode Jacks
Allow for remote On/Off and Mode switch installations

Thermal Rollback

The Q-Logic 3e Controller is equipped with a thermal rollback circuit that monitors the temperature of the power chair's motors and controller. If either exceeds the safe operating temperature, the controller reduces the output to 20% of full operation level. This reduces the power chair's speed and allows a cool-down period. Once the temperature returns to a safe level, the power chair will resume normal operation.

Battery Condition Meter

The battery condition meter is in front of the joystick on the controller and as an LED on the Attendant Control.

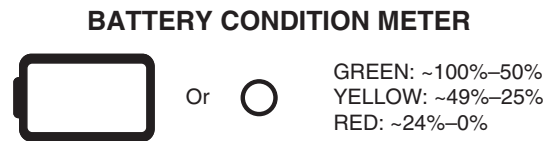

Figure 3. Battery Condition Meter

Battery Life Indicator

The Q-Logic 3e Controller system uses pop-ups to indicate the remaining battery life of the power chair. The system will show information screens when the battery voltage is at 50%, 30%, and 15%. If the pop-ups are not needed, this feature can be disabled, using a programmer, such as Econ-W or Econ-I, under the display settings.



Battery Charge 50%



Battery Charge 30%



Battery Charge 15%

Q-Logic 3e Error Codes

The Q-Logic 3e Controller displays two types of messages: warning and error. **See figure 4.**

- **Warning:** Alerts you to conditions that may affect power chair functionality and performance.
- **Error:** Alerts you to conditions that influence power chair functionality and performance.

Error codes are displayed on the LCD by number. The following table identifies the error codes that may be easily rectified, probably causes, and possible solutions. If you receive one of these error codes, follow the recommended solution, and if the problem persists, you receive any other error code or experience any other problem with your power chair, contact your Quantum Rehab Provider.



INFORMATION



WARNING



ERROR

Figure 4. Error Codes

Care and Maintenance

Refer to your power chair owner's manual for proper cleaning and disposal instructions.

Temperature













Some of the parts of your power chair are susceptible to extreme changes in temperature. Always keep your power chair between the temperatures of 18°F (-8°C) and 122°F (50°C).

Warranty

Refer to your power chair owner's manual for specific information on controller warranty.











Graphic User Interface - General System





Item	Icon Name	Icon visual	Comments
X4	Power Cycle		Shown when power cycle is required. Indicates a required action/input.
X5	DB backup		Shows when system is backing up any changes made.
X6	DB restore		Shows when system is restoring parameters from Power base.
X7	Animated bar; Animated element		Shows when system is processing internally.
X8	Firmware update		Shown if system has detected an update and asks to confirm the installation upon a forward input command. Similarity to BT connection x. Icon Select on top, "Update" text on the bottom. Indicates a required action/input.
X9	Home drive		A forward command will move to the first drive profile.
X10	Home seat		A right command will move to the seat screen.
X11	Home settings		A left command will move to the settings screen.
X12	Battery outline; Battery X, Battery charging		The battery state shall have the following state indications: <ol style="list-style-type: none"> 1. Green, 100% segments (total, full) 2. Green, 80% segment 3. Green, 60% segment 4. Yellow, 40% segment 5. Red, 20% segment 6. Red Cross (empty) Percentage is shown below. While charging, an indication shall be added in front of it.
X13	BT visible		Shows when Bluetooth is enabled.
X14	BT connected		Shows when Bluetooth is connected.
X15	Configuring network		Item that indicates that the system modules are being configured. Shows animated bar below.

18 BASIC OPERATION INSTRUCTIONS

GUI Icons - Drive

Item	Icon Name	Icon visual	Comments
D1.1	Drive 1 to 4		Shown while in drive profile. 4 profiles. Example: D1.
D1.2	Drive Indoor slow; Drive indoor moderate; Drive outdoor fast; Drive school; Drive work; Drive ramp; Drive sport		Icon to represent drive profile as opposed to Dx, must be programmed by the dealer. Outdoor fast icon shown.
D1.3	Drive green circle; Drive purple pentagon; Drive white square; Drive red triangle; Drive blue cross; Drive yellow star		Icon to represent drive profile as opposed to Dx, must be programmed by dealer. Yellow star symbol shown.
D2	Drive 5 - 100		Shows reachable profile speed with speed adjust setting. 19 items. Example. 60%.
D4	iLevel		Shown if iLevel drive mode is active while seat is elevated. Shown in drive and seat screens.
D5	Drive restricted		Shown if a drive speed restriction of any source is active. Shown in drive and seat screens.
D6	Drive Inhibited		Shown if driving is inhibited. Shown in drive and seat screens.
D7	Attendant Drive 1/2		The attendant drive has 2 profiles.

Lights, Indicators, Hazard

Item	Icon Name	Icon visual	Comments
L1	Light on		Icon shows while light status "on". No icon shows if light status "off."
L2	Indicator left on		Icon shows while left indicator "on". Shall alternate on and off. No icon shows if left indicator "off."
L3	Indicator right on		Icon shows while right indicator "on". Will alternate on and off. No icon shows if right indicator "off."
L4	Hazard on		Icons show while hazard status "on". Will alternate on and off. No icons show if hazard "off." Use indicator icons.

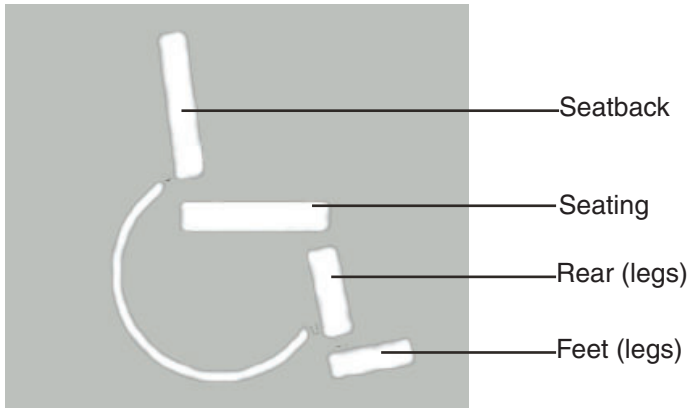

Seat













Seat Icons

Item	Icon Name	Icon Visual	Comments
S1	Main Seat Tilt Forward		Seating and seatback icon, both highlighted. Direction arrows, forward highlighted.
S2	Main Seat Tilt Backward		Seating and seatback icon, both highlighted. Direction arrows, backward highlighted.
S3	Main Seat Recline Forward		Seatback icon highlighted. Direction arrows, forward highlighted.
S4	Main Seat Recline Backward		Seatback icon highlighted. Direction arrows, backward highlighted.
S5	Main Seat elevate up		Seating highlighted. Direction arrows, up highlighted.
S6	Main Seat elevate down		Seating highlighted. Direction arrows, down highlighted.
S7	Main Seat AFP, Legs out		Used, if both legs operate at the same time: -AFP -Legs -Left leg & right leg combined Foot platform, consisting of 2 elements (1 rear, 1 feet), both highlighted. Arrows, forward highlighted.
S8	Main Seat, AFP, Legs in		Used, if both legs operate at the same time: -AFP -Legs -Left leg & right leg combined Foot platform, consisting of 2 elements (1 rear, 1 feet), both highlighted. Arrows, forward highlighted.
S9	Main Seat Legs up		Consisting of 2 elements (1 rear, 1 feet) feet highlighted. Left side chair view. Arrows, reverse highlighted (same placement as 4.1)
S10	Main Seat Legs down		Consisting of 2 elements (1 rear, 1 feet) feet highlighted. Left side chair view. Arrows, reverse highlighted (same placement as 4.2)







Seat Icons continued

Item	Icon Name	Icon Visual	Comments
S11	N/A		Seat right leg up. Seat left leg up remains in place
S12	N/A		Seat right leg down. Seat left leg remains in place..

Auxillary Functions









Item	Icon Name	Icon Visual	Comments
M2	Settings		Settings menu icon, selected with forward input. Left or right input lead to Bluetooth or information menu icon. Shown as well: Select/Next/Previous
M3	Select		Select menu item. Highlighted if activated by input device forward input.
M4	Previous		Navigates through menu and settings items. Highlighted if activated by input devices right input (all).
M5	Next		Navigates through menu and settings items. Highlighted if activated by input device right input (all).
M6	Change plus		Highlighted if activated by input device forward input.
M7	Change minus		Highlighted if activated by input device reverse input.
M8	Brightness		Large brightness change icon. Shown as well: Next/Previous/Change plus/minus
M9	Beep		Large beep volume change icon. Shown as well: Next/Previous/Change plus/minus
M10	Horn		Large horn volume change icon. Shown as well; Next/Previous/Change Plus/minus.
M11	BT Main Menu		Main Bluetooth, press up to enable.

Auxillary Functions continued



Item	Icon Name	Icon Visual	Comments
M12	BT Programming		Wireless Bluetooth programming access icon (tablet/phone).
M13	BT Connection ID		Shows Power Chair Bluetooth Identification number
M14	BT Connection		Bluetooth connected push up to abort. Device ID connected on bottom.
M16	BT Access confirm		Icon shows symbolic chair with a dotted line to the tablet/phone device.
M17	BT key confirm		Icon shows symbolic key. Shown as well: C2: "BT visible". C3: 'Select' C4: System ID (font size as used for battery) Key number
M18	Abort		Shown as well: M: 'BT programming' icon T1-T3: Paired device name C2: 'BT connected'
M19	Provider information		Information menu icon leading to provider information page, shown as well: Select/Next/Previous.

Soft Key Functions















The seat soft key icons will correspond to the respective seat screen icons.

Item	Icon Name	Icon Visual	Comments
T13	Speed up		Allows to adjust upwards (in steps) max profile; speed down on Drive X (speed arc).
T14	Speed down		Allows to adjust downwards adjust (in steps) max profile speed shown on Drive X (speed arc).
T15	Light control		Allows light on/off function.
T16	Indicator left control		Allows left turn on/off function.
T17	Indicator right control		Allows right turn on/off function.
T18	Home shortcut		Allow access to Home screen.
T19	Settings shortcut		Allows access to Setting menu.
T20	BT shortcut		Allows access to Bluetooth menu.
T21	Seating Shortcut		Allows access to Seating menu.

General exceptions

Item	Icon Name	Icon Visual	Comments
F1	Warning		Shown on warning as generic icon for most warnings. T2# and warning number. Exceptions for specific user warnings see below.
F2	Error		Shown on error as generic icon for most errors. T2: # and error number. Exceptions for specific user errors see below.

User exceptions

Item	Icon Name	Icon Visual	Comments
F4.1	Information battery yellow		Large battery icons show upon a transition into the following levels. -Green (51%) into yellow (50%) -Yellow (31%) into red (30%) -Red (16%) into red cross Required large icons: -Yellow (50% filled) -Red (30% filled) -Red cross (empty)
F4.2	Information battery red		See above
F4.3	Information battery empty		See above
F5	Error battery empty		Error will show an empty battery icon integrated into error icon.
F6	Error no charging		Error will show a disconnected power plug icon integrated into error icon.
F7	Error brakes		Error will show a brake icon integrated into error icon. Drive is inhibited.
F8	Error overtemperature		Error will show high temperature integrated into error icon. Drive is inhibited.
F9	Warning speed reduction temperature		Warning will show high temperature integrated into warning icon. Drive at reduced speed with warning icon in C1.
F11	Warning speed reduction overvoltage		Warning will show an overcharged battery icon integrated into warning icon. Drive at reduced speed with warning icon in C1.
F12	Warning joystick deflected		Warning will show deflected joystick integrated into warning icon.
F13	Warning joystick deflected		Error will show deflected joystick integrated into error icon.
F14	iLevel warning		Warning will show iLevel icon and a level ground line integrated into warning icon.
F16	Warning Traction error		Warning will show a traction control (ABS) icon integrated into warning icon for Quantum 4Front.
F17	Encoder Active		Shows encoder enabled on drive screen.
F18	Encoder Error		Shows encode error on drive screen.

Q·LOGIC 3^e

USA

401 York Avenue
Duryea, PA 18642
www.quantumrehab.com

Canada

5096 South Service Road
Beamsville, Ontario L0R 1B3
www.quantumrehab.com

Australia

20-24 Apollo Drive
Hallam, Victoria 3803
www.quantumrehab.com.au

New Zealand

38 Lansford Crescent
Avondale
Auckland, New Zealand 0600
www.pridemobility.co.nz

UK

32 Wedgwood Road
Bicester, Oxfordshire OX26 4UL
www.quantumrehab.co.uk

B.V.

(Authorised EU Representative)
De Zwaan 3
1601 MS Enkhuizen
The Netherlands
www.quantumrehab.eu

Italy

Via del Progresso, ang. Via del Lavoro
Loc. Prato della Corte
00065 Fiano Romano (RM)
www.quantumrehab-italia.it

France

26 rue Monseigneur Ancel
69800 Saint-Priest
www.quantumrehab.fr

Spain

Calle Las Minas Número 67
Polígono Industrial Urtinsa II, de Alcorón
28923-Madrid

GmbH

Hövelrieger Str. 28
33161 Hövelhof
Germany



I N F M A N U S 1 5 4