



Changing Places **Transforming Lives**

Information Kit

NOVEMBER 2015

We need **changing** **places** to go places



Index

Foreword	4
How can Changing Places assist?	
Introduction	6
The need for Changing Places toilets	7
Andy's story	8
Brendan's story	9
Liz's story	10
Susan and Ben's story	11
Lockable options	12
Changing Places design specification, costings and guidelines	
Overview	14
Design options	15
Ceiling height	16
Ceiling hoist	17
Hoist charging station	17
Accessible toilet & grabrails	17
Hand wash basin	19
Fixtures & fittings	20
Change table	20
Changing rails	21
Flooring	23
Automated door	24
Signage	26
Design plans	29
Changing Places design & development costs	32
Guidelines for the use of slings in Changing Places toilets	42
Key schemes	43
Accreditation of Changing Place facilities	44
Changing Places Supporters	
Supporters	46
Changing Places Technical Advisory Team	47



Foreword

The Association for Children with a Disability (ACD) is a not-for-profit community based organisation that was established in 1980. ACD works to improve the lives of children with a disability and their families by influencing public policy and advancing worthy initiatives.

For too long we have seen families confronted by social isolation due to not having adequate toilet facilities that meet the needs of their children.

Some families in desperation to live a life outside of four walls, find themselves with no choice but to change their child on the cold floor of a public toilet. This option is unhygienic, undignified and presents health risks for both recipient and carer. Sitting in soiled clothing is the alternative but is undignified, unhealthy and often leads to urinary infection.

Can you imagine having to face such choices on a daily basis?

For these reasons, we seek to introduce Changing Places toilets to Australia.

Changing Places Toilets are a real improvement on standard accessible toilets. Each Changing Places toilet provides: a height adjustable adult-sized changing bench, a tracking hoist system, enough space and a safe and clean environment.

The Changing Places website also provides advocates, disability service providers, people with a disability and their families with the tools to advocate for the installation of a Changing Places toilet in their local community.

The Changing Places concept was introduced successfully in the UK in 2006 with over 700 Changing Places toilets spread across the country. This has transformed the lives of hundreds of thousands of people, enabling them to be far more engaged in their own local communities.

Changing Places was introduced to Australia in 2012 with the establishment of a consortium called "Changing Places Victoria". The Consortium, lead by Maroondah City Council, developed an early relationship with Changing Places UK and set about developing designs for Changing Places toilets in Australia. It has since evolved into a nationwide initiative aimed at breaking down one of the fundamental barriers to inclusion for people with severe and profound disabilities.

In developing the Kit, the Consortium received great assistance from many professionals.

I would particularly like to thank the following individuals for their invaluable assistance: Bruce Bromley and Lee Wilson (Equal Access), Helen Fearn-Wannan and Francesca Davenport (Architecture and Access) and Jack Mulholland (Maroondah City Council).. ACD is indebted to the Victorian State Government, Maroondah City Council and Jack for their respective support and leadership with the Changing Places project. ACD especially acknowledges the Victorian Government and the Department of Health and Human Services (DHHS) whose ongoing support to the Changing Places initiative and to the creation of several Changing Places facilities in key locations across Victoria has helped to create valuable momentum for the campaign, and has been an excellent demonstration of leading by example when it comes to inclusion of people with disabilities.

Finally, ACD would like to acknowledge the dozens of individuals and organisations across Australia who are working hard to advocate for Changing Place facilities in their community.

For further information on how to support Changing Places, please contact ACD or visit www.changingplaces.org.au

I trust you will find the Changing Places Information Kit to be a valuable and useful resource.

Eddie Chapman

Chief Executive Officer Association for Children with a Disability

How can **Changing Places** assist?



Introduction



Standard accessible toilets do not meet the needs of all people with a disability or their carers. People with profound and multiple learning disabilities, as well as spinal injuries, spina bifida, motor neurone disease, multiple sclerosis or an acquired brain injury, often need extra facilities to allow them to use the toilets comfortably.

Changing Places toilets are different to standard accessible toilets in that they have extra features and more space to meet these needs. Each Changing Places toilet provides:

- a height adjustable adult-sized changing bench
- a tracking hoist system
- enough space
- safe and clean environment

Without Changing Places toilets carers are forced to choose between changing their loved-ones on the floors of public toilets or being confined to the four walls of their home.

The introduction of the National Disability Insurance Scheme (NDIS) provides support to individuals and families but does not include community infrastructure.

Despite all the support of the NDIS, many people's lives will remain restricted. Changing Places underpins the goals of the NDIS by removing a considerable barrier to social inclusion and community participation by providing toilet facilities that meet the needs of people with a severe or profound disability.

The NDIS will change the lives of people with a disability for the better in many ways BUT without Changing Places toilets people with a disability and their carers will not be able to realise these opportunities.

The Changing Places initiative advocates for the installation of Changing Places toilets in key community spaces across metropolitan and regional Australia.

This includes:

- shopping centres
- premium train stations
- aquatic facilities
- major sporting and recreational complexes
- major cultural facilities and tourist attractions
- parks
- civic centres
- airports
- hospitals

Changing Places toilets are to be provided in addition to and separate from regular accessible toilets to accommodate the needs of both groups of toilet users.



The need for Changing Places toilets

“We recently had a Changing Places toilet installed at our local shopping centre and I must say Changing Places has changed our lives, to experience my daughter’s joy in going to the cinema released all the years of pent up emotion as tears streamed down my face. My daughter’s expression has changed forever, the grey skies have been lifted!!!”

Proven model

Changing Places was launched in the UK in 2006 where there were nine facilities that contained the features of a Changing Places toilet. There are now over 700 Changing Places facilities across the UK. They have been placed in key public spaces such as shopping centres, large railway stations, leisure complexes such as aquatic facilities, and recreational and sporting complexes such as the zoo, football stadiums and more recently the London Olympics where a Changing Places facility was made available at all venues.

National Disability Strategy 2010 – 2020 (NDS)

The National Disability Strategy 2010-2020 states that “people with disability may experience restricted access to social and cultural events and to civic, political and economic opportunities because of inaccessible attributes of the built and natural environment”.

Changing Places toilets underpin the following NDS policy directions:

- Increased participation of people with disability, their families and carers in the social, cultural, recreational and sporting life of the community
- Improved accessibility of the built and natural environment through planning and regulatory systems, maximising the participation and inclusion of every member of the community
- A public, private and community transport system that is accessible for the whole community

Carers

The Wellbeing of Australians - Carers Health and Wellbeing (Deakin University, 2007) the following was identified:

- Carers are more likely than is normal to be experiencing chronic pain
- Carers are highly likely to be carrying an injury presumably caused by their caring activities
- Carers have an average rating on the depression scale that is classified as moderate depression

Changing Places toilets will enhance the carer’s physical wellbeing through removing the need to lift the person with a disability.

The carer’s wellbeing will also be enhanced through increased social opportunities and the removal of the everyday stress of planning around the bathroom needs of the person they are caring for.

Andy's story

Hi my name is Andy and I have worked within the disability field for over 20 years, the last five with people with a disability that use wheelchairs.

This includes supporting people to be involved in special events, that we all enjoy, from the Australian Tennis Open, test match cricket, Zoo, Puffing Billy, AC-DC in concert to Buddy Holly story on stage.

Our day would start at 9am at a centre with a meet and greet and a cuppa.

We then take care of any personal needs of the people we support at the centre, using a change table and hoist, and by 10am we would be on a bus or using public transport, packed with lunch for the day and all the necessary items to have a great day out; including medication, sunscreen and emergency information folder. And as we left, we would all quietly hope that we didn't have any toilet requirements.

While on an outing, we would assist the people we support with lunch. However some of the people we support will refuse drinks while on outings, because they are scared that they would need to go to the toilet. Going to the toilet means sitting in extreme discomfort and indignity with soiled pads or turning around and going back home. By about 2pm there is no alternative but to arrange to return to the centre to attend to personal care needs as we have to balance the enjoyment of such outings with the risk of urinary infections.

Considering the travel time and time spent at such outings as the tennis, cricket, zoo and concert how long could you hold off from going to the toilet? Imagine the anxiety of knowing at some stage your enjoyment and comfort will change dramatically as nature calls.

So desperate to make the most of their limited opportunity some look to refuse a drink even on a 37 degree day. This presented us with another health issue as we look to ensure their safety and welfare.

Going back to the centre can be really tough as you can feel the change as yet another potential memorable day has been cut short. The smiles of joy seen not that long ago have all but disappeared.

If we had Changing Places, the health and well being of the people I support would be better because they wouldn't be sitting in soiled pads waiting for us to get back to the centre to change, or having to hold for long periods of time. Outings such as the Australian Tennis Open, concerts, the football we could stay for the entire day ensuring we maximise the opportunity for the people we support and they could finally get to enjoy the tense moments of the conclusion of a match or an encore of a concert, imagine that!. Outings would no longer be cut short.

It sometimes means that the choice for the people we support becomes: do I go out and enjoy myself until the moment of needing to go or do I stay at home or in the centre and miss out on one of the highlights of my year? And is it worth the money if I miss the ending anyway?

Brendan's story

Hi my name is Brendan and I am 26. I enjoy a busy life doing lots of things like part-time courses, choir, going to the footy to see the Tigers play, singing, church, live concerts, local festivals and hanging out with my friends. Singing is my passion and I enjoy it. I get about in my van and use public transport alot.

It's fantastic when I can go out with my friends but doing that is complicated because we all have different needs. Without Changing Places my day becomes restricted to being close to home so I can have my personal care needs met. This really limits where I can go.

I am also a passionate self-advocate and I want you to know how important Changing Places are to me, not only for myself and my friends but also for tens of thousands of other children and adults with disabilities. Some people are "changed" on the floor of a disabled toilet, I don't want this so I have to go home to have my personal care needs met. What a waste of my time when I could have the same convenience and spontaneity as you if there were Changing Places. We need Changing Places with an adjustable height change table and hoist. You and I deserve the same right to dignity, hygiene and safety. This would happen if there were Changing Places available.

Living at home with mum, dad, my brothers and sister is great but I really like to get out and enjoy life. I do pretty much the same as my brothers and sister, but I have better taste in music. One of the major differences is I know they don't plan their days out around the only toilet they can use in the city.

Having Changing Places all over Australia would be great. They would give me the freedom to live a life with more choices about what I can do, where I can go and when I can do it – we really do need Changing Places to go places.



Liz's story

Liz is 28 has a Bachelor of Social Work but finds employment opportunities are almost non-existent as we have a community without toilets that meet her needs.

For the last two years Melbourne has been crowned as the most livable city in the world - that is if you don't have a disability". "We have Australian Building Standards for accessible toilets which unfortunately are discriminating in that they do not meet the needs of all people with a disability.

As everything is built to standards, like so many other people with a disability, I'm left to try and engage in the community without the availability of toilets.

This is extremely limiting where leaving early has become all too familiar. Missing a concert I paid for, leaving meetings half way through, missing the end of the movie, leaving the shops without acquiring what you came for is very emotionally draining.

There are no alternatives as there is a no lifting policy for support staff so if you cannot stand up, like me, public accessible toilets are not an option, sitting in soiled pads it is not only humiliating but has impacted on my health resulting in infections and bleeding.

I really only have one alternative and that means not to go out at all and stay at home.

The idea of being stuck inside four walls is soul destroying for me as I am an extrovert by nature with a love of people. I feel like a bird with my wings clipped.

Having Changing Places toilets would change everything and provide me with opportunities for employment, shopping, movies, concerts, visiting family and friends rather than online but best of all it would provide me a life, a life outside of four walls, a lot of quality.

I have a dream!!!!

Susan and Ben's story

I've been asked what it's like having a child with a severe physical disability so many times, but never does anyone wonder how we actually access our community and city, particularly in regards to bathroom facilities. When I think about it, the way we participate in our community has been dominated by this issue.

When my son Ben was young, up to age 5 and 6, we could still use nappy change facilities but there came a time where he just got too big. A couple of times we have tried to use the back of the car but then he got too long for that too.

I guess the last option was to lay him on the public bathroom floor and change him - horrendous!! For one it's just a filthy thing to have to do, even if we have a mat it's unhygienic and demoralising, it is definitely a two person job and we are both kneeling over him and there is no privacy for him at all. Secondly he is so heavy to lift from the ground, and again this would have to be a two person job. I can only imagine how awful it must be for an adult to maintain their dignity and independence. So we just put extra padding on him and only do short trips and cross our fingers.

As a family we now have such low expectations that we don't ever bother planning a day trip which is sad for all our children. We haven't taken them to the Dandenong's, the Yarra Valley, a day trip to the beach, a day trip to Werribee zoo or a fun park - the list is endless.

Once we did a day trip to the picnic races and had to try to make a screen with chairs while we changed him on the grass. It was humiliating for all of us.

Accessible toilets would be life changing for a family like ours. We would be able to enjoy many different experiences together.



Changing Places online

The Changing Places website contains information and tools to help build or advocate for the construction of a Changing Place.

The website also features a regularly updated map of Changing Places and other fully accessible toilets across Australia. All accredited Changing Place facilities are automatically added to the map.

Visit www.changingplaces.org.au to find:

- Photographs of Changing Places
- Case studies for builders
- Testimonials from Changing Place users
- Sample letters, presentations and videos for advocates
- Campaigns for Changing Place facilities
- Location map of Changing Places and other fully accessible toilets
- Useful downloads e.g. the Changing Places kit and layout schematics
- A list of Changing Place supporters

From the website you can start your own campaign for a Changing Places toilet in your community or take part in an existing campaign. Visit www.changingplaces.org.au to find out how you can support Changing Places.

Stay up to date on the latest Changing Places news by joining our online mailing list or following us on Facebook and Twitter:



www.facebook.com/ChangingPlacesAustralia



[@ChangingPlaceAU](https://twitter.com/ChangingPlaceAU)

Changing Places

design specification



Changing Places design specification



Overview

The need

Changing Places toilets have been introduced to provide suitable toilets for people who cannot use standard accessible toilets. A Changing Places toilet allows people with a severe or profound disability and their carers / family to enjoy the day to day activities many of us take for granted and is considered best practice under the Disability Discrimination Act 1992.

This may include people with an acquired brain injury, cerebral palsy, multiple sclerosis, spina bifida, motor neurone disease and their carers, as well as many other people with a disability.

Each toilet needs a toilet pan, an adult size adjustable changing table, a ceiling hoist, sufficient circulation space and a safe, clean environment. The current version of Australian Standard AS1428.1 does not require such adult changing equipment in standard accessible sanitary toilets.

Changing Places toilets and accessible toilets

It is important to note that Changing Places toilets are “not required” toilets under the “deemed-to-satisfy” provisions of the Building Code of Australia (BCA) or Disability (Access to Premises - Buildings) Standards 2010 (Premises Standards).

As such, the provision of any Changing Places toilet is considered to be above and beyond the current legislated requirement within each State or Territory and provided in addition to the “required” accessible toilets. Changing Places toilets are designed to meet the needs of people who require assistance to use the toilet and combining Changing Places toilets with regular accessible facilities may compromise the needs of both user groups.

The Changing Places layouts specified in this kit have been developed with best practice standards in mind. In order to be classified as a Changing Places toilet, facilities must either be based on the exact designs provided or meet the key requirements in terms of circulation space and features. This is to ensure that any toilet advertised as a Changing Places toilet consistently meets the needs and expectations of the people who use them as well as their carers.

Please refer to the accreditation guidelines on page (44)

Corporate social responsibility

The provision of a Changing Places toilet is a great step towards creating an inclusive built environment for all people with disability. Organisations and building owners who provide a Changing Places toilet, can proudly promote their awareness of community needs and commitment to their social responsibility on company websites and promotional materials.

“I am racked with guilt every time I lie my son Toby down on a dirty toilet floor because I know I am risking his health. But I have no other option. We can't stay at home all the time.”

Design options

The Changing Places Consortium in Australia has developed three typical design options for use as follows.

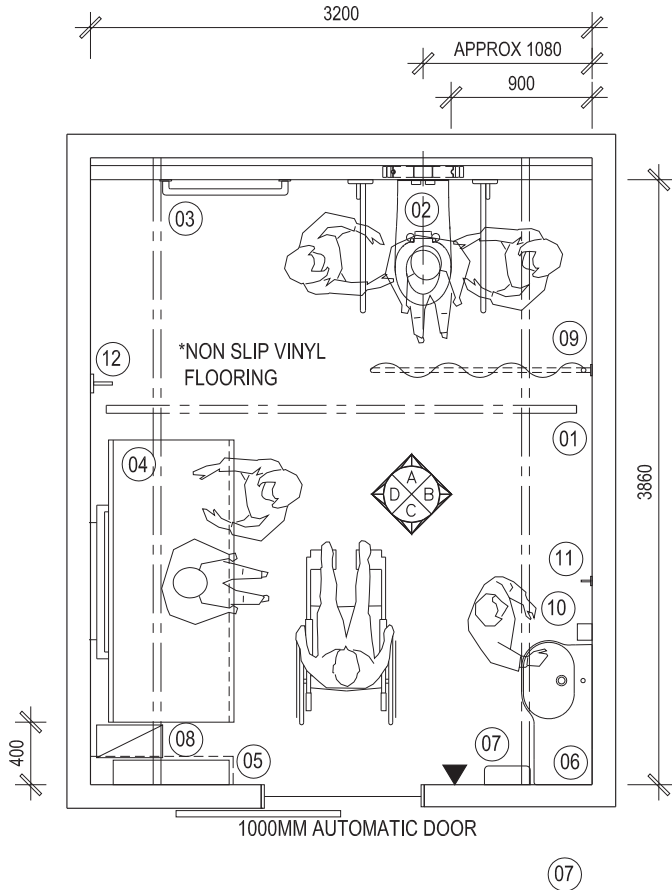

Type 1A

- 01** Room coverage hoist
- 02** Accessible wc incl. backrest and lift up grab rails
- 03** Two 800mm long horizontal grab rails mounted at 800mm and 1000mm above floor level for adjusting clothes.
- 04** 1000mm above floor level for adjusting clothes (while person holds onto grabrail)
- 05** Adjustable height change table, 1800mm long with side safety rail
- 06** Disposable change table cover dispenser with shelf over
- 07** Integrated wash hand basin
- 08** Hand dryer
- 09** Rubbish bin
- 10** Retractable privacy curtain, wall mounted
- 11** Soap dispenser
- 12** Clothes hook
- ▼** Large sling hook
- ▼** Automatic door control

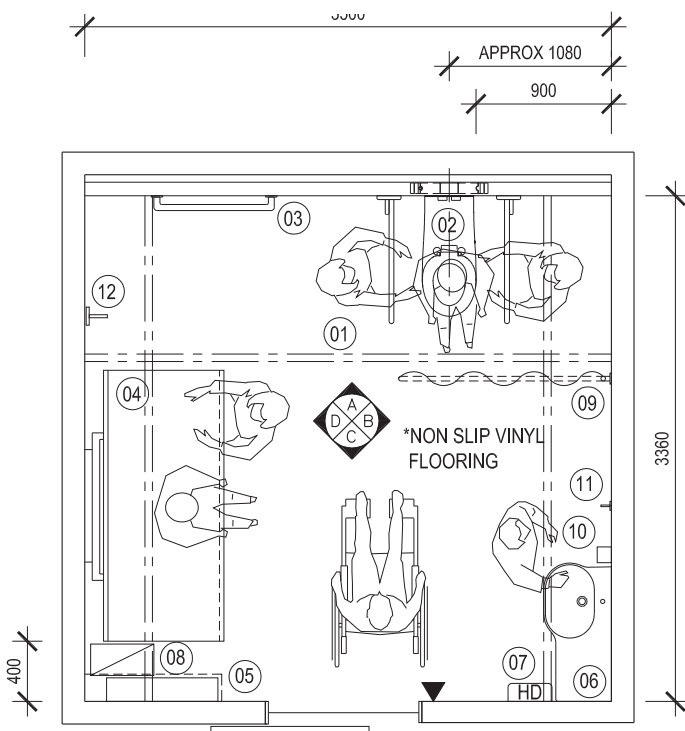

Type 1B

- 01** Room coverage hoist
- 02** Accessible wc incl. backrest and lift up grab rails
- 03** Two 800mm long horizontal grab rails mounted at 800mm and 1000mm above floor level for adjusting clothes.
- 04** 1000mm above floor level for adjusting clothes (while person holds onto grabrail)
- 05** Adjustable height change table, 1800mm long with side safety rail
- 06** Disposable change table cover dispenser with shelf over
- 07** Integrated wash hand basin
- 08** Hand dryer
- 09** Rubbish bin
- 10** Retractable privacy curtain, wall mounted
- 11** Soap dispenser
- 12** Clothes hook
- ▼** Large sling hook
- ▼** Automatic door control

Changing Places design specification, costings and guidelines

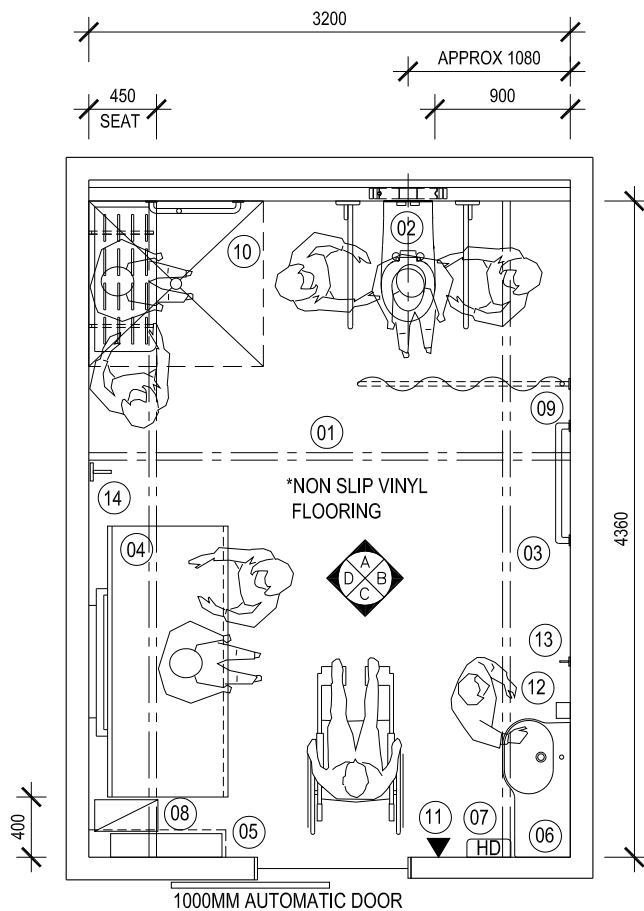

Type 2

01	Room coverage hoist
02	Accessible wc incl. backrest and lift up grab rails Two 800mm long horizontal grab rails at 800mm and
03	1000mm above floor level for adjusting clothes (while person holds onto grabrail)
04	Adjustable height change table, 1800mm long with side safety rail
05	Disposable change table cover dispenser with shelf over
06	Integrated wash hand basin
07	Hand dryer
08	Rubbish bin
09	Retractable privacy curtain, wall mounted
10	Accessible shower
11	Automatic door control
12	Soap dispenser
13	Clothes hook
14	Large sling hook
▼	Automatic door control

Ceiling height

The minimum ceiling height of the facility is to be determined by the design of the ceiling hoist specified for the facility.

The facility must achieve the following as a minimum requirement, with regard to the ceiling hoist installation and track system:

1. A minimum height of 2100mm clear unobstructed vertical height from the finished floor level to the underside of any ceiling hoist track, ceiling hoist component or other fixture and fittings. A height of 2400mm clear unobstructed height is preferred.

Ceiling hoist

Provide a room coverage hoist system, also called XY system or gantry, including 2 parallel fixed rails and a perpendicular moving traverse rail. This provides coverage over the entire room for greatest flexibility when using the facility. Ensure full coverage of the bathroom, including toilet and change table, is provided.

Performance details

Track system equivalent to:

1. Rail system with a safe working load (SWL) equal to or greater than 180kg.
2. Two fixed parallel rails.
3. One moving traverse rail. (May require piggyback support rail.)
4. Includes wall or ceiling mounted charger. Standard GPO required to be provided by builder at ceiling level.

Hoist system equivalent to:

1. Fixed hoist
2. Lifting height up to a min 210cm
3. Safe working load equal to or greater than 180kg
4. Hoist Case Flame Retardant ABS

Hoist charging station

Locate the hoist charging station in a position which will not interfere with users of the room when the hoist is not being used; typically this will be over the change table. Do not locate the charging station over the WC pan.

Accessible toilet & grabrails

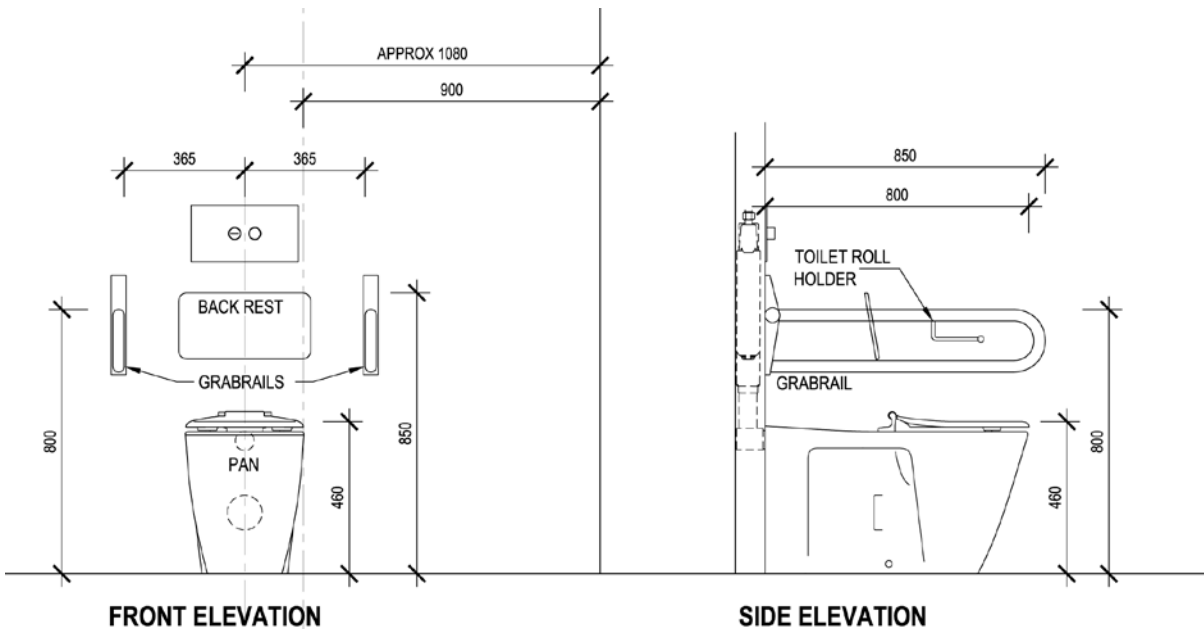

Pan

A toilet pan shall be provided. The toilet pan shall be installed so that:

1. The front edge of the pan is 800mm \pm 10mm from the rear wall; and
2. A 900mm wide circulation space is provided between the pan and the side wall.

Seat

A toilet seat shall be provided in compliance with the current version of AS1428.1, including the requirement to:

1. Be of the full-round type, (i.e., not open fronted) and with minimal contours to the top surface;
2. Be securely fixed in position when in use;
3. Have seat fixings that create lateral stability for the seat when in use;
4. Be load-rated to 150 kg; and
5. Have a minimum luminance contrast of 30% with the background (e.g., pan, wall or floor against which it is viewed).

Flushing controls

Flushing controls shall be in compliance with the current version of AS1428.1, including:

1. Being user activated, either hand operated or automatic.
2. Where hand-operated flushing controls are used, they shall be centred on the centre-line of the toilet (max height 1100mm), wholly within the vertical limits of that zone. The position of the flushing control within this zone shall not be within the area required for any grabrails or backrest.
3. The flushing control shall be proud of the surface and shall activate the flush before the button becomes level with the surrounding surface.

Backrest

A backrest shall be provided in compliance with the current version of AS1428.1. The backrest shall:

1. Be capable of withstanding a force in any direction of 1100 N;
2. Have a height, at the lower edge of backrest to the top of the WC seat, of 120mm to 150mm;
3. Have a vertical height of 150–200mm and a width of 350–400mm; and
4. The front edge of the centre of the backrest be positioned to achieve an angle of between 95° to 100° back from the seat hinge.

Grabrails

Fold down grabrails shall be provided and shall be:

1. Located at a height of 800mm to the top of the rail;
2. Located 360-370mm from the centreline of the WC pan;
3. 850mm minimum long;
4. 32mm diameter;
5. Securely fixed to withstand a force in any direction of 1100 N;
6. At least one grabrail is to contain a toilet paper holder; and
7. Capable of being lifted up or swung away to allow unimpeded access to the WC pan.

Hand wash basin

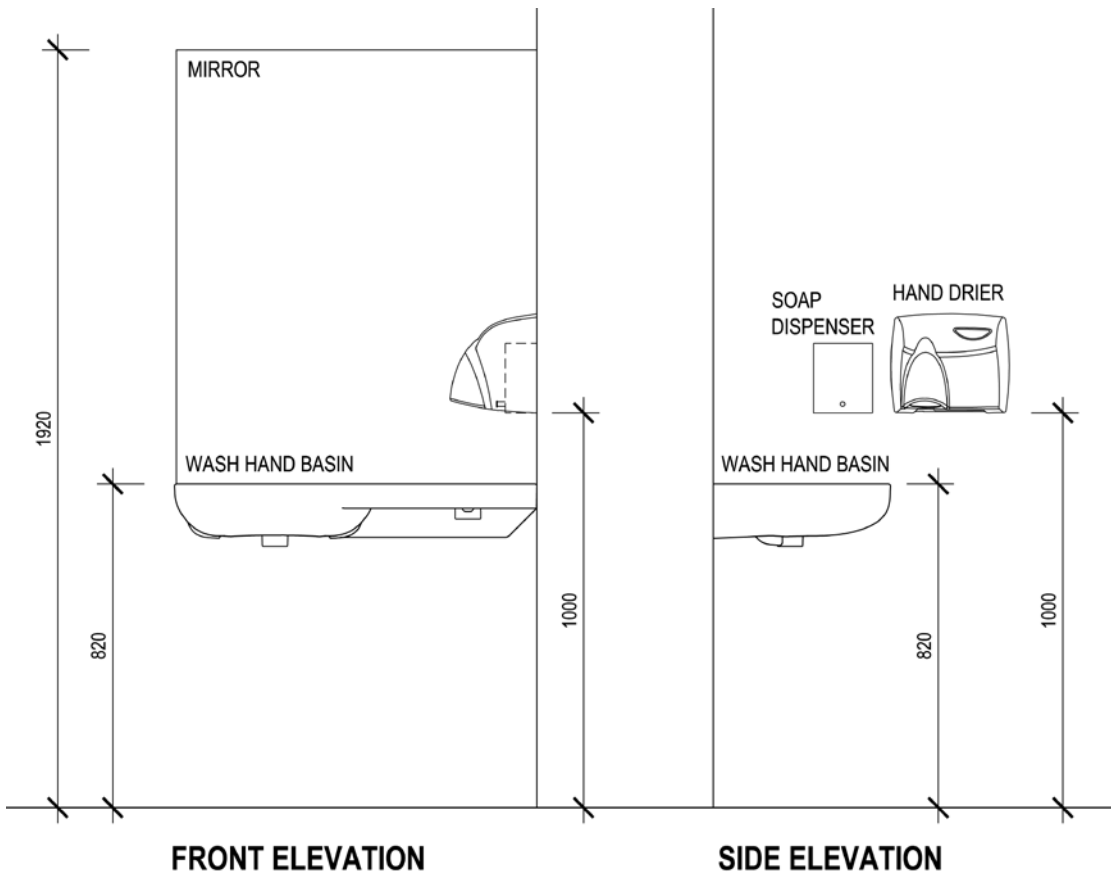

Hand wash basin

The installation of wash basins shall be in compliance with the current version of AS1428.1, including:

1. The wash basin shall be installed within the height range to 800 – 830mm;
2. Exposed hot water supply pipes shall be insulated or located so as not to present a hazard;
3. Water supply pipes and waste outlet pipes shall not encroach on the required clear space under the washbasin; and
4. Hand wash basin is to have an integrated lay off area of a minimum 300mm wide.

Tap

Water taps shall be in compliance with the current version of AS1428.1, including:

1. Taps shall have lever handles, sensor plates, or other similar controls;
2. Lever handles shall have not less than 50mm clearance from an adjacent surface;
3. Where separate taps are provided for hot and cold water, the hot water tap shall be placed to the left of the cold water tap for horizontal configurations, or above the cold water tap for vertical configurations; and
4. Where hot water is provided, the water shall be delivered through a mixing spout.

Fixtures and fittings

Mirror/s

The mirror shall be in compliance with the current version of AS1428.1, including:

1. Provide a vertical mirror with a reflective surface not less than 350mm wide and shall extend from a height of not more than 900mm to a height of not less than 1850mm above the plane of the finished floor; and
2. Where provided, a second vertical mirror shall extend from a height of not less than 600mm to a height of not less than 1850mm above the plane of the finished floor.

Soap dispensers, towel dispensers and similar fittings

Soap dispensers, towel dispensers, hand dryers and similar fittings shall be provided in compliance with the current version of AS1428.1. Each fitting shall be operable by one hand, and be:

1. Installed with the height of their operative component or output not less than 900mm and not more than 1100mm above the plane of the finished floor; and
2. No closer than 500mm from an internal corner.

Clothes hook

One clothes hook shall be installed in compliance with the current version of AS1428.1 between 1200mm to 1350mm above the plane of the finished floor located near the hand washbasin.

Sling hook

One large clothes hook shall be installed beside the change table for slings at 1500mm above the finished floor level.

Sanitary disposal unit

The sanitary disposal unit shall be located as follows:

1. Portable unit in the corner beside the pan.

Change table

The general requirements for the change table are as follows:

1. 700mm of height adjustability (Minimum 300mm - Maximum 1000mm);
2. 700mm table width;
3. A safety rail that can be folded up or down easily;
4. Remote controlled, low voltage for safe operation in a wet area;
5. Weight loading capacity to be min 180 kg;
6. If a freestanding style change table is used it must have two safety sides; and
7. Manually adjustable back support (desirable only, not mandatory)

Disposable change table cover dispenser with shelf over

Provide a paper towel cover and dispenser or antiseptic wipes for cleaning of the table.

Provide a shelf for storage of supplies by users of the room. Shelf to be 400x150mm wide minimum.

Changing rails

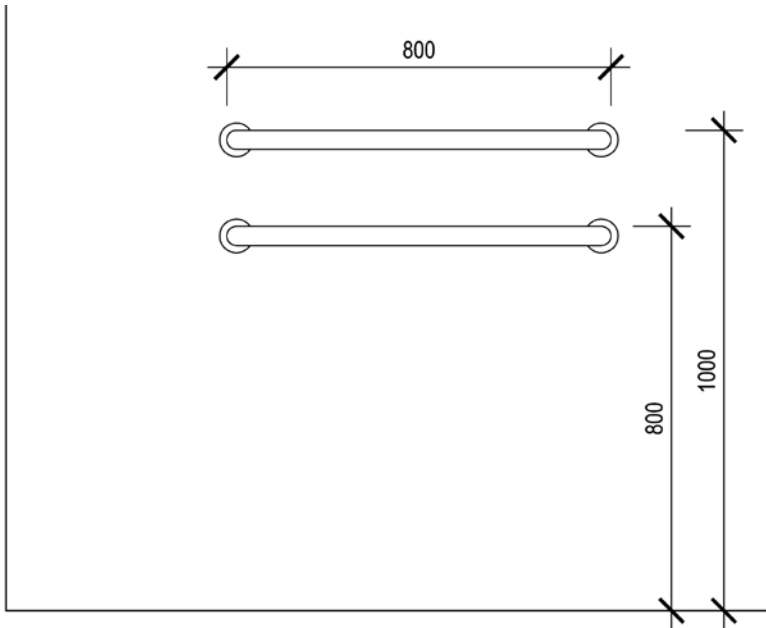

Changing rails

Provide two 32mm diameter, 800mm long grab rails installed horizontally at 800mm and 1000mm above the plane of the floor level that allow users to hold onto whilst standing to have clothes adjusted.

Shower

Where included, shower installations should comply with the current version of AS1428.1:2009 with the exception of the shower seat that is increased to 450mm in width.

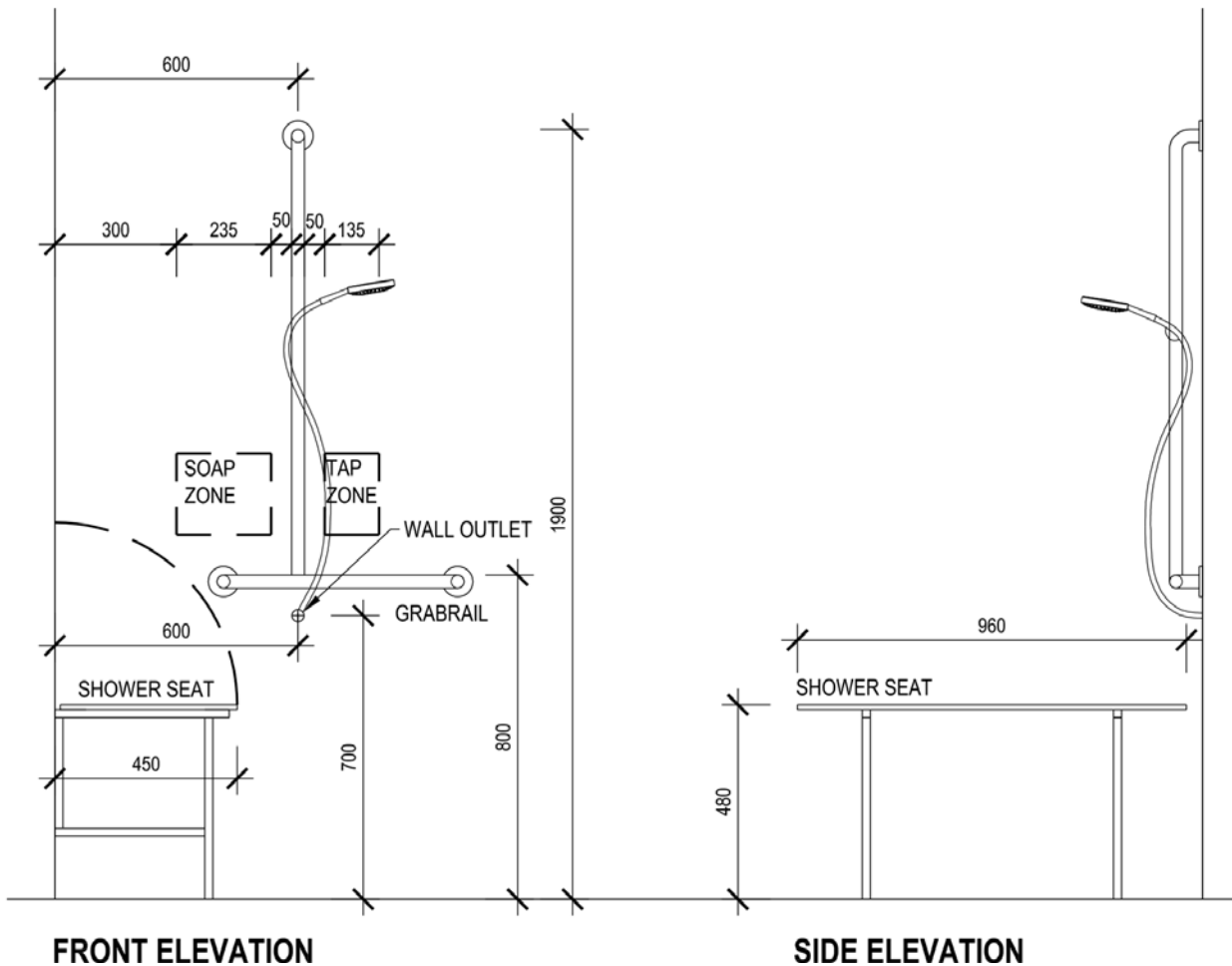

Floor and waste outlet

The requirements for the floor and waste outlet are as follows:

1. The floor of the shower recess and associated circulation space shall be self draining and without a step-down, raised step kerb or hob at the entry to the recess;
2. The waste outlet for the shower shall be provided in accordance with the floor plans;
3. The slope of the floor of the shower recess shall have a gradient in compliance with the current version of AS1428.1; and
4. The slope of floor of the remainder of the sanitary facility shall have a gradient between 1 in 80 and 1 in 100.

Grabrails

Provide 32mm diameter grabrail/s in accordance with the current AS1428.1 which shall be fixed on the walls in the positions shown as detailed.

Shower head support grabrail

A shower head support grabrail shall be fixed on the wall in the position as detailed.

Shower head

A hand-held shower head shall be provided in compliance with the current version of AS1428.1, including:

1. A flexible hose with a minimum length of 1500mm;
2. An adjustable shower head holder shall be provided to support the shower head and shall:
 - a. Be installed on the shower head holder support grabrail as shown;
 - b. Allow the graspable portion of the shower head to be positioned at various angles and heights;
 - c. Allow the graspable portion of the shower head to be located at heights between 1000mm and 1800mm above the plane of the finished floor; and
 - d. Allow access and adjustment from a seated position.

Water outlet

The water outlet shall be located as detailed and be provided with a back-flow prevention device.

Soap holder

The soap holder shall be located within the zone as detailed.

Taps

Taps shall be located within the zone as detailed.

Folding seat

A foldable seat shall be provided inside the shower recess in compliance with the current version of AS1428.1, as detailed and shall—

1. Be self-draining;
2. Be slip-resistant;
3. Have front corners that are rounded to a radius of 10 to 15mm;
4. Have top edges that are rounded with a minimum radius of 2 to 3mm; and
5. Shall fold in an upwards direction and when folded the grabrail shall be accessible; and
6. Shall not be slatted.

Where drainage is provided by holes or slots in single unit seats, the diameter of the holes, the width of the slots and the gaps between slats shall be between 4 to 6mm.

The fastenings, materials and construction of the seat shall be able to withstand a force of 1100 N applied at any position and in any direction without failing or loosening of fastenings.

Clothes hooks for shower

Provide not less than two clothes-hanging devices in compliance with the current version of AS1428.1, installed 1200mm to 1350mm above the plane of the finished floor and shall be fitted outside the shower recess.

One such device shall be located within 400mm and the other within 600mm of the folding seat.

Flooring

The flooring shall be either non-slip vinyl or non-slip ceramic tiles that provides a minimum R11 non-slip rating.

“I have to lay him down on dirty public toilet floors with his head under the pan where someone else has just peed. I don't like putting my handbag down on some floors; why on earth should I be expected to lie my precious son on them.”

Automated Door

Door Threshold

The threshold at the entry door shall incorporate a smooth transition without a step or lip.

Contrast of doorway

The doorway shall have a minimum 50mm luminance contrast band around the doorway. The band must achieve a minimum luminance contrast of 30% between the following components:

- door leaf and door jamb; or
- door leaf and adjacent wall; or
- architrave and wall; or
- door leaf and architrave; or
- door jamb and adjacent wall.

Door control locations

The automatic door controls shall comply with the current version of AS1428.1 and be installed in accordance with the following:

1. Installed between 900–1200mm above the level of the finished floor level.
2. Located at least 500mm from any internal corner.
3. The button shall have a minimum dimension of 25mm diameter and be proud of the surrounding surface.

Door control safety features

The automatic door shall be provided the following safety features:

1. The automated door must be calibrated to have sufficient 'dwell' time to allow people to safely travel through the doorway with a gentle opening and closing operation to reduce the risk of impact to users of the facility.
2. The automated door must be fitted with a fail-safe opening mechanism that opens the door if an object is detected during its closing operation.

Door control Braille and tactile text

The automatic door control signage shall comply with current versions of AS1428.1 & BCA and must achieve the following:

1. Door control signs shall include both Braille and raised tactile text characters.
2. Braille and tactile text are to be provided on the signage complying with Specification D3.6 of the BCA.
3. The Braille & tactile text component of the signage must be installed between 1200mm and 1600mm above the level of the finished floor level in accordance with BCA, Specification D3.6.

Door control operational requirements

The automatic door control plate signage shall achieve compliance with the following operational requirements (as a minimum):

1. The “Push to Open” and “Push to Lock” buttons shall have a minimum dimension of 25mm diameter and be proud of the surrounding surface.
2. All buttons shall be of a contrasting colour to the plate background.
3. The external “Push to Open” button may be replaced with a Master Locksmiths Access Key (MLAK) in public areas without a high level of supervision and where there is a risk of damage or vandalism to equipment. The MLAK is a locking system that enables people with disabilities to gain access to a network of public facilities as and when required. See <http://www.masterlocksmiths.com.au/mlak.php>
Further information about MLAK systems is available on page 43.
4. The external door control plate must indicate the method of opening the door (i.e. by way of a “Push to Open” button as shown in the image below, or by the use of an MLAK*).
5. “Occupied” and “Vacant” indicator lights are required on the external plate.
6. “Locked” and “Unlocked” indicator lights are required on the internal plate.
7. When the “Push to Lock” internal plate button is pressed it must secure the door followed by an audible beep.

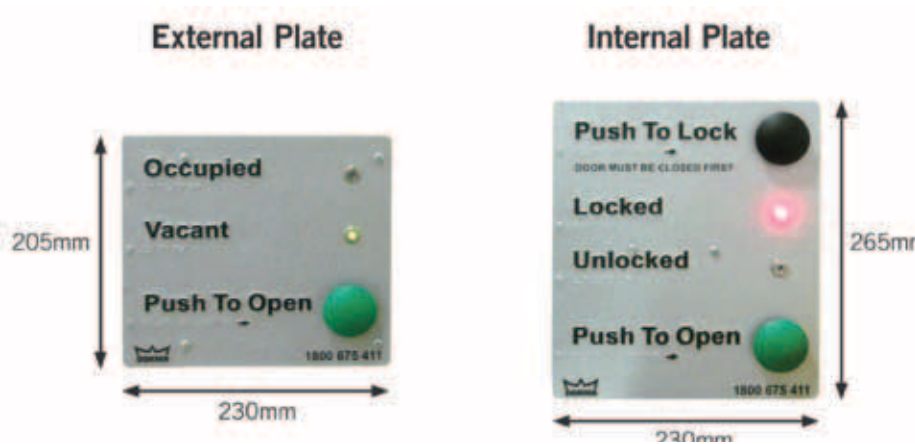

An example of suitable standard door controls and signage is pictured left.
Sign design by Braille Tactile Signs

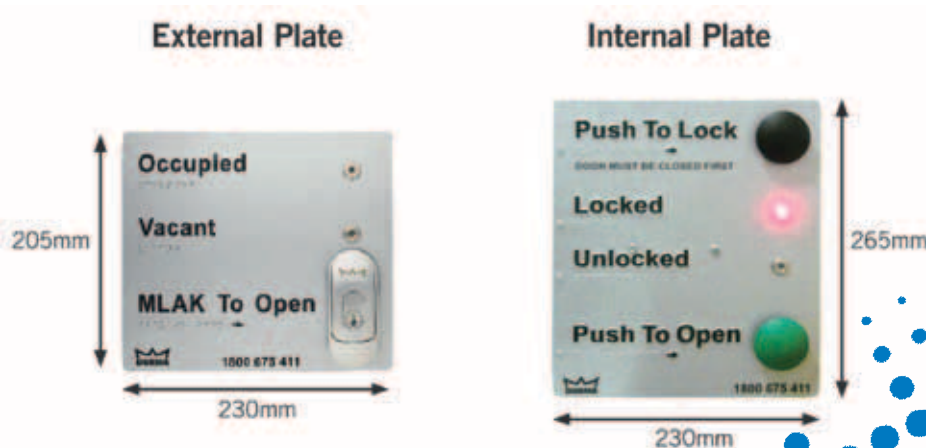

An example of suitable MLAK door controls and signage is pictured left.
Sign design by Braille Tactile Signs

Internal signage

Change table operating instructions

Provide a sign detailing operating instructions for the change table.

Refer typical signage layout.

Change table operating instructions

The Safe Working Load for the bench is 180 kgs, this table is not to be used by persons above this weight.

The following instructions **MUST** be complied with each time the change table is used.

An MLAK key is required and is available from nominated location.

1. Gently unfold the table from the upright position
2. Unlock keyed box and remove control for table.
3. Do not raise or lower the table whilst in the folded up position
4. Nothing should stand in the way of the table when in motion.
5. Press the \wedge button to raise the table and the \vee button to lower the table.
6. Cover the table with disposable paper towel.
7. Raise the side safety rail when the person has been placed on the table. To unlock the side safety rail, pull out pin on right side and unfold.
7. After use, wipe down table with antiseptic spray and wipes /dispose of paper table cover.
8. Fold the side safety rail back to the flat position after use. Use pin to secure in place.
9. Fold the table up into the upright position.
10. Lock control back in keyed box.

Remember

- This table is not to be played with at any time. The table is to be used for the purpose for which it is designed.
- Children are not to operate the bench at any time.
- If the table is out of order, it must not be used.
- Reporting Maintenance - Signage should advise users of where to report maintenance issues to, including contact phone numbers.

Internal signage

Ceiling hoist operating instructions

To provide a sign detailing operating instructions for the ceiling hoist.

Refer typical signage layout.

Ceiling hoist operating instructions

The maximum Safe Working Load of this hoist is 180kg reduce weight recommended by manufacturer as motor will burn-out quickly!. This hoist is not to be used by persons above this weight.

If the red light is on, do not use this hoist. If there is any doubt about the safety of using this hoist, it **MUST NOT** be used. *(Picture of hoist with emergency light on, example outline below)*

1. Use the control to raise or lower the spreader bar to the required height.
2. Attach the hooks of the sling in the lifting hanger's hooks. Check the sling is securely attached before lifting the person. *(Fig. 1a & 1b)*

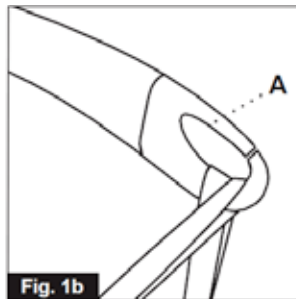
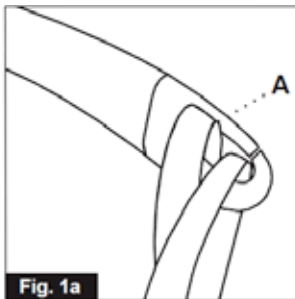

3. Check nothing will stop the hoist from lifting the person.

4. Use the control buttons to raise the person.

1 – Lift

2 – Lower

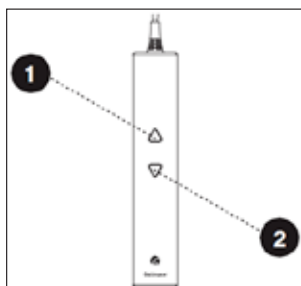

5. After use, return hoist to charging station.

(Picture needed)

6. Emergency lowering strap can be used to lower a person in an emergency. Pull the red strap (once/continuously).

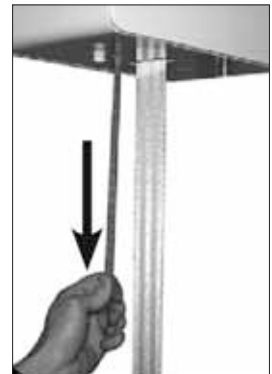

Once activated the hoist will not operate until the yellow button is manually pressed in.



7. Warning lights

Green light – hoist is ready to use

Yellow light is on – hoist battery is low or flat. Hoist must be charged before using.

Red light – do not use

(or whatever is relevant for the chosen hoist)



COPYRIGHT - ALL RIGHTS RESERVED
 This document is the property of EQUAL ACCESS CONSULTANTS and is to be used only for the project for which it was prepared. It is not to be reproduced, stored in a retrieval system, or transmitted in any form or by any means, electronic, mechanical, photocopying, recording, or by any information storage and retrieval system, without the prior written permission of EQUAL ACCESS CONSULTANTS. The design and construction details shown in this document are for information only and are not to be used for construction without the prior written permission of EQUAL ACCESS CONSULTANTS.

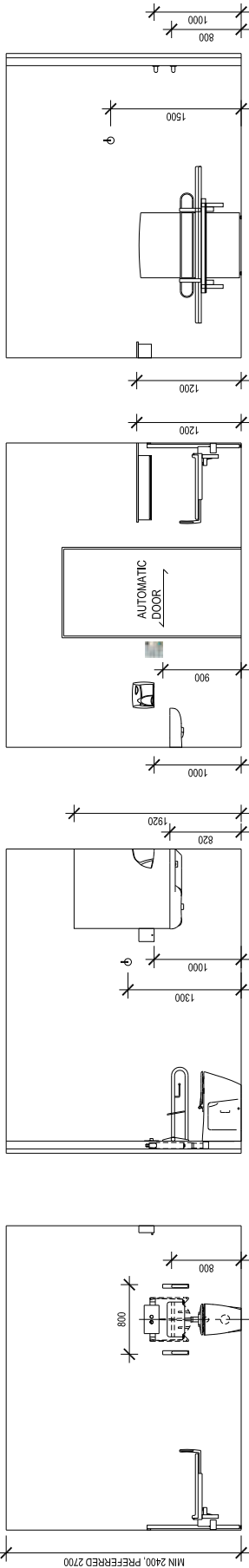

Changing Places

D. GENERAL UPDATES	OCT 2015	DATE
REVISION	SEPTEMBER 2015	DATE
	SCALE	1:50
	DRAWING NO	DD02D

PROJECT
 CHANGING PLACES
 ASSISTED CHANGE FACILITIES
 DESIGN OPTIONS

TITLE
 DESIGN DEVELOPMENT
 OPTION 1B

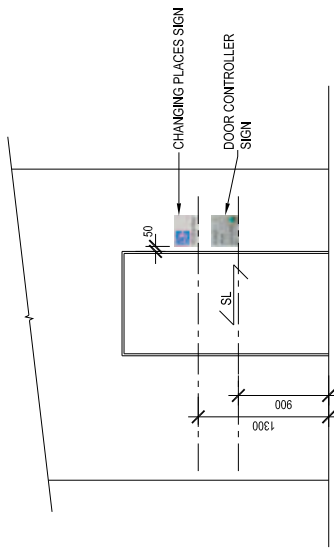

EXTERNAL DOOR ELEVATION

- 01 ROOM COVERAGE HOIST
- 02 ACCESSIBLE WC INCL BACKREST AND LIFT UP GRAB RAILS
- 03 TWO 800MM LONG HORIZONTAL GRAB RAILS AT 600MM AND 1000MM ABOVE FLOOR LEVEL FOR ADJUSTING CLOTHES (WHILE PERSON HOLDS ON TO GRAB RAIL)
- 04 ADJUSTABLE HEIGHT CHANGE TABLE, 1800MM LONG WITH SIDE SAFETY RAIL
- 05 DISPOSABLE CHANGE TABLE COVER DISPENSER WITH SHELF OVER
- 06 INTERGRATED WASH HAND BASIN
- 07 HAND DRIER
- 08 RUBBISH BIN
- 09 RETRACTABLE PRIVACY CURTAIN, WALL MOUNTED
- 10 SOAP DISPENSER
- 11 CLOTHES HOOK
- 12 LARGE SLING HOOK

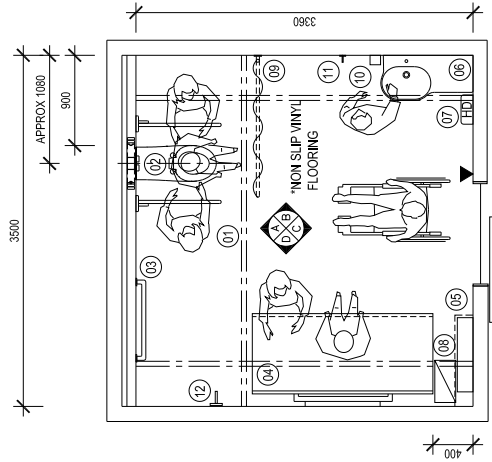

OPTION 1B SQUARE CONFIGURATION WITHOUT SHOWER

COPYRIGHT - ALL RIGHTS RESERVED.
 This document is the property of EQUAL ACCESS CONSULTANTS and is to be used only for the project and location specified. It is not to be reproduced, stored in a retrieval system, or transmitted in any form or by any means, electronic, mechanical, photocopying, recording, or by any information storage and retrieval system, without the prior written permission of EQUAL ACCESS CONSULTANTS. The design and construction of the facilities shown in this document are subject to change without notice.

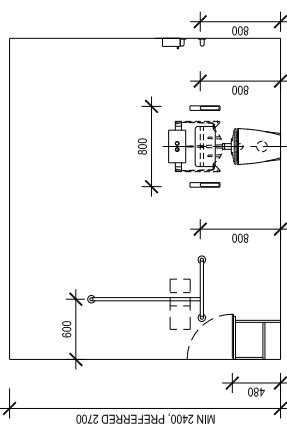

ELEVATION A

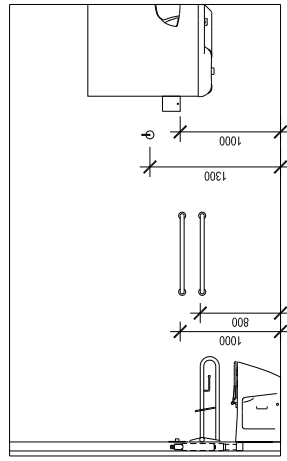

ELEVATION B

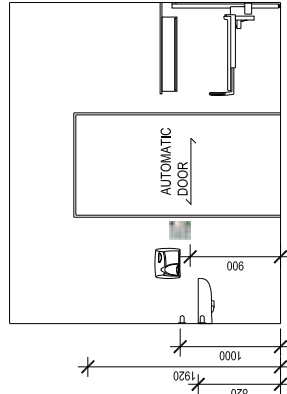

ELEVATION C

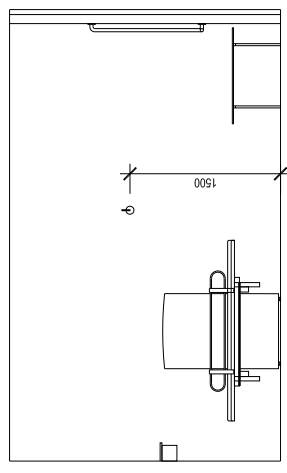

ELEVATION D

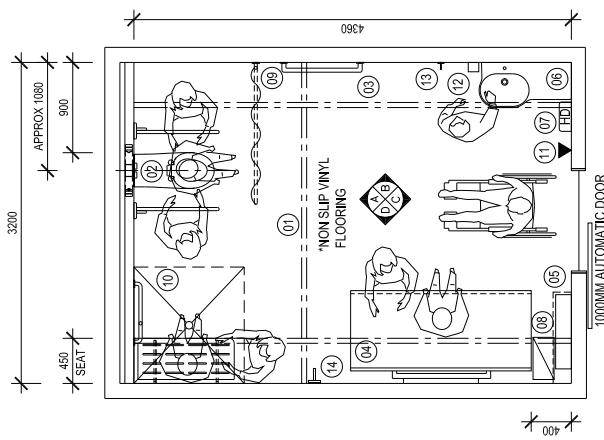

OPTION 2
 RECTANGULAR CONFIGURATION
 WITH SHOWER



Changing Places

D	GENERAL UPDATES	OCT 2015	DATE
REVISION			
DATE	SEPTEMBER 2015		
SCALE	1:50		
DRAWING NO	12110	DD02D	

PROJECT:
 CHANGING PLACES
 ASSISTED CHANGE FACILITIES
 DESIGN OPTIONS

TITLE:
 DESIGN DEVELOPMENT
 OPTION 2

EQUAL ACCESS CONSULTANTS
 DISABILITY ACCESS CONSULTANTS
 1111 WINDYBUSH DRIVE
 NOTTING HILL, VICTORIA, 3108
 P: 61 3 9001 5800 | F: 61 3 9001 9800
 email: info@equalaccess.com.au
 ABN: 22 123 979 733 | BR REG: CP-AC21678

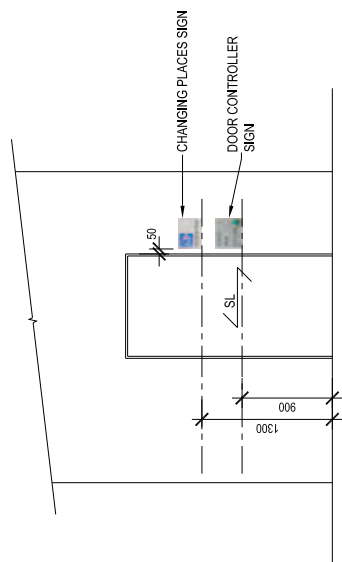

**EXTERNAL DOOR
 ELEVATION**

- 01 ROOM COVERAGE HOIST
- 02 ACCESSIBLE WC INCL BACKREST AND LIFT UP GRAB RAILS
- 03 TWO 800MM LONG HORIZONTAL GRAB RAILS AT 800MM AND 1000MM ABOVE FLOOR LEVEL FOR ADJUSTING CLOTHES (WHILE PERSON HOLDS ONTO GRABRAIL)
- 04 ADJUSTABLE HEIGHT CHANGE TABLE, 1800MM LONG WITH SIDE SAFETY RAIL
- 05 DISPOSABLE CHANGE TABLE COVER DISPENSER WITH SHELF OVER
- 06 INTEGRATED WASH HAND BASIN
- 07 HAND DRIER
- 08 RUBBISH BIN
- 09 RETRACTABLE PRIVACY CURTAIN, WALL MOUNTED
- 10 ACCESSIBLE DOOR CONTROL
- 11 SOAP DISPENSER
- 12 CLOTHES HOOK
- 13 LARGE SLING HOOK
- 14 AUTOMATIC DOOR CONTROL

Changing Places design development costs

(As of September 2013)



Disclaimer: These product specifications have been provided as indicative pricing only and are subject to change. The following costings are based on full construction and fit out of Changing Places facilities and not retrofit of an existing space. The products and suppliers listed here are suggestions only – for a list of alternative suggestions please contact info@changingplaces.org.au

Option 1A

Option 1A - Change Facility				
Item Description	Qty	Unit	Rate	Amount \$
Area				
Base Area	12.80	m2		
Shell Construction:-				
Prepare substrate	13.00	m2	15.00	195.00
Perimeter wall incl. stud frame, insulation, plasterboard, paint & skirting externally				
Frame	38.00	m2	40.00	1,520.00
Insulation	38.00	m2	15.00	570.00
Plasterboard	76.00	m2	37.50	2,850.00
Paint external	38.00	m2	12.00	456.00
Skirting	15.00	m	15.00	225.00
New suspended ceiling (possible existing)	13.00	m2	60.00	780.00
Miscellaneous works	1.00	Item	154.00	154.00
Shell Construction:-				6,750.00
Option 1 Fit-Out				
Construction:-				
1000mm x 2100mm high disabled person door, frame & hardware	1.00	No	3,000.00	3,000.00
Automatic release button fully installed	1.00	No	2,500.00	2,500.00
Frame service duct wall	9.00	m2	85.00	765.00
Support frame for change table	1.00	No	1,150.00	1,150.00
Support frame for ceiling hoist	1.00	No	2,850.00	2,850.00
Non slip vinyl flooring	13.00	m2	90.00	1,170.00
Coved skirting	14.00	m	20.00	280.00
Vinyl splashback basin/WC	4.00	m2	80.00	320.00
1500mm long retractable privacy curtain (wall mounted)	1.00	No	350.00	350.00
Paint walls	35.00	m2	12.00	420.00
Miscellaneous works	1.00	Item	195.00	195.00
Builders Works & Finishes				13,000.000

Option 1A - Change Facility					
Item Description	Qty	Unit	Rate	Mark Up	Amount \$
Fitments:-					
Vanity Unit	1.00	No	1,000.00		1000.00
Equipment					
Ceiling hoist (Fixed 200kg K-series hoist Unit Quote provided by CHS Healthcare)	1.00	No	7,970.00	5.00	8,368.50
Adjustable change table/ Adjustable nursing benches (Quote provided by Healthcare Lifting Specialists)	1.00	No	11,019.00	5.00	11,569.95
Disposable change table cover dispenser & shelf over	1.00	No	750.00		750.00
Bin	1.00	No	250.00		250.00
Sanitary Fittings					
Lift up grab rails	2.00	No	350.00		700.00
Backrest	2.00	No	350.00		700.00
800mm horizontal grab rails	2.00	No	130.00		260.00
1000mm horizontal grab rails	2.00	No	150.00		300.00
Hand dryer	1.00	No	1,000.00		1,000.00
TPH	1.00	No	150.00		150.00
Soap dispenser	1.00	No	125.00		125.00
Miscellaneous fixings	1.00	No	294.85		294.85
Fitments & Equipment					25,468.00
Services					
Sanitary Plumbing					
Disabled WC, cistern etc	1.00	No	1,750.00		1,750.00
Disabled vanity unit & flickmixer (Not Auto)	1.00	No	1,250.00		1,250.00
Soil waste, vents, core holes etc connect to point outside wall	1.00	No	2,500.00		2,500.00
Cold water reticulation & connect to point outside wall	1.00	No	750.00		750.00
Hot water unit	1.00	No	1,000.00		1,000.00
Tempering valve	1.00	No	500.00		500.00
Hot water reticulation	1.00	No	500.00		500.00
Testing & Commissioning	1.00	No	600.00		600.00

Changing Places design specification, costings and guidelines

Option 1A - Change Facility				
Item Description	Qty	Unit	Rate	Amount \$
Electrical Services				
Lighting	1.00	No	3,000.00	3,000.00
Power	1.00	No	1,500.00	1,500.00
Emergency lighting	1.00	No	400.00	400.00
Early Warning Indicator System & fire detection	1.00	No	750.00	750.00
Testing & Commissioning	1.00	No	350.00	350.00
Mechanical Services				
Exhaust ventilation to outlet outside wall	1.00	No		2,750.00
Minor alteration existing AC system	1.00	No		1,500.00
Testing & Commissioning	1.00	No		1,150.00
Services			20,250.00	
Builders Site Preliminaries, Supervision, Site Establishment, Insurance, Overheads & Margin	1.00	Item		9,750.00
Contingency Sum				
Design Contingency 5%	1.00	Item	3,750.00	3,750.00
Construction Contingency 6%	1.00	Item	4,500.00	4,500.00
Total Construction Cost Excl. GST				83,000.00
Consultant Fees	1.00	Item	10,250.00	10,250.00
Loose Furniture	1.00	Item		
Signage	1.00	Item	500.00	500.00
Other fees, levies etc	1.00	Item	250.00	250.00
Project Contingency Sum 7.5%	1.00	Item	7,000.00	7,000.00
Total Project Cost Excl. GST				101,468.00
Exclusions:-				
GST				
Cost Escalation from December 2013				
Equipment, Computers, Refrigerators, Microwaves etc				
Services Infrastructure from Rm Ext Wall Line incl. Mech. Plant, Electrical Switchboards etc				
Total:				101,468.00

Option 1B

Option 1B - Change Facility					
Item Description	Qty	Unit	Rate	Mark Up	Amount \$
Area					
Base Area	12.30	m2			
Shell Construction:-					
Prepare substrate	12.30	m2	15.00		184.50
Perimeter wall incl. stud frame, insulation, plasterboard, paint & skirting externally					
Frame	37.00	m2	40.00		1,480.00
Insulation	37.00	m2	15.00		555.00
Plasterboard	74.00	m2	37.50		2,775.00
Paint external	37.00	m2	12.00		444.00
Skirting	14.00	m	15.00		210.00
New suspended ceiling (possible existing)	12.30	m2	60.00		738.00
Miscellaneous works	1.00	Item	113.50		113.50
Shell Construction:-					6,500.00
Option 1B Fit-Out					
Construction:-					
1000mm x 2100mm high disabled person door, frame & hardware	1.00	No	3,000.00		3,000.00
Automatic release button fully installed	1.00	No	2,500.00		2,500.00
Support frame for change table	1.00	No	1,150.00		1,150.00
Support frame for ceiling hoist	1.00	No	2,850.00		2,850.00
Frame service duct wall	10.00	m2	85.00		850.00
Non slip vinyl flooring	13.00	m2	90.00		1,170.00
Coved skirting	13.00	m	20.00		260.00
Vinyl splashback basin/WC	4.00	m2	80.00		320.00
1500mm long retractable privacy curtain (wall mounted)	1.00	Item	50.00		50.00
Paint walls	31.00	m2	12.00		372.00
Miscellaneous works	1.00	Item	228.00		228.00
Builders Works & Finishes					12,750.00
Fitments:-					
Vanity Unit	1.00	No	1,000.00		1,000.00

Changing Places design specification, costings and guidelines

Option 1B - Change Facility					
Item Description	Qty	Unit	Rate	Mark Up	Amount \$
Equipment					
Ceiling hoist (Fixed 200kg K-series hoist Unit Quote provided by CHS Healthcare)	1.00	No	7,970.00	5.00	8,368.50
Adjustable change table/ Adjustable nursing benches (Quote provided by Healthcare Lifting Specialists)	1.00	No	11,019.00	5.00	11,569.95
Disposable change table cover dispenser & shelf over	1.00	No	750.00		750.00
Bin	1.00	No	250.00		250.00
Sanitary Fittings					
Lift up grab rails	2.00	No	350.00		700.00
Backrest	2.00	No	350.00		700.00
800mm horizontal grab rails	2.00	No	130.00		260.00
1000mm horizontal grab rails	2.00	No	150.00		300.00
Hand dryer	1.00	No	1,000.00		1,000.00
TPH	1.00	No	150.00		150.00
Soap dispenser	1.00	No	125.00		125.00
Miscellaneous fixings	1.00	No	294.85		294.85
Fitments & Equipment					25,468.00
Services					
Sanitary Plumbing					
Disabled WC, cistern etc	1.00	No	1,750.00		1,750.00
Disabled vanity unit & flickmixer (Not Auto)	1.00	No	1,250.00		1,250.00
Soil waste, vents, core holes etc connect to point outside wall	1.00	No	2,500.00		2,500.00
Cold water reticulation & connect to point outside wall	1.00	No	750.00		750.00
Hot water unit	1.00	No	1,000.00		1,000.00
Tempering valve	1.00	No	500.00		500.00
Hot water reticulation	1.00	No	500.00		500.00
Testing & Commissioning	1.00	No	600.00		600.00

Option 1B - Change Facility					
Item Description	Qty	Unit	Rate	Mark Up	Amount \$
Electrical Services					
Lighting	1.00	No	3,000.00		3,000.00
Power	1.00	No	1,500.00		1,500.00
Emergency lighting	1.00	No	400.00		400.00
Early Warning Indicator System & fire detection	1.00	No	750.00		750.00
Testing & Commissioning	1.00	No	350.00		350.00
Mechanical Services					
Exhaust ventilation to outlet outside wall	1.00	No	2,750.00		2,750.00
Minor alteration existing AC system	1.00		1,500.00		1,500.00
Testing & Commissioning	1.00	No	1,150.00		1,150.00
Services					20,250.00
Builders Site Preliminaries, Supervision, Site Establishment, Insurance, Overheads & Margin					
Builders Site Preliminaries, Supervision, Site Establishment, Insurance, Overheads & Margin	1.00	Item	9,750.00		9,750.00
Contingency Sum					
Design Contingency 5%	1.00	Item	3,750.00		3,750.00
Construction Contingency 6%	1.00	Item	4,500.00		4,500.00
Total Construction Cost Excl. GST					82,500.00
Consultant Fees	1.00	Item	10,250.00		10,250.00
Loose Furniture	1.00	Item			
Signage	1.00	Item	500.00		500.00
Other fees, levies etc	1.00	Item	250.00		250.00
Project Contingency Sum 7.5%	1.00	Item	7,000.00		7,000.00
Total Project Cost Excl. GST					100,968.00
Exclusions:-					
GST					
Cost Escalation from December 2013					
Equipment, Computers, Refrigerators, Microwaves etc					
Services Infrastructure from Rm Ext Wall Line incl. Mech. Plant, Electrical Switchboards etc					
Total :					100,968.00

Option 2

Option 2					
Item Description	Qty	Unit	Rate	Mark Up	Amount \$
Area					
Base Area	14.40	m2			
Shell Construction					
Prepare substrate	14.40	m2	15.00		216.00
Perimeter Wall Incl. Stud Frame, Insulation, Plasterboard, Paint & Skirting Externally					
Frame	41.00	m2	40.00		1,640.00
Insulation	41.00	m2	15.00		615.00
Plasterboard	82.00	m2	37.50		3,075.00
Paint external	41.00	m2	12.00		492.00
Skirting	16.00	m	12.00		192.00
New suspended ceiling (possible existing)	15.00	m2	60.00		900.00
Miscellaneous works	1.00	Item	120.00		120.00
Shell Construction					7,250.00
Option 2 Fit- Out					
Construction					
1000mm wide x 2100mm high disabled automatic sliding door	1.00	No	3,000.00		3,000.00
Automatic release button fully installed	1.00	No	2,500.00		2,500.00
Frame service duct wall	9.00	m2	85.00		765.00
Support frame for change table	1.00	No	1,150.00		1,150.00
Support frame for ceiling hoist	1.00	No	2,850.00		2,850.00
Non slip vinyl flooring	15.00	m2	90.00		1,350.00
Coved skirting	15.00	m	20.00		300.00
Vinyl splashback basin/WC	4.00	m2	80.00		320.00
1500mm wide retractable privacy curtain (wall mounted)	1.00	No	350.00		350.00
Paint walls	37.00	m2	12.00		444.00
Miscellaneous works	1.00	Item	221.00		221.00
Builders Works & Finishes					13,250.00
Fitments					
Vanity unit	1.00	No	1,000.00		1,000.00

Option 2					
Item Description	Qty	Unit	Rate	Mark Up	Amount \$
Equipment					
Ceiling hoist (Fixed 200kg K-series hoist Unit Quote provided by CHS Healthcare)	1.00	Item	7,970.00	5.00	8,368.50
Adjustable change table/ height adjustable nursing benches (quote provided by Healthcare Lifting Specialists)	1.00	Item	11,019.00	5.00	11,569.95
Disposal change table cover dispenser with shelf over	1.00	No	750.00		750.00
Bin	1.00	No	250.00		250.00
Sanitary Fittings					
Lift up grab rails	2.00	No	350.00		700.00
Backrest	1.00	No	350.00		350.00
800mm long horizontal grab rails	2.00	No	130.00		260.00
800mm long cloths rack	2.00	No	130.00		260.00
700mm long shower grab rail or combined grabrail	1.00	No	150.00		150.00
1100mm vertical shower grab rail	1.00	No	175.00		175.00
Height adjustable support arm	2.00	No	250.00		500.00
TPH	1.00	No	150.00		150.00
Hand dryer	1.00	No	1,000.00		1,000.00
Soap dispenser	1.00	No	125.00		125.00
Shower seat	1.00	No	575.00		575.00
Swing-away curtains	3.00	m	91.67		275.00
Robe hooks	2.00	No	20.00		40.00
900mm wide x 1100mm high mirror	1.00	No	300.00		300.00
Miscellaneous fixings	1.00	Item	169.85		169.85
Fitments & Equipment					26,968.00

“I had to lift him up from the ground myself and manoeuvre him into his chair outside the cubicle. I was nearly in tears, as I was so anxious not to drop him, or fall with him, in such an awkward position.”

Changing Places design specification, costings and guidelines

Option 2					
Item Description	Qty	Unit	Rate	Mark Up	Amount \$
Services					
Sanitary Plumbing					
Disabled WC, cistern etc	1.00	No	1,750.00		1,750.00
Disabled vanity unit & flickmixer (Not Auto)	1.00	No	1,250.00		1,250.00
Shower waste	1.00	No	750.00		750.00
Soil waste, vents, core holes etc connect to point outside wall	1.00	No	2,750.00		2,750.00
Shower mixer	1.00	No	500.00		500.00
Shower hose & handspray	1.00	No	750.00		750.00
Cold water reticulation & connect to point outside wall	1.00	No	1,000.00		1,000.00
Hot water unit	1.00	No	1,000.00		1,000.00
Tempering valve	1.00	No	500.00		500.00
Hot water reticulation	1.00	No	1,000.00		1,000.00
Testing & commissioning	1.00	No	850.00		850.00
Electrical Services					
Lighting	1.00	No	3,000.00		3,000.00
Power	1.00	No	1,500.00		1,500.00
Emergency lighting	1.00	No	400.00		400.00
Early Warning Indicator System & fire detection	1.00	No	750.00		750.00
Testing & commissioning	1.00	No	350.00		350.00
Mechanical Services					
Exhaust ventilation to outlet outside wall	1.00	No	2,750.00		2,750.00
Minor alteration existing AC system	1.00	No	1,500.00		1,500.00
Testing & commissioning	1.00	No	1,150.00		1,150.00
Services					23,500.00
Builders Site Preliminaries, Supervision, Site Establishment, Insurance, Overheads & Margin					
Builders Site Preliminaries, Supervision, Site Establishment, Insurance, Overheads & Margin	1.00	Item	10,500.00		10,500.00

Option 2					
Item Description	Qty	Unit	Rate	Mark Up	Amount \$
Contingency Sum					
Design Contingency 5%	1.00	Item	4,000.00		4,000.00
Construction Contingency 6%	1.00	Item	5,000.00		5,000.00
Total Construction Cost Excl. GST					90,000.00
Consultant Fees	1.00	Item	11,250.00		11,250.00
Loose Furniture	1.00	Item			
Signage	1.00	Item	500.00		500.00
Other fees, levies etc	1.00	Item	250.00		250.00
Project Contingency Sum 7.5%	1.00	Item	7,000.00		7,000.00
Total Project Cost Excl. GST					109,468.00
Exclusions:-					
GST					
Cost Escalation from December 2013					
Equipment, Computers, Refrigerators, Microwaves etc					
Services Infrastructure from Rm Ext Wall Line incl. Mech. Plant, Electrical Switchboards etc					
Total :					109,468.00

“Not many ordinary people truly understand what it is like being locked up with a person with a disability 24/7. So much of the time is just the two of us. It’s just wonderful if someone drops in, and it’s a chance to talk to someone other than each other.”

Guidelines for the use of slings in Changing Places toilets

Risks associated with providing a sling

The provision of permanent or disposable slings in Changing Places toilets present considerable risks and is not advisable. These risks include:

- cross-infection, which could not be fully eradicated even with the use of chemical wipes;
- difficulties associated with the compatibility of the sling in terms of its size and type; and
- the user and/or carers knowledge of how to use the sling.

Therefore, to minimise any potential risks users should provide their own sling, which would have the advantage of both the user and carer being familiar with how to use the sling.

Signage and literature should clearly advise people that they need to provide their own sling for health and safety reasons.

Compatibility of slings with the hoist

If users bring their own slings there is the risk that it might be incompatible with the particular model of hoist provided in the toilet. To minimise this risk the following can be undertaken:

- advertise the model of hoist on all promotional material, including prominent notices in the toilet, which should include pictorial or diagrammatic guidance and easy English text;
- advise potential users to check the compatibility of the hoist with their sling by contacting the supplier, manufacturer, prescribing therapist or by calling the Independent Living Centres Advisory Service on (1300 885 886) for advice;
- advise potential users which slings are compatible with the hoist provided, which can be obtained from the supplier of the hoist;

Potential users should be notified that if their sling is not compatible with the hoist or if compatibility has not been checked, and there is any uncertainty they should not use the Changing Places toilet.

If this was to occur, potential users should also be advised that they can request an assessment by an Occupational Therapist or Physiotherapist for a sling that meets their needs, and is also compatible with the hoist provided.



Competence of user and carer

There are risks associated with the user and/or carer not being competent in use of the hoist. To minimise this risk all promotional material including notices in the toilet should state that **only users and carers accustomed to hoisting should use the hoist.**

All information should include pictorial or diagrammatic guidance and easy English text. It should also be made clear that there is no one on site available to assist, as currently available at Travellers Aid and those requiring assistance should have a support person/carer with them.

The manufacturer's instructions for use of the hoist should also be displayed in a prominent position in the toilet.

Key schemes

It is up to each venue how they manage access to their Changing Places toilet.

Some venues choose to keep the Changing Places toilet unlocked. Other venues may keep it locked as a way to counter vandalism and misuse.

By providing a key operated system you are ensuring the toilet facilities are only used by people who require them, as a result most of these toilets have been found to be in a safe and clean environment.

If you are choosing to have the Changing Places facility locked you will need to install the following system: Master Locksmiths' Access Key (MLAK) or Master Locksmiths' Access Fobs are also available for the MLA LOKtouch electro-mechanical access control system.

The Master Locksmiths' Access Key (MLAK) enables people with disabilities to gain 24/7 access to a network of public facilities.

MLAK has been fitted to elevators at railway stations, accessible toilets in Council municipalities and National Parks and in adaptive playground equipment (Liberty Swings) across Australia.

People with a disability are able to purchase MLAK which will open all toilets, playgrounds and other facilities which are fitted with this specially designed lock.

MLAK is available for purchase from the Master Locksmiths Association of Australasia. To apply for and purchase MLAK online go to www.masterlocksmiths.com.au or telephone (03) 9338 8822.

Who is eligible?

Eligibility is restricted to people who have a disability or have written authority from:

- a doctor
- a disability organisation
- community health centre
- the owner or management of a building with an accessible toilet on site



For further information, please contact the
Master Locksmiths Association (03) 9338 8822

Accreditation of Changing Place facilities

Facilities may be accredited as either a **BLUE** or **GREEN** Changing Place.



Facilities bearing the BLUE Changing Places logo are those built according to one of the three specifications detailed in this kit (pages 29, 30, 31) or based on alternate or modified plans which have been approved by the Changing Places technical advisory team prior to construction.



The GREEN Changing Places logo represents facilities which meet the key equipment and circulation space requirements of BLUE Changing Place facilities but which are not built according to the specifications set out in this kit or according to an approved modification. Facilities built prior to 30th June 2015 and retrofitted facilities may apply for GREEN level accreditation.

We recommend the use of one of the three specified BLUE Changing Place designs for new build facilities.

Please note: From 30th June 2015, it is required that accredited Changing Places facilities be built in addition to and separate from required Unisex Accessible Toilets. This is to ensure that the needs of both groups of toilet users are met without compromise.

Applications for accreditation may be submitted by registered Access Consultants or Building Surveyors. An AUD 250 administration fee will apply.

For accreditation forms and guidelines please visit www.changingplaces.org.au or email: info@changingplaces.org.au

For any enquiries related to accreditation, please email info@changingplaces.org.au

The Changing Places initiative will continue to support adult change facilities which do not meet the requirements for BLUE or GREEN accreditation by including them on the Changing Places location map.

Changing Places

supporters



Supporters of the Changing Places campaign



The Changing Places project is advocating for Changing Places toilets to be installed in all main public buildings across Australia.

The following organisations are supporting the Changing Places campaign. To add your organisation to this list please email mayn@acd.org.au

Annecto
Architecture & Access (Aust)
Association for Children with a Disability
Association of Consultants in Access Australia Inc
Australian Physiotherapy Association
BKK Architects
Braille Tactile Signs (Aust)
Carer Solutions Australia
Carers Victoria
CHS Healthcare
Centre for Developmental Disability Health
Cerebral Palsy Support Network
Children with Disability Australia
City of Melbourne
City of Port Phillip
City of Yarra
Disability Action Group Eastern Region
Disability Justice Advocacy Inc
DORMA Australia
Eastland Shopping Centre
Equal Access Pty Ltd
Envirodome
Enware Australia Pty Limited
Fruitbowl Productions
Functional Access Solutions
Gift Options
Greater Shepparton City Council
Grocon Group
Hede Architects
HLS healthcare
HSPC Disability Access Consultancy
Independence Australia
Independent Disability Services
Institute of Access Training Australia
Knox City Council
Leisure Options
Marillac
Maroondah City Council
Master Locksmiths Association of Australasia Limited
Melba Support Services
Melton City Council
Mode Design
Moodie Outdoor Products
Mornington Peninsula Shire Council
MS Australia – ACT/NSW/VIC
Nadrasca
National Disability Services Victoria
Obvius Access
Options Victoria
Outlook Vic
Ovens & King Community Health Service
Parents Support Network Eastern Region
Peninsula Access Support & Training Inc
Parks Victoria
Pureablue
Radius Disability Services
RuralAccess Gippsland
Scope
Simon Mattiske Building Surveyors & Building Inspectors
Spina Bifida Foundation Victoria
Travellers Aid Australia
Touch By Olivia Foundation
Variety – The Children’s Charity (Victoria)
Victorian Chapter Royal Australian Institute of Architects
Victorian Equal Opportunity Human Rights Commission
WC Innovations
Yooralla

For a full list of Changing Places initiative supporters please visit www.changingplaces.org.au/our-supporters

Changing Places Technical Advisory Team

Changing Places would like to acknowledge the support received from its Technical Advisory Team who have kindly offered their time and expertise on a volunteer basis:

Equal Access Pty Ltd

Disability access consultants
Accredited members of Association of Consultants in Access, Australia.
Phone: 03 9001 5805
www.equalaccess.com.au

Bruce Bromley

Bruce has over 25 years experience in disability access, architectural design, documentation & project management. He formed Equal Access Pty Ltd in 2006 in response to a growing recognition, that whilst businesses were being urged to respond to their obligations under the Disability Discrimination Act, the majority of assistance available was focused almost entirely upon the needs of the individual with a disability without an understanding of the impacts and practicalities for building owners, managers and consultants. Bruce also specialises in evacuation procedures and policy for people with a disability and is a sitting member of the Fire Protection Association Australia, technical and advisory committee TAC17 for emergency workplace evacuation.

Lee Wilson

Lee Wilson has over 28 years experience in a number of areas associated with the building industry. Lee has worked in construction, military, facility/property management and has several years experience in building compliance, both in the private sector and in local government. Over this time Lee has developed advanced skills in project management and in OHS/Building Code compliance. Lee has post-graduate fire engineering qualifications to assess performance based alternative solutions in building approvals.

Architecture & Access (Aust) Pty Ltd

Disability access consultants
Accredited members of Association of Consultants in Access, Australia.
Phone: 8383 6688
www.architectureandaccess.com.au

Chris Porter

Chris is a highly qualified architect and professional access consultant with over 30 years experience as a company director providing services to the construction industry in Australia. At Architecture

& Access, he is a specialist in accessible design and respected consultant to private, public and commercial projects producing built environments accessible to people with disability. Chris has been working closely with Eastland shopping centre where the Changing Places facility has recently opened. He has been a proud supporter of the Changing Places campaign as it strongly aligns with the company's motto – "Creating environments, transforming lives".

Helen Fearn-Wannan

Helen is an access consultant, accredited with the Association of Consultants in Access, Australia and a registered Occupational Therapist with over 14 years experience in the area of building access, design and modification. Helen previously worked with Scope where she had the opportunity to work closely with people with high support needs and the people who support them. It was here that Helen developed the specialist skills of understanding how people, space and technical equipment, including hoists and change tables, all need to work together to provide a change facility that meets everyone's needs with dignity and in safety.

Helen works for Architecture & Access and consults at all stages of documentation on a broad range of building projects including community, educational, commercial, health and government projects. She has championed the inclusion of Changing Places facilities in many settings and has recently seen their inclusion in university, community, aquatic, commercial and health projects.

Francesca Davenport

Francesca Davenport is an architect and an accredited member of the Association of Consultants in Access, Australia. She was Chair of the National Access Work Group of the Australian Institute of Architects from 2004 to 2014. Francesca has recently joined the team at Architecture & Access after leading Health Science Planning Consultants Disability Access Consultancy for over 11 years.

A special thanks to the Victorian Government and CHS Healthcare for their contribution to the Changing Places initiative

CHS Healthcare

Jason Swaffield Phone: 1300 789 420
www.chshealthcare.com.au



Changing Places Transforming Lives

For further information please contact
May Ng
Marketing and Communications Coordinator,
Association for Children with a Disability
mayn@acd.org.au
ph: (03) 9818 2000
www.acd.org.au

www.changingplaces.org.au



www.facebook.com/ChangingPlacesAustralia